

MARKS PUBLISHED FOR OPPOSITION

The following marks are published in compliance with section 12(a) of the Trademark Act of 1946. Applications for the registration of marks in more than one class have been filed as provided in section 30 of said act as amended by Public Law 772, 87th Congress, approved Oct. 9, 1962, 76 Stat. 769. Opposition under section 13 may be filed within thirty days of the date of this publication. See rules 2.101 to 2.105.

A separate fee of two hundred dollars for opposing each mark in each class must accompany the opposition.

SECTION 1.— INTERNATIONAL CLASSIFICATION

The short titles associated below with the international class numbers are terms designed merely for quick identification and are not an official part of the international classification. The full names of international classes are given in section 6.1 of the trademark rules of practice.

The designation "U.S. Cl." appearing in this section refers to the U.S. class in effect prior to Sep. 1, 1973 rather than the international class which applies to applications filed on or after that date. For adoption of international classification see notice in the OFFICIAL GAZETTE of Jun. 26, 1973 (911 O.G. TM 210).

Application in more than one class

SN 75-694,927. RED BULL GMBH, FUSCHL AM SEE, AUSTRIA, FILED 4-30-1999.

SN 76-204,458. OPEN BUSINESS EXCHANGE LIMITED, LONDON WC2R IDA, UNITED KINGDOM, FILED 2-2-2001.

OB 10



OWNER OF ERPN CMNTY TM OFC REG. NO. 001854389, DATED 10-10-2001, EXPIRES 10-10-2011.

CLASS 9—ELECTRICAL AND SCIENTIFIC APPARATUS

FOR COMPUTER SOFTWARE FOR THE ELECTRONIC DELIVERY AND EXCHANGE OF INVOICES AND DOCUMENTATION BETWEEN TRADING ENTITIES (U.S. CLS. 21, 23, 26, 36 AND 38).

CLASS 35—ADVERTISING AND BUSINESS

FOR PROVIDING BUSINESS INVOICING SERVICES, NAMELY, PROVIDING A COMPUTER PLATFORM FOR THE DELIVERY AND EXCHANGE OF INVOICES AND DOCUMENTATION BETWEEN TRADING ENTITIES (U.S. CLS. 100, 101 AND 102).
BRIDGETT SMITH, EXAMINING ATTORNEY

OWNER OF AUSTRIA REG. NO. 179,129, DATED 11-23-1998, EXPIRES 11-30-2008.

OWNER OF U.S. REG. NO. 3,197,810.

CLASS 25—CLOTHING

FOR FOOTWEAR; CLOTHING, NAMELY SHIRTS, PANTS, T-SHIRTS, SWEAT SHIRTS AND SWEAT PANTS, SHORTS, BLOUSES, SKIRTS, JUMPERS, SOCKS, HATS, CAPS; OUTERWEAR, NAMELY JACKETS AND COATS; ACTIVE WEAR, NAMELY VISORS; BANDANAS, NECKERCHIEFS, SWEATERS, SLEEPWEAR; SUSPENDERS (U.S. CLS. 22 AND 39).

CLASS 32—LIGHT BEVERAGES

FOR MINERAL WATERS AND AERATED WATERS AND OTHER NON-ALCOHOLIC BEVERAGES, NAMELY FLAVORED WATERS; SOFT DRINKS, AND SPORTS DRINKS (U.S. CLS. 45, 46 AND 48).

CLASS 33—WINES AND SPIRITS

FOR ALCOHOLIC BEVERAGES, NAMELY VODKA, BRANDY SPIRITS, GIN AND WINE (U.S. CLS. 47 AND 49).

GENE MACIOL, EXAMINING ATTORNEY

SN 76-340,463. LABORATOIRES DE BIOLOGIE VEGETALE YVES ROCHER, 56200 LA GACILLY, FRANCE, FILED 11-20-2001.

PUR DESIR DE

PRIORITY CLAIMED UNDER SEC. 44(D) ON FRANCE APPLICATION NO. 013195247, FILED 5-31-2001, REG. NO. 013105247, DATED 5-31-2001, EXPIRES 5-31-2011.

THE ENGLISH TRANSLATION OF THE FRENCH PHRASE "PUR DESIR DE" IS "PURE DESIRE FOR".

CLASS 3—COSMETICS AND CLEANING PREPARATIONS

FOR SOAPS, NAMELY, HAND SOAPS, PERFUMED SOAPS, AND MOISTURIZING SOAPS; PERFUMES, COLOGNES, EAU DE TOILETTE, ESSENTIAL OILS FOR PERSONAL USE, NAMELY, PERFUMED OILS AND AROMATHERAPY OILS; HAIR CARE PREPARATIONS, NAMELY, SHAMPOOS, CONDITIONING TREATMENTS, LOTIONS, HAIR SPRAYS, HAIR BLEACH, MOUSSE AND GELS; NON-MEDICATED COSMETICS IN ANY GALENIC FORM, NAMELY, MAKEUP AND SKIN CARE PREPARATIONS FOR MOISTURIZING, CLEANSING AND IMPROVING THE APPEARANCE OF THE BODY AND FACE, NAMELY, FACE, HAND, BODY, AND FOOT CREAMS, LOTIONS, TONERS, GELS AND SCRUBS, ANTI-WRINKLE AND ANTI-AGING PREPARATIONS, CREAMS AND LOTIONS FOR CELLULITE REDUCTION, FACIAL MAKEUP, FOUNDATION CREAMS AND LOTIONS, FACE POWDER, BLUSH AND ROUGE, EYE MAKEUP, EYE LINERS, EYE SHADOWS, MASCARA, LIPSTICKS, LIP GLOSSES, LIP PENCILS, LIP LINERS AND LIP ENAMELS, BATH AND SHOWER PRODUCTS, NAMELY, BATH SALTS, BATH CRYSTALS, BATH POWDERS, BATH OILS, BATH MILKS AND BATH GELS; ORAL HYGIENE PRODUCTS, NAMELY, TOOTHPASTE; DEODORANTS; ROOM FRAGRANCES, NAMELY PERFUMED ROOM SPRAYS, FRAGRANCE EMITTING WICKS, SCENTED CERAMIC STONES, INCENSE, AND AROMATIC WOOD CHIPS; AROMATIC POTPOURRIS; AND SCENTED PRODUCTS FOR USE WITH LINEN AND LINGERIE, NAMELY, SACHETS AND SCENTED WATER FOR USE WITH IRONS (U.S. CLS. 1, 4, 6, 50, 51 AND 52).

CLASS 42—SCIENTIFIC AND COMPUTER SERVICES

FOR HAIR AND BEAUTY SALON SERVICES AND BEAUTY CONSULTING SERVICES (U.S. CLS. 100 AND 101).

LINDA POWELL, EXAMINING ATTORNEY

SN 76-362,789. DULCES Y CONSERVAS HELIOS S.A., 47080 VALLADOLID, SPAIN, FILED 1-28-2002.



THE TRANSLATION OF THE WORD "HELIOS" IS "SUN."

CLASS 29—MEATS AND PROCESSED FOODS

FOR JAMS AND MARMALADES AND PORTIONS OF JAMS AND MARMALADES; VEGETABLE PRESERVES; FRUITS IN SYRUP; PICKLES IN VINEGARS; PICOS, NAMELY FRUIT PASTE WEDGES, AND CANDIED FRUIT, ALL EXCLUDING DRIED FRUITS AND PLUMS (U.S. CL. 46).

CLASS 30—STAPLE FOODS

FOR FONDANT, TOMATO SAUCE, HONEY AND PORTIONS FOR HONEY, AND SWEETENED GELATIN (U.S. CL. 46).

BRENDAN MCCAULEY, EXAMINING ATTORNEY

SN 76-499,528. GLOBE ELECTRIC COMPANY INC., POINTE-CLAIRE, QUEBEC, CANADA, FILED 3-21-2003.



PRIORITY CLAIMED UNDER SEC. 44(D) ON CANADA APPLICATION NO. 1,157,111, FILED 10-28-2002, REG. NO. TMA653,678, DATED 11-28-2005, EXPIRES 11-28-2020.

OWNER OF U.S. REG. NOS. 2,431,982 AND 2,493,754.
COLOR IS NOT CLAIMED AS A FEATURE OF THE MARK.

CLASS 9—ELECTRICAL AND SCIENTIFIC APPARATUS

FOR ELECTRIC FUSES, ELECTRIC POWER EXTENSION CORDS, ELECTRIC POWER SUPPLIES, NAMELY, ELECTRIC TAPS, POWER BARS AND POWER STAKES, INDOOR AND OUTDOOR TIMED AND MOTION-SENSITIVE SECURITY LIGHTING, WATERPROOF ELECTRICAL OUTLET BOXES AND COVERS THEREFOR FOR OUTDOOR USE (U.S. CLS. 21, 23, 26, 36 AND 38).

CLASS 11—ENVIRONMENTAL CONTROL APPARATUS

FOR ELECTRIC LIGHT BULBS EXCLUDING SPHERICAL AND GLOBE SHAPED BULBS, ELECTRIC FAN LIGHTS, ELECTRIC NIGHT LIGHTS, ELECTRIC WALL AND CEILING LIGHT FIXTURES EXCLUDING SPHERICAL AND GLOBE SHAPED BULBS OR GLASS COVERINGS, ELECTRIC LAMPS, ELECTRIC TABLE LAMPS, ELECTRIC FLOOR LAMPS, ELECTRIC LIGHTING FIXTURES EXCLUDING SPHERICAL AND GLOBE SHAPED BULBS OR GLASS COVERINGS, NAMELY, ELECTRIC WORK LIGHTS, ELECTRIC SHOP LIGHTS, SPECIALTY TASK LIGHTING FIXTURES, LED LAMPS, OUTDOOR ELECTRIC AND SOLAR POWERED LIGHTS USED IN LAWNS AND GARDENS, ELECTRIC LIGHTS FOR CABINETS, INDOOR AND OUTDOOR ELECTRIC LIGHTING FIXTURES, ELECTRIC TRACK LIGHTING, AND SOLAR POWERED LIGHTING FIXTURES (U.S. CLS. 13, 21, 23, 31 AND 34).

CLASS 35—ADVERTISING AND BUSINESS

FOR WHOLESALE DISTRIBUTORSHIPS FEATURING ELECTRIC BULBS EXCLUDING SPHERICAL AND GLOBE SHAPED BULBS, ELECTRICAL SUPPLIES AND LIGHTING PRODUCTS (U.S. CLS. 100, 101 AND 102).

REBECCA SMITH, EXAMINING ATTORNEY

SN 76-550,221. SPRINGER-VERLAG GMBH & CO. KG, HEIDELBERG, FED REP GERMANY, FILED 10-8-2003.

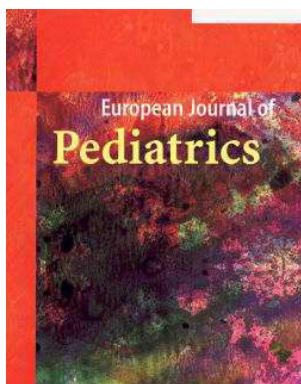

PRIORITY CLAIMED UNDER SEC. 44(D) ON ERP N CMNTY TM OFC APPLICATION NO. 0033184661, FILED 8-19-2003, REG. NO. 003318466, DATED 4-12-2007, EXPIRES 8-19-2013.

NO CLAIM IS MADE TO THE EXCLUSIVE RIGHT TO USE "JOURNAL", APART FROM THE MARK AS SHOWN.

THE COLOR(S) WHITE, YELLOW, GREEN, PINK, PURPLE, RED AND BROWN IS/ARE CLAIMED AS A FEATURE OF THE MARK.

THE MARK CONSISTS OF THE WORDS "EUROPEAN JOURNAL OF" IN WHITE, "PEDIATRICS" IN YELLOW AND A DESIGN OF THE VARIEGATED AND BLENDED COLORS GREEN, PINK, PURPLE, RED AND BROWN, WHICH APPLICANT HEREBY CLAIMS AS A FEATURE OF THE MARK.

SEC. 2(F).

CLASS 16—PAPER GOODS AND PRINTED MATTER

FOR PRINTED BOOKS AND JOURNALS IN THE FIELD OF MEDICINE (U.S. CLS. 2, 5, 22, 23, 29, 37, 38 AND 50).

CLASS 41—EDUCATION AND ENTERTAINMENT

FOR WRITTEN TEXT EDITING; PUBLICATION OF BOOKS AND JOURNALS IN THE FIELD OF MEDICINE; ON-LINE PUBLICATION OF ELECTRONIC BOOKS AND JOURNALS IN THE FIELD OF MEDICINE (U.S. CLS. 100, 101 AND 107).

DORITT L. CARROLL, EXAMINING ATTORNEY

SN 76-611,634. CHAMNESS RELOCATION SERVICES, INC., CHANDLER, AZ. FILED 9-16-2004.



NO CLAIM IS MADE TO THE EXCLUSIVE RIGHT TO USE "RELOCATION SERVICES", APART FROM THE MARK AS SHOWN.

GRAY IS A FEATURE OF THE MARK AND APPEARS IN ALL LINES COMPRISING THE GLOBE.

CLASS 35—ADVERTISING AND BUSINESS

FOR RELOCATION SERVICES FOR BUSINESSES NAMELY, RELOCATING EMPLOYEES, INTERNS, AND FOREIGN EMPLOYEES; PERSONNEL RELOCATION CONSULTING SERVICES; REAL ESTATE SALES MANAGEMENT SERVICES, NAMELY, PROVIDING MANAGEMENT OF A NATIONAL REAL ESTATE BROKER NETWORK (U.S. CLS. 100, 101 AND 102).

FIRST USE 0-0-1996; IN COMMERCE 0-0-1996.

CLASS 43—HOTEL AND RESTAURANT SERVICES

FOR ASSISTANCE WITH TEMPORARY HOUSING, NAMELY, TEMPORARY HOUSING ACCOMMODATIONS (U.S. CLS. 100 AND 101).

BERYL GARDNER, EXAMINING ATTORNEY

SN 76-622,455. KABUSHIKI KAISHA TOSHIBA, MINATOKU, TOKYO, JAPAN, FILED 11-29-2004.

LCSIMULATOR

THE MARK CONSISTS OF STANDARD CHARACTERS WITHOUT CLAIM TO ANY PARTICULAR FONT, STYLE, SIZE, OR COLOR.

PRIORITY CLAIMED UNDER SEC. 44(D) ON JAPAN APPLICATION NO. 2004-56216, FILED 6-17-2004, REG. NO. 5014574, DATED 1-5-2007, EXPIRES 1-5-2017.

CLASS 9—ELECTRICAL AND SCIENTIFIC APPARATUS

FOR COMPUTER SOFTWARE USED FOR EVALUATING AND OPTIMIZING PROFIT PERFORMANCE AND ENVIRONMENTAL BURDEN IN PRODUCT LIFE CYCLE; PROVIDING COMPUTER SOFTWARE USED FOR EVALUATING AND OPTIMIZING PROFIT PERFORMANCE AND ENVIRONMENTAL BURDEN IN PRODUCT LIFE CYCLE (U.S. CLS. 21, 23, 26, 36 AND 38).

CLASS 42—SCIENTIFIC AND COMPUTER SERVICES

FOR COMPUTER SOFTWARE DESIGN; COMPUTER PROGRAMMING; MAINTENANCE OF COMPUTER SOFTWARE; CREATING OR MAINTAINING WEB SITES FOR OTHERS; RENTAL OF COMPUTERS (U.S. CLS. 100 AND 101).

CAROLYN GRAY, EXAMINING ATTORNEY

SN 76-630,600. BARRY CALLEBAUT AG, 8034 ZURICH, SWITZERLAND, FILED 2-7-2005.



CLASS 29—MEATS AND PROCESSED FOODS

FOR COCOA BUTTER FOR FOOD PURPOSES, GROUND HAZELNUTS, HAZELNUT CREAM, WALNUT CREAM, DAIRY BASED CHOCOLATE AND COCOA-BASED FOOD BEVERAGES; VEGETABLE-BASED CHOCOLATE AND COCOA BASED FOOD BEVERAGES; DAIRY-BASED AND COCOA-BASED CREAM FOR THE BAKERY; EDIBLE OILS; HAZEL NUT PASTE FOR FILLING PASTRIES, NUT PASTE FOR FILLING PASTRIES, PRESERVED TRUFFLES (U.S. CL. 46).

FIRST USE 10-31-2004; IN COMMERCE 10-31-2004.

CLASS 30—STAPLE FOODS

FOR FRUIT-BASED GLAZING GELS, CONFECTIONARY PRODUCTS, NAMELY, CHOCOLATES AND ASSORTED CHOCOLATES; OTHER CHOCOLATE OR COCOA PRODUCTS, NAMELY, CHOCOLATE MASS, COCOA MASS; CHOCOLATE PIECES; BAKING CHOCOLATE; CHOCOLATE BARS; CHOCOLATE BARS AND CHOCOLATE TABLETS BEING MADE USING MILK AND HONEY AND OTHER INGREDIENTS; CHOCOLATE COATED CANDY BEING MADE USING MILK AND HONEY AND OTHER INGREDIENTS; CHOCOLATE SQUARES; CHOCOLATE LOZENGES; CHOCOLATE MOLDED INTO VARIOUS SHAPES; CHOCOLATE BONBONS AND OTHER ASSORTED CHOCOLATES; FILLED CHOCOLATE BARS; SHAPED, ICED AND HOLLOW CHOCOLATES; GOODS CONSISTING PRIMARILY OF CHOCOLATE SUBSTITUTES, SUGAR FREE CHOCOLATE, AND SUGARFREE CHOCOLATE COATING; CHOCOLATE-BASED GLAZES; IMITATION CHOCOLATE; IMITATION CHOCOLATE CONFECTIONERY, NAMELY, DIETETIC CHOCOLATE PRODUCTS IN THE NATURE OF SUGAR FREE CHOCOLATE SWEETS; DIET CHOCOLATE; RAW CHOCOLATE, RAW CHOCOLATE IN THE FORM OF SMALL LENTILS OR TABLETS, IN ONE PIECE OR DIVIDED IN SMALL PARTS; RAW CHOCOLATE IN THE FORM OF LENS-SHAPED DROPS OR SMALL TABLETS FOR USE IN INDUSTRY OR HOUSEHOLDS; CHOCOLATE COATINGS AND DIET CHOCOLATE COATINGS, NAMELY, COMPOUND COATING; COMPOUND COATING FOR USE IN THE MANUFACTURE OF CANDIES AND CONFECTIONERS COATING; CHOCOLATE PRODUCTS FOR FURTHER INDUSTRIAL PROCESSING, NAMELY, AIR-FILLED CHOCOLATE, CHOCOLATE SYRUP, CHOCOLATE DESERTS; SMALL WRAPPED MILK CHOCOLATE EGGS; CHOCOLATE CAKES; CHOCOLATE CANDY DROPS; CHOCOLATE-BASED CANDY FOR RETAIL SALE AND USE IN FOOD MANUFACTURING; DARK CHOCOLATE; SHAPED, ICED AND HOLLOW CHOCOLATES; PLAIN CHOCOLATE, CHOCOLATE CANDY AND SWEETS, IN PARTICULAR FILLED WITH FRUITS; CHOCOLATE COATED FRUITS; CHOCOLATE-COVERED SWEETMEATS, NAMELY, CHOCOLATE COVERED RAISINS, NUTS, ALMONDS; CHOCOLATE AND COCOA FOOD BEVERAGES NOT BEING DAIRY-BASED OR VEGETABLE BASED; CHOCOLATE FLAVORED BEVERAGES, NAMELY, HOT COCOA AND MILK SHAKES; COCOA POWDER FOR MAKING BEVERAGES; BEVERAGES BASED ON CHOCOLATE ADDITIVES; CHOCOLATE BREAD SPREADS; CHOCOLATE SPREADS; THIN CHOCOLATE SLABS FOR LAYING ON BREAD; CHOCOLATE-NUT-NOUGAT CREAM FOR BREAD; CHOCOLATE, CANDY AND CHOCOLATE-BASED SEASON'S ARTICLES FOR EASTER AND CHRISTMAS; SYNTHETIC CHOCOLATE PRODUCTS; LIQUID AND SOLID CHOCOLATE INTENDED FOR USE BY THE CHOCOLATE INDUSTRY AND NOT FOR DIRECT HUMAN CONSUMPTION; CHOCOLATE BASED BEVERAGES, NAMELY, MILK SHAKES; CHO-

COLATE SAUCES; CHOCOLATE DROPS; CHOCOLATE PRALINES BEING MADE USING MILK AND HONEY AND OTHER INGREDIENTS; PRALINES; ALCOHOLIC PRALINES; PRALINES FILLED WITH LIQUIDS AND NUTS, HAZELNUT CREAM AND WALNUT CREAM; DIET PRALINES; CHOCOLATE TRUFFLES; CHOCOLATE STICKS; FUDGE; CHOCOLATE ICES; WAFERS AND PASTRIES WITH CHOCOLATE COATING; CHOCOLATE WAFER; WAFER BISCUITS; PLAIN FLOUR WAFERS; WAFERED PRALINES; WAFER SANDWICHES; FARINACEOUS AND BAKERY PRODUCTS, NAMELY, RUSKS, CAKES, BREADS, SWEET BREADS, COOKIES, BISCUITS, PIES; WAFFLES; CRACKERS; CHOCOLATE COVERED WAFFLES, IN PARTICULAR, WAFFLE BISCUITS AND WAFFLE PRALINES; TOAST; GINGERBREAD; SYRUP WAFFLES, NAMELY, TWO WAFFLES HELD TOGETHER BY SYRUP; CONFECTIONERY ARTICLES COVERED WITH CHOCOLATE, NAMELY, CAKE, CRACKERS, TOAST, GINGERBREAD; CHOCOLATE-COATED BISCUITS; CHOCOLATE WAFERS; BLANCMANGE POWDER; BAKING POWDER; FLOUR CONFECTIONERY AND SUGAR CONFECTIONERY; FLOUR; HONEY; HONEY MOLASSES; FLAVORING SYRUP; YEAST; YEAST BAKING POWDER; FLAN; MARZIPAN (U.S. CL. 46).

FIRST USE 10-31-2004; IN COMMERCE 10-31-2004.
ALICIA COLLINS, EXAMINING ATTORNEY

SN 76-643,872. JAMBA! GMBH, BERLIN, FED REP GERMANY, FILED 7-28-2005.

CRAZY FROG

THE MARK CONSISTS OF STANDARD CHARACTERS WITHOUT CLAIM TO ANY PARTICULAR FONT, STYLE, SIZE, OR COLOR.

PRIORITY CLAIMED UNDER SEC. 44(D) ON FED REP GERMANY APPLICATION NO. 30511995.8, FILED 3-2-2005, REG. NO. 30511995, DATED 6-9-2005, EXPIRES 3-31-2015.

CLASS 9—ELECTRICAL AND SCIENTIFIC APPARATUS

FOR COMPUTER HARDWARE; COMPUTER APPLICATION SOFTWARE FOR MOBILE PHONES; TELECOMMUNICATIONS AND COMMUNICATIONS EQUIPMENT, APPARATUS AND SYSTEMS FOR RECORDING, TRANSMISSION, RECEPTION PROCESSING, RETRIEVAL, REPRODUCTION, MANIPULATION, ANALYSIS, DISPLAY AND PRINT OUT OF SOUND, IMAGES OR DATA, NAMELY, TAPE RECORDERS, RECORD ALBUMS, MOBILE RADIOS, TWO-WAY RADIOS, CELLULAR TELEPHONES, DIGITAL CELLULAR TELEPHONES, MOBILE TELEPHONES, DISPATCH RADIOS, PAGERS, MOBILE DISPATCH RADIOS, MOBILE DATA RECEIVERS AND TRANSMITTERS; ENCODED SMART CARDS, NAMELY, PREPAID SMART CARDS FOR MOBILE TELEPHONES; MOBILE PERSONAL ELECTRONIC HANDHELD UNITS FOR THE WIRELESS RECEIPT AND/OR TRANSMISSION OF DATA AND/OR VOICE COMMUNICATIONS AND FOR THE PERSONAL MANAGEMENT AND ORGANIZATION OF SUCH DATA; PRE-RECORDED CD'S, VIDEO TAPES, CD-ROM'S, DVD'S AND FLASH MEMORY CARDS FEATURING ENTERTAINMENT, NEWS, MUSIC, TECHNOLOGY, WEATHER, SPORTS AND THE ARTS; ELECTRONIC PUBLICATIONS, NAMELY, BOOKS, MAGAZINES, MANUALS AND PAMPHLETS FEATURING ENTERTAINMENT, NEWS, MUSIC, TECHNOLOGY, WEATHER, SPORTS AND THE ARTS RECORDED ON COMPUTER MEDIA; VIDEO GAME SOFTWARE; MOUSE PADS; KEYBOARDS; SPECTACLES, NAMELY, READING GLASSES AND EYEGLASS FRAMES; DOWNLOADABLE MUSICAL SOUND RECORDINGS; DOWNLOADABLE RING TONES, GRAPHICS AND MUSIC VIA GLOBAL COMPUTER NETWORK AND WIRELESS DEVICES; DOWNLOADABLE VIDEO RECORDINGS FEATURING ENTERTAINMENT, NEWS, MUSIC, TECHNOLOGY, WEATHER, SPORTS AND THE ARTS (U.S. CLS. 21, 23, 26, 36 AND 38).

CLASS 16—PAPER GOODS AND PRINTED MATTER

FOR PAPER PRODUCTS, NAMELY, PAPER, CARDBOARD, CARDBOARD BOXES, CARDBOARD CONTAINERS, AND CARDBOARD PACKAGING; PUBLICATIONS, NAMELY, BROCHURES AND LEAFLETS FEATURING INFORMATION ON THE SUBJECT OF TELECOMMUNICATIONS PRODUCTS AND SERVICES; PRINTED TICKETS; INVITATION CARDS; STICKERS; IRON-ON AND PLASTIC TRANSFERS; PHOTOGRAPHS; PAPER STATIONERY; ADHESIVES FOR HOUSEHOLD OR STATIONERY USE; TYPEWRITERS; PRINTED TEACHING MATERIALS IN THE FIELD OF ENTERTAINMENT, NEWS, MUSIC, WEATHER, SPORTS AND THE ARTS; PLASTIC BAGS FOR PACKAGING (U.S. CLS. 2, 5, 22, 23, 29, 37, 38 AND 50).

CLASS 28—TOYS AND SPORTING GOODS

FOR PLAYING CARDS; TOYS, GAMES AND PLAYTHINGS, NAMELY, STUFFED TOY ANIMALS AND RUBBER CHARACTER TOYS; GYMNASTIC APPARATUS; DECORATIONS FOR CHRISTMAS TREES; KALEIDOSCOPES (U.S. CLS. 22, 23, 38 AND 50).

CLASS 35—ADVERTISING AND BUSINESS

FOR ON-LINE TRADING SERVICES TO FACILITATE THE SALE OF GOODS AND SERVICES BY OTHERS VIA THE INTERNET, OTHER COMPUTER NETWORKS AND AN AFFILIATE PROGRAM, IN WHICH SELLER POSTS PRODUCTS TO BE AUCTIONED AND BIDDING IS DONE VIA THE INTERNET AND OTHER COMPUTER NETWORKS; ON-LINE RETAIL STORE SERVICES FEATURING A VARIETY OF GENERAL MERCHANDISE; TELEPHONE DIRECTORY INFORMATION; DATA PROCESSING FOR THIRD PARTIES; ON-LINE RETAIL STORE SERVICES FEATURING COMPUTER SOFTWARE; ONLINE RETAIL STORE SERVICES FEATURING DOWNLOADABLE MUSICAL SOUND RECORDINGS, DOWNLOADABLE RING TONES, GRAPHICS, MUSIC, AND DOWNLOADABLE VIDEO RECORDINGS FEATURING ENTERTAINMENT, NEWS, MUSIC, TECHNOLOGY, WEATHER, SPORTS AND THE ARTS (U.S. CLS. 100, 101 AND 102).

CLASS 38—COMMUNICATION

FOR TELECOMMUNICATION SERVICES, NAMELY, TRANSMISSION OF VOICE, DATA, PICTURES, MUSIC AND VIDEO VIA WIRELESS NETWORKS; ELECTRONIC TRANSMISSION OF VOICE, TEXT, IMAGES, DATA AND INFORMATION BY MEANS OF MOBILE RADIOS, TWO-WAY RADIOS, CELLULAR TELEPHONES, DIGITAL CELLULAR TELEPHONES, MOBILE TELEPHONES, DISPATCH RADIOS, PAGERS, MOBILE DISPATCH RADIOS, MOBILE DATA RECEIVERS AND TRANSMITTERS; RENTAL OF TELEPHONE, RADIO TELEPHONE AND RADIO FACSIMILE APPARATUS; COMMUNICATION OF DATA BY MEANS OF RADIO, TELECOMMUNICATION AND SATELLITE; EMAIL SERVICES; TELECOMMUNICATION ACCESS SERVICE FOR MOBILE DEVICES VIA A WIRELESS NETWORK FOR THE PURPOSE OF SENDING AND RECEIVING ELECTRONIC MAIL, FACSIMILES, DATA, IMAGES, INFORMATION, TEXT, NUMERIC MESSAGE AND TEXT MESSAGING AND FOR ACCESSING A GLOBAL COMMUNICATIONS NETWORK; TRANSMISSION OF NEWS OVER THE INTERNET; WORLDWIDE SWITCHED TEXT AND MESSAGE TRANSMISSION SERVICES; PROVIDING ON-LINE CHAT ROOMS AND ELECTRONIC BULLETIN BOARDS FOR TRANSMISSION OF MESSAGES AMONG USERS IN THE FIELD OF VARIOUS SUBJECT MATTER, INCLUDING ENTERTAINMENT, NEWS, MUSIC, TECHNOLOGY, WEATHER, SPORTS AND THE ARTS, PROVIDING ON-LINE CHAT ROOMS FOR TRANSMISSION OF MESSAGES AMONG COMPUTER USERS CONCERNING ON-LINE INTRODUCTION, DATING AND MATCHMAKING SERVICES (U.S. CLS. 100, 101 AND 104).

CLASS 41—EDUCATION AND ENTERTAINMENT

FOR ENTERTAINMENT SERVICES, NAMELY, ORGANIZING SPORTING AND CULTURAL EVENTS; PROVIDING INFORMATION RELATING TO ENTERTAINMENT VIA A GLOBAL COMMUNICATIONS NETWORK; ENTERTAINMENT SERVICES, NAMELY, PROVIDING ONLINE MULTI-PLAYER, INTERACTIVE COMPUTER GAMES (U.S. CLS. 100, 101 AND 107).

CLASS 42—SCIENTIFIC AND COMPUTER SERVICES

FOR CONSULTING SERVICES IN THE FIELD OF SELECTION, IMPLEMENTATION AND USE OF COMPUTER SOFTWARE SYSTEMS AND DATA PROCESSING SYSTEMS FOR OTHERS; COMPUTER SERVICES, NAMELY, PROVIDING SEARCH ENGINES FOR LOCATING INFORMATION, RESOURCES AND THE WEBSITES OF OTHERS ON A GLOBAL COMPUTER NETWORK (U.S. CLS. 100 AND 101).

CLASS 45—PERSONAL AND LEGAL SERVICES

FOR PROVIDING ON-LINE INTRODUCTION, DATING AND MATCHMAKING SERVICES AND INFORMATION RELATING THERETO (U.S. CLS. 100 AND 101).
LINDA ORNDORFF, EXAMINING ATTORNEY

SN 76-644,042. BIOPASSWORD, INC., ISSAQUAH, WA.
FILED 8-1-2005.

BIOPASSWORD

THE MARK CONSISTS OF STANDARD CHARACTERS WITHOUT CLAIM TO ANY PARTICULAR FONT, STYLE, SIZE, OR COLOR.
OWNER OF U.S. REG. NO. 1,854,043.

CLASS 9—ELECTRICAL AND SCIENTIFIC APPARATUS

FOR COMMUNICATIONS SECURITY SOFTWARE FOR CONNECTING GLOBAL COMPUTER NETWORKS, SOFTWARE FOR PUBLIC, PERSONAL AND USER VERIFICATION, IDENTIFICATION AND AUTHENTICATION; USER AUTHENTICATION AND IDENTIFICATION SOFTWARE THAT MAY BE USED IN CONNECTION VIA THE INTERNET AND VIA ALL INTERNAL, EXTERNAL, VOICE, INFRARED, SATELLITE, WIRELESS, DIGITAL AND NON-DIGITAL NETWORKS; SOFTWARE FOR VERIFYING IDENTIFICATION OF THE END USER/ENTITY BY MEANS OF PASSWORD DATA ENTRY AND/OR BEHAVIORAL BIOMETRICS AND/OR PHYSICAL MOVEMENTS BY PEOPLE, ENTITIES OR MACHINES; COMPUTER SOFTWARE FOR USER, ENTITY, SYSTEM AND ACCOUNT IDENTIFICATION SYSTEMS, FOR PROVIDING ACCESS TO COMPUTERS, COMPUTER HARDWARE AND ALL INTERNAL AND EXTERNAL COMPUTER, VOICE, SATELLITE, WIRELESS, INFRARED, DIGITAL AND NON-DIGITAL NETWORKS (U.S. CLS. 21, 23, 26, 36 AND 38).
FIRST USE 2-1-1990; IN COMMERCE 2-1-1990.

CLASS 42—SCIENTIFIC AND COMPUTER SERVICES

FOR DEVELOPMENT, DESIGN, IMPLEMENTATION, TESTING, ANALYSIS, AND CONSULTING SERVICES IN THE FIELD OF SECURITY, ACCESS, AUTHORIZATION, AUTHENTICATION, ENCRYPTION, AND IDENTIFICATION SYSTEMS FOR COMPUTERS, COMPUTER HARDWARE AND COMPUTER NETWORKS; DEVELOPMENT, INTEGRATION AND OPERATION OF COMPUTER SYSTEMS TO SUPPORT ISSUANCE AND MANAGEMENT OF DIGITAL CERTIFICATES; CREATION AND IMPLEMENTATION OF PROCEDURES AND PRACTICES FOR ISSUANCE AND MANAGEMENT OF DIGITAL CERTIFICATES AND ENTERPRISE SOFTWARE INTEGRATION; PROVIDING TECHNICAL SUPPORT IN CONNECTION WITH AUTHENTICATION, PERSONAL IDENTIFICATION INFORMATION, ISSUANCE AND MANAGEMENT OF DIGITAL CERTIFICATES FOR AUTHENTICATION OF IDENTITY OR ENCRYPTION OF A DIGITAL IDENTITY, OR AUTHENTICATION OF A DIGITAL SIGNATURE IN AN ELECTRONIC TRANSACTION OR COMMUNICATION, OVER THE INTERNET AND OTHER COMPUTER NETWORKS (U.S. CLS. 100 AND 101).
FIRST USE 2-1-1990; IN COMMERCE 2-1-1990.

CLASS 45—PERSONAL AND LEGAL SERVICES

FOR IDENTIFICATION VERIFICATION SERVICES, NAMELY, PROVIDING AUTHENTICATION, PERSONAL IDENTIFICATION INFORMATION, ISSUANCE AND MANAGEMENT OF DIGITAL CERTIFICATES FOR AUTHENTICATION OF IDENTITY OR ENCRYPTION OF A DIGITAL IDENTITY, OR AUTHENTICATION OF A DIGITAL SIGNATURE IN AN ELECTRONIC TRANSACTION OR COMMUNICATION, OVER THE INTERNET AND OTHER COMPUTER NETWORKS (U.S. CLS. 100 AND 101).

FIRST USE 2-1-1990; IN COMMERCE 2-1-1990.
FLORENTINA BLANDU, EXAMINING ATTORNEY

SN 76-644,043. BIOPASSWORD, INC., ISSAQUAH, WA.
FILED 8-1-2005.



OWNER OF U.S. REG. NO. 1,854,043.
THE MARK IS THE WORD BIOPASSWORD BELOW A SERIES OF DOTS ARRANGED IN A WAVE PATTERN.

CLASS 9—ELECTRICAL AND SCIENTIFIC APPARATUS

FOR COMMUNICATIONS SECURITY SOFTWARE FOR CONNECTING GLOBAL COMPUTER NETWORKS, SOFTWARE FOR PUBLIC, PERSONAL AND USER VERIFICATION, IDENTIFICATION AND AUTHENTICATION; USER AUTHENTICATION AND IDENTIFICATION SOFTWARE THAT MAY BE USED IN CONNECTION VIA THE INTERNET AND VIA ALL INTERNAL, EXTERNAL, VOICE, INFRARED, SATELLITE, WIRELESS, DIGITAL AND NON-DIGITAL NETWORKS; SOFTWARE FOR VERIFYING IDENTIFICATION OF THE END USER/ENTITY BY MEANS OF PASSWORD DATA ENTRY AND/OR BEHAVIORAL BIOMETRICS AND/OR PHYSICAL MOVEMENTS BY PEOPLE, ENTITIES OR MACHINES; COMPUTER SOFTWARE FOR USER, ENTITY, SYSTEM AND ACCOUNT IDENTIFICATION SYSTEMS, FOR PROVIDING ACCESS TO COMPUTERS, COMPUTER HARDWARE AND ALL INTERNAL AND EXTERNAL COMPUTER, VOICE, SATELLITE, WIRELESS, INFRARED, DIGITAL AND NON-DIGITAL NETWORKS (U.S. CLS. 21, 23, 26, 36 AND 38).
FIRST USE 10-0-2000; IN COMMERCE 10-0-2000.

CLASS 42—SCIENTIFIC AND COMPUTER SERVICES

FOR DEVELOPMENT, DESIGN, IMPLEMENTATION, TESTING, ANALYSIS, AND CONSULTING SERVICES IN THE FIELD OF SECURITY, ACCESS, AUTHORIZATION, AUTHENTICATION, ENCRYPTION, AND IDENTIFICATION SYSTEMS FOR COMPUTERS, COMPUTER HARDWARE AND COMPUTER NETWORKS; DEVELOPMENT, INTEGRATION AND OPERATION OF COMPUTER SYSTEMS TO SUPPORT ISSUANCE AND MANAGEMENT OF DIGITAL CERTIFICATES; CREATION AND IMPLEMENTATION OF PROCEDURES AND PRACTICES FOR ISSUANCE AND MANAGEMENT OF DIGITAL CERTIFICATES AND ENTERPRISE SOFTWARE INTEGRATION; PROVIDING TECHNICAL SUPPORT IN CONNECTION WITH AUTHENTICATION, PERSONAL IDENTIFICATION INFORMATION, ISSUANCE AND MANAGEMENT OF DIGITAL CERTIFICATES FOR AUTHENTICATION OF IDENTITY OR ENCRYPTION OF A DIGITAL IDENTITY, OR AUTHENTICATION OF A DIGITAL SIGNATURE IN AN ELECTRONIC TRANSACTION OR COMMUNICATION, OVER THE INTERNET AND OTHER COMPUTER NETWORKS (U.S. CLS. 100 AND 101).

FIRST USE 10-0-2000; IN COMMERCE 10-0-2000.

CLASS 45—PERSONAL AND LEGAL SERVICES

FOR IDENTIFICATION VERIFICATION SERVICES, NAMELY, PROVIDING AUTHENTICATION, PERSONAL IDENTIFICATION INFORMATION, ISSUANCE AND MANAGEMENT OF DIGITAL CERTIFICATES FOR AUTHENTICATION OF IDENTITY OR ENCRYPTION OF A DIGITAL IDENTITY, OR AUTHENTICATION OF A DIGITAL SIGNATURE IN AN ELECTRONIC TRANSACTION OR COMMUNICATION, OVER THE INTERNET AND OTHER COMPUTER NETWORKS (U.S. CLS. 100 AND 101).

FIRST USE 10-0-2000; IN COMMERCE 10-0-2000.
FLORENTINA BLANDU, EXAMINING ATTORNEY

SN 76-644,605. NETWORK SOLUTIONS, LLC, HERNDON, VA. FILED 8-10-2005.

NAMESECURE

THE MARK CONSISTS OF STANDARD CHARACTERS WITHOUT CLAIM TO ANY PARTICULAR FONT, STYLE, SIZE, OR COLOR.

OWNER OF U.S. REG. NOS. 2,549,368, 2,555,219 AND 2,742,916.

CLASS 35—ADVERTISING AND BUSINESS

FOR DOMAIN NAME ACCOUNT MANAGEMENT SERVICES (U.S. CLS. 100, 101 AND 102).

FIRST USE 4-0-1996; IN COMMERCE 4-0-1996.

CLASS 38—COMMUNICATION

FOR ELECTRONIC MAIL SERVICES; EMAIL AND WEBSITE FORWARDING SERVICES (U.S. CLS. 100, 101 AND 104).

FIRST USE 4-0-1996; IN COMMERCE 4-0-1996.

CLASS 42—SCIENTIFIC AND COMPUTER SERVICES

FOR HOSTING THE WEB SITES OF OTHERS ON A COMPUTER SERVER FOR A GLOBAL COMPUTER NETWORK; DOMAIN NAME REGISTRATION FOR IDENTIFICATION OF USERS ON A GLOBAL COMPUTER NETWORK; DOMAIN NAME SEARCHING SERVICES; REDIRECTING ELECTRONIC MAIL TO CHANGED PERSONAL ELECTRONIC ADDRESSES (U.S. CLS. 100 AND 101).

FIRST USE 4-0-1996; IN COMMERCE 4-0-1996.
RONALD MCMORROW, EXAMINING ATTORNEY

SN 76-645,398. BIZMATICS, INC., CUPERTINO, CA. FILED 8-23-2005.

PROGNOCIS

THE COLOR(S) BLACK AND RED IS/ARE CLAIMED AS A FEATURE OF THE MARK.

THE COLOR BLACK APPEARS IN THE PROGNO PORTION OF THE MARK AND THE LINE BELOW PROGNO, AND THE COLOR RED APPEARS IN THE CIS PORTION OF THE MARK AND THE LINE BELOW THE LETTERS CIS.

CLASS 9—ELECTRICAL AND SCIENTIFIC APPARATUS

FOR COMPUTER SOFTWARE FOR USE IN AUTOMATING MEDICAL PRACTICE WORKFLOWS, NAMELY, PROVIDING ACCESS TO PATIENT HISTORY AND MEDICAL RECORDS ENABLING PHYSICIANS TO LOG PATIENT NOTES AND MANAGE DATA, DOCUMENTS, SCHEDULES, PRESCRIPTIONS, GRAPHICS ANALYSIS, INSURANCE CLAIMS, LAB TESTS AND RADIOLOGY REPORTS IN THE FIELD OF MEDICAL PRACTICE BUSINESS MANAGEMENT (U.S. CLS. 21, 23, 26, 36 AND 38).

FIRST USE 3-11-2003; IN COMMERCE 3-11-2003.

CLASS 42—SCIENTIFIC AND COMPUTER SERVICES

FOR COMPUTER SERVICE, NAMELY, ACTING AS AN APPLICATION SERVICE PROVIDER IN THE FIELD OF KNOWLEDGE MANAGEMENT TO HOST COMPUTER APPLICATION SOFTWARE FOR THE COLLECTION, EDITING, ORGANIZING, MODIFYING, TRANSMISSION, STORAGE AND SHARING OF DATA AND INFORMATION IN THE FIELD OF MEDICAL PRACTICE WORKFLOW AND DATA MANAGEMENT FOR THE MEDICAL INDUSTRY (U.S. CLS. 100 AND 101).

FIRST USE 3-11-2003; IN COMMERCE 3-11-2003.
TONI HICKEY, EXAMINING ATTORNEY

SN 76-645,500. UNITED BIBLE SOCIETIES, INC., MIAMI, FL.
FILED 8-22-2005.



NO CLAIM IS MADE TO THE EXCLUSIVE RIGHT TO USE "TRADUCCION EN LENGUAJE ACTUAL", APART FROM THE MARK AS SHOWN.
THE ENGLISH TRANSLATION OF THE WORD TRADUCCION EN LENGUAJE ACTUAL IN THE MARK IS TRANSLATION IN CURRENT LANGUAGE.

CLASS 9—ELECTRICAL AND SCIENTIFIC APPARATUS

FOR PRE-RECORDED VIDEOS, AUDIOS, CD-ROM AND COMPACT DISCS AND AUDIO CASSETTES FEATURING RELIGIOUS MUSIC, RELIGIOUS SERMONS AND BIBLICAL SCRIPTURES (U.S. CLS. 21, 23, 26, 36 AND 38).
FIRST USE 4-30-2003; IN COMMERCE 4-30-2003.

CLASS 16—PAPER GOODS AND PRINTED MATTER

FOR PRINTED BOOKS FEATURING BIBLICAL TEXTS AND TEACHINGS; PRINTED BIBLES AND SEPARATE PORTIONS THEREOF, NAMELY, NEW TESTAMENT (U.S. CLS. 2, 5, 22, 23, 29, 37, 38 AND 50).
FIRST USE 4-30-2003; IN COMMERCE 4-30-2003.
KARANENDRA S. CHHINA, EXAMINING ATTORNEY

SN 76-651,187. QINETIQ LIMITED, FAMBOROUGH, HAMPSHIRE, UNITED KINGDOM, FILED 11-30-2005.



THE MARK CONSISTS OF STANDARD CHARACTERS WITHOUT CLAIM TO ANY PARTICULAR FONT, STYLE, SIZE, OR COLOR.
PRIORITY CLAIMED UNDER SEC. 44(D) ON UNITED KINGDOM APPLICATION NO. 2393451, FILED 6-2-2005, REG. NO. 2393451B, DATED 6-2-2005, EXPIRES 6-2-2015.
PRIORITY CLAIMED UNDER SEC. 44(D) ON UNITED KINGDOM APPLICATION NO. 2393451, FILED 6-2-2005, REG. NO. 2393451A, DATED 6-2-2005, EXPIRES 6-2-2015.

CLASS 9—ELECTRICAL AND SCIENTIFIC APPARATUS

FOR LASER ANEMOMETERS, LASER DOPPLER ANEMOMETERS, LASER DOPPLER VELOCIMETERS (LDVS), LASER RADARS (LIDARS) FOR WIND SPEED MEASUREMENT, LASER BASED WIND SPEED MEASUREMENT APPARATUS, APPARATUS FOR MEASURING WIND SPEED USING INFRA-RED (IR) RADIATION, OPTICAL FIBRE BASED LASER ANEMOMETERS, ANEMOMETERS, GROUND BASED LASER ANEMOMETERS, VEHICLE MOUNTABLE LASER ANEMOMETERS, BUOY MOUNTABLE LASER ANEMOMETERS, SHIP MOUNTABLE LASER ANEMOMETERS, AIRCRAFT MOUNTABLE LASER ANEMOMETERS, AIRBORNE LASER ANEMOMETERS, LASER ANEMOMETERS FOR TRUE AIR-SPEED MEASUREMENTS, LASER ANEMOMETERS FOR AIR TURBULENCE MEASUREMENTS, LASER ANEMOMETERS FOR MEASURING WIND SPEED IN A WIND TUNNEL AND WIND TURBINE MOUNTABLE LASER ANEMOMETERS (U.S. CLS. 21, 23, 26, 36 AND 38).

CLASS 37—CONSTRUCTION AND REPAIR

FOR MAINTENANCE AND REPAIR OF LASER ANEMOMETERS (U.S. CLS. 100, 103 AND 106).

CLASS 42—SCIENTIFIC AND COMPUTER SERVICES

FOR MEASUREMENT EVALUATIONS IN THE FIELD OF WIND SPEED; WIND SPEED MEASUREMENT EVALUATION SERVICES USING LASER ANEMOMETERS; WIND SPEED LASER ANEMOMETRY EVALUATION SERVICES USING LASER ANEMOMETRY, LASER DOPPLER ANEMOMETRY, LASER DOPPLER VELOCIMETRY (LDV), AND LASER RADARS (LIDARS) FOR ACQUIRING WIND SPEED MEASUREMENTS; WIND SPEED MEASUREMENT EVALUATION SERVICES USING LASERS, OPTICAL FIBRE BASED LASER ANEMOMETERS, AND AN APPARATUS COMPRISING A SOURCE OF INFRA-RED (IR) RADIATION; MEASUREMENT EVALUATIONS IN THE FIELD OF AIR TURBULENCE USING LASER ANEMOMETERS; MEASUREMENT EVALUATION SERVICES FOR MEASURING TRUE AIRSPEED USING LASER ANEMOMETERS (U.S. CLS. 100 AND 101).
TONI HICKEY, EXAMINING ATTORNEY

SN 76-654,567. MARS, INCORPORATED, MCLEAN, VA.
FILED 2-3-2006.

SLAMMIN' SALSA

THE MARK CONSISTS OF STANDARD CHARACTERS WITHOUT CLAIM TO ANY PARTICULAR FONT, STYLE, SIZE, OR COLOR.
NO CLAIM IS MADE TO THE EXCLUSIVE RIGHT TO USE "SALSA", APART FROM THE MARK AS SHOWN.

CLASS 5—PHARMACEUTICALS

FOR NUTRITIONALLY FORTIFIED ENERGY BARS FOR USE AS NUTRITIONAL SUPPLEMENTS OR MEAL REPLACEMENT; SOY-BASED SNACK BARS FOR USE AS NUTRITIONAL SUPPLEMENTS OR MEAL REPLACEMENT (U.S. CLS. 6, 18, 44, 46, 51 AND 52).

CLASS 29—MEATS AND PROCESSED FOODS

FOR SOY BASED, MEAT-BASED AND FRUIT BASED SNACK FOODS (U.S. CL. 46).

CLASS 30—STAPLE FOODS

FOR WHEAT-BASED AND RICE-BASED SNACK BARS; WHEAT-BASED AND RICE-BASED SNACK FOODS (U.S. CL. 46).

EVELYN BRADLEY, EXAMINING ATTORNEY

SN 76-658,093. THE TALBOT GROUP, LLC, WILMINGTON, DE. FILED 4-10-2006.

**CLASS 25—CLOTHING**

FOR CLOTHING, NAMELY, CHILDREN'S CLOTHING, NAMELY, SHIRTS, SKIRTS, DRESSES, PANTS, SHORTS, BLAZERS, JACKETS, COATS, T-SHIRTS, SWEATERS, SWEATSHIRTS, SWEATPANTS, SWEATERS, JUMP SUITS, SLEEPWEAR, PAJAMAS, UNDERWEAR, TOPS AND BOTTOMS, CAPS, HATS, GLOVES, MITTENS, SOCKS, STOCKINGS, TIGHTS, AND FOOTWEAR; AND WOMEN'S CLOTHING, NAMELY, BLOUSES, SHIRTS, SKIRTS, DRESSES, SUN-DRESSES, PANTS, SHORTS, BLAZERS, JACKETS, T-SHIRTS, SWEATERS, SWEATSHIRTS, SWEATPANTS, JOGGING SUITS, SWEATERS, JUMP SUITS, SLEEPWEAR, PAJAMAS, NIGHT GOWNS, LOUNGE WEAR, BATHROBES, AND WOMEN'S UNDERWEAR, TOPS AND BOTTOMS, CAPS, HATS, GLOVES, MITTENS, SOCKS, STOCKINGS, TIGHTS, AND FOOTWEAR (U.S. CLS. 22 AND 39).

CLASS 35—ADVERTISING AND BUSINESS

FOR RETAIL STORE SERVICES FEATURING CHILDREN'S AND WOMEN'S CLOTHING, CLOTHING ACCESSORIES, AND FOOTWEAR (U.S. CLS. 100, 101 AND 102).

RICHARD A. STRASER, EXAMINING ATTORNEY

SN 76-657,730. KONAMI SPORTS & LIFE CO., LTD., TOKYO, JAPAN, FILED 4-3-2006.



SN 76-658,343. UNITED PRESS INTERNATIONAL, WASHINGTON, DC. FILED 4-12-2006.

CLASS 9—ELECTRICAL AND SCIENTIFIC APPARATUS

FOR FITNESS EXERCISE RECORDED COMPUTER PROGRAM; FITNESS EXERCISE RECORDED DVD, TELEVISION MONITOR, VIDEO GAME SOFTWARE AND VIDEO GAME PROGRAM (U.S. CLS. 21, 23, 26, 36 AND 38).

CLASS 28—TOYS AND SPORTING GOODS

FOR GYMNASTIC, SPORTING, AND FITNESS ARTICLES, NAMELY, PERSONAL EXERCISE FLOOR MATS INCORPORATING ELECTRONIC SENSORS, WEIGHT LIFTING BELTS INCORPORATING ELECTRONIC SENSORS, AND RECEIVERS OF ELECTRIC WAVES EMITTED BY BELTS ALL SOLD AS A UNIT; STAND ALONE VIDEO GAME MACHINES FOR PHYSICAL FITNESS TRAINING (U.S. CLS. 22, 23, 38 AND 50).

CLASS 41—EDUCATION AND ENTERTAINMENT

FOR EDUCATIONAL AND INSTRUCTIONAL SERVICES FOR SPORTS, NAMELY, AEROBICS INSTRUCTION, PHYSICAL FITNESS INSTRUCTION, YOGA INSTRUCTION, MARTIAL ARTS INSTRUCTION, DANCE INSTRUCTION; PHYSICAL FITNESS INSTRUCTION IN THE NATURE OF AN EXERCISE PROGRAM BASED ON A VIDEO GAME; PROVIDING PHYSICAL FITNESS FACILITIES, HEALTH CLUB SERVICES, NAMELY, PROVIDING FITNESS MACHINES FOR PHYSICAL FITNESS TRAINING (U.S. CLS. 100, 101 AND 107).

TARAH HARDY, EXAMINING ATTORNEY

UPI

THE MARK CONSISTS OF STANDARD CHARACTERS WITHOUT CLAIM TO ANY PARTICULAR FONT, STYLE, SIZE, OR COLOR.

OWNER OF U.S. REG. NOS. 679,644, 697,239 AND 1,261,962.

CLASS 9—ELECTRICAL AND SCIENTIFIC APPARATUS

FOR PRE-RECORDED VIDEOS AND TAPES FEATURING NEWS; FILMS ON THE TOPIC OF NEWS (U.S. CLS. 21, 23, 26, 36 AND 38).

FIRST USE 5-24-1958; IN COMMERCE 5-24-1958.

CLASS 16—PAPER GOODS AND PRINTED MATTER

FOR NEWS BULLETINS; PHOTOGRAPHS (U.S. CLS. 2, 5, 22, 23, 29, 37, 38 AND 50).

FIRST USE 5-24-1958; IN COMMERCE 5-24-1958.

CLASS 35—ADVERTISING AND BUSINESS

FOR NEWS CLIPPING SERVICES; LICENSING OF FILM AND PHOTOGRAPHS; LICENSING OF NEWS ARTICLES; PROMOTION OF THE BOOKS OF OTHER NEWS TOPICS AND NEWS GATHERING (U.S. CLS. 100, 101 AND 102).

FIRST USE 5-24-1958; IN COMMERCE 5-24-1958.

CLASS 38—COMMUNICATION

FOR TRANSMISSION OF NEWS IN AUDIO, VIDEO, FIXED PHOTO AND TEXT FORMATS IN MULTIPLE LANGUAGES AND VIA THE INTERNET, MOBILE PHONES, RADIO, AND TV (U.S. CLS. 100, 101 AND 104).

FIRST USE 5-24-1958; IN COMMERCE 5-24-1958.

CLASS 41—EDUCATION AND ENTERTAINMENT

FOR NEWS AGENCIES, NAMELY, GATHERING AND DISSEMINATION OF NEWS; NEWS ANALYSIS AND FEATURES DISTRIBUTION; NEWS SYNDICATION FOR BROADCASTING INDUSTRY; NEWS SYNDICATION REPORTING; CUSTOM WRITING SERVICES; PROVIDING INFORMATION AND NEWS ALL IN THE FIELD OF CURRENT EVENTS AND NEWS IN THE NATURE OF CURRENT EVENT REPORTING VIA THE INTERNET; VIDEO TAPE AND DISC PRODUCTION FOR OTHERS; PHOTOGRAPHY SERVICES; NEWS REPORTING SERVICES FEATURING INTERVIEWS; PROVIDING ONLINE PUBLICATIONS IN THE NATURE OF NEWS BULLETINS IN THE FIELD OF CURRENT EVENTS (U.S. CLS. 100, 101 AND 107).

FIRST USE 5-24-1958; IN COMMERCE 5-24-1958.

CLASS 42—SCIENTIFIC AND COMPUTER SERVICES

FOR STOCK PHOTOGRAPHY SERVICES, NAMELY, LEASING REPRODUCTION RIGHTS OF PHOTOGRAPHS AND TRANSPARENCIES TO OTHERS (U.S. CLS. 100 AND 101).

FIRST USE 5-24-1958; IN COMMERCE 5-24-1958.
LINDA ESTRADA, EXAMINING ATTORNEY

SN 76-659,411. REDXDEFENSE, LLC, ROCKVILLE, MD. FILED 4-28-2006.

REDX

CLASS 9—ELECTRICAL AND SCIENTIFIC APPARATUS

FOR PORTABLE AND FIXED BASE HAZARD DETECTION AND ALARM SYSTEMS FOR DETECTING SECURITY THREATS, NAMELY, EXPLOSIVES, RADIATION, AND CHEMICAL/BIOLOGICAL TOXINS; SOFTWARE FOR PERFORMING MULTI-LAYER MONITORING OF SECURITY SYSTEMS, NAMELY, MONITORING AND CHANGING SECURITY THREAT LEVELS AND INITIATING APPROPRIATE SECURITY PROCEDURES, AUTHENTICATING USERS OF THE DETECTION AND ALARM SYSTEMS, AUDITING AND ANALYZING PERFORMANCE OF THE SYSTEM AS IT PERFORMS ITS TASKS (U.S. CLS. 21, 23, 26, 36 AND 38).

FIRST USE 3-31-2005; IN COMMERCE 3-31-2005.

CLASS 42—SCIENTIFIC AND COMPUTER SERVICES

FOR SECURITY SOLUTION SERVICES, NAMELY, DEVELOPING FULLY INTEGRATED HAZARD SECURITY AND ALARM SYSTEMS DEIGNED TO DETECT EXPLOSIVES, RADIATION, AND CHEMICAL/BIOLOGICAL TOXINS (U.S. CLS. 100 AND 101).

FIRST USE 3-31-2005; IN COMMERCE 3-31-2005.
SUZANNE BLANE, EXAMINING ATTORNEY

SN 76-660,172. ADVANTAGE MEDIA GROUP, LLC, WESTBROOK, ME. FILED 5-17-2006.

THE TOTAL TRANSFORMATION

THE MARK CONSISTS OF STANDARD CHARACTERS WITHOUT CLAIM TO ANY PARTICULAR FONT, STYLE, SIZE, OR COLOR.

CLASS 9—ELECTRICAL AND SCIENTIFIC APPARATUS

FOR PRERECORDED CD'S AND DVD'S FEATURING INFORMATION ON PARENTING SKILLS AND TECHNIQUES (U.S. CLS. 21, 23, 26, 36 AND 38).

FIRST USE 8-28-2004; IN COMMERCE 8-28-2004.

CLASS 45—PERSONAL AND LEGAL SERVICES

FOR PROVIDING INFORMATION IN THE FIELD OF PARENTING CONCERNING INTRA-FAMILY RELATIONSHIPS THROUGH VARIOUS PARENTING TECHNIQUES BY MEANS OF A TOLL-FREE TELEPHONE NUMBER (U.S. CLS. 100 AND 101).

FIRST USE 8-28-2004; IN COMMERCE 8-28-2004.
WILLIAM ROSSMAN, EXAMINING ATTORNEY

SN 76-660,617. RFSCO, INC., DBA THE SHARPE GROUP, MEMPHIS, TN. FILED 5-25-2006.

SHARPE  GROUP

NO CLAIM IS MADE TO THE EXCLUSIVE RIGHT TO USE "GROUP", APART FROM THE MARK AS SHOWN.

CLASS 35—ADVERTISING AND BUSINESS

FOR CONSULTING AND ADVISING SERVICES IN THE FIELD OF SOLICITATION OF PHILANTHROPIC CONTRIBUTORS (U.S. CLS. 100, 101 AND 102).

FIRST USE 10-0-2003; IN COMMERCE 10-0-2003.

CLASS 36—INSURANCE AND FINANCIAL

FOR CONSULTING AND ADVISING SERVICES IN THE FIELD OF PHILANTHROPIC FINANCIAL PLANNING AND FINANCIAL MANAGEMENT (U.S. CLS. 100, 101 AND 102).

FIRST USE 10-0-2003; IN COMMERCE 10-0-2003.
BRIAN NEVILLE, EXAMINING ATTORNEY

SN 76-661,934. BELATOR LLC, STUDIO CITY, CA. FILED 6-21-2006.

RandyBlue

THE MARK CONSISTS OF STANDARD CHARACTERS WITHOUT CLAIM TO ANY PARTICULAR FONT, STYLE, SIZE, OR COLOR.

"THE NAME(S), PORTRAIT(S), AND/OR SIGNATURE(S) SHOWN IN THE MARK DOES NOT IDENTIFY A PARTICULAR LIVING INDIVIDUAL."

CLASS 9—ELECTRICAL AND SCIENTIFIC APPARATUS

FOR PRE-RECORDED VIDEOTAPES AND DIGITAL VIDEO DISCS, DVDS, IN THE FIELD OF ADULT ENTERTAINMENT (U.S. CLS. 21, 23, 26, 36 AND 38).

CLASS 16—PAPER GOODS AND PRINTED MATTER

FOR MAGAZINES AND PRINTED MATERIALS IN THE FIELD OF ADULT ENTERTAINMENT (U.S. CLS. 2, 5, 22, 23, 29, 37, 38 AND 50).

CLASS 35—ADVERTISING AND BUSINESS

FOR COMPUTERIZED ON-LINE STORE RETAIL SERVICES IN THE FIELD OF ADULT ENTERTAINMENT, NAMELY, PROVIDING PHOTOGRAPHS, MOTION PICTURE CLIPS, COMMENTARY AND ARTICLES IN THE FIELD OF ADULT ENTERTAINMENT VIA A GLOBAL COMPUTER NETWORK (U.S. CLS. 100, 101 AND 102).

STEPHANIE ALI, EXAMINING ATTORNEY

SN 76-663,393. LANDO, ALLISON, STATEN ISLAND, NY. FILED 7-20-2006.

ALLY & BAILEY COMPANY

THE MARK CONSISTS OF STANDARD CHARACTERS WITHOUT CLAIM TO ANY PARTICULAR FONT, STYLE, SIZE, OR COLOR.

NO CLAIM IS MADE TO THE EXCLUSIVE RIGHT TO USE "COMPANY", APART FROM THE MARK AS SHOWN.

CLASS 25—CLOTHING

FOR CLOTHING, NAMELY, SHIRTS, T-SHIRTS, BABY CLOTHING, NAMELY, LAYETTES, ONE PIECE OUTFITS, SHIRTS, SWEATERS, T-SHIRTS, PANTS, AND HATS, CAPS, BABY BUNTING OUTFITS (U.S. CLS. 22 AND 39).

FIRST USE 11-0-2005; IN COMMERCE 11-0-2005.

CLASS 28—TOYS AND SPORTING GOODS

FOR PARTY FAVORS IN THE NATURE OF SMALL TOYS (U.S. CLS. 22, 23, 38 AND 50).

FIRST USE 11-1-2005; IN COMMERCE 11-1-2005.

CLASS 45—PERSONAL AND LEGAL SERVICES

FOR PREPARATION OF CUSTOMIZED GIFT BASKETS, PREPARATION OF CUSTOMIZED GIFT BASKETS WITH SELECTED ITEMS REGARDING A PARTICULAR OCCASION OR THEME, AND PERSONAL GIFT SELECTION FOR OTHERS (U.S. CLS. 100 AND 101).

FIRST USE 11-1-2005; IN COMMERCE 11-1-2005.
KELLY BOULTON, EXAMINING ATTORNEY

SN 76-663,754. ADVANCE MAGAZINE PUBLISHERS INC., NEW YORK, NY. FILED 7-27-2006.

BRIDES

THE MARK CONSISTS OF STANDARD CHARACTERS WITHOUT CLAIM TO ANY PARTICULAR FONT, STYLE, SIZE, OR COLOR.

OWNER OF U.S. REG. NOS. 340,115, 2,340,335 AND OTHERS.
SEC. 2(F).

CLASS 35—ADVERTISING AND BUSINESS

FOR PROMOTING THE GOODS AND SERVICES OF OTHERS VIA WIRELESS AND MOBILE DEVICES (U.S. CLS. 100, 101 AND 102).

CLASS 38—COMMUNICATION

FOR TRANSMISSION OF INFORMATION VIA WIRELESS AND MOBILE DEVICES, SATELLITE AND CABLE AND OTHER MEANS OF DIGITAL AND ELECTRONIC TRANSMISSIONS; TRANSMISSION OF INFORMATION VIA DIGITAL NETWORKS AND ELECTRONIC COMMUNICATIONS NETWORKS (U.S. CLS. 100, 101 AND 104).

ANDREW RHIM, EXAMINING ATTORNEY

SN 76-664,043. E. BEGEROW GMBH & CO., 55450 LANGENLONSHEIM, FED REP GERMANY, FILED 8-2-2006.

MINICAP

THE MARK CONSISTS OF STANDARD CHARACTERS WITHOUT CLAIM TO ANY PARTICULAR FONT, STYLE, SIZE, OR COLOR.

CLASS 1—CHEMICALS

FOR MINERAL SUBSTANCES IN THE NATURE OF FILTERING MATERIALS COMPRISED OF ORGANIC AND INORGANIC FILLING MATERIALS, NAMELY, DIATOMITE, PERLITE, BENTONITE, CELLULOSE, AND CHEMICAL SALTS; CHEMICAL ADDITIVES, NAMELY, WET STRENGTH AGENTS, RESINS, NAMELY, ACRYLIC RESINS, EPOXY RESINS, EPICHLOROHYDRINE RESINS, MELAMINE RESINS, PHENOLIC RESINS, SURFACTANTS, POLYMER BASED COMPOSITIONS, WATERPROOFING AGENTS AND HYDROPHILIC AGENTS, ALL FOR USE IN CONNECTION WITH WATER FILTRATION PROCESSES (U.S. CLS. 1, 5, 6, 10, 26 AND 46).

CLASS 7—MACHINERY

FOR FILTER DEVICES, FILTER APPARATUS, FILTER MODULES, FILTER CANDLES AND FILTER MEDIA AS PARTS OF FILTERING MACHINES AND FILTERING INSTALLATIONS CONSTRUCTED THEREFROM, NAMELY, FILTERS FOR MACHINES USED IN THE FILTRATION, CLARIFYING AND STERILIZING OF FLUIDS IN THE BEVERAGE, CHEMICAL AND CHEMICAL-PHARMACEUTICAL INDUSTRIES, NAMELY, FILTERS COMPRISED OF ORGANIC AND INORGANIC FILLERS, FIBROUS MATERIALS, ION EXCHANGING MATERIALS, RESINS, POLYMERS, AND HYDROPHILIC AGENTS (U.S. CLS. 13, 19, 21, 23, 31, 34 AND 35).

CLASS 11—ENVIRONMENTAL CONTROL APPARATUS

FOR FILTER MATERIALS, NAMELY, FILTER MEDIA, FILTER BEDS, FILTER CAPSULES, AND DEPTH FILTERS IN THE FORM OF FILTER SHEETS FOR USE IN CLARIFYING, FILTRATION AND STERILIZATION OF FLUIDS IN THE BEVERAGE, CHEMICAL AND CHEMICAL-PHARMACEUTICAL INDUSTRY; FILLING MATERIALS IN THE FORM OF FIBROUS FILTERING MEDIA WITH INTERFACES MODIFIED USING CHEMICAL-PHYSICAL AND BIOLOGICAL PROCESS FOR USE IN CLARIFYING, FILTRATIONS AND STERILIZATION OF FLUID IN THE DRINK, CHEMICAL AND CHEMICAL-PHARMACEUTICAL INDUSTRY (U.S. CLS. 13, 21, 23, 31 AND 34).

JANICE KIM, EXAMINING ATTORNEY

SN 76-664,044. E. BEGEROW GMBH & CO., 55450 LANGENSHEIM, FED REP GERMANY, FILED 8-2-2006.

BECOCAP

THE MARK CONSISTS OF STANDARD CHARACTERS WITHOUT CLAIM TO ANY PARTICULAR FONT, STYLE, SIZE, OR COLOR.

CLASS 1—CHEMICALS

FOR MINERAL SUBSTANCES IN THE NATURE OF FILTERING MATERIALS COMPRISED OF ORGANIC AND INORGANIC FILLING MATERIALS, NAMELY, DIATOMITE, PERLITE, BENTONITE, CELLULOSE, AND CHEMICAL SALTS; CHEMICAL ADDITIVES, NAMELY, WET STRENGTH AGENTS, RESINS, NAMELY, ACRYLIC RESINS, EPOXY RESINS, EPICHLOROHYDRINE RESINS, MELAMINE RESINS, PHENOLIC RESINS, SURFACTANTS, POLYMER BASED COMPOSITIONS, WATERPROOFING AGENTS AND HYDROPHILIC AGENTS, ALL FOR USE IN CONNECTION WITH WATER FILTRATION PROCESSES (U.S. CLS. 1, 5, 6, 10, 26 AND 46).

CLASS 7—MACHINERY

FOR FILTER DEVICES, FILTER APPARATUS, FILTER MODULES, FILTER CANDLES AND FILTER MEDIA AS PARTS OF FILTERING MACHINES AND FILTERING INSTALLATIONS CONSTRUCTED THEREFROM, NAMELY, FILTERS FOR MACHINES USED IN THE FILTRATION, CLARIFYING AND STERILIZING OF FLUIDS IN THE BEVERAGE, CHEMICAL AND CHEMICAL-PHARMACEUTICAL INDUSTRIES, NAMELY, FILTERS COMPRISED OF ORGANIC AND INORGANIC FILLERS, FIBROUS MATERIALS, ION EXCHANGING MATERIALS, RESINS, POLYMERS, AND HYDROPHILIC AGENTS (U.S. CLS. 13, 19, 21, 23, 31, 34 AND 35).

CLASS 11—ENVIRONMENTAL CONTROL APPARATUS

FOR FILTER MATERIALS, NAMELY, FILTER MEDIA, FILTER BEDS, FILTER CAPSULES, AND DEPTH FILTERS IN THE FORM OF FILTER SHEETS FOR USE IN CLARIFYING, FILTRATION AND STERILIZATION OF FLUIDS IN THE BEVERAGE, CHEMICAL AND CHEMICAL-PHARMACEUTICAL INDUSTRY; FILLING MATERIALS IN THE FORM OF FIBROUS FILTERING MEDIA WITH INTERFACES MODIFIED USING CHEMICAL-PHYSICAL AND BIOLOGICAL PROCESS FOR USE IN CLARIFYING, FILTRATIONS AND STERILIZATION OF FLUID IN THE DRINK, CHEMICAL AND CHEMICAL-PHARMACEUTICAL INDUSTRY (U.S. CLS. 13, 21, 23, 31 AND 34).

JANICE KIM, EXAMINING ATTORNEY

SN 76-664,909. ADVANCED FINANCIAL STRATEGIES, INC., IRVINE, CA. FILED 8-21-2006.

ADVANCED FINANCIAL STRATEGIES

THE MARK CONSISTS OF STANDARD CHARACTERS WITHOUT CLAIM TO ANY PARTICULAR FONT, STYLE, SIZE, OR COLOR.

NO CLAIM IS MADE TO THE EXCLUSIVE RIGHT TO USE "FINANCIAL", APART FROM THE MARK AS SHOWN.

SEC. 2(F).

CLASS 35—ADVERTISING AND BUSINESS

FOR BUSINESS PLANNING AND TAX PLANNING CONSULTATION SERVICES (U.S. CLS. 100, 101 AND 102).

FIRST USE 12-31-1993; IN COMMERCE 12-31-1993.

CLASS 36—INSURANCE AND FINANCIAL

FOR FINANCIAL PLANNING, INVESTMENT MANAGEMENT, INSURANCE NEED ANALYSIS AND PLANNING AND BUSINESS FINANCING SERVICES (U.S. CLS. 100, 101 AND 102).

FIRST USE 12-31-1993; IN COMMERCE 12-31-1993.
DARRYL SPRUILL, EXAMINING ATTORNEY

SN 76-665,700. GSI TECHNOLOGIES, LLC, DBA GRAPHICS SOLUTIONS INTERNATIONAL, LLC AKA BKL A GRAPHICS SOLUTIONS COMPANY, BURR RIDGE, IL. FILED 9-7-2006.

GSİ TECHNOLOGIES

THE MARK CONSISTS OF STANDARD CHARACTERS WITHOUT CLAIM TO ANY PARTICULAR FONT, STYLE, SIZE, OR COLOR.

NO CLAIM IS MADE TO THE EXCLUSIVE RIGHT TO USE "TECHNOLOGIES", APART FROM THE MARK AS SHOWN.

CLASS 9—ELECTRICAL AND SCIENTIFIC APPARATUS

FOR PRINTED RFID ANTENNAS, PRINTED CIRCUIT BOARDS, THIN FLEXIBLE MICROELECTRONIC (TFM) ENERGY CELLS, RFID LABELS AND SYSTEMS, NAMELY RFID READERS AND TAGS, DURABLE IMAGE PLATES AND TAGS, NAMELY PLATE CAMERAS (U.S. CLS. 21, 23, 26, 36 AND 38).

CLASS 11—ENVIRONMENTAL CONTROL APPARATUS

FOR ELECTRO-LUMINESCENCE (EL) LAMPS AND LAMP FIXTURES (U.S. CLS. 13, 21, 23, 31 AND 34).

CLASS 40—MATERIAL TREATMENT

FOR PRINTING SERVICES IN THE NATURE OF PROVIDING FLEXOGRAPHY SERVICES, HOT STAMPING, SCREEN PRINTING, DURABLE IMAGE PLATES AND TAGS, AND CONDUCTIVE PRINTING (U.S. CLS. 100, 103 AND 106).

CLASS 42—SCIENTIFIC AND COMPUTER SERVICES

FOR PROVIDING CONSULTING AND TECHNICAL SUPPORT IN THE FORM OF MONITORING AND TROUBLE SHOOTING SERVICES IN THE FIELD OF RFID SYSTEM DESIGN, RFID ANTENNAS, RFID LABELS, AND RFID SYSTEMS; SEMI-CONDUCTOR CHIP MOUNTING, AND ELECTRO-MECHANICAL PICK-AND-PLACE PRODUCTION LINE SERVICES (U.S. CLS. 100 AND 101).

TAMARA FRAZIER, EXAMINING ATTORNEY

SN 76-665,852. THE UNITED METHODIST PUBLISHING HOUSE, NASHVILLE, TN. FILED 9-11-2006.

PARTHENON PRESS

THE MARK CONSISTS OF STANDARD CHARACTERS WITHOUT CLAIM TO ANY PARTICULAR FONT, STYLE, SIZE, OR COLOR.

OWNER OF U.S. REG. NO. 1,999,530.

NO CLAIM IS MADE TO THE EXCLUSIVE RIGHT TO USE "PRESS", APART FROM THE MARK AS SHOWN.

CLASS 16—PAPER GOODS AND PRINTED MATTER

FOR PUBLICATIONS, NAMELY BOOKS, COURSE BOOKS, STUDY AIDS, BROCHURES AND PAMPHLETS IN THE FIELD OF RELIGION, CHRISTIANITY AND FAMILY VALUES (U.S. CLS. 2, 5, 22, 23, 29, 37, 38 AND 50).

CLASS 41—EDUCATION AND ENTERTAINMENT

FOR PUBLICATION SERVICES, NAMELY PUBLISHING BOOKS, MANUSCRIPTS, MAGAZINES, PAMPHLETS, BROCHURES ON BEHALF OF OTHERS IN THE FIELD OF RELIGION, CHRISTIANITY AND FAMILY VALUES (U.S. CLS. 100, 101 AND 107).

REBECCA POVARCHUK, EXAMINING ATTORNEY

SN 76-666,274. MISTER CARTOON HOLDINGS LLC, LOS ANGELES, CA. FILED 9-19-2006.

MISTER CARTOON

THE MARK CONSISTS OF STANDARD CHARACTERS WITHOUT CLAIM TO ANY PARTICULAR FONT, STYLE, SIZE, OR COLOR.

CLASS 3—COSMETICS AND CLEANING PREPARATIONS

FOR GENERAL PURPOSE CLEANING, POLISHING, AND ABRASIVE LIQUIDS AND POWDERS; SCOURING PREPARATIONS, NAMELY, SCOURING LIQUIDS AND POWDERS; HAND SOAPS; LIQUID SOAPS FOR HANDS, FACE AND BODY; PERFUMERY; PERFUMES; TOILET WATER; ESSENTIAL OILS FOR PERSONAL USE; COSMETICS; HAIR LOTIONS; DENTIFRICES; DEODORANTS FOR PERSONAL USE; CLEANSING MILK FOR TOILETRY PURPOSES; TALCUM POWDER; COSMETIC OILS FOR THE BODY; COSMETIC CREAMS; MAKE-UP; SHAVING PRODUCTS, NAMELY, SHAVING LATHER, SHAVING GELS, AFTER SHAVE LOTIONS, SHAVING SOAPS; COSMETIC KITS COMPRISED OF LIPSTICK, MASCARA AND LIP GLOSS; SKIN CLEANERS; HAIR SHAMPOO; BATH OILS (U.S. CLS. 1, 4, 6, 50, 51 AND 52).

CLASS 5—PHARMACEUTICALS

FOR NUTRITIONAL PRODUCTS, NAMELY, SUPPLEMENTS, NUTRITIONAL OILS FOR SKIN CARE, NUTRITIONAL SUPPLEMENTS IN LOTION FORM SOLD AS A COMPONENT OF NUTRITIONAL SKIN CARE PRODUCTS (U.S. CLS. 6, 18, 44, 46, 51 AND 52).

CLASS 9—ELECTRICAL AND SCIENTIFIC APPARATUS

FOR OPTICAL WARE AND EYE CARE PRODUCTS, NAMELY, EYEGLASSES, COMPUTER SCREENS, COMPUTER SCREEN FILTERS, COMPUTER GLARE REDUCER SCREENS, COMPUTER GOGGLES, SPECTACLES, EYEGLASS LENSES, EYEGLASS FRAMES, EYEGLASS CASES AND POUCHES, EYEGLASS RETENTION BANDS, SUNGLASSES, BINOCULARS, OPTICAL LENSES, MICROSCOPES, TELESCOPES, SAFETY GOGGLES, SPORTS GOGGLES, NIGHT VISION GOGGLES; PRE-RECORDED VIDEO CASSETTES, COMPACT DISCS, CD-ROM DISCS AND DVD DISCS FEATURING DRAWING INSTRUCTIONAL, TATTOO ART DOCUMENTARIES; COMPUTER GAMES EQUIPMENT, NAMELY, COMPUTER GAME SOFTWARE IN THE FORM OF CARTRIDGES, CASSETTES, DISCS, AND TAPES, INTERACTIVE MULTIMEDIA COMPUTER GAME PROGRAMS AND INTERACTIVE VIDEO GAMES PROGRAMS IN THE NATURE OF CARTRIDGES, CASSETTES, DISCS AND TAPES (U.S. CLS. 21, 23, 26, 36 AND 38).

CLASS 12—VEHICLES

FOR VEHICLES FOR LOCOMOTION BY LAND, AIR OR WATER, NAMELY, AUTOMOBILES, AIR-CUSHION HOVERCRAFT VEHICLES, AIRPLANES, BOATS, SEA PLANES, VANS, TRUCKS, MOTORCYCLES, BICYCLES AND GO-CARTS; PARTS FOR LAND AND AIR VEHICLES, NAMELY, TIRES AND WHEEL RIMS (U.S. CLS. 19, 21, 23, 31, 35 AND 44).

CLASS 14—JEWELRY

FOR JEWELRY, NAMELY, SILVER AND GOLD JEWELRY, JEWELRY MADE OF PRECIOUS METALS AND STONES, BRACELETS, EARRINGS, RINGS, NECKLACES, TOE RINGS, CUFFLINKS, TIE TACKS, PINS, AND WATCHES (U.S. CLS. 2, 27, 28 AND 50).

CLASS 18—LEATHER GOODS

FOR PURSES AND ACCESSORIES, NAMELY, SHOULDER BAGS, WALLETS, BACKPACKS, BRIEF-CASE-TYPE PORTFOLIOS, KNAPSACKS, RUCKSACKS, HANDBAGS, LUGGAGE, TRAVEL BAGS, BEACH BAGS, GARMENT BAGS FOR TRAVEL, GYM BAGS, DUFFEL BAGS, ATTACHE CASES, SHOPPING BAGS MADE OF MESH, TEXTILE AND LEATHER, SATCHELS AND UMBRELLAS (U.S. CLS. 1, 2, 3, 22 AND 41).

CLASS 25—CLOTHING

FOR BELTS FOR CLOTHING (U.S. CLS. 22 AND 39).

CLASS 26—FANCY GOODS

FOR BELT BUCKLES FOR CLOTHING; BELT BUCKLES OF PRECIOUS METAL FOR CLOTHING (U.S. CLS. 37, 39, 40, 42 AND 50).

CLASS 37—CONSTRUCTION AND REPAIR

FOR VEHICLE DETAILING AND CUSTOMIZING SERVICES, NAMELY, RECONDITIONING AUTOMOBILE BODIES, UNDERCARRIAGES AND INTERIORS, CUSTOMIZING AUTOMOBILE PAINT JOBS AND RE-DESIGN (U.S. CLS. 100, 103 AND 106).

SUZANNE BLANE, EXAMINING ATTORNEY

SN 76-666,756. SOUTH JERSEY AGRICULTURAL PRODUCTS, INC., ELMER, NJ. FILED 9-27-2006.

MILITARY BRAND

THE MARK CONSISTS OF STANDARD CHARACTERS WITHOUT CLAIM TO ANY PARTICULAR FONT, STYLE, SIZE, OR COLOR.

NO CLAIM IS MADE TO THE EXCLUSIVE RIGHT TO USE "BRAND", APART FROM THE MARK AS SHOWN.

CLASS 1—CHEMICALS

FOR NATURAL PRODUCTS FOR USE IN HORTICULTURE AND LANDSCAPE APPLICATIONS, NAMELY, HUMUS, MANURE, POTTING SOIL, COMPOST AND SOIL AMENDMENTS (U.S. CLS. 1, 5, 6, 10, 26 AND 46).

CLASS 31—NATURAL AGRICULTURAL PRODUCTS

FOR MULCH; BLENDED AND SCREENED TOPSOIL (U.S. CLS. 1 AND 46).

JOHN SCHUYLER YARD, EXAMINING ATTORNEY

SN 76-667,698. AMERICAN CHEMICAL SOCIETY, WASHINGTON, DC. FILED 10-18-2006.

ACS GREEN CHEMISTRY INSTITUTE

THE MARK CONSISTS OF STANDARD CHARACTERS WITHOUT CLAIM TO ANY PARTICULAR FONT, STYLE, SIZE, OR COLOR.

OWNER OF U.S. REG. NOS. 1,082,875 AND 1,481,565.

NO CLAIM IS MADE TO THE EXCLUSIVE RIGHT TO USE "GREEN CHEMISTRY INSTITUTE", APART FROM THE MARK AS SHOWN.

CLASS 35—ADVERTISING AND BUSINESS

FOR PROVIDING INFORMATION TO THE PUBLIC TO INCREASE AWARENESS AND UNDERSTANDING OF GREEN CHEMISTRY AND ITS BENEFITS; PROMOTING THE SERVICES OF OTHERS BY DISTRIBUTING MATERIALS ON FUNDING, RESEARCH AND EDUCATIONAL OPPORTUNITIES IN THE FIELD OF GREEN CHEMISTRY THROUGH A VARIETY OF METHODS; INDUSTRIAL MANAGEMENT ASSISTANCE, NAMELY, AIDING BUSINESSES WITH INDUSTRIAL IMPLEMENTATION OF GREEN CHEMISTRY PRINCIPLES (U.S. CLS. 100, 101 AND 102).

FIRST USE 9-28-2006; IN COMMERCE 9-28-2006.

CLASS 41—EDUCATION AND ENTERTAINMENT

FOR EDUCATIONAL SERVICES, NAMELY, PROVIDING WORKSHOPS FOR STUDENTS, FACULTY, AND EXPERIENCED SCIENTISTS IN THE FIELD OF GREEN CHEMISTRY; ORGANIZATION OF CONFERENCES AND SYMPOSIA IN GREEN CHEMISTRY; PROVIDING RECOGNITION AND INCENTIVES BY THE WAY OF ADMINISTERING AN AWARDS PROGRAM TO DEMONSTRATE EXCELLENCE IN THE FIELD OF GREEN CHEMISTRY (U.S. CLS. 100, 101 AND 107).

FIRST USE 9-28-2006; IN COMMERCE 9-28-2006.

SKYE YOUNG, EXAMINING ATTORNEY

SN 76-668,013. CARMICHAEL TRAINING SYSTEMS, INC., COLORADO SPRINGS, CO. FILED 10-25-2006.

WINNING LIFE. NOW.

THE MARK CONSISTS OF STANDARD CHARACTERS WITHOUT CLAIM TO ANY PARTICULAR FONT, STYLE, SIZE, OR COLOR.

CLASS 9—ELECTRICAL AND SCIENTIFIC APPARATUS

FOR ELECTRONIC GOODS, NAMELY, VIDEO CASSETTES, DIGITAL VIDEO DISCS AND CD'S FEATURING ENDURANCE AND AEROBIC TRAINING, PHYSICAL FITNESS AND NUTRITION INSTRUCTION; DOWNLOADABLE ELECTRONIC PUBLICATION, NAMELY NEWSLETTERS FEATURING ARTICLES AND INFORMATION ABOUT NUTRITION, CAREER, FAMILY, PHYSICAL FITNESS, HEALTH AND WELLNESS (U.S. CLS. 21, 23, 26, 36 AND 38).

CLASS 16—PAPER GOODS AND PRINTED MATTER

FOR PUBLICATIONS, NAMELY, PAMPHLETS, BROCHURES, BOOKS AND NEWSLETTERS FEATURING ARTICLES AND INFORMATION ABOUT NUTRITION, CAREER, FAMILY, PHYSICAL FITNESS, HEALTH AND WELLNESS (U.S. CLS. 2, 5, 22, 23, 29, 37, 38 AND 50).

CLASS 25—CLOTHING

FOR CLOTHING, NAMELY, T-SHIRTS, CAPS, SWEAT SHIRTS AND TROUSERS (U.S. CLS. 22 AND 39).

CLASS 41—EDUCATION AND ENTERTAINMENT

FOR PHYSICAL FITNESS INSTRUCTION, NAMELY, ENDURANCE AND AEROBIC TRAINING FOR ELITE AND RECREATIONAL ATHLETES; PHYSICAL FITNESS CONSULTATION IN THE FIELD OF ENDURANCE AND AEROBIC TRAINING FOR ELITE AND RECREATIONAL ATHLETES (U.S. CLS. 100, 101 AND 107).

CLASS 44—MEDICAL, BEAUTY AND AGRICULTURAL SERVICES

FOR NUTRITION CONSULTATION IN THE FIELD OF ENDURANCE AND AEROBIC TRAINING FOR ELITE AND RECREATIONAL ATHLETES (U.S. CLS. 100 AND 101).

CHRIS WELLS, EXAMINING ATTORNEY

SN 76-668,014. CARMICHAEL TRAINING SYSTEMS, INC., COLORADO SPRINGS, CO. FILED 10-25-2006.

**CLASS 9—ELECTRICAL AND SCIENTIFIC APPARATUS**

FOR ELECTRONIC GOODS, NAMELY, VIDEO CASSETTES, DIGITAL VIDEO DISCS AND CD'S FEATURING ENDURANCE AND AEROBIC TRAINING, PHYSICAL FITNESS AND NUTRITION INSTRUCTION; DOWNLOADABLE ELECTRONIC PUBLICATION, NAMELY NEWSLETTERS FEATURING ARTICLES AND INFORMATION ABOUT NUTRITION, CAREER, FAMILY, PHYSICAL FITNESS, HEALTH AND WELLNESS (U.S. CLS. 21, 23, 26, 36 AND 38).

CLASS 16—PAPER GOODS AND PRINTED MATTER

FOR PUBLICATIONS, NAMELY, PAMPHLETS, BROCHURES, BOOKS AND NEWSLETTERS FEATURING ARTICLES AND INFORMATION ABOUT NUTRITION, CAREER, FAMILY, PHYSICAL FITNESS, HEALTH AND WELLNESS (U.S. CLS. 2, 5, 22, 23, 29, 37, 38 AND 50).

CLASS 25—CLOTHING

FOR CLOTHING, NAMELY, T-SHIRTS, CAPS, SWEAT SHIRTS AND TROUSERS (U.S. CLS. 22 AND 39).

CLASS 41—EDUCATION AND ENTERTAINMENT

FOR PHYSICAL FITNESS INSTRUCTION, NAMELY, ENDURANCE AND AEROBIC TRAINING FOR ELITE AND RECREATIONAL ATHLETES; PHYSICAL FITNESS CONSULTATION IN THE FIELD OF ENDURANCE AND AEROBIC TRAINING FOR ELITE AND RECREATIONAL ATHLETES (U.S. CLS. 100, 101 AND 107).

CLASS 44—MEDICAL, BEAUTY AND AGRICULTURAL SERVICES

FOR NUTRITION CONSULTATION IN THE FIELD OF ENDURANCE AND AEROBIC TRAINING FOR ELITE AND RECREATIONAL ATHLETES (U.S. CLS. 100 AND 101).

CHRIS WELLS, EXAMINING ATTORNEY

SN 76-668,636. MAXYIELD COOPERATIVE, WEST BEND, IA. FILED 11-7-2006.

NO CLAIM IS MADE TO THE EXCLUSIVE RIGHT TO USE "COOPERATIVE", APART FROM THE MARK AS SHOWN.

CLASS 35—ADVERTISING AND BUSINESS

FOR ADVICE CONCERNING AND PROVISION OF GRAIN MARKETING SERVICES (U.S. CLS. 100, 101 AND 102).

FIRST USE 6-1-2004; IN COMMERCE 6-1-2004.

CLASS 42—SCIENTIFIC AND COMPUTER SERVICES

FOR CROP MANAGEMENT CONSULTING SERVICES, NAMELY, FIELD MAPPING; TESTING, INSPECTION OR RESEARCH ON AGRICULTURE, NAMELY, CROP SCOUTING, SOIL SAMPLING AND SITE SPECIFIC SOIL FERTILITY RECOMMENDATIONS, AND ANALYSIS OF CROP YIELD RESULTS; MAPPING, NAMELY, YIELD MAP GENERATION AND INTERPRETATION (U.S. CLS. 100 AND 101).

FIRST USE 6-1-2004; IN COMMERCE 6-1-2004.
NANCY CLARKE, EXAMINING ATTORNEY

SN 76-670,253. SPOILED PINK, LLC, FORT WORTH, TX.
FILED 12-12-2006.

FRANKIE AIMES

THE MARK CONSISTS OF STANDARD CHARACTERS WITHOUT CLAIM TO ANY PARTICULAR FONT, STYLE, SIZE, OR COLOR.

THE NAME "FRANKIE AIMES" IN THE MARK DOES NOT IDENTIFY A PARTICULAR LIVING INDIVIDUAL.

CLASS 18—LEATHER GOODS

FOR PURSES AND BAGS, NAMELY LEATHER PURSES, MULTI-PURPOSE PURSES, CLUTCH PURSES, ALL PURPOSE CARRYING BAGS, CARRY-ALL BAGS, CARRY-ON BAGS, TOTE BAGS, COSMETIC BAGS SOLD EMPTY, DUFFEL BAGS, AND BEACH BAGS (U.S. CLS. 1, 2, 3, 22 AND 41).

CLASS 25—CLOTHING

FOR CLOTHING, NAMELY SHIRTS, TOPS, T-SHIRTS, PANTS, SLACKS, SHORTS, TIES, BELTS, SWEATERS, JACKETS, COATS, HATS, HEADGEAR, NAMELY, HATS AND CAPS, SHOULDER WRAPS, AND SCARVES (U.S. CLS. 22 AND 39).

CLASS 35—ADVERTISING AND BUSINESS

FOR ONLINE RETAIL STORE SERVICES FEATURING CLOTHING, APPAREL, BAGS, PURSES, JEWELRY AND FASHION ACCESSORIES; RETAIL APPAREL STORES; RETAIL CLOTHING BOUTIQUES; RETAIL CLOTHING STORES; RETAIL STORE SERVICES FEATURING CLOTHING, APPAREL, BAGS, PURSES, JEWELRY AND FASHION ACCESSORIES (U.S. CLS. 100, 101 AND 102).

ELLEN PERKINS, EXAMINING ATTORNEY

SN 76-670,571. ALAMO GROUP INC., SEGUIN, TX. FILED
12-20-2006.

HERSCHEL

THE MARK CONSISTS OF STANDARD CHARACTERS WITHOUT CLAIM TO ANY PARTICULAR FONT, STYLE, SIZE, OR COLOR.

CLASS 7—MACHINERY

FOR TRACTOR-TOWED AGRICULTURAL TILLAGE TOOLS FOR CULTIVATORS, DISC HARROWS, SUBSOILERS, AND PLOWS; AGRICULTURAL MACHINERY PARTS FOR COMBINES, HAY BALERS, SWATHERS, FORAGE CUTTING MACHINES, ROTARY, FLAIL, AND DISC MOWERS AND CONDITIONERS; AND TRACTOR EXHAUST PARTS, NAMELY, MANIFOLDS, PIPES AND MUFFLERS (U.S. CLS. 13, 19, 21, 23, 31, 34 AND 35).

FIRST USE 8-0-2005; IN COMMERCE 8-0-2005.

CLASS 12—VEHICLES

FOR TRACTOR PARTS, NAMELY, INTERNAL ENGINES, DRIVE TRAINS, STEERING PARTS, SEATS (U.S. CLS. 19, 21, 23, 31, 35 AND 44).

FIRST USE 8-0-2005; IN COMMERCE 8-0-2005.

KIMBERLY PERRY, EXAMINING ATTORNEY

SN 76-671,837. IC GROUP LP, MISSISSAUGA, ON L5L 4M1,
CANADA, FILED 1-25-2007.

IC GROUP

THE MARK CONSISTS OF STANDARD CHARACTERS WITHOUT CLAIM TO ANY PARTICULAR FONT, STYLE, SIZE, OR COLOR.

OWNER OF U.S. REG. NO. 2,731,130.

NO CLAIM IS MADE TO THE EXCLUSIVE RIGHT TO USE "GROUP", APART FROM THE MARK AS SHOWN.

CLASS 35—ADVERTISING AND BUSINESS

FOR PROMOTING THE SALE OF GOODS AND SERVICES OF OTHERS THROUGH THE DEVELOPMENT, ADMINISTRATION, HOSTING AND EXECUTION OF GAMES OF CHANCE, PROMOTIONAL CONTESTS AND PROMOTIONAL OFFERS; PRODUCT, PRIZE AND PROMOTIONS FULFILLMENT SERVICES FOR OTHERS (U.S. CLS. 100, 101 AND 102).

FIRST USE 1-0-2005; IN COMMERCE 1-0-2005.

CLASS 36—INSURANCE AND FINANCIAL

FOR INSURANCE UNDERWRITING IN THE FIELD OF CONTINGENCY INSURANCE (U.S. CLS. 100, 101 AND 102).

FIRST USE 1-0-2005; IN COMMERCE 1-0-2005.

CHARLES L. JENKINS, EXAMINING ATTORNEY

SN 76-673,797. HAWLEY, M'LISS RAE, FREELAND, WA.
FILED 3-8-2007.

M'LISS

THE MARK CONSISTS OF STANDARD CHARACTERS WITHOUT CLAIM TO ANY PARTICULAR FONT, STYLE, SIZE, OR COLOR.

OWNER OF U.S. REG. NO. 3,091,168.

CLASS 16—PAPER GOODS AND PRINTED MATTER

FOR PRINTED PUBLICATIONS, NAMELY, BOOKS IN THE FIELD OF QUILTING AND EMBROIDERY, PATTERNS FOR MAKING QUILTS, AND EMBROIDERY DESIGN PATTERNS (U.S. CLS. 2, 5, 22, 23, 29, 37, 38 AND 50).

FIRST USE 9-1-1998; IN COMMERCE 9-1-1998.

CLASS 24—FABRICS

FOR FABRICS OF COTTON, SATIN, RAYON, SILK, WOOL, LINEN, AND POLYESTER (U.S. CLS. 42 AND 50).

CLASS 41—EDUCATION AND ENTERTAINMENT

FOR EDUCATIONAL SERVICES, NAMELY, CLASSES AND SEMINARS IN QUILTING, SEWING AND QUILT DESIGN, AND ENTERTAINMENT SERVICES, NAMELY, ONGOING TELEVISION PROGRAMS IN THE FIELD OF QUILTING (U.S. CLS. 100, 101 AND 107).
FIRST USE 12-31-1991; IN COMMERCE 12-31-1998.
STEVEN PEREZ, EXAMINING ATTORNEY

SN 76-673,826. BLUFIN S.P.A., CARPI, ITALY, FILED 3-8-2007.

BLUMARINE

THE MARK CONSISTS OF STANDARD CHARACTERS WITHOUT CLAIM TO ANY PARTICULAR FONT, STYLE, SIZE, OR COLOR.

OWNER OF U.S. REG. NO. 1,612,676.

CLASS 14—JEWELRY

FOR PRECIOUS METALS AND THEIR ALLOYS AND GOODS IN PRECIOUS METALS OR COATED THEREWITH, NOT INCLUDED IN OTHER CLASSES, NAMELY, KEY CHAINS, NECKLACES, BRACELETS, EARRINGS; JEWELRY; PRECIOUS STONES; CHEAP JEWELRY AND TRINKETS, NAMELY, RINGS, NECKLACES, BRACELETS, BROOCHES, EARRINGS; WATCHES, STRAPS FOR WATCHES, CASES FOR WATCHES, POCKET WATCHES, WRIST-WATCHES, CLOCKS, CHRONOGRAPHS FOR USE AS WATCHES AND TIME PIECES; HOROLOGICAL AND CHRONOMETRIC INSTRUMENTS (U.S. CLS. 2, 27, 28 AND 50).

CLASS 21—HOUSEWARES AND GLASS

FOR HOUSEHOLD AND KITCHEN UTENSILS, NAMELY, SPATULAS, GRATERS, SIEVES, AND HOUSEHOLD AND KITCHEN CONTAINERS; BEVERAGE GLASSWARE, CRYSTAL-STEMWARE, PORCELAIN AND EARTHENWARE, NAMELY, MUGS, PLATES, CUPS AND BOWLS; DISHES AND PLATES, DRINKING GLASSES AND CHALICES, VASES, COFFEE-CUPS, TEA-CUPS, BREAKFAST-CUPS, MUGS; BREAD BOXES, FRAMES FOR DRYING AND MAINTAINING THE SHAPE OF A CLOTHING ITEM, CANDLESTICK HOLDERS, TRAYS, ICE-BUCKETS, THERMAL INSULATED CONTAINERS FOR FOOD OR BEVERAGE, FRUIT-DISHES AND FRUIT-BOWLS, JUGS AND BOTTLES SOLD EMPTY, GOBLETS AND GOBLETS FOR FRUIT-SALADS, SERVIETTE-RINGS, OIL CRUET STANDS, CHAMPAGNE-BUCKETS, SAUCEBOATS, STANDS FOR GLASSES, BOTTLE-STANDS, KNIFE-BLOCKS, CHEESE-DISHES, CAVIAR-DISHES, BUTTER-DISHES ALL OF THESE IN GLASS, CRYSTAL, PORCELAIN OR EARTHENWARE; TABLEWARE, NAMELY, FORKS, KNIVES AND SPOONS AND SERVING FORKS, KNIVES AND SPOONS (U.S. CLS. 2, 13, 23, 29, 30, 33, 40 AND 50).

CLASS 24—FABRICS

FOR TEXTILES AND TEXTILE GOODS, NOT INCLUDED IN OTHER CLASSES, NAMELY, BED SPREADS, BED COVERS AND BED LINEN; TABLE LINEN; BATH TOWELS, BATH SHEETS AND BATH LINEN; HOUSE LINEN (U.S. CLS. 42 AND 50).

CLASS 26—FANCY GOODS

FOR LACE AND EMBROIDERY, RIBBONS AND BRAID; BUTTONS FOR CLOTHING; HOOKS AND EYES; SEWING PINS AND NEEDLES; ARTIFICIAL FLOWERS; HAIR ORNAMENTS; ACCESSORIES AND ORNAMENTS FOR HAIR, NAMELY, HAIR BANDS, BARRETTES, COMBS (U.S. CLS. 37, 39, 40, 42 AND 50).
DEIRDRE ROBERTSON, EXAMINING ATTORNEY

SN 76-673,876. BLUFIN S.P.A., CARPI, ITALY, FILED 3-9-2007.

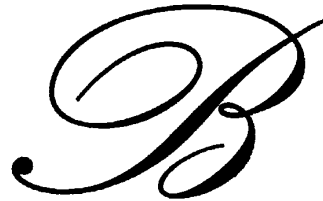
**CLASS 18—LEATHER GOODS**

FOR ALL PURPOSE SPORT BAGS; HANDBAGS; SUITCASES; BACKPACKS; WALLETS; PURSES; BRIEFCASES; DOCUMENT HOLDERS MADE OF SKIN, HIDE AND IMITATION LEATHER; MEN'S HANDBAGS; TRUNKS; ANIMAL SKINS AND HIDES; ARTICLES OF SKIN OR HIDE, NAMELY, LEATHER KEY CASES; PARASOLS; BEACH UMBRELLAS; AND WALKING CANES (U.S. CLS. 1, 2, 3, 22 AND 41).

CLASS 25—CLOTHING

FOR CLOTHING FOR MEN, WOMEN AND CHILDREN, NAMELY, DRESSES AND SHORTS, SHIRTS; CHEMISETTES; SKIRTS; LADIES' SUITS; JACKETS; TROUSERS; SHORT TROUSERS; SWEATERS; WOOLEN CLOTHING, NAMELY, COATS; PAJAMAS; STOCKINGS; SLEEVELESS T-SHIRTS; CORSETS; SOCK SUSPENDERS; BRIEFS; BRASSIERES; UNDERWEAR; HATS; SCARVES; NECKTIES; RAINCOATS; OVERCOATS; COATS; BATHING SUITS; SPORTS SUITS; WIND RESISTANT JACKETS; SKI PANTS; BELTS; PELISSES; SASHES FOR WEAR; GLOVES; DRESSING GOWNS; FOOTWEAR IN GENERAL, NAMELY, SLIPPERS, SHOES, SPORTS SHOES, BOOTS AND SANDALS (U.S. CLS. 22 AND 39).

DEIRDRE ROBERTSON, EXAMINING ATTORNEY

SN 76-676,324. EDELBROCK CORPORATION, TORRANCE, CA. FILED 5-2-2007.



OWNER OF U.S. REG. NO. 1,457,065.

CLASS 7—MACHINERY

FOR PARTS FOR LAND VEHICLES, NAMELY, WATER PUMPS AND CARBURETORS; LAND VEHICLE ENGINE PARTS, NAMELY, ELECTRONIC FUEL INJECTION MODULES (U.S. CLS. 13, 19, 21, 23, 31, 34 AND 35).
FIRST USE 3-0-1992; IN COMMERCE 3-0-1992.

CLASS 12—VEHICLES

FOR PARTS FOR LAND VEHICLES, NAMELY, SHOCK ABSORBERS (U.S. CLS. 19, 21, 23, 31, 35 AND 44).

FIRST USE 10-0-1988; IN COMMERCE 10-0-1988.
DAVID MURRAY, EXAMINING ATTORNEY

SN 76-676,635. THE HUTSON COMPANIES, LLC, JACKSONVILLE, FL. FILED 5-10-2007.

SUGARLEAF

THE MARK CONSISTS OF STANDARD CHARACTERS WITHOUT CLAIM TO ANY PARTICULAR FONT, STYLE, SIZE, OR COLOR.

CLASS 35—ADVERTISING AND BUSINESS

FOR REAL ESTATE SERVICES, NAMELY, REAL ESTATE ADVERTISING AND MARKETING OF RESIDENTIAL AND COMMERCIAL PROPERTIES, AND RECREATIONAL AMENITIES; REAL ESTATE MARKETING SERVICES, NAMELY, ONLINE SERVICES FEATURING TOURS AND LISTINGS OF RESIDENTIAL AND COMMERCIAL PROPERTIES; AND REAL ESTATE SALES MANAGEMENT (U.S. CLS. 100, 101 AND 102).

CLASS 36—INSURANCE AND FINANCIAL

FOR REAL ESTATE BROKERAGE AND LISTINGS; LEASING OF REAL ESTATE; REAL ESTATE AGENCIES; AND REAL ESTATE MANAGEMENT SERVICES (U.S. CLS. 100, 101 AND 102).

CLASS 37—CONSTRUCTION AND REPAIR

FOR LAND DEVELOPMENT SERVICES, NAMELY, CONSTRUCTION OF A PLANNED COMMUNITY DEVELOPMENT OF MIXED USE, GATED AND UN-GATED RESIDENTIAL, OFFICE, RETAIL, AND INDUSTRIAL PROPERTIES (U.S. CLS. 100, 103 AND 106).

CLASS 41—EDUCATION AND ENTERTAINMENT

FOR GOLF COURSES; GOLF PRACTICE RANGES; GOLF INSTRUCTION SERVICES; GOLF CADDIE SERVICES; GOLF CLUB SERVICES, NAMELY, PROVIDING FACILITIES FOR GOLF; AND ENTERTAINMENT IN THE NATURE OF GOLF TOURNAMENTS (U.S. CLS. 100, 101 AND 107).

PRISCILLA MILTON, EXAMINING ATTORNEY

SN 76-978,120. BRIGADE ELECTRONICS PLC, LONDON SE18 6BG, UNITED KINGDOM, FILED 9-18-2001.

bbs-tek

OWNER OF ERPN CMNTY TM OFC REG. NO. 002127595, DATED 4-7-2002, EXPIRES 3-13-2011.
COLOR IS NOT CLAIMED AS A FEATURE OF THE MARK.

CLASS 12—VEHICLES

FOR REVERSING ALARMS FOR VEHICLES AND MOBILE PLANT AND MACHINERY (U.S. CLS. 19, 21, 23, 31, 35 AND 44).

CLASS 37—CONSTRUCTION AND REPAIR

FOR REPAIR, MAINTENANCE, FITTING AND INSTALLATION OF REVERSING ALARMS, EMERGENCY SIRENS AND HORNS FOR VEHICLES AND MOBILE PLANT AND MACHINERY (U.S. CLS. 100, 103 AND 106).
MIDGE BUTLER, EXAMINING ATTORNEY

SN 77-000,011. WHITEPAGES.COM, INC., SEATTLE, WA. FILED 9-14-2006.

WHITEPAGE SOMEONE

THE MARK CONSISTS OF STANDARD CHARACTERS WITHOUT CLAIM TO ANY PARTICULAR FONT, STYLE, SIZE, OR COLOR.

NO CLAIM IS MADE TO THE EXCLUSIVE RIGHT TO USE "WHITEPAGE", APART FROM THE MARK AS SHOWN.

CLASS 35—ADVERTISING AND BUSINESS

FOR ON-LINE DIRECTORY INFORMATION SERVICES; ON-LINE TELEPHONE DIRECTORY INFORMATION SERVICES; ON-LINE MOBILE TELEPHONE DIRECTORY INFORMATION SERVICES; ON-LINE ELECTRONIC MAIL ADDRESS DIRECTORY INFORMATION SERVICES; PROVIDING AND RENTAL OF ON-LINE ADVERTISING SPACE (U.S. CLS. 100, 101 AND 102).

CLASS 38—COMMUNICATION

FOR E-MAIL SERVICES; E-MAIL FORWARDING SERVICES (U.S. CLS. 100, 101 AND 104).

CLASS 42—SCIENTIFIC AND COMPUTER SERVICES

FOR PROVIDING TEMPORARY USE OF NON-DOWNLOADABLE COMPUTER SOFTWARE FOR RETRIEVING DIRECTORY DATA CONTAINED IN A DATABASE IN THE FIELDS OF TELEPHONE DIRECTORY ASSISTANCE AND BUSINESS AND PERSONAL CONTACT INFORMATION; PROVIDING TEMPORARY USE OF NON-DOWNLOADABLE COMPUTER SOFTWARE THAT SUPPLIES BUSINESSES AND INDIVIDUALS WITH INFORMATION OBTAINED THROUGH INVESTIGATION OF PUBLIC RECORDS AND PUBLICLY AVAILABLE DATA (U.S. CLS. 100 AND 101).

LESLEY LAMOTHE, EXAMINING ATTORNEY

SN 77-000,217. L'OREAL, PARIS, FRANCE, FILED 9-15-2006.

ENDOLINE

THE MARK CONSISTS OF STANDARD CHARACTERS WITHOUT CLAIM TO ANY PARTICULAR FONT, STYLE, SIZE, OR COLOR.

OWNER OF FRANCE REG. NO. 063412123, DATED 2-23-2006, EXPIRES 2-23-2016.

CLASS 1—CHEMICALS

FOR CHEMICAL INGREDIENT FOR COSMETIC PRODUCTS (U.S. CLS. 1, 5, 6, 10, 26 AND 46).

CLASS 3—COSMETICS AND CLEANING PREPARATIONS

FOR PERFUME, TOILET WATER; GELS AND SALTS FOR THE BATH AND SHOWER NOT FOR MEDICAL PURPOSE; TOILET SOAPS, BODY DEODORANTS; COSMETICS, NAMELY, CREAMS, MILKS, LOTIONS, GELS AND POWDERS FOR THE FACE, THE BODY AND THE HANDS; MAKEUP PREPARATIONS; SHAMPOOS; GELS, SPRAYS, MOUSSES AND BALMS FOR HAIR STYLING AND HAIR CARE; HAIR LACQUERS; HAIR COLOURING AND HAIR DECOLORANT PREPARATIONS; PERMANENT WAVING AND CURLING PREPARATIONS; ESSENTIAL OILS FOR PERSONAL USE (U.S. CLS. 1, 4, 6, 50, 51 AND 52).

MELVIN AXILBUND, EXAMINING ATTORNEY

SN 77-000,463. GUERREIRO MULTI JÓIA LTDA., SÃO PAULO/SP, BRAZIL, FILED 9-15-2006.



THE FOREIGN WORDING IN THE MARK TRANSLATES INTO ENGLISH AS "FIGHTER" OR "WARRIOR".

CLASS 14—JEWELRY

FOR JEWELRY, NAMELY, RINGS, EARRINGS, BRACELETS, BANGLES, NECKLACES, AMULETS, CHARMS, ANTIQUE JEWELRY, BROOCHES, KEY RINGS OF PRECIOUS METAL; CLOCKS, CASES FOR CLOCKS, ALARM CLOCKS, WATCH BOXES OF PRECIOUS METAL AND IMITATION OF PRECIOUS STONES (U.S. CLS. 2, 27, 28 AND 50).

CLASS 18—LEATHER GOODS

FOR LEATHER AND IMITATIONS OF LEATHER, NAMELY, POCKET WALLETS AND BAGS; UMBRELLAS (U.S. CLS. 1, 2, 3, 22 AND 41).

CLASS 35—ADVERTISING AND BUSINESS

FOR RETAIL STORE SERVICES FEATURING JEWELRY, NAMELY, RINGS, EARRINGS, BRACELETS, BANGLES, NECKLACES, AMULETS, CHARMS, ANTIQUE JEWELRY, BROOCHES, KEY RINGS; CLOCKS, CLOCKS CASES, ALARM CLOCKS, WATCH BOXES OF PRECIOUS METAL AND IMITATION OF PRECIOUS STONES; LEATHER AND IMITATIONS OF LEATHER, NAMELY, POCKET WALLETS AND BAGS; UMBRELLAS (U.S. CLS. 100, 101 AND 102).

ESTHER A. BORSUK, EXAMINING ATTORNEY

SN 77-000,901. PENINSULA INTERNATIONAL (USA) LIMITED, WILMINTGON, DE. FILED 9-15-2006.



OWNER OF U.S. REG. NOS. 1,320,035, 2,976,948 AND OTHERS.

CLASS 3—COSMETICS AND CLEANING PREPARATIONS

FOR AROMATIC ESSENTIAL OILS FOR PERSONAL USE; TOILET SOAP; DEODORANT SOAP; EAU DE COLOGNE; ESSENTIAL OILS; LAVENDER OIL; BODY, SKIN, FACE AND HAND LOTIONS FOR COSMETIC PURPOSES; PERFUMES; POTPOURRI; COSMETIC SOAP; NON-MEDICATED TOILETRIES; SHAMPOOS; ALMOND MILK FOR COSMETIC PURPOSES; ALMOND BODY OIL FOR COSMETIC PURPOSES; ALMOND SOAPS FOR BODY CARE; PERFUMES AMBER IN COLOR; BATH SALTS, NOT FOR MEDICAL PURPOSES; NON-MEDICATED COSMETIC BATH PREPARATIONS; BERGAMOT OILS; ESSENTIAL OILS OF CEDAR WOOD FOR PERSONAL USE; ESSENTIAL OILS OF CITRON FOR PERSONAL USE; MAKE-UP KITS COMPRISING COSMETICS; PERFUMES COMPRISING FLOWER EXTRACTS; INCENSE; JASMINE BODY AND BATH OILS; ESSENTIAL OIL OF LEMON FOR PERSONAL USE; ESSENTIAL OILS FEATURING MINT ESSENCES FOR PERSONAL USE; PERFUMES FEATURING MINT; COSMETIC OILS; BATH OILS FOR COSMETIC PURPOSES; PERFUME OILS; PERFUMERY; ROSE OIL FOR COSMETIC PURPOSES; SCENTED LINEN WATER; COSMETIC CREAMS FOR SKIN CARE; COSMETIC PREPARATIONS IN THE FORMS OF AEROSOLS FOR SKIN CARE; TOILET WATER (U.S. CLS. 1, 4, 6, 50, 51 AND 52).

CLASS 4—LUBRICANTS AND FUELS

FOR INDUSTRIAL OILS, NAMELY, MOISTENING OILS FOR INDUSTRIAL USE; BEESWAX FOR USE IN THE MANUFACTURE OF CANDLES AND COSMETICS; CANDLES, INCLUDING CANDLES FOR CHRISTMAS TREES; LANOLIN FOR USE IN THE MANUFACTURE OF COSMETICS AND OINTMENTS; PARAFFIN; WICKS FOR CANDLES (U.S. CLS. 1, 6 AND 15).

ZHALEH DELANEY, EXAMINING ATTORNEY

SN 77-001,233. WILDCAT VINEYARDS, LLC, GILROY, CA.
FILED 9-18-2006.

SN 77-001,303. HUMMER WHOLE HEALTH MANAGE-
MENT, INC., CLEVELAND, OH. FILED 9-18-2006.

Sarah's Vineyard

THE MARK CONSISTS OF STANDARD CHARACTERS WITHOUT CLAIM TO ANY PARTICULAR FONT, STYLE, SIZE, OR COLOR.

NO CLAIM IS MADE TO THE EXCLUSIVE RIGHT TO USE "VINEYARD", APART FROM THE MARK AS SHOWN.

CLASS 32—LIGHT BEVERAGES

FOR DE-ALCOHOLIZED WINES; NON-ALCOHOLIZED WINES (U.S. CLS. 45, 46 AND 48).

CLASS 33—WINES AND SPIRITS

FOR APERITIF WINES; APERITIFS WITH A WINE BASE; COOKING WINE; FRUIT WINE; GRAPE WINE; KITS FOR MAKING WINE; NATURAL SPARKLING WINES; PORT WINES; PREPARED WINE COCKTAILS; RED WINE; SPARKLING FRUIT WINE; SPARKLING GRAPE WINE; SPARKLING WINE; STRAWBERRY WINE; SWEET WINES; TABLE WINES; TONIC SWEET GRAPE WINE CONTAINING EXTRACTS FROM GINSENG AND CONCHONA BARK (NINJIN-KINATETSU WINE); WHITE WINE; WINE; WINE COOLERS; WINE PUNCH; WINE PUNCHES (U.S. CLS. 47 AND 49).
FIRST USE 10-1-1978; IN COMMERCE 11-1-1980.

CLASS 35—ADVERTISING AND BUSINESS

FOR LICENSING CONSULTATION IN CONNECTION WITH THE PRODUCTION, BOTTLING, MARKETING AND SALE OF WINE AND WINE RELATED BEVERAGES IN COMPLIANCE WITH EXISTING FEDERAL AND STATE REGULATIONS (U.S. CLS. 100, 101 AND 102).

CLASS 40—MATERIAL TREATMENT

FOR PROVIDING INFORMATION ABOUT WINE-MAKING (U.S. CLS. 100, 103 AND 106).

CLASS 41—EDUCATION AND ENTERTAINMENT

FOR CONDUCTING ENTERTAINMENT EXHIBITIONS IN THE NATURE OF WINE FESTIVALS; ENTERTAINMENT SERVICES, NAMELY WINE AND FOOD TASTINGS; ENTERTAINMENT SERVICES, NAMELY, WINE TASTINGS (U.S. CLS. 100, 101 AND 107).

FIRST USE 10-1-1978; IN COMMERCE 11-1-1980.

CLASS 43—HOTEL AND RESTAURANT SERVICES

FOR PROVIDING INFORMATION ABOUT WINE CHARACTERISTICS; SOMMELIER SERVICES, NAMELY, PROVIDING ADVICE ON WINE AND WINE AND FOOD PAIRING; WINE BARS (U.S. CLS. 100 AND 101).

ESTHER A. BORSUK, EXAMINING ATTORNEY

LIVE WHOLE HEALTH

THE MARK CONSISTS OF STANDARD CHARACTERS WITHOUT CLAIM TO ANY PARTICULAR FONT, STYLE, SIZE, OR COLOR.

OWNER OF U.S. REG. NOS. 3,018,878 AND 3,018,879.
SEC. 2(F) AS TO "WHOLE HEALTH."

CLASS 41—EDUCATION AND ENTERTAINMENT

FOR HEALTH EDUCATION, NAMELY, CONDUCTING CLASSES, SEMINARS, CONFERENCES AND WORKSHOPS, AND DISTRIBUTION OF COURSE MATERIAL IN CONNECTION THEREWITH (U.S. CLS. 100, 101 AND 107).

CLASS 44—MEDICAL, BEAUTY AND AGRICULTURAL SERVICES

FOR PROVIDING HEALTHCARE SERVICES AND PREVENTATIVE HEALTHCARE PROGRAMS, NAMELY, MEDICAL TESTING AND NUTRITIONAL COUNSELING (U.S. CLS. 100 AND 101).

BARBARA BROWN, EXAMINING ATTORNEY

SN 77-001,721. AMERICAN FEDERATION PUERI CANTORES, ORANGE, CA. FILED 9-18-2006.

AMERICAN FEDERATION PUERI CANTORES

THE MARK CONSISTS OF STANDARD CHARACTERS WITHOUT CLAIM TO ANY PARTICULAR FONT, STYLE, SIZE, OR COLOR.

NO CLAIM IS MADE TO THE EXCLUSIVE RIGHT TO USE "AMERICAN FEDERATION", APART FROM THE MARK AS SHOWN.

CLASS 9—ELECTRICAL AND SCIENTIFIC APPARATUS

FOR PRERECORDED VIDEOTAPES, AUDIO CASSETTES, DIGITAL VIDEO DISCS AND COMPACT DISCS FEATURING EDUCATIONAL MATERIALS IN THE FIELDS OF MUSIC, SACRED MUSIC, CHORAL MUSIC, AND RELIGION; PRERECORDED VIDEOTAPES, AUDIO CASSETTES, DIGITAL VIDEO DISCS AND COMPACT DISCS FEATURING MUSIC AND ENTERTAINMENT, NAMELY, CHORAL AND MUSICAL PERFORMANCES (U.S. CLS. 21, 23, 26, 36 AND 38).

CLASS 16—PAPER GOODS AND PRINTED MATTER

FOR PRINTED MATERIALS, NAMELY, WORKBOOKS, MUSIC BOOKS, SONGBOOKS, SHEET MUSIC, CONDUCTORS MUSICAL SCORES, MUSIC ARRANGEMENTS, PRINTED LYRICS SHEETS, AND SOUVENIR PROGRAMS FEATURING MUSIC; NEWSLETTERS AND MAGAZINES FEATURING MUSIC NEWS; PRINTED CURRICULUM MATERIALS AND PRINTED EDUCATIONAL MATERIALS IN THE FIELD OF MUSIC, SACRED MUSIC, CHORAL MUSIC, AND RELIGION; STATIONERY, NAMELY, PORTFOLIOS, FOLDERS, BINDERS, STICKERS, PENS, PENCILS, NOTE PADS, AND PLANNERS (U.S. CLS. 2, 5, 22, 23, 29, 37, 38 AND 50).

CLASS 25—CLOTHING

FOR CLOTHING, NAMELY, SHIRTS, BLOUSES, TOPS, JERSEYS, SWEATERS, T-SHIRTS, VESTS, TANK TOPS, GOLF SHIRTS, JACKETS, POLO SHIRTS, TIES, ASCOTS, PANTS, JEANS, SWEAT PANTS, SHORTS, SKIRTS, JACKETS, PARKAS, WIND RESISTANT JACKETS, RAINCOATS, CAPES, SLICKERS, OVERALLS, SCARVES, MUFFLERS, HATS, CAPS, BELTS, GLOVES; FOOTWEAR, NAMELY, HOSIERY, SOCKS, STOCKINGS; HEADWEAR, NAMELY, HATS, BILLED CAPS, SKI CAPS, VISORS (U.S. CLS. 22 AND 39).

CLASS 41—EDUCATION AND ENTERTAINMENT

FOR ENTERTAINMENT SERVICES, NAMELY, LIVE PERFORMANCES IN THE NATURE OF CHORAL PERFORMANCES; EDUCATIONAL SERVICES, NAMELY, TRAINING IN THE FIELDS OF MUSIC, SACRED MUSIC, CHORAL SINGING, AND RELIGION (U.S. CLS. 100, 101 AND 107).

DAVID MILLER, EXAMINING ATTORNEY

CLASS 35—ADVERTISING AND BUSINESS

FOR TRANSPORTATION AND STORAGE SERVICES, NAMELY, TRANSPORTATION LOGISTICS SERVICES IN THE NATURE OF ARRANGING THE TRANSPORTATION OF GOODS FOR OTHERS, PLANNING AND SCHEDULING SHIPMENTS FOR USERS OF TRANSPORTATION SERVICES, ARRANGING FOR PICKUP, DELIVERY, STORAGE AND TRANSPORTATION OF DOCUMENTS, PACKAGES, FREIGHT AND PARCELS VIA GROUND, AIR, BOAT, AND RAIL CARRIERS; IMPORT AND EXPORT AGENCIES (U.S. CLS. 100, 101 AND 102).

CLASS 36—INSURANCE AND FINANCIAL

FOR INSURANCE AND CLAIMS SERVICES, NAMELY, INSURANCE AGENCIES, INSURANCE ADMINISTRATION, INSURANCE BROKERAGE, INSURANCE CLAIMS ADMINISTRATION, INSURANCE CLAIMS PROCESSING (U.S. CLS. 100, 101 AND 102).

CLASS 39—TRANSPORTATION AND STORAGE

FOR IMPORT AND EXPORT CARGO HANDLING SERVICES; STORAGE OF DOCUMENTS, PACKAGES, RAW MATERIALS, AND FREIGHT FOR OTHERS; DISTRIBUTION SERVICES, NAMELY, DELIVERY OF DOCUMENTS, PACKAGES, RAW MATERIALS, AND FREIGHT FOR OTHERS; TRANSPORTATION OF GOODS BY AIR, BOAT, RAIL, TRUCK (U.S. CLS. 100 AND 105).

BENJAMIN OKEKE, EXAMINING ATTORNEY

SN 77-002,135. WALL, BRIAN T. WOODBRIDGE, NJ. AND WALL, ELLEN M. WOODBRIDGE, NJ. FILED 9-19-2006.

SN 77-001,972. INTEGRAL TRANSPORT SERVICE, INC., DULLES, VA. FILED 9-19-2006.

ICECAM



NO CLAIM IS MADE TO THE EXCLUSIVE RIGHT TO USE "TRANSPORT SERVICE", APART FROM THE MARK AS SHOWN.

THE COLOR(S) BLUE IS/ARE CLAIMED AS A FEATURE OF THE MARK.

THE MARK CONSISTS OF THE LETTERS ITSSA IN BLUE WITH HORIZONTAL LINES ACROSS A SOLID BLUE CIRCLE ON A WHITE BACKGROUND WITH THE WORDS INTEGRAL TRANSPORT SERVICE BENEATH. THE COLOR WHITE CONSTITUTES BACKGROUND AND IS NOT PART OF THE MARK.

THE MARK CONSISTS OF STANDARD CHARACTERS WITHOUT CLAIM TO ANY PARTICULAR FONT, STYLE, SIZE, OR COLOR.

CLASS 35—ADVERTISING AND BUSINESS

FOR PRODUCTION OF AUDIO-VISUAL PRESENTATIONS FEATURING FOOTAGE TAKEN FROM A CAMERA ATTACHED TO AN ICE RESURFACING MACHINE FOR USE IN ADVERTISING FOR OTHERS; DISSEMINATION OF ADVERTISING MATTER (U.S. CLS. 100, 101 AND 102).

CLASS 41—EDUCATION AND ENTERTAINMENT

FOR PRODUCTION OF LIVE VIDEO FEATURING FOOTAGE TAKEN FROM A CAMERA ATTACHED TO AN ICE RESURFACING MACHINE TO BE USED TO ENTERTAIN PEOPLE ATTENDING OR VIEWING ICE RINK SPORTS (U.S. CLS. 100, 101 AND 107).

BERNICE MIDDLETON, EXAMINING ATTORNEY

SN 77-003,602. STEPAC L.A. LTD., TEFEN, WESTERN GALILEE, ISRAEL, FILED 9-20-2006.

SN 77-003,903. DATABLEUE FORTRESS PTY LTD., BRISBANE, AUSTRALIA, FILED 9-21-2006.

BODYGUARD

THE MARK CONSISTS OF STANDARD CHARACTERS WITHOUT CLAIM TO ANY PARTICULAR FONT, STYLE, SIZE, OR COLOR.

CLASS 9—ELECTRICAL AND SCIENTIFIC APPARATUS

FOR AUTOMATED SYSTEMS COMPRISED PRIMARILY OF COMPUTER SOFTWARE, HARDWARE AND SENSORS FOR MONITORING AND CONTROLLING PARAMETERS PERTINENT TO THE QUALITY OF PERISHABLE ITEMS ON A CONTINUOUS REAL TIME BASIS (U.S. CLS. 21, 23, 26, 36 AND 38).

CLASS 42—SCIENTIFIC AND COMPUTER SERVICES

FOR QUALITY CONTROL SERVICES FOR OTHERS IN THE FIELD OF FRESH FOOD (U.S. CLS. 100 AND 101).

JOHN WILKE, EXAMINING ATTORNEY

SN 77-003,652. THE UNIVERSITY OF TULSA, TULSA, OK. FILED 9-20-2006.

TULSA UNIVERSITY

THE MARK CONSISTS OF STANDARD CHARACTERS WITHOUT CLAIM TO ANY PARTICULAR FONT, STYLE, SIZE, OR COLOR.

OWNER OF U.S. REG. NOS. 2,075,741, 2,119,208 AND 2,372,294.

NO CLAIM IS MADE TO THE EXCLUSIVE RIGHT TO USE "TULSA", APART FROM THE MARK AS SHOWN.

CLASS 14—JEWELRY

FOR JEWELRY; WATCHES; ALARM CLOCKS; ITEMS MADE OF PRECIOUS METALS, NAMELY, ASHTRAYS, TANKARDS AND TROPHIES (U.S. CLS. 2, 27, 28 AND 50).

CLASS 21—HOUSEWARES AND GLASS

FOR MUGS, PORTABLE BEVERAGE COOLERS, INSULATED SLEEVE HOLDERS FOR BEVERAGES, AND COASTERS NOT OF LINEN OR PAPER (U.S. CLS. 2, 13, 23, 29, 30, 33, 40 AND 50).

CLASS 25—CLOTHING

FOR CLOTHING, NAMELY, T-SHIRTS, SHORTS, JACKETS, SOCKS, BELTS, SCARVES, GLOVES, SWEATERS, SWEATSHIRTS, TIES, RAINWEAR, PANTS, FOOTWEAR, JERSEYS, AND HEADWEAR (U.S. CLS. 22 AND 39).

DAVID I, EXAMINING ATTORNEY

DATABLUE

THE MARK CONSISTS OF STANDARD CHARACTERS WITHOUT CLAIM TO ANY PARTICULAR FONT, STYLE, SIZE, OR COLOR.

PRIORITY CLAIMED UNDER SEC. 44(D) ON AUSTRALIA APPLICATION NO. 1105505, FILED 3-27-2006, REG. NO. 1105505, DATED 1-19-2007, EXPIRES 3-27-2016.

CLASS 9—ELECTRICAL AND SCIENTIFIC APPARATUS

FOR COMPUTERS; COMPUTER HARDWARE; COMPUTER SOFTWARE FOR DATA MANAGEMENT, DATA CAPTURE, DATA ENTRY, RAPID DATA ENTRY, PREDICTIVE DATA ENTRY, DATA PARSING, DATA QUALITY, DATA SEARCHING, DATA UPDATING, DATA CORRECTION, GEOCODING, ADDRESS MANAGEMENT, ADDRESS VALIDATION, ADDRESS STANDARDIZATION, DOCUMENT MANAGEMENT, PRINT MANAGEMENT, BARCODING, OPTICAL MARK RECOGNITION, MAILING AND/OR DOCUMENT DELIVERY; COMPUTER PROGRAMS FOR DATA MANAGEMENT, DATA CAPTURE, DATA ENTRY, RAPID DATA ENTRY, PREDICTIVE DATA ENTRY, DATA PARSING, DATA QUALITY, DATA SEARCHING, DATA UPDATING, DATA CORRECTION, GEOCODING, ADDRESS MANAGEMENT, ADDRESS VALIDATION, ADDRESS STANDARDIZATION, DOCUMENT MANAGEMENT, PRINT MANAGEMENT, BARCODING, OPTICAL MARK RECOGNITION, MAILING AND/OR DOCUMENT DELIVERY; BARCODE READERS; DATA RECORDED IN ELECTRONIC, OPTICAL OR MAGNETIC FORM, NAMELY, BUSINESS INFORMATION, ADDRESS INFORMATION, MARKET INFORMATION AND LIFESTYLE INFORMATION, ALL BEING RECORDED ON COMPACT DISCS, CD-ROM DISCS, DIGITAL VERSATILE DISCS, DIGITAL VIDEO DISCS, LASER VIDEO DISCS, FLOPPY DISCS, MAGNETIC DATA CARRIERS OR OPTICAL DATA CARRIERS; BLANK MAGNETIC DATA CARRIERS AND BLANK OPTICAL DATA CARRIERS (U.S. CLS. 21, 23, 26, 36 AND 38).

CLASS 35—ADVERTISING AND BUSINESS

FOR RETAIL STORES, WHOLESALE STORES AND DISTRIBUTORSHIP FEATURING PRODUCTS FOR USE IN DIRECT MAIL MARKETING, DATA MANAGEMENT, DATA QUALITY, ADDRESS MANAGEMENT, DOCUMENT MANAGEMENT, PRINT MANAGEMENT, BARCODING, OPTICAL MARK RECOGNITION, MAILING AND DOCUMENT DELIVERY; ADVERTISING AND MARKETING SERVICES, NAMELY, DIRECT MAIL ADVERTISING; BUSINESS AUDITING IN THE AREAS OF EFFICIENCY, KNOWLEDGE MANAGEMENT PROCESSES AND/OR BUSINESS PROCESSES; BUSINESS CONSULTANCY SERVICES; PROVISION OF BUSINESS INFORMATION; BUSINESS MANAGEMENT AND ADMINISTRATION SERVICES SUPPORTING UTILIZATION OF A GLOBAL COMPUTER NETWORK; BUSINESS MANAGEMENT OF TELEPHONE CALL CENTRES; OPERATION OF TELEPHONE CALL CENTRES, NAMELY, PROVIDING BUSINESS INFORMATION TO CALLERS; COMPILATION OF INFORMATION INTO COMPUTER DATABASES; DATA CAPTURE, NAMELY, DATA ENTRY SERVICES; DATA PROCESSING; BUSINESS RESEARCH SERVICES, NAMELY, PROVIDING DATA SEARCHES IN COMPUTER FILES FOR OTHERS; COMPUTERIZED DATABASE MANAGEMENT, NAMELY, DATA VERIFICATION; DISSEMINATION OF ADVERTISING MATTER; DOCUMENT REPRODUCTION; EFFICIENCY EXPERTS; COMPUTERIZED FILE MANAGEMENT; COMPILING AND PROVIDING STATISTICAL INFORMATION; TYPING; WORD PROCESSING; PROMOTION OF COMPU-

TER NETWORKS OF OTHERS VIA THE INTERNET; PROVISION OF BUSINESS INFORMATION IN RELATION TO MARKETING, BUSINESS EFFICIENCY, BUSINESS PROCESSES, DATA MANAGEMENT, DATA QUALITY, ADDRESS MANAGEMENT, DOCUMENT MANAGEMENT, PRINT MANAGEMENT, BARCODING, OPTICAL MARK RECOGNITION, MAILING, DOCUMENT DELIVERY, DATA ENTRY; PROVISION OF BUSINESS SERVICES VIA A GLOBAL COMPUTER NETWORK, NAMELY, BUSINESS ADVISORY AND BUSINESS CONSULTANCY SERVICES IN RESPECT OF ADVERTISING, DIRECT MAIL ADVERTISING, KNOWLEDGE MANAGEMENT, BUSINESS EFFICIENCY, BUSINESS PROCESSES, BUSINESS RESEARCH, DATABASE MANAGEMENT, DATA MANAGEMENT, DATA QUALITY, ADDRESS MANAGEMENT, DOCUMENT MANAGEMENT, PRINT MANAGEMENT, BARCODING, OPTICAL MARK RECOGNITION, MAILING AND DOCUMENT DELIVERY (U.S. CLS. 100, 101 AND 102).

CLASS 42—SCIENTIFIC AND COMPUTER SERVICES

FOR ACCREDITATION SERVICES, NAMELY, DEVELOPING, EVALUATING AND TESTING STANDARDS FOR DIRECT MAIL ADVERTISING, KNOWLEDGE MANAGEMENT, BUSINESS EFFICIENCY, BUSINESS PROCESSES, DATABASE MANAGEMENT, DATA MANAGEMENT, DATA QUALITY, ADDRESS MANAGEMENT, DOCUMENT MANAGEMENT, PRINT MANAGEMENT, BARCODING, OPTICAL MARK RECOGNITION, MAILING, DOCUMENT DELIVERY AND COMPUTER PROGRAMMING FOR THE PURPOSE OF QUALITY AND/OR STANDARD ACCREDITATION; COMPUTER CONSULTANCY SERVICES; COMPUTER PROGRAMMING; COMPUTER PROGRAMMING CONSULTANCY; COMPUTER AND COMPUTER SOFTWARE RENTAL; COMPUTER SOFTWARE DESIGN AND DEVELOPMENT; TECHNICAL SUPPORT SERVICES, NAMELY, TROUBLESHOOTING OF COMPUTER HARDWARE, SOFTWARE AND PERIPHERALS, AND PROVIDING ADVICE AND INFORMATION IN RELATION THERETO; COMPUTER SYSTEM DESIGN; COMPUTER SYSTEMS ANALYSIS; CONSULTANCY IN THE FIELD OF COMPUTER HARDWARE; DATA CONVERSION OF COMPUTER PROGRAMS AND DATA; DESIGN AND DEVELOPMENT OF COMPUTER HARDWARE AND SOFTWARE FOR OTHERS; HOSTING COMPUTER WEBSITES; INFORMATION TECHNOLOGY (IT) SERVICES, NAMELY, INFORMATION TECHNOLOGY CONSULTATION; INSTALLATION OF COMPUTER SOFTWARE; MAINTENANCE AND UPDATING OF COMPUTER SOFTWARE; QUALITY CONTROL SERVICES FOR OTHERS; PRODUCT RESEARCH AND DEVELOPMENT FOR OTHERS; WEB PORTAL SERVICES, NAMELY, CREATING, MAINTAINING, DESIGNING AND IMPLEMENTING WEB PORTALS FOR OTHERS; INDUSTRIAL ANALYSIS AND RESEARCH SERVICES; PROVISION OF TECHNOLOGICAL AND COMPUTER-RELATED INFORMATION IN THE AREAS OF DIRECT MAIL ADVERTISING, KNOWLEDGE MANAGEMENT, BUSINESS EFFICIENCY, BUSINESS PROCESSES, DATABASE MANAGEMENT, DATA MANAGEMENT, DATA QUALITY, ADDRESS MANAGEMENT, DOCUMENT MANAGEMENT, PRINT MANAGEMENT, BARCODING, OPTICAL MARK RECOGNITION, MAILING, DOCUMENT DELIVERY AND COMPUTER PROGRAMMING; PROVISION OF TECHNOLOGICAL AND COMPUTER SERVICES VIA A GLOBAL COMPUTER NETWORK, NAMELY, PROVISION OF TECHNICAL INFORMATION AND ADVICE IN THE AREAS OF DIRECT MAIL ADVERTISING, KNOWLEDGE MANAGEMENT, BUSINESS EFFICIENCY, BUSINESS PROCESSES, DATABASE MANAGEMENT, DATA MANAGEMENT, DATA QUALITY, ADDRESS MANAGEMENT, DOCUMENT MANAGEMENT, PRINT MANAGEMENT, BARCODING, OPTICAL MARK RECOGNITION, MAILING, DOCUMENT DELIVERY AND COMPUTER PROGRAMMING; TECHNOLOGY TRANSFER SERVICES, NAMELY, TRANSFERRING DOCUMENT DATA FROM ONE COMPUTER FORMAT TO ANOTHER (U.S. CLS. 100 AND 101).

LINDA ORNDORFF, EXAMINING ATTORNEY

SN 77-004,440. KOBE ALUMINUM AUTOMOTIVE PRODUCTS, LLC, BOWLING GREEN, KY. FILED 9-21-2006.

KOBE ALUMINUM AUTOMOTIVE PRODUCTS, LLC

THE MARK CONSISTS OF STANDARD CHARACTERS WITHOUT CLAIM TO ANY PARTICULAR FONT, STYLE, SIZE, OR COLOR.

NO CLAIM IS MADE TO THE EXCLUSIVE RIGHT TO USE "ALUMINUM AUTOMOTIVE PRODUCTS, LLC", APART FROM THE MARK AS SHOWN.

CLASS 12—VEHICLES

FOR AUTOMOTIVE MOTORIZED VEHICLE SUSPENSION PARTS, NAMELY UPPER AND LOWER SUSPENSION ARMS (U.S. CLS. 19, 21, 23, 31, 35 AND 44).

FIRST USE 3-4-2005; IN COMMERCE 3-4-2005.

CLASS 40—MATERIAL TREATMENT

FOR MANUFACTURING SERVICES FOR OTHERS IN THE FIELD OF AUTOMOTIVE PARTS, NAMELY, MOTORIZED VEHICLE SUSPENSION PARTS (U.S. CLS. 100, 103 AND 106).

FIRST USE 6-6-2006; IN COMMERCE 6-6-2006.

LYDIA BELZER, EXAMINING ATTORNEY

SN 77-004,547. IMPEX CORPORATION, JERSEY CITY, NJ. FILED 9-21-2006.



OWNER OF U.S. REG. NOS. 2,331,663, 3,024,362 AND 3,137,255.

THE COLOR(S) BLUE, YELLOW, AND RED IS/ARE CLAIMED AS A FEATURE OF THE MARK.

THE MARK CONSISTS OF WAVE DESIGN IN BLUE WITH YELLOW STRIPE AND WORDS DAILY DELIGHT IN RED AND THE OVER LAPPING DS IN YELLOW AND RED, RESPECTIVELY.

CLASS 29—MEATS AND PROCESSED FOODS

FOR FROZEN FOODS, NAMELY, FRUIT, SEAFOOD, AND VEGETABLES AND PREPARED SIDE DISHES AND ENTREES CONSISTING PREDOMINANTLY OF SEAFOOD, MEAT AND/OR VEGETABLES (U.S. CL. 46).

FIRST USE 11-2-1998; IN COMMERCE 11-2-1998.

CLASS 30—STAPLE FOODS

FOR FROZEN FOODS, NAMELY, BREAD, CREPES, UNLEAVENED BREAD IN THIN SHEETS, AND PASTA; FROZEN BAKERY DESSERTS; PREPARED SIDE DISHES AND ENTREES CONSISTING PREDOMINANTLY OF RICE AND/OR WHEAT (U.S. CL. 46).

FIRST USE 11-2-1998; IN COMMERCE 11-2-1998.
AISHA SALEM, EXAMINING ATTORNEY

SN 77-006,571. ZUMTOBEL LIGHTING GMBH, DORNBIRN, AUSTRIA, FILED 9-25-2006.

RESCLITE

THE MARK CONSISTS OF STANDARD CHARACTERS WITHOUT CLAIM TO ANY PARTICULAR FONT, STYLE, SIZE, OR COLOR.

PRIORITY CLAIMED UNDER SEC. 44(D) ON AUSTRIA APPLICATION NO. AM37232006, FILED 5-24-2006, REG. NO. 235144, DATED 10-24-2006, EXPIRES 10-31-2016.

CLASS 9—ELECTRICAL AND SCIENTIFIC APPARATUS

FOR DATA PROCESSING EQUIPMENT, NAMELY, DATA PROCESSORS AND COMPUTERS; COMPUTER SOFTWARE PROGRAMS FOR DESIGN AND PLANNING OF INSTALLATIONS FOR SECURITY AND EMERGENCY LIGHTING, AIR CONDITIONING, VENTILATING AND HEATING; REGULATING AND CONTROL DEVICES AND EQUIPMENT FOR SECURITY LIGHTS AND EMERGENCY LIGHTS, NAMELY, ELECTRIC LIGHT DIMMERS AND ELECTRIC LIGHT SWITCHES, AND TOUCH PANELS; LIGHTING BALASTS AND STARTERS FOR GLOW-DISCHARGE LAMPS; ELECTRONIC TRANSFORMERS; CONNECTORS AND PLUG CONNECTORS FOR FIBER OPTIC CABLES; OPTICAL FIBER CABLES OF GLASS OR PLASTIC FIBERS FOR LIGHTING; FILTERS AND BARRIER FILTERS FOR SECURITY LIGHTS AND EMERGENCY LIGHTS; LIGHT OUTLETS FOR SECURITY LIGHTS AND EMERGENCY LIGHTS; LENSES FOR FOCUSING LIGHT, NAMELY ANTI-REFLECTIVE LENSES (U.S. CLS. 21, 23, 26, 36 AND 38).

CLASS 11—ENVIRONMENTAL CONTROL APPARATUS

FOR SECURITY LIGHTS AND EMERGENCY LIGHTS; HOUSINGS FOR SECURITY LIGHTS AND EMERGENCY LIGHTS; SCREENS FOR CONTROLLING LIGHT AND SECURITY LIGHTS AND EMERGENCY LIGHTS; REFLECTORS AND COVERS FOR SECURITY LIGHTS AND EMERGENCY LIGHTS; LAMP SOCKETS FOR ELECTRIC LIGHTS; LAMP HANGING SUPPORTS FOR SECURITY LIGHTS AND EMERGENCY LIGHTS, NAMELY, SUSPENSION PENDANTS FOR LAMPS; VENTILATING INSTALLATIONS, DEVICES AND EQUIPMENT, NAMELY, VENTILATING EXHAUST FANS, VENTILATION FANS FOR SECURITY AND EMERGENCY USE, VENTILATION HOODS FOR STOVES, VENTILATORS FOR COMMERCIAL AND INDUSTRIAL USE; DEVICES FOR DIRECTING AND GUIDING AIR, NAMELY, AIR BLOWERS AND AIR DIRECTING VANES; VENTILATION GRILLS FOR DIRECTING AIR, NAMELY, VENTILATING LOUVERS; ROLLERS FOR DIRECTING AIR, AIR CONDITIONING INSTALLATIONS, DEVICES AND EQUIPMENT, NAMELY, AIR CONDITIONERS, AIR FILTERS FOR AIR CONDITION UNITS AND VALVES FOR AIR CONDITIONERS; HEATING INSTALLATIONS, DEVICES AND EQUIPMENT, NAMELY, ELECTRIC HEATING FANS, ELECTRIC RADIATORS FOR HEATING BUILDINGS AND THERMOSTATIC VALVES, ALL EXCLUDING PORTABLE LAMPS (U.S. CLS. 13, 21, 23, 31 AND 34).

CLASS 42—SCIENTIFIC AND COMPUTER SERVICES

FOR DESIGN AND TECHNICAL PLANNING FOR INSTALLATIONS FOR SECURITY AND EMERGENCY LIGHTING, AIR CONDITIONING, VENTILATION AND HEATING, NAMELY DESIGN OF INSTALLATION SCHEMATICS; COMPUTER PROGRAMMING FOR OTHERS, NAMELY PROGRAMMING OF COMPUTING ROUTINES FOR ELECTRONIC DATA PROCESSING EQUIPMENT (U.S. CLS. 100 AND 101).

JENNIFER DIXON, EXAMINING ATTORNEY

SN 77-007,819. INFINITY HOSPITALITY GROUP, CORONA, CA. FILED 9-26-2006.

ENELLO

THE MARK CONSISTS OF STANDARD CHARACTERS WITHOUT CLAIM TO ANY PARTICULAR FONT, STYLE, SIZE, OR COLOR.

CLASS 3—COSMETICS AND CLEANING PREPARATIONS

FOR SHAMPOO, CONDITIONER, LOTIONS FOR SKIN, MOUTHWASH, BAR SOAPS, TOOTHPASTE, DEODORANT, SHAVING CREAM, ALL PURPOSE COTTON SWABS FOR PERSONAL USE, MAKEUP REMOVER, LAUNDRY DETERGENT, DRYER SHEETS, LAUNDRY BLEACH AND FABRIC SOFTENER (U.S. CLS. 1, 4, 6, 50, 51 AND 52).

CLASS 5—PHARMACEUTICALS

FOR DISINFECTANT BATHROOM CLEANERS (U.S. CLS. 6, 18, 44, 46, 51 AND 52).

CLASS 16—PAPER GOODS AND PRINTED MATTER

FOR TOILET PAPER, PAPER TOWELS, PAPER NAPKINS, FACIAL TISSUE, TOILET SEAT BANDS, TOILET SEAT COVERS MADE OF PAPER, PAPER PLACEMATS, TRASH CAN LINERS, ICE BUCKET LINERS, PENS, PENCILS (U.S. CLS. 2, 5, 22, 23, 29, 37, 38 AND 50).

CLASS 21—HOUSEWARES AND GLASS

FOR PAPER PLATES, PAPER CUPS, PAPER BOWLS, INSULATED HOT DRINK CUPS MADE OF PAPER (U.S. CLS. 2, 13, 23, 29, 30, 33, 40 AND 50).

CLASS 24—FABRICS

FOR BATH TOWELS, WASH CLOTHS, HAND TOWELS, POOL TOWELS, BED SHEETS, PILLOW CASES, BED BLANKETS, MATTRESS PADS, MATTRESS PROTECTORS, PILLOW PROTECTORS, BEDSPREADS, DRAPERY AND SHOWER CURTAINS (U.S. CLS. 42 AND 50).

THEODORE MCBRIDE, EXAMINING ATTORNEY

SN 77-008,221. NEURO VISION TECHNOLOGY PTY LTD,
SEMAPHORE, AUSTRALIA, FILED 9-27-2006.

NVT

THE MARK CONSISTS OF STANDARD CHARACTERS WITHOUT CLAIM TO ANY PARTICULAR FONT, STYLE, SIZE, OR COLOR.

OWNER OF AUSTRALIA REG. NO. 1104704, DATED 3-22-2006, EXPIRES 3-22-2016.

CLASS 9—ELECTRICAL AND SCIENTIFIC APPARATUS

FOR COMPUTER HARDWARE AND COMPUTER SOFTWARE FOR USE IN THE ASSESSMENT OF VISUAL IMPAIRMENT AND VISUAL FIELD TESTING; COMPUTER HARDWARE AND COMPUTER SOFTWARE FOR USE IN THE REHABILITATION OF VISUAL IMPAIRMENT (U.S. CLS. 21, 23, 26, 36 AND 38).

CLASS 41—EDUCATION AND ENTERTAINMENT

FOR MEDICAL TRAINING IN THE FIELD OF VISUAL IMPAIRMENT (U.S. CLS. 100, 101 AND 107).

CLASS 44—MEDICAL, BEAUTY AND AGRICULTURAL SERVICES

FOR MEDICAL EVALUATION AND TESTING SERVICES, NAMELY, ASSESSMENT OF VISUAL IMPAIRMENT AND VISUAL FIELD TESTING; REHABILITATION SERVICES IN THE FIELD OF VISUAL IMPAIRMENT (U.S. CLS. 100 AND 101).

DAVID HOFFMAN, EXAMINING ATTORNEY

SN 77-008,297. PRATCHETT, TERENCE DAVID JOHN,
SALISBURY, UNITED KINGDOM, FILED 9-27-2006.

NAC MAC FEEGLE

THE MARK CONSISTS OF STANDARD CHARACTERS WITHOUT CLAIM TO ANY PARTICULAR FONT, STYLE, SIZE, OR COLOR.

CLASS 9—ELECTRICAL AND SCIENTIFIC APPARATUS

FOR PRE-RECORDED AUDIO RECORDINGS, TAPES AND COMPACT DISCS FEATURING MUSIC AND FICTIONAL COMEDY, DRAMA, ACTION, AND ADVENTURE STORIES; PRE-RECORDED VIDEO CASSETTES, DVDS, AND CD-ROMS FEATURING MOTION PICTURES, TELEVISION PROGRAMS AND THEATRICAL PRODUCTIONS; VIDEO GAME SOFTWARE; COMPUTER GAME SOFTWARE, PROGRAMS AND CARTRIDGES (U.S. CLS. 21, 23, 26, 36 AND 38).

CLASS 16—PAPER GOODS AND PRINTED MATTER

FOR BOOKS FEATURING FICTIONAL COMEDY, DRAMA, ACTION, AND ADVENTURE STORIES; MAGAZINES FEATURING FICTIONAL COMEDY, DRAMA, ACTION, AND ADVENTURE STORIES; WIRE BOUND NOTEBOOKS; GIFT WRAPPING PAPER; GREETING CARDS; STATIONERY; PENS; PENCILS; POSTERS; CALENDARS; STICKERS (U.S. CLS. 2, 5, 22, 23, 29, 37, 38 AND 50).

CLASS 25—CLOTHING

FOR CLOTHING, NAMELY, SHIRTS, JERSEYS, T-SHIRTS, SWEATERS, PULLOVERS, JACKETS, SCARVES, SUSPENDERS, BELTS, GLOVES, SOCKS, FOOTWEAR, COSTUMES, NAMELY, HALLOWEEN COSTUMES, CAPS AND HATS (U.S. CLS. 22 AND 39).

CLASS 28—TOYS AND SPORTING GOODS

FOR GAMES, NAMELY, BOARD GAMES AND CARD GAMES; TOYS, NAMELY, ACTION FIGURES, DOLLS, PUZZLES, STUFFED TOYS, MINIATURE TOY FIGURES (U.S. CLS. 22, 23, 38 AND 50).

CLASS 41—EDUCATION AND ENTERTAINMENT

FOR ENTERTAINMENT SERVICES, NAMELY, PRODUCTION AND DISTRIBUTION OF MOTION PICTURE FILMS, CABLE TELEVISION PROGRAMS AND TELEVISION PROGRAMS, AND RADIO SHOWS; PROVIDING ON-LINE NONDOWNLOADABLE ELECTRONIC PUBLICATIONS IN THE NATURE OF MAGAZINES, NEWSLETTERS, AND BOOKS FEATURING FICTIONAL COMEDY, DRAMA, ACTION, AND ADVENTURE STORIES; ENTERTAINMENT SERVICES, NAMELY, PRODUCTION OF STAGE PLAYS AND PERFORMANCES; ENTERTAINMENT SERVICES, NAMELY, PRODUCTION OF THEATRICAL PRODUCTIONS (U.S. CLS. 100, 101 AND 107).

KENNETH E. SHARPERSON, EXAMINING ATTORNEY

SN 77-008,301. PRATCHETT, TERENCE DAVID JOHN,
SALISBURY, UNITED KINGDOM, FILED 9-27-2006.

WEE FREE MEN

THE MARK CONSISTS OF STANDARD CHARACTERS WITHOUT CLAIM TO ANY PARTICULAR FONT, STYLE, SIZE, OR COLOR.

CLASS 9—ELECTRICAL AND SCIENTIFIC APPARATUS

FOR PRE-RECORDED AUDIO RECORDINGS, TAPES AND COMPACT DISCS FEATURING MUSIC AND FICTIONAL COMEDY, DRAMA, ACTION, AND ADVENTURE STORIES; PRE-RECORDED VIDEO CASSETTES, DVDS, AND CD-ROMS FEATURING MOTION PICTURES, TELEVISION PROGRAMS AND THEATRICAL PRODUCTIONS; VIDEO GAME SOFTWARE; COMPUTER GAME SOFTWARE, PROGRAMS AND CARTRIDGES (U.S. CLS. 21, 23, 26, 36 AND 38).

CLASS 16—PAPER GOODS AND PRINTED MATTER

FOR BOOKS FEATURING FICTIONAL COMEDY, DRAMA, ACTION, AND ADVENTURE STORIES; MAGAZINES FEATURING FICTIONAL COMEDY, DRAMA, ACTION, AND ADVENTURE STORIES; WIRE BOUND NOTEBOOKS; GIFT WRAPPING PAPER; GREETING CARDS; STATIONERY; PENS; PENCILS; POSTERS; CALENDARS; STICKERS (U.S. CLS. 2, 5, 22, 23, 29, 37, 38 AND 50).

CLASS 25—CLOTHING

FOR CLOTHING, NAMELY, SHIRTS, JERSEYS, T-SHIRTS, SWEATERS, PULLOVERS, JACKETS, SCARVES, SUSPENDERS, BELTS, GLOVES, SOCKS, FOOTWEAR; COSTUMES, NAMELY, HALLOWEEN COSTUMES, CAPS AND HATS (U.S. CLS. 22 AND 39).

CLASS 28—TOYS AND SPORTING GOODS

FOR GAMES, NAMELY, BOARD GAMES AND CARD GAMES; TOYS, NAMELY, ACTION FIGURES, DOLLS, PUZZLES, STUFFED TOYS, MINIATURE TOY FIGURES (U.S. CLS. 22, 23, 38 AND 50).

CLASS 41—EDUCATION AND ENTERTAINMENT

FOR ENTERTAINMENT SERVICES, NAMELY, PRODUCTION AND DISTRIBUTION OF MOTION PICTURE FILMS, CABLE TELEVISION PROGRAMS AND TELEVISION PROGRAMS, RADIO SHOWS; PROVIDING ON-LINE NONDOWNLOADABLE ELECTRONIC PUBLICATIONS IN THE NATURE OF MAGAZINES, NEWSLETTERS, AND BOOKS FEATURING FICTIONAL COMEDY, DRAMA, ACTION, AND ADVENTURE STORIES; ENTERTAINMENT SERVICES, NAMELY, PRODUCTION OF STAGE PLAYS AND PERFORMANCES; ENTERTAINMENT SERVICES, NAMELY, PRODUCTION OF THEATRICAL PRODUCTIONS (U.S. CLS. 100, 101 AND 107).

KENNETH E. SHARPERSON, EXAMINING ATTORNEY

CLASS 16—PAPER GOODS AND PRINTED MATTER

FOR BOOKS FEATURING FICTIONAL COMEDY, DRAMA, ACTION, AND ADVENTURE STORIES; MAGAZINES FEATURING FICTIONAL COMEDY, DRAMA, ACTION, AND ADVENTURE STORIES; WIRE BOUND NOTEBOOKS; GIFT WRAPPING PAPER; GREETING CARDS; STATIONERY; PENS; PENCILS; POSTERS; CALENDARS; STICKERS (U.S. CLS. 2, 5, 22, 23, 29, 37, 38 AND 50).

CLASS 25—CLOTHING

FOR CLOTHING, NAMELY, SHIRTS, JERSEYS, T-SHIRTS, SWEATERS, PULLOVERS, JACKETS, SCARVES, SUSPENDERS, BELTS, GLOVES, SOCKS, FOOTWEAR, COSTUMES, NAMELY, HALLOWEEN COSTUMES, CAPS AND HATS (U.S. CLS. 22 AND 39).

CLASS 28—TOYS AND SPORTING GOODS

FOR GAMES, NAMELY, BOARD GAMES AND CARD GAMES; TOYS, NAMELY, ACTION FIGURES, DOLLS, PUZZLES, STUFFED TOYS, MINIATURE TOY FIGURES (U.S. CLS. 22, 23, 38 AND 50).

CLASS 41—EDUCATION AND ENTERTAINMENT

FOR ENTERTAINMENT SERVICES, NAMELY, PRODUCTION AND DISTRIBUTION OF MOTION PICTURE FILMS, CABLE TELEVISION PROGRAMS AND TELEVISION PROGRAMS, RADIO SHOWS; PROVIDING ON-LINE NONDOWNLOADABLE ELECTRONIC PUBLICATIONS IN THE NATURE OF MAGAZINES, NEWSLETTERS, AND BOOKS FEATURING FICTIONAL COMEDY, DRAMA, ACTION, AND ADVENTURE STORIES; ENTERTAINMENT SERVICES, NAMELY, PRODUCTION OF STAGE PLAYS AND PERFORMANCES; ENTERTAINMENT SERVICES, NAMELY, PRODUCTION OF THEATRICAL PRODUCTIONS (U.S. CLS. 100, 101 AND 107).

KENNETH E. SHARPERSON, EXAMINING ATTORNEY

SN 77-008,305. PRATCHETT, TERENCE DAVID JOHN, SALISBURY, UNITED KINGDOM, FILED 9-27-2006.

SN 77-008,311. PRATCHETT, TERENCE DAVID JOHN, SALISBURY, UNITED KINGDOM, FILED 9-27-2006.

DISCWORLD

TERRY PRATCHETT

THE MARK CONSISTS OF STANDARD CHARACTERS WITHOUT CLAIM TO ANY PARTICULAR FONT, STYLE, SIZE, OR COLOR.

THE MARK CONSISTS OF STANDARD CHARACTERS WITHOUT CLAIM TO ANY PARTICULAR FONT, STYLE, SIZE, OR COLOR.

CLASS 9—ELECTRICAL AND SCIENTIFIC APPARATUS

FOR PRE-RECORDED AUDIO RECORDINGS, TAPES AND COMPACT DISCS FEATURING MUSIC AND FICTIONAL COMEDY, DRAMA, ACTION, AND ADVENTURE STORIES; PRE-RECORDED VIDEO CASSETTES, DVDS, AND CD-ROMS FEATURING MOTION PICTURES, TELEVISION PROGRAMS AND THEATRICAL PRODUCTIONS; VIDEO GAME SOFTWARE; COMPUTER GAME SOFTWARE, PROGRAMS AND CARTRIDGES (U.S. CLS. 21, 23, 26, 36 AND 38).

CLASS 9—ELECTRICAL AND SCIENTIFIC APPARATUS

FOR PRE-RECORDED AUDIO RECORDINGS, TAPES AND COMPACT DISCS FEATURING MUSIC AND FICTIONAL COMEDY, DRAMA, ACTION, AND ADVENTURE STORIES; PRE-RECORDED VIDEO CASSETTES, DVDS, AND CD-ROMS FEATURING MOTION PICTURES, TELEVISION PROGRAMS AND THEATRICAL PRODUCTIONS; VIDEO GAME SOFTWARE; COMPUTER GAME SOFTWARE, PROGRAMS AND CARTRIDGES (U.S. CLS. 21, 23, 26, 36 AND 38).

CLASS 16—PAPER GOODS AND PRINTED MATTER

FOR BOOKS FEATURING FICTIONAL COMEDY, DRAMA, ACTION, AND ADVENTURE STORIES; MAGAZINES FEATURING FICTIONAL COMEDY, DRAMA, ACTION, AND ADVENTURE STORIES; WIRE BOUND NOTEBOOKS; GIFT WRAPPING PAPER; GREETING CARDS; STATIONERY; PENS; PENCILS; POSTERS; CALENDARS; STICKERS (U.S. CLS. 2, 5, 22, 23, 29, 37, 38 AND 50).

CLASS 25—CLOTHING

FOR CLOTHING, NAMELY, SHIRTS, JERSEYS, T-SHIRTS, SWEATERS, PULLOVERS, JACKETS, SCARVES, SUSPENDERS, BELTS, GLOVES, SOCKS, FOOTWEAR, COSTUMES, NAMELY, HALLOWEEN COSTUMES, CAPS AND HATS (U.S. CLS. 22 AND 39).

CLASS 28—TOYS AND SPORTING GOODS

FOR GAMES, NAMELY, BOARD GAMES AND CARD GAMES; TOYS, NAMELY, ACTION FIGURES, DOLLS, PUZZLES, STUFFED TOYS, MINIATURE TOY FIGURES (U.S. CLS. 22, 23, 38 AND 50).

CLASS 41—EDUCATION AND ENTERTAINMENT

FOR ENTERTAINMENT SERVICES, NAMELY, PRODUCTION AND DISTRIBUTION OF MOTION PICTURE FILMS, CABLE TELEVISION PROGRAMS AND TELEVISION PROGRAMS, RADIO SHOWS; PROVIDING ONLINE NONDOWNLOADABLE ELECTRONIC PUBLICATIONS IN THE NATURE OF MAGAZINES, NEWSLETTERS, AND BOOKS FEATURING FICTIONAL COMEDY, DRAMA, ACTION, AND ADVENTURE STORIES; ENTERTAINMENT SERVICES, NAMELY, PRODUCTION OF STAGE PLAYS AND PERFORMANCES; ENTERTAINMENT SERVICES, NAMELY, PRODUCTION OF THEATRICAL PRODUCTIONS (U.S. CLS. 100, 101 AND 107).

KENNETH E. SHARPERSON, EXAMINING ATTORNEY

CLASS 35—ADVERTISING AND BUSINESS

FOR ADVERTISING SERVICES, NAMELY, PROMOTING THE GOODS AND SERVICES OF OTHERS IN A WIDE VARIETY OF FIELDS, THROUGH THE DISTRIBUTION OF AUDIO AND AUDIO-VISUAL PROMOTIONAL MATERIALS AND BY RENDERING SALES AND PROMOTION ADVICE; PLACING ADVERTISEMENTS FOR OTHERS; PRODUCTION AND DISTRIBUTION OF RADIO AND TELEVISION COMMERCIALS; PRODUCING AUDIO AND VIDEO INFOMERCIALS; PRODUCT MERCHANDISING; BUSINESS MARKETING CONSULTING SERVICES; PROVIDING INFORMATION TO THE PUBLIC ABOUT THE PRODUCTS AND SERVICES OF OTHERS VIA A COMPUTERIZED RETAIL-BASED ADVERTISEMENT SAMPLING APPARATUS, CONSISTING OF A COMPUTER, COMPUTER OPERATING PROGRAMS, OPTICAL DISKS CONTAINING PRE-RECORDED ADVERTISEMENTS OF OTHERS, TELEVISION MONITOR, ELECTRONIC KEYPAD, AND PRODUCT DISPLAY AREA; PROVIDING INFORMATION TO THE PUBLIC ABOUT THE PRODUCTS AND SERVICES OF OTHERS VIA RETAIL-BASED DELIVERY OF FULL MOTION VIDEO, AUDIO, TEXT AND GRAPHIC IMAGES IN THE FORM OF TELEVISION PROGRAMS, MUSIC VIDEOS, MOVIE PREVIEWS, COMMERCIALS AND INFOMERCIALS; AND PROVIDING INFORMATION TO THE PUBLIC ABOUT THE PRODUCTS AND SERVICES OF OTHERS VIA DISPLAYS ON SINGLE COMPUTERS, LOCAL COMPUTER NETWORKS AND THE ON-LINE GLOBAL COMPUTER NETWORK; MARKETING AND PROMOTION SERVICES; ADVERTISING THROUGH ALL PUBLIC COMMUNICATION MEANS; FORMATTING AND UPDATING ADVERTISING MATERIAL FOR PRESENTATION ON A DIGITAL MEDIUM; PROVISION OF ADVERTISING SPACE BY ELECTRONIC MEANS AND GLOBAL INFORMATION NETWORKS; ADVERTISING AND PUBLICITY SERVICES, NAMELY, PROMOTING THE GOODS, SERVICES, BRAND IDENTITY AND COMMERCIAL INFORMATION AND NEWS OF THIRD PARTIES THROUGH DIGITAL MEDIA; ISSUING AND UPDATING OF ADVERTISING TEXTS; ADVERTISING ON COMPUTER COMMUNICATION NETWORKS; ADVERTISING BY TRANSMISSION OF ONLINE PUBLICITY FOR THIRD PARTIES THROUGH ELECTRONIC COMMUNICATIONS NETWORKS; ARRANGING AND CONDUCTING MARKETING PROMOTIONAL EVENTS FOR OTHERS (U.S. CLS. 100, 101 AND 102).

CLASS 38—COMMUNICATION

FOR TRANSMISSION OF NEWS, SOUND, VIDEO AND INFORMATION; LIVE EVENT BROADCASTING VIA RADIO, TELEVISION AND INTERNET (U.S. CLS. 100, 101 AND 104).

MICHAEL KEATING, EXAMINING ATTORNEY

SN 77-008,691. ONSPOT DIGITAL NETWORK, INDIANAPOLIS, IN. FILED 9-27-2006.

SN 77-009,282. FENNESSY, MICHAEL P., LIVERPOOL, NY. FILED 9-28-2006.

PRIME TIME AT THE RIGHT
TIME.

THE MARK CONSISTS OF STANDARD CHARACTERS WITHOUT CLAIM TO ANY PARTICULAR FONT, STYLE, SIZE, OR COLOR.

LOGOCRETE

THE MARK CONSISTS OF STANDARD CHARACTERS WITHOUT CLAIM TO ANY PARTICULAR FONT, STYLE, SIZE, OR COLOR.

OWNER OF U.S. REG. NO. 2,384,228.

CLASS 7—MACHINERY

FOR CONCRETE BLASTING APPARATUS AND PARTS THEREFOR (U.S. CLS. 13, 19, 21, 23, 31, 34 AND 35).

CLASS 35—ADVERTISING AND BUSINESS

FOR FRANCHISING, NAMELY, OFFERING TECHNICAL ASSISTANCE IN THE ESTABLISHMENT AND/OR OPERATION OF BUSINESSES SPECIALIZING IN THE CUSTOM APPLICATION OF LOGOS, TRADEMARKS, DESIGNS, AND ARTWORK TO SURFACES (U.S. CLS. 100, 101 AND 102).

CLASS 40—MATERIAL TREATMENT

FOR CUSTOM MANUFACTURE OF DECORATIVE WALL AND GROUND SURFACE COVERINGS TO THE ORDER AND SPECIFICATION OF OTHERS; SURFACE FINISHING SERVICES BY ABRASIVE BLASTING; APPLICATION OF LOGOS, TRADEMARKS, DESIGNS, AND ARTWORK TO SURFACES TO THE ORDER OF OTHERS BY MEANS OF ABRASIVE BLASTING (U.S. CLS. 100, 103 AND 106).

DOMINIC J. FERRAIUOLO, EXAMINING ATTORNEY

SN 77-009,325. FENNESSY, MICHAEL P., LIVERPOOL, NY. FILED 9-28-2006.



OWNER OF U.S. REG. NO. 2,384,228.
NO CLAIM IS MADE TO THE EXCLUSIVE RIGHT TO USE "SYSTEMS", APART FROM THE MARK AS SHOWN. THE COLOR(S) BROWN, SILVER AND WHITE IS/ARE CLAIMED AS A FEATURE OF THE MARK.

THE MARK CONSISTS OF THE COLOR BROWN APPEARING IN THE WORDING "SYSTEMS" AND IN THE DESIGN OF TEXTURED ELEMENT IN THE MARK; THE COLOR SILVER APPEARING IN THE DESIGN OF THE SURROUNDING FEATURE OF THE TEXTURED ELEMENT; THE COLOR WHITE APPEARS IN THE WORDING "LOGOCRETE" AND IN THE DESIGN OF THE ARROWS.

CLASS 7—MACHINERY

FOR CONCRETE BLASTING APPARATUS AND PARTS THEREFOR (U.S. CLS. 13, 19, 21, 23, 31, 34 AND 35).

CLASS 35—ADVERTISING AND BUSINESS

FOR FRANCHISING, NAMELY, OFFERING TECHNICAL ASSISTANCE IN THE ESTABLISHMENT AND/OR OPERATION OF BUSINESSES SPECIALIZING IN THE CUSTOM APPLICATION OF LOGOS, TRADEMARKS, DESIGNS, AND ARTWORK TO SURFACES (U.S. CLS. 100, 101 AND 102).

CLASS 40—MATERIAL TREATMENT

FOR CUSTOM MANUFACTURE OF DECORATIVE WALL AND GROUND SURFACE COVERINGS TO THE ORDER AND SPECIFICATION OF OTHERS; SURFACE FINISHING SERVICES BY ABRASIVE BLASTING; APPLICATION OF LOGOS, TRADEMARKS, DESIGNS, AND ARTWORK TO SURFACES TO THE ORDER OF OTHERS BY MEANS OF ABRASIVE BLASTING (U.S. CLS. 100, 103 AND 106).

DOMINIC J. FERRAIUOLO, EXAMINING ATTORNEY

SN 77-009,300. FENNESSY, MICHAEL P., LIVERPOOL, NY. FILED 9-28-2006.

LOGOCRETE SYSTEMS

THE MARK CONSISTS OF STANDARD CHARACTERS WITHOUT CLAIM TO ANY PARTICULAR FONT, STYLE, SIZE, OR COLOR.

OWNER OF U.S. REG. NO. 2,384,228.
NO CLAIM IS MADE TO THE EXCLUSIVE RIGHT TO USE "SYSTEMS", APART FROM THE MARK AS SHOWN.

CLASS 7—MACHINERY

FOR CONCRETE BLASTING APPARATUS AND PARTS THEREFOR (U.S. CLS. 13, 19, 21, 23, 31, 34 AND 35).

CLASS 35—ADVERTISING AND BUSINESS

FOR FRANCHISING, NAMELY, OFFERING TECHNICAL ASSISTANCE IN THE ESTABLISHMENT AND/OR OPERATION OF BUSINESSES SPECIALIZING IN THE CUSTOM APPLICATION OF LOGOS, TRADEMARKS, DESIGNS, AND ARTWORK TO SURFACES (U.S. CLS. 100, 101 AND 102).

CLASS 40—MATERIAL TREATMENT

FOR CUSTOM MANUFACTURE OF DECORATIVE WALL AND GROUND SURFACE COVERINGS TO THE ORDER AND SPECIFICATION OF OTHERS; SURFACE FINISHING SERVICES BY ABRASIVE BLASTING; APPLICATION OF LOGOS, TRADEMARKS, DESIGNS, AND ARTWORK TO SURFACES TO THE ORDER OF OTHERS BY MEANS OF ABRASIVE BLASTING (U.S. CLS. 100, 103 AND 106).

DOMINIC J. FERRAIUOLO, EXAMINING ATTORNEY

SN 77-009,468. BELL, MARC, NEW YORK, NY. FILED 9-28-2006.

MARKY RAMONE

THE MARK CONSISTS OF STANDARD CHARACTERS WITHOUT CLAIM TO ANY PARTICULAR FONT, STYLE, SIZE, OR COLOR.

THE NAME IN THE MARK IDENTIFIES A LIVING INDIVIDUAL WHOSE CONSENT IS OF RECORD.

CLASS 9—ELECTRICAL AND SCIENTIFIC APPARATUS

FOR (BASED ON USE IN COMMERCE) PRE-RECORDED CD'S FEATURING MUSIC (BASED ON INTENT TO USE) PRE-RECORDED DVDS FEATURING MUSIC, LIVE MUSICAL PERFORMANCES, DOCUMENTARIES (U.S. CLS. 21, 23, 26, 36 AND 38).

FIRST USE 0-0-1998; IN COMMERCE 0-0-1998.

CLASS 25—CLOTHING

FOR CLOTHING, NAMELY, T-SHIRTS (U.S. CLS. 22 AND 39).

CLASS 41—EDUCATION AND ENTERTAINMENT

FOR ENTERTAINMENT, NAMELY, LIVE PERFORMANCES BY A MUSICAL BAND (U.S. CLS. 100, 101 AND 107).

FIRST USE 0-0-1998; IN COMMERCE 0-0-1998.
STEVEN R. FINE, EXAMINING ATTORNEY

SN 77-011,476. THE BUCKLE, INC., KEARNEY, NE. FILED 10-2-2006.



THE MARK CONSISTS OF A STYLIZED LETTER B.

CLASS 3—COSMETICS AND CLEANING PREPARATIONS

FOR PERFUMES AND COLOGNES (U.S. CLS. 1, 4, 6, 50, 51 AND 52).

FIRST USE 6-6-2002; IN COMMERCE 6-6-2002.

CLASS 14—JEWELRY

FOR JEWELRY (U.S. CLS. 2, 27, 28 AND 50).

FIRST USE 6-6-2002; IN COMMERCE 6-6-2002.

CLASS 18—LEATHER GOODS

FOR BACKPACKS (U.S. CLS. 1, 2, 3, 22 AND 41).

FIRST USE 6-6-2002; IN COMMERCE 6-6-2002.

CLASS 25—CLOTHING

FOR SWEATERS, SWEATSHIRTS, WOVEN SHIRTS, T-SHIRTS, KNIT SHIRTS, TOPS AND POLO SHIRTS, HATS, SHOES, JACKETS, BLAZERS, VESTS, PULL-OVERS, SLACKS, PANTS, JEANS, SHORTS, SWEAT PANTS, SKIRTS, CULOTTES, DRESSES, SWIMWEAR AND OUTERWEAR, NAMELY, COATS AND PARKAS (U.S. CLS. 22 AND 39).

FIRST USE 6-6-2002; IN COMMERCE 6-6-2002.
BONNIE LUKEN, EXAMINING ATTORNEY

SN 77-010,089. AGITAR SOFTWARE INC., MOUNTAIN VIEW, CA. FILED 9-28-2006.

AGITARONE

THE MARK CONSISTS OF STANDARD CHARACTERS WITHOUT CLAIM TO ANY PARTICULAR FONT, STYLE, SIZE, OR COLOR.

CLASS 9—ELECTRICAL AND SCIENTIFIC APPARATUS

FOR COMPUTER SOFTWARE FOR USE IN TESTING, EVALUATING AND INTEGRATING COMPUTER SOFTWARE AND NETWORKS; COMPUTER SOFTWARE DEVELOPMENT TOOLS (U.S. CLS. 21, 23, 26, 36 AND 38).

CLASS 42—SCIENTIFIC AND COMPUTER SERVICES

FOR COMPUTER SOFTWARE CONSULTATION AND DESIGN FOR OTHERS; COMPUTER NETWORK CONSULTATION AND DESIGN FOR OTHERS; COMPUTER PROJECT MANAGEMENT SERVICES; COMPUTER SYSTEMS ANALYSIS; TECHNICAL SUPPORT SERVICES, NAMELY, TROUBLESHOOTING OF COMPUTER HARDWARE AND SOFTWARE PROBLEMS (U.S. CLS. 100 AND 101).

BILL DAWE, EXAMINING ATTORNEY

SN 77-012,170. LAND O'LAKES PURINA FEED LLC, SHOREVIEW, MN. FILED 10-3-2006.

NUTRA BLEND

THE MARK CONSISTS OF STANDARD CHARACTERS WITHOUT CLAIM TO ANY PARTICULAR FONT, STYLE, SIZE, OR COLOR.

NO CLAIM IS MADE TO THE EXCLUSIVE RIGHT TO USE "BLEND", APART FROM THE MARK AS SHOWN.

CLASS 5—PHARMACEUTICALS

FOR MEDICATED CALF MILK REPLACER FOR ANIMALS (U.S. CLS. 6, 18, 44, 46, 51 AND 52).

CLASS 31—NATURAL AGRICULTURAL PRODUCTS

FOR NON-MEDICATED CALF MILK REPLACER FOR ANIMALS (U.S. CLS. 1 AND 46).
KATHERINE CHANG, EXAMINING ATTORNEY

SN 77-012,593. ENTERPRISE RENT-A-CAR COMPANY, ST. LOUIS, MO. FILED 10-3-2006.



OWNER OF U.S. REG. NO. 2,064,660.
THE COLOR(S) GREEN AND BLACK IS/ARE CLAIMED AS A FEATURE OF THE MARK.

THE MARK CONSISTS OF A HORIZONTALLY DISPOSED RECTANGLE, WHICH IS DIVIDED INTO TWO ADJACENT FIELDS: A GREEN, GENERALLY SQUARE FIELD ON THE LEFT, AND A BLACK RECTANGULAR FIELD ON THE RIGHT.

SN 77-012,340. ASTYPALEA, INC., LINTHICUM, MD. FILED 10-3-2006.

CLASS 12—VEHICLES

FOR VEHICLES, NAMELY, AUTOMOBILES, TRUCKS, CARS, LAND VEHICLES (U.S. CLS. 19, 21, 23, 31, 35 AND 44).

CLASS 35—ADVERTISING AND BUSINESS

FOR VEHICLE DEALERSHIP SERVICES, NAMELY, DEALERSHIPS IN THE FIELD OF AUTOMOBILES, TRUCKS, CARS, LAND VEHICLES; VEHICLE FLEET MANAGEMENT SERVICES, NAMELY, TRACKING AND MONITORING VEHICLES FOR COMMERCIAL PURPOSES, AND BUSINESS CONSULTATION SERVICES RELATING TO THE MANAGEMENT OF A FLEET OF VEHICLES FOR COMMERCIAL PURPOSES (U.S. CLS. 100, 101 AND 102).

CLASS 37—CONSTRUCTION AND REPAIR

FOR VEHICLE REPAIR SERVICES; VEHICLE FLEET MANAGEMENT SERVICES, NAMELY, VEHICLE REPAIR AND MAINTENANCE (U.S. CLS. 100, 103 AND 106).

CLASS 39—TRANSPORTATION AND STORAGE

FOR VEHICLE RENTAL AND LEASING SERVICES; AND RESERVATION SERVICES FOR THE RENTAL AND LEASING OF VEHICLES, NAMELY, RENTAL RESERVATIONS FOR AUTOMOBILES, TRUCKS, CARS, LAND VEHICLES (U.S. CLS. 100 AND 105).

JOHN DWYER, EXAMINING ATTORNEY



RESTAURANT

NO CLAIM IS MADE TO THE EXCLUSIVE RIGHT TO USE "RESTAURANT", APART FROM THE MARK AS SHOWN.

THE COLOR(S) RED, WHITE AND BLUE IS/ARE CLAIMED AS A FEATURE OF THE MARK.

THE MARK CONSISTS OF A RED SHIELD WITH A WHITE AND BLUE BORDER. ACROSS THE SHIELD IS A BLUE BANNER/SASH WITH "G&M" WRITTEN IN WHITE. BELOW THE SHIELD IS THE WORD "RESTAURANT" WRITTEN IN BLUE.

CLASS 29—MEATS AND PROCESSED FOODS

FOR DINNER PACKAGES CONSISTING OF CRAB CAKES, SEAFOOD SOUPS, STUFFED OYSTERS AND STUFFED SHRIMP; CRAB CAKES, SEAFOOD SOUPS, STUFFED OYSTERS, STUFFED SHRIMP; MOUSSAKA (U.S. CL. 46).

FIRST USE 1-1-2006; IN COMMERCE 1-1-2006.

CLASS 35—ADVERTISING AND BUSINESS

FOR MAIL ORDER SERVICES FEATURING PREPARED SEAFOOD DISHES (U.S. CLS. 100, 101 AND 102).
FIRST USE 1-1-2006; IN COMMERCE 1-1-2006.

CLASS 43—HOTEL AND RESTAURANT SERVICES

FOR RESTAURANT, BAR AND CARRY-OUT FOOD RESTAURANT SERVICES (U.S. CLS. 100 AND 101).
FIRST USE 1-1-2006; IN COMMERCE 1-1-2006.
KHANH LE, EXAMINING ATTORNEY

SN 77-012,676. LF, LLC, WILMINGTON, DE. FILED 10-3-2006.



NO CLAIM IS MADE TO THE EXCLUSIVE RIGHT TO USE "DESIGN", APART FROM THE MARK AS SHOWN.

THE MARK CONSISTS OF THE WORDS "UNWIND & DESIGN" IN LOWER-CASE LETTERS, THE WORD "DESIGN" HAVING A STYLIZED LETTER "G".

CLASS 9—ELECTRICAL AND SCIENTIFIC APPARATUS

FOR DOWNLOADABLE FILMS AND TELEVISION PROGRAMS PROVIDED VIA A VIDEO-ON-DEMAND SERVICE AND PRERECORDED VIDEOTAPES, ALL FEATURING IDEAS FOR HOME IMPROVEMENT, HOME AND GARDEN, AND WOODWORKING PROJECTS (U.S. CLS. 21, 23, 26, 36 AND 38).

SN 77-012,908. EASYHOME LTD., EDMONTON, ALBERTA, CANADA, FILED 10-3-2006.

EASYHOME

CLASS 16—PAPER GOODS AND PRINTED MATTER

FOR PRINTED MATERIALS, NAMELY, BROCHURES, PAMPHLETS, NEWSLETTERS, MAGAZINES, BOOKS, AND POSTERS FEATURING IDEAS FOR HOME IMPROVEMENT, HOME AND GARDEN, AND WOODWORKING PROJECTS (U.S. CLS. 2, 5, 22, 23, 29, 37, 38 AND 50).

THE MARK CONSISTS OF STANDARD CHARACTERS WITHOUT CLAIM TO ANY PARTICULAR FONT, STYLE, SIZE, OR COLOR.

OWNER OF U.S. REG. NO. 3,118,219.

CLASS 35—ADVERTISING AND BUSINESS

FOR RETAIL STORE SERVICES FEATURING FURNITURE AND HOUSEHOLD FURNISHINGS IN THE NATURE OF APPLIANCES AND ELECTRONIC EQUIPMENT THAT CAN BE PURCHASED UNDER A RENT-TO-OWN CONTRACT (U.S. CLS. 100, 101 AND 102).

FIRST USE 6-18-2007; IN COMMERCE 6-18-2007.

CLASS 35—ADVERTISING AND BUSINESS

FOR PROVIDING ADVICE AND INFORMATION VIA A COMPUTER WEB SITE REGARDING CUSTOMER SERVICES, PRODUCT MANAGEMENT, AND PRICES IN CONNECTION WITH PURCHASES MADE OVER THE INTERNET RELATING TO HOME IMPROVEMENT, HOME AND GARDEN, AND WOODWORKING PROJECTS; PREPARATION OF ADVERTISING FOR OTHERS FOR DISSEMINATION VIA A COMPUTER WEB SITE, COMPACT DISC, OR DVD FOR OPTIONAL UPLOAD OR DOWNLOAD TO A COMPUTER (U.S. CLS. 100, 101 AND 102).

CLASS 43—HOTEL AND RESTAURANT SERVICES

FOR RENTAL OF FURNITURE; RENTAL OF FURNITURE AND HOUSEHOLD FURNISHINGS IN THE NATURE OF APPLIANCES AND ELECTRONIC EQUIPMENT FOR USE IN TEMPORARY HOUSING ACCOMMODATIONS (U.S. CLS. 100 AND 101).

FIRST USE 6-18-2007; IN COMMERCE 6-18-2007.

JOHN DWYER, EXAMINING ATTORNEY

CLASS 38—COMMUNICATION

FOR PROVIDING TELECOMMUNICATIONS ACCESS TO FILMS AND TELEVISION PROGRAMS VIA A VIDEO-ON-DEMAND SERVICE FEATURING IDEAS FOR HOME IMPROVEMENT, HOME AND GARDEN, AND WOODWORKING PROJECTS; TELEVISION AND RADIO BROADCASTING SERVICES; AND TELEVISION AND RADIO BROADCASTING INFORMATION AND CONSULTATION SERVICES (U.S. CLS. 100, 101 AND 104).

SN 77-012,917. EASYHOME LTD., EDMONTON, ALBERTA, CANADA, FILED 10-3-2006.

CLASS 41—EDUCATION AND ENTERTAINMENT

FOR EDUCATIONAL SERVICES, NAMELY, OFFERING WORKSHOPS AND SEMINARS FEATURING IDEAS FOR HOME IMPROVEMENT, HOME AND GARDEN, AND WOODWORKING PROJECTS; PROVIDING NON-DOWNLOADABLE FILMS AND TELEVISION PROGRAMS VIA A VIDEO-ON-DEMAND SERVICE; PRODUCTION OF TELEVISION AND RADIO PROGRAMS RELATING TO HOME IMPROVEMENT, HOME AND GARDEN, AND WOODWORKING PROJECTS; AND ELECTRONIC PUBLISHING SERVICES, NAMELY, PUBLICATION OF TEXT AND GRAPHICS WORKS OF OTHERS ON A COMPUTER WEB SITE, COMPACT DISC, OR DVD FEATURING IDEAS FOR HOME IMPROVEMENT, HOME AND GARDEN, AND WOODWORKING PROJECTS (U.S. CLS. 100, 101 AND 107).

WOODROW HARTZOG, EXAMINING ATTORNEY

OWNER OF U.S. REG. NO. 3,118,219.

CLASS 35—ADVERTISING AND BUSINESS

FOR RETAIL STORE SERVICES FEATURING FURNITURE AND HOUSEHOLD FURNISHINGS IN THE NATURE OF APPLIANCES AND ELECTRONIC EQUIPMENT THAT CAN BE PURCHASED UNDER A RENT-TO-OWN CONTRACT (U.S. CLS. 100, 101 AND 102).

FIRST USE 6-18-2007; IN COMMERCE 6-18-2007.



The logo for Easyhome features the word "easyhome" in a lowercase, sans-serif font. The letter "e" is stylized with a small house icon integrated into its top curve. The logo is positioned above a vertical line that extends downwards.

CLASS 43—HOTEL AND RESTAURANT SERVICES

FOR RENTAL OF FURNITURE; RENTAL OF FURNITURE AND HOUSEHOLD FURNISHINGS IN THE NATURE OF APPLIANCES AND ELECTRONIC EQUIPMENT FOR USE IN TEMPORARY HOUSING ACCOMMODATIONS (U.S. CLS. 100 AND 101).

FIRST USE 6-18-2007; IN COMMERCE 6-18-2007.
JOHN DWYER, EXAMINING ATTORNEY

SN 77-013,130. NEUTROGENA CORPORATION, LOS ANGELES, CA. FILED 10-4-2006.

OIL-FREE ACNE STRESS
CONTROL

THE MARK CONSISTS OF STANDARD CHARACTERS WITHOUT CLAIM TO ANY PARTICULAR FONT, STYLE, SIZE, OR COLOR.

NO CLAIM IS MADE TO THE EXCLUSIVE RIGHT TO USE "OIL-FREE ACNE", APART FROM THE MARK AS SHOWN.

CLASS 3—COSMETICS AND CLEANING PREPARATIONS

FOR NON-MEDICATED ACNE MASK, NON-MEDICATED ACNE GEL, NON-MEDICATED ACNE WASH, NON-MEDICATED ACNE HYDRATOR LIQUID, NON-MEDICATED ACNE MOISTURIZER, NON-MEDICATED SKIN EXFOLIATOR; FACIAL AND BODY CLEANSING LIQUID, LOTION, CREAM, FOAM AND GEL, CLEANSING PADS; FOAMING FACIAL AND BODY WASH, FACIAL AND BODY SCRUB; NON-MEDICATED BLACKHEAD ELIMINATOR CREAM, LOTION, GEL AND WIPES; NON-MEDICATED ACNE PATCH; FACIAL TONER; FACIAL AND BODY CLEANSING SOAP, BODY WASH, BODY SCRUB, BODY GEL; DEEP PORE SKIN CLEANSER; CONCEALER, COVER-UP CREAM AND LOTION; CLEANSING GEL, TONING GEL, SOOTHING GEL, NON-MEDICATED ACNE TREATMENT MASK AND GEL; ASTRINGENT REFRESHER FOR COSMETIC PURPOSES; NON-MEDICATED SCAR TREATMENTS, NAMELY, SCAR ERASER AND SCAR ELIMINATOR CREAM, GEL, LOTION AND SERUM; SHOWER GEL, FACIAL AND BODY RINSE, NON-MEDICATED SKIN TREATMENT MASK; NON-MEDICATED ACNE SOLUTION AND BALM; NON-MEDICATED SKIN SERUM; NON-MEDICATED CLEANSING CLOTHS AND CLEANSING PADS; DISPOSABLE NON-MEDICATED ACNE TREATMENT STICKS AND SWABS (U.S. CLS. 1, 4, 6, 50, 51 AND 52).

CLASS 5—PHARMACEUTICALS

FOR MEDICATED ACNE MASK, MEDICATED ACNE GEL, MEDICATED ACNE WASH, MEDICATED ACNE HYDRATOR LIQUID, MEDICATED MOISTURIZER, MEDICATED SKIN EXFOLIATOR; MEDICATED FACIAL AND BODY CLEANSING LIQUID, LOTION, CREAM, FOAM AND GEL; MEDICATED CLEANSING PADS; MEDICATED FOAMING FACIAL AND BODY WASH, MEDICATED FACIAL AND BODY SCRUB; MEDICATED BLACKHEAD ELIMINATOR CREAM, LOTION, GEL AND WIPES, MEDICATED ACNE PATCH; MEDICATED FACIAL TONER; MEDICATED FACIAL AND BODY CLEANSING SOAP, MEDICATED BODY WASH, BODY SCRUB, BODY GEL; MEDICATED DEEP PORE SKIN CLEANSER; MEDICATED CONCEALER, COVER-UP CREAM AND LOTION; MEDICATED CLEANSING GEL, TONING GEL, AND SOOTHING GEL; MEDICATED ACNE TREATMENT MASK AND GEL; MEDICATED ASTRINGENT REFRESHER; MEDICATED SCAR TREATMENTS, NAMELY, SCAR ERASER AND SCAR ELIMINATOR CREAM, GEL, LOTION AND SERUM; MEDICATED SHOWER GEL, MEDICATED FACIAL AND BODY RINSE, MEDICATED SKIN TREATMENT MASK; MEDICATED ACNE SOLUTION AND BALM; MEDICATED SKIN SERUM; MEDICATED CLEANSING CLOTHS AND CLEANSING PADS; DISPOSABLE MEDICATED ACNE TREATMENT STICKS AND SWABS (U.S. CLS. 6, 18, 44, 46, 51 AND 52).

CLASS 21—HOUSEWARES AND GLASS

FOR BATTERY OPERATED AND ELECTRONICALLY OPERATED HAND HELD EXFOLIATING DEVICES FOR TREATING, CLEANSING AND MASSAGING THE SKIN (U.S. CLS. 2, 13, 23, 29, 30, 33, 40 AND 50).
WON TEAK OH, EXAMINING ATTORNEY

SN 77-013,701. THE DEREK CORPORATION LIMITED, AUCKLAND, NEW ZEALAND, FILED 10-4-2006.



OWNER OF NEW ZEALAND REG. NO. 755886, DATED 9-26-2006, EXPIRES 9-26-2016.

OWNER OF NEW ZEALAND REG. NO. 733395, DATED 8-1-2005, EXPIRES 8-1-2015.

CLASS 3—COSMETICS AND CLEANING PREPARATIONS

FOR (BASED ON 44(E) PURSUANT TO NEW ZEALAND FOREIGN REGISTRATION NUMBER 733395) HAND SOAPS, SHAMPOOS, LIP BALM, NON-MEDICATED TOILETRIES, SKIN MOISTURIZERS (U.S. CLS. 1, 4, 6, 50, 51 AND 52).

CLASS 18—LEATHER GOODS

FOR (BASED ON 44(E) PURSUANT TO NEW ZEALAND FOREIGN REGISTRATION NUMBER 755866) COSMETIC BAGS SOLD EMPTY, HANDBAGS, AND TRAVEL LUGGAGE (U.S. CLS. 1, 2, 3, 22 AND 41).
WENDY JUN, EXAMINING ATTORNEY

SN 77-014,307. EPT, VILLEURBANNE, FRANCE, FILED 10-5-2006.

SN 77-014,922. US INVESTIGATIONS SERVICES, LLC, ANNANDALE, PA. FILED 10-5-2006.

EXAPROTECT

THE MARK CONSISTS OF STANDARD CHARACTERS WITHOUT CLAIM TO ANY PARTICULAR FONT, STYLE, SIZE, OR COLOR.

CLASS 9—ELECTRICAL AND SCIENTIFIC APPARATUS

FOR SECURITY MANAGEMENT SOFTWARE FOR MANAGING COMPUTER LOG AND COMPUTER NETWORK SECURITY POLICY (U.S. CLS. 21, 23, 26, 36 AND 38).

CLASS 42—SCIENTIFIC AND COMPUTER SERVICES

FOR DESIGN AND DEVELOPMENT OF SECURITY MANAGEMENT SOFTWARE (U.S. CLS. 100 AND 101).
CORY BOONE, EXAMINING ATTORNEY

SN 77-014,835. CANAD CORPORATION OF MANITOBA LTD., WINNIPEG, MANITOBA, CANADA, FILED 10-5-2006.

CANAD INNS. YOUR DESTINATION CENTERS.

THE MARK CONSISTS OF STANDARD CHARACTERS WITHOUT CLAIM TO ANY PARTICULAR FONT, STYLE, SIZE, OR COLOR.

NO CLAIM IS MADE TO THE EXCLUSIVE RIGHT TO USE "INNS" AND "CENTERS", APART FROM THE MARK AS SHOWN.

SEC. 2(F) AS TO "CANAD INNS".

CLASS 41—EDUCATION AND ENTERTAINMENT

FOR CABARET SERVICES (U.S. CLS. 100, 101 AND 107).

CLASS 43—HOTEL AND RESTAURANT SERVICES

FOR HOTEL, MOTEL, BAR, COCKTAIL LOUNGE AND BANQUET ROOM AND SOCIAL FUNCTION FACILITIES FOR SPECIAL OCCASIONS (U.S. CLS. 100 AND 101).

SARA THOMAS, EXAMINING ATTORNEY



OWNER OF U.S. REG. NOS. 1,443,502 AND 2,908,473.
"THE COLOR(S) BLACK AND RED IS/ARE CLAIMED AS A FEATURE OF THE MARK."

THE MARK CONSISTS OF THE WORDING DAC IN BLACK. A CHECK MARK DESIGN IN RED AND THE WORDING THE DRIVING FORCE BEHIND USIS IN RED. THE MARK APPEARS ON A TRANSPARENT BACKGROUND AND ANY COLOR APPEARING THEREIN IS NEITHER CLAIMED AS, NOR IS A FEATURE OF THE MARK.

CLASS 44—MEDICAL, BEAUTY AND AGRICULTURAL SERVICES

FOR PROVIDING EMPLOYMENT AND PRE-EMPLOYMENT DRUG AND ALCOHOL TESTING OF CANDIDATES FOR VEHICLE DRIVER POSITIONS. (U.S. CLS. 100 AND 101).

CLASS 45—PERSONAL AND LEGAL SERVICES

FOR EMPLOYMENT AND PRE-EMPLOYMENT BACKGROUND SCREENING SERVICES, NAMELY, PROVIDING CUSTOMIZED INFORMATION WITH REGARD TO CANDIDATES FOR VEHICLE DRIVER POSITIONS. (U.S. CLS. 100 AND 101).

BERNICE MIDDLETON, EXAMINING ATTORNEY

SN 77-015,821. TABLETOPS UNLIMITED INC., CARSON, CA. FILED 10-6-2006.

Everyday Entertaining

THE MARK CONSISTS OF STANDARD CHARACTERS WITHOUT CLAIM TO ANY PARTICULAR FONT, STYLE, SIZE, OR COLOR.

CLASS 8—HAND TOOLS

FOR CUTLERY, NAMELY KNIVES, FORKS, SPOONS (U.S. CLS. 23, 28 AND 44).

CLASS 21—HOUSEWARES AND GLASS

FOR COOKWARE, NAMELY, POTS AND PANS; BEVERAGE GLASSWARE; DINNERWARE, NAMELY, MUGS, SERVING TRAYS; SERVING PLATTERS, PLATES, DISHES AND SAUCERS (U.S. CLS. 2, 13, 23, 29, 30, 33, 40 AND 50).

REGINA DRUMMOND, EXAMINING ATTORNEY

SN 77-015,891. NOTORIOUS LLC, NEW YORK, NY. FILED 10-6-2006.

SN 77-016,717. TREEHUGGER ACQUISITION CORP., SILVER SPRING, MD. FILED 10-9-2006.

NOTORIOUS B.I.G.

THE MARK CONSISTS OF STANDARD CHARACTERS WITHOUT CLAIM TO ANY PARTICULAR FONT, STYLE, SIZE, OR COLOR.

THE NAME "NOTORIOUS B.I.G." IN THE MARK DOES NOT IDENTIFY A PSEUDONYM, STAGE NAME OR NICKNAME OF A LIVING INDIVIDUAL.

CLASS 9—ELECTRICAL AND SCIENTIFIC APPARATUS

FOR CD CASES/SLEEVES, COMPUTER GAME CARTRIDGES, COMPUTER GAME CASSETTES, COMPUTER GAME DISCS, COMPUTER GAME PROGRAMS, COMPUTER GAME SOFTWARE, COMPUTER GAME TAPES, COMPUTER PROGRAMS FOR PRE-RECORDED GAMES, ELECTRONIC GAME PROGRAMS, ELECTRONIC GAME SOFTWARE FOR CELLULAR TELEPHONES, ELECTRONIC GAME SOFTWARE FOR WIRELESS DEVICES, ELECTRONIC GAME SOFTWARE FOR HANDHELD ELECTRONIC DEVICES, GAME SOFTWARE, INTERACTIVE MULTIMEDIA COMPUTER GAME PROGRAM, INTERACTIVE VIDEO GAME PROGRAMS, INTERACTIVE VIDEO GAMES OF VIRTUAL REALITY COMPRISED OF COMPUTER HARDWARE AND SOFTWARE, VIDEO GAME SOFTWARE, VIDEO GAME TAPE CASSETTES (U.S. CLS. 21, 23, 26, 36 AND 38).

CLASS 18—LEATHER GOODS

FOR SACKS AND BAGS COMPRISED OF WOVEN, NATURAL AND SYNTHETIC FIBERS, NAMELY, SACK BAGS IN THE NATURE OF HIP SACKS, KNAPSACKS, COURIER BAGS IN THE NATURE OF MESSENGER BAGS, MESSENGER BAGS AND DUFFLE BAGS (U.S. CLS. 1, 2, 3, 22 AND 41).

CLASS 25—CLOTHING

FOR BOYS, TODDLERS AND INFANTS' SWEATSHIRTS, JACKETS, WIND RESISTANT JACKETS, SKI JACKETS, TRENCH COATS, RAINWEAR, RAINCOATS, PONCHOS, COATS, SHIRTS, DRESS SHIRTS, THERMAL UNDERWEAR, JOGGING SUITS, SWEAT SUITS, TEE SHIRTS, PANTS, DRESS PANTS, CASUAL PANTS, JEANS, SWEAT PANTS, SKI PANTS, SWIM WEAR, BATHING SUITS, UNDERWEAR, NAMELY, UNDERSHIRTS, BOXERS AND BRIEFS, LOUNGEWEAR, SOCKS, PAJAMAS, ROBES, WARM UP SUITS, SHORTS, SWEATERS, VESTS, MUFFLERS, GLOVES, SCARVES, RASHGUARDS, NAMELY, TEE SHIRTS MADE OUT OF SWIMWEAR MATERIAL, AND TIES (U.S. CLS. 22 AND 39).

CLASS 28—TOYS AND SPORTING GOODS

FOR ACTION SKILL GAMES, ACTION TARGET GAMES, ACTION-TYPE TARGET GAMES (U.S. CLS. 22, 23, 38 AND 50).

CLASS 41—EDUCATION AND ENTERTAINMENT

FOR PROVIDING A COMPUTER GAME THAT MAY BE ACCESSED NETWORK-WIDE BY NETWORK USERS (U.S. CLS. 100, 101 AND 107).

SONYA STEPHENS, EXAMINING ATTORNEY

HUGG

THE MARK CONSISTS OF STANDARD CHARACTERS WITHOUT CLAIM TO ANY PARTICULAR FONT, STYLE, SIZE, OR COLOR.

CLASS 41—EDUCATION AND ENTERTAINMENT

FOR ENTERTAINMENT SERVICES, NAMELY, PROVIDING TELEVISION PROGRAMS, WEBCAST TELEVISION AND VIDEO PROGRAMS VIA A GLOBAL COMPUTER NETWORK, AND PODCASTS ALL IN THE FIELD OF SUSTAINABLE AND ECO-FRIENDLY RESOURCES; ELECTRONIC PUBLISHING SERVICES, NAMELY, PUBLICATION OF AUDIO, TEXT AND GRAPHICS OF OTHERS FEATURING ENVIRONMENTAL MATTERS AND SUSTAINABLE AND ECO-FRIENDLY RESOURCES (U.S. CLS. 100, 101 AND 107).

CLASS 42—SCIENTIFIC AND COMPUTER SERVICES

FOR PROVIDING CUSTOMIZED ON-LINE WEB PAGES FEATURING USER DEFINED INFORMATION, WHICH INCLUDES SEARCH ENGINES AND ON-LINE WEB LINKS TO OTHER WEB SITES (U.S. CLS. 100 AND 101).

FIRST USE 3-19-2006; IN COMMERCE 3-19-2006.
LAURIE KAUFMAN, EXAMINING ATTORNEY

SN 77-016,870. MYOJO SHOKUJIN KABUSHIKI KAISHA ALSO TRADING AS MYOJO FOODS CO., LTD., TOKYO, JAPAN, FILED 10-9-2006.



OWNER OF U.S. REG. NO. 1,355,676.

THE COLOR(S) RED, GOLD AND WHITE IS/ARE CLAIMED AS A FEATURE OF THE MARK.

THE MARK CONSISTS OF THE WORD MYOJO IN SPECIAL FORM IN WHITE, THE REPRESENTATION OF A CHICKEN IN WHITE WITH AN ARBITRARY DESIGN IN WHITE ALL APPEARING ON A RED OVAL WITH GOLD TRIM.

THE FOREIGN WORDING IN THE MARK TRANSLATES INTO ENGLISH AS A BRIGHT STAR.

CLASS 29—MEATS AND PROCESSED FOODS

FOR POTATO CHIPS; SOUP FOR CHINESE NOODLES; SOUP FOR UDON NOODLES; SOUP FOR SOBA NOODLES (U.S. CL. 46).

SN 77-017,471. R. C. TAYLOR & ASSOCIATES, INC., WEST CHESTER, PA. FILED 10-10-2006.

POSITUDE

THE MARK CONSISTS OF STANDARD CHARACTERS WITHOUT CLAIM TO ANY PARTICULAR FONT, STYLE, SIZE, OR COLOR.

CLASS 30—STAPLE FOODS

FOR CHINESE NOODLE SNACKS; POPCORN; JAPANESE CONFECTIONERY, NAMELY, SWEET RED BEAN SOUP WITH POUNDED RICE CAKE KNOWN AS SHIRUKO, INSTANT SHIRUKO, SWEET SOUP OF RED BEAN FLOUR WITH POUNDED RICE CAKE KNOWN AS ZENZAI, POWDERED ZENZAI; WESTERN-STYLE CONFECTIONERY, NAMELY, ICE CREAM, CAKE, CASTELLA CAKE, SHIP BISCUITS KNOWN AS PILOT BREAD, COOKIES, CRACKERS, SHERBETS, SORBETS, SPONGE CAKE, PIES AND BISCUITS; CONFECTIONERY, NAMELY, SNACKS MADE FROM WHEAT, CHINESE FOOD FLAVOR NOODLE SNACKS, JAPANESE FOOD FLAVOR NOODLE SNACKS, TORTILLA CHIPS; BREAD AND BUNS; SAUCES FOR FRIED CHINESE NOODLES; MAYONNAISE; SALAD DRESSINGS; OTHER SEASONINGS, NAMELY FERMENTED SOYBEAN PASTE CALLED MISO, WORCESTERSHIRE SAUCE, MEAT GRAVIES, KETCHUP, SOY SAUCE, VINEGAR, VINEGAR MIXES, SAUCE IN THE NATURE OF DIPPING SOUP FOR SOBA NOODLE, CALLED SOBY-TSUYU, WHITE SAUCE, SAUCES FOR BARBECUED MEAT, FOOD ADDITIVES FOR NON-NUTRITIONAL PURPOSES FOR USE AS A FLAVORING, INGREDIENT OR FILLER, NAMELY, FRUCTOSE FOR FOOD, SUGAR, MALTOSE FOR FOOD, GLUCOSE FOR FOOD, STARCH SYRUP FOR FOOD, TABLE SALT MIXED WITH SESAME SEEDS, COOKING SALT, ROASTED AND GROUND SESAME SEEDS, CELERY SALT, CHEMICAL SEASONINGS NAMELY MONOSODIUM GLUTAMATE; PEPPER FOR CHINESE NOODLES; MUSTARD AND OTHER SPICES, NAMELY MUSTARD POWDER, CURRY POWDER, PEPPER POWDER, JAPANESE PEPPER POWDER SPICE KNOWN AS SANSHO POWDER, CLOVE POWDER, HOT PEPPER POWDER, CINNAMON POWDER, JAPANESE HORSERADISH POWDER SPICE KNOWN AS WASABI; INSTANT ICE CREAM MIXES; INSTANT SHERBET MIXES; FRIED CHINESE NOODLES, UNCOOKED; SOBA NOODLES, UNCOOKED; CHINESE NOODLES, UNCOOKED; INSTANT OR PRECOOKED FRIED CHINESE NOODLES; INSTANT OR PRECOOKED SOBA NOODLES; INSTANT OR PRECOOKED CHINESE NOODLES; SPAGHETTI, UNCOOKED; PASTA, UNCOOKED; INSTANT OR PRECOOKED SPAGHETTI; MACARONI, UNCOOKED; PASTA-WRAPPINGS FOR CHINESE STUFFED DUMPLINGS, GYOZA; WON-TON; BEAN-STARCH NOODLES, HARUSAME UNCOOKED; CHINESE RICE NOODLES, BIFUN UNCOOKED; POUNDED RICE CAKES, MOCHI; DRIED COOKED-RICE; CANNED COOKED RICE; OATMEAL; CORN FLAKES; BREAKFAST CEREALS; PROCESSED CEREALS; COOKED CHINESE NOODLES; COOKED WON-TON; COOKED BEAN-STARCH NOODLES, HARUSAME; COOKED CHINESE RICE NOODLES, BIFUN; COOKED SOBA NOODLES; COOKED FRIED CHINESE NOODLES; COOKED SPAGHETTI; COOKED PASTA; CHINESE STUFFED DUMPLINGS, GYOZA; CHINESE STEAMED DUMPLINGS, SHUMAI; SANDWICHES; BOX LUNCHES, NAMELY, READY-MADE BOX LUNCH SET CONSISTING PRIMARILY OF BOILED RICE; STEAMED BUNS STUFFED WITH MINCED MEAT, CHINESE MEAT BUNS; PIZZAS; RAVIOLI; SUSHI; INSTANT CONFECTIONERY MIXES, NAMELY, INSTANT CAKES AND DESSERT MIXES IN THE NATURE OF MIXES FOR PANCAKES, SPONGE CAKE, DOUGHNUTS, BISCUITS, COOKIES, CARAMEL CUSTARD AND JELLY; RICE; PROCESSED HUSKED OATS AND BARLEY; FLOUR FOR FOOD; GLUTEN FOR FOOD; FRIED BALLS OF BATTER MIXES WITH SMALL PIECES OF OCTOPUS, TAKOYAKI (U.S. CL. 46).
LYDIA BELZER, EXAMINING ATTORNEY

CLASS 9—ELECTRICAL AND SCIENTIFIC APPARATUS

FOR PRE-RECORDED CD'S, VIDEO TAPES, LASER DISKS AND DVD'S FEATURING MATERIALS PERTAINING TO ENHANCEMENT OF MANAGEMENT, COMMUNICATION AND SALES SKILLS FOR INDIVIDUALS AND ORGANIZATIONS (U.S. CLS. 21, 23, 26, 36 AND 38).

FIRST USE 2-1-1989; IN COMMERCE 2-1-1989.

CLASS 14—JEWELRY

FOR ORNAMENTAL LAPEL PINS (U.S. CLS. 2, 27, 28 AND 50).

FIRST USE 2-1-1989; IN COMMERCE 2-1-1989.

CLASS 16—PAPER GOODS AND PRINTED MATTER

FOR WORKBOOKS IN THE FIELD OF ENHANCEMENT OF MANAGEMENT, COMMUNICATION AND SALES SKILLS FOR INDIVIDUALS AND ORGANIZATIONS (U.S. CLS. 2, 5, 22, 23, 29, 37, 38 AND 50).

FIRST USE 2-1-1989; IN COMMERCE 2-1-1989.

CLASS 41—EDUCATION AND ENTERTAINMENT

FOR EDUCATION SERVICES, NAMELY, PROVIDING CLASSES, SEMINARS AND WORKSHOPS IN THE FIELD OF BUSINESS MANAGEMENT, COMMUNICATIONS AND SALES FOR INDIVIDUALS AND ORGANIZATIONS (U.S. CLS. 100, 101 AND 107).

FIRST USE 2-1-1989; IN COMMERCE 2-1-1989.

JOANNA DUKOVIC, EXAMINING ATTORNEY

SN 77-019,172. THE BOARD OF TRUSTEES OF THE UNIVERSITY OF ILLINOIS, URBANA, IL. FILED 10-11-2006.



THE MARK CONSISTS OF NCSA TRI-COLOR RAY OF LIGHT LOGO.

CLASS 9—ELECTRICAL AND SCIENTIFIC APPARATUS

FOR DOWNLOADABLE COMPUTER SOFTWARE FOR PROCESSING, ANALYZING, ORGANIZING, VISUALIZING, ANIMATING, MANIPULATING, STORING, CONVERTING AND MODELING DATA; DOWNLOADABLE APPLICATION DEVELOPMENT SOFTWARE; DOWNLOADABLE COMPUTER NETWORKING SOFTWARE; DOWNLOADABLE VIRTUAL REALITY INTERFACE COMPUTER SOFTWARE; DOWNLOADABLE COMPUTER SECURITY SOFTWARE IN THE FIELDS OF AUTHENTICATION AND PRIVACY; DOWNLOADABLE COMPUTER SOFTWARE FOR MAKING DOCUMENTS AVAILABLE TO WEB BROWSERS; DOWNLOADABLE COMPUTER SOFTWARE TO COLLECT IMAGES; DOWNLOADABLE INTERACTIVE COMPUTER SOFTWARE; DOWNLOADABLE INFORMATICS COMPUTER SOFTWARE; DOWNLOADABLE FORECASTING COMPUTER SOFTWARE; DOWNLOADABLE COMPUTER SOFTWARE FOR USE IN SUPERCOMPUTING APPLICATIONS AND NETWORKS; DOWNLOADABLE HIGH PERFORMANCE COMPUTING SOFTWARE; AND DOWNLOADABLE COMPUTING SOFTWARE FOR ARTIFICIAL INTELLIGENCE, DATA MINING AND MACHINE LEARNING (U.S. CLS. 21, 23, 26, 36 AND 38).

FIRST USE 8-0-2003; IN COMMERCE 8-0-2003.

CLASS 16—PAPER GOODS AND PRINTED MATTER

FOR PRINTED PERIODICALS IN THE FIELDS OF COMPUTER SECURITY, COMPUTER NETWORKING, DATA HANDLING, DATA MANAGEMENT, DATA STORAGE, DESIGN AND DEVELOPMENT OF COMPUTER NETWORKS, DATA MINING, COMPUTER INFRASTRUCTURE, COMPUTER SOFTWARE, COMPUTER HARDWARE, SUPERCOMPUTING APPLICATIONS, HIGH PERFORMANCE COMPUTING APPLICATIONS, DATA VISUALIZATION, INFORMATION VISUALIZATION, COMPUTER ANIMATION, COMPUTER DRAWING, COMPUTER MODELING, ELECTRONIC STORAGE; PRINTED PERIODICALS FEATURING GENERAL SCIENCE AND ENGINEERING RESEARCH USING SUPERCOMPUTING AND HIGH PERFORMANCE COMPUTING HARDWARE, SOFTWARE AND INFRASTRUCTURE (U.S. CLS. 2, 5, 22, 23, 29, 37, 38 AND 50).

FIRST USE 8-0-2003; IN COMMERCE 8-0-2003.

CLASS 41—EDUCATION AND ENTERTAINMENT

FOR EDUCATIONAL SERVICES IN THE NATURE OF— ORGANIZING, PROVIDING AND CONDUCTING INSTRUCTIONAL ACTIVITIES, PROGRAMS, TUTORIALS, SEMINARS, WORKSHOPS, COURSE MODULES, CLASS MATERIALS, LECTURES, SYMPOSIA AND CONFERENCES IN INTEGRATION OF COMPUTER SYSTEMS AND NETWORKS IN THE FIELDS OF SOFTWARE, HARDWARE, SECURITY, NETWORKING, DATA HANDLING, DATA MANAGEMENT, AND DATA STORAGE; DESIGN AND DEVELOPMENT OF COMPUTER NETWORKS; DATA MINING; COMPUTER INFRASTRUCTURE; COMPUTER SOFTWARE; COMPUTER HARDWARE; SUPERCOMPUTING APPLICATIONS; HIGH PERFORMANCE COMPUTING APPLICATIONS; COMPUTER SECURITY; DATA VISUALIZATION; INFORMATION VISUALIZATION; COMPUTER ANIMATION; COMPUTER DRAWING; COMPUTER MODELING; DATA MANAGEMENT; DATA HANDLING; ELECTRONIC STORAGE; INTEGRATION OF COMPUTATIONAL MODELING INTO A CURRICULUM; AND ON-LINE PERIODICALS IN THE FIELDS OF COMPUTER SECURITY, COMPUTER NETWORKING, DATA HANDLING, DATA MANAGEMENT, DATA STORAGE, DESIGN AND DEVELOPMENT OF COMPUTER NETWORKS, DATA MINING, COMPUTER INFRA-

STRUCTURE, COMPUTER SOFTWARE, COMPUTER HARDWARE, SUPERCOMPUTING APPLICATIONS, HIGH PERFORMANCE COMPUTING APPLICATIONS, DATA VISUALIZATION, INFORMATION VISUALIZATION, COMPUTER ANIMATION, COMPUTER DRAWING, COMPUTER MODELING, ELECTRONIC STORAGE, AND GENERAL SCIENCE AND ENGINEERING RESEARCH USING SUPERCOMPUTING AND HIGH PERFORMANCE COMPUTING HARDWARE, SOFTWARE AND INFRASTRUCTURE VIA A GLOBAL COMPUTER INFORMATION NETWORK (U.S. CLS. 100, 101 AND 107).

FIRST USE 8-0-2003; IN COMMERCE 8-0-2003.

CLASS 42—SCIENTIFIC AND COMPUTER SERVICES

FOR COMPUTER SERVICES, NAMELY, INTEGRATION OF COMPUTER SYSTEMS AND NETWORKS IN THE FIELDS OF SOFTWARE, HARDWARE, SECURITY, NETWORKING, DATA HANDLING, DATA MANAGEMENT, AND DATA STORAGE; DESIGN AND DEVELOPMENT OF COMPUTER NETWORKS; DATA MINING; COMPUTER CONSULTATION IN THE FIELDS OF COMPUTER SECURITY, APPLICATIONS, VISUALIZATION, MODELING AND DATA ANALYTICS; RESEARCH AND DEVELOPMENT IN THE FIELDS OF COMPUTER INFRASTRUCTURE, COMPUTER SOFTWARE, COMPUTER HARDWARE, SUPERCOMPUTING APPLICATIONS, HIGH PERFORMANCE COMPUTING APPLICATIONS, COMPUTER SECURITY, DATA VISUALIZATION, INFORMATION VISUALIZATION, COMPUTER ANIMATION, COMPUTER DRAWING, COMPUTER MODELING, DATA MANAGEMENT, DATA HANDLING, AND ELECTRONIC STORAGE; COMPUTER TIME-SHARING SERVICES; ON-LINE BATCH COMPUTER SERVICES; LEASING OF COMPUTERS; AND LEASING OF COMPUTER FACILITIES (U.S. CLS. 100 AND 101).

FIRST USE 8-0-2003; IN COMMERCE 8-0-2003.

REGINA DRUMMOND, EXAMINING ATTORNEY

SN 77-019,339. PSI SERVICES HOLDING INC., DENVER, CO.
FILED 10-12-2006.

PSHI

THE MARK CONSISTS OF STANDARD CHARACTERS WITHOUT CLAIM TO ANY PARTICULAR FONT, STYLE, SIZE, OR COLOR.

CLASS 35—ADVERTISING AND BUSINESS

FOR BUSINESS ADMINISTRATION OF HUMAN SERVICES PROGRAMS FOR GOVERNMENTAL ENTITIES, EXCLUDING DIRECT CLIENT SERVICES RELATED TO MENTAL AND PHYSICAL HEALTH AND THERAPY, FOSTER CARE AND ADOPTION SERVICES, HOME HEALTH AND NURSING SERVICE (U.S. CLS. 100, 101 AND 102).

CLASS 42—SCIENTIFIC AND COMPUTER SERVICES

FOR COMPUTER SOFTWARE DESIGN FOR OTHERS; COMPUTER CONSULTATION; DEVELOPMENT OF COMPUTER SOFTWARE, HARDWARE AND NETWORK SYSTEM DEVELOPMENT FOR OTHERS (U.S. CLS. 100 AND 101).

JOANNA DUKOVIC, EXAMINING ATTORNEY

SN 77-019,350. DRÄGER MEDICAL AG & CO. KG, LÜBECK, FED REP GERMANY, FILED 10-12-2006.

SAFESTAR

PRIORITY CLAIMED UNDER SEC. 44(D) ON ERPN CMNTY TM OFC APPLICATION NO. 005363445, FILED 10-6-2006, REG. NO. 005363445, DATED 7-23-2007, EXPIRES 10-6-2016.

THE MARK CONSISTS OF THE WORD SAFESTAR.

CLASS 9—ELECTRICAL AND SCIENTIFIC APPARATUS

FOR FILTERS FOR RESPIRATORY MASKS, NAMELY, BREATHING FILTERS (U.S. CLS. 21, 23, 26, 36 AND 38).

CLASS 10—MEDICAL APPARATUS

FOR MEDICAL INSTRUMENTS FOR USE IN ANESTHESIA AND RESPIRATION, NAMELY, BREATHING FILTERS FOR ANESTHESIA MACHINES, MEDICAL RESPIRATORS, AND MEDICAL VENTILATORS (U.S. CLS. 26, 39 AND 44).

SHARON MEIER, EXAMINING ATTORNEY

SN 77-019,497. CBS BROADCASTING INC., NEW YORK, NY. FILED 10-12-2006.



NO CLAIM IS MADE TO THE EXCLUSIVE RIGHT TO USE "RECORDS", APART FROM THE MARK AS SHOWN. THE MARK CONSISTS OF A RECORD AND EYE DESIGN WITH WORDS CBS RECORDS UNDERNEATH IT.

CLASS 9—ELECTRICAL AND SCIENTIFIC APPARATUS

FOR PRE-RECORDED DIGITAL VIDEO DISKS AND VIDEO TAPES FEATURING MUSIC, COMPACT DISCS FEATURING MUSIC, PRERECORDED CD-I'S FEATURING MUSIC; DIGITAL VERSATILE DISCS (DVD'S) FEATURING MUSIC, PRERECORDED AUDIO TAPES FEATURING MUSIC, PRERECORDED VIDEOCASSETTES FEATURING MUSIC, COMPUTER GAME CARTRIDGES (U.S. CLS. 21, 23, 26, 36 AND 38).

CLASS 35—ADVERTISING AND BUSINESS

FOR RETAIL STORE SERVICES FEATURING PRE-RECORDED SOUND, VIDEO AND DATA RECORDINGS, VIDEO DISCS, COMPACT DISCS, CD-ROMS, CD-I'S, DIGITAL VERSATILE DISCS (DVD'S), TAPES, VIDEOCASSETTES, CARTRIDGES AND CARDS (U.S. CLS. 100, 101 AND 102).

CLASS 38—COMMUNICATION

FOR TRANSMISSION OF STREAMED SOUND AND AUDIO-VISUAL RECORDINGS AND UPLOADING AND DOWNLOADING MUSIC, MP3S, GRAPHICS, VIDEO IMAGES RENDERED THROUGH THE MEDIA OF TELEVISION, CABLE, SATELLITE, RADIO, TELEPHONE AND BROADBAND SYSTEMS, AND VIA THE INTERNET, PORTABLE AND WIRELESS COMMUNICATION DEVICES; PROVIDING ONLINE CHAT ROOMS AND BULLETIN BOARDS FOR ELECTRONIC TRANSMISSION OF MESSAGES AMONG USERS IN THE FIELD OF ENTERTAINMENT, CONCERTS, MUSIC EVENTS AND NEWS (U.S. CLS. 100, 101 AND 104).

CLASS 41—EDUCATION AND ENTERTAINMENT

FOR ENTERTAINMENT SERVICES, NAMELY, PRODUCTION OF MUSIC (U.S. CLS. 100, 101 AND 107).

CHARLES L. JENKINS, EXAMINING ATTORNEY

SN 77-019,975. BALL HORTICULTURAL COMPANY, WEST CHICAGO, IL. FILED 10-12-2006.

BALL INNOVATIONS

THE MARK CONSISTS OF STANDARD CHARACTERS WITHOUT CLAIM TO ANY PARTICULAR FONT, STYLE, SIZE, OR COLOR.

OWNER OF U.S. REG. NOS. 1,002,986, 1,905,832 AND 2,031,678.

NO CLAIM IS MADE TO THE EXCLUSIVE RIGHT TO USE "INNOVATIONS", APART FROM THE MARK AS SHOWN.

CLASS 21—HOUSEWARES AND GLASS

FOR PLANTS POTS, PLANT TRAYS, PLANT BASKETS, PLANT CONTAINERS (U.S. CLS. 2, 13, 23, 29, 30, 33, 40 AND 50).

CLASS 31—NATURAL AGRICULTURAL PRODUCTS

FOR LIVE PLANTS AND SEEDS; PEAT MOSS FOR PLANT AND BASKETS (U.S. CLS. 1 AND 46).

KYLE PEETE, EXAMINING ATTORNEY

SN 77-020,189. E.L.V.H., INC., LOS ANGELES, CA. FILED 10-12-2006.



OWNER OF U.S. REG. NOS. 2,853,393, 2,868,311 AND OTHERS.

CLASS 9—ELECTRICAL AND SCIENTIFIC APPARATUS

FOR MUSICAL SOUND RECORDINGS, MUSICAL VIDEO RECORDINGS, MUSICAL INSTRUMENT SIGNAL PROCESSORS, AUDIO SPEAKERS (U.S. CLS. 21, 23, 26, 36 AND 38).

SN 77-022,170. GREEN EXCHANGE, LLC, CHICAGO, IL. FILED 10-16-2006.

CLASS 14—JEWELRY

FOR JEWELRY AND WATCHES (U.S. CLS. 2, 27, 28 AND 50).

CLASS 15—MUSICAL INSTRUMENTS

FOR MUSICAL INSTRUMENTS, MUSICAL INSTRUMENTS ACCESSORIES, NAMELY, GUITAR CABLES, GUITAR PICKS, GUITAR STRAPS, MUSICAL INSTRUMENT STANDS (U.S. CLS. 2, 21 AND 36).

CLASS 16—PAPER GOODS AND PRINTED MATTER

FOR POSTERS; FOLD-OUT POSTER BOOKS; POSTCARDS; MOUNTED AND UNMOUNTED PHOTOGRAPHS AND PHOTOGRAPHIC PRINTS; NEWSLETTERS IN THE FIELD OF MUSIC AND ENTERTAINMENT; STICKERS; CALENDARS; DECALS AND TEMPORARY TATTOOS; PRINTED CONCERT TICKETS; PRINTED BACKSTAGE PASSES; TRADING CARDS; BOOKS, TRIVIA BOOKS, TOUR BOOKS, COMIC BOOKS, PICTURE BOOKS, MAGAZINES, ALL IN THE FIELD OF MUSIC AND ENTERTAINMENT; TABLATURE BOOKS; SHEET MUSIC BOOKS; BOOK COVERS (U.S. CLS. 2, 5, 22, 23, 29, 37, 38 AND 50).

CLASS 25—CLOTHING

FOR CLOTHING, NAMELY, SHORTS; CAPS; HATS; JERSEYS; BLOUSES; SHIRTS; TANK-TOPS; T-SHIRTS, NAMELY, LONG SLEEVE AND SHORT SLEEVE T-SHIRTS; POLO SHIRTS; WOVEN AND KNIT SHIRTS; THERMAL SHIRTS; SWEATERS; JOGGING AND WARM-UP SUITS; SWEAT SHIRTS; SWEAT PANTS; SWEAT BANDS; HEADBANDS; BANDANAS; JEANS; PANTS; TIES; JACKETS; GLOVES; SCARVES; NECKWEAR (U.S. CLS. 22 AND 39).

CLASS 41—EDUCATION AND ENTERTAINMENT

FOR ENTERTAINMENT SERVICES, NAMELY, LIVE PERFORMANCES AND APPEARANCES BY A VOCAL AND INSTRUMENTAL GROUP, AND LIVE PERFORMANCES AND APPEARANCES FEATURING PRERECORDED MUSIC BY A VOCAL AND INSTRUMENTAL GROUP; FAN CLUB SERVICES; PROVIDING A WEBSITE FEATURING ENTERTAINMENT INFORMATION, NAMELY REVIEWS, ARTICLES, INTERVIEWS, MUSIC VIDEOS, MUSIC CHARTS, PERSONAL BIOGRAPHIES, DIARIES, INFORMATION ON MUSIC INSTRUMENTS, TOUR DATES, GAMES, TRIVIA, ACCESS TO MEMORABILIA, PHOTOGRAPHS, VIDEO CLIPS, AND AUDIO CLIPS, ALL AVAILABLE VIA A GLOBAL COMPUTER NETWORK (U.S. CLS. 100, 101 AND 107).

DANIEL RUSSELL, EXAMINING ATTORNEY

GREEN EXCHANGE

THE MARK CONSISTS OF STANDARD CHARACTERS WITHOUT CLAIM TO ANY PARTICULAR FONT, STYLE, SIZE, OR COLOR.

NO CLAIM IS MADE TO THE EXCLUSIVE RIGHT TO USE "EXCHANGE", APART FROM THE MARK AS SHOWN.

CLASS 35—ADVERTISING AND BUSINESS

FOR DISSEMINATION OF ADVERTISING FOR OTHERS VIA THE INTERNET AND OTHER MEDIA (U.S. CLS. 100, 101 AND 102).

FIRST USE 11-15-2006; IN COMMERCE 11-15-2006.

CLASS 36—INSURANCE AND FINANCIAL

FOR REAL ESTATE SERVICES, NAMELY, LISTING, LEASING AND MANAGING COMMERCIAL AND RESIDENTIAL PROPERTY (U.S. CLS. 100, 101 AND 102).

FIRST USE 11-15-2006; IN COMMERCE 11-15-2006.

MICHELE SWAIN, EXAMINING ATTORNEY

SN 77-022,708. DENIHAN OWNERSHIP COMPANY, LLC, NEW YORK, NY. FILED 10-17-2006.

DREAM DOG

THE MARK CONSISTS OF STANDARD CHARACTERS WITHOUT CLAIM TO ANY PARTICULAR FONT, STYLE, SIZE, OR COLOR.

NO CLAIM IS MADE TO THE EXCLUSIVE RIGHT TO USE "DOG", APART FROM THE MARK AS SHOWN.

CLASS 35—ADVERTISING AND BUSINESS

FOR REFERRALS IN THE FIELDS OF TAXI TRANSPORT, PET CARE, DOG WALKING, PET GROOMING, PET PSYCHIC AND PET SITTING FOR HOTEL GUESTS (U.S. CLS. 100, 101 AND 102).

FIRST USE 10-27-2006; IN COMMERCE 10-27-2006.

CLASS 43—HOTEL AND RESTAURANT SERVICES

FOR PET DAY CARE SERVICES FOR HOTEL GUESTS (U.S. CLS. 100 AND 101).

FIRST USE 10-27-2006; IN COMMERCE 10-27-2006.

IRA J. GOODSaid, EXAMINING ATTORNEY

SN 77-023,886. WHITEPAGES.COM, INC., SEATTLE, WA.
FILED 10-18-2006.

OWNER OF U.S. REG. NOS. 3,078,920 AND 3,089,615.
NO CLAIM IS MADE TO THE EXCLUSIVE RIGHT TO USE "WHITEPAGES.COM", APART FROM THE MARK AS SHOWN.

THE COLOR(S) PURPLE, WHITE AND TURQUOISE IS/ARE CLAIMED AS A FEATURE OF THE MARK.

THE MARK CONSISTS OF THE LETTERING WHITE-PAGES.COM IN WHITE OUTLINED IN PURPLE WITH THE PERIOD IN TURQUOISE.

CLASS 35—ADVERTISING AND BUSINESS

FOR ON-LINE DIRECTORY INFORMATION SERVICES; ON-LINE TELEPHONE DIRECTORY INFORMATION SERVICES; ON-LINE MOBILE TELEPHONE DIRECTORY INFORMATION SERVICES; ON-LINE ELECTRONIC MAIL ADDRESS DIRECTORY INFORMATION SERVICES; PROVISION AND RENTAL OF ON-LINE ADVERTISING SPACE (U.S. CLS. 100, 101 AND 102).

CLASS 38—COMMUNICATION

FOR E-MAIL SERVICES; E-MAIL FORWARDING SERVICES (U.S. CLS. 100, 101 AND 104).

CLASS 42—SCIENTIFIC AND COMPUTER SERVICES

FOR PROVIDING TEMPORARY USE OF NON-DOWNLOADABLE COMPUTER SOFTWARE FOR RETRIEVING DIRECTORY DATA CONTAINED IN A DATABASE IN THE FIELDS OF TELEPHONE DIRECTORY ASSISTANCE AND BUSINESS AND PERSONAL CONTACT INFORMATION; PROVIDING TEMPORARY USE OF NON-DOWNLOADABLE COMPUTER SOFTWARE THAT SUPPLIES BUSINESSES AND INDIVIDUALS WITH INFORMATION OBTAINED THROUGH INVESTIGATION OF PUBLIC RECORDS AND PUBLICLY AVAILABLE DATA (U.S. CLS. 100 AND 101).

LESLEY LAMOTHE, EXAMINING ATTORNEY

SN 77-023,917. WHITEPAGES.COM, INC., SEATTLE, WA.
FILED 10-18-2006.

OWNER OF U.S. REG. NOS. 3,078,920 AND 3,089,615.
NO CLAIM IS MADE TO THE EXCLUSIVE RIGHT TO USE "WHITEPAGES.COM", APART FROM THE MARK AS SHOWN.

THE COLOR(S) PURPLE, WHITE AND TURQUOISE IS/ARE CLAIMED AS A FEATURE OF THE MARK.

THE MARK CONSISTS OF THE LETTERING WHITE-PAGES.COM IN WHITE OUTLINED IN PURPLE AND THE LETTERING SEARCH. FIND. CONNECT. AND AN ADDITIONAL PERIOD IN TURQUOISE.

CLASS 35—ADVERTISING AND BUSINESS

FOR ON-LINE DIRECTORY INFORMATION SERVICES; ON-LINE TELEPHONE DIRECTORY INFORMATION SERVICES; ON-LINE MOBILE TELEPHONE DIRECTORY INFORMATION SERVICES; ON-LINE ELECTRONIC MAIL ADDRESS DIRECTORY INFORMATION SERVICES; PROVISION AND RENTAL OF ON-LINE ADVERTISING SPACE (U.S. CLS. 100, 101 AND 102).

CLASS 38—COMMUNICATION

FOR E-MAIL SERVICES; E-MAIL FORWARDING SERVICES (U.S. CLS. 100, 101 AND 104).

CLASS 42—SCIENTIFIC AND COMPUTER SERVICES

FOR PROVIDING TEMPORARY USE OF NON-DOWNLOADABLE COMPUTER SOFTWARE FOR RETRIEVING DIRECTORY DATA CONTAINED IN A DATABASE IN THE FIELDS OF TELEPHONE DIRECTORY ASSISTANCE AND BUSINESS AND PERSONAL CONTACT INFORMATION; PROVIDING TEMPORARY USE OF NON-DOWNLOADABLE COMPUTER SOFTWARE THAT SUPPLIES BUSINESSES AND INDIVIDUALS WITH INFORMATION OBTAINED THROUGH INVESTIGATION OF PUBLIC RECORDS AND PUBLICLY AVAILABLE DATA (U.S. CLS. 100 AND 101).

LESLEY LAMOTHE, EXAMINING ATTORNEY

SN 77-024,179. JUST ADD LLC, NEWBERG, OR. FILED 10-18-2006.

THE MARK CONSISTS OF STANDARD CHARACTERS WITHOUT CLAIM TO ANY PARTICULAR FONT, STYLE, SIZE, OR COLOR.

CLASS 25—CLOTHING

FOR BERMUDA SHORTS; CAPS; KNIT SHIRTS; OPEN-NECKED SHIRTS; POLO SHIRTS; SHIRTS; SHOES; SHORT SETS; SHORT-SLEEVED OR LONG-SLEEVED T-SHIRTS; SHORT-SLEEVED SHIRTS; SHORTS; SPORT SHIRTS; SPORTS SHIRTS; SWEAT SHIRTS; T-SHIRTS; TOPS; WALKING SHORTS (U.S. CLS. 22 AND 39).

CLASS 35—ADVERTISING AND BUSINESS

FOR ADVERTISING AND MARKETING; ADVERTISING AND PUBLICITY SERVICES, NAMELY, PROMOTING THE GOODS, SERVICES, BRAND IDENTITY AND COMMERCIAL INFORMATION AND NEWS OF THIRD PARTIES THROUGH PRINT, AUDIO, VIDEO, DIGITAL AND ON-LINE MEDIUM; ADVERTISING, INCLUDING PROMOTION OF PRODUCTS AND SERVICES OF THIRD PARTIES THROUGH SPONSORING ARRANGEMENTS AND LICENCE AGREEMENTS RELATING TO INTERNATIONAL SPORTS' EVENTS; ADVERTISING, MARKETING AND PROMOTION SERVICES (U.S. CLS. 100, 101 AND 102).

JESSICA A. POWERS, EXAMINING ATTORNEY

SN 77-024,531. STREAMLINE FOR LIFE LLC, ANN ARBOR, MI. FILED 10-19-2006.

MET-REV

THE MARK CONSISTS OF STANDARD CHARACTERS WITHOUT CLAIM TO ANY PARTICULAR FONT, STYLE, SIZE, OR COLOR.

CLASS 9—ELECTRICAL AND SCIENTIFIC APPARATUS

FOR PRE-RECORDED CDS, VIDEO TAPES, DVD'S FEATURING INFORMATION RELATING TO ENERGY, STRENGTH, MUSCLE TONE, PHYSICAL ACTIVITY, METABOLISM, WEIGHT LOSS, AND HEALTH AND FITNESS LEVELS; PERSONAL MONITOR DEVICES FOR TRACKING EXERCISE, NUTRITION, HUMAN ENERGY/METABOLISM ENHANCEMENTS, AND WEIGHT LOSS ACTIONS USING MANUAL OR ELECTRONIC CONTROLS TO IMPROVE ATTENTION TO ENERGY, METABOLISM, WEIGHT LOSS, HEALTH, AND FITNESS LEVELS, SOLD TOGETHER WITH INSTRUCTION SHEETS AND SCORECARDS AS A UNIT (U.S. CLS. 21, 23, 26, 36 AND 38).

CLASS 16—PAPER GOODS AND PRINTED MATTER

FOR PRINTED PUBLICATIONS, NAMELY, BOOKS, MAGAZINES, BROCHURES, BOOKLETS, PAMPHLETS, WRITTEN ARTICLES, SCORECARDS, INDEX CARDS, FLASH CARDS, PAGES, MENUS, WORKSHEETS, AND ACTIVITY SHEETS, IN THE FIELD OF PERSONAL PHYSICAL ENERGY, STRENGTH, MUSCLE TONE, PHYSICAL ACTIVITY, METABOLISM, WEIGHT LOSS, AND HEALTH AND FITNESS LEVELS (U.S. CLS. 2, 5, 22, 23, 29, 37, 38 AND 50).

CLASS 41—EDUCATION AND ENTERTAINMENT

FOR PHYSICAL FITNESS INSTRUCTION AND CONSULTATION; EDUCATIONAL SERVICES, NAMELY, PROVIDING A WEBSITE FEATURING INFORMATION RELATING TO PHYSICAL FITNESS, PHYSICAL STRENGTH, MUSCLE TONE, PHYSICAL EXERCISE, AND PERSONAL PHYSICAL FITNESS LEVEL; EDUCATIONAL SERVICES, NAMELY, CONDUCTING ON-LINE DISPLAYS AND INTERACTIVE EXHIBITS IN THE FIELDS OF PERSONAL PHYSICAL ENERGY, STRENGTH, MUSCLE TONE, PHYSICAL ACTIVITY, METABOLISM, WEIGHT LOSS, AND HEALTH AND FITNESS LEVELS (U.S. CLS. 100, 101 AND 107).

CLASS 42—SCIENTIFIC AND COMPUTER SERVICES

FOR PROVIDING TEMPORARY USE OF ONLINE NON DOWNLOADABLE COMMUNICATIONS SOFTWARE TO ALLOW USERS ACCESS TO INFORMATION RELATING TO PERSONAL PHYSICAL ENERGY, STRENGTH, MUSCLE TONE, PHYSICAL ACTIVITY, METABOLISM, WEIGHT LOSS, AND HEALTH AND FITNESS LEVELS BY LAPTOP COMPUTERS, DESKTOP COMPUTERS, WRISTWATCHES, MOBILE PHONES, OR PERSONAL DIGITAL ASSISTANTS (U.S. CLS. 100 AND 101).

CLASS 44—MEDICAL, BEAUTY AND AGRICULTURAL SERVICES

FOR EDUCATIONAL SERVICES, NAMELY, PROVIDING A WEBSITE FEATURING INFORMATION IN THE FIELDS OF PERSONAL PHYSICAL ENERGY, METABOLISM, WEIGHT LOSS, AND PERSONAL HEALTH LEVEL, ALL AS IT RELATES TO A PERSON'S PHYSICAL HEALTH (U.S. CLS. 100 AND 101).

JASON BLAIR, EXAMINING ATTORNEY

SN 77-025,980. ARAMARK CORPORATION, PHILADELPHIA, PA. FILED 10-20-2006.

GREEN THREAD

THE MARK CONSISTS OF STANDARD CHARACTERS WITHOUT CLAIM TO ANY PARTICULAR FONT, STYLE, SIZE, OR COLOR.

NO CLAIM IS MADE TO THE EXCLUSIVE RIGHT TO USE GREEN, APART FROM THE MARK AS SHOWN.

CLASS 35—ADVERTISING AND BUSINESS

FOR MARKETING PROGRAM, NAMELY PROMOTING THE PUBLIC AWARENESS OF ENVIRONMENTALLY CONSCIOUS ACTIVITIES USED AND IMPLEMENTED IN THE PROVISION OF RESTAURANT SERVICES, BUILDING MAINTENANCE AND REPAIR SERVICES, JANITORIAL AND CLEANING SERVICES, WASTE MANAGEMENT AND RECYCLING SERVICES, GROUNDS MAINTENANCE AND LANDSCAPING SERVICES, BUILDING DESIGN SERVICES, AND ENERGY MANAGEMENT SERVICES; ENERGY USAGE MANAGEMENT SERVICES (U.S. CLS. 100, 101 AND 102).

CLASS 37—CONSTRUCTION AND REPAIR

FOR BUILDING MAINTENANCE AND REPAIR SERVICES; JANITORIAL AND CLEANING SERVICES (U.S. CLS. 100, 103 AND 106).

CLASS 40—MATERIAL TREATMENT

FOR WASTE MANAGEMENT AND RECYCLING SERVICES (U.S. CLS. 100, 103 AND 106).

CLASS 42—SCIENTIFIC AND COMPUTER SERVICES

FOR ARCHITECTURAL BUILDING DESIGN SERVICES (U.S. CLS. 100 AND 101).

CLASS 43—HOTEL AND RESTAURANT SERVICES

FOR RESTAURANT SERVICES (U.S. CLS. 100 AND 101).

CLASS 44—MEDICAL, BEAUTY AND AGRICULTURAL SERVICES

FOR LANDSCAPING AND GROUNDS MAINTENANCE SERVICES, NAMELY, GRASS CUTTING, HEDGE TRIMMING, TREE AND PLANT REMOVAL, AND TREE AND PLANT INSTALLATION (U.S. CLS. 100 AND 101).

MARILYN IZZI, EXAMINING ATTORNEY

SN 77-026,556. ARROWHEAD MEADOWS, LLC, PHOENIX, AZ. FILED 10-21-2006.

SN 77-031,402. YOUNG PRESIDENT'S ORGANIZATION, IRVING, TX. FILED 10-27-2006.

Tails

THE MARK CONSISTS OF STANDARD CHARACTERS WITHOUT CLAIM TO ANY PARTICULAR FONT, STYLE, SIZE, OR COLOR.

CLASS 35—ADVERTISING AND BUSINESS

FOR FRANCHISING, NAMELY, OFFERING TECHNICAL ASSISTANCE IN THE ESTABLISHMENT AND/OR OPERATION OF THEMED RESTAURANTS, BARS, SPORTS THEMED BARS, HOTELS; MAIL ORDER CATALOG SERVICES FEATURING TRADEMARK IDENTIFIED CLOTHING; MANAGEMENT OF AN AIRLINE COMPANY; RESTAURANT FRANCHISING; RETAIL CLOTHING BOUTIQUES; RETAIL CLOTHING STORES (U.S. CLS. 100, 101 AND 102).

CLASS 43—HOTEL AND RESTAURANT SERVICES

FOR HOTEL, BAR AND RESTAURANT SERVICES (U.S. CLS. 100 AND 101).
RICHARD A. STRASER, EXAMINING ATTORNEY

SN 77-027,602. SYSONIC USA, INC., DOWNEY, CA. FILED S.R. 10-23-2006; AM. P.R. 8-3-2007.



THE MARK CONSISTS OF 01.05.25 - SUN, OTHER REPRESENTATIONS OF THE SUN.

CLASS 12—VEHICLES

FOR AUTOMOBILE ACCESSORIES AND EQUIPMENT, NAMELY, FITTED VEHICLE CARGO AREA LINERS, CARGO CARRIERS, CARGO RACK, FITTED AUTOMOBILE COVERS, VEHICLE SEATS, STEERING WHEELS, STEERING WHEEL COVERS, SEAT BELTS, SEAT BELT PADS, VEHICLE SEAT COVERS (U.S. CLS. 19, 21, 23, 31, 35 AND 44).
FIRST USE 11-20-2005; IN COMMERCE 5-30-2006.

CLASS 27—FLOOR COVERINGS

FOR MATS, NAMELY, FLOOR MATS FOR VEHICLES (U.S. CLS. 19, 20, 37, 42 AND 50).
FIRST USE 11-20-2005; IN COMMERCE 12-1-2005.
MICHAEL SOUDERS, EXAMINING ATTORNEY



THE COLOR(S) THE COLORS BLUE, WHITE, AND YELLOW ARE CLAIMED AS A FEATURE OF THE MARK IS/ARE CLAIMED AS A FEATURE OF THE MARK.

THE MARK CONSISTS OF A SERIES OF BLUE, AND WHITE TRIANGLES ARRANGED INSIDE ONE ANOTHER TO FORM A LARGER TRIANGLE, WITH A YELLOW TRIANGLE IN THE MIDDLE.

CLASS 16—PAPER GOODS AND PRINTED MATTER

FOR PRINTED INSTRUCTIONAL, EDUCATIONAL, AND TEACHING MATERIALS IN THE FIELD OF BUSINESS MANAGEMENT AND IN THE FIELD OF COMBINING BUSINESS LEADERSHIP WITH COMMUNITY, FAMILY AND PERSONAL INTERESTS (U.S. CLS. 2, 5, 22, 23, 29, 37, 38 AND 50).
FIRST USE 7-4-2001; IN COMMERCE 7-4-2001.

CLASS 35—ADVERTISING AND BUSINESS

FOR ASSOCIATION SERVICES, NAMELY, PROMOTING THE INTERESTS OF BUSINESS EXECUTIVES, BY THE PROMOTION OF THE EXCHANGE OF IDEAS AMONG BUSINESS EXECUTIVES THROUGH ARRANGING MEETINGS, MEMBER DIRECTORIES AND TAPES AND PUBLICATIONS FEATURING MEMBERS' IDEA EXCHANGE (U.S. CLS. 100, 101 AND 102).
FIRST USE 7-4-2001; IN COMMERCE 7-4-2001.

CLASS 41—EDUCATION AND ENTERTAINMENT

FOR EDUCATIONAL SERVICES, NAMELY, OFFERING LECTURES, RETREATS, CONFERENCES, COURSES AND SEMINARS ON THE SUBJECTS OF BUSINESS MANAGEMENT, AND COMBINING BUSINESS LEADERSHIP WITH COMMUNITY, FAMILY, AND PERSONAL INTERESTS (U.S. CLS. 100, 101 AND 107).
FIRST USE 7-4-2001; IN COMMERCE 7-4-2001.
GRETTA YAO, EXAMINING ATTORNEY

SN 77-036,814. THE TRADA GROUP, LLC, SAN FRANCISCO, CA. FILED 11-3-2006.



THE MARK CONSISTS OF WORD MARK PLUS UPWARD POINTING ARROW.

CLASS 35—ADVERTISING AND BUSINESS

FOR REAL ESTATE AND PROPERTY MANAGEMENT MARKETING OF MULTI-UNIT RESIDENTIAL PROJECTS (U.S. CLS. 100, 101 AND 102).

FIRST USE 5-1-2006; IN COMMERCE 5-1-2003.

CLASS 36—INSURANCE AND FINANCIAL

FOR REAL ESTATE PROPERTY MANAGEMENT AND REAL ESTATE FINANCING SERVICES (U.S. CLS. 100, 101 AND 102).

FIRST USE 11-1-2005; IN COMMERCE 11-1-2005.

CLASS 37—CONSTRUCTION AND REPAIR

FOR REAL ESTATE DEVELOPMENT AND CONSTRUCTION SERVICES, NAMELY, LAND DEVELOPMENT, CONSTRUCTION, REPAIR AND RENOVATION OF RESIDENTIAL BUILDINGS (U.S. CLS. 100, 103 AND 106).

FIRST USE 5-1-2003; IN COMMERCE 5-1-2003.

ROBIN CHOSID, EXAMINING ATTORNEY

SN 77-037,864. STORMFÄGELN AB, STOCKHOLM, SWEDEN, FILED 11-6-2006.



THE ENGLISH TRANSLATION OF THE WORD "STORMFÄGELN" IN THE MARK IS "STORM BIRD".

CLASS 12—VEHICLES

FOR BOATS AND SHIPS (U.S. CLS. 19, 21, 23, 31, 35 AND 44).

CLASS 37—CONSTRUCTION AND REPAIR

FOR CUSTOM SHIPBUILDING (U.S. CLS. 100, 103 AND 106).

CLASS 42—SCIENTIFIC AND COMPUTER SERVICES

FOR PRODUCT DEVELOPMENT OF SHIPS AND HULLS AND PROPELLORS FOR SHIPS (U.S. CLS. 100 AND 101).

H. M. FISHER, EXAMINING ATTORNEY

SN 77-039,637. KULITE SEMICONDUCTOR PRODUCTS, INC., LEONIA, NJ. FILED 11-8-2006.



OWNER OF U.S. REG. NO. 2,255,282.

CLASS 9—ELECTRICAL AND SCIENTIFIC APPARATUS

FOR PRESSURE TRANSDUCERS, ACCELEROMETERS AND MICROPHONES; ELECTRONIC CIRCUITRY FOR PRESSURE TRANSDUCERS, ACCELEROMETERS AND MICROPHONES; PRESSURE TRANSDUCERS WITH INTEGRATED ELECTRONIC CIRCUITRY; ACCELEROMETERS WITH INTEGRATED ELECTRONIC CIRCUITRY; MICROPHONES WITH INTEGRATED ELECTRONIC CIRCUITRY (U.S. CLS. 21, 23, 26, 36 AND 38).

FIRST USE 1-31-1950; IN COMMERCE 1-31-1950.

CLASS 40—MATERIAL TREATMENT

FOR CUSTOM MANUFACTURE OF PRESSURE TRANSDUCERS, ACCELEROMETERS AND MICROPHONES, ELECTRONIC CIRCUITRY FOR PRESSURE TRANSDUCERS, ACCELEROMETERS AND MICROPHONES, PRESSURE TRANSDUCERS WITH INTEGRATED ELECTRONIC CIRCUITRY, ACCELEROMETERS WITH INTEGRATED ELECTRONIC CIRCUITRY, AND MICROPHONES WITH INTEGRATED ELECTRONIC CIRCUITRY, FOR OTHERS (U.S. CLS. 100, 103 AND 106).

FIRST USE 1-31-1950; IN COMMERCE 1-31-1950.

KEVON CHISOLM, EXAMINING ATTORNEY

SN 77-039,684. KULITE SEMICONDUCTOR PRODUCTS, INC., LEONIA, NJ. FILED 11-8-2006.

KULITE

THE MARK CONSISTS OF STANDARD CHARACTERS WITHOUT CLAIM TO ANY PARTICULAR FONT, STYLE, SIZE, OR COLOR.

OWNER OF U.S. REG. NO. 2,255,282.

CLASS 9—ELECTRICAL AND SCIENTIFIC APPARATUS

FOR PRESSURE TRANSDUCERS, ACCELEROMETERS AND MICROPHONES; ELECTRONIC CIRCUITRY FOR PRESSURE TRANSDUCERS, ACCELEROMETERS AND MICROPHONES; PRESSURE TRANSDUCERS WITH INTEGRATED ELECTRONIC CIRCUITRY; ACCELEROMETERS WITH INTEGRATED ELECTRONIC CIRCUITRY; MICROPHONES WITH INTEGRATED ELECTRONIC CIRCUITRY (U.S. CLS. 21, 23, 26, 36 AND 38).

FIRST USE 1-31-1950; IN COMMERCE 1-31-1950.

CLASS 40—MATERIAL TREATMENT

FOR CUSTOM MANUFACTURE OF PRESSURE TRANSDUCERS, ACCELEROMETERS AND MICROPHONES, ELECTRONIC CIRCUITRY FOR PRESSURE TRANSDUCERS, ACCELEROMETERS AND MICROPHONES, PRESSURE TRANSDUCERS WITH INTEGRATED ELECTRONIC CIRCUITRY, ACCELEROMETERS WITH INTEGRATED ELECTRONIC CIRCUITRY, AND MICROPHONES WITH INTEGRATED ELECTRONIC CIRCUITRY, FOR OTHERS (U.S. CLS. 100, 103 AND 106).

FIRST USE 1-31-1950; IN COMMERCE 1-31-1950.

KEVON CHISOLM, EXAMINING ATTORNEY

SN 77-040,417. BANSHEE MUSIC, LLC, NEW BERLIN, WI. FILED 11-9-2006.

SN 77-041,217. LANCOME PARFUMS ET BEAUTE & CIE, PARIS, FRANCE, FILED 11-10-2006.

BANSHEE MUSIC

THE MARK CONSISTS OF STANDARD CHARACTERS WITHOUT CLAIM TO ANY PARTICULAR FONT, STYLE, SIZE, OR COLOR.

NO CLAIM IS MADE TO THE EXCLUSIVE RIGHT TO USE "MUSIC", APART FROM THE MARK AS SHOWN.

CLASS 35—ADVERTISING AND BUSINESS

FOR PERSONAL AND BUSINESS MANAGEMENT CONSULTING SERVICES; AND PROMOTING THE SERVICES OF OTHERS IN THE FIELDS OF MUSIC ARTISTS, MUSIC GROUPS AND LIVE MUSICAL PERFORMERS (U.S. CLS. 100, 101 AND 102).

CLASS 41—EDUCATION AND ENTERTAINMENT

FOR MUSIC PUBLISHING SERVICES; AND SONG-WRITING SERVICES (U.S. CLS. 100, 101 AND 107).
ALEXANDER L. POWERS, EXAMINING ATTORNEY

SN 77-040,925. RF MONOLITHICS, INC., DALLAS, TX. FILED 11-9-2006.

SOLUTIONS
DRIVEN/TECHNOLOGY ENABLED

THE MARK CONSISTS OF STANDARD CHARACTERS WITHOUT CLAIM TO ANY PARTICULAR FONT, STYLE, SIZE, OR COLOR.

CLASS 40—MATERIAL TREATMENT

FOR CUSTOM MANUFACTURE OF WIRELESS COMPUTER SYSTEMS TO THE ORDER AND SPECIFICATION OF OTHERS (U.S. CLS. 100, 103 AND 106).

CLASS 42—SCIENTIFIC AND COMPUTER SERVICES

FOR DEVELOPMENT AND DESIGN OF CUSTOM OR CUSTOMIZED HARDWARE AND SOFTWARE FOR OTHERS IN THE FIELD OF WIRELESS SYSTEMS; DEVELOPMENT ENGINEERING SERVICES TO CREATE CUSTOM OR CUSTOMIZED HARDWARE AND SOFTWARE IN THE FIELD OF WIRELESS SYSTEMS; SYSTEM INTEGRATION IN THE FIELD OF WIRELESS SYSTEMS (U.S. CLS. 100 AND 101).
ALICE SUE CARRUTHERS, EXAMINING ATTORNEY

DERMSPECIALISTS CENTRE

THE MARK CONSISTS OF STANDARD CHARACTERS WITHOUT CLAIM TO ANY PARTICULAR FONT, STYLE, SIZE, OR COLOR.

PRIORITY CLAIMED UNDER SEC. 44(D) ON ERPNCMNTY TM OFC APPLICATION NO. 5456942, FILED 11-10-2006.

CLASS 3—COSMETICS AND CLEANING PREPARATIONS

FOR PERFUMERY PRODUCTS, NAMELY, PERFUMES, EAU DE COLOGNE, PERFUMED WATER, SKIN LOTIONS, SOAPS, BATH AND SHOWER FOAMING COMPOSITIONS AND GELS; COSMETICS, NAMELY, CREAMS, GELS, MILKS, POWDERS AND LOTIONS FOR THE FACE, THE BODY AND THE HANDS; MAKEUP PRODUCTS, NAMELY, MASCARA, EYE LINER, EYE SHADOW, EYEBROW PENCIL, LIPSTICKS, NAIL POLISH, BLUSH, FOUNDATION CREAMS AND POWDER, BODY DEODORANTS; SUN CARE PREPARATIONS, NAMELY, TANNING AND AFTER-SUN MILKS, GELS AND OILS; ESSENTIAL OILS FOR PERSONAL USE; GELS, SPRAYS AND BALMS FOR THE HAIR STYLING AND HAIR CARE; HAIR LACQUERS; SHAMPOOS, CONDITIONERS, TREATMENTS, SERUMS, MASQUES AND MOUSSE FOR THE HAIR (U.S. CLS. 1, 4, 6, 50, 51 AND 52).

CLASS 44—MEDICAL, BEAUTY AND AGRICULTURAL SERVICES

FOR PROVIDING CONSULTATION AND INFORMATION ABOUT BEAUTY, NAMELY, PROVIDING PERSONALIZED CONSULTATION AND ANALYSIS IN THE FIELD OF THE SELECTION OF THE MOST SUITABLE COSMETICS, TOILETRIES, PERFUMES AND BEAUTY TREATMENTS FOR INDIVIDUAL SKIN AND HAIR TYPES, SKIN AND HAIR COLOR AND BONE STRUCTURE (U.S. CLS. 100 AND 101).
JAMES GRIFFIN, EXAMINING ATTORNEY

SN 77-042,226. LUTHERAN FAMILY AND CHILDREN'S SERVICES OF MISSOURI, ST. LOUIS, MO. FILED 11-13-2006.



THE MARK CONSISTS OF THE WORDS "GET REAL WITH YOURSELF" SUPERIMPOSED ON TOP OF TWO HANDDRAWN SHADED CIRCLES.

CLASS 44—MEDICAL, BEAUTY AND AGRICULTURAL SERVICES

FOR PROVIDING A WEBSITE FEATURING INFORMATION, EDUCATION AND REFERRALS CONCERNING CHILDBIRTH, PREGNANCY, HEALTH AND MENTAL HEALTH ISSUES, INCLUDING PREGNANCY HEALTH ISSUES; COUNSELING IN THE FIELD OF UNPLANNED PREGNANCY (U.S. CLS. 100 AND 101).
FIRST USE 8-31-2006; IN COMMERCE 8-31-2006.

CLASS 45—PERSONAL AND LEGAL SERVICES

FOR COUNSELING IN THE FIELD OF ADOPTION (U.S. CLS. 100 AND 101).
FIRST USE 8-31-2006; IN COMMERCE 8-31-2006.
JAMES STEIN, EXAMINING ATTORNEY

SN 77-042,244. CITIGROUP INC., NEW YORK, NY. FILED 11-13-2006.

CITI FIELD

THE MARK CONSISTS OF STANDARD CHARACTERS WITHOUT CLAIM TO ANY PARTICULAR FONT, STYLE, SIZE, OR COLOR.

NO CLAIM IS MADE TO THE EXCLUSIVE RIGHT TO USE "FIELD", APART FROM THE MARK AS SHOWN.

CLASS 41—EDUCATION AND ENTERTAINMENT

FOR ORGANIZING SPORTS, RECREATIONAL, CULTURAL AND ENTERTAINMENT EVENTS FOR PUBLIC EXHIBITION (U.S. CLS. 100, 101 AND 107).

CLASS 43—HOTEL AND RESTAURANT SERVICES

FOR ARENA SERVICES, NAMELY, PROVIDING FACILITIES FOR SPORTS, CONCERTS, CONVENTIONS AND EXHIBITIONS (U.S. CLS. 100 AND 101).
ALYSSA PALADINO, EXAMINING ATTORNEY

SN 77-042,246. CITIGROUP INC., NEW YORK, NY. FILED 11-13-2006.

CITIFIELD

THE MARK CONSISTS OF STANDARD CHARACTERS WITHOUT CLAIM TO ANY PARTICULAR FONT, STYLE, SIZE, OR COLOR.

CLASS 41—EDUCATION AND ENTERTAINMENT

FOR ORGANIZING SPORTS, RECREATIONAL, CULTURAL AND ENTERTAINMENT EVENTS FOR PUBLIC EXHIBITION (U.S. CLS. 100, 101 AND 107).

CLASS 43—HOTEL AND RESTAURANT SERVICES

FOR ARENA SERVICES, NAMELY, PROVIDING FACILITIES FOR SPORTS, CONCERTS, CONVENTIONS AND EXHIBITIONS (U.S. CLS. 100 AND 101).
ALYSSA PALADINO, EXAMINING ATTORNEY

SN 77-042,397. TENUTO, JOHN P., WINTER PARK, FL. FILED 11-13-2006.

JOHN TENUTO AND THE BRIDGE
& THE PROPHET

THE MARK CONSISTS OF STANDARD CHARACTERS WITHOUT CLAIM TO ANY PARTICULAR FONT, STYLE, SIZE, OR COLOR.

THE NAME JOHN TENUTO IDENTIFIES A LIVING INDIVIDUAL WHOSE CONSENT IS OF RECORD.

CLASS 9—ELECTRICAL AND SCIENTIFIC APPARATUS

FOR COMPACT DISC CASES; MOUSE PADS; PRE-RECORDED CDS, VIDEO TAPES, LASER DISKS AND DVDS FEATURING MUSICAL PRODUCTIONS AND SONGS (U.S. CLS. 21, 23, 26, 36 AND 38).

CLASS 14—JEWELRY

FOR JEWELRY (U.S. CLS. 2, 27, 28 AND 50).

CLASS 16—PAPER GOODS AND PRINTED MATTER

FOR ADHESIVE LABELS; BOOKS IN THE FIELD OF POETRY, PHILOSOPHY AND MUSIC; CALENDARS; DRAWINGS; ENVELOPES; MAGAZINES FEATURING MUSIC GROUPS; NEWSLETTERS IN THE FIELD OF MUSIC GROUPS; PAINTINGS; PENS; PHOTOGRAPHS; POSTCARDS; POSTERS; PRINTED TICKETS; STICKERS (U.S. CLS. 2, 5, 22, 23, 29, 37, 38 AND 50).

CLASS 18—LEATHER GOODS

FOR BACKPACKS; FANNY PACKS (U.S. CLS. 1, 2, 3, 22 AND 41).

CLASS 21—HOUSEWARES AND GLASS

FOR CUPS (U.S. CLS. 2, 13, 23, 29, 30, 33, 40 AND 50).

CLASS 25—CLOTHING

FOR HATS; HEAD SCARVES; JACKETS; SHOES; SWEATERS; T-SHIRTS (U.S. CLS. 22 AND 39).

CLASS 41—EDUCATION AND ENTERTAINMENT

FOR ENTERTAINMENT NAMELY, LIVE PERFORMANCES BY A MUSICAL BAND; ENTERTAINMENT SERVICES, NAMELY, PROVIDING A WEB SITE FEATURING MUSICAL PERFORMANCES, MUSICAL VIDEOS, RELATED FILM CLIPS, PHOTOGRAPHS, AND OTHER MULTIMEDIA MATERIALS (U.S. CLS. 100, 101 AND 107).

JOHN E. MICHOS, EXAMINING ATTORNEY

SN 77-042,796. J. R. ANDORIN, INC., PINE BUSH, NY. FILED 11-13-2006.

NATURAL WELLNESS

THE MARK CONSISTS OF STANDARD CHARACTERS WITHOUT CLAIM TO ANY PARTICULAR FONT, STYLE, SIZE, OR COLOR.

OWNER OF U.S. REG. NO. 2,026,211.

NO CLAIM IS MADE TO THE EXCLUSIVE RIGHT TO USE "WELLNESS", APART FROM THE MARK AS SHOWN. SEC. 2(F).

CLASS 9—ELECTRICAL AND SCIENTIFIC APPARATUS

FOR PRERECORDED EDUCATIONAL VIDEOS, LASER DISKS, AUDIO CASSETTES, CDS, AND COMPUTER SOFTWARE ALL HAVING THE SUBJECT MATTER OF HOLISTIC HEALTH, INTEGRATIVE MEDICINE, NUTRITIONAL SUPPLEMENTS, ALTERNATIVE HEALING, PERSONAL AND PROFESSIONAL GROWTH AND DEVELOPMENT, PERSONAL WELLNESS, SPIRITUAL AND RELIGIOUS ISSUES, PSYCHOLOGICAL COUNSELING, FAMILY WELL-BEING, EDUCATION AND HOME-SCHOOLING ISSUES, LIFESTYLE ISSUES, AND HEALTHY FOODS (U.S. CLS. 21, 23, 26, 36 AND 38).

FIRST USE 6-10-1996; IN COMMERCE 6-10-1996.

CLASS 35—ADVERTISING AND BUSINESS

FOR RETAIL STORE SERVICES FEATURING AND MAIL ORDER CATALOG SERVICES FEATURING AUDIO AND VIDEO PRERECORDED CASSETTES, CDS, LASER DISKS, COMPUTER SOFTWARE, BOOKS, BOOKLETS, NEWSLETTERS, MAGAZINES, ALL HAVING THE SUBJECT MATTER OF HOLISTIC HEALTH, INTEGRATIVE MEDICINE, NUTRITIONAL SUPPLEMENTS, ALTERNATIVE HEALING, PERSONAL AND PROFESSIONAL GROWTH AND DEVELOPMENT, PERSONAL WELLNESS, SPIRITUAL AND RELIGIOUS ISSUES, PSYCHOLOGICAL COUNSELING, FAMILY WELL-BEING, EDUCATION AND HOME-SCHOOLING ISSUES, LIFESTYLE ISSUES, AND HEALTHY FOODS, HOMEOPATHIC REMEDIES, VITAMIN AND MINERAL NUTRITIONAL SUPPLEMENTS, HERBS AND HERBAL PREPARATIONS, SEA OR LAND PLANTS ESSENCES AND EXTRACTS, AND NATURAL AND SYNTHESIZED SUBSTANCES FOR MEDICINAL, HYGIENIC AND BEAUTY CARE PURPOSES, HOME DECORATING ACCESSORIES, HOUSEHOLD PRODUCTS, EDUCATIONAL GAMES AND PLAYTHINGS (U.S. CLS. 100, 101 AND 102).

FIRST USE 6-10-1996; IN COMMERCE 6-10-1996.

CLASS 41—EDUCATION AND ENTERTAINMENT

FOR ENTERTAINMENT IN THE NATURE OF A SERIES OF TELEVISION PROGRAMS DEALING WITH HOLISTIC HEALTH, INTEGRATIVE MEDICINE, NUTRITIONAL SUPPLEMENTS, ALTERNATIVE HEALING, PERSONAL AND PROFESSIONAL GROWTH AND DEVELOPMENT, PERSONAL WELLNESS, SPIRITUAL AND RELIGIOUS ISSUES, PSYCHOLOGICAL COUNSELING, FAMILY WELL-BEING, EDUCATION AND HOME-SCHOOLING ISSUES, LIFESTYLE ISSUES, AND HEALTHY FOODS; EDUCATIONAL SERVICES, NAMELY CONDUCTING WORKSHOPS, TRAINING SESSIONS, SEMINARS AND TEACHING CLASSES IN THE SUBJECT OF HOLISTIC HEALTH, INTEGRATIVE MEDICINE, ALTERNATIVE HEALING, PERSONAL AND PROFESSIONAL GROWTH AND DEVELOPMENT, PERSONAL WELLNESS, SPIRITUAL AND RELIGIOUS ISSUES, PSYCHOLOGICAL COUNSELING, FAMILY WELL-BEING, EDUCATION AND HOME-SCHOOLING ISSUES, LIFESTYLE ISSUES, AND HEALTHY FOODS, AND DISTRIBUTING PRINTED MATERIALS AND PRE-RECORDED MULTIMEDIA MATERIALS IN CONNECTION THEREWITH (U.S. CLS. 100, 101 AND 107).

FIRST USE 6-10-1996; IN COMMERCE 6-10-1996.

CLASS 44—MEDICAL, BEAUTY AND AGRICULTURAL SERVICES

FOR THE RENDERING OF MASSAGE SERVICES; PHYSICAL THERAPY; HYPNOTHERAPY; NATURAL HEALTH COUNSELING ON THERAPIES SUCH AS VITAMINS, MINERALS, NUTRITIONAL SUPPLEMENTS, NON-CONVENTIONAL MEDICINE REGARDING MASSAGE AND BODYWORK TREATMENTS, ORIENTAL MEDICINE, BIOFEEDBACK, MEDITATION AND VISUALIZATION; PSYCHOLOGICAL COUNSELING SERVICES; HEALTH SPA SERVICES FOR HEALTH AND WELLNESS OF THE BODY AND SPIRIT OFFERED AT HEALTH RESORT (U.S. CLS. 100 AND 101).

FIRST USE 6-10-1996; IN COMMERCE 6-10-1996.

STEPHANIE ALI, EXAMINING ATTORNEY

SN 77-043,253. FRENKEL INTERNATIONAL GROUP, INC., UNION, NJ. FILED 11-14-2006.

NATURE'S INTENT

THE MARK CONSISTS OF STANDARD CHARACTERS WITHOUT CLAIM TO ANY PARTICULAR FONT, STYLE, SIZE, OR COLOR.

CLASS 3—COSMETICS AND CLEANING PREPARATIONS

FOR BATH AND BODY PRODUCTS, NAMELY, BATH GEL, SHOWER GEL, BATH WASH, BODY LOTION, HAND LOTION, FOOT LOTION, BODY OIL, AROMATHERAPY OILS, AROMATHERAPY BEADS OR STONES, BATH PETALS, BATH BEADS, BATH CAVIAR, BODY BUTTER, COCOA BUTTER FOR COSMETIC PURPOSES, BODY TALC, BODY POWDER, BATH SALTS, BATH SOAK, FOOT SOAK, HAND SOAK, BODY SPRAY, BODY SPLASH, BODY SCRUB, MILK BATH, BUBBLE BATH, CREAM BATH, BATH SOAP, HAND SOAP, FOAM BATH, EFFERVESCENT BATH CRYSTALS, EFFERVESCENT BATH SALTS, BATH FIZZERS, MASSAGE OILS, GEL EYE MASK, SOOTHING EYE MASK, HERBAL EYE MASK, PUMICE STONE (U.S. CLS. 1, 4, 6, 50, 51 AND 52).

CLASS 8—HAND TOOLS

FOR BATH AND BODY PRODUCTS, NAMELY, MANICURE TOOLS, NAMELY, NAIL FILES, NAIL CLIPPERS, CUTICLE PUSHERS, TWEEZERS, NAIL AND CUTICLE SCISSORS, PEDICURE TOOLS, NAMELY, NAIL FILES, NAIL CLIPPERS, CUTICLE PUSHERS, TWEEZERS, NAIL AND CUTICLE SCISSORS (U.S. CLS. 23, 28 AND 44).

CLASS 20—FURNITURE AND ARTICLES NOT OTHERWISE CLASSIFIED

FOR FOAM TOE SEPARATORS FOR USE IN PEDICURES (U.S. CLS. 2, 13, 22, 25, 32 AND 50).

CLASS 21—HOUSEWARES AND GLASS

FOR BATH AND BODY PRODUCTS, NAMELY, BATH SPONGE, BACK SCRUBBER, SEA SPONGE, LOOFA SPONGE, COMPLEXION BRUSH, MESH SPONGE, NAIL BRUSH, LOOFA MITT (U.S. CLS. 2, 13, 23, 29, 30, 33, 40 AND 50).

CLASS 24—FABRICS

FOR BATH AND BODY PRODUCTS, NAMELY, BATH MITTS (U.S. CLS. 42 AND 50).

MICHAEL ENGEL, EXAMINING ATTORNEY

CLASS 42—SCIENTIFIC AND COMPUTER SERVICES

FOR COMPUTER COLOCATION SERVICES, NAMELY, PROVIDING CUSTOMERS WITH THE ABILITY TO LOCATE THEIR COMMUNICATIONS AND NETWORKING EQUIPMENT AT CARRIER POINT FACILITIES; COMPUTER NETWORK DESIGN SERVICES FOR OTHERS (U.S. CLS. 100 AND 101).

FIRST USE 10-11-2005; IN COMMERCE 10-11-2005.
KIMBERLY FRYE, EXAMINING ATTORNEY

SN 77-045,819. FLTI, LITTLE ROCK, AR. FILED 11-16-2006.

SN 77-044,317. FIBERNET TELECOM GROUP, INC., NEW YORK, NY. FILED 11-15-2006.



THE COLOR(S) GREEN AND GRAY IS/ARE CLAIMED AS A FEATURE OF THE MARK.

"THE MARK CONSISTS OF THE COLORS GREEN AND GRAY. THE COLOR GREEN APPEARS IN THE TOP CIRCLE AND THE BOTTOM CIRCLE IS GRAY. THE WHITE IN THE MARK REPRESENTS THE BACKGROUND AND IS NOT CLAIMED AS A FEATURE OF THE MARK."

CLASS 38—COMMUNICATION

FOR COMMUNICATIONS SERVICES, NAMELY, PROVIDING BROADBAND CONNECTIVITY FOR DATA, VOICE AND VIDEO TRANSMISSION ON ITS FIBER OPTIC NETWORKS IN MAJOR METROPOLITAN AREAS; PROVIDING ACCESS MANAGEMENT SERVICES, NAMELY, MANAGEMENT OF TELECOMMUNICATION NETWORKS IN BUILDINGS (U.S. CLS. 100, 101 AND 104).

FIRST USE 10-11-2005; IN COMMERCE 10-11-2005.

FAMILYLIFE GETAWAY

THE MARK CONSISTS OF STANDARD CHARACTERS WITHOUT CLAIM TO ANY PARTICULAR FONT, STYLE, SIZE, OR COLOR.

NO CLAIM IS MADE TO THE EXCLUSIVE RIGHT TO USE "GETAWAY", APART FROM THE MARK AS SHOWN.

CLASS 41—EDUCATION AND ENTERTAINMENT

FOR EDUCATIONAL SERVICES, NAMELY, ARRANGING AND CONDUCTING SEMINARS, CONFERENCES AND WORKSHOPS IN THE FIELDS OF RELIGION REGARDING THE BIBLE, RELIGIOUS AND CULTURAL ISSUES, VALUES AND THEMES (U.S. CLS. 100, 101 AND 107).

FIRST USE 10-3-1996; IN COMMERCE 10-3-1996.

CLASS 45—PERSONAL AND LEGAL SERVICES

FOR EVANGELISTIC AND MINISTERIAL SERVICES, NAMELY, CONDUCTING SPIRITUAL RETREATS TO ASSIST INDIVIDUALS TO DEVELOP AND ENHANCE THE SPIRITUAL LIVES OF THEMSELVES AND THEIR FAMILIES (U.S. CLS. 100 AND 101).

FIRST USE 10-3-1996; IN COMMERCE 10-3-1996.
GISELLE AGOSTO, EXAMINING ATTORNEY

SN 77-047,436. MUSIC CITY DIGITAL LLC, NASHVILLE, TN. FILED 11-19-2006.



THE COLOR(S) RED, BEIGE, BROWN, GOLD, AND GREEN IS/ARE CLAIMED AS A FEATURE OF THE MARK.

THE MARK CONSISTS OF THE WORDS GAMMA BLAST WHICH APPEAR IN THE COLOR RED, HIGHLIGHTED IN BEIGE AND GOLD; BETWEEN THE WORDING IS A CIRCULAR IMAGE OUTLINED IN THE COLORS GOLD AND GREEN WHICH CONTAINS A DEPICTION OF A MUSHROOM SHAPED CLOUD IN THE COLOR BEIGE, OUTLINED IN THE COLOR BROWN AND THERE IS A BROWN RING AROUND THE MIDDLE OF THE CLOUD. THE BACKGROUND INSIDE THE CIRCULAR IMAGE APPEARS IN TWO SHADES OF ALTERNATING GREEN.

CLASS 40—MATERIAL TREATMENT

FOR DUPLICATION OF AUDIO TAPES; DUPLICATION OF TAPE RECORDINGS; DUPLICATION OF VIDEO CASSETTES; DUPLICATION OF VIDEO TAPES (U.S. CLS. 100, 103 AND 106).

FIRST USE 11-17-2006; IN COMMERCE 11-17-2006.

CLASS 41—EDUCATION AND ENTERTAINMENT

FOR PRODUCTION OF SOUND AND MUSIC VIDEO RECORDINGS; AUDIO RECORDING AND PRODUCTION; EDITING OR RECORDING OF SOUNDS AND IMAGES; PRODUCTION OF CLOSED CAPTION TELEVISION PROGRAMS; PRODUCTION OF RADIO OR TELEVISION PROGRAMS; PRODUCTION OF VIDEO AND CREATION OF VISUAL EFFECTS FOR OTHERS FOR USE IN DVDS, TELEVISION PROGRAMS AND ON WEBSITES; TELEVISION POST PRODUCTION SERVICES; PRODUCTION OF VIDEO DISCS AND TAPES; PRODUCTION OF VISUAL EFFECTS FOR VIDEOS, DVDS, TELEVISION AND FOR INTERNET WEBSITES; TELEVISION PRODUCTION; VIDEO EDITING; VIDEO-TAPE PRODUCTION (U.S. CLS. 100, 101 AND 107).

FIRST USE 11-17-2006; IN COMMERCE 11-17-2006.

GEORGIA CARTY, EXAMINING ATTORNEY

SN 77-048,557. CHURCH, JUDITH L., NEW YORK, NY. FILED 11-21-2006.

GREEN SPRINGS CREATIONS

THE MARK CONSISTS OF STANDARD CHARACTERS WITHOUT CLAIM TO ANY PARTICULAR FONT, STYLE, SIZE, OR COLOR.

CLASS 42—SCIENTIFIC AND COMPUTER SERVICES

FOR PROVIDING INTERIOR DESIGN INFORMATION FEATURING HOME FURNISHING AND DESIGN OVER A GLOBAL COMPUTER NETWORK (U.S. CLS. 100 AND 101).

CLASS 43—HOTEL AND RESTAURANT SERVICES

FOR PROVIDING COOKING INFORMATION FEATURING RECIPES, AND DESIGNS, PLANS AND PROGRAMS FOR COOKING FOR HEALTHY LIVING OVER A GLOBAL COMPUTER NETWORK (U.S. CLS. 100 AND 101).

CLASS 44—MEDICAL, BEAUTY AND AGRICULTURAL SERVICES

FOR PROVIDING HEALTH AND NUTRITION INFORMATION FOR HEALTHY LIVING OVER A GLOBAL COMPUTER NETWORK (U.S. CLS. 100 AND 101).

KRISTINA MORRIS, EXAMINING ATTORNEY

SN 77-048,561. CHURCH, JUDITH L., NEW YORK, NY. FILED 11-21-2006.

MAKE THE BEST, BUILD THE BEST, BE THE BEST

THE MARK CONSISTS OF STANDARD CHARACTERS WITHOUT CLAIM TO ANY PARTICULAR FONT, STYLE, SIZE, OR COLOR.

CLASS 42—SCIENTIFIC AND COMPUTER SERVICES

FOR PROVIDING INTERIOR DESIGN INFORMATION FEATURING HOME FURNISHING AND DESIGN OVER A GLOBAL COMPUTER NETWORK (U.S. CLS. 100 AND 101).

CLASS 43—HOTEL AND RESTAURANT SERVICES

FOR PROVIDING COOKING INFORMATION FEATURING RECIPES, AND DESIGNS, PLANS AND PROGRAMS FOR COOKING FOR HEALTHY LIVING OVER A GLOBAL COMPUTER NETWORK (U.S. CLS. 100 AND 101).

CLASS 44—MEDICAL, BEAUTY AND AGRICULTURAL SERVICES

FOR PROVIDING HEALTH AND NUTRITION INFORMATION FOR HEALTHY LIVING OVER A GLOBAL COMPUTER NETWORK (U.S. CLS. 100 AND 101).

KRISTINA MORRIS, EXAMINING ATTORNEY

SN 77-051,088. VICTORIA'S SECRET STORES BRAND MANAGEMENT, INC., REYNOLDSBURG, OH. FILED 11-27-2006.

SWEET TEASE

THE MARK CONSISTS OF STANDARD CHARACTERS WITHOUT CLAIM TO ANY PARTICULAR FONT, STYLE, SIZE, OR COLOR.

CLASS 3—COSMETICS AND CLEANING PREPARATIONS

FOR PERSONAL CARE PRODUCTS, NAMELY, BODY LOTION, BODY WASH, EAU DE PARFUM SPRAY, MASSAGE OIL; HOME FRAGRANCE PRODUCTS, NAMELY, POTPOURRI, ROOM FRAGRANCE SPRAYS AND SACHETS (U.S. CLS. 1, 4, 6, 50, 51 AND 52).

CLASS 4—LUBRICANTS AND FUELS

FOR CANDLES (U.S. CLS. 1, 6 AND 15).
JENNY PARK, EXAMINING ATTORNEY

SN 77-052,396. EBA DESIGN, INC, TUSTIN, CA. FILED 11-28-2006.



NO CLAIM IS MADE TO THE EXCLUSIVE RIGHT TO USE "EUROPEAN BODY ART" AND "EUROPEANBODY-ART.COM", APART FROM THE MARK AS SHOWN.

THE COLOR(S) WHITE, BLUE AND BLACK IS/ARE CLAIMED AS A FEATURE OF THE MARK.

THE COLOR BLACK APPEARS IN SOME OF THE OUTLINES OF THE TRIBAL TATTOO DESIGN. THE COLOR WHITE APPEARS IN SOME OF THE OUTLINES OF THE TRIBAL TATTOO DESIGN, AND IN THE LETTERS EBA. THE COLOR DARK BLUE APPEARS IN THE WORDING EUROPEAN BODY ART, AND IN THE BACKGROUND OF THE RECTANGULAR DESIGN. THE COLOR MEDIUM BLUE APPEARS IN PORTIONS OF THE TRIBAL TATTOO DESIGN, IN PORTIONS OF THE LETTERS EBA, AND IN THE WORDING EUROPEANBODYART.COM.

THE MARK CONSISTS OF THE WORDING EUROPEAN BODY ART IN STYLIZED FORM, AND BELOW THIS A RECTANGLE WITH A TRIBAL TATTOO DESIGN INSIDE IT, AND THE LETTERS EBA IN THE LOWER LEFT HAND CORNER OF THE RECTANGLE. BELOW THE RECTANGLE IS THE WORDING EUROPEANBODYART.COM.

CLASS 16—PAPER GOODS AND PRINTED MATTER

FOR TEMPORARY TATTOOS (U.S. CLS. 2, 5, 22, 23, 29, 37, 38 AND 50).

CLASS 41—EDUCATION AND ENTERTAINMENT

FOR ENTERTAINMENT SERVICES, NAMELY, BODY PAINTING SERVICES HELD AT SPECIAL EVENTS (U.S. CLS. 100, 101 AND 107).
NANCY CLARKE, EXAMINING ATTORNEY

SN 77-052,646. NICOLA PIZZA, INC., REHOBETH BEACH, DE. FILED 11-29-2006.

TASTE OF THE FIRST STATE

THE MARK CONSISTS OF STANDARD CHARACTERS WITHOUT CLAIM TO ANY PARTICULAR FONT, STYLE, SIZE, OR COLOR.

NO CLAIM IS MADE TO THE EXCLUSIVE RIGHT TO USE "THE FIRST STATE", APART FROM THE MARK AS SHOWN.

CLASS 25—CLOTHING

FOR BATHING SUITS; BELTS; BLOUSES; CAPS; CLOTHING, NAMELY, WRAP-AROUNDS; COATS; DRESS SHIRTS; DRESS SUITS; DRESSES; GOLF SHIRTS; GYM SUITS; HEADBANDS AGAINST SWEATING; HOODS; JERSEYS; KNIT SHIRTS; LEATHER BELTS; MANTLES; MEN'S SUITS, WOMEN'S SUITS; MUFFLERS; OPEN-NECKED SHIRTS; POLO SHIRTS; SHIRTS; SHORT SETS; SKIRT SUITS; SKIRTS; SKIRTS AND DRESSES; SPORT SHIRTS; SUITS; SWEAT BANDS; SWEAT PANTS; SWEAT SHIRTS; SWEAT SHORTS; SWEAT SUITS; T-SHIRTS; TIES; TOPS; WRAPS (U.S. CLS. 22 AND 39).

CLASS 43—HOTEL AND RESTAURANT SERVICES

FOR CAFE-RESTAURANTS; CARRY-OUT RESTAURANTS; DELICATESSENS; FAST FOOD AND NON-STOP RESTAURANT SERVICES; FAST-FOOD RESTAURANTS; FAST-FOOD RESTAURANTS AND SNACK-BARS; RESTAURANT SERVICES; RESTAURANTS (U.S. CLS. 100 AND 101).

JAMES MACFARLANE, EXAMINING ATTORNEY

SN 77-052,942. INTERNATIONAL DATA GROUP, INC., FRAMINGHAM, MA. FILED 11-29-2006.

E4ALL

THE MARK CONSISTS OF STANDARD CHARACTERS WITHOUT CLAIM TO ANY PARTICULAR FONT, STYLE, SIZE, OR COLOR.

CLASS 16—PAPER GOODS AND PRINTED MATTER

FOR PRINT PUBLICATIONS, NAMELY, NEWSLETTERS, MAGAZINES AND SUPPLEMENTS IN THE FIELD OF VIDEO GAMES, INTERACTIVE ENTERTAINMENT AND RELATED PRODUCTS (U.S. CLS. 2, 5, 22, 23, 29, 37, 38 AND 50).

CLASS 35—ADVERTISING AND BUSINESS

FOR ADVERTISING SERVICES; ARRANGING AND CONDUCTING EVENTS, NAMELY, TRADE SHOWS, EXPOSITIONS AND EXHIBITIONS IN THE FIELD OF VIDEO GAMES, INTERACTIVE ENTERTAINMENT AND RELATED PRODUCTS; BUSINESS CONSULTATION (U.S. CLS. 100, 101 AND 102).

CLASS 41—EDUCATION AND ENTERTAINMENT

FOR ARRANGING AND CONDUCTING SEMINARS, CONFERENCES, SYMPOSIUMS, COLLOQUIUMS AND DISCUSSION GROUPS IN THE FIELD OF VIDEO GAMES, INTERACTIVE ENTERTAINMENT AND RELATED PRODUCTS (U.S. CLS. 100, 101 AND 107).

CLASS 42—SCIENTIFIC AND COMPUTER SERVICES

FOR PROVIDING A WEBSITE THAT FEATURES INFORMATION CONCERNING VIDEO GAMES, INTERACTIVE ENTERTAINMENT AND RELATED PRODUCTS; RESEARCH FOR OTHERS IN THE FIELD OF VIDEO GAMES, INTERACTIVE ENTERTAINMENT AND RELATED PRODUCTS (U.S. CLS. 100 AND 101).
BONNIE LUKEN, EXAMINING ATTORNEY

SN 77-053,783. INTELLIMAT, INC., ROANOKE, VA. FILED 11-30-2006.

LEVELMARKETING

THE MARK CONSISTS OF STANDARD CHARACTERS WITHOUT CLAIM TO ANY PARTICULAR FONT, STYLE, SIZE, OR COLOR.

CLASS 9—ELECTRICAL AND SCIENTIFIC APPARATUS

FOR DIGITAL SIGNAGE SYSTEMS AND RELATED EQUIPMENT, NAMELY, ELECTRIC SIGNS, ELECTRONIC DISPLAYS, CHANGEABLE ELECTRONIC ADVERTISING AND MESSAGE DISPLAY UNITS WITH STAND-ALONE CAPABILITIES, MULTI-NETWORKING CAPABILITIES, AND REMOTE CONNECTIVITY, LIQUID-CRYSTAL DISPLAYS, LIGHT EMITTING DIODE DISPLAYS, ELECTRONIC PAPER DISPLAYS, OPTICAL FIBER ARRAY DISPLAYS, CHANGEABLE ELECTRONIC DISPLAYS, CHANGEABLE ELECTRONIC ADVERTISING AND MESSAGE DISPLAY UNITS, SURROUNDS AND SUPPORTING STRUCTURES FOR DIGITAL SIGNAGE SYSTEMS, PORTABLE AND COMPACT COMPUTING DEVICES FOR OPERATING DIGITAL SIGNAGE SYSTEMS, AND PORTABLE AND COMPACT POWER SUPPLY UNITS FOR POWERING DIGITAL SIGNAGE SYSTEMS; WIRED AND WIRELESS NETWORKING SYSTEMS FOR DIGITAL SIGNAGE SYSTEMS AND CHANGEABLE ELECTRONIC ADVERTISING AND MESSAGE DISPLAY UNITS, NAMELY, COMPUTER HARDWARE AND SOFTWARE FOR OPERATING ELECTRONIC DISPLAYS AND DIGITAL SIGNAGE SYSTEMS, COMPUTER HARDWARE AND SOFTWARE FOR ADMINISTRATION AND OPERATION OF COMPUTER LOCAL AREA NETWORKS, COMPUTER NETWORKING HARDWARE AND NETWORK OPERATING SOFTWARE AND TELECOMMUNICATIONS AND NETWORKING HARDWARE, NAMELY, DEVICES FOR TRANSPORTING AND AGGREGATING AUDIO, DATA, AND VIDEO COMMUNICATIONS ACROSS MULTIPLE NETWORK INFRASTRUCTURES AND COMMUNICATIONS PROTOCOLS (U.S. CLS. 21, 23, 26, 36 AND 38).

CLASS 35—ADVERTISING AND BUSINESS

FOR OPERATION AND ADMINISTRATION OF DIGITAL SIGNAGE SYSTEMS FOR OTHERS, NAMELY, PROVIDING ADVERTISING SPACE BY ELECTRONIC MEANS AND GLOBAL COMPUTER INFORMATION NETWORKS; RETAIL STORE SERVICES FEATURING EQUIPMENT FOR DIGITAL SIGNAGE SYSTEMS (U.S. CLS. 100, 101 AND 102).

ROBIN CHOSID, EXAMINING ATTORNEY

SN 77-053,856. NASHVILLE CONVENTION & VISITORS BUREAU, NASHVILLE, TN. FILED 11-30-2006.

NO CLAIM IS MADE TO THE EXCLUSIVE RIGHT TO USE "NASHVILLE" AND "MUSIC CITY", APART FROM THE MARK AS SHOWN.

THE MARK CONSISTS OF LINE ONE HAS THE WORD NASHVILLE IN A LARGE BOLD FONT. LINE TWO HAS THE WORDS MUSIC CITY IN A SMALLER BOLD FONT CENTERED BETWEEN THE N AND SECOND L IN NASHVILLE. THERE IS ALSO A MUSIC NOTE BETWEEN THE WORDS MUSIC AND CITY.

CLASS 25—CLOTHING

FOR CLOTHING, NAMELY, HATS AND SHIRTS (U.S. CLS. 22 AND 39).

FIRST USE 9-30-2005; IN COMMERCE 9-30-2005.

CLASS 35—ADVERTISING AND BUSINESS

FOR CHAMBER OF COMMERCE SERVICES, NAMELY, PROMOTING BUSINESS AND TOURISM IN THE GREATER NASHVILLE AREA (U.S. CLS. 100, 101 AND 102).

FIRST USE 9-30-2005; IN COMMERCE 9-30-2005.

DAWN FELDMAN, EXAMINING ATTORNEY

SN 77-055,041. CEDERQUIST, EDWARD, NAPLES, FL. FILED 12-1-2006.

BISTRO MD

THE MARK CONSISTS OF STANDARD CHARACTERS WITHOUT CLAIM TO ANY PARTICULAR FONT, STYLE, SIZE, OR COLOR.

NO CLAIM IS MADE TO THE EXCLUSIVE RIGHT TO USE "BISTRO", APART FROM THE MARK AS SHOWN.

CLASS 5—PHARMACEUTICALS

FOR FOOD, NAMELY, MEAL REPLACEMENT PROTEIN SHAKES (U.S. CLS. 6, 18, 44, 46, 51 AND 52).

CLASS 29—MEATS AND PROCESSED FOODS

FOR FOOD, NAMELY, VEGGIE BURGERS PATTIES, SEAFOOD, NAMELY, SALMON, CRABS, TILAPIA, POLLOCK, MAHI-MAHI, TUNA, COD, SEA-SCALLOPS, AND OTHER FISH; CHICKEN, STUFFED CHICKEN, TURKEY, STUFFED TURKEY, PORK, BEEF, SIRLOIN BEEF, HAM, SOUPS, EGGS, OMELETS, PROTEIN BASED, NUTRIENT-DENSE SNACK BARS, SOY PROTEIN CHIPS, SOY-BASED SNACKS (U.S. CL. 46).

CLASS 30—STAPLE FOODS

FOR FOOD, NAMELY, PROTEIN SHAKES, HOT BEVERAGES, NAMELY, COFFEE, TEA, COCOA; GRAVIES AND SAUCES, NAMELY, TOMATO BASED, HOLLANDAISE, VANILLA SAUCE, CREAM BASED TERIYAKI SAUCE, BARBECUE SAUCE, FRUIT BASED SAUCE EXCLUDING CRANBERRY SAUCE AND APLESAUCE; OATMEAL; MUFFINS, COOKIES, PRETZELS, WAFFLES, BAGELS, PASTRIES, NAMELY, CHEESECAKE, CINNAMON ROLLS, COFFEE CAKE, DOUGHNUTS, AND BREAKFAST BISCUITS; AND VEGIE BURGER SANDWICHES (U.S. CL. 46).

CLASS 33—WINES AND SPIRITS

FOR HARD CIDER (U.S. CLS. 47 AND 49).

CLASS 39—TRANSPORTATION AND STORAGE

FOR MEAL DELIVERY SERVICES (U.S. CLS. 100 AND 105).

ANDREA K. NADELMAN, EXAMINING ATTORNEY

SN 77-057,156. FUTUREFUEL CORP., CLAYTON, MO. FILED 12-5-2006.



NO CLAIM IS MADE TO THE EXCLUSIVE RIGHT TO USE "CHEMICAL COMPANY", APART FROM THE MARK AS SHOWN.

THE COLOR(S) RED, GRAY AND BLACK IS/ARE CLAIMED AS A FEATURE OF THE MARK.

THE MARK CONSISTS OF THE CHEMICAL COMPOUND FOR GLYCERIN.

CLASS 39—TRANSPORTATION AND STORAGE

FOR STORAGE AND TRANSPORTATION OF FUELS, NAMELY, BIODIESEL AND ETHANOL (U.S. CLS. 100 AND 105).

CLASS 40—MATERIAL TREATMENT

FOR CUSTOM MANUFACTURE AND PRODUCTION OF RENEWABLE FUELS AND SPECIALITY CHEMICALS (U.S. CLS. 100, 103 AND 106).

INGA ERVIN, EXAMINING ATTORNEY

SN 77-057,640. FOSS ANALYTICAL A/S, HILLEROD, DENMARK, FILED 12-5-2006.

RINA

THE MARK CONSISTS OF STANDARD CHARACTERS WITHOUT CLAIM TO ANY PARTICULAR FONT, STYLE, SIZE, OR COLOR.

CLASS 9—ELECTRICAL AND SCIENTIFIC APPARATUS

FOR SOFTWARE FOR CONFIGURATION OF ANALYSIS ACTIVITY AND ANALYSIS OPERATIONS, OPERATION OF ANALYSIS ACTIVITY AND ANALYSIS OPERATIONS, SURVEILLANCE OF ANALYSIS ACTIVITY AND ANALYSIS OPERATIONS AND REMOTE MONITORING OF SPECTROSCOPIC, MEASUREMENT AND SCANNING ANALYZING INSTRUMENTS IN THE FIELD OF ANALYSIS OPERATIONS OF FOODSTUFFS, AGRICULTURAL PRODUCTS, CHEMICAL PRODUCTS AND PHARMACEUTICAL PRODUCTS (U.S. CLS. 21, 23, 26, 36 AND 38).

CLASS 42—SCIENTIFIC AND COMPUTER SERVICES

FOR COMPUTER SOFTWARE DEVELOPMENT, MAINTENANCE AND TECHNICAL SUPPORT, NAMELY, TROUBLESHOOTING OF COMPUTER SOFTWARE PROBLEMS; COMPUTER CONSULTANCY SERVICES; COMPUTER SUPPORT SERVICES, NAMELY, MONITORING AND ANALYZING THE COMPUTER SOFTWARE AND SYSTEMS OF OTHERS FOR TECHNICAL AND DEVELOPMENT PURPOSES; SCIENTIFIC RESEARCH AND INDUSTRIAL RESEARCH, PARTICULARLY IN THE FIELD OF INNOVATION AND NEW PRODUCT DESIGN (U.S. CLS. 100 AND 101).

WILLIAM BRECKENFELD, EXAMINING ATTORNEY

SN 77-059,025. INTELLIMAT, INC., ROANOKE, VA. FILED 12-7-2006.

LEVELTISE

THE MARK CONSISTS OF STANDARD CHARACTERS WITHOUT CLAIM TO ANY PARTICULAR FONT, STYLE, SIZE, OR COLOR.

CLASS 9—ELECTRICAL AND SCIENTIFIC APPARATUS

FOR DIGITAL SIGNAGE SYSTEMS AND RELATED EQUIPMENT, NAMELY, ELECTRIC SIGNS, ELECTRONIC DISPLAYS, CHANGEABLE ELECTRONIC ADVERTISING AND MESSAGE DISPLAY UNITS WITH STAND-ALONE CAPABILITIES, MULTI-NETWORKING CAPABILITIES, AND REMOTE CONNECTIVITY, LIQUID-CRYSTAL DISPLAYS, LIGHT EMITTING DIODE DISPLAYS, ELECTRONIC PAPER DISPLAYS, OPTICAL FIBER ARRAY DISPLAYS, CHANGEABLE ELECTRONIC DISPLAYS, CHANGEABLE ELECTRONIC ADVERTISING AND MESSAGE DISPLAY UNITS, SURROUNDS AND SUPPORTING STRUCTURES FOR DIGITAL SIGNAGE SYSTEMS, PORTABLE AND COMPACT COMPUTING DEVICES FOR OPERATING DIGITAL SIGNAGE SYSTEMS, AND PORTABLE AND COMPACT POWER SUPPLY UNITS FOR POWERING DIGITAL SIGNAGE SYSTEMS; WIRED AND WIRELESS NETWORKING SYSTEMS FOR DIGITAL SIGNAGE SYSTEMS AND CHANGEABLE ELECTRONIC ADVERTISING AND MESSAGE DISPLAY UNITS, NAMELY, COMPUTER HARDWARE AND SOFTWARE FOR OPERATING ELECTRONIC DISPLAYS AND DIGITAL SIGNAGE SYSTEMS, COMPUTER HARDWARE AND SOFTWARE FOR ADMINISTRATION AND OPERATION OF COMPUTER LOCAL AREA NETWORKS, COMPUTER NETWORKING HARDWARE AND NETWORK OPERATING SOFTWARE AND TELECOMMUNICATIONS AND NETWORKING HARDWARE, NAMELY, DEVICES FOR TRANSPORTING AND AGGREGATING AUDIO, DATA, AND VIDEO COMMUNICATIONS ACROSS MULTIPLE NETWORK INFRASTRUCTURES AND COMMUNICATIONS PROTOCOLS (U.S. CLS. 21, 23, 26, 36 AND 38).

CLASS 35—ADVERTISING AND BUSINESS

FOR OPERATION AND ADMINISTRATION OF DIGITAL SIGNAGE SYSTEMS FOR OTHERS, NAMELY, PROVIDING ADVERTISING SPACE BY ELECTRONIC MEANS AND GLOBAL COMPUTER INFORMATION NETWORKS; RETAIL STORE SERVICES FEATURING EQUIPMENT FOR DIGITAL SIGNAGE SYSTEMS (U.S. CLS. 100, 101 AND 102).
ROBIN CHOSID, EXAMINING ATTORNEY

SN 77-060,045. TENUTO, JOHN P., WINTER PARK, FL. FILED 12-8-2006.

CLASS 16—PAPER GOODS AND PRINTED MATTER

FOR ADHESIVE LABELS; ART PRINTS; BOOKS IN THE FIELD OF POETRY, PHILOSOPHY, AND MUSIC; CALENDARS; DRAWINGS; ENVELOPES; MAGAZINES FEATURING MUSIC GROUPS; NEWSLETTERS IN THE FIELD OF MUSIC GROUPS; PAINTINGS; PENS; PHOTOGRAPHS; POSTCARDS; POSTERS; PRINTED TICKETS; STICKERS (U.S. CLS. 2, 5, 22, 23, 29, 37, 38 AND 50).

CLASS 18—LEATHER GOODS

FOR BACKPACKS; FANNY PACKS (U.S. CLS. 1, 2, 3, 22 AND 41).

CLASS 21—HOUSEWARES AND GLASS

FOR CUPS (U.S. CLS. 2, 13, 23, 29, 30, 33, 40 AND 50).

CLASS 25—CLOTHING

FOR HATS; HEAD SCARVES; JACKETS; SHOES; SWEATERS; T-SHIRTS (U.S. CLS. 22 AND 39).

CLASS 41—EDUCATION AND ENTERTAINMENT

FOR ENTERTAINMENT NAMELY, LIVE PERFORMANCES BY A MUSICAL BAND; ENTERTAINMENT SERVICES, NAMELY, PROVIDING A WEB SITE FEATURING MUSICAL PERFORMANCES, MUSICAL VIDEOS, RELATED FILM CLIPS, PHOTOGRAPHS, AND OTHER MULTIMEDIA MATERIALS; POEM AND LYRIC WRITING (U.S. CLS. 100, 101 AND 107).
JOHN E. MICHOS, EXAMINING ATTORNEY

SN 77-061,973. HK SYSTEMS, INC., NEW BERLIN, WI. FILED 12-12-2006.

HK PRODUCTION LOGISTICS

(Nine 9.eniN)

THE MARK CONSISTS OF STANDARD CHARACTERS WITHOUT CLAIM TO ANY PARTICULAR FONT, STYLE, SIZE, OR COLOR.

CLASS 9—ELECTRICAL AND SCIENTIFIC APPARATUS

FOR COMPACT DISC CASES; MOUSE PADS; PRE-RECORDED CDS, VIDEO TAPES, LASER DISKS AND DVDS FEATURING MUSICAL PRODUCTIONS AND SONGS (U.S. CLS. 21, 23, 26, 36 AND 38).

CLASS 14—JEWELRY

FOR JEWELRY (U.S. CLS. 2, 27, 28 AND 50).

THE MARK CONSISTS OF STANDARD CHARACTERS WITHOUT CLAIM TO ANY PARTICULAR FONT, STYLE, SIZE, OR COLOR.

NO CLAIM IS MADE TO THE EXCLUSIVE RIGHT TO USE "PRODUCTION LOGISTICS", APART FROM THE MARK AS SHOWN.

CLASS 35—ADVERTISING AND BUSINESS

FOR INVENTORY MANAGEMENT SERVICES FOR INDUSTRIAL EQUIPMENT MANUFACTURERS (U.S. CLS. 100, 101 AND 102).

CLASS 40—MATERIAL TREATMENT

FOR PRODUCT ASSEMBLY SERVICES FOR OTHERS (U.S. CLS. 100, 103 AND 106).
ALLISON SCHRODY, EXAMINING ATTORNEY

SN 77-062,220. MATHIESON & ASSOCIATES INC., CENTREVILLE, VA. AND GREG E. MATHIESON, CENTREVILLE, VA. FILED 12-12-2006.

SN 77-062,774. DMB ASSOCIATES, INC., SCOTTSDALE, AZ. FILED 12-12-2006.



NO CLAIM IS MADE TO THE EXCLUSIVE RIGHT TO USE "PHOTO NEWS AGENCY, INC.", APART FROM THE MARK AS SHOWN.

THE COLOR(S) BLUE IS/ARE CLAIMED AS A FEATURE OF THE MARK.

THE COLOR BLUE APPEARS IN THE RECTANGLE AND THE LETTER "A."

THE COLOR WHITE IN THE MARK IS USED ONLY TO INDICATE THE BACKGROUND COLOR. THE COLOR BLUE APPEARS IN THE RECTANGLE AND THE LETTER "A".

CLASS 38—COMMUNICATION

FOR NEWS AGENCIES, NAMELY, THE TRANSMISSION OF NEWS ITEMS TO NEWS REPORTING ORGANIZATIONS; TRANSMISSION OF NEWS (U.S. CLS. 100, 101 AND 104).

FIRST USE 12-1-1981; IN COMMERCE 12-1-1981.

CLASS 41—EDUCATION AND ENTERTAINMENT

FOR AERIAL PHOTOGRAPHY; ENTERTAINMENT, NAMELY, TELEVISION NEWS SHOWS; NEWS AGENCIES, NAMELY, GATHERING AND DISSEMINATION OF NEWS; NEWS REPORTING SERVICES; NEWS SYNDICATION FOR THE BROADCASTING INDUSTRY; NEWS SYNDICATION REPORTING; PHOTO EDITING; PHOTOGRAPHIC AND VIDEO SERVICES, NAMELY, PHOTOGRAPHIC AND VIDEO CAPTURE; PHOTOGRAPHIC REPORTING; PHOTOGRAPHY SERVICES; PORTRAIT PHOTOGRAPHY; PRODUCTION OF VIDEO AND CREATION OF VISUAL EFFECTS FOR OTHERS FOR USE IN DVDS, TELEVISION PROGRAMS AND ON WEBSITES; PROVIDING NEWS IN THE NATURE OF CURRENT EVENT REPORTING; TELEVISION PRODUCTION; TELEVISION SHOW PRODUCTION (U.S. CLS. 100, 101 AND 107).

FIRST USE 12-1-1981; IN COMMERCE 12-1-1981.

CLASS 45—PERSONAL AND LEGAL SERVICES

FOR STOCK PHOTOGRAPHY SERVICES, NAMELY, LEASING REPRODUCTION RIGHTS OF PHOTOGRAPHS AND TRANSPARENCIES TO OTHERS (U.S. CLS. 100 AND 101).

FIRST USE 12-1-1981; IN COMMERCE 12-1-1981.
AMEETA JORDAN, EXAMINING ATTORNEY



A PASSION FOR GREAT PLACES

OWNER OF U.S. REG. NOS. 3,157,802, 3,157,865 AND 3,158,391.

CLASS 16—PAPER GOODS AND PRINTED MATTER

FOR PAPER; PRINTED MATTER, NAMELY, POSTCARDS, PRINTED CALENDARS, STATIONERY; SCORE CARDS; PENCILS; PENS; PRINTED PUBLICATIONS, NAMELY, MAGAZINES, NEWSLETTERS, CATALOGS, BROCHURES AND LEAFLETS FEATURING REAL ESTATE AND COMMUNITY EVENTS; PRINTED INSTRUCTIONAL AND TEACHING MATERIAL IN THE FIELD OF REAL ESTATE; PRINTED GOLF COURSE GUIDES. (U.S. CLS. 2, 5, 22, 23, 29, 37, 38 AND 50).

CLASS 21—HOUSEWARES AND GLASS

FOR SPORTS BOTTLES SOLD EMPTY. (U.S. CLS. 2, 13, 23, 29, 30, 33, 40 AND 50).

CLASS 25—CLOTHING

FOR CLOTHING, NAMELY, SHIRTS, T-SHIRTS, SPORT SHIRTS, JACKETS AND LIGHTWEIGHT WIND-RESISTANT JACKETS, HATS, SWEATERS AND SWEATSHIRTS, FOOTWEAR, SHORTS, PANTS, WARM UP SUITS, GOLF SHOES; HEADBANDS AND WRIST BANDS (U.S. CLS. 22 AND 39).

CLASS 28—TOYS AND SPORTING GOODS

FOR SPORTING GOODS, NAMELY, GOLF GLOVES, GOLF BALLS, GOLF CLUBS, GOLF BAGS, GOLF BAG COVERS, GOLF BAG TAGS, HEAD COVERS FOR GOLF CLUBS, GOLF BALL MARKERS, GOLF ACCESSORY POUCHES, GOLF TEES, GOLF FLAGS, DIVOT REPAIR TOOLS, AND NON-MOTORIZED GOLF CLUB CARTS (U.S. CLS. 22, 23, 38 AND 50).

CLASS 35—ADVERTISING AND BUSINESS

FOR ASSOCIATION SERVICES, NAMELY, PROMOTING THE INTERESTS OF HOMEOWNERS THAT RESIDE IN THE COMMUNITY; RETAIL GOLF AND TENNIS STORE SERVICES; COMMERCIAL BUSINESS MANAGEMENT; BUSINESS MANAGEMENT IN THE FIELD OF COMMERCIAL REAL ESTATE AND RETAIL; PROMOTING THE GOODS AND SERVICES OF OTHERS BY DISTRIBUTING ADVERTISING MATERIALS THROUGH A VARIETY OF METHODS (U.S. CLS. 100, 101 AND 102).

CLASS 36—INSURANCE AND FINANCIAL

FOR REAL ESTATE AGENCY SERVICES; REAL ESTATE MANAGEMENT SERVICES; REAL ESTATE LEASING SERVICES; CHARITABLE FUND RAISING SERVICES; REAL ESTATE BROKERAGE SERVICES FOR CUSTOM HOMES, PRODUCTION HOME AND CUSTOM HOME SITES (U.S. CLS. 100, 101 AND 102).

CLASS 37—CONSTRUCTION AND REPAIR

FOR REAL ESTATE DEVELOPMENT SERVICES, NAMELY, THE DEVELOPMENT OF MASTER PLANNED COMMUNITIES, PLANNING AND DEVELOPMENT OF RESIDENTIAL COMMUNITIES, INCLUDING PLANNING AND LAYING OUT HOUSES AND APARTMENTS WITHIN THE COMMUNITY; REAL ESTATE DEVELOPMENT OF COMMERCIAL PROPERTIES, INDUSTRIAL BUILDINGS, OFFICE AND RETAIL SPACE; REAL ESTATE DEVELOPMENT SERVICES FOR RESIDENTIAL COMMUNITIES AND COMMERCIAL PROPERTIES; PLANNING, DESIGNING AND LAYING OUT OF RESIDENTIAL COMMUNITIES AND COMMERCIAL PROPERTIES; CONSTRUCTION PLANNING; SNOW REMOVAL SERVICES. (U.S. CLS. 100, 103 AND 106).

CLASS 41—EDUCATION AND ENTERTAINMENT

FOR PROVIDING TENNIS COURT FACILITIES AND TENNIS INSTRUCTION; GOLF COURSES AND GOLF INSTRUCTION; HEALTH CLUB SERVICES, NAMELY PROVIDING INSTRUCTION AND EQUIPMENT IN THE FIELD OF PHYSICAL EXERCISE; PHYSICAL FITNESS AND EXERCISE FACILITIES AND PHYSICAL FITNESS INSTRUCTION; COUNTRY CLUBS; ENTERTAINMENT IN THE NATURE OF GOLF AND TENNIS TOURNAMENTS; COUNTRY CLUB SERVICES, NAMELY PROVIDING FACILITIES FOR GOLF; ORGANIZING AND CONDUCTING GOLF TOURNAMENTS; GOLF CLUB SERVICES AND FACILITIES, NAMELY PROVIDING GOLF COURSES; EQUESTRIAN CENTER FACILITIES; RENTAL OF GOLF EQUIPMENT; PROVIDING RECREATIONAL FACILITIES IN THE NATURE OF CHILDREN'S PLAY AREAS, SWIMMING POOLS, BOWLING ALLEYS, MOVIE THEATERS; PROVIDING SPORTS FACILITIES FOR TENNIS, GOLF, BASKETBALL, SWIMMING AND SKIING; ORGANIZING COMMUNITY FESTIVALS FEATURING A VARIETY OF ACTIVITIES, NAMELY, SPORTING EVENTS, ART EXHIBITIONS, FLEA MARKETS, ETHNIC DANCES AND THE LIKE; COORDINATION OF RECREATIONAL SPORTING OPPORTUNITIES FOR INDIVIDUALS WHO WISH TO PARTICIPATE IN TEAM LEAGUE SPORTS, NAMELY, FOR TENNIS, GOLF, BASKETBALL, SWIMMING, AND SKIING TEAMS; RECREATIONAL PARK SERVICES, NAMELY, PROVIDING OPEN SPACES; ART EXHIBITS FEATURING VISUAL ARTS AND LITERATURE FOR EDUCATIONAL OR ENTERTAINMENT PURPOSES (U.S. CLS. 100, 101 AND 107).

CLASS 43—HOTEL AND RESTAURANT SERVICES

FOR HEALTH RESORT SERVICES, NAMELY, PROVIDING FOOD AND LODGING THAT SPECIALIZE IN PROMOTING PATRONS' GENERAL HEALTH AND WELL-BEING; SPA SERVICES, NAMELY, PROVIDING TEMPORARY ACCOMMODATIONS AND MEALS TO CLIENTS OF A HEALTH OR BEAUTY SPA; RESTAURANT AND BANQUET CATERING SERVICES; PROVIDING BANQUET AND SOCIAL FUNCTION FACILITIES FOR SPECIAL OCCASIONS; PROVIDING FACILITIES FOR EXHIBITIONS; SNACK BAR SERVICES; CAFE SERVICES; RESORT HOTEL AND LODGING SERVICES, RESTAURANT, BAR AND LOUNGE SERVICES (U.S. CLS. 100 AND 101).

CLASS 44—MEDICAL, BEAUTY AND AGRICULTURAL SERVICES

FOR HEALTH SPA SERVICES, NAMELY COSMETIC BODY CARE SERVICES (U.S. CLS. 100 AND 101).

CLASS 45—PERSONAL AND LEGAL SERVICES

FOR CONCIERGE SERVICES FOR OTHERS COMPRISED OF MAKING REQUESTED PERSONAL ARRANGEMENTS AND RESERVATIONS AND PROVIDING CUSTOMER-SPECIFIC INFORMATION TO MEET INDIVIDUAL NEEDS RENDERED TOGETHER IN A MIXED USE ENVIRONMENT OF RESIDENTIAL, CORPORATE AND COMMERCIAL BUSINESSES; HOTEL CONCIERGE SERVICES (U.S. CLS. 100 AND 101).
ELI HELLMAN, EXAMINING ATTORNEY

SN 77-063,308. SPARTAN BRANDS INCORPORATED, NEW YORK, NY. FILED 12-13-2006.

STYLE SAVER

THE MARK CONSISTS OF STANDARD CHARACTERS WITHOUT CLAIM TO ANY PARTICULAR FONT, STYLE, SIZE, OR COLOR.

NO CLAIM IS MADE TO THE EXCLUSIVE RIGHT TO USE "STYLE", APART FROM THE MARK AS SHOWN.

CLASS 3—COSMETICS AND CLEANING PREPARATIONS

FOR HAIR CONDITIONERS; HAIR SETTING PRODUCTS, NAMELY, HAIR DRESSINGS FOR WOMEN, POMADES AND GELS (U.S. CLS. 1, 4, 6, 50, 51 AND 52).

CLASS 25—CLOTHING

FOR SATIN SLEEP CAPS, BONNETS, AND SCARVES (U.S. CLS. 22 AND 39).

DANIEL RUSSELL, EXAMINING ATTORNEY

SN 77-063,970. MOLSON CANADA 2005, TORONTO, CANADA, FILED 12-14-2006.

THE TRUE NORTHERN LIGHT

THE MARK CONSISTS OF STANDARD CHARACTERS WITHOUT CLAIM TO ANY PARTICULAR FONT, STYLE, SIZE, OR COLOR.

CLASS 25—CLOTHING

FOR CLOTHING, NAMELY, SHIRTS, T-SHIRTS, GOLF SHIRTS, BOWLING SHIRTS, DENIM SHIRTS, TOPS, TANK TOPS, SWEATERS, SWEAT SHIRTS, JERSEYS, PANTS, SWEATPANTS, SHORTS, DRESSES, JACKETS, WIND RESISTANT JACKETS, PONCHOS, HATS, CAPS, ARM BANDS, APRONS, SLIPPERS, SANDALS AND BATHING SUITS (U.S. CLS. 22 AND 39).

CLASS 32—LIGHT BEVERAGES

FOR BREWED ALCOHOLIC BEVERAGES, NAMELY, BEER (U.S. CLS. 45, 46 AND 48).

CHRISTOPHER BUONGIORNO, EXAMINING ATTORNEY

SN 77-064,719. LOCKHEED MARTIN CORPORATION,
BETHESDA, MD. FILED 12-14-2006.

SN 77-065,314. DMB ASSOCIATES, INC., SCOTTSDALE, AZ.
FILED 12-15-2006.



A PASSION FOR GREAT PLACES

CLASS 9—ELECTRICAL AND SCIENTIFIC APPARATUS

FOR SATELLITES AND COMPUTER HARDWARE AND COMPUTER SOFTWARE IN THE FIELD OF SATELLITE CONTROL (U.S. CLS. 21, 23, 26, 36 AND 38).

CLASS 42—SCIENTIFIC AND COMPUTER SERVICES

FOR PROVIDING PLANNING AND ENGINEERING SERVICES IN THE FIELD OF INFORMATION AND COMMUNICATIONS NETWORKS; TECHNOLOGY CONSULTATION IN THE FIELD OF SATELLITE COMMUNICATION SYSTEMS (U.S. CLS. 100 AND 101).
KAPIL BHANOT, EXAMINING ATTORNEY

THE MARK CONSISTS OF STANDARD CHARACTERS WITHOUT CLAIM TO ANY PARTICULAR FONT, STYLE, SIZE, OR COLOR.

CLASS 16—PAPER GOODS AND PRINTED MATTER

FOR PAPER; PRINTED MATTER, NAMELY, POSTCARDS, PRINTED CALENDARS, STATIONERY; SCORE CARDS; PENCILS; PENS; PRINTED PUBLICATIONS, NAMELY, MAGAZINES, NEWSLETTERS, CATALOGS, BROCHURES AND LEAFLETS FEATURING REAL ESTATE AND COMMUNITY EVENTS; PRINTED INSTRUCTIONAL AND TEACHING MATERIAL IN THE FIELD OF REAL ESTATE; PRINTED GOLF COURSE GUIDES. (U.S. CLS. 2, 5, 22, 23, 29, 37, 38 AND 50).

CLASS 21—HOUSEWARES AND GLASS

FOR SPORTS BOTTLES SOLD EMPTY. (U.S. CLS. 2, 13, 23, 29, 30, 33, 40 AND 50).

CLASS 25—CLOTHING

FOR CLOTHING, NAMELY, SHIRTS, T-SHIRTS, SPORT SHIRTS, JACKETS AND LIGHTWEIGHT WIND-RESISTANT JACKETS, HATS, SWEATERS AND SWEATSHIRTS, FOOTWEAR, SHORTS, PANTS, WARM UP SUITS, GOLF SHOES; HEADBANDS AND WRIST BANDS (U.S. CLS. 22 AND 39).

CLASS 28—TOYS AND SPORTING GOODS

FOR SPORTING GOODS, NAMELY, GOLF GLOVES, GOLF BALLS, GOLF CLUBS, GOLF BAGS, GOLF BAG COVERS, GOLF BAG TAGS, HEAD COVERS FOR GOLF CLUBS, GOLF BALL MARKERS, GOLF ACCESSORY POUCHES, GOLF TEES, GOLF FLAGS, DIVOT REPAIR TOOLS, AND NON-MOTORIZED GOLF CLUB CARTS (U.S. CLS. 22, 23, 38 AND 50).

CLASS 35—ADVERTISING AND BUSINESS

FOR ASSOCIATION SERVICES, NAMELY, PROMOTING THE INTERESTS OF HOMEOWNERS THAT RESIDE IN THE COMMUNITY; RETAIL GOLF AND TENNIS STORE SERVICES; COMMERCIAL BUSINESS MANAGEMENT; BUSINESS MANAGEMENT IN THE FIELD OF COMMERCIAL REAL ESTATE AND RETAIL; PROMOTING THE GOODS AND SERVICES OF OTHERS BY DISTRIBUTING ADVERTISING MATERIALS THROUGH A VARIETY OF METHODS (U.S. CLS. 100, 101 AND 102).

CLASS 36—INSURANCE AND FINANCIAL

FOR REAL ESTATE AGENCY SERVICES; REAL ESTATE MANAGEMENT SERVICES; REAL ESTATE LEASING SERVICES; CHARITABLE FUND RAISING SERVICES; REAL ESTATE BROKERAGE SERVICES FOR CUSTOM HOMES, PRODUCTION HOME AND CUSTOM HOME SITES (U.S. CLS. 100, 101 AND 102).

SN 77-064,743. LOCKHEED MARTIN CORPORATION,
BETHESDA, MD. FILED 12-14-2006.

MUOS

THE MARK CONSISTS OF STANDARD CHARACTERS WITHOUT CLAIM TO ANY PARTICULAR FONT, STYLE, SIZE, OR COLOR.

CLASS 9—ELECTRICAL AND SCIENTIFIC APPARATUS

FOR SATELLITES AND COMPUTER HARDWARE AND COMPUTER SOFTWARE IN THE FIELD OF SATELLITE CONTROL (U.S. CLS. 21, 23, 26, 36 AND 38).

CLASS 42—SCIENTIFIC AND COMPUTER SERVICES

FOR PROVIDING PLANNING AND ENGINEERING SERVICES IN THE FIELD OF INFORMATION AND COMMUNICATIONS NETWORKS; TECHNOLOGY CONSULTATION IN THE FIELD OF SATELLITE COMMUNICATION SYSTEMS (U.S. CLS. 100 AND 101).
KAPIL BHANOT, EXAMINING ATTORNEY

CLASS 37—CONSTRUCTION AND REPAIR

FOR REAL ESTATE DEVELOPMENT SERVICES, NAMELY, THE DEVELOPMENT OF MASTER PLANNED COMMUNITIES, PLANNING AND DEVELOPMENT OF RESIDENTIAL COMMUNITIES, INCLUDING PLANNING AND LAYING OUT HOUSES AND APARTMENTS WITHIN THE COMMUNITY; REAL ESTATE DEVELOPMENT OF COMMERCIAL PROPERTIES, INDUSTRIAL BUILDINGS, OFFICE AND RETAIL SPACE; REAL ESTATE DEVELOPMENT SERVICES FOR RESIDENTIAL COMMUNITIES AND COMMERCIAL PROPERTIES; PLANNING, DESIGNING AND LAYING OUT OF RESIDENTIAL COMMUNITIES AND COMMERCIAL PROPERTIES; CONSTRUCTION PLANNING; SNOW REMOVAL SERVICES (U.S. CLS. 100, 103 AND 106).

CLASS 41—EDUCATION AND ENTERTAINMENT

FOR PROVIDING TENNIS COURT FACILITIES AND TENNIS INSTRUCTION; GOLF COURSES AND GOLF INSTRUCTION; HEALTH CLUB SERVICES, NAMELY PROVIDING INSTRUCTION AND EQUIPMENT IN THE FIELD OF PHYSICAL EXERCISE; PHYSICAL FITNESS AND EXERCISE FACILITIES AND PHYSICAL FITNESS INSTRUCTION; COUNTRY CLUBS; ENTERTAINMENT IN THE NATURE OF GOLF AND TENNIS TOURNAMENTS; COUNTRY CLUB SERVICES, NAMELY PROVIDING FACILITIES FOR GOLF; ORGANIZING AND CONDUCTING GOLF TOURNAMENTS; GOLF CLUB SERVICES AND FACILITIES, NAMELY PROVIDING GOLF COURSES; EQUESTRIAN CENTER FACILITIES; RENTAL OF GOLF EQUIPMENT; PROVIDING RECREATIONAL FACILITIES IN THE NATURE OF CHILDREN'S PLAY AREAS, SWIMMING POOLS, BOWLING ALLEYS, MOVIE THEATERS; PROVIDING SPORTS FACILITIES FOR TENNIS, GOLF, BASKETBALL, SWIMMING AND SKIING; ORGANIZING COMMUNITY FESTIVALS FEATURING A VARIETY OF ACTIVITIES, NAMELY, SPORTING EVENTS, ART EXHIBITIONS, FLEA MARKETS, ETHNIC DANCES AND THE LIKE; COORDINATION OF RECREATIONAL SPORTING OPPORTUNITIES FOR INDIVIDUALS WHO WISH TO PARTICIPATE IN TEAM LEAGUE SPORTS, NAMELY, FOR TENNIS, GOLF, BASKETBALL, SWIMMING, AND SKIING TEAMS; RECREATIONAL PARK SERVICES, NAMELY, PROVIDING OPEN SPACES; ART EXHIBITS FEATURING VISUAL ARTS AND LITERATURE FOR EDUCATIONAL OR ENTERTAINMENT PURPOSES (U.S. CLS. 100, 101 AND 107).

CLASS 43—HOTEL AND RESTAURANT SERVICES

FOR HEALTH RESORT SERVICES, NAMELY, PROVIDING FOOD AND LODGING THAT SPECIALIZE IN PROMOTING PATRONS' GENERAL HEALTH AND WELL-BEING; SPA SERVICES, NAMELY, PROVIDING TEMPORARY ACCOMMODATIONS AND MEALS TO CLIENTS OF A HEALTH OR BEAUTY SPA; RESTAURANT AND BANQUET CATERING SERVICES; PROVIDING BANQUET AND SOCIAL FUNCTION FACILITIES FOR SPECIAL OCCASIONS; PROVIDING FACILITIES FOR EXHIBITIONS; SNACK BAR SERVICES; CAFE SERVICES; RESORT HOTEL AND LODGING SERVICES, RESTAURANT, BAR AND LOUNGE SERVICES (U.S. CLS. 100 AND 101).

CLASS 44—MEDICAL, BEAUTY AND AGRICULTURAL SERVICES

FOR HEALTH SPA SERVICES, NAMELY COSMETIC BODY CARE SERVICES (U.S. CLS. 100 AND 101).

CLASS 45—PERSONAL AND LEGAL SERVICES

FOR CONCIERGE SERVICES FOR OTHERS COMPRISED OF MAKING REQUESTED PERSONAL ARRANGEMENTS AND RESERVATIONS AND PROVIDING CUSTOMER-SPECIFIC INFORMATION TO MEET INDIVIDUAL NEEDS RENDERED TOGETHER IN A MIXED USE ENVIRONMENT OF RESIDENTIAL, CORPORATE AND COMMERCIAL BUSINESSES; HOTEL CONCIERGE SERVICES (U.S. CLS. 100 AND 101).
ELI HELLMAN, EXAMINING ATTORNEY

SN 77-067,211. HONEYWELL INTERNATIONAL INC., MORRISTOWN, NJ. FILED 12-19-2006.

REAL FRAMEWORK

THE MARK CONSISTS OF STANDARD CHARACTERS WITHOUT CLAIM TO ANY PARTICULAR FONT, STYLE, SIZE, OR COLOR.

NO CLAIM IS MADE TO THE EXCLUSIVE RIGHT TO USE "FRAMEWORK", APART FROM THE MARK AS SHOWN.

CLASS 9—ELECTRICAL AND SCIENTIFIC APPARATUS

FOR VIRTUAL REALITY MODELING AND SIMULATION SOFTWARE AND HARDWARE FOR DEMONSTRATING AND TESTING TECHNOLOGY IN THE FIELDS OF BUSINESS, MILITARY, DEFENSE, SPACE AND AVIATION (U.S. CLS. 21, 23, 26, 36 AND 38).

CLASS 41—EDUCATION AND ENTERTAINMENT

FOR DEMONSTRATION AND TRAINING IN THE USE OF SPECIFIC SOFTWARE AND HARDWARE FOR THE DEVELOPMENT AND TESTING OF NEW TECHNOLOGY (U.S. CLS. 100, 101 AND 107).

CLASS 42—SCIENTIFIC AND COMPUTER SERVICES

FOR DEVELOPMENT AND TESTING OF NEW TECHNOLOGY FOR OTHERS IN THE FIELDS OF BUSINESS, MILITARY, DEFENSE, SPACE AND AVIATION (U.S. CLS. 100 AND 101).

MATTHEW MCDOWELL, EXAMINING ATTORNEY

SN 77-068,451. VICTORIA'S SECRET STORES BRAND MANAGEMENT, INC., REYNOLDSBURG, OH. FILED 12-20-2006.

AFTER DARK

THE MARK CONSISTS OF STANDARD CHARACTERS WITHOUT CLAIM TO ANY PARTICULAR FONT, STYLE, SIZE, OR COLOR.

CLASS 3—COSMETICS AND CLEANING PREPARATIONS

FOR PERSONAL CARE PRODUCTS, NAMELY, BODY LOTION, BODY WASH, EAU DE PARFUM SPRAY, MASSAGE OIL, HOME FRAGRANCE PRODUCTS, NAMELY, POTPOURRI, ROOM FRAGRANCE SPRAYS AND SACHETS (U.S. CLS. 1, 4, 6, 50, 51 AND 52).

CLASS 4—LUBRICANTS AND FUELS

FOR CANDLES (U.S. CLS. 1, 6 AND 15).
ALLISON SCHRODY, EXAMINING ATTORNEY

SN 77-069,951. BATH & BODY WORKS BRAND MANAGEMENT, INC., REYNOLDSBURG, OH. FILED 12-21-2006.

TAHITI'S NATIVE SECRET FOR
BEAUTIFUL SKIN

THE MARK CONSISTS OF STANDARD CHARACTERS WITHOUT CLAIM TO ANY PARTICULAR FONT, STYLE, SIZE, OR COLOR.

NO CLAIM IS MADE TO THE EXCLUSIVE RIGHT TO USE "TAHITI'S" AND "SKIN", APART FROM THE MARK AS SHOWN.

CLASS 3—COSMETICS AND CLEANING PREPARATIONS

FOR PERSONAL CARE PRODUCTS, NAMELY, AFTER SHAVE CREAM, AFTER SHAVE BALM, AGE SPOT LIGHTENER CREAMS, ANTIPERSPIRANT, ASTRINGENT FOR THE FACE FOR COSMETIC PURPOSES, ASTRINGENT FOR THE SKIN FOR COSMETIC PURPOSES, BATH BEADS, BATH CLEANSING CREAM, BATH CUBES, NAMELY, BATH SALTS, BATH FOAM, BATH MILK, BATH OIL, BATH SALTS, BATH SOAKS, NAMELY, BATH GELS, BLEMISH CORRECTOR, NAMELY, FACIAL CONCEALERS, BLEMISH STICK, NAMELY, BODY CONCEALERS, BLUSH, NON-MEDICATED BODY BALM, BODY SOAP BAR, BODY SHEA BUTTER FOR COSMETIC PURPOSES, BODY CREAM, BODY ESSENCE IN THE NATURE OF BODY SPRAY WITH A FRAGRANCE, BODY GEL, BODY GLITTER, BODY LOTION, BODY MASK, BODY OIL, BODY POWDER, BODY SCRUB, BODY SMOOTHER IN THE NATURE OF BODY LOTION, BODY SOAP, BODY SPLASH IN THE NATURE OF BODY SPRAYS, BODY WASH, BUBBLE BATH, SKIN BUFFING BAR, COLOGNE, CREAM BODY WASH, CREAM SKIN CLEANSER, CUTICLE CREAM, CUTICLE CREAM STICK FOR COSMETIC PURPOSES, CUTICLE OIL, BODY DEODORANT, EAU DE TOILETTE, ESSENTIAL OILS, EXFOLIATOR FOR THE FEET, EYE SUN BLOCK, EYE BROW LINER, EYE CREAM, EYE GEL, EYE LINER, GEL EYE MASK, EYE REPAIR CREAM, EYE SHADOW, FACE BALM, FACE SUN BLOCK LOTIONS, FACE CLEANSER, FACE CREAM, FACE GEL, FACE LOTION, FACE MASK, FACE MOISTURIZER, FACE POLISHER IN THE NATURE OF FACE LOTION, FACE POWDER, FACE SCRUB, FACE CLEANSING SOAP, FACE WASH, FACIAL ABRASIVE CLOTHS, FOAM BATH, NON-MEDICATED FOOT CREAM, NON-MEDICATED FOOT LOTION, NON-MEDICATED FOOT POWDER, FOOT SCRUB, NON-MEDICATED FOOT SOAK, FOUNDATION, GEL FACE WASH, GLYCERIN BODY SOAP, HAIR CONDITIONER, HAIR DETANGLER, HAIR DYE, HAIR GEL, HAIR GLITTER, DEPILATORIES IN THE NATURE OF HAIR INHIBITOR LOTION, HAIR MASCARA, HAIR MIST IN THE NATURE OF HAIR SPRAY, HAIR POMADE, HAIR RECONSTRUCTOR IN THE NATURE OF HAIR CONDITIONERS, HAIR REMOVING CREAM, HAIR RINSE, HAIR SHAMPOO, HAIR SHINE SERUM, HAIR SPRAY, HAIR STRAIGHTENER CREAMS, HAIR STYLING MOUSSE, NON-MEDICATED HAND BALM, HAND CLEANSING SPRAY IN THE

NATURE OF HAND SOAP, HAND CREAM, HAND EXFOLIATOR LOTION, HAND LOTION, HAND RENEWER, NAMELY, HAND CREAM, HAND SOAP, LEG BRONZER CREAMS, LEG REFRESHER IN THE NATURE OF LEG SPRAY, LINE PREVENTION CONCENTRATE IN THE NATURE OF ANTI-WRINKLE CREAMS, LINE PREVENTION SERUM IN THE NATURE OF ANTI-WRINKLE CREAMS, LINE REDUCING CONCENTRATE IN THE NATURE OF WRINKLE REMOVING SKIN CARE PREPARATIONS, LINE REDUCING SERUM IN THE NATURE OF WRINKLE REMOVING SKIN CARE PREPARATIONS, LIP BALM, LIP SUN BLOCK, LIP GLOSS, LIP LINER, LIP PAINT, NON-MEDICATED LIP PROTECTOR, LIP SHINE LIP GLOSS, LIP STICK, LIP TINT IN THE NATURE OF LIP GLOSS, MASCARA, MASSAGE CREAM, MASSAGE LOTION, MASSAGE OIL, MINERAL BATH IN THE NATURE OF MINERAL BATH SALTS NOT FOR MEDICAL PURPOSES, NON-MEDICATED COSMETIC MOOD ENHANCING MASSAGE OINTMENT, MOOD ENHANCING MIST IN THE NATURE OF PERFUME, MOOD ENHANCING SKIN CREAM, NAIL CORRECTOR PEN IN THE NATURE OF NAIL POLISH REMOVER IN PEN FORM, NAIL CREAM, NAIL POLISH, NAIL POLISH REMOVER, NAIL STENCILS, NIGHT EYE CREAM, NIGHT NOURISHING BODY CREAM, COSMETIC OIL BLOTTING SHEETS FOR THE SKIN, PERFUME OIL SPRAY, PENETRATING RUB, NAMELY PENETRATING SKIN CREAM, PERFUME, PERFUME OILS, PILLOW MIST IN THE NATURE OF SCENTED FRAGRANCES FOR PILLOWS, POST-SUNTANNING LOTION FOR THE BODY, POTPOURRI, NON-MEDICATED POWDER FOR THE FEET, PRE-SUNTANNING LOTION FOR THE BODY, PULSE POINT BODY CREAM, PUMICE STONES FOR PERSONAL USE, REFILLS IN THE NATURE OF ROOM FRAGRANCES FOR ELECTRIC ROOM FRAGRANCE DISPENSERS, ROOM FRAGRANCE SPRAY, SACHETS, SALT SCRUB IN THE NATURE OF BATH OIL, NON-MEDICATED SEA SALT EXFOLIATOR BODY CREAM, SELF TANNING PREPARATION, SHAVING CREAM, SHEA BUTTER HAND CREAM, SHEA BUTTER BODY CREAM TREATMENT STICK, SHIMMER BODY LOTION, SHIMMER BODY POWDER PUFFS FOR COSMETIC PURPOSES FILLED WITH SHIMMERING POWDER, SHOWER CREAM SOAPS, SHOWER FOAM, SHOWER GEL, SHOWER BODY SCRUB, SKIN BRONZING CREAM, NON-MEDICATED COSMETIC SKIN CLEANSING WIPES, SKIN CREAM, SKIN EXFOLIATOR CREAM, SKIN LOTION, SKIN MOISTURIZER, SKIN POLISHER, SKIN SCRUB, SKIN SERUM, SMOOTHING BODY OIL, SOAP, SPARKLE NAIL POLISH, HAIR STYLING FOAM, SUGAR BODY SCRUB, SUN SCREEN, SUNBLOCK FOR THE BODY, SUNBLOCK FOR THE FACE, SUNLESS TANNING CREAM, SUNLESS TANNING LOTION FOR THE BODY, SUNLESS TANNING LOTION FOR THE FACE, SUNTAN LOTION FOR THE BODY, SUNTAN LOTION FOR THE FACE, TALCUM POWDER (U.S. CLS. 1, 4, 6, 50, 51 AND 52).

CLASS 35—ADVERTISING AND BUSINESS

FOR RETAIL STORE SERVICES, MAIL ORDER RETAIL STORE SERVICES AND ONLINE RETAIL STORE SERVICES ALL IN THE FIELD OF PERSONAL CARE PRODUCTS, COSMETICS, HOME FRAGRANCE PRODUCTS AND ACCESSORIES (U.S. CLS. 100, 101 AND 102).

WILLIAM ROSSMAN, EXAMINING ATTORNEY

SN 77-070,082. FIERRO, MANUEL I., SAN ANTONIO, TX.
FILED 12-22-2006.



NO CLAIM IS MADE TO THE EXCLUSIVE RIGHT TO USE "LONE STAR", APART FROM THE MARK AS SHOWN.
THE COLOR(S) BLUE AND RED IS/ARE CLAIMED AS A FEATURE OF THE MARK.

THE MARK CONSISTS OF THE WORDS LONE STAR CATALOG OVER A FIVE POINTED STAR. THE WORD LONE AND THE STAR ARE BLUE, AND THE WORDS STAR CATALOG ARE RED AND OUTLINED IN WHITE. WHITE CONSTITUTES BACKGROUND AND OUTLINING, AND IS NOT PART OF THE MARK.

CLASS 24—FABRICS

FOR BED LINEN; FABRIC WINDOW COVERINGS AND TREATMENTS, NAMELY CURTAINS, DRAPERIES, SHEERS, SWAGS AND VALANCES; HOUSEHOLD LINEN; KITCHEN LINENS; TABLE LINEN (U.S. CLS. 42 AND 50).

CLASS 25—CLOTHING

FOR LINGERIE; SLEEPWEAR; SOCKS; SWIM WEAR; UNDERWEAR; WAIST BELTS (U.S. CLS. 22 AND 39).
MORENO, PAUL, EXAMINING ATTORNEY

SN 77-070,558. HARRAH'S LICENSE COMPANY, LLC, LAS VEGAS, NV. FILED 12-22-2006.



OWNER OF U.S. REG. NOS. 2,432,163, 2,475,977 AND OTHERS.

CLASS 41—EDUCATION AND ENTERTAINMENT

FOR CASINO AND GAMING SERVICES; ENTERTAINMENT SERVICES, NAMELY, ARRANGING FOR TICKET RESERVATIONS FOR SHOWS AND OTHER ENTERTAINMENT EVENTS; AND CONDUCTING AND PROVIDING FACILITIES FOR SPECIAL EVENTS FEATURING CASINO AND GAMING CONTESTS AND TOURNAMENTS (U.S. CLS. 100, 101 AND 107).
FIRST USE 9-1-1999; IN COMMERCE 9-1-1999.

CLASS 43—HOTEL AND RESTAURANT SERVICES

FOR HOTEL SERVICES; BAR AND RESTAURANT SERVICES; PROVISION OF CONFERENCE, EXHIBITION AND MEETING FACILITIES (U.S. CLS. 100 AND 101).
FIRST USE 9-1-1999; IN COMMERCE 9-1-1999.
BRENDAN MCCAULEY, EXAMINING ATTORNEY

SN 77-072,028. FOREVISTA LLC, AUSTIN, TX. FILED 12-27-2006.



THE COLOR(S) BLACK, GRAY AND PURPLE IS/ARE CLAIMED AS A FEATURE OF THE MARK.

THE MARK CONSISTS OF THE WORD "FOREVISTA" IN BLACK DISPOSED OVER A GRAY INFINITY SYMBOL WITH PURPLE SHADING.

CLASS 35—ADVERTISING AND BUSINESS

FOR ACCOUNTING, BOOKKEEPING AND BUSINESS MANAGEMENT SERVICES (U.S. CLS. 100, 101 AND 102).
FIRST USE 1-1-2006; IN COMMERCE 1-1-2006.

CLASS 36—INSURANCE AND FINANCIAL

FOR INVESTMENT SERVICES, NAMELY ASSET MANAGEMENT SERVICES; INVESTMENT MANAGEMENT (U.S. CLS. 100, 101 AND 102).
FIRST USE 1-1-2006; IN COMMERCE 1-1-2006.
MARY BOAGNI, EXAMINING ATTORNEY

SN 77-073,475. TIM HOLTZ, LLC, PRESCOTT, AZ. FILED 12-29-2006.

Tim Holtz

THE MARK CONSISTS OF STANDARD CHARACTERS WITHOUT CLAIM TO ANY PARTICULAR FONT, STYLE, SIZE, OR COLOR.

THE NAME(S), PORTRAIT(S), AND/OR SIGNATURE(S) SHOWN IN THE MARK IDENTIFIES TIM HOLTZ, WHOSE CONSENT(S) TO REGISTER IS MADE OF RECORD.

CLASS 2—PAINTS

FOR METALS IN LEAF AND POWDER FORM FOR PAINTERS, DECORATORS, PRINTERS AND ARTISTS; NONFERROUS METALS IN FOIL OR POWDER FORM FOR PAINTERS, DECORATORS, PRINTERS AND ARTISTS; PAINTS FOR ARTS AND CRAFTS (U.S. CLS. 6, 11 AND 16).

CLASS 6—METAL GOODS

FOR GENERAL PURPOSE METAL STORAGE BINS; GENERAL PURPOSE METAL STORAGE CONTAINERS; METAL BOXES; METAL CHAINS; METAL CLASPS FOR PAPER CRAFTS; METAL CLIP FOR PAPER CRAFTS; METAL CLOSURES FOR PAPER CRAFTS; METAL KEY BLANKS; METAL TOOL BOXES (U.S. CLS. 2, 12, 13, 14, 23, 25 AND 50).

CLASS 8—HAND TOOLS

FOR HAND TOOLS NAMELY, HAMMERS; HAND TOOLS NAMELY, NEEDLE TOOL FOR MANIPULATING FIBROUS MATERIALS INCLUDING PAPER AND FABRIC, THREAD CUTTER/DISTRESSER FOR MANIPULATING FIBROUS MATERIALS INCLUDING PAPER AND FABRIC, CRAFT KNIFE, AND SCRATCHER FOR MANIPULATING FIBROUS MATERIALS INCLUDING PAPER AND FABRIC; ROLL-UP FABRIC CONTAINER FOR HAND TOOLS; SANDING BLOCKS; SCISSORS (U.S. CLS. 23, 28 AND 44).

FIRST USE 1-1-2006; IN COMMERCE 7-21-2006.

CLASS 16—PAPER GOODS AND PRINTED MATTER

FOR ACID-RESISTANT PAPER; ADHESIVE CORNERS FOR PHOTOGRAPHS; ADHESIVE LABELS; ADHESIVE MATERIALS FOR OFFICE USE; ADHESIVE-BACKED LETTERS AND NUMBERS FOR USE IN MAKING PAPER CRAFTS, ALTERED ART, AND HOME DECOR;; ADHESIVES FOR STATIONERY OR HOUSEHOLD PURPOSES; ALBUMS FOR ALTERED ART, PAPER CRAFT, AND HOME DECOR;; ART PAPER; ARTISTS' BRUSHES; ARTISTS' PENS; ARTS AND CRAFT PAINT KITS; BLANK JOURNAL BOOKS; BOOKS IN THE FIELD OF ALTERED ARTS, HOME DECOR, AND PAPER CRAFT;; CARDBOARD BOXES; COFFEE TABLE BOOKS FEATURING ALTERED ART;; CRAFT PAPER; EDUCATIONAL BOOKS FEATURING PAPER CRAFT; HOME DECOR, AND ALTERED ART; EMBOSSING POWDERS; FIBERBOARD BOXES; GIFT WRAP PAPER; GUIDE BOOKS FEATURING HOW-TO ALTERED ART, PAPER CRAFT, AND HOME DECOR;; ILLUSTRATION PAPER; IMPRESSION STAMPS; INK FOR WRITING INSTRUMENTS; INK PENS; INK STAMPS; INKING PADS; LABEL PRINTING MACHINES; LIQUID PAINT FELT TIP MARKING AND COLORING APPLICATORS; MARKING STAMPS; NUMBERING STAMPS; PAINT BRUSHES; PAINTING SETS; PAINTING SETS FOR ARTISTS; PAPER; PAPER AND CARDBOARD; PAPER BOARDS; PAPER BOXES; PAPER BOXES FOR STORING GREETING CARDS; PAPER CLIPS; PAPER CONTAINERS; PAPER CUTTERS; PAPER DIE CUT SHAPES; PAPER EMBLEMS; PAPER EMBOSERS; PAPER FASTENERS; PAPER FILE JACKETS; PAPER FOLDERS; PAPER FOR USE IN THE MANUFACTURE OF ALTERED ART, PAPER CRAFT, AND HOME DECOR;; PAPER HANG TAGS; PAPER HOLE PUNCHES; PAPER LABELS; PAPER LETTERS AND NUMBER FOR USE IN MAKING ALTERED ART, PAPER CRAFT AND HOME DECOR;; PAPER RACKS; PAPER STAPLERS; PAPER STAPLES; PAPER STATIONERY; PAPER STOCK; PAPER TAGS; PAPER TRANSPARENCIES; PASTES AND OTHER ADHESIVES FOR STATIONERY OR HOUSEHOLD PURPOSES; PEN INK REFILLS; PHOTO STORAGE BOXES; PRINT LETTERS AND BLOCKS; PRINTED INSTRUCTIONAL, EDUCATIONAL, AND TEACHING MATERIALS IN THE FIELD OF PAPER CRAFTS, ALTERED ART, AND HOME DECOR;; PROTECTIVE COVERS FOR SHEETS OR PAPER AND PAGES OF BOOKS AND THE LIKE; RUBBER STAMPS; SERIES OF NON-FICTION BOOKS IN THE FIELD OF ALTERED ART, HOME DECOR, AND PAPER CRAFTS;; SKETCH BOOKS; STAMP INKS; STAMP PAD INKS; STAMP PADS; STAMPING INKS; STATIONERY BOXES;

STORAGE CONTAINERS MADE OF PAPER; VINYL LETTERS AND NUMBER FOR USE IN MAKING ALTERED ART; WIREBOUND BOOKS; WRITING INK (U.S. CLS. 2, 5, 22, 23, 29, 37, 38 AND 50).

FIRST USE 4-1-2003; IN COMMERCE 2-5-2004.

CLASS 18—LEATHER GOODS

FOR ALL-PURPOSE CARRYING BAGS; BARREL BAGS; BOOK BAGS; CARRY-ALL BAGS; COSMETIC BAGS SOLD EMPTY; KIT BAGS; LUGGAGE; ROLL BAGS; TOOL BAGS SOLD EMPTY; TOTE BAGS; TRAVEL BAGS (U.S. CLS. 1, 2, 3, 22 AND 41).

FIRST USE 1-1-2006; IN COMMERCE 7-21-2006.

ESTHER A. BORSUK, EXAMINING ATTORNEY

SN 77-074,852. PIZZA HUT, INC., DALLAS, TX. FILED 1-3-2007.



OWNER OF U.S. REG. NOS. 2,439,156, 2,523,071 AND OTHERS.

THE MARK CONSISTS OF A STYLIZED REPRESENTATION OF A ROOF.

CLASS 16—PAPER GOODS AND PRINTED MATTER

FOR PRINTED MATTER, NAMELY, ADDRESS BOOKS, ADDRESS LABELS, PAPER AND PLASTIC BAGS FOR GENERAL USE, BANK CHECKS, PAPER BANNERS, BOOK COVERS, CHECK BOOK COVERS AND HOLDERS, APPOINTMENT BOOKS, CARDBOARD AND PAPER BOXES, BUMPER STICKERS, STICKERS, BUSINESS CARDS AND FORMS, CALENDARS, NOTE CARDS, CARDBOARD AND PAPER CONTAINERS, COUPONS, DAILY PLANNERS, DATE BOOKS, DECALS, DESK CALENDARS, ENVELOPES, ACCOUNTING, BOOKKEEPING AND ORDER FORMS, FOUNTAIN PENS, PENCILS, PEN OR PENCIL HOLDERS, NOTEBOOKS, NOTEPADS, MEMO PADS, MEMO PADS WITH ADHESIVE-BACKING, POSTERS, WRITING PAPER, PAPER NAME BADGES, PAPER NAPKINS, STATIONERY, TRAINING AND TEACHING MATERIALS, NAMELY MANAGEMENT MANUALS FOR RESTAURANT OPERATIONS (U.S. CLS. 2, 5, 22, 23, 29, 37, 38 AND 50).

CLASS 25—CLOTHING

FOR CLOTHING FOR ADULTS, CHILDREN AND INFANTS, NAMELY, SHIRTS, T-SHIRTS, POLO SHIRTS, KNIT SHIRTS, SWEATSHIRTS, NIGHT SHIRTS, PAJAMAS, GOLF SHIRTS, PANTS, SHORTS, BOXER SHORTS, GYM SHORTS, SHOES, COATS, JACKETS, SUITS, JOGGING SUITS, TENNIS WEAR, VESTS, SWEATERS, TURTLENECK AND V-NECK SWEATERS, UNDERWEAR, NECKTIES, SOCKS, HATS, CAPS, SCARVES, BELTS, BEACHWEAR, AND GLOVES (U.S. CLS. 22 AND 39).

CLASS 28—TOYS AND SPORTING GOODS

FOR TOYS, NAMELY, BASEBALLS, BASKETBALLS, FOOTBALLS, GOLF BALLS, RACKET BALLS, SOCCER BALLS, TENNIS BALLS, VOLLEY BALLS, PADDLE BALL GAMES, RUBBER ACTION BALLS, STUFFED ANIMALS, PLUSH ANIMALS, TOY ANIMAL FIGURES, GOLF BAGS, GOLF BAG COVERS, GOLF TEES, BOWLING BAGS, BALLOONS, BATH TOYS, BASEBALL AND GOLF GLOVES, BASEBALL AND SOFTBALL BATS, TOY BUILDING AND CONSTRUCTION BLOCKS, CARD AND BOARD GAMES, TOY BOXES, PLAYING CARDS, FLYING DISCS, DOLLS AND DOLL ACCESSORIES, WIND-UP TOYS, TOY VEHICLES AND TOY VEHICLE ACCESSORIES, TOY GUNS, TOY BANKS, KITES, PUZZLES, SKIS, SKATEBOARDS, ROLLER AND ICE SKATES, AND YO-YOS (U.S. CLS. 22, 23, 38 AND 50).

CLASS 29—MEATS AND PROCESSED FOODS

FOR MEAT, FISH, POULTRY AND GAME; MEAT EXTRACTS; PRESERVED, DRIED AND COOKED FRUITS AND VEGETABLES; MEAT JELLIES, JAMS, COMPOTES; EGGS, MILK AND MILK PRODUCTS, EXCLUDING ICE CREAM, ICE MILK AND FROZEN YOGURT; EDIBLE OILS AND FATS; CHEESES; SALADS; COOKING OILS; COOKED MEAT TOPPINGS FOR USE ON PIZZA, CHEESE TOPPINGS FOR USE ON PIZZAS, FRUIT TOPPINGS AND FRESH VEGETABLE TOPPINGS FOR PIZZA (U.S. CL. 46).

CLASS 30—STAPLE FOODS

FOR COFFEE, TEA, COCOA, SUGAR, RICE, TAPIOCA, SAGO, ARTIFICIAL COFFEE; FLOUR AND PREPARATIONS MADE FROM CEREALS, BREAD, FLOUR AND PREPARATIONS MADE FROM CEREALS, BREAD, PASTRY; ICE; HONEY, TREACLE; YEAST, BAKING-POWDER; SALT, MUSTARD; VINEGAR, SAUCES, SPICES; SEASONINGS; ROLLS, BISCUITS, CAKES, PIZZAS; PIZZA PIE CRUSTS; PIZZA SAUCES; PIZZA DOUGH; PASTA, SPAGHETTI; PREPARED PASTA ENTREES AND SALAD DRESSINGS, FRUIT JELLIES (U.S. CL. 46).

CLASS 43—HOTEL AND RESTAURANT SERVICES

FOR RESTAURANT SERVICES (U.S. CLS. 100 AND 101).

DORITT L. CARROLL, EXAMINING ATTORNEY

SN 77-076,628. HEARST COMMUNICATIONS, INC., NEW YORK, NY. FILED 1-5-2007.

ESQUIRE

THE MARK CONSISTS OF STANDARD CHARACTERS WITHOUT CLAIM TO ANY PARTICULAR FONT, STYLE, SIZE, OR COLOR.

OWNER OF U.S. REG. NOS. 313,768, 1,489,930 AND OTHERS.

CLASS 16—PAPER GOODS AND PRINTED MATTER

FOR EXECUTIVE DESK SETS, COMPRISED OF SOME OR ALL OF THE FOLLOWING GOODS, BLOTTERS, PEN AND PENCIL HOLDERS, STAPLERS, BUSINESS CARD HOLDERS, AND PUZZLE PAPERWEIGHTS AND INTERACTIVE PAPERWEIGHTS (U.S. CLS. 2, 5, 22, 23, 29, 37, 38 AND 50).

CLASS 28—TOYS AND SPORTING GOODS

FOR EXECUTIVE TOYS, NAMELY, DESKTOP POOL TABLES, DESKTOP STRESS RELIEVING TOYS, NAMELY, STRESS BALLS FOR SQUEEZING, DICE, EXECUTIVE BOARD GAMES, FOOTBALLS, BASKETBALLS, CHESS AND CHECKERS SETS (U.S. CLS. 22, 23, 38 AND 50).

DAVID I, EXAMINING ATTORNEY

SN 77-079,080. KOHL'S ILLINOIS, INC., AURORA, IL. FILED 1-9-2007.

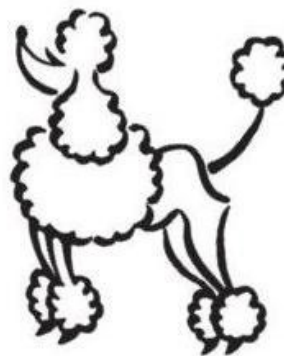

THE MARK CONSISTS OF AN OUTLINE OF A POODLE.

CLASS 9—ELECTRICAL AND SCIENTIFIC APPARATUS

FOR SUNGLASSES (U.S. CLS. 21, 23, 26, 36 AND 38).

CLASS 14—JEWELRY

FOR JEWELRY; WATCHES (U.S. CLS. 2, 27, 28 AND 50).

CLASS 18—LEATHER GOODS

FOR PURSES; CARRY-ALL BAGS; WALLETS (U.S. CLS. 1, 2, 3, 22 AND 41).

CLASS 25—CLOTHING

FOR CLOTHING AND APPAREL PRODUCTS, NAMELY, TOPS, PANTS, SHORTS, SKIRTS, DRESSES, JEANS, SLEEPWEAR, LOUNGEWEAR, ROBES, SOCKS, HOSIERY, JACKETS, UNDERGARMENTS, UNDERWEAR, INTIMATE APPAREL, NAMELY, PANTIES, BRAS, AND LINGERIE, SHOES, FOOTWEAR, SWEATERS, JUMPERS, OVERALLS, COATS, BELTS, GLOVES, HATS, MITTENS, AND SCARVES (U.S. CLS. 22 AND 39).

CLASS 26—FANCY GOODS

FOR HAIR ACCESSORIES, NAMELY BARRETTES, CLIPS, BANDS, AND SCRUNCHIES (U.S. CLS. 37, 39, 40, 42 AND 50).

WON TEAK OH, EXAMINING ATTORNEY

SN 77-079,327. HEALING HEALTHCARE SYSTEMS, INC.,
RENO, NV. FILED 1-9-2007.



NO CLAIM IS MADE TO THE EXCLUSIVE RIGHT TO USE HEALTHCARE AND SYSTEMS, APART FROM THE MARK AS SHOWN.

THE MARK CONSISTS OF A SOLID OVAL WITH A REVERSED JAGGED LINE SIMILAR TO A CARDIAC READING OF A HEART BEAT FOLLOWED BY A MUSICAL STAFF AT A SLIGHT UPWARD ANGLE.

CLASS 9—ELECTRICAL AND SCIENTIFIC APPARATUS

FOR AUDIO AND VIDEO PRODUCTS, NAMELY, CDS, DVDS, TAPES, CASSETTES, AND OTHER DIGITAL MEDIA IN THE FIELD OF RELAXATION MUSIC FOR PATIENTS, CONTINUING NURSING EDUCATION, AND CONTINUING MEDICAL EDUCATION, AND FOR MARKETING DEMONSTRATION PRODUCTS OF CD, DVD'S (U.S. CLS. 21, 23, 26, 36 AND 38).

FIRST USE 6-6-1995; IN COMMERCE 7-6-1995.

CLASS 41—EDUCATION AND ENTERTAINMENT

FOR PROVIDING CONTINUING NURSING AND MEDICAL EDUCATION COURSES; PRODUCTION OF TELEVISION AND RADIO PROGRAMS; ENTERTAINMENT, NAMELY, A CONTINUING SHOW FEATURING MUSIC AND IMAGES INTENDED FOR PATIENTS IN HOSPITALS BROADCAST OVER TELEVISION, SATELLITE, AUDIO, AND VIDEO MEDIA (U.S. CLS. 100, 101 AND 107).

FIRST USE 6-6-1995; IN COMMERCE 6-6-1995.
ANGELA M. MICHELI, EXAMINING ATTORNEY

SN 77-081,806. FOREVER YOUNG (PROPRIETARY) LIMITED, PRETORIA, SOUTH AFRICA, FILED 1-12-2007.



NO CLAIM IS MADE TO THE EXCLUSIVE RIGHT TO USE "ROOIBOS" AND "HEALTH & SKINCARE", APART FROM THE MARK AS SHOWN.

"THE FOREIGN WORDING IN THE MARK TRANSLATES INTO ENGLISH AS RED BUSH."

CLASS 1—CHEMICALS

FOR FATTY ACIDS FOR USE AS A FOOD ADDITIVE, ALL CONTAINING IN PART EXTRACTS OF ROOIBOS (U.S. CLS. 1, 5, 6, 10, 26 AND 46).

CLASS 3—COSMETICS AND CLEANING PREPARATIONS

FOR SOAPS; PERFUME; FRAGRANCES FOR PERSONAL USE; COLOGNES; ESSENTIAL OILS; COSMETICS; SHAMPOOS; HAIR RINSES; FACIAL WASHES; TOILET WATER AND TOILET SOAP; COSMETIC PREPARATIONS FOR BODY CARE; BODY AND BEAUTY CARE PREPARATIONS; AND NON-MEDICATED SKIN CARE PREPARATIONS, ALL CONTAINING IN PART EXTRACTS OF ROOIBOS AND SPECIFICALLY EXCLUDING MAKE-UP PENCILS, LIPSTICKS, AND POWDERED MAKE-UP (U.S. CLS. 1, 4, 6, 50, 51 AND 52).

CLASS 5—PHARMACEUTICALS

FOR BABY FOOD; FOOD FOR MEDICALLY RESTRICTED DIETS; DIETETIC FOODS ADAPTED FOR MEDICAL USE; PLANT EXTRACTS FOR MEDICAL, VETERINARY, AND PHARMACEUTICAL PURPOSES; DIETARY AND NUTRITIONAL MEAL REPLACEMENT BARS AND DRINKS; FOOD SUPPLEMENTS; NUTRITIONALLY FORTIFIED BEVERAGES; VITAMIN FORTIFIED BEVERAGES; VITAMIN AND MINERAL SUPPLEMENTS; NUTRITIONAL PROTEIN SUPPLEMENTS; BISCUITS, BREAD, BREAD ROLLS, CAKES, CEREAL PRODUCTS, CONFECTIONERY, CRACKERS, NOODLES, FISH SAUCE, RELISH, SAUCES, CEREAL-BASED SNACK-FOODS, AND PREPARED DIETARY ITEMS THAT ARE GLUTEN-FREE TO ACCOMMODATE SPECIAL MEDICAL AND HEALTH CONDITIONS; SANITARY PREPARATIONS FOR MEDICAL USE; ALL PURPOSE DISINFECTANTS; PREPARATIONS FOR DESTROYING VERMIN; FUNGICIDES; HERBAL TEAS FOR MEDICINAL PURPOSES; HERBICIDES FOR DOMESTIC USE; HERBAL SUPPLEMENTS; MEDICINAL HERBAL EXTRACTS FOR MEDICAL PURPOSES; MEDICINAL HERB EXTRACTS; VITAMIN AND MINERAL PREPARATIONS FOR MEDICAL USE; HOMEOPATHIC SUPPLEMENTS; ANTI-OXIDANTS; VITAMINS; AND MINERAL SUPPLEMENTS, ALL CONTAINING IN PART EXTRACTS OF ROOIBOS (U.S. CLS. 6, 18, 44, 46, 51 AND 52).

CLASS 35—ADVERTISING AND BUSINESS

FOR RETAIL STORES SERVICES IN THE FIELD OF COSMETICS; WHOLESALE DISTRIBUTORSHIP FEATURING COSMETICS; ADVERTISING, MARKETING, AND PROMOTION SERVICES; DISTRIBUTORSHIPS IN THE FIELD OF COSMETICS; PRODUCT MERCHANDISING; IMPORT AND EXPORT AGENCIES; MAIL ORDER SERVICES FEATURING COSMETICS; ADVERTISING SERVICES; BUSINESS ADMINISTRATION CONSULTANCY; BUSINESS MANAGEMENT CONSULTATION; AND FRANCHISING, NAMELY CONSULTATION AND ASSISTANCE IN BUSINESS MANAGEMENT, ORGANIZATION, AND PROMOTION (U.S. CLS. 100, 101 AND 102).

CLASS 44—MEDICAL, BEAUTY AND AGRICULTURAL SERVICES

FOR BEAUTY SALONS; HAIRDRESSING SALONS; AND HEALTH CARE SERVICES (U.S. CLS. 100 AND 101).

MIDGE BUTLER, EXAMINING ATTORNEY

SN 77-081,864. KERRY EARNHARDT, INC., MOORESVILLE, NC. FILED 1-12-2007.

JEFFREY EARNHARDT

THE MARK CONSISTS OF STANDARD CHARACTERS WITHOUT CLAIM TO ANY PARTICULAR FONT, STYLE, SIZE, OR COLOR.

"THE NAME(S), PORTRAIT(S), AND/OR SIGNATURE(S) SHOWN IN THE MARK IDENTIFIES JEFFREY EARNHARDT, WHOSE CONSENT(S) TO REGISTER IS SUBMITTED."

CLASS 28—TOYS AND SPORTING GOODS

FOR MINIATURE REPLICA AUTOMOBILES (U.S. CLS. 22, 23, 38 AND 50).

CLASS 41—EDUCATION AND ENTERTAINMENT

FOR ENTERTAINMENT SERVICES IN THE NATURE OF PARTICIPATING IN PROFESSIONAL AUTOMOBILE RACES AND EXHIBITIONS (U.S. CLS. 100, 101 AND 107).

FIRST USE 10-1-2006; IN COMMERCE 10-10-2006.
MIDGE BUTLER, EXAMINING ATTORNEY

SN 77-081,957. TRAGEDY ASSISTANCE PROGRAM FOR SURVIVORS, INC., WASHINGTON, DC. FILED 1-12-2007.



The logo consists of the word "TAPS" in a bold, serif font. Each letter is black with a white outline. There are three small, five-pointed stars positioned between the letters: one between 'T' and 'A', one between 'A' and 'P', and one between 'P' and 'S'.

CLASS 16—PAPER GOODS AND PRINTED MATTER

FOR PRINTED MATERIALS, NAMELY, MAGAZINES AND BROCHURES DIRECTED TO GRIEF AND BEREAVEMENT MANAGEMENT AND SUPPORT FOR FAMILIES, FRIENDS AND LOVED ONES OF MILITARY PEOPLE WHO HAVE DIED IN THE LINE OF DUTY (U.S. CLS. 2, 5, 22, 23, 29, 37, 38 AND 50).

FIRST USE 10-11-1994; IN COMMERCE 10-11-1994.

CLASS 41—EDUCATION AND ENTERTAINMENT

FOR EDUCATIONAL SERVICES, NAMELY, OFFERING SEMINARS AND PROGRAMS IN THE FIELD OF GRIEF MANAGEMENT AND BEREAVEMENT SUPPORT SERVICES; EDUCATIONAL SEMINARS RELATING TO GOVERNMENT BENEFITS FOR THOSE WHO HAVE LOST A LOVED ONE IN THE MILITARY SERVICE; PROVIDING CONSULTATION AND SUPPORT, NAMELY, EDUCATION SERVICES, NAMELY, PROVIDING SEMINARS TO ORGANIZATIONS DEALING WITH BEREAVEMENT ABOUT THE GRIEVING PROCESS AND PROVIDING TIPS TO ENABLE THEM TO SUPPORT THOSE WHO HAVE LOST A LOVED ONE IN MILITARY SERVICE; ONLINE INFORMATION SERVICES IN THE FIELD OF GRIEF AND TRAUMA SUPPORT AND MANAGEMENT SERVICES, NAMELY, PROVIDING ON-LINE PUBLICATIONS IN THE NATURE OF THE DEPARTMENT OF DEFENSE HANDBOOK AND ARTICLES ON GRIEF AND GRIEVING (U.S. CLS. 100, 101 AND 107).

FIRST USE 10-11-2004; IN COMMERCE 10-11-2004.

CLASS 45—PERSONAL AND LEGAL SERVICES

FOR CONSULTATION AND SUPPORT SERVICES, NAMELY, PROVIDING PERSONAL SUPPORT FOR FAMILIES, FRIENDS AND LOVED ONES OF MILITARY PEOPLE WHO HAVE DIED IN THE LINE OF DUTY, NAMELY, PEER-BASED EMOTIONAL SUPPORT; DEVELOPMENT AND MAINTENANCE OF LOCAL SUPPORT GROUPS AND BEREAVEMENT CONSULTING IN THE SURVIVOR'S LOCAL COMMUNITY; TELEPHONE HOTLINE COUNSELING, NAMELY, OFFERING CRISIS INTERVENTION SERVICES, NAMELY, A 24 HOUR HOTLINE AVAILABLE FOR FAMILIES TO CALL IN CASE OF PERSONAL CRISIS, AND A NATIONWIDE NETWORK OF POLICE CHAPLAINS WHO CAN PERSONALLY RESPOND TO THOSE WHO HAVE LOST A LOVED ONE IN MILITARY SERVICE; PROVIDING GRIEF COUNSELING RESOURCES, NAMELY, PROVIDING A LIST OF NAMES OF SUPPORT GROUPS AND COUNSELORS SPECIALIZING IN BEREAVEMENT AND GRIEVING; PROVIDING LISTS OF OTHER ONLINE GRIEF RESOURCES FOR MILITARY SURVIVORS; ALL OF THE ABOVE BEING FOR FAMILIES, FRIENDS AND LOVED ONES OF MILITARY PEOPLE WHO HAVE DIED IN THE LINE OF DUTY (U.S. CLS. 100 AND 101).

FIRST USE 10-11-1994; IN COMMERCE 10-11-1994.
STEVEN JACKSON, EXAMINING ATTORNEY

SN 77-083,510. BURNLOUNGE, INC., NEW YORK, NY. FILED 1-16-2007.



OWNER OF U.S. REG. NO. 3,095,058.
THE MARK CONSISTS OF A FLAME IN A CIRCLE.

CLASS 16—PAPER GOODS AND PRINTED MATTER

FOR PRINTED PERIODICAL FEATURING UNIQUE PERSPECTIVES ON ENTERTAINMENT, BUSINESS AND TECHNOLOGY (U.S. CLS. 2, 5, 22, 23, 29, 37, 38 AND 50).

FIRST USE 5-1-2005; IN COMMERCE 5-1-2005.

CLASS 35—ADVERTISING AND BUSINESS

FOR ONLINE RETAIL STORE SERVICES FEATURING DIGITAL ENTERTAINMENT IN THE FORM OF MUSICAL PERFORMANCES ON VIDEOS, FILM CLIPS, PHOTOGRAPHS AND OTHER MULTIMEDIA MATERIALS (U.S. CLS. 100, 101 AND 102).

FIRST USE 2-1-2004; IN COMMERCE 2-1-2004.

CLASS 41—EDUCATION AND ENTERTAINMENT

FOR ENTERTAINMENT SERVICES, NAMELY, PROVIDING INFORMATION ABOUT DIGITAL ENTERTAINMENT IN THE NATURE OF VIDEOS, FILM CLIPS, PHOTOGRAPHS, DIGITAL MUSICAL RELEASES, MUSICAL PERFORMANCES AND MUSICAL VIDEOS, PROVIDING INFORMATION ABOUT NEW MUSICAL ARTISTS AND NEW RELEASES, AND PROVIDING ONLINE REVIEWS OF NEW DIGITAL MUSICAL RELEASES, MUSICAL PERFORMANCES AND MUSICAL VIDEOS (U.S. CLS. 100, 101 AND 107).

FIRST USE 2-1-2004; IN COMMERCE 2-1-2004.

WILLIAM ROSSMAN, EXAMINING ATTORNEY

SN 77-088,397. S&S CYCLE, INC., LACROSSE, WI. FILED 1-22-2007.

X-WEDGE

THE MARK CONSISTS OF STANDARD CHARACTERS WITHOUT CLAIM TO ANY PARTICULAR FONT, STYLE, SIZE, OR COLOR.

CLASS 7—MACHINERY

FOR MOTORCYCLE ENGINE PARTS, NAMELY, AIR CLEANERS, MUFFLERS, OIL PUMPS, CYLINDER HEADS, ENGINE INTAKE AND EXHAUST VALVES, VALVE SPRINGS, VALVE AND TAPPET GUIDES, CRANKCASES, CYLINDERS, FLYWHEELS, ROCKER ARMS AND COVERS, INTAKE MANIFOLDS, EXHAUST PIPES, TAPPET BLOCKS AND LIFTERS, PUSHRODS, PUSHROD TUBE COVERS, TRANSMISSION KICK STARTER CONVERTERS, CAMSHAFTS, CONNECTING RODS, GEARS, GEAR COVERS, HOUSINGS, FUEL INJECTORS, CARBURETORS, AND REPLACEMENT PARTS THEREFORE (U.S. CLS. 13, 19, 21, 23, 31, 34 AND 35).

CLASS 12—VEHICLES

FOR MOTORCYCLE PARTS, NAMELY, SPRING KITS COMPRISED OF BALL SPRINGS, COLLARS AND KEEPERS; MOTORCYCLE PARTS, NAMELY, AIR HORNS, SEATS, ENGINES, DRIVELINES, SPROCKETS, DRIVE CHAINS, DRIVE BELTS, CLUTCHES, TRANSMISSION CASES, TRANSMISSION GEARS, TRANSMISSIONS, SPROCKET SHAFTS AND PINION SHAFTS, MOTORCYCLE ENGINES, ENGINES FOR LAND VEHICLES, AND REPLACEMENT PARTS THEREFORE (U.S. CLS. 19, 21, 23, 31, 35 AND 44).

JEFF DEFORD, EXAMINING ATTORNEY

SN 77-088,428. S&S CYCLE, INC., LACROSSE, WI. FILED 1-22-2007.



THE MARK CONSISTS OF XWEDGE (STYLIZED LETTERS).

CLASS 7—MACHINERY

FOR MOTORCYCLE ENGINE PARTS, NAMELY, AIR CLEANERS, MUFFLERS, OIL PUMPS, CYLINDER HEADS, ENGINE INTAKE AND EXHAUST VALVES, VALVE SPRINGS, VALVE AND TAPPET GUIDES, CRANKCASES, CYLINDERS, FLYWHEELS, ROCKER ARMS AND COVERS, INTAKE MANIFOLDS, EXHAUST PIPES, TAPPET BLOCKS AND LIFTERS, PUSHRODS, PUSHROD TUBE COVERS, TRANSMISSION KICK STARTER CONVERTERS, CAMSHAFTS, CONNECTING RODS, GEARS, GEAR COVERS, HOUSINGS, FUEL INJECTORS, CARBURETORS, AND REPLACEMENT PARTS THEREFORE (U.S. CLS. 13, 19, 21, 23, 31, 34 AND 35).

CLASS 12—VEHICLES

FOR MOTORCYCLE PARTS, NAMELY, SPRING KITS COMPRISED OF VALVE SPRINGS, COLLARS AND KEEPERS; MOTORCYCLE PARTS, NAMELY, AIR HORNS, SEATS, ENGINES, DRIVELINES, SPROCKETS, DRIVE CHAINS, DRIVE BELTS, CLUTCHES, TRANSMISSION CASES, TRANSMISSION GEARS, TRANSMISSIONS, SPROCKET SHAFTS AND PINION SHAFTS, MOTORCYCLE ENGINES, ENGINES FOR LAND VEHICLES, AND REPLACEMENT PARTS THEREFORE (U.S. CLS. 19, 21, 23, 31, 35 AND 44).

JEFF DEFORD, EXAMINING ATTORNEY

SN 77-090,176. IXETIC GMBH, 61352 BAD HOMBURG, FED REP GERMANY, FILED 1-24-2007.

IXETIC

THE MARK CONSISTS OF STANDARD CHARACTERS WITHOUT CLAIM TO ANY PARTICULAR FONT, STYLE, SIZE, OR COLOR.

OWNER OF FED REP GERMANY REG. NO. 30646934, DATED 10-12-2006, EXPIRES 10-12-2016.

CLASS 7—MACHINERY

FOR MACHINERY PARTS, NAMELY, COUPLING AND TRANSMISSION COMPONENTS, PUMPS AND COMPRESSORS; MACHINE TOOLS FOR MANUFACTURE OF AUTO PARTS; AUTOMOBILE PARTS, NAMELY, AIR CONDITIONING COMPRESSORS AND OIL LUBRICATING PUMPS (U.S. CLS. 13, 19, 21, 23, 31, 34 AND 35).

CLASS 12—VEHICLES

FOR AUTOMOBILE PARTS, NAMELY, POWER STEERING PUMPS, GEAR PUMPS, GEARS, GEAR COMPONENTS, POWER STEERING COMPONENTS, CHASSIS PUMPS FOR RIDE STABILIZATION SYSTEMS AND VACUUM PUMPS FOR BRAKING SYSTEMS (U.S. CLS. 19, 21, 23, 31, 35 AND 44).

BENJAMIN ALLEN, EXAMINING ATTORNEY

SN 77-090,504. SAN-IT-SAFE INC., LOS ANGELES, CA.
FILED 1-24-2007.

purespace

THE MARK CONSISTS OF STANDARD CHARACTERS WITHOUT CLAIM TO ANY PARTICULAR FONT, STYLE, SIZE, OR COLOR.

CLASS 10—MEDICAL APPARATUS

FOR STERILIZATION UNITS FOR MEDICAL INSTRUMENTS (U.S. CLS. 26, 39 AND 44).

CLASS 11—ENVIRONMENTAL CONTROL APPARATUS

FOR SANITIZING AND STERILIZATION APPLIANCE, FOR HOME USE AND PROFESSIONAL USE, FOR DENTURES, TOOTHBRUSHES, MOUTH GUARDS, BABY PACIFIERS AND BOTTLES, RAZORS, BATH ITEMS, MAKEUP AND COSMETIC TOOLS, JEWELRY AND OTHER PERSONAL ITEMS USING STEAM AS A SANITIZING AGENT (U.S. CLS. 13, 21, 23, 31 AND 34).
ANNE MADDEN, EXAMINING ATTORNEY

SN 77-091,582. TRITON DISTRIBUTION SYSTEMS, INC., SAUSALITO, CA. FILED 1-25-2007.

TRITON

THE MARK CONSISTS OF STANDARD CHARACTERS WITHOUT CLAIM TO ANY PARTICULAR FONT, STYLE, SIZE, OR COLOR.

CLASS 9—ELECTRICAL AND SCIENTIFIC APPARATUS

FOR COMPUTER SOFTWARE FOR BUSINESSES IN THE TRAVEL INDUSTRY TO CREATE AN ELECTRONIC CATALOG TO SHARE, EXCHANGE, MANAGE, DISTRIBUTE AND PROMOTE INFORMATION WITH EACH OTHER AND WITH CONSUMERS REGARDING AVAILABLE INVENTORY AND RESERVATIONS IN REAL TIME VIA A GLOBAL COMPUTER NETWORK; COMPUTER SOFTWARE FOR MAKING AND VIEWING RESERVATIONS AND FOR VIEWING TRAVEL INFORMATION FOR USE BY TRAVEL INDUSTRY PROFESSIONALS (U.S. CLS. 21, 23, 26, 36 AND 38).

CLASS 39—TRANSPORTATION AND STORAGE

FOR PROVIDING TRAVEL INFORMATION SERVICES VIA A GLOBAL COMPUTER NETWORK; PROVIDING INFORMATION ABOUT TRAVEL DESTINATIONS VIA A GLOBAL COMPUTER NETWORK; PROVIDING AN INTERACTIVE DATABASE IN THE FIELD OF TRAVEL, NAMELY, A DATABASE FOR BUSINESSES AND CONSUMERS IN THE TRAVEL INDUSTRY TO SHARE, EXCHANGE, MANAGE, DISTRIBUTE AND PROMOTE AVAILABLE TRAVEL INVENTORY AND RESERVATIONS (U.S. CLS. 100 AND 105).

CLASS 42—SCIENTIFIC AND COMPUTER SERVICES

FOR ONLINE, NON-DOWNLOADABLE SOFTWARE FOR PROVIDING TRAVEL INVENTORY IN REAL TIME AND ACCESSIBLE VIA A GLOBAL COMPUTER NETWORK; PROVIDING ONLINE NON-DOWNLOADABLE SOFTWARE FOR SHARING, EXCHANGING, MANAGING, DISTRIBUTING AND PROMOTING INFORMATION ABOUT AVAILABLE INVENTORY AND RESERVATIONS, FOR USE BY BUSINESSES AND CONSUMERS IN THE TRAVEL INDUSTRY (U.S. CLS. 100 AND 101).

REBECCA EISINGER, EXAMINING ATTORNEY

SN 77-091,584. TRITON DISTRIBUTION SYSTEMS, INC., SAUSALITO, CA. FILED 1-25-2007.



THE MARK CONSISTS OF THE FORM OF A WAVE OR DOVE ABOVE THE WORD TRITON.

CLASS 9—ELECTRICAL AND SCIENTIFIC APPARATUS

FOR COMPUTER SOFTWARE FOR BUSINESSES IN THE TRAVEL INDUSTRY TO CREATE AN ELECTRONIC CATALOG TO SHARE, EXCHANGE, MANAGE, DISTRIBUTE AND PROMOTE INFORMATION WITH EACH OTHER AND WITH CONSUMERS REGARDING AVAILABLE INVENTORY AND RESERVATIONS IN REAL TIME VIA A GLOBAL COMPUTER NETWORK; COMPUTER SOFTWARE FOR MAKING AND VIEWING RESERVATIONS AND FOR VIEWING TRAVEL INFORMATION FOR USE BY TRAVEL INDUSTRY PROFESSIONALS (U.S. CLS. 21, 23, 26, 36 AND 38).

CLASS 39—TRANSPORTATION AND STORAGE

FOR PROVIDING TRAVEL INFORMATION SERVICES VIA A GLOBAL COMPUTER NETWORK; PROVIDING INFORMATION ABOUT TRAVEL DESTINATIONS VIA A GLOBAL COMPUTER NETWORK; PROVIDING AN INTERACTIVE DATABASE IN THE FIELD OF TRAVEL, NAMELY, A DATABASE FOR BUSINESSES AND CONSUMERS IN THE TRAVEL INDUSTRY TO SHARE, EXCHANGE, MANAGE, DISTRIBUTE AND PROMOTE AVAILABLE TRAVEL INVENTORY AND RESERVATIONS (U.S. CLS. 100 AND 105).

CLASS 42—SCIENTIFIC AND COMPUTER SERVICES

FOR ONLINE, NON-DOWNLOADABLE SOFTWARE FOR PROVIDING TRAVEL INVENTORY IN REAL TIME AND ACCESSIBLE VIA A GLOBAL COMPUTER NETWORK; PROVIDING ONLINE NON-DOWNLOADABLE SOFTWARE FOR SHARING, EXCHANGING, MANAGING, DISTRIBUTING AND PROMOTING INFORMATION ABOUT AVAILABLE INVENTORY AND RESERVATIONS, FOR USE BY BUSINESSES AND CONSUMERS IN THE TRAVEL INDUSTRY (U.S. CLS. 100 AND 101).

REBECCA EISINGER, EXAMINING ATTORNEY

SN 77-092,098. LIAN HWA FOODS (USA), INC., UNION CITY, CA. FILED 1-26-2007.



THE COLOR(S) GOLD IS/ARE CLAIMED AS A FEATURE OF THE MARK.

THE MARK CONSISTS OF SOGO.

"THE NON-LATIN CHARACTER(S) IN THE MARK TRANSLITERATES INTO ABALONE SHARKFIN, AND THIS MEANS ABALONE SHARKFIN IN ENGLISH."

CLASS 16—PAPER GOODS AND PRINTED MATTER

FOR PRINTED RECIPES SOLD AS A COMPONENT OF FOOD PACKAGING (U.S. CLS. 2, 5, 22, 23, 29, 37, 38 AND 50).

CLASS 40—MATERIAL TREATMENT

FOR FOOD CANNING (U.S. CLS. 100, 103 AND 106).

CLASS 43—HOTEL AND RESTAURANT SERVICES

FOR FOOD PREPARATION SERVICES (U.S. CLS. 100 AND 101).

KIMBERLY PERRY, EXAMINING ATTORNEY

SN 77-092,265. COMMUNITY CONNECT INC., NEW YORK, NY. FILED 1-26-2007.



NO CLAIM IS MADE TO THE EXCLUSIVE RIGHT TO USE GAY AND LESBIAN, APART FROM THE MARK AS SHOWN.

CLASS 35—ADVERTISING AND BUSINESS

FOR ADVERTISING SERVICES, NAMELY, PROMOTING THE GOODS AND SERVICES OF OTHERS THROUGH THE DISSEMINATION OF ADVERTISING MATERIALS VIA THE INTERNET; PROVIDING INFORMATION IN THE FIELD OF GOVERNMENT AFFAIRS, POLITICS AND EMPLOYMENT OPPORTUNITIES TO INDIVIDUALS OF COMMON SOCIAL AFFINITIES AND ATTRIBUTES (U.S. CLS. 100, 101 AND 102).

CLASS 38—COMMUNICATION

FOR ELECTRONIC MAIL SERVICES; PROVIDING ON-LINE CHAT ROOMS FOR TRANSMISSION OF MESSAGES AMONG COMPUTER USERS CONCERNING TOPICS OF GENERAL INTEREST TO INDIVIDUALS OF COMMON SOCIAL AFFINITIES AND ATTRIBUTES (U.S. CLS. 100, 101 AND 104).

CLASS 41—EDUCATION AND ENTERTAINMENT

FOR PROVIDING ONLINE CURRENT EVENTS NEWS AND INFORMATION CONCERNING SUBJECTS AND TOPICS OF INTEREST TO INDIVIDUALS OF COMMON SOCIAL AFFINITIES AND ATTRIBUTES, INCLUDING ENTERTAINMENT SUBJECTS AND TOPICS OF INTEREST TO INDIVIDUALS OF COMMON SOCIAL AFFINITIES AND ATTRIBUTES; PROVIDING ONLINE INFORMATION AND NEWS IN THE FIELD OF EMPLOYMENT TRAINING CONCERNING SUBJECTS AND TOPICS OF INTEREST TO INDIVIDUALS OF COMMON SOCIAL AFFINITIES AND ATTRIBUTES (U.S. CLS. 100, 101 AND 107).

CLASS 42—SCIENTIFIC AND COMPUTER SERVICES

FOR PROVIDING CUSTOMIZED ON-LINE WEB PAGES FEATURING USER-DEFINED INFORMATION, WHICH INCLUDES SEARCH ENGINES AND ONLINE WEB LINKS TO OTHER WEB SITES (U.S. CLS. 100 AND 101).

NICHOLAS ALTREE, EXAMINING ATTORNEY

SN 77-098,112. LEGISDISCOVERY, LLC, MCLEAN, VA. FILED 2-2-2007.

LDISCOVERYCONSULTING

THE MARK CONSISTS OF STANDARD CHARACTERS WITHOUT CLAIM TO ANY PARTICULAR FONT, STYLE, SIZE, OR COLOR.

CLASS 35—ADVERTISING AND BUSINESS

FOR BUSINESS CONSULTING AND AUDITING IN THE FIELD OF INFORMATION TECHNOLOGY SYSTEMS AND COMPUTER FORENSIC INVESTIGATIONS; BUSINESS ENQUIRIES AND INVESTIGATIONS; BUSINESS EXPERT EVALUATIONS AND PREPARING BUSINESS REPORTS RELATING TO COMPUTER FORENSIC INVESTIGATIONS, ELECTRONIC DISCOVERY, AND FILE RETENTION (U.S. CLS. 100, 101 AND 102).

CLASS 42—SCIENTIFIC AND COMPUTER SERVICES

FOR CONDUCTING COMPUTER FORENSIC INVESTIGATIONS; PROVIDING ELECTRONIC DISCOVERY SERVICES; TECHNICAL EXPERT EVALUATIONS AND REPORTS RELATING TO COMPUTER FORENSIC INVESTIGATIONS, ELECTRONIC DISCOVERY, AND FILE RETENTION; COMPUTER SERVICES, NAMELY ACTING AS AN APPLICATION SERVICE PROVIDER IN THE FIELD OF ELECTRONIC DISCOVERY TO PROVIDE, HOST, MANAGE, DEVELOP, AND MAINTAIN ELECTRONIC DATABASES FOR STORAGE AND SHARING OF DATA AND INFORMATION (U.S. CLS. 100 AND 101).

CLASS 45—PERSONAL AND LEGAL SERVICES

FOR BACKGROUND INVESTIGATION AND RESEARCH SERVICES; LITIGATION SUPPORT SERVICES AND LEGAL CONSULTATION SERVICES (U.S. CLS. 100 AND 101).

KEVON CHISOLM, EXAMINING ATTORNEY

SN 77-101,336. CHEN, JER, TAIPEI, TAIWAN, FILED 2-7-2007.

ROSE TANGO

THE MARK CONSISTS OF STANDARD CHARACTERS WITHOUT CLAIM TO ANY PARTICULAR FONT, STYLE, SIZE, OR COLOR.

NO CLAIM IS MADE TO THE EXCLUSIVE RIGHT TO USE "ROSE", APART FROM THE MARK AS SHOWN.

"THE NAME(S), PORTRAIT(S), AND/OR SIGNATURE(S) SHOWN IN THE MARK DOES NOT IDENTIFY A PARTICULAR LIVING INDIVIDUAL."

SN 77-099,242. PUERTO RICO INDUSTRIAL DEVELOPMENT COMPANY, HATO REY, PUERTO RICO, FILED 2-5-2007.

CLASS 3—COSMETICS AND CLEANING PREPARATIONS

FOR COSMETICS, PERFUME (U.S. CLS. 1, 4, 6, 50, 51 AND 52).

CLASS 43—HOTEL AND RESTAURANT SERVICES

FOR RESTAURANT SERVICES (U.S. CLS. 100 AND 101).

NORA BUCHANAN WILL, EXAMINING ATTORNEY



Commonwealth of Puerto Rico
PUERTO RICO BIOISLAND

SN 77-103,350. OCWEN FINANCIAL CORPORATION, WEST PALM BEACH, FL. FILED 2-9-2007.

GLOBAL RECOVERY FACTORY

THE MARK CONSISTS OF STANDARD CHARACTERS WITHOUT CLAIM TO ANY PARTICULAR FONT, STYLE, SIZE, OR COLOR.

NO CLAIM IS MADE TO THE EXCLUSIVE RIGHT TO USE "GLOBAL RECOVERY", APART FROM THE MARK AS SHOWN.

NO CLAIM IS MADE TO THE EXCLUSIVE RIGHT TO USE "COMMONWEALTH OF PUERTO RICO" AND "PUERTO RICO", APART FROM THE MARK AS SHOWN.

THE COLOR(S) OLIVE AND GREEN IS/ARE CLAIMED AS A FEATURE OF THE MARK.

"THE MARK CONSISTS OF AN OLIVE GREEN DNA SPIRAL, WITH THE WORDING COMMONWEALTH OF PUERTO RICO IN LIGHT GREEN BELOW THE SPIRAL, AND THE WORDING PUERTO RICO IN LIGHT GREEN AND BIOISLAND IN OLIVE GREEN BELOW, THE WORDING COMMONWEALTH OF PUERTO RICO."

CLASS 35—ADVERTISING AND BUSINESS

FOR BUSINESS INFORMATION SERVICES IN THE FIELD OF BIOTECHNOLOGY SERVICES IN PUERTO RICO; BUSINESS INFORMATION SERVICES IN THE NATURE OF PROVIDING INFORMATION ON BUSINESS OPPORTUNITIES; BUSINESS SERVICES, NAMELY, PROCURING QUALIFIED AND CREDENTIALLED THIRD-PARTY EXPERTS, PROFESSIONALS AND OTHER QUALIFIED PERSONNEL, AND DOCUMENTATION AND INFORMATION ALL ON BEHALF OF OTHERS; CONSULTATION SERVICES IN THE FIELD OF COMPANY, BUSINESS SECTOR AND INDUSTRY DATA AND RESEARCH; DISSEMINATION OF ADVERTISEMENTS AND OF ADVERTISING MATERIAL NAMELY BROCHURES, WEBPAGES, NEWSLETTERS, FLYERS, LEAFLETS AND SAMPLES. (U.S. CLS. 100, 101 AND 102).

CLASS 41—EDUCATION AND ENTERTAINMENT

FOR ARRANGING OF SEMINARS AND CONFERENCES (U.S. CLS. 100, 101 AND 107).

ODESSA BIBBINS, EXAMINING ATTORNEY

CLASS 35—ADVERTISING AND BUSINESS

FOR BUSINESS PROCESS OUTSOURCING SERVICES (U.S. CLS. 100, 101 AND 102).

CLASS 36—INSURANCE AND FINANCIAL

FOR LOAN MANAGEMENT, LOAN SERVICING AND ORIGINATION SERVICES; MORTGAGE PROCESSING SERVICES; PROVIDING ACCOUNT INFORMATION BY TELEPHONE; CASH MANAGEMENT; CHECK CASHING; CHECK PROCESSING; FINANCIAL ANALYSIS AND CONSULTATION; FINANCIAL INVESTMENT IN THE FIELDS OF REAL ESTATE AND SECURITIES; LEASE-PURCHASE FINANCING; LOAN FINANCING; LOAN SECURITIZATION, FINANCING SERVICES; HOME EQUITY LOANS; INSTALLMENT LOANS; INVESTMENT OF FUNDS FOR OTHERS; MORTGAGE LENDING; LOAN COLLECTION SERVICES; REAL ESTATE FORECLOSURE TRUSTEE SERVICES; FINANCIAL EVALUATION OF REAL ESTATE; REAL ESTATE INVESTMENT IN LOW INCOME HOUSING TAX CREDIT PARTNERSHIPS; UNSECURED DEBT COLLECTION SERVICES (U.S. CLS. 100, 101 AND 102).

GILBERT SWIFT, EXAMINING ATTORNEY

SN 77-103,387. TENEDORA DE VALORES E INVERSIONES T.D.V.I., C.A., CARACAS, VENEZUELA, FILED 2-9-2007.

SN 77-105,296. TRANSFORMATION TEES, LLC, HACKETTSTOWN, NJ. FILED 2-12-2007.



THE COLOR(S) BLACK AND ORANGE IS/ARE CLAIMED AS A FEATURE OF THE MARK.

THE MARK CONSISTS OF STYLIZED LETTERING. THE ENGLISH TRANSLATION OF THE WORD "LEONES" IN THE MARK IS "LIONS".

CLASS 16—PAPER GOODS AND PRINTED MATTER

FOR PAPER, CARDBOARD AND GOODS MADE FROM THESE MATERIALS, NAMELY, CALENDARS, MAGAZINES IN THE FIELDS OF SPORTS AND SPORTS RELATED ACTIVITIES; BROADCAST MEDIA GUIDES; NAPKINS, PADS OF WRITING PAPER, PHOTOGRAPHS AND POSTERS, PRINTED MATTER, NAMELY, INVITATIONS, BUSINESS CARDS, WRAPPING PAPER, PAPER BAGS AND WIRE BOUND NOTEBOOKS; BOOKBINDINGS; PHOTOGRAPHS; STATIONERY; ADHESIVES FOR STATIONERY OR HOUSEHOLD PURPOSES; ARTISTS MATERIALS, NAMELY, STICKERS, ART PAPER, PHOTOGRAPH ALBUMS, AND PAINT BRUSHES; INSTRUCTIONAL AND TEACHING MATERIALS IN THE FIELDS OF SPORTS AND SPORTS RELATED ACTIVITIES, NAMELY, INSTRUCTIONAL AND INFORMATIONAL BROCHURES AND PAMPHLETS; PLASTIC BAGS FOR PACKING; PENCILS AND PENS; AND PRINTER'S TYPE (U.S. CLS. 2, 5, 22, 23, 29, 37, 38 AND 50).

CLASS 25—CLOTHING

FOR CLOTHING NAMELY, T-SHIRTS, SHORTS, SHIRTS, APRONS, BATH ROBES, PANTS, SOCKS, JACKETS, SWEATERS, CAPS, SHOES, BOOTS, PAJAMAS, SCARVES, ROBES, UNDERWEAR, BATHING SUITS, HATS, GLOVES AND EAR MUFFS (U.S. CLS. 22 AND 39).

CLASS 38—COMMUNICATION

FOR TELECOMMUNICATIONS SERVICES, NAMELY, RADIO AND TELEVISION BROADCASTING, INTERNET TRANSMISSIONS AND OTHER COMPUTER AIDED TRANSMISSIONS OF INFORMATION AND IMAGES (U.S. CLS. 100, 101 AND 104).

CLASS 41—EDUCATION AND ENTERTAINMENT

FOR ENTERTAINMENT SERVICES IN THE NATURE OF ATHLETIC EXHIBITIONS AND COMPETITIONS AND MUSICAL PERFORMANCES; EDUCATIONAL SERVICES, NAMELY, ATHLETIC TRAINING, CONFERENCES AND INSTRUCTION THROUGH CLASSES AND SEMINARS; ORGANIZING EXHIBITIONS FOR EDUCATIONAL AND CULTURAL PURPOSES IN THE FIELDS OF SPORTS AND SPORTS RELATED ACTIVITIES (U.S. CLS. 100, 101 AND 107).

VIVIAN MICZNIK FIRST, EXAMINING ATTORNEY

REFLECT YOUR POWER

THE MARK CONSISTS OF STANDARD CHARACTERS WITHOUT CLAIM TO ANY PARTICULAR FONT, STYLE, SIZE, OR COLOR.

CLASS 14—JEWELRY

FOR JEWELRY (U.S. CLS. 2, 27, 28 AND 50).

CLASS 18—LEATHER GOODS

FOR TOTE BAGS, GYM BAGS, AND CARRY-ALL BAGS (U.S. CLS. 1, 2, 3, 22 AND 41).

CLASS 25—CLOTHING

FOR CLOTHING, NAMELY T-SHIRTS AND SHIRTS, FOOTWEAR, AND HEADGEAR, NAMELY HATS AND CAPS (U.S. CLS. 22 AND 39).

YAT SYE, LEE, EXAMINING ATTORNEY

SN 77-105,350. INVENTIV HEALTH, INC., SOMERSET, NJ. FILED 2-12-2007.

PRS FRANKLIN

THE MARK CONSISTS OF STANDARD CHARACTERS WITHOUT CLAIM TO ANY PARTICULAR FONT, STYLE, SIZE, OR COLOR.

CLASS 35—ADVERTISING AND BUSINESS

FOR SAMPLING COMPLIANCE CONSULTING, NAMELY, CONSULTATION IN THE FIELD OF THE DISTRIBUTION OF FREE PRESCRIPTION DRUGS TO PHYSICIANS; SAMPLING, NAMELY, DISTRIBUTION OF FREE PRESCRIPTION DRUGS TO PHYSICIANS FOR PROMOTIONAL PURPOSES (U.S. CLS. 100, 101 AND 102).

CLASS 45—PERSONAL AND LEGAL SERVICES

FOR REGULATORY COMPLIANCE CONSULTING AS IT APPLIES TO THE PROMOTION AND DISTRIBUTION OF PRESCRIPTION DRUGS (U.S. CLS. 100 AND 101).

KATHRYN COWARD, EXAMINING ATTORNEY

SN 77-106,352. AMERICAN COLLEGE OF CARDIOLOGY, WASHINGTON, DC. FILED 2-13-2007.

SN 77-106,528. ANDRADE, MANUEL, CHICAGO, IL. FILED 2-13-2007.



THE MARK CONSISTS OF THE LETTERS "ACC" AND "CAN" SEPARATED BY A VERTICAL LINE, AND THE WORDS "CARDIOADVOCACY NETWORK" BENEATH "CAN".

CLASS 35—ADVERTISING AND BUSINESS

FOR GRASSROOTS ADVOCACY IN THE NATURE OF PROMOTIONAL SERVICES ON BEHALF OF CARDIOVASCULAR PROFESSIONALS IN THE FIELD OF CARDIOLOGY AND CARDIOVASCULAR MEDICINE AND HEALTH (U.S. CLS. 100, 101 AND 102).

FIRST USE 9-0-2005; IN COMMERCE 9-0-2005.

CLASS 44—MEDICAL, BEAUTY AND AGRICULTURAL SERVICES

FOR PROVIDING INFORMATION IN THE NATURE OF ISSUE BRIEFINGS IN THE FIELD OF CARDIOLOGY AND CARDIOVASCULAR MEDICINE AND HEALTH (U.S. CLS. 100 AND 101).

FIRST USE 9-0-2005; IN COMMERCE 9-0-2005.
JILL PRATER, EXAMINING ATTORNEY

SN 77-106,476. TODD CRANDELL, SYLVANIA, OH. FILED 2-13-2007.

Racing for Recovery

THE MARK CONSISTS OF STANDARD CHARACTERS WITHOUT CLAIM TO ANY PARTICULAR FONT, STYLE, SIZE, OR COLOR.

CLASS 41—EDUCATION AND ENTERTAINMENT

FOR ENTERTAINMENT SERVICES IN THE NATURE OF FILM NAMELY, FILM DISTRIBUTION AND MOTION PICTURE FILM PRODUCTION, TELEVISION NAMELY, ON-GOING TELEVISION PROGRAMS, AND PRINT MEDIA NAMELY, PUBLICATION OF PRINTED MEDIA ALL REGARDING TRIATHLONS (U.S. CLS. 100, 101 AND 107).

FIRST USE 10-10-2001; IN COMMERCE 10-10-2001.

CLASS 44—MEDICAL, BEAUTY AND AGRICULTURAL SERVICES

FOR SUBSTANCE ABUSE COUNSELING SERVICES, NAMELY PROVIDING ASSISTANCE IN OVERCOMING ALCOHOL OR DRUG ADDICTION (U.S. CLS. 100 AND 101).

FIRST USE 10-21-2001; IN COMMERCE 10-21-2001.
RICHARD WHITE, EXAMINING ATTORNEY

Sueño de un Héroe

THE MARK CONSISTS OF STANDARD CHARACTERS WITHOUT CLAIM TO ANY PARTICULAR FONT, STYLE, SIZE, OR COLOR.

THE ENGLISH TRANSLATION OF SUEÑO DE UN HÉROE IS DREAM OF A HERO.

CLASS 9—ELECTRICAL AND SCIENTIFIC APPARATUS

FOR MUSICAL SOUND RECORDINGS; FEATURING MUSIC; DOWNLOADABLE MP3 FILES, MP3 RECORDINGS, ONLINE DISCUSSION BOARDS, WEB CASTS, POD CASTS FEATURING MUSIC, AUDIO BOOKS AND NEWS BROADCASTS; DOWNLOADABLE MUSICAL SOUND RECORDINGS; DOWNLOADABLE RING TONES, GRAPHICS AND MUSIC VIA A GLOBAL COMPUTER NETWORK AND WIRELESS DEVICES; DOWNLOADABLE VIDEO RECORDINGS FEATURING MUSICAL PERFORMANCES; MUSICAL SOUND RECORDINGS; MUSICAL VIDEO RECORDINGS; SOUND RECORDINGS FEATURING MUSICAL PERFORMANCES; VIDEO RECORDINGS FEATURING MUSICAL PERFORMANCES; VISUAL RECORDINGS AND AUDIO VISUAL RECORDINGS FEATURING MUSIC AND ANIMATION (U.S. CLS. 21, 23, 26, 36 AND 38).

FIRST USE 6-1-2006; IN COMMERCE 10-30-2006.

CLASS 41—EDUCATION AND ENTERTAINMENT

FOR COMPOSITION OF MUSIC FOR OTHERS; ENTERTAINMENT IN THE NATURE OF VISUAL AND AUDIO PERFORMANCES, AND MUSICAL, VARIETY, NEWS AND COMEDY SHOWS; ENTERTAINMENT IN THE NATURE OF VISUAL AND AUDIO PERFORMANCES, NAMELY, MUSICAL BAND, ROCK GROUP, GYMNASTIC, DANCE, AND BALLET PERFORMANCES; ENTERTAINMENT, NAMELY, LIVE PERFORMANCES BY A MUSICAL BAND; ENTERTAINMENT, NAMELY, LIVE MUSIC CONCERTS; ENTERTAINMENT, NAMELY, LIVE PERFORMANCES BY MUSICAL BANDS; MUSIC COMPOSITION AND TRANSCRIPTION FOR OTHERS; MUSIC COMPOSITION FOR OTHERS; MUSIC PRODUCTION SERVICES; MUSIC PUBLISHING SERVICES; MUSIC TRANSCRIPTION FOR OTHERS; PLANNING ARRANGEMENT OF SHOWING MOVIES, SHOWS, PLAYS OR MUSICAL PERFORMANCES; PRESENTATION OF MUSICAL PERFORMANCE; PRODUCTION OF SOUND AND MUSIC VIDEO RECORDINGS; PUBLICATION OF MUSICAL TEXTS (U.S. CLS. 100, 101 AND 107).

FIRST USE 6-1-2006; IN COMMERCE 10-30-2006.
CHRIS WELLS, EXAMINING ATTORNEY

SN 77-107,300. BARLOWORLD HANDLING LP, CHARLOTTE, NC. FILED 2-14-2007.

FLEETFLEX

THE MARK CONSISTS OF STANDARD CHARACTERS WITHOUT CLAIM TO ANY PARTICULAR FONT, STYLE, SIZE, OR COLOR.

CLASS 12—VEHICLES

FOR INDUSTRIAL TRUCKS, NAMELY, FORKLIFT TRUCKS AND WAREHOUSE TRUCKS (U.S. CLS. 19, 21, 23, 31, 35 AND 44).

CLASS 36—INSURANCE AND FINANCIAL

FOR FINANCING SERVICES FOR THE PURCHASE, LEASE OR RENTAL OF INDUSTRIAL TRUCKS, NAMELY, FORKLIFT TRUCKS AND WAREHOUSE TRUCKS (U.S. CLS. 100, 101 AND 102).

CLASS 39—TRANSPORTATION AND STORAGE

FOR LEASING OF INDUSTRIAL TRUCKS, NAMELY, FORKLIFT TRUCKS AND WAREHOUSE TRUCKS; RENTAL OF INDUSTRIAL TRUCKS, NAMELY, FORKLIFT TRUCKS AND WAREHOUSE TRUCKS (U.S. CLS. 100 AND 105).

PAUL CROWLEY, EXAMINING ATTORNEY

SN 77-107,443. LORI WEITZNER DESIGN INC., NEW YORK, NY. FILED 2-14-2007.

LORI WEITZNER

THE MARK CONSISTS OF STANDARD CHARACTERS WITHOUT CLAIM TO ANY PARTICULAR FONT, STYLE, SIZE, OR COLOR.

THE NAME LORI WEITZNER IDENTIFIES A LIVING INDIVIDUAL WHOSE CONSENT IS OF RECORD.

CLASS 24—FABRICS

FOR TEXTILE FABRICS FOR COMMERCIAL AND HOME INTERIORS; CLOTH TEXTILES FOR USE IN MANUFACTURING OF WALL COVERINGS, BEDDING, UPHOLSTERY, DRAPERIES, TABLE LINENS (U.S. CLS. 42 AND 50).

FIRST USE 0-0-2004; IN COMMERCE 0-0-2004.

CLASS 26—FANCY GOODS

FOR PASSEMENTERIE (U.S. CLS. 37, 39, 40, 42 AND 50).

FIRST USE 11-0-2006; IN COMMERCE 11-0-2006.

CLASS 27—FLOOR COVERINGS

FOR RUGS (U.S. CLS. 19, 20, 37, 42 AND 50).

FIRST USE 0-0-2004; IN COMMERCE 0-0-2004.

CLASS 42—SCIENTIFIC AND COMPUTER SERVICES

FOR CUSTOM DESIGN OF FABRICS AND TEXTILES, WALL COVERINGS IN THE NATURE OF WALLPAPER, DINNERWARE, PRODUCT PACKAGING, RUGS, HOUSEHOLD LINENS, FASHION ACCESSORIES, STATIONERY, HEALTHCARE PRODUCTS IN THE NATURE OF CUBICAL CURTAINS, RUGS AND INTERIOR FURNISHINGS (U.S. CLS. 100 AND 101).

FIRST USE 0-0-2004; IN COMMERCE 0-0-2004.
TONI HICKEY, EXAMINING ATTORNEY

SN 77-107,472. LOTUS BEDDING GROUP, DUSIT, BANGKOK, THAILAND, FILED 2-14-2007.

OMAZZ

THE MARK CONSISTS OF STANDARD CHARACTERS WITHOUT CLAIM TO ANY PARTICULAR FONT, STYLE, SIZE, OR COLOR.

CLASS 20—FURNITURE AND ARTICLES NOT OTHERWISE CLASSIFIED

FOR FITTED FABRIC FURNITURE COVERS; FURNITURE; OFFICE FURNITURE; MIRRORS; PICTURE FRAMES; PHOTOGRAPH FRAMES; PHOTOGRAPH FRAMES OF METAL, WOOD AND PAPER; DRAPERY HARDWARE, NAMELY, CURTAIN HOLDERS, HOOKS, RAILS, RINGS, RODS, AND ROLLERS; BAMBOO CURTAINS AND BAMBOO BLINDS; DECORATIVE BEAD CURTAINS; VENETIAN BLINDS; PLASTIC STORAGE CONTAINERS FOR COMMERCIAL OR INDUSTRIAL USE; FURNITURE CHESTS; CABINETS; CHAIRS; DESKS AND TABLES; DRESSING TABLES; EASY CHAIRS; BEDS AND WATER BEDS NOT FOR MEDICAL PURPOSES; BED FITTINGS NOT OF METAL, NAMELY, HEADBOARDS, RAILS, AND FRAMES; WOOD BEDSTEADS; FURNITURE SCREENS; NON-METAL CLOTHES HOOKS AND COAT HANGERS; COAT STANDS; CUSHIONS; DIVANS; NAP MATS; MATTRESSES; PILLOWS; SLEEPING BAGS; DOORS FOR FURNITURE; FOOTSTOOLS; BOTTLE RACKS FOR WINE; MAGAZINE RACKS; PLATE RACKS; MIRROR TILES; BOXES OF WOOD AND OF PLASTIC; HIGH CHAIRS FOR BABIES; PLAYPENS FOR BABIES AND WALKERS FOR INFANTS; DECORATIVE MOBILES; COTS; CRADLES AND CRIBS; STATUETTES AND FIGURINES OF WOOD, WAX, PLASTER AND OF PLASTIC; WORKS OF ART OF WOOD, WAX, PLASTER AND OF PLASTIC (U.S. CLS. 2, 13, 22, 25, 32 AND 50).

CLASS 24—FABRICS

FOR TEXTILES AND TEXTILE GOODS, NOT INCLUDED IN OTHER CLASSES, NAMELY, MATTRESS PADS; BED AND TABLE COVERS; RUGS; TRAVELING LAP RUGS; LAP RUGS; TOWELS; BED LINEN, BED BLANKETS, BEDSPREADS, QUILTS, BED CANOPIES, BED PADS, BED SHEETS, PILLOW CASES, COMFORTERS, DUVET COVERS, MATTRESS COVERS, CRIB BUMPERS, MOSQUITO NETS, PILLOW SHAMS; FABRIC, NAMELY, COTTON, COTTON SATIN, ITALIAN SILK, POLYESTER-COTTON; TABLE LINEN; PLACE MATS NOT OF PAPER; TEXTILE NAPKINS, TEXTILE SERVIETTES AND FABRIC TABLE RUNNERS; CLOTH DOILIES; CLOTH NAPKINS; DISH CLOTHS; FABRIC TABLE CLOTHS; KITCHEN TOWELS; FABRIC PLACE MATS; OVEN MITTS; WASHING MITTS; CLOTH COASTERS; CURTAINS; DRAPERIES; CURTAIN HOLDERS OF CLOTH; CLOTH BANNERS; HANDKERCHIEFS; BATH LINEN; BATH TOWELS AND WASH CLOTHS; HOUSEHOLD LINEN; PLACE MATS OF LINEN; UNFITTED COVERINGS OF TEXTILE AND OF PLASTIC FOR FURNITURE; FITTED COVERS FOR TOILET LIDS OF FABRIC; COVERS FOR CUSHIONS; UNFITTED FABRIC COVERS FOR FURNITURE; TEXTILE WALL HANGINGS; SHOWER CURTAINS; COTTON, POLYESTER AND NYLON FABRIC; FABRIC OF IMITATION ANIMAL SKINS; UPHOLSTERY FABRICS; TEXTILE LINGERIE FABRIC; FABRIC CURTAIN TIE-BACKS (U.S. CLS. 42 AND 50).

CLASS 27—FLOOR COVERINGS

FOR RUGS; CARPETS, MATS AND MATTING FOR COVERING EXISTING FLOORS; FLOOR COVERINGS; LINOLEUM FOR COVERING EXISTING FLOORS; VINYL FLOOR COVERINGS; NON-TEXTILE WALL HANGINGS; TAPESTRY-STYLE WALL HANGINGS, NOT OF TEXTILE; WALLPAPER; CEILING COVERINGS; BATH MATS; DOOR MATS (U.S. CLS. 19, 20, 37, 42 AND 50).

AMY HELLA, EXAMINING ATTORNEY

SN 77-108,179. WELLMARK, INC., DES MOINES, IA. FILED 2-15-2007.

Collaboration on Quality

THE MARK CONSISTS OF STANDARD CHARACTERS WITHOUT CLAIM TO ANY PARTICULAR FONT, STYLE, SIZE, OR COLOR.

CLASS 36—INSURANCE AND FINANCIAL

FOR PROVIDING INFORMATION IN INSURANCE MATTERS (U.S. CLS. 100, 101 AND 102).

CLASS 44—MEDICAL, BEAUTY AND AGRICULTURAL SERVICES

FOR PROVIDING HEALTH INFORMATION, NAMELY, MEASURING THE PERFORMANCE OF HEALTH CARE DELIVERY AND PROVIDING INFORMATION TO CLINICIANS AND HEALTH CARE FACILITIES TO SUPPORT THEIR IMPROVED PERFORMANCE OF EFFECTIVE AND EFFICIENT HEALTH CARE DELIVERY USING STATISTICAL ANALYSIS AND APPLICATION OF PROCESS IMPROVEMENT METHODS (U.S. CLS. 100 AND 101).

APRIL ROACH, EXAMINING ATTORNEY

SN 77-108,799. LITTLE FOREST, LLC., MILL VALLEY, CA. FILED 2-15-2007.

LITTLE FOREST

THE MARK CONSISTS OF STANDARD CHARACTERS WITHOUT CLAIM TO ANY PARTICULAR FONT, STYLE, SIZE, OR COLOR.

CLASS 3—COSMETICS AND CLEANING PREPARATIONS

FOR DIAPER RASH TREATMENT AND PREVENTION CREAMS, LOTIONS AND POWDERS; CRADLE CAP OIL; CRADLE CAP SHAMPOO; SUNSCREEN, SUNBLOCK, ALL FOR NON-MEDICATED USE (U.S. CLS. 1, 4, 6, 50, 51 AND 52).

FIRST USE 3-0-1997; IN COMMERCE 3-0-1997.

CLASS 5—PHARMACEUTICALS

FOR DIAPER RASH TREATMENT AND PREVENTION CREAMS, LOTIONS AND POWDERS; CRADLE CAP OIL; CRADLE CAP SHAMPOO, ALL FOR MEDICATED USE; AND INSECT REPELLENT (U.S. CLS. 6, 18, 44, 46, 51 AND 52).

FIRST USE 3-0-1997; IN COMMERCE 3-0-1997.

BARNEY CHARLON, EXAMINING ATTORNEY

SN 77-109,360. ASPHALT ENTERTAINMENT, LLC, VALENCIA, CA. FILED 2-16-2007.



ASPHALT ENTERTAINMENT

NO CLAIM IS MADE TO THE EXCLUSIVE RIGHT TO USE "ENTERTAINMENT", APART FROM THE MARK AS SHOWN.

CLASS 9—ELECTRICAL AND SCIENTIFIC APPARATUS

FOR PRE-RECORDED CDS, VIDEO TAPES, LASER DISKS AND DVDS FEATURING MUSIC (U.S. CLS. 21, 23, 26, 36 AND 38).

FIRST USE 1-9-2006; IN COMMERCE 2-10-2006.

CLASS 25—CLOTHING

FOR BLOUSES; DRESSES; FOOTWEAR; HATS; JACKETS; LINGERIE; PAJAMAS; PANTS; ROBES; SHOES; SHORTS; SOCKS; SWEAT SHIRTS; SWEATERS; T-SHIRTS; TANK TOPS; UNDERWEAR (U.S. CLS. 22 AND 39).

FIRST USE 1-9-2006; IN COMMERCE 2-10-2006.

LINDA MICKLEBURGH, EXAMINING ATTORNEY

SN 77-110,530. THE MARSTON GROUP, P.C., MEMPHIS, TN. FILED 2-19-2007.

INSIGHT BEYOND THE NUMBERS

THE MARK CONSISTS OF STANDARD CHARACTERS WITHOUT CLAIM TO ANY PARTICULAR FONT, STYLE, SIZE, OR COLOR.

CLASS 35—ADVERTISING AND BUSINESS

FOR BUSINESS ANALYSIS SERVICES, NAMELY, BUSINESS ADVICE AND ANALYSIS OF MARKETS AND COMPANIES; PERFORMANCE REPORTING SERVICES, NAMELY, ANALYZING AND COMPILING DATA FOR MEASURING THE PERFORMANCE OF MARKETS AND COMPANIES; BUSINESS STRATEGIC ADVICE, NAMELY, CONSULTATION, BUSINESS ACCOUNTING AND INTERNAL AUDITING SERVICES; TAX PLANNING, CONSULTING, ADVISORY AND COMPLIANCE SERVICES; BUSINESS SUSTAINABILITY ADVISORY SERVICES IN THE NATURE OF REVIEW OF TROUBLED BUSINESSES (U.S. CLS. 100, 101 AND 102).

CLASS 36—INSURANCE AND FINANCIAL

FOR FINANCIAL RISK MANAGEMENT SERVICES; CUSTOMER AND SHAREHOLDER FINANCIAL ANALYSIS SERVICES; CONSULTING AND ADVISORY SERVICES RELATING TO FINANCIAL MATTERS; PROVIDING FINANCIAL INFORMATION AND ADVISORY SERVICES IN THE FOLLOWING FIELDS: FINANCIAL RISK MANAGEMENT SERVICES, CONSULTING AND ADVISORY SERVICES RELATING TO FINANCIAL MATTERS, AND ADVISORY SERVICES RELATING TO FINANCIAL MATTERS, RISK MANAGEMENT ADVISORY SERVICES (U.S. CLS. 100, 101 AND 102).

WILLIAM P. SHANAHAN, EXAMINING ATTORNEY

SN 77-110,607. TRAVEL SUPPORT SYSTEMS, INC., BRADENTON, FL. FILED 2-19-2007.



NO CLAIM IS MADE TO THE EXCLUSIVE RIGHT TO USE "SINCE 1990" AND "OUTSIDE SALES SUPPORT", APART FROM THE MARK AS SHOWN.

CLASS 35—ADVERTISING AND BUSINESS

FOR ASSOCIATION SERVICES, NAMELY PROMOTING THE INTEREST OF TRAVEL AGENTS AND AGENCIES; BUSINESS NETWORKING SERVICES (U.S. CLS. 100, 101 AND 102).

FIRST USE 7-17-2004; IN COMMERCE 7-17-2004.

CLASS 41—EDUCATION AND ENTERTAINMENT

FOR EDUCATION SERVICES, NAMELY PROVIDING TRAINING PROGRAMS, SEMINARS, AND WORKSHOPS IN THE FIELD OF TRAVEL AGENCY (U.S. CLS. 100, 101 AND 107).

FIRST USE 7-17-2004; IN COMMERCE 7-17-2004.
ALLISON SCHRODY, EXAMINING ATTORNEY

SN 77-111,413. LEGISDISCOVERY, LLC, MCLEAN, VA. FILED 2-20-2007.

LDISCOVERY

THE MARK CONSISTS OF STANDARD CHARACTERS WITHOUT CLAIM TO ANY PARTICULAR FONT, STYLE, SIZE, OR COLOR.

CLASS 35—ADVERTISING AND BUSINESS

FOR BUSINESS CONSULTING AND AUDITING IN THE FIELD OF INFORMATION TECHNOLOGY SYSTEMS AND COMPUTER FORENSIC INVESTIGATIONS; BUSINESS ENQUIRIES AND INVESTIGATIONS; BUSINESS EXPERT EVALUATIONS AND PREPARING BUSINESS REPORTS RELATING TO COMPUTER FORENSIC INVESTIGATIONS, ELECTRONIC DISCOVERY, AND FILE RETENTION (U.S. CLS. 100, 101 AND 102).

CLASS 42—SCIENTIFIC AND COMPUTER SERVICES

FOR CONDUCTING COMPUTER FORENSIC INVESTIGATIONS; PROVIDING ELECTRONIC DISCOVERY SERVICES; TECHNICAL EXPERT EVALUATIONS AND REPORTS RELATING TO COMPUTER FORENSIC INVESTIGATIONS, ELECTRONIC DISCOVERY, AND FILE RETENTION; COMPUTER SERVICES, NAMELY ACTING AS AN APPLICATION SERVICE PROVIDER IN THE FIELD OF ELECTRONIC DISCOVERY TO PROVIDE, HOST, MANAGE, DEVELOP, AND MAINTAIN ELECTRONIC DATABASES FOR STORAGE AND SHARING OF DATA AND INFORMATION (U.S. CLS. 100 AND 101).

CLASS 45—PERSONAL AND LEGAL SERVICES

FOR BACKGROUND INVESTIGATION AND RESEARCH SERVICES; LITIGATION SUPPORT SERVICES AND LEGAL CONSULTATION SERVICES (U.S. CLS. 100 AND 101).

KEVON CHISOLM, EXAMINING ATTORNEY

SN 77-113,578. FLUGPO, LTD., NEW YORK, NY. FILED 2-22-2007.

THE COLOR(S) GREEN IS/ARE CLAIMED AS A FEATURE OF THE MARK.

THE MARK CONSISTS OF THE WORD FLUGPO IN LOWER CASE GREEN LETTERS.

CLASS 9—ELECTRICAL AND SCIENTIFIC APPARATUS

FOR AUDIO RECORDINGS FEATURING MUSIC; VIDEO RECORDINGS FEATURING MUSIC; DOWNLOADABLE AUDIO AND VIDEO RECORDINGS FEATURING MUSIC (U.S. CLS. 21, 23, 26, 36 AND 38).

CLASS 35—ADVERTISING AND BUSINESS

FOR ADVERTISING AND INFORMATION DISTRIBUTION SERVICES, NAMELY, PROVIDING CLASSIFIED ADVERTISING SPACE VIA THE GLOBAL COMPUTER NETWORK; PROMOTING THE GOODS AND SERVICES OF OTHERS OVER THE INTERNET; PROVIDING ON-LINE COMPUTER DATABASES AND ON-LINE SEARCHABLE DATABASES FEATURING CLASSIFIED LISTINGS AND WANT ADS (U.S. CLS. 100, 101 AND 102).

FIRST USE 1-25-2007; IN COMMERCE 1-25-2007.

CLASS 38—COMMUNICATION

FOR PROVIDING ON-LINE CHAT ROOMS AND ELECTRONIC BULLETIN BOARDS FOR TRANSMISSION OF MESSAGES AMONG USERS IN THE FIELD OF GENERAL INTEREST; PROVIDING EMAIL AND INSTANT MESSAGING SERVICES (U.S. CLS. 100, 101 AND 104).

CLASS 42—SCIENTIFIC AND COMPUTER SERVICES

FOR COMPUTER SERVICES, NAMELY, HOSTING ONLINE WEB FACILITIES FOR OTHERS FOR ORGANIZING AND CONDUCTING ONLINE MEETINGS, GATHERINGS, AND INTERACTIVE DISCUSSIONS; AND COMPUTER SERVICES IN THE NATURE OF CUSTOMIZED WEB PAGES FEATURING USER-DEFINED INFORMATION, PERSONAL PROFILES AND INFORMATION (U.S. CLS. 100 AND 101).

FIRST USE 1-25-2007; IN COMMERCE 1-25-2007.
MONIQUE MILLER, EXAMINING ATTORNEY

SN 77-115,963. HAYATA OF NORTH AMERICA, LTD., DALLAS, TX. FILED 2-26-2007.



THE MARK CONSISTS OF HAYATA IS IN ALL CAPITAL LETTERS. THE FIRST SYLLABLE OF THE WORD HAYATA HAS AN ARC DESIGN UNDER THE WORD. THE LAST SYLLABLE OF THE WORD HAYATA HAS AN ARC DESIGN ABOVE THE WORD.

CLASS 6—METAL GOODS

FOR CABLE CLAMPS OF METAL (U.S. CLS. 2, 12, 13, 14, 23, 25 AND 50).

FIRST USE 8-2-1999; IN COMMERCE 8-2-1999.

CLASS 9—ELECTRICAL AND SCIENTIFIC APPARATUS

FOR CABLE CONNECTORS; DUCTING FOR ELECTRIC CABLES; ELECTRICAL CONNECTORS (U.S. CLS. 21, 23, 26, 36 AND 38).

FIRST USE 8-2-1999; IN COMMERCE 8-2-1999.
NANCY CLARKE, EXAMINING ATTORNEY

SN 77-114,345. DEBORA BROWN, AMHERST, MA. AND JANE GIAT, AMHERST, MA. AND JENNIFER BOURGEOIS, AMHERST, MA. FILED 2-23-2007.



NO CLAIM IS MADE TO THE EXCLUSIVE RIGHT TO USE "HANDCRAFTED", APART FROM THE MARK AS SHOWN.

THE MARK CONSISTS OF A BIRD IN FLIGHT.

CLASS 14—JEWELRY

FOR JEWELRY (U.S. CLS. 2, 27, 28 AND 50).
FIRST USE 5-1-2006; IN COMMERCE 5-1-2006.

CLASS 21—HOUSEWARES AND GLASS

FOR BLOWN GLASS ART, NAMELY, SCULPTURES OF GLASS, FIGURINES OF GLASS, BOTTLES, JARS AND BOWLS SOLD EMPTY (U.S. CLS. 2, 13, 23, 29, 30, 33, 40 AND 50).

FIRST USE 5-1-2006; IN COMMERCE 5-1-2006.
JEFF DEFORD, EXAMINING ATTORNEY

SN 77-116,196. FLEETPRIDE, INC., THE WOODLANDS, TX. FILED 2-26-2007.

PRIMATECH

THE MARK CONSISTS OF STANDARD CHARACTERS WITHOUT CLAIM TO ANY PARTICULAR FONT, STYLE, SIZE, OR COLOR.

CLASS 1—CHEMICALS

FOR CHEMICALS FOR COMMERCIAL VEHICLES, NAMELY, ENGINE COOLANTS, STARTING FLUID FOR VEHICULAR ENGINES, WINDSHIELD ANTI-FREEZE FLUIDS, TRANSMISSION FLUID, ANTI-FREEZE FOR AIR BRAKE LINES (U.S. CLS. 1, 5, 6, 10, 26 AND 46).

CLASS 3—COSMETICS AND CLEANING PREPARATIONS

FOR AUTOMOTIVE CLEANERS, NAMELY, ENGINE CLEANERS AND BRAKE PARTS CLEANER (U.S. CLS. 1, 4, 6, 50, 51 AND 52).

CLASS 4—LUBRICANTS AND FUELS

FOR INDUSTRIAL OILS AND LUBRICANTS, NAMELY, GEAR OILS, HYDRAULIC OILS, MOTOR OIL, LUBRICATION GREASE FOR VEHICLES (U.S. CLS. 1, 6 AND 15).

CLASS 7—MACHINERY

FOR PARTS FOR COMMERCIAL VEHICLES, NAMELY, WATER PUMPS FOR USE IN MOTORS AND ENGINES, FAN BELTS FOR MOTORS AND ENGINES, EXHAUST PIPES FOR LAND MOTORS AND ENGINES, MUFFLERS FOR MOTORS AND ENGINES, COMPRESSORS AND AIR CONDENSERS FOR AIR CONDITIONERS IN COMMERCIAL VEHICLES (U.S. CLS. 13, 19, 21, 23, 31, 34 AND 35).

CLASS 11—ENVIRONMENTAL CONTROL APPARATUS

FOR COMPONENTS FOR AIR-CONDITIONING SYSTEM FOR COMMERCIAL VEHICLES, NAMELY, BLOWER MOTORS, EXPANSION VALVES, EVAPORATORS, FILTER DRYERS (U.S. CLS. 13, 21, 23, 31 AND 34).

CLASS 12—VEHICLES

FOR COMPONENTS FOR COMMERCIAL VEHICLES, NAMELY, CLUTCHES FOR LAND VEHICLES; WINDSHIELD WIPER BLADES; AIR SPRINGS FOR VEHICLE SUSPENSION; SHOCK ABSORBERS; SUSPENSION PARTS, NAMELY, TORQUE ARMS, U-BOLTS, HANGERS, AND EQUALIZERS; AND, CHROME ACCESSORIES, NAMELY WHEEL COVERS, LUG NUT COVERS, AXLE COVERS, HORN COVERS, LICENSE PLATE AND DRIVING PERMIT HOLDERS, ANTI-SAIL BRACKETS, GUARDS FOR MARKER LIGHTS, AND MUD FLAP HANGERS (U.S. CLS. 19, 21, 23, 31, 35 AND 44).

YAT SYE, LEE, EXAMINING ATTORNEY

SN 77-116,664. BEEHIVE.COM, INC., NEWPORT BEACH, CA. FILED 2-26-2007.

BEEHIVE

THE MARK CONSISTS OF STANDARD CHARACTERS WITHOUT CLAIM TO ANY PARTICULAR FONT, STYLE, SIZE, OR COLOR.

CLASS 35—ADVERTISING AND BUSINESS

FOR ONLINE ADVERTISING FOR OTHERS IN THE FIELD OF SOCIAL AND PERSONAL NETWORKING ON GLOBAL COMPUTER NETWORKS (U.S. CLS. 100, 101 AND 102).

CLASS 42—SCIENTIFIC AND COMPUTER SERVICES

FOR PROVIDING ON-LINE NON-DOWNLOADABLE COMPUTER SEARCH ENGINE SOFTWARE FOR THE USE IN THE FIELD OF SOCIAL AND PERSONAL NETWORKING; COMPUTER SERVICES IN THE NATURE OF CUSTOMIZED WEB PAGES FEATURING USER DEFINED INFORMATION, PERSONAL PROFILES, PREFERENCE MATCHING, AND INFORMATION FOR SOCIAL AND PERSONAL NETWORKING PURPOSES; PROVIDING CUSTOMIZED WEB PAGES FEATURING USER DEFINED INFORMATION, WHICH INCLUDES SEARCH ENGINES, A SOCIAL/PERSONAL CALENDAR, AND NON-DOWNLOADABLE VIDEOS IN THE FIELD OF SOCIAL AND PERSONAL NETWORKING AND RELATIONSHIPS, CURRENT ENTERTAINMENT EVENTS AND ENTERTAINMENT ACTIVITIES (U.S. CLS. 100 AND 101).

CLASS 45—PERSONAL AND LEGAL SERVICES

FOR ONLINE SOCIAL NETWORKING SERVICES ACCESSED THROUGH GLOBAL COMPUTER NETWORKS AND MOBILE DEVICES (U.S. CLS. 100 AND 101).

DANIEL BRODY, EXAMINING ATTORNEY

SN 77-117,307. SILVERSUN PICKUPS, LOS ANGELES, CA. FILED 2-27-2007.

SILVERSUN PICKUPS

THE MARK CONSISTS OF STANDARD CHARACTERS WITHOUT CLAIM TO ANY PARTICULAR FONT, STYLE, SIZE, OR COLOR.

CLASS 9—ELECTRICAL AND SCIENTIFIC APPARATUS

FOR ELECTRONIC PUBLICATIONS, NAMELY, BOOKS AND MAGAZINES FEATURING MUSICAL, DRAMATIC, COMEDIC AND SPORTS ENTERTAINMENT RECORDED ON COMPUTER MEDIA; PRE-RECORDED COMPACT DISCS, LASER DISCS, CD ROMS, DVDS, DVD ROMS, VIDEO TAPES, CASSETTES, AND OTHER PRE-RECORDED OPTICAL, ELECTRONIC, AND MAGNETIC MEDIA FEATURING MUSIC AND PERFORMANCES BY MUSICIANS; AUDIO AND VISUAL RECORDINGS IN ALL FORMS, NAMELY, MAGNETIC TAPE, OPTICAL DISC, MEMORY CARTRIDGE, AND DIGITAL DOWNLOADABLE FORMATS, FEATURING MUSIC, MUSICAL PERFORMANCES AND DRAMATIC AND COMEDIC ENTERTAINMENT; DOWNLOADABLE MUSICAL SOUND RECORDINGS; DOWNLOADABLE VIDEO RECORDINGS FEATURING MUSICAL PERFORMANCES; EYEWEAR, NAMELY, EYEGLASSES AND CASES THEREFORE; VIDEO GAME MACHINES FOR USE WITH TELEVISIONS (U.S. CLS. 21, 23, 26, 36 AND 38).

CLASS 16—PAPER GOODS AND PRINTED MATTER

FOR PAPER AND PAPER ARTICLES, NAMELY, TRADING CARDS, STATIONERY, PAPER CUT-OUT FIGURES, AND GIFT WRAP PAPER; PARTY GOODS, NAMELY, PAPER PARTY HATS, PAPER CAKE DECORATIONS AND PAPER TABLE CLOTHS; PICTURES, POSTERS, MOUNTED AND UNMOUNTED PHOTOGRAPHS; PUBLICATIONS, NAMELY, BOOKS, MAGAZINES, NEWSLETTERS, AND BULLETINS IN THE FIELDS OF MUSIC AND MUSICAL PERFORMANCES AND THE ENTERTAINMENT INDUSTRY; ADDRESS BOOKS; PHOTO AND STAMP ALBUMS; PAPER BANNERS; PRINTED MUSIC BOOKS; COLORING AND CHILDREN'S BOOKS; BULLETIN BOARDS; CALENDARS; PENS AND PENCILS; PEN AND PENCIL CASES; ERASERS; MARKERS; CRAYONS; CHALK; ARTS AND CRAFTS PAINT KITS; GREETING, NOTE AND BLANK CARDS; WRITING AND NOTE PAPER AND PADS; NOTEBOOKS, BOOK COVERS; PICTURE BOOKS; DECALS; DESK SETS AND DESK TOP ORGANIZERS; PAPER NAPKINS; TISSUE PAPER; PAPER PLACE MATS; RUBBER STAMPS; ADHESIVE BACKED NOTE PAPER; STENCILS; CONSTRUCTION PAPER; ART RUBBING BOARDS AND MODELING CLAY; BOOKMARKS; IRON-ON TRANSFERS; LITHOGRAPHS; MUSIC AND LYRIC SHEETS; FAN MAGAZINE IN THE FIELD OF MUSIC, FILM AND ENTERTAINMENT; PRE-PAID TELEPHONE CALLING CARDS, NOT MAGNETICALLY ENCODED; DRAWING RULERS; BINDERS WITH POCKETED PAGES FOR CARRYING CD-ROMS; DRAWING SETS CONSISTING OF FINGER PAINTS; ARTS AND CRAFTS PAINT KITS CONSISTING OF POSTER PAINTS; COLORED PENCILS; PAINT BOOKS; DIARIES; BLANK JOURNALS; LETTER WRITING SETS PRIMARILY COMPRISING STATIONERY, BLANK JOURNALS, PENS, PENCILS AND NOTE PADS; MEMORANDUM BOARDS; STICKERS; TEMPORARY TATTOOS; CHECKBOOK COVERS; LEATHER BOOK COVERS (U.S. CLS. 2, 5, 22, 23, 29, 37, 38 AND 50).

CLASS 25—CLOTHING

FOR CLOTHING, NAMELY, MEN'S AND WOMEN'S CLOTHING, NAMELY, SHIRTS, SHORTS, PANTS, TROUSERS, JEANS, JACKETS, SLACKS, SKIRTS, BLOUSES, DRESSES, VESTS, COATS, SWEATERS, SPORTS SHIRTS, POLO SHIRTS, TANK TOPS, SHORTS, T-SHIRTS, SWEATSHIRTS, SWEAT PANTS, JERSEYS, JOGGING SUITS, WRIST BANDS, RAINCOATS, SWIMWEAR, SWIMSUITS, NIGHTGOWNS, NIGHTSHIRTS, PAJAMAS, ROBES, UNDERWEAR, UNDERPANTS, BOXER SHORTS, LINGERIE, SLIPS, CAMISOLES, PETTICOATS, BRAS, SOCKS, HOSIERY, PANTYHOSE, TIGHTS, NECKTIES, BELTS, SCARVES, GLOVES, AND LEOTARDS; INFANTS' AND CHILDREN'S CLOTHING, NAMELY, T-SHIRTS, SWEATERS, LONG SLEEVED SHIRTS, SHORTS, PANTS, JUMPERS, JUMPSUITS, OVERALLS, ONE-PIECE PLAYSUITS, SWIMSUITS, PAJAMAS, SOCKS, DRESSES, SKIRTS; MEN'S WOMEN'S, CHILDREN'S AND INFANT'S FOOTWEAR, NAMELY, SHOES, BOOTS, ATHLETIC SHOES, GALOSHES, HIKING BOOTS, BEACH SHOES, SANDALS AND SLIPPERS; AND MEN'S WOMEN'S AND CHILDREN'S AND INFANT'S HEADWEAR, NAMELY, HATS, CAPS, NIGHTCAPS, BERETS, HEADBANDS, AND SUN VISORS; LEATHER JACKETS (U.S. CLS. 22 AND 39).

CLASS 41—EDUCATION AND ENTERTAINMENT

FOR ENTERTAINMENT SERVICES IN THE NATURE OF LIVE PERFORMANCES FEATURING MUSICAL GROUPS; PLANNING AND ARRANGEMENT OF LIVE MUSICAL PERFORMANCES; EDUCATIONAL AND TRAINING SERVICES, NAMELY, ARRANGING AND CONDUCTING CLASSES, SEMINARS, APPRENTICESHIPS AND CONFERENCES IN THE FIELD OF MUSIC; AUDIO AND VIDEO RECORDING AND PRODUCTION SERVICES; MUSIC PRODUCTION SERVICES; SONGWRITING; MUSIC COMPOSITION AND TRANSCRIPTION OF MUSIC FOR OTHERS; MOTION PICTURE SONG PRODUCTION (U.S. CLS. 100, 101 AND 107).

KATHERINE CONNOLLY, EXAMINING ATTORNEY

SN 77-117,924. DFP, INC., BISMARCK, ND. FILED 2-28-2007.

LINE BLOCKER

THE MARK CONSISTS OF STANDARD CHARACTERS WITHOUT CLAIM TO ANY PARTICULAR FONT, STYLE, SIZE, OR COLOR.

NO CLAIM IS MADE TO THE EXCLUSIVE RIGHT TO USE "LINE", APART FROM THE MARK AS SHOWN.

CLASS 3—COSMETICS AND CLEANING PREPARATIONS

FOR MAKEUP, HAIR CARE PREPARATIONS, NON-MEDICATED SKIN CARE PREPARATIONS, NAMELY, LOTIONS, MOISTURIZING CREAMS, OILS AND SUNSCREENS; BODY OILS AND BODY MOISTURIZERS (U.S. CLS. 1, 4, 6, 50, 51 AND 52).

CLASS 5—PHARMACEUTICALS

FOR MEDICATED SKIN CARE PREPARATIONS, NAMELY, LOTIONS, MOISTURIZING CREAMS, OILS AND SUNSCREENS (U.S. CLS. 6, 18, 44, 46, 51 AND 52).
PRISCILLA MILTON, EXAMINING ATTORNEY

SN 77-119,433. JUNGE, JOHN P., SAN DIEGO, CA. FILED 3-1-2007.



THE MARK CONSISTS OF THE WORDS ALL STAR OVER TWO LINES EXTENDING FROM A STAR AND THE LETTER A BEING A POINT OF THE STAR.

CLASS 35—ADVERTISING AND BUSINESS

FOR BUSINESS MANAGEMENT SERVICES, NAMELY, MANAGING LOGISTICS, REVERSE LOGISTICS, SUPPLY CHAIN SERVICES, SUPPLY CHAIN VISIBILITY AND SYNCHRONIZATION, SUPPLY AND DEMAND FORECASTING AND PRODUCT DISTRIBUTION PROCESSES FOR OTHERS; TRANSPORTATION LOGISTICS SERVICES, NAMELY, PLANNING AND SCHEDULING SHIPMENTS FOR USERS OF TRANSPORTATION SERVICES; TRANSPORTATION LOGISTICS SERVICES, NAMELY, ARRANGING THE TRANSPORTATION OF GOODS FOR OTHERS; OPERATION AND ADMINISTRATION OF ELECTRICAL GENERATORS, WATER SUPPLIES, SEWAGE TREATMENT FACILITIES AND HVAC EQUIPMENT OF OTHERS; PROVIDING TELEPHONE OPERATOR SERVICES FOR DISPATCH OF MAINTENANCE WORKERS (U.S. CLS. 100, 101 AND 102).

FIRST USE 2-21-2006; IN COMMERCE 2-21-2006.

CLASS 37—CONSTRUCTION AND REPAIR

FOR REPAIR AND MAINTENANCE OF AUTOMOBILES, FLEET VEHICLES; CONSTRUCTION AND RENOVATION OF BUILDINGS; BUILDING REMODELING AND RENOVATION SERVICES; MAINTENANCE OF WATER SUPPLIES AND SEWAGE TREATMENT FACILITIES; MAINTENANCE OF ELECTRICAL GENERATORS AND HVAC EQUIPMENT EXCLUSIVELY FOR FEDERAL, STATE AND LOCAL GOVERNMENT AGENCIES AND ORGANIZATIONS (U.S. CLS. 100, 103 AND 106).

FIRST USE 8-17-1999; IN COMMERCE 8-17-1999.

CLASS 39—TRANSPORTATION AND STORAGE

FOR SUPPLY CHAIN, LOGISTICS AND REVERSE LOGISTICS SERVICES, NAMELY, STORAGE, PACKAGING, TRANSPORTATION AND DELIVERY OF DOCUMENTS, PACKAGES, RAW MATERIALS, AND OTHER FREIGHT FOR OTHERS BY AIR, RAIL, SHIP OR TRUCK (U.S. CLS. 100 AND 105).

FIRST USE 2-21-2006; IN COMMERCE 2-21-2006.
HANNO RITTNER, EXAMINING ATTORNEY

CLASS 39—TRANSPORTATION AND STORAGE

FOR SUPPLY CHAIN, LOGISTICS AND REVERSE LOGISTICS SERVICES, NAMELY, STORAGE, PACKAGING, TRANSPORTATION AND DELIVERY OF DOCUMENTS, PACKAGES, RAW MATERIALS, AND OTHER FREIGHT FOR OTHERS BY AIR, RAIL, SHIP OR TRUCK (U.S. CLS. 100 AND 105).

FIRST USE 2-21-2006; IN COMMERCE 2-21-2006.
HANNO RITTNER, EXAMINING ATTORNEY

SN 77-120,313. NIEMOTKA, JOHN, FRESNO, CA. FILED 3-1-2007.



NO CLAIM IS MADE TO THE EXCLUSIVE RIGHT TO USE "ADVERTISING" OR "DESIGN", APART FROM THE MARK AS SHOWN.

THE MARK CONSISTS OF A GAS PUMP IN A BOX WITH THE WORDS OCTANE ADVERTISING UNDER OR TO THE RIGHT SIDE OF THE GAS PUMP LOGO.

SN 77-119,481. JUNGE, JOHN P., SAN DIEGO, CA. FILED 3-1-2007.

ALL STAR

THE MARK CONSISTS OF STANDARD CHARACTERS WITHOUT CLAIM TO ANY PARTICULAR FONT, STYLE, SIZE, OR COLOR.

CLASS 35—ADVERTISING AND BUSINESS

FOR BUSINESS MANAGEMENT SERVICES, NAMELY, MANAGING LOGISTICS, REVERSE LOGISTICS, SUPPLY CHAIN SERVICES, SUPPLY CHAIN VISIBILITY AND SYNCHRONIZATION, SUPPLY AND DEMAND FORECASTING AND PRODUCT DISTRIBUTION PROCESSES FOR OTHERS; TRANSPORTATION LOGISTICS SERVICES, NAMELY, PLANNING AND SCHEDULING SHIPMENTS FOR USERS OF TRANSPORTATION SERVICES; TRANSPORTATION LOGISTICS SERVICES, NAMELY, ARRANGING THE TRANSPORTATION OF GOODS FOR OTHERS; OPERATION AND ADMINISTRATION OF ELECTRICAL GENERATORS, WATER SUPPLIES, SEWAGE TREATMENT FACILITIES AND HVAC EQUIPMENT OF OTHERS; PROVIDING TELEPHONE OPERATOR SERVICES FOR DISPATCH OF MAINTENANCE WORKERS (U.S. CLS. 100, 101 AND 102).

FIRST USE 2-21-2006; IN COMMERCE 2-21-2006.

CLASS 37—CONSTRUCTION AND REPAIR

FOR REPAIR AND MAINTENANCE OF AUTOMOBILES, FLEET VEHICLES; CONSTRUCTION AND RENOVATION OF BUILDINGS; BUILDING REMODELING AND RENOVATION SERVICES; MAINTENANCE OF WATER SUPPLIES AND SEWAGE TREATMENT FACILITIES (U.S. CLS. 100, 103 AND 106).

FIRST USE 0-0-1989; IN COMMERCE 0-0-1989.

CLASS 35—ADVERTISING AND BUSINESS

FOR PROMOTING THE GOODS AND SERVICES OF OTHERS BY DISTRIBUTING ADVERTISING MATERIALS THROUGH A VARIETY OF METHODS; ADVERTISING AGENCIES, NAMELY, PROMOTING THE GOODS AND SERVICES OF OTHERS; ADVERTISING AND BUSINESS SERVICES, NAMELY SECURING AIR-TIME ON ALL FORMS OF MEDIA COMMUNICATIONS STATIONS, SYSTEMS, NETWORKS, AND SERVICES FOR THE PURPOSE OF PROMOTING THE GOODS AND SERVICES OF OTHERS; ADVERTISING AND COMMERCIAL INFORMATION SERVICES, VIA THE INTERNET; ADVERTISING AND MARKETING; ADVERTISING AND PUBLICITY SERVICES, NAMELY, PROMOTING THE GOODS, SERVICES, BRAND IDENTITY AND COMMERCIAL INFORMATION AND NEWS OF THIRD PARTIES THROUGH PRINT, AUDIO, VIDEO, DIGITAL AND ON-LINE MEDIUM; ADVERTISING CONSULTATION; ADVERTISING SERVICES, NAMELY, CREATING CORPORATE LOGOS FOR OTHERS; ADVERTISING SERVICES, NAMELY, CREATING CORPORATE AND BRAND IDENTITY FOR OTHERS; ADVERTISING SERVICES OF A RADIO AND TELEVISION ADVERTISING AGENCY; ADVERTISING SERVICES, NAMELY, PROMOTING AND MARKETING THE GOODS AND SERVICES OF OTHERS THROUGH ALL PUBLIC COMMUNICATION MEANS; ADVERTISING, MARKETING AND PROMOTION SERVICES; CREATING AND UPDATING ADVERTISING MATERIAL ; CREATION OF MARKETING TOOLS DESIGNED TO INCREASE A CLIENT COMPANY'S KNOWLEDGE OF CUSTOMER NEEDS, AND ITS COMPETITORS' PRODUCTS AND SERVICES, PRICING, ADVERTISING STRATEGY AND SALES STRATEGY; DESIGN OF ADVERTISING MATERIALS FOR OTHERS; DIRECT MAIL ADVERTISING; DISTRIBUTION AND DISSEMINATION OF ADVERTISING MATERIALS; MEDIA BUYING ADVICE, NAMELY, ADVISING THE CLIENT HOW MUCH MEDIA TIME, AND AT WHAT TIMES THE CLIENT SHOULD BE PURCHASING ADVERTISING; ON-LINE ADVERTISING AND MARKETING SERVICES; PROMOTION, ADVERTISING AND MARKETING OF ON-LINE WEBSITES; PROVIDING ADVERTISING, MARKETING AND PROMOTIONAL SERVICES FOR THE PHARMACEUTICAL AND MEDICAL INDUSTRY; DEVELOPING PROMOTIONAL CAMPAIGNS FOR BUSINESS; PROVIDING TELEVISION ADVERTISING FOR OTHERS; TELEVISION ADVERTISING AGENCIES (U.S. CLS. 100, 101 AND 102).

FIRST USE 1-1-2003; IN COMMERCE 1-1-2003.

CLASS 42—SCIENTIFIC AND COMPUTER SERVICES

FOR ANIMATION AND SPECIAL-EFFECTS DESIGN FOR OTHERS; COMMERCIAL ART DESIGN; COMPUTER GRAPHICS SERVICES; COMPUTER SERVICES, NAMELY, CREATING AND MAINTAINING WEB SITES FOR OTHERS; COMPUTER SERVICES, NAMELY, DESIGNING AND IMPLEMENTING WEB SITES FOR OTHERS; COMPUTER SERVICES, NAMELY, MANAGING WEB SITES FOR OTHERS (U.S. CLS. 100 AND 101).

FIRST USE 1-1-2003; IN COMMERCE 1-1-2003.
JAMES GRIFFIN, EXAMINING ATTORNEY

SN 77-121,990. EXERCISE PARTY, LLC, FITCHBURG, WI. FILED 3-5-2007.



EXERCISE PARTY

NO CLAIM IS MADE TO THE EXCLUSIVE RIGHT TO USE "EXERCISE", APART FROM THE MARK AS SHOWN. THE COLOR(S) PINK AND RED IS/ARE CLAIMED AS A FEATURE OF THE MARK.

THE MARK CONSISTS OF A BACKWARDS CAPITAL E IN RED AND PINK, WITH A CAPITAL P USING THE BACKWARDS STROKE DOWN OF THE E AS THE COMPLETION OF THE LETTER P. THE 2 LETTERS ARE JOINED BY THE PINK SIDE OF THE LETTER E. THE CAPITAL P IS ALL PINK. THE WORDS EXERCISE PARTY ARE BELOW THE E AND P IN RED.

CLASS 9—ELECTRICAL AND SCIENTIFIC APPARATUS

FOR DIGITAL MEDIA, NAMELY, EP EXERCISE PARTY DVDS FEATURING WORKOUTS AND NUTRITIONAL INFORMATION (U.S. CLS. 21, 23, 26, 36 AND 38).

CLASS 28—TOYS AND SPORTING GOODS

FOR EXERCISE EQUIPMENT, NAMELY SHOULDER STRETCHER USING RESISTANCE CABLES (U.S. CLS. 22, 23, 38 AND 50).

CLASS 35—ADVERTISING AND BUSINESS

FOR DISTRIBUTORSHIPS IN THE FIELD OF RESISTANCE BANDS AND EXERCISE DVDS (U.S. CLS. 100, 101 AND 102).

CLASS 40—MATERIAL TREATMENT

FOR CUSTOM IMPRINTING OF EP EXERCISE CLOTHING WITH DECORATIVE DESIGNS (U.S. CLS. 100, 103 AND 106).

SHAUNIA CARLYLE, EXAMINING ATTORNEY

SN 77-120,397. INTERNATIONAL CORPORATE & CARGO SERVICES S.A. DE C.V., MEXICO D.F., MEXICO, FILED 3-1-2007.



NO CLAIM IS MADE TO THE EXCLUSIVE RIGHT TO USE "MEXICO & LATIN AMERICA", APART FROM THE MARK AS SHOWN.

THE COLOR(S) RED AND BLUE IS/ARE CLAIMED AS A FEATURE OF THE MARK.

THE MARK CONSISTS OF THE COLOR RED WHICH APPEARS IN THE TOP PART OF THE LETTERS "ICCS". THE COLOR BLUE APPEARS IN THE LOWER PART OF THE LETTERS "ICCS" AND IN THE LETTERS OF THE WORD "MEXICO & LATIN AMERICA".

CLASS 36—INSURANCE AND FINANCIAL

FOR PROVIDING CREDIT CARD SERVICES WHICH ENABLE USERS TO FURNISH FUEL FOR AIRPLANES (U.S. CLS. 100, 101 AND 102).

FIRST USE 6-30-2004; IN COMMERCE 6-30-2004.

CLASS 39—TRANSPORTATION AND STORAGE

FOR TRANSPORTATION OF PASSENGERS, PARCELS, FREIGHT AND CARGO BY AIR (U.S. CLS. 100 AND 105).

FIRST USE 6-30-2004; IN COMMERCE 6-30-2004.
NORA BUCHANAN WILL, EXAMINING ATTORNEY

SN 77-122,324. CINCINNATI BELL INC., CINCINNATI, OH. FILED 3-5-2007.

CINCINNATI BELL

THE MARK CONSISTS OF STANDARD CHARACTERS WITHOUT CLAIM TO ANY PARTICULAR FONT, STYLE, SIZE, OR COLOR.

THIS IS A CONCURRENT REGISTRATION ISSUED PURSUANT TO THE OPINIONS OF THE UNITED STATES DISTRICT COURT FOR THE DISTRICT OF COLUMBIA IN UNITED STATES V. WESTERN ELECTRIC CO., INC., 569 F. SUPP. 1057 (D.D.C. JULY 8, 1983) AND UNITED STATES V. WESTERN ELECTRIC CO., INC., CIVIL ACTION NO. 82-0192, 1984 U.S. DIST. LEXIS 19733 (D.D.C. FEB. 6, 1984), AND

SECTION 2(D) OF THE LANHAM ACT, 15 U.S.C. SECTION 1052(D). THE APPLICANT ASSERTS A SHARED COMMON HERITAGE OF RIGHTS AND RELATED GOODWILL IN THE "BELL" ELEMENT OF THE MARK WITH OTHER FORMER MEMBERS OF THE BELL SYSTEM. REGISTRATION IS NATIONWIDE, BUT IS SUBJECT TO THE CONDITION THAT THE APPLICANT SHALL USE THE MARK ONLY IN CONJUNCTION WITH ONE OR MORE OF THE FOLLOWING MODIFIERS: "CINCINNATI BELL." USE OF A MODIFIER SHALL BE CONSIDERED TO BE IN CONJUNCTION WITH THE MARK IF IT IS USED IN SUFFICIENT PROXIMITY TO THE MARK SUCH THAT A REASONABLE OBSERVER WOULD NORMALLY VIEW THE MARK AND THE MODIFIER IN A SINGLE VISUAL IMPRESSION AND WOULD RECOGNIZE THAT BOTH THE MARK AND THE MODIFIER ARE USED BY THE APPLICANT. THE APPLICANT'S RIGHT TO EXCLUSIVE USE OF THE "BELL" MARK IS SUBJECT TO RIGHTS OF THE FOLLOWING COMPANIES, TO WHICH CONCURRENT REGISTRATIONS IN THE "BELL" MARK HAVE ALSO BEEN ISSUED, TO USE THE "BELL" MARK IN CONJUNCTION WITH ONE OR MORE OF THE MODIFIERS SPECIFIED IN THOSE REGISTRATIONS, AND AS SPECIFIED IN THE OPINIONS OF THE UNITED STATES DISTRICT COURT AS CITED ABOVE: AMERICAN INFORMATION TECHNOLOGIES CORPORATION, 30 SOUTH WACKER DRIVE, CHICAGO, IL 60606; BELL ATLANTIC CORPORATION, 1310 NORTH COURTHOUSE ROAD, ARLINGTON, VA 22201; BELL SOUTH CORPORATION, 1155 PEACHTREE STREET, N.E. ATLANTA GA 30367; NYNEX CORPORATION, 1113 WESTCHESTER AVENUE, WHITE PLAINS, NY 10604; PACIFIC TELESIS GROUP, 130 KEARNY STREET, SAN FRANCISCO, CA 94108; THE SOUTHERN NEW ENGLAND TELEPHONE COMPANY, 227 CHURCH STREET, NEW HAVEN, CT 06506; SOUTHWESTERN BELL CORPORATION, ONE BELL CENTER, ST. LOUIS, MO 63101; U S WEST, INC., 6200 SOUTH QUEBEC ROAD, ENGLEWOOD, CO, 80111; AND AT&T KNOWLEDGE VENTURES, L.P., 6500 RIVERPLACE BLVD, AUSTIN, TEXAS 78730.

OWNER OF U.S. REG. NOS. 2,371,962, 2,378,421 AND OTHERS.

SEC. 2(F) AS TO "CINCINNATI"..

CLASS 38—COMMUNICATION

FOR TELECOMMUNICATION SERVICES, NAMELY, LOCAL AND LONG DISTANCE TRANSMISSION OF VOICE, DATA, GRAPHICS BY MEANS OF TELEPHONE, TELEGRAPHIC, CABLE, AND SATELLITE TRANSMISSIONS (U.S. CLS. 100, 101 AND 104).

FIRST USE 1-3-1984; IN COMMERCE 1-3-1984.

CLASS 41—EDUCATION AND ENTERTAINMENT

FOR PROVIDING EDUCATIONAL SERVICES, SEMINARS AND WORKSHOPS IN TELECOMMUNICATIONS SKILLS AND THE USE OF TELECOMMUNICATIONS EQUIPMENT AND SERVICES (U.S. CLS. 100, 101 AND 107).

FIRST USE 1-3-1984; IN COMMERCE 1-3-1984.

CLASS 42—SCIENTIFIC AND COMPUTER SERVICES

FOR DESIGNING AND ENGINEERING TELECOMMUNICATIONS SYSTEMS AND EQUIPMENT FOR OTHERS AND RELATED CONSULTING SERVICES (U.S. CLS. 100 AND 101).

FIRST USE 1-3-1984; IN COMMERCE 1-3-1984.
ANGELA GAW, EXAMINING ATTORNEY

SN 77-123,410. ENVIRONMENTAL WASTE SOLUTIONS, INC., DBA RETRIEVER WASTE MANAGEMENT, MEDIA, PA. FILED 3-6-2007.

RETRIEVER WASTE MANAGEMENT

THE MARK CONSISTS OF STANDARD CHARACTERS WITHOUT CLAIM TO ANY PARTICULAR FONT, STYLE, SIZE, OR COLOR.

NO CLAIM IS MADE TO THE EXCLUSIVE RIGHT TO USE "WASTE MANAGEMENT", APART FROM THE MARK AS SHOWN.

CLASS 37—CONSTRUCTION AND REPAIR

FOR CONSULTING IN THE FIELD OF MEDICAL WASTE DISPOSAL SERVICES (U.S. CLS. 100, 103 AND 106).

FIRST USE 7-31-2006; IN COMMERCE 7-31-2006.

CLASS 40—MATERIAL TREATMENT

FOR CONSULTING IN THE FIELD OF WASTE MANAGEMENT SERVICES (U.S. CLS. 100, 103 AND 106).

FIRST USE 7-31-2006; IN COMMERCE 7-31-2006.
CHRISTINA SOBRAL, EXAMINING ATTORNEY

SN 77-123,414. ENVIRONMENTAL WASTE SOLUTIONS, INC., DBA RETRIEVER WASTE MANAGEMENT, MEDIA, PA. FILED 3-6-2007.



NO CLAIM IS MADE TO THE EXCLUSIVE RIGHT TO USE "WASTE MANAGEMENT", APART FROM THE MARK AS SHOWN.

CLASS 37—CONSTRUCTION AND REPAIR

FOR CONSULTING IN THE FIELD OF MEDICAL WASTE DISPOSAL SERVICES (U.S. CLS. 100, 103 AND 106).

FIRST USE 7-31-2006; IN COMMERCE 7-31-2006.

CLASS 40—MATERIAL TREATMENT

FOR CONSULTING IN THE FIELD OF WASTE MANAGEMENT SERVICES (U.S. CLS. 100, 103 AND 106).

FIRST USE 7-31-2006; IN COMMERCE 7-31-2006.
CHRISTINA SOBRAL, EXAMINING ATTORNEY

SN 77-123,442. THE COCA-COLA COMPANY, ATLANTA, GA. FILED 3-6-2007.

SN 77-123,463. THE COCA-COLA COMPANY, ATLANTA, GA. FILED 3-6-2007.

FRUIT SWERVE

THE MARK CONSISTS OF STANDARD CHARACTERS WITHOUT CLAIM TO ANY PARTICULAR FONT, STYLE, SIZE, OR COLOR.

OWNER OF U.S. REG. NO. 2,903,908.

NO CLAIM IS MADE TO THE EXCLUSIVE RIGHT TO USE "FRUIT", APART FROM THE MARK AS SHOWN.

CLASS 29—MEATS AND PROCESSED FOODS

FOR YOGURT BASED BEVERAGES (U.S. CL. 46).

CLASS 32—LIGHT BEVERAGES

FOR NON-ALCOHOLIC BEVERAGES, NAMELY, FRUIT JUICES (U.S. CLS. 45, 46 AND 48).
SUNG IN, EXAMINING ATTORNEY

SN 77-123,445. WELDON, WILLIAMS & LICK, INC., FORT SMITH, AR. FILED 3-6-2007.

DIRECT SOUVENIR

THE MARK CONSISTS OF STANDARD CHARACTERS WITHOUT CLAIM TO ANY PARTICULAR FONT, STYLE, SIZE, OR COLOR.

NO CLAIM IS MADE TO THE EXCLUSIVE RIGHT TO USE "SOUVENIR", APART FROM THE MARK AS SHOWN.

CLASS 16—PAPER GOODS AND PRINTED MATTER

FOR PRINTED KEEPSAKE EVENT TICKETS (U.S. CLS. 2, 5, 22, 23, 29, 37, 38 AND 50).

CLASS 39—TRANSPORTATION AND STORAGE

FOR DISTRIBUTION TO PATRONS OF ONLINE PURCHASED PRINTED KEEPSAKE EVENT TICKETS (U.S. CLS. 100 AND 105).
CHERYL CLAYTON, EXAMINING ATTORNEY

SWERVE

THE MARK CONSISTS OF STANDARD CHARACTERS WITHOUT CLAIM TO ANY PARTICULAR FONT, STYLE, SIZE, OR COLOR.

OWNER OF U.S. REG. NO. 2,903,908.

CLASS 29—MEATS AND PROCESSED FOODS

FOR YOGURT BASED BEVERAGES (U.S. CL. 46).

CLASS 32—LIGHT BEVERAGES

FOR NON-ALCOHOLIC BEVERAGES, NAMELY, FRUIT JUICES (U.S. CLS. 45, 46 AND 48).
SUNG IN, EXAMINING ATTORNEY

SN 77-124,286. GOPALAKRISHNAN, CHENNIAPPAN, KORAMANGALA, BANGALORE, INDIA, FILED 3-7-2007.



NO CLAIM IS MADE TO THE EXCLUSIVE RIGHT TO USE "STORES", APART FROM THE MARK AS SHOWN.

THE MARK CONSISTS OF STYLIZED LETTER "N" FOLLOWED BY THE WORD "STORES".

CLASS 30—STAPLE FOODS

FOR FOOD PRODUCTS, NAMELY, COFFEE, COFFEE FLAVORED SYRUP USED IN MAKING FOOD BEVERAGES, COFFEE SUBSTITUTES, INSTANT COFFEE, TEA, BEVERAGES MADE FROM TEA, ICED TEA, TEA SUBSTITUTES, COCOA, COCOA BEVERAGES MADE FROM MILK, COCOA BEVERAGES NOT MADE FROM MILK, COCOA-BASED INGREDIENTS FOR CONFECTIONERY PRODUCTS, SUGAR AND SUGAR SUBSTITUTES, RICE, RICE FLOURS, TAPIOCA AND TAPIOCA FLOUR, CHOCOLATE AND CHOCOLATE FOOD BEVERAGES NOT BEING DAIRY-BASED OR VEGETABLE BASED, PREPARATIONS MADE FROM CEREALS, NAMELY, PORRIDGE, UNLEAVENED BREAD, PANCAKES AND CREPES MADE MAINLY OF RICE, WHEAT AND PROCESSED OATS, PROCESSED AND BREAKFAST CEREALS, BREAD, CRACKERS, COOKIES, FOOD PACKAGES CONSISTING PRIMARILY OF BREADS, BAKERY GOODS, MIXES FOR BAKERY GOODS, CONFECTIONS, NAMELY, CANDY BARS, LICORICE, SUCKING CANDIES, LOLLIPOPS, MARSHMALLOWS, SUGAR AND SUGAR-FREE CHEWING GUM, TOFFEES, SPICES, SPICE BLENDS, BAKERY SPICES, VINEGAR, SALT, MUSTARD, SAUCES, NAMELY, FOOD SAUCES (U.S. CL. 46).

CLASS 35—ADVERTISING AND BUSINESS

FOR RETAIL DEPARTMENT STORE SERVICES, RETAIL GROCERY STORE SERVICES, RETAIL SUPERMARKET SERVICES, RETAIL BAKERY SERVICES, RETAIL ELECTRONIC STORE SERVICES, NAMELY, RETAIL STORES FEATURING ELECTRICAL AND ELECTRONIC GOODS, MUSIC AND MOVIE PRODUCTS, RETAIL CLOTHING STORE SERVICES, RETAIL SPORTING GOOD STORE SERVICES (U.S. CLS. 100, 101 AND 102).

LOURDES AYALA, EXAMINING ATTORNEY

SN 77-124,467. MEGA BRANDS INTERNATIONAL, LUXEMBOURG, ZUG BRANCH, ZUG, SWITZERLAND, FILED 3-7-2007.

SRX

THE MARK CONSISTS OF STANDARD CHARACTERS WITHOUT CLAIM TO ANY PARTICULAR FONT, STYLE, SIZE, OR COLOR.

CLASS 3—COSMETICS AND CLEANING PREPARATIONS

FOR CLEANER FOR USE ON DRY ERASE WRITING BOARDS (U.S. CLS. 1, 4, 6, 50, 51 AND 52).

CLASS 16—PAPER GOODS AND PRINTED MATTER

FOR WRITING INSTRUMENTS, CRAYONS, DRY ERASE WRITING BOARDS, NON-ELECTRIC DRY ERASER FOR DRAWING AND MESSAGE BOARDS, DRY ERASERS, AND DRY ERASE MARKERS (U.S. CLS. 2, 5, 22, 23, 29, 37, 38 AND 50).

TONJA GASKINS, EXAMINING ATTORNEY

SN 77-124,311. GOPALAKRISHNAN, CHENNIAPPAN, KORAMANGALA, BANGALORE, INDIA, FILED 3-7-2007.

Kapi 
Kadai

NO CLAIM IS MADE TO THE EXCLUSIVE RIGHT TO USE "KAPI KADAI", APART FROM THE MARK AS SHOWN.

THE MARK CONSISTS OF STYLIZED FORM OF "KAPI KADAI" WITH STYLIZED COFFEE BEAN SHAPE.

THE ENGLISH TRANSLATION OF THE WORD "KAPI KADAI" IN THE MARK IS "COFFEE SHOP."

CLASS 30—STAPLE FOODS

FOR FOOD PRODUCTS, NAMELY COFFEE, COFFEE FLAVORED SYRUP USED IN MAKING FOOD BEVERAGES, COFFEE SUBSTITUTES, INSTANT COFFEE, TEA, BEVERAGES MADE FROM TEA, ICED TEA, TEA SUBSTITUTES, COCOA, COCOA BEVERAGES MADE FROM MILK, COCOA BEVERAGES NOT MADE FROM MILK, COCOA-BASED INGREDIENTS FOR CONFECTIONARY PRODUCTS, SUGAR AND SUGAR SUBSTITUTES, RICE, RICE FLOURS, TAPIOCA AND TAPIOCA FLOUR, CHOCOLATE AND CHOCOLATE FOOD BEVERAGES NOT BEING DAIRY-BASED OR VEGETABLE BASED, PREPARATIONS MADE FROM CEREALS, NAMELY, PORRIDGE, UNLEAVENED BREAD, PANCAKES AND CREPES MADE MAINLY OF RICE, WHEAT AND PROCESSED OATS, PROCESSED AND BREAKFAST CEREALS, BREAD, CRACKERS, COOKIES, FOOD PACKAGES CONSISTING PRIMARILY OF BREADS, BAKERY GOODS, MIXES FOR BAKERY GOODS, CONFECTIONS, NAMELY, CANDY BARS, LICORICE, SUCKING CANDIES, LOLLIPOPS, MARSHMALLOWS, SUGAR AND SUGAR-FREE CHEWING GUM, TOFFEES, SPICES, SPICE BLENDS, BAKERY SPICES, VINEGAR, SALT, MUSTARD, SAUCES, NAMELY FOOD SAUCES (U.S. CL. 46).

CLASS 43—HOTEL AND RESTAURANT SERVICES

FOR RESTAURANT AND COFFEE SHOP SERVICES, NAMELY PROVIDING FOOD AND DRINK (U.S. CLS. 100 AND 101).

LOURDES AYALA, EXAMINING ATTORNEY

SN 77-125,128. A & M ENTERPRISES, INC., ALBUQUERQUE, NM. FILED 3-7-2007.



Full Circle
Wellness Center

NO CLAIM IS MADE TO THE EXCLUSIVE RIGHT TO USE "WELLNESS CENTER", APART FROM THE MARK AS SHOWN.

THE COLOR(S) MAROON, TAN, LIGHT TAN, RED AND DARK RED IS/ARE CLAIMED AS A FEATURE OF THE MARK.

THE COLOR MAROON APPEARS IN THE WORDING "FULL CIRCLE WELLNESS CENTER", IN THE WORDING "PHYSICAL EMOTIONAL MENTAL SPIRITUAL SOCIAL ENVIRONMENTAL", IN THE CIRCLES THAT SEPARATE THE WORDS THAT BORDER THE CIRCLE, IN THE OUTLINES OF THE CIRCULAR DESIGN ELEMENT, AND IN THE SHADING OF THE FOUR CIRCLES THAT APPEAR IN THE CENTER OF THE CIRCULAR DESIGN ELEMENT. THE COLOR TAN APPEARS IN SHADING OF THE INNER PORTION OF THE CIRCLE AND THE COLOR LIGHT TAN APPEARS IN THE SHADING OF THE OUTER BORDER OF THE CIRCLE. THE COLOR RED APPEARS IN THE SMALL CIRCLE THAT IS POSITIONED IN THE CENTER OF THE DESIGN ELEMENT AND THE COLOR DARK RED APPEARS IN THE OVERLAPPING PORTIONS OF THE CIRCLES.

CLASS 41—EDUCATION AND ENTERTAINMENT

FOR HEALTH CLUB SERVICES, NAMELY PROVIDING INSTRUCTION AND EQUIPMENT IN THE FIELD OF PHYSICAL EXERCISE (U.S. CLS. 100, 101 AND 107).

CLASS 44—MEDICAL, BEAUTY AND AGRICULTURAL SERVICES

FOR HEALTH SPA SERVICES, NAMELY, COSMETIC BODY CARE SERVICES (U.S. CLS. 100 AND 101).
ROBERT LAVACHE, EXAMINING ATTORNEY

SN 77-126,102. THINKTANK DESIGN GROUP, INC., BOZEMAN, MT. FILED 3-8-2007.



NO CLAIM IS MADE TO THE EXCLUSIVE RIGHT TO USE "THINKTANK DESIGN GROUP, INC.", APART FROM THE MARK AS SHOWN.

THE MARK CONSISTS OF ON THE LEFT HAND SIDE IS A BOX. ENCLOSED BY THE BOX ARE TWO STYLIZED "T"'S. TO THE RIGHT OF THE BOX ARE THE WORDS "THINKTANK DESIGN GROUP, INC." WHICH IS THE NAME OF THE CORPORATION. "THINKTANK" IS BOLD COMPARED TO THE OTHER LETTERS.

SN 77-125,551. KCQ SUPPLIES LLC, CLIVE, IA. FILED 3-8-2007.

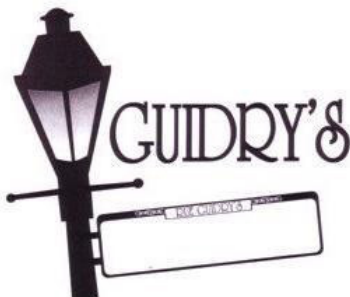

OWNER OF U.S. REG. NO. 3,245,695.

THE MARK CONSISTS OF A STYLIZED DESIGN OF A LAMPPOST WITH AN ATTACHED STREET SIGN. ADJACENT TO THE LAMPPOST IS THE WORD "GUIDRY'S" AND THE WORDING "RUE GUIDRY'S" IS ON THE TOP PORTION OF THE STREET SIGN.

CLASS 25—CLOTHING

FOR CLOTHING, NAMELY, APRONS, GOLF SHIRTS; BASEBALL CAPS (U.S. CLS. 22 AND 39).

CLASS 29—MEATS AND PROCESSED FOODS

FOR (BASED ON USE IN COMMERCE) SEASONED MEAT, FRESH MEAT, FROZEN MEAT, MARINATED MEAT, PROCESSED MEAT, NAMELY, PORK, VEAL, BEEF, HAM, TURKEY, CHICKEN, LAMB, AND SAUSAGES; (BASED ON INTENT TO USE) PRE-PACKAGED MEALS, NAMELY, CAJUN, CREOLE, CARIBBEAN, MEXICAN AND ITALIAN PRE-PACKAGES MEALS CONSISTING PRIMARILY OF MEAT, FISH, POULTRY OR VEGETABLES (U.S. CL. 46).
FIRST USE 12-1-2006; IN COMMERCE 12-1-2006.

CLASS 30—STAPLE FOODS

FOR DRY SEASONING MIXES, NAMELY, FOR CAJUN, CREOLE, CARIBBEAN, MEXICAN AND ITALIAN SEASONINGS; SEASONINGS; DRY SEASONING MIXES AND SEASONED COATINGS FOR MEAT, FISH, AND POULTRY; FLOUR-BASED BREADING MIXES FOR OVEN FRYING OF MEAT, FISH AND POULTRY; SALSA; SAUCES (U.S. CL. 46).
PAUL CROWLEY, EXAMINING ATTORNEY

CLASS 37—CONSTRUCTION AND REPAIR

FOR LAND DEVELOPMENT SERVICES, NAMELY, PLANNING AND LAYING OUT OF RESIDENTIAL AND/OR COMMERCIAL COMMUNITIES (U.S. CLS. 100, 103 AND 106).

FIRST USE 7-1-2006; IN COMMERCE 7-1-2006.

CLASS 42—SCIENTIFIC AND COMPUTER SERVICES

FOR ARCHITECTURAL DESIGN (U.S. CLS. 100 AND 101).

FIRST USE 7-1-2006; IN COMMERCE 7-1-2006.

CARYN GLASSER, EXAMINING ATTORNEY

SN 77-127,239. ROBISON'S, INC., IDAHO FALLS, ID. FILED 3-9-2007.

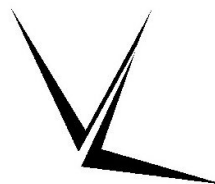

THE MARK CONSISTS OF STYLIZED VL.

CLASS 18—LEATHER GOODS

FOR LUGGAGE; BACKPACKS; AND DUFFLE BAGS (U.S. CLS. 1, 2, 3, 22 AND 41).

CLASS 25—CLOTHING

FOR CLOTHING, NAMELY, JACKETS, SHIRTS, PANTS, INSULATED BIBS FOR SNOW SPORTS FOR PROTECTION AGAINST COLD, RAIN SUITS, RAIN COATS, UNDERGARMENTS, SCARVES, BALACLAVAS, GLOVES, MITTENS, BOOTS, SHOES, AND HATS; SKI BOOT BAGS; THERMALLY INSULATED FACE-MASKS FOR SNOW SPORTS (U.S. CLS. 22 AND 39).

CLASS 28—TOYS AND SPORTING GOODS

FOR BAGS SPECIALLY ADAPTED FOR SNOW SPORTS EQUIPMENT; SKI-CARRYING BAGS; SNOW BOARD-CARRYING BAGS (U.S. CLS. 22, 23, 38 AND 50).
SANDRA MANIOS, EXAMINING ATTORNEY

SN 77-128,519. MESO SCALE DIAGNOSTICS, LLC,
GAITHERSBURG, MD. FILED 3-12-2007.

QUICKPLEX

THE MARK CONSISTS OF STANDARD CHARACTERS WITHOUT CLAIM TO ANY PARTICULAR FONT, STYLE, SIZE, OR COLOR.

CLASS 1—CHEMICALS

FOR BIOLOGICAL ASSAYS AND KITS, NAMELY, SELF-ASSEMBLED ARRAYS FOR SIMULTANEOUS, MULTIPLE DETECTION OF BIOLOGICAL ANALYTES AND FOR USE IN THE FIELDS OF BIOLOGICAL AND DIAGNOSTIC TESTING FOR INDUSTRIAL, SCIENTIFIC AND/OR RESEARCH USE (U.S. CLS. 1, 5, 6, 10, 26 AND 46).

CLASS 5—PHARMACEUTICALS

FOR BIOLOGICAL ASSAYS AND KITS, NAMELY, SELF-ASSEMBLED ARRAYS FOR SIMULTANEOUS, MULTIPLE DETECTION OF BIOLOGICAL ANALYTES AND FOR USE IN THE FIELDS OF BIOLOGICAL AND DIAGNOSTIC TESTING FOR MEDICAL AND/OR VETERINARY USE (U.S. CLS. 6, 18, 44, 46, 51 AND 52).
KEVON CHISOLM, EXAMINING ATTORNEY

SN 77-128,737. RISO KAGAKU CORPORATION, TOKYO,
JAPAN, FILED 3-12-2007.

ComColorExpress

CLASS 2—PAINTS

FOR INKS AND COLORINGS FOR USE IN PHOTOCOPYING, PRINTING, AND STENCIL MACHINES, INK CARTRIDGES FOR USE IN COPYING MACHINES, PRINTING MACHINES AND PRINTERS, INKS CONTAINED IN CARTRIDGES, INKS CONTAINED IN ROLLER CASSETTES; TONERS FOR USE IN PHOTOCOPYING AND PRINTING MACHINES, TONER CARTRIDGES FOR USE IN COPYING MACHINES AND PRINTERS, TONERS CONTAINED IN CARTRIDGES; PRINTING PIGMENTS; PRINTING PASTE FOR PRINTING AND COPYING (U.S. CLS. 6, 11 AND 16).

CLASS 7—MACHINERY

FOR PRINTING MACHINES, NAMELY, PRINTING PRESSES; PRINTING PLATES SUCH AS HEAT-PERFORATABLE FLEXIBLE PRINTING PLATES; PAPER FEEDERS; PRINTED PAPER SORTING MACHINES; PRINTING AND STENCIL MAKING MACHINES; MACHINES FOR PRODUCING STENCILS; FLASH UNITS FOR PRODUCING STENCILS AS BEING PARTS OF MACHINES FOR PRODUCING STENCILS; AND PARTS, FITTINGS AND ACCESSORIES FOR THE AFORESAID GOODS (U.S. CLS. 13, 19, 21, 23, 31, 34 AND 35).

CLASS 9—ELECTRICAL AND SCIENTIFIC APPARATUS

FOR INK JET PRINTERS FOR USE WITH COMPUTERS; IMAGE REPRODUCING MACHINES AND APPARATUS, NAMELY COPYING MACHINES, PHOTOGRAPHIC, ELECTROSTATIC AND THERMAL COPYING MACHINES; DIGITAL PRINTERS; DIGITAL PRINTING MACHINES FOR OFFICE USE; DIGITAL DUPLICATORS; PRINTERS FOR USE WITH COMPUTERS; PERIPHERAL DEVICES, ALL FOR USE WITH COMPUTERS AND DATA PROCESSING EQUIPMENT; PARTS AND FITTING FOR ALL THE AFORESAID GOODS (U.S. CLS. 21, 23, 26, 36 AND 38).
BONNIE LUKEN, EXAMINING ATTORNEY

SN 77-129,326. ASPARAGUS BEACH LLC, EAST HAMPTON,
NY. FILED 3-13-2007.

ASPARAGUS BEACH

THE MARK CONSISTS OF STANDARD CHARACTERS WITHOUT CLAIM TO ANY PARTICULAR FONT, STYLE, SIZE, OR COLOR.

NO CLAIM IS MADE TO THE EXCLUSIVE RIGHT TO USE "BEACH", APART FROM THE MARK AS SHOWN.

CLASS 3—COSMETICS AND CLEANING PREPARATIONS

FOR COSMETICS, BODY SOAPS, BODY LOTIONS, HAIR LOTIONS, SHAMPOOS, DEODORANTS FOR PERSONAL USE, BODY CREAMS, FACE CREAMS, AND FRAGRANCES (U.S. CLS. 1, 4, 6, 50, 51 AND 52).

CLASS 24—FABRICS

FOR BEACH TOWELS AND BLANKETS (U.S. CLS. 42 AND 50).

CLASS 25—CLOTHING

FOR SHIRTS, JERSEYS, SWEAT SHIRTS, SWEAT PANTS, TANK-TOPS, T-SHIRTS, WOVEN SHIRTS, KNIT SHIRTS, PANTS, SHORTS, SWIM WEAR, SWIM DRESSES, COVER DRESSES, SWIMSUIT COVER-UPS, WRAPS, UNDERWEAR, JACKETS, HATS, SUN HATS, CAPS AND VISORS, BANDANAS, FOOTWEAR AND SANDALS (U.S. CLS. 22 AND 39).

CLASS 35—ADVERTISING AND BUSINESS

FOR RETAIL STORE SERVICES FEATURING MEN'S, WOMEN'S AND CHILDREN'S CLOTHING, BEACH WEAR, BEACH ACCESSORIES, COSMETICS AND CLEANING PRODUCTS ON-LINE RETAIL STORE SERVICES FEATURING MEN'S, WOMEN'S AND CHILDREN'S CLOTHING, BEACH WEAR, BEACH ACCESSORIES, COSMETICS AND CLEANING PRODUCTS (U.S. CLS. 100, 101 AND 102).

CLASS 43—HOTEL AND RESTAURANT SERVICES

FOR RESTAURANT SERVICES (U.S. CLS. 100 AND 101).

ANNE MADDEN, EXAMINING ATTORNEY

SN 77-129,679. INNOVATIVE BIOSENSORS, INC., ROCKVILLE, MD. FILED 3-13-2007.

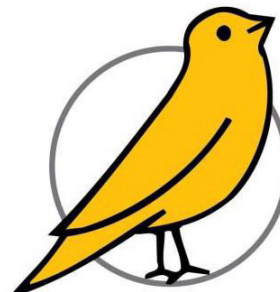

SN 77-129,628. RESPONSE BIOMEDICAL CORPORATION, BURNABY, CANADA, FILED 3-13-2007.

RAMP
Response Biomedical

OWNER OF U.S. REG. NOS. 2,605,067 AND 2,632,327.
THE MARK CONSISTS OF A GRAPHIC RAMP AND THE WORDS RESPONSE BIOMEDICAL.

CLASS 1—CHEMICALS

FOR DISPOSABLE CARTRIDGES CONTAINING REAGENTS AND ASSAYS FOR SCIENTIFIC RESEARCH IN THE NATURE OF ENVIRONMENTAL AND FOOD TESTING (U.S. CLS. 1, 5, 6, 10, 26 AND 46).

CLASS 5—PHARMACEUTICALS

FOR DISPOSABLE CARTRIDGES CONTAINING MEDICAL DIAGNOSTIC REAGENTS AND ASSAYS FOR USE IN ANALYZING BODY FLUIDS (U.S. CLS. 6, 18, 44, 46, 51 AND 52).

CLASS 9—ELECTRICAL AND SCIENTIFIC APPARATUS

FOR ENVIRONMENTAL AND FOOD TESTING APPARATUS USED TO DETECT TOXINS, ANTIGENS AND OTHER SUCH IMPURITIES AND DISPOSABLE CARTRIDGES FOR SUCH APPARATUS (U.S. CLS. 21, 23, 26, 36 AND 38).

CLASS 10—MEDICAL APPARATUS

FOR MEDICAL DIAGNOSTIC APPARATUS USED FOR ANALYZING BODILY FLUIDS AND DISPOSABLE CARTRIDGES FOR SUCH APPARATUS (U.S. CLS. 26, 39 AND 44).

NICHOLAS ALTREE, EXAMINING ATTORNEY

THE COLOR(S) YELLOW, BLACK, GREY AND WHITE IS/ARE CLAIMED AS A FEATURE OF THE MARK.

THE MARK CONSISTS OF A YELLOW BIRD OUTLINED IN BLACK SURROUNDED BY A GREY CIRCLE WITH THE COLOR WHITE WITHIN THE INTERIOR OF THE CIRCLE.

CLASS 1—CHEMICALS

FOR REAGENTS USED TO DETECT ANALYTES FOR NON-MEDICAL PURPOSES (U.S. CLS. 1, 5, 6, 10, 26 AND 46).

FIRST USE 7-0-2006; IN COMMERCE 7-0-2006.

CLASS 5—PHARMACEUTICALS

FOR REAGENTS USED TO DETECT ANALYTES FOR MEDICAL PURPOSES (U.S. CLS. 6, 18, 44, 46, 51 AND 52).

FIRST USE 7-0-2006; IN COMMERCE 7-0-2006.

SKYE YOUNG, EXAMINING ATTORNEY

SN 77-129,810. AGERA LABORATORIES, INC., WILMINGTON, DE. FILED 3-13-2007.

AGERA RX

THE MARK CONSISTS OF STANDARD CHARACTERS WITHOUT CLAIM TO ANY PARTICULAR FONT, STYLE, SIZE, OR COLOR.

OWNER OF U.S. REG. NO. 1,793,341.

NO CLAIM IS MADE TO THE EXCLUSIVE RIGHT TO USE "RX", APART FROM THE MARK AS SHOWN.

CLASS 3—COSMETICS AND CLEANING PREPARATIONS

FOR NON-MEDICATED SKIN CARE PREPARATIONS, NAMELY, SERUMS, LOTIONS, CREAMS, GELS, MASKS AND SPRAYS; COSMETIC PRODUCTS, NAMELY, SKIN CLEANERS, SKIN EXFOLIATES, SKIN LOTIONS AND SKIN MOISTURIZERS (U.S. CLS. 1, 4, 6, 50, 51 AND 52).

CLASS 5—PHARMACEUTICALS

FOR COSMETIC PRODUCTS; NAMELY, VITAMIN SUPPLEMENTS DESIGNED TO PROMOTE YOUTHFUL LOOKING SKIN; PHARMACEUTICAL OR MEDICAL PREPARATIONS CONTAINING FIBROBLAST CELLS FOR INJECTING UNDER THE SKIN FOR WRINKLE REDUCTION, REDUCTION OF ACNE CONDITIONS OR REDUCTION OF SCARS OF THE SKIN OR FOR INJECTING OR SURGICALLY IMPLANTING INTO THE GUMS OR AROUND THE TEETH; SYNTHETIC PEPTIDES FOR PHARMACEUTICAL PURPOSES; AMINO ACID SEQUENCES FOR MEDICAL OR VETERINARY PURPOSES; PHARMACEUTICAL PRODUCTS FOR THE TREATMENT OF DERMATOLOGIC CONDITIONS, WOUND HEALING, CANCERS, CARDIOVASCULAR DISEASES, VIRAL AND INFECTIOUS DISEASES, DISEASES OF THE IMMUNE SYSTEM, GENETIC DISORDERS, OPHTHALMIC DISEASES (U.S. CLS. 6, 18, 44, 46, 51 AND 52).

PAULA MAYS, EXAMINING ATTORNEY

SN 77-130,962. THE TILE SHOP, LLC, PLYMOUTH, MN. FILED 3-14-2007.

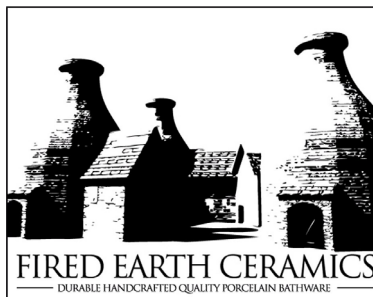

NO CLAIM IS MADE TO THE EXCLUSIVE RIGHT TO USE "FIRED EARTH CERAMICS" AND "DURABLE HANDCRAFTED PORCELAIN BATHWARE", APART FROM THE MARK AS SHOWN.

THE STIPPLING IS A FEATURE OF THE MARK.

SN 77-130,842. INTERLEGIS, INC., DALLAS, TX. FILED 3-14-2007.

DISCOVERY360

THE MARK CONSISTS OF STANDARD CHARACTERS WITHOUT CLAIM TO ANY PARTICULAR FONT, STYLE, SIZE, OR COLOR.

CLASS 42—SCIENTIFIC AND COMPUTER SERVICES

FOR CONVERSION OF DATA OR DOCUMENTS FROM PHYSICAL TO ELECTRONIC MEDIA; PROVIDING TEMPORARY USE OF NON-DOWNLOADABLE COMPUTER SOFTWARE FOR TRACKING DOCUMENTS OVER COMPUTER NETWORKS, INTRANETS, AND THE INTERNET; INFORMATION MANAGEMENT SERVICES, NAMELY, EXTRACTION OF METADATA, TEXT, INFORMATION, AND DATA FROM DOCUMENTS, HARD COPIES, AND ELECTRONIC MEDIA; INFORMATION MANAGEMENT SERVICES, NAMELY, COMPARISONS AND IDENTIFICATION OF METADATA, TEXT, INFORMATION AND DATA FROM DOCUMENTS, HARD COPIES, AND ELECTRONIC MEDIA; COMPUTER SERVICES, NAMELY ACTING AS AN APPLICATION SERVICE PROVIDER IN THE FIELD OF KNOWLEDGE MANAGEMENT TO HOST COMPUTER APPLICATION SOFTWARE FOR CREATING SEARCHABLE DATABASES OF INFORMATION AND DATA (U.S. CLS. 100 AND 101).

FIRST USE 10-24-2006; IN COMMERCE 10-24-2006.

CLASS 45—PERSONAL AND LEGAL SERVICES

FOR LITIGATION SUPPORT SERVICES (U.S. CLS. 100 AND 101).

FIRST USE 10-24-2006; IN COMMERCE 10-24-2006.
SHAILA SETTLES, EXAMINING ATTORNEY

CLASS 9—ELECTRICAL AND SCIENTIFIC APPARATUS

FOR TILE-RELATED PRODUCTS, NAMELY, OUTLET COVERS AND SWITCH-PLATE COVERS, ALL MADE OF TILE (U.S. CLS. 21, 23, 26, 36 AND 38).

CLASS 19—NON-METALLIC BUILDING MATERIALS

FOR EARTHENWARE TILES; NON-METAL ROOFING TILES; NON-METAL TILES (U.S. CLS. 1, 12, 33 AND 50).

CLASS 21—HOUSEWARES AND GLASS

FOR TILE-RELATED PRODUCTS, NAMELY BASINS, SOAP HOLDERS, TOWEL RACKS AND HOLDERS (U.S. CLS. 2, 13, 23, 29, 30, 33, 40 AND 50).

GEORGIA CARTY, EXAMINING ATTORNEY

SN 77-130,976. SOLUTIA INC., ST. LOUIS, MO. FILED 3-14-2007.



OWNER OF U.S. REG. NOS. 1,183,834 AND 2,761,191.
THE COLOR(S) RED, BLACK, AND BLUE IS/ARE CLAIMED AS A FEATURE OF THE MARK.

THE MARK CONSISTS OF THE COLOR RED APPEARING IN THE ZIGZAG LINE TO THE LEFT OF THE WORDING; THE COLOR BLACK APPEARING IN THE WORDING NO-SHOCK AND THE COLOR BLUE APPEARING IN THE STRAIGHT LINE TO THE RIGHT OF THE WORDING. THE COLOR WHITE CONSTITUTES TRANSPARENT AREAS AND ARE NOT PART OF THE MARK.

CLASS 22—CORDAGE AND FIBERS

FOR TEXTILE FIBERS; SYNTHETIC FIBERS FOR USE IN CARPETS, IN MATS, AND IN MATTING (U.S. CLS. 1, 2, 7, 19, 22, 42 AND 50).

CLASS 24—FABRICS

FOR UPHOLSTERY FABRIC; NYLON FABRIC; FABRICS PRINCIPALLY OF NYLON SYNTHETIC FIBER FABRIC; FABRIC PRINCIPALLY OF SYNTHETIC FIBERS; MIXED FIBER FABRICS; WOVEN FABRICS; NON-WOVEN FABRICS; FABRICS, TEXTILE FABRICS AND TEXTILE LININGS, FOR USE IN THE MANUFACTURE OF THE FOLLOWING: CLOTHING, CARPETS, RUGS, MATS, CONVEYOR BELTS, DRAPERIES AND WINDOW COVERINGS, MEDICAL FABRICS, AND FILTER FABRICS; TEXTILE FABRICS FOR HOME AND COMMERCIAL INTERIORS (U.S. CLS. 42 AND 50).

CLASS 27—FLOOR COVERINGS

FOR CARPETS, RUGS, MATS AND MATTING (U.S. CLS. 19, 20, 37, 42 AND 50).
JENNIFER DIXON, EXAMINING ATTORNEY

SN 77-133,100. P.C. RICHARD LONG & SON LONG ISLAND CORP., FARMINGDALE, NY. FILED 3-16-2007.



NO CLAIM IS MADE TO THE EXCLUSIVE RIGHT TO USE "FLAT PANEL TV INSTALLATIONS", APART FROM THE MARK AS SHOWN.

THE MARK CONSISTS OF THE WORDS "FLAT" AND "PANEL" IN STYLIZED TYPE APPEAR UPPERMOST; THE WORD "INSTALLATIONS" APPEARS BELOW THE WORDS "FLAT PANEL" AND ABOVE THE WORDS "MADE" AND "EASY" IN STYLIZED TYPE. THE LETTERS "TV" APPEAR TO THE LEFT OF THE WORD "INSTALLATION" AND THE WORDS "MADE EASY".

CLASS 35—ADVERTISING AND BUSINESS

FOR RETAIL STORE SERVICES FEATURING CONSUMER ELECTRONICS AND ACCESSORIES (U.S. CLS. 100, 101 AND 102).
FIRST USE 1-12-2007; IN COMMERCE 1-12-2007.

CLASS 37—CONSTRUCTION AND REPAIR

FOR INSTALLATION OF HOME THEATRES AND RELATED STRUCTURED WIRING; INSTALLATION OF FURNITURE (U.S. CLS. 100, 103 AND 106).
FIRST USE 1-12-2007; IN COMMERCE 1-12-2007.
AISHA SALEM, EXAMINING ATTORNEY

SN 77-133,248. AMERICAN DESTINY HOLDINGS, LTD, DALLAS, TX. FILED 3-16-2007.

DESTINY

THE MARK CONSISTS OF STANDARD CHARACTERS WITHOUT CLAIM TO ANY PARTICULAR FONT, STYLE, SIZE, OR COLOR.

CLASS 4—LUBRICANTS AND FUELS

FOR LIQUID PETROLEUM GASES TO BE USED IN MOTOR VEHICLES (U.S. CLS. 1, 6 AND 15).

CLASS 35—ADVERTISING AND BUSINESS

FOR RETAIL STORE SERVICES FEATURING CONVENIENCE STORE ITEMS AND GASOLINE (U.S. CLS. 100, 101 AND 102).
SANJEEV VOHRA, EXAMINING ATTORNEY

SN 77-133,971. WEATHERGUARD BUILDING PRODUCTS, INC., WEST PALM BEACH, FL. FILED 3-19-2007.

UNITED SHUTTER SYSTEMS ASSOCIATION

THE MARK CONSISTS OF STANDARD CHARACTERS WITHOUT CLAIM TO ANY PARTICULAR FONT, STYLE, SIZE, OR COLOR.

NO CLAIM IS MADE TO THE EXCLUSIVE RIGHT TO USE "SHUTTER SYSTEMS" FOR INTERNATIONAL CLASSES 6 AND 19; "SHUTTER SYSTEMS ASSOCIATION" FOR INTERNATIONAL CLASS 35, APART FROM THE MARK AS SHOWN.

CLASS 6—METAL GOODS

FOR PROTECTIVE AND SECURITY METAL WINDOWS, METAL DOORS, AND METAL BUILDING SHUTTERS (U.S. CLS. 2, 12, 13, 14, 23, 25 AND 50).

CLASS 19—NON-METALLIC BUILDING MATERIALS

FOR PROTECTIVE AND SECURITY NON-METAL WINDOWS, NON-METAL DOORS, AND NON-METAL BUILDING SHUTTERS (U.S. CLS. 1, 12, 33 AND 50).

CLASS 35—ADVERTISING AND BUSINESS

FOR ASSOCIATION SERVICES, NAMELY, PROMOTING THE INTERESTS OF MANUFACTURERS AND SUPPLIERS OF COMPONENTS OF WIND, STORM HURRICANE METAL PROTECTIVE AND SECURITY WINDOW, DOOR AND BUILDING SHUTTERS (U.S. CLS. 100, 101 AND 102).
ANGELA GAW, EXAMINING ATTORNEY

SN 77-135,033. CLINIQUE LABORATORIES LLC, NEW YORK, NY. FILED 3-20-2007.

CLINIQUE

THE MARK CONSISTS OF STANDARD CHARACTERS WITHOUT CLAIM TO ANY PARTICULAR FONT, STYLE, SIZE, OR COLOR.

OWNER OF U.S. REG. NOS. 878,877, 2,165,411 AND OTHERS.

CLASS 35—ADVERTISING AND BUSINESS

FOR ONLINE RETAIL STORE SERVICES OFFERED VIA A GLOBAL COMMUNICATION NETWORK FEATURING PERSONAL CARE PRODUCTS, COSMETICS, TOILETRIES, PERFUMERY, BATH AND BODY PRODUCTS, SKIN CARE PRODUCTS AND HAIR CARE PRODUCTS; RETAIL STORE SERVICES FEATURING PERSONAL CARE PRODUCTS, COSMETICS, TOILETRIES, PERFUMERY, BATH AND BODY PRODUCTS, SKIN CARE PRODUCTS, HAIR CARE PRODUCTS AND BEAUTY TREATMENTS; MAIL ORDER SERVICES FEATURING PERSONAL CARE PRODUCTS, COSMETICS, COSMECEUTICALS, TOILETRIES, PERFUMERY, BATH AND BODY PRODUCTS, MEDICATED AND NON-MEDICATED SKIN CARE PREPARATIONS AND HAIR CARE PRODUCTS (U.S. CLS. 100, 101 AND 102).

CLASS 44—MEDICAL, BEAUTY AND AGRICULTURAL SERVICES

FOR BEAUTY CONSULTATION SERVICES REGARDING THE SELECTION AND USE OF PERSONAL CARE PRODUCTS, COSMETICS, COSMECEUTICALS, TOILETRIES, PERFUMERY, BATH AND BODY PRODUCTS, MEDICATED AND NON-MEDICATED SKIN CARE PREPARATIONS, HAIR CARE PRODUCTS AND BEAUTY TREATMENTS, COLOR ANALYSIS AND PERSONAL APPEARANCE; PROVISION OF BEAUTY INFORMATION CONCERNING COLOR ANALYSIS, PERSONAL CARE PRODUCTS, COSMETICS, COSMECEUTICALS, TOILETRIES, PERFUMERY, BATH AND BODY PRODUCTS, MEDICATED AND NON-MEDICATED SKIN CARE PREPARATIONS, HAIR CARE PRODUCTS, BEAUTY TREATMENTS AND PERSONAL APPEARANCE; ONLINE PROVISION OF BEAUTY INFORMATION VIA A GLOBAL COMMUNICATION NETWORK REGARDING THE SELECTION AND USE OF PERSONAL CARE PRODUCTS, COSMETICS, COSMECEUTICALS, TOILETRIES, PERFUMERY, BATH AND BODY PRODUCTS, MEDICATED AND NON-MEDICATED SKIN CARE PREPARATIONS, HAIR CARE PRODUCTS AND BEAUTY TREATMENTS, COLOR ANALYSIS AND PERSONAL APPEARANCE (U.S. CLS. 100 AND 101).

PAUL CROWLEY, EXAMINING ATTORNEY

SN 77-135,260. TAPHANDLES INC., RENTON, WA. FILED 3-20-2007.



NO CLAIM IS MADE TO THE EXCLUSIVE RIGHT TO USE "TAP HANDLES", APART FROM THE MARK AS SHOWN.

CLASS 6—METAL GOODS

FOR NON-LUMINOUS AND NON-MECHANICAL METAL SIGNS AND METAL TOOL BOXES; METAL HANDLES FOR TAPS FOR KEGS (U.S. CLS. 2, 12, 13, 14, 23, 25 AND 50).

CLASS 19—NON-METALLIC BUILDING MATERIALS

FOR NON-LUMINOUS, NON-MECHANICAL SIGNS NOT OF METAL (U.S. CLS. 1, 12, 33 AND 50).

CLASS 20—FURNITURE AND ARTICLES NOT OTHERWISE CLASSIFIED

FOR DISPLAY STANDS; NONMETAL HANDLES FOR TAPS FOR KEGS (U.S. CLS. 2, 13, 22, 25, 32 AND 50).

CLASS 21—HOUSEWARES AND GLASS

FOR BEVERAGE GLASSWARE; BOTTLE OPENERS (U.S. CLS. 2, 13, 23, 29, 30, 33, 40 AND 50).
MAUREEN DALL, EXAMINING ATTORNEY

SN 77-136,051. FORREST, RUDOLPH R., LOS ANGELES, CA. FILED 3-20-2007.



THE MARK CONSISTS OF A SKULL WHICH IS PRESENTED WEARING A HAT AND BOWTIE.

CLASS 25—CLOTHING

FOR BASEBALL CAPS; BOXING SHOES; BUTTON-FRONT ALOHA SHIRTS; CAMP SHIRTS; CAP VISORS; CAPRI PANTS; CAPS; CAPS WITH VISORS; CARGO PANTS; DECK-SHOES; DENIMS; DRESS SHIRTS; GOLF CAPS; GOLF SHIRTS; GOLF SHOES; JOGGING PANTS; KNIT SHIRTS; KNITTED CAPS; LEATHER PANTS; LEATHER SHOES; NIGHT SHIRTS; NURSE PANTS; OPEN-NECKED SHIRTS; PANTS; POLO SHIRTS; SHIRT FRONTS; SHIRTS; SHIRTS FOR SUITS; SHOES; SHORT-SLEEVED OR LONG-SLEEVED T-SHIRTS; SHORT-SLEEVED SHIRTS; SKI AND SNOWBOARD SHOES AND PARTS THEREOF; SKI PANTS; SKIING SHOES; SKULL CAPS; SNOW PANTS; SNOWBOARD PANTS; SPORT SHIRTS; SPORTS SHIRTS; SPORTS SHIRTS WITH SHORT SLEEVES; SWEAT PANTS; SWEAT SHIRTS; T-SHIRTS; TENNIS SHOES; WATERPROOF JACKETS AND PANTS; WIND SHIRTS (U.S. CLS. 22 AND 39).

CLASS 35—ADVERTISING AND BUSINESS

FOR CATALOG ORDERING SERVICE FEATURING CLOTHING, SHOES, AND OTHER GARMENTS (U.S. CLS. 100, 101 AND 102).

CLASS 40—MATERIAL TREATMENT

FOR IMPRINTING MESSAGES ON T-SHIRTS; T-SHIRT EMBROIDERING SERVICES (U.S. CLS. 100, 103 AND 106).
SANJEEV VOHRA, EXAMINING ATTORNEY

SN 77-136,088. LOST KEY REWARDS, INC., SUNNY ISLES BEACH, FL. FILED 3-20-2007.



NO CLAIM IS MADE TO THE EXCLUSIVE RIGHT TO USE "KEY" AND "REWARDS", APART FROM THE MARK AS SHOWN.

THE COLOR(S) BLACK, RED, WHITE, DARK BLUE, DODGER BLUE, LIGHT BLUE, SANDY BROWN, DARK GRAY AND GOLD IS/ARE CLAIMED AS A FEATURE OF THE MARK.

THE MARK CONSISTS OF MAIL BOX- DARK BLUE, TRIMMED WITH DODGER BLUE AND HAS A BLACK MAIL SLOT. MAIL MAN'S- HAT AND JACKET ARE DODGER BLUE, AND TRIMMED IN LIGHT BLUE. MAIL MAN'S PANTS ARE DARK BLUE. HIS FACE AND HANDS ARE SANDY BROWN. MAIL MAN'S HAIR AND EYES ARE BLACK. HE HOLDS A RED KEY IN HIS RIGHT HAND. SHOES ARE DARK GRAY. SOCKS ARE BLACK. THE STYLIZED CAPITALIZED LETTERS ARE LOST KEY ARE RED ON THE INSIDE AND LINED WITH WHITE AROUND THE OUTSIDE OF EACH LETTER. THE STYLIZED LETTERS REWARDS ARE LOWER CASE AND ALL WHITE IN COLOR. A GOLD RIBBON IS PRESENT UNDER THE REWARDS WORD AND STARTS UNDER THE EDGE OF THE W THE COLOR IS GOLD.

CLASS 35—ADVERTISING AND BUSINESS

FOR KEY RETURN REGISTRATION (U.S. CLS. 100, 101 AND 102).

FIRST USE 2-15-2007; IN COMMERCE 2-15-2007.

CLASS 45—PERSONAL AND LEGAL SERVICES

FOR LOST PROPERTY RETURN (U.S. CLS. 100 AND 101).

FIRST USE 2-15-2007; IN COMMERCE 2-15-2007.
SANJEEV VOHRA, EXAMINING ATTORNEY

SN 77-136,823. KOGER AIR CORPORATION, MARTINSVILLE, VA. FILED 3-21-2007.



THE COLOR(S) BLUE AND GRAY IS/ARE CLAIMED AS A FEATURE OF THE MARK.

THE MARK CONSISTS OF A BLUE SIX SIDED STAR FOLLOWED BY THE WORDS "KOGER" IN GRAY AND "AIR" IN BLUE.

CLASS 37—CONSTRUCTION AND REPAIR

FOR INSTALLATION OF INDUSTRIAL EQUIPMENT, NAMELY, DUST CONTROL, CONVEYING, BLOWPIPE, AND AIR-HANDLING EQUIPMENT (U.S. CLS. 100, 103 AND 106).

FIRST USE 2-1-2007; IN COMMERCE 2-1-2007.

CLASS 42—SCIENTIFIC AND COMPUTER SERVICES

FOR DESIGN SERVICES IN THE FIELD OF INDUSTRIAL EQUIPMENT, NAMELY, DUST CONTROL, CONVEYING, BLOWPIPE, AND AIR-HANDLING EQUIPMENT (U.S. CLS. 100 AND 101).

FIRST USE 2-1-2007; IN COMMERCE 2-1-2007.

JACLYN KIDWELL, EXAMINING ATTORNEY

SN 77-137,560. SMITH & ASSOCIATES, INC., OVERLAND PARK, KS. FILED 3-22-2007.

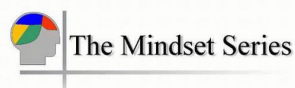

NO CLAIM IS MADE TO THE EXCLUSIVE RIGHT TO USE "SERIES", APART FROM THE MARK AS SHOWN.

THE COLOR(S) RED, BLUE, YELLOW, GREEN, GRAY AND BLACK IS/ARE CLAIMED AS A FEATURE OF THE MARK.

THE MARK CONSISTS OF A DRAWING OF A PERSON'S HEAD IN GRAY WITH FOUR BLOCKS APPEARING IN THE TOP OF THE HEAD IN GREEN, YELLOW, BLUE AND RED, THE WORDS THE MINDSET SERIES TO THE RIGHT OF THE HEAD IN BLACK WITH GRAY SHADOWING, AND A GRAY HORIZONTAL LINE UNDERNEATH THE HEAD AND WORDS AND A VERTICAL GRAY LINE BETWEEN THE HEAD AND WORDS.

CLASS 16—PAPER GOODS AND PRINTED MATTER

FOR A SERIES OF BOOKS, WRITTEN ARTICLES, HANDOUTS AND WORKSHEETS IN THE FIELD OF LIFE PLANNING, BUSINESS PLANNING AND TEAM WORK (U.S. CLS. 2, 5, 22, 23, 29, 37, 38 AND 50).

FIRST USE 6-30-2004; IN COMMERCE 4-18-2005.

CLASS 41—EDUCATION AND ENTERTAINMENT

FOR CONDUCTING WORKSHOPS AND SEMINARS IN LIFE PLANNING, BUSINESS PLANNING AND TEAM WORK (U.S. CLS. 100, 101 AND 107).

FIRST USE 6-30-2004; IN COMMERCE 4-18-2005.

BARNEY CHARLON, EXAMINING ATTORNEY

SN 77-137,639. HIGH PRESSURE INTEGRITY, INC., HOUSTON, TX. FILED 3-22-2007.

HIP

THE MARK CONSISTS OF STANDARD CHARACTERS WITHOUT CLAIM TO ANY PARTICULAR FONT, STYLE, SIZE, OR COLOR.

CLASS 7—MACHINERY

FOR DOWNHOLE PLUGS, NAMELY, THRU-TUBING BRIDGE PLUGS USED IN THE OIL AND GAS INDUSTRY (U.S. CLS. 13, 19, 21, 23, 31, 34 AND 35).
FIRST USE 1-1-1985; IN COMMERCE 1-1-1985.

CLASS 19—NON-METALLIC BUILDING MATERIALS

FOR CEMENT MIX SLURRY BLENDS FOR BONDING IN WELL CASING IN THE OIL AND GAS INDUSTRY (U.S. CLS. 1, 12, 33 AND 50).
FIRST USE 1-1-1985; IN COMMERCE 1-1-1985.
TIMOTHY FINNEGAN, EXAMINING ATTORNEY

CLASS 20—FURNITURE AND ARTICLES NOT OTHERWISE CLASSIFIED

FOR INFANT BOUNCERS, BOOSTER SEATS (U.S. CLS. 2, 13, 22, 25, 32 AND 50).

CLASS 28—TOYS AND SPORTING GOODS

FOR INFANT SWINGS AND GLIDERS, AND BABY CARRIERS FOR USE WITH INFANT SWINGS AND GLIDERS; INFANT EXERCISE SEATS BEING DOORWAY JUMPERS (U.S. CLS. 22, 23, 38 AND 50).
BRENDAN REGAN, EXAMINING ATTORNEY

SN 77-138,099. REFCON, LCC, NORWOOD, NJ. FILED 3-22-2007.

REFCON

THE MARK CONSISTS OF STANDARD CHARACTERS WITHOUT CLAIM TO ANY PARTICULAR FONT, STYLE, SIZE, OR COLOR.

CLASS 11—ENVIRONMENTAL CONTROL APPARATUS

FOR HEATED MERCHANDISE DISPLAY CASES; REFRIGERATED MERCHANDISE DISPLAY CASES (U.S. CLS. 13, 21, 23, 31 AND 34).

CLASS 20—FURNITURE AND ARTICLES NOT OTHERWISE CLASSIFIED

FOR DISPLAY CASES FOR MERCHANDISE; FURNITURE FOR DISPLAYING GOODS; FURNITURE, NAMELY, DISPLAY UNITS; FURNITURE, NAMELY, SALES AND DISPLAY COUNTERS (U.S. CLS. 2, 13, 22, 25, 32 AND 50).
ROBIN MITTLER, EXAMINING ATTORNEY

SN 77-139,381. GRACO CHILDREN'S PRODUCTS INC., ATLANTA, GA. FILED 3-23-2007.

SWEET PEACE

THE MARK CONSISTS OF STANDARD CHARACTERS WITHOUT CLAIM TO ANY PARTICULAR FONT, STYLE, SIZE, OR COLOR.

CLASS 12—VEHICLES

FOR INFANTS' AND CHILDREN'S CAR SEATS; TRAVEL SYSTEMS, NAMELY, COMBINATION INFANTS' AND CHILDREN'S CAR SEATS AND INFANTS' AND CHILDREN'S CAR SEAT BASES (U.S. CLS. 19, 21, 23, 31, 35 AND 44).

SN 77-139,402. SENNIN PRODUCTIONS, L.L.C., LAFAYETTE, LA. FILED 3-23-2007.



THE MARK CONSISTS OF A CIRCULAR SHIELD CONTAINING THE FOLLOWING ELEMENTS: (1) IN THE CENTER, A TENGOKU SYMBOL CONSISTING OF THREE COMMA SHAPES, LAID END TO END, COMPRISING A CIRCLE AND CREATING THREE, BLADE-LIKE SPOKES BETWEEN THE COMMAS; AND (2) SURROUNDING THE INNER CIRCLE IS A DECORATIVE BORDER IN THE SHAPE OF A NINE-PRONGED COG WHEEL.

CLASS 35—ADVERTISING AND BUSINESS

FOR ADVERTISING AND MARKETING; ADVERTISING AND PUBLICITY SERVICES; ADVERTISING PARTICULARLY SERVICES FOR THE PROMOTION OF GOODS; ADVERTISING SERVICES, NAMELY, PROVIDING ADVERTISING SPACE IN A PERIODICAL; ADVERTISING SERVICES, NAMELY, PROVIDING INFORMATION AS TO THE AVAILABILITY OF ANIME ENTERTAINMENT MEDIA, INCLUDING MOVIES, GAMES, ART AND GOODS, AND JAPANESE ART AND GOODS FOR RENT OR PURCHASE; ADVERTISING VIA ELECTRONIC MEDIA AND SPECIFICALLY THE INTERNET; ARRANGING AND CONDUCTING TRADE SHOWS IN THE FIELD OF ANIME AND JAPANESE CULTURE; PROMOTING PUBLIC AWARENESS OF ANIME AND JAPANESE CULTURE; PROMOTING THE GOODS AND SERVICES OF OTHERS BY ARRANGING FOR SPONSORS TO AFFILIATE THEIR GOODS AND SERVICES WITH MECHAICON ANNUAL CONVENTION; THE BRINGING TOGETHER, FOR THE BENEFIT OF OTHERS, OF A VARIETY OF GOODS, ENABLING CUSTOMERS TO CONVENIENTLY VIEW AND PURCHASE THOSE GOODS (U.S. CLS. 100, 101 AND 102).

FIRST USE 11-1-2004; IN COMMERCE 11-1-2004.

CLASS 41—EDUCATION AND ENTERTAINMENT

FOR ARRANGING OF EXHIBITIONS, SEMINARS AND CONFERENCES; ART EXHIBITIONS; CONDUCTING EDUCATIONAL EXHIBITIONS IN THE NATURE OF CONVENTION SHOWCASING ANIME AND JAPANESE CULTURE; CONDUCTING ENTERTAINMENT EXHIBITIONS IN THE NATURE OF CONVENTION SHOWCASING ANIME FILM, VIDEO GAMES AND TOURNAMENTS; CONDUCTING WORKSHOPS AND SEMINARS IN ANIME AND JAPANESE CULTURE; EDUCATION SERVICES, NAMELY, PROVIDING CONVENTION SHOWCASING LECTURES, DEMONSTRATIONS AND PANEL DISCUSSIONS IN THE FIELD OF ANIME AND JAPANESE CULTURE; ENTERTAINMENT IN THE NATURE OF COMPETITIONS IN THE FIELD OF VIDEO GAMES; ENTERTAINMENT IN THE NATURE OF LIVE PERFORMANCES BY JAPANESE OR JAPANESE-STYLE MUSICIANS; ENTERTAINMENT IN THE NATURE OF ANIME MOVIE VIEWING, VIDEO GAME COMPETITIONS AND PERFORMANCES BY JAPANESE OR JAPANESE-STYLE MUSICIANS; ENTERTAINMENT IN THE NATURE OF VIDEO AND TABLETOP GAME EXHIBITIONS; ENTERTAINMENT, NAMELY, LIVE PERFORMANCES BY A MUSICAL BAND; ENTERTAINMENT SERVICES, NAMELY, PERSONAL APPEARANCES BY A ANIME INDUSTRY GUEST AND ARTISTS; ORGANIZING EXHIBITIONS FOR EDUCATIONAL PURPOSES IN THE FIELD OF ANIME AND JAPANESE CULTURE; PLANNING ARRANGEMENT OF SHOWING MOVIES, SHOWS, PLAYS OR MUSICAL PERFORMANCES; WORKSHOPS AND SEMINARS IN THE FIELD OF ANIME AND JAPANESE CULTURE (U.S. CLS. 100, 101 AND 107).

FIRST USE 11-1-2004; IN COMMERCE 11-1-2004.
STACY WAHLBERG, EXAMINING ATTORNEY

SN 77-139,695. WONG, JULIA, CALABASAS, CA. FILED 3-25-2007.

Julia Wong Designs

THE MARK CONSISTS OF STANDARD CHARACTERS WITHOUT CLAIM TO ANY PARTICULAR FONT, STYLE, SIZE, OR COLOR.

NO CLAIM IS MADE TO THE EXCLUSIVE RIGHT TO USE "DESIGNS", APART FROM THE MARK AS SHOWN.

CLASS 20—FURNITURE AND ARTICLES NOT OTHERWISE CLASSIFIED

FOR FURNITURE; CUSHIONS; BEDROOM FURNITURE; BUMPER GUARDS FOR FURNITURE; CABINETS; CARPET COASTERS FOR PROTECTING FURNITURE LEGS; CAST STONE HOUSEHOLD AND GARDEN FURNITURE; COMPUTER FURNITURE; DINNER WAGONS; DOORS FOR FURNITURE; DRAFTING TABLES; ENTERTAINMENT CENTERS; FITTED FABRIC FURNITURE COVERS; FITTED FURNITURE COVER NOT OF FABRIC; FURNITURE CHESTS; FURNITURE FOR DISPLAYING GOODS; FURNITURE FOR HOUSE, OFFICE AND GARDEN; FURNITURE FRAMES; FURNITURE HARDWARE, NAMELY, DRAWER SLIDES; FURNITURE MADE FROM STEEL TUBING; FURNITURE MOLDINGS; FURNITURE PARTITIONS; FURNITURE PARTS; FURNITURE PARTS, NAMELY, COUNTERTOPS; FURNITURE, NAMELY, DISPLAY UNITS; FURNITURE, NAMELY, DRESSERS; FURNITURE, NAMELY, SALES AND DISPLAY COUNTERS; FURNITURE, NAMELY, WALL UNITS; FURNITURE, NAMELY, WARDROBES; INDOOR WINDOW BLINDS; LAWN FURNITURE; LIVING ROOM FURNITURE; MIRRORS; OFFICE FURNITURE; OUTDOOR FURNITURE; PLASTIC FURNITURE FOR GARDENS; PLASTIC MOLDS FOR USE IN MANUFACTURING FURNITURE, BED LINERS, TRAILER FLOORING AND DECKS; RECLINERS; SCREENS; SEATING FURNITURE; SEATS; STONE FURNITURE; TABLES; TOOL BOXES NOT OF METAL; TOOL CHESTS NOT OF METAL; FURNITURE; TOWEL CLOSETS; TOY BOXES (U.S. CLS. 2, 13, 22, 25, 32 AND 50).

CLASS 24—FABRICS

FOR FABRIC WINDOW COVERINGS AND TREATMENTS, NAMELY CURTAINS, DRAPERIES, SHEERS, SWAGS AND VALANCES; CONTOURED MATTRESS COVERS; COVERS FOR CUSHIONS; CURTAIN FABRIC; DUVET COVERS; FABRIC TABLE RUNNERS; FABRIC TABLE TOPPERS; FABRIC VALANCES; MATTRESS COVERS; PAPER BED COVERS; SWAGS; TEXTILE FABRICS FOR LINGERIE; UNFITTED FABRIC FURNITURE COVERS; UNFITTED FURNITURE COVERS NOT OF PAPER; UNFITTED FUTON COVERS NOT OF PAPER; UPHOLSTERY FABRICS; WINDOW CURTAINS (U.S. CLS. 42 AND 50).

ALEX KEAM, EXAMINING ATTORNEY

SN 77-139,622. KLECZKA, DAVID HENRY, NEW BERLIN, WI. FILED 3-24-2007.

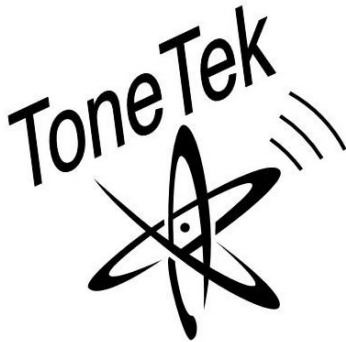

THE MARK CONSISTS OF A STYLIZED "TONETEK" WITH AN ATOM SYMBOL AND CURVED BANDS DEPICTING SOUND WAVES.

CLASS 9—ELECTRICAL AND SCIENTIFIC APPARATUS

FOR DOWNLOADABLE MUSICAL SOUND RECORDINGS; MUSICAL SOUND RECORDINGS; MUSICAL VIDEO RECORDINGS (U.S. CLS. 21, 23, 26, 36 AND 38).

CLASS 15—MUSICAL INSTRUMENTS

FOR GUITAR PICKS (U.S. CLS. 2, 21 AND 36).
HENRY S. ZAK, EXAMINING ATTORNEY

SN 77-139,935. PERFORMANCE LICENSING, LLC, WINSTON-SALEM, NC. FILED 3-26-2007.



NO CLAIM IS MADE TO THE EXCLUSIVE RIGHT TO USE "TORCH" AS TO INTERNATIONAL CLASS 011 ONLY, APART FROM THE MARK AS SHOWN.

THE MARK CONSISTS OF THE WORD "TAILGATE" WHICH IS TYPED IN A BLOCK FONT WITH A FLAME AS THE DOT OVER THE "I" IN TAILGATE. THE TOP OF THE CAPITAL "T" IN "TAILGATE" EXTENDS OVER THE "A" IN "TAILGATE." ADDITIONALLY THE BOTTOM PART OF THE LETTER "G" IN "TAILGATE" EXTENDS TO THE LEFT UNDER THE LETTERS "I" AND "L." THE WORD "TORCH" IS TYPED IN A BLOCK FONT WITH THE TOP LINE OF THE CAPITAL LETTER "T" EXTENDING OVER THE "O" IN TORCH.

CLASS 11—ENVIRONMENTAL CONTROL APPARATUS

FOR FLASHLIGHTS (U.S. CLS. 13, 21, 23, 31 AND 34).

CLASS 21—HOUSEWARES AND GLASS

FOR CORK SCREWS; BOTTLE OPENERS (U.S. CLS. 2, 13, 23, 29, 30, 33, 40 AND 50).

CLASS 34—SMOKERS' ARTICLES

FOR LIGHTERS FOR SMOKERS (U.S. CLS. 2, 8, 9 AND 17).

LINDA POWELL, EXAMINING ATTORNEY

SN 77-140,153. JACT MEDIA LLC, DALLAS, TX. FILED 3-26-2007.

JACT

THE MARK CONSISTS OF STANDARD CHARACTERS WITHOUT CLAIM TO ANY PARTICULAR FONT, STYLE, SIZE, OR COLOR.

CLASS 9—ELECTRICAL AND SCIENTIFIC APPARATUS

FOR PROVIDING ON-LINE DOWNLOADABLE SOFTWARE FOR USE IN TIME MANAGEMENT OF ON-LINE VIDEO GAME PLAY (U.S. CLS. 21, 23, 26, 36 AND 38). FIRST USE 3-30-2005; IN COMMERCE 3-30-2005.

CLASS 35—ADVERTISING AND BUSINESS

FOR INCENTIVE AWARD PROGRAM TO PROMOTE THE PARTICIPATION OF ONLINE VIDEO GAME PLAY; ONLINE RETAIL STORE SERVICES FEATURING, GAMER GEAR, VIDEO GAMES, MOVIES, GAMES AND TOYS, ELECTRONICS, COMPUTERS AND ACCESSORIES, AND HOME AND GARDEN PRODUCTS; PROMOTING THE GOODS AND SERVICES OF OTHERS BY MEANS OF OPERATING AN ON-LINE SHOPPING MALL (U.S. CLS. 100, 101 AND 102).

FIRST USE 3-30-2005; IN COMMERCE 3-30-2005. MARK SPARACINO, EXAMINING ATTORNEY

SN 77-140,530. TELLURIDE RESORT & SPA, LLC, DALLAS, TX. FILED 3-26-2007.



OWNER OF U.S. REG. NOS. 862,884, 3,038,608 AND OTHERS.

NO CLAIM IS MADE TO THE EXCLUSIVE RIGHT TO USE "RESORT" AND "SPA", APART FROM THE MARK AS SHOWN.

THE COLOR(S) GREY AND GREEN IS/ARE CLAIMED AS A FEATURE OF THE MARK.

THE MARK CONSISTS OF A GREEN THREE-FANNED SPIRAL DESIGN ABOVE THE WORDS "THE PEAKS RESORT & GOLDEN DOOR SPA" IN GREY LETTERING.

CLASS 35—ADVERTISING AND BUSINESS

FOR HOTEL AND RESORT MANAGEMENT SERVICES FOR OTHERS (U.S. CLS. 100, 101 AND 102). FIRST USE 11-1-2005; IN COMMERCE 11-1-2005.

CLASS 41—EDUCATION AND ENTERTAINMENT

FOR HEALTH AND FITNESS CLUB SERVICES; PHYSICAL FITNESS INSTRUCTION (U.S. CLS. 100, 101 AND 107).

FIRST USE 11-1-2005; IN COMMERCE 11-1-2005.

CLASS 43—HOTEL AND RESTAURANT SERVICES

FOR RESORT HOTELS; RESTAURANT SERVICES (U.S. CLS. 100 AND 101). FIRST USE 11-1-2005; IN COMMERCE 11-1-2005.

CLASS 44—MEDICAL, BEAUTY AND AGRICULTURAL SERVICES

FOR HEALTH SPA SERVICES FOR HEALTH AND WELLNESS OF THE BODY AND SPIRIT OFFERED AT A HEALTH RESORT, AND HEALTH SPA SERVICES, NAMELY COSMETIC BODY CARE SERVICES (U.S. CLS. 100 AND 101).

FIRST USE 11-1-2005; IN COMMERCE 11-1-2005.

JENNIFER KRISP, EXAMINING ATTORNEY

SN 77-140,742. IMERJENT LLC, WILSONVILLE, OR. FILED 3-26-2007.



THE MARK CONSISTS OF THE WORD IMERJENT IN COMBINATION WITH A SUN AND HORIZON DESIGN.

CLASS 6—METAL GOODS

FOR PORTABLE BIODIESEL PRODUCTION AND DISTRIBUTION EQUIPMENT NAMELY METAL INTER-MODAL SHIPPING CONTAINERS (U.S. CLS. 2, 12, 13, 14, 23, 25 AND 50).

CLASS 11—ENVIRONMENTAL CONTROL APPARATUS

FOR FULLY AUTOMATED AND STATIONARY BIODIESEL PRODUCTION AND DISTRIBUTION EQUIPMENT, NAMELY MODULAR REFINERY UNITS COMPRISED OF SEPARATORS FOR THE CLEANING AND PURIFICATION OF LIQUID BIOFUELS (U.S. CLS. 13, 21, 23, 31 AND 34).

LYDIA BELZER, EXAMINING ATTORNEY

SN 77-141,933. SUN GRO HORTICULTURE CANADA LTD., SEBA BEACH, CANADA, FILED 3-27-2007.

The Secret's in the Soil!

THE MARK CONSISTS OF STANDARD CHARACTERS WITHOUT CLAIM TO ANY PARTICULAR FONT, STYLE, SIZE, OR COLOR.

CLASS 1—CHEMICALS

FOR POTTING AND PLANTING SOIL MIXES COMPRISED OF ORGANIC MATERIALS AND CONTAINING FERTILIZER ALL FOR HORTICULTURAL USE (U.S. CLS. 1, 5, 6, 10, 26 AND 46).

CLASS 31—NATURAL AGRICULTURAL PRODUCTS

FOR PEAT MOSS CONTAINING HORTICULTURAL MIXES FOR USE AS A SOIL SUBSTITUTE (U.S. CLS. 1 AND 46).

MARGERY A. TIERNEY, EXAMINING ATTORNEY

SN 77-142,227. PRODUCT PARTNERS LLC, BEVERLY HILLS, CA. FILED 3-28-2007.

DO IT WITH ME

THE MARK CONSISTS OF STANDARD CHARACTERS WITHOUT CLAIM TO ANY PARTICULAR FONT, STYLE, SIZE, OR COLOR.

CLASS 18—LEATHER GOODS

FOR BACKPACKS; GYM BAGS; TRAVEL BAGS (U.S. CLS. 1, 2, 3, 22 AND 41).

CLASS 25—CLOTHING

FOR CLOTHING, NAMELY, SHIRTS, TOPS, T-SHIRTS, SWEAT SHIRTS, SWEAT PANTS, SWEAT SUITS, SHORTS, PANTS, JACKETS, SWEATERS AND SOCKS (U.S. CLS. 22 AND 39).

CLASS 41—EDUCATION AND ENTERTAINMENT

FOR EDUCATIONAL SERVICES, NAMELY, INSTRUCTION IN THE FIELDS OF EXERCISE EQUIPMENT, FITNESS EXERCISE, AND DIET AND NUTRITION PROGRAMS; PROVIDING A WEB SITE FEATURING ON-LINE INSTRUCTION IN THE FIELDS OF PHYSICAL EXERCISE AND NUTRITION AND FOR TRACKING PROGRESS OF PHYSICAL FITNESS WORK-OUTS (U.S. CLS. 100, 101 AND 107).

HANNO RITTNER, EXAMINING ATTORNEY

SN 77-142,629. DEROSSETT ENTERPRISES, INC., CORONA DEL MAR, CA. FILED 3-28-2007.

VINTNER FRIENDLY

THE MARK CONSISTS OF STANDARD CHARACTERS WITHOUT CLAIM TO ANY PARTICULAR FONT, STYLE, SIZE, OR COLOR.

NO CLAIM IS MADE TO THE EXCLUSIVE RIGHT TO USE "VINTNER", APART FROM THE MARK AS SHOWN.

CLASS 32—LIGHT BEVERAGES

FOR GRAPE MUST (U.S. CLS. 45, 46 AND 48).

CLASS 33—WINES AND SPIRITS

FOR KITS FOR MAKING WINE (U.S. CLS. 47 AND 49).

JOHN SCHUYLER YARD, EXAMINING ATTORNEY

SN 77-143,063. DUJARDIN DESIGN ASSOCIATES, INC., WESTPORT, CT. FILED 3-28-2007.

HOLISTIC HOUSE

THE MARK CONSISTS OF STANDARD CHARACTERS WITHOUT CLAIM TO ANY PARTICULAR FONT, STYLE, SIZE, OR COLOR.

NO CLAIM IS MADE TO THE EXCLUSIVE RIGHT TO USE "HOUSE", APART FROM THE MARK AS SHOWN.

CLASS 1—CHEMICALS

FOR INDUSTRIAL ADHESIVES (U.S. CLS. 1, 5, 6, 10, 26 AND 46).

CLASS 2—PAINTS

FOR PRESERVATIVE COATINGS FOR PAPER AND WOOD SURFACES; PRESERVATIVE COATINGS FOR INSULATION, DRYWALL, AND MASONRY (U.S. CLS. 6, 11 AND 16).

CLASS 8—HAND TOOLS

FOR FLATWARE AND CUTLERY (U.S. CLS. 23, 28 AND 44).

CLASS 11—ENVIRONMENTAL CONTROL APPARATUS

FOR LIGHTING FIXTURES; HVAC UNITS; GAS AND ELECTRIC COOKING STOVES; REFRIGERATORS; PLUMBING FITTINGS, NAMELY, FAUCETS, FAUCET AERATORS, FAUCET SPRAYERS, TAP WATER FAUCETS, WATER FAUCET SPOUTS, FAUCETS FOR BATH TUBS AND SINKS; BATH TUBS; SINKS; TOILETS (U.S. CLS. 13, 21, 23, 31 AND 34).

SN 77-143,422. L&P PROPERTY MANAGEMENT COMPANY, SOUTH GATE, CA. FILED 3-29-2007.

GROWING A GREENER TOMORROW

CLASS 16—PAPER GOODS AND PRINTED MATTER

FOR BOOKS, NAMELY, BOOKS ON INTERIOR DESIGN, SUSTAINABLE DESIGN AND ENVIRONMENTAL IMPACT; PRINTED PERIODICALS IN THE FIELD OF INTERIOR DESIGN, SUSTAINABLE DESIGN AND ENVIRONMENTAL IMPACT; PAMPHLETS IN THE FIELD OF INTERIOR DESIGN, SUSTAINABLE DESIGN AND ENVIRONMENTAL IMPACT; PHOTOGRAPHS; GRAPHIC PRINTS; BLUEPRINTS AND DESIGN DRAWINGS (U.S. CLS. 2, 5, 22, 23, 29, 37, 38 AND 50).

THE MARK CONSISTS OF STANDARD CHARACTERS WITHOUT CLAIM TO ANY PARTICULAR FONT, STYLE, SIZE, OR COLOR.

CLASS 1—CHEMICALS

FOR SOIL ADDITIVES, NAMELY, TACKIFIER AND BINDING AGENT FOR USE IN EROSION CONTROL AND SOIL STABILIZATION; FERTILIZER BLENDS (U.S. CLS. 1, 5, 6, 10, 26 AND 46).

CLASS 20—FURNITURE AND ARTICLES NOT OTHERWISE CLASSIFIED

FOR FURNITURE; PILLOWS; WINDOW BLINDS; MATTRESSES (U.S. CLS. 2, 13, 22, 25, 32 AND 50).

CLASS 31—NATURAL AGRICULTURAL PRODUCTS

FOR GRASS SEED MIXTURES INCLUDING CLOVERS, AUSTRIAN WINTER PEAS, CROWN VETCH, LESPEDEZAS, AND/OR MILLETS (U.S. CLS. 1 AND 46).
SUNG IN, EXAMINING ATTORNEY

CLASS 21—HOUSEWARES AND GLASS

FOR BEVERAGE GLASSWARE; PORCELAIN, NAMELY DINNERWARE PLATES, CUPS, MUGS, SAUCERS, BOWLS, SERVING DISHES, TEA SETS, FIGURINES, VASES (U.S. CLS. 2, 13, 23, 29, 30, 33, 40 AND 50).

SN 77-143,611. THE AMERICAN INSTITUTE OF ARCHITECTS, WASHINGTON, DC. FILED 3-29-2007.

CLASS 24—FABRICS

FOR TEXTILES NAMELY, UNFITTED FABRIC FURNITURE COVERS, UPHOLSTERY FABRICS; BED LINEN; BATH LINEN, KITCHEN LINEN, TABLE CLOTHS NOT OF PAPER; TEXTILE WALL HANGINGS; PILLOW CASES, PILLOW COVERS AND PILLOW SHAMS; FABRIC TABLE TOPPERS, RUNNERS AND PLACEMATS; FABRIC WINDOW COVERINGS AND TREATMENTS, NAMELY CURTAINS, DRAPERIES, SHEERS, SWAGS AND VALANCES; TEXTILE FABRICS FOR HOME AND COMMERCIAL INTERIORS; MATTRESS PADS (U.S. CLS. 42 AND 50).

SOLOSO

THE MARK CONSISTS OF STANDARD CHARACTERS WITHOUT CLAIM TO ANY PARTICULAR FONT, STYLE, SIZE, OR COLOR.

CLASS 26—FANCY GOODS

FOR LACE AND EMBROIDERY; RIBBONS, FRINGES AND BRAIDS (U.S. CLS. 37, 39, 40, 42 AND 50).

CLASS 35—ADVERTISING AND BUSINESS

FOR PROVIDING BUSINESS RESEARCH SERVICES AND BUSINESS INFORMATION FOR THE ARCHITECTURE PROFESSION VIA THE INTERNET (U.S. CLS. 100, 101 AND 102).

CLASS 27—FLOOR COVERINGS

FOR CARPETS, RUGS, LINOLEUM FOR USE ON FLOORS; FLOOR COVERINGS; WALLPAPER (U.S. CLS. 19, 20, 37, 42 AND 50).

CLASS 41—EDUCATION AND ENTERTAINMENT

FOR PROVIDING ONLINE EDUCATION SERVICES, NAMELY, CONDUCTING ONLINE SEMINARS AND COURSES OF INSTRUCTION IN THE FIELD OF ARCHITECTURE VIA THE INTERNET (U.S. CLS. 100, 101 AND 107).

CLASS 42—SCIENTIFIC AND COMPUTER SERVICES

FOR DESIGN FOR OTHERS IN THE FIELDS OF HOME, INTERIOR, FURNITURE AND FURNISHING DESIGN; ARCHITECTURAL DESIGN FOR OTHERS; CONSULTING SERVICES, RESEARCH AND DESIGN FOR OTHERS IN THE FIELD OF SUSTAINABLE DESIGN AND ANALYSIS OF ENVIRONMENTAL IMPACT (U.S. CLS. 100 AND 101).

ROSELLE HERRERA, EXAMINING ATTORNEY

CLASS 42—SCIENTIFIC AND COMPUTER SERVICES

FOR PROVIDING TECHNICAL INFORMATION IN THE FIELD OF ARCHITECTURE VIA THE INTERNET (U.S. CLS. 100 AND 101).

DAVID H. STINE, EXAMINING ATTORNEY

SN 77-144,277. FERAL CHILDREN PRODUCTIONS, LLC,
LOS ANGELES, CA. FILED 3-29-2007.

BEAUTIFUL/
DECAY

THE MARK CONSISTS OF THE WORD "BEAUTIFUL" ABOVE THE WORD "DECAY" WITH A FORWARD SLASH AFTER THE WORD BEAUTIFUL. BOTH WORDS ARE IN CAPITAL LETTERS AND THE WORD BEAUTIFUL IS SLIGHTLY DARKER.

CLASS 16—PAPER GOODS AND PRINTED MATTER

FOR MAGAZINES FEATURING INFORMATION ABOUT FINE ART, DESIGN, FASHION, GRAFFITI AND OTHER RELEVANT FORMS OF ART (U.S. CLS. 2, 5, 22, 23, 29, 37, 38 AND 50).

FIRST USE 4-1-2001; IN COMMERCE 4-1-2001.

CLASS 25—CLOTHING

FOR TOPS (U.S. CLS. 22 AND 39).
FIRST USE 1-1-2006; IN COMMERCE 1-1-2006.

CLASS 42—SCIENTIFIC AND COMPUTER SERVICES

FOR COMPUTER SERVICES, NAMELY, HOSTING AND MAINTAINING AN ONLINE WEBSITE FOR OTHERS TO OBTAIN INFORMATION ABOUT FINE ART, DESIGN, FASHION, GRAFFITI AND OTHER RELEVANT FORMS OF ART (U.S. CLS. 100 AND 101).
FIRST USE 4-1-2001; IN COMMERCE 4-1-2001.

MARIAM MAHMOUDI, EXAMINING ATTORNEY

SN 77-144,622. EAST CAROLINA UNIVERSITY, GREENVILLE, NC. FILED 3-30-2007.



OWNER OF U.S. REG. NOS. 2,266,402, 2,858,176 AND OTHERS.

THE MARK CONSISTS OF THE DESIGN OF A PIRATE SKULL WEARING AN EYE PATCH, A BANDANA AND A HOOP EARRING.

CLASS 16—PAPER GOODS AND PRINTED MATTER

FOR ANNUAL YEARBOOKS, NOTEBOOKS, LOOSE-LEAF BINDERS, WRITING PAPER AND ENVELOPES, DESK PADS, NOTEPAD HOLDERS, LETTER OPENERS, PENCIL CUPS, PLASTIC CONTAINERS FOR PAPER CLIPS, APPOINTMENT BOOKS, ADDRESS BOOKS, CALENDARS, PROTECTIVE BINDERS FOR DIPLOMAS, PENS, PEN AND PENCIL SETS, BOOK ENDS, LAP BOARD FOR HOLDING BOOKS AND PAPER, DECALS, POSTCARDS, BUMPER STICKERS, AND PAPER NAPKINS (U.S. CLS. 2, 5, 22, 23, 29, 37, 38 AND 50).

CLASS 25—CLOTHING

FOR SLEEP SHIRTS, ROBES, SHIRTS, T-SHIRTS, TENNIS SHIRTS, TOPS, JERSEYS, SWEAT SHIRTS, SWEAT PANTS, WARM-UP SUITS, SWEATERS, BLAZERS, JACKETS, VESTS, SHORTS, BABY PANTS, CLOTH BABY BIBS, TIES, SHOES, MITTENS, SCARVES, SOCKS, CAPS AND VISORS (U.S. CLS. 22 AND 39).
LESLIE RICHARDS, EXAMINING ATTORNEY

SN 77-145,082. BREADFRUIT TRADING COMPANY, PHILADELPHIA, PA. FILED 3-30-2007.

BREADFRUIT TRADING COMPANY

THE MARK CONSISTS OF STANDARD CHARACTERS WITHOUT CLAIM TO ANY PARTICULAR FONT, STYLE, SIZE, OR COLOR.

NO CLAIM IS MADE TO THE EXCLUSIVE RIGHT TO USE "TRADING COMPANY", APART FROM THE MARK AS SHOWN.

CLASS 21—HOUSEWARES AND GLASS

FOR BUTLERS' TRAYS; SERVING TRAYS; UTENSILS FOR BARBECUES, NAMELY, FORKS, TONGS, TURNERS; MIXING SPOONS; SOAP HOLDERS; BATH ACCESSORIES, NAMELY, CUP HOLDERS; TOOTHBRUSH HOLDERS; CONTAINERS FOR HOUSEHOLD USE; SOAP CONTAINERS (U.S. CLS. 2, 13, 23, 29, 30, 33, 40 AND 50).

CLASS 29—MEATS AND PROCESSED FOODS

FOR VEGETABLE CHIPS (U.S. CL. 46).

CLASS 35—ADVERTISING AND BUSINESS

FOR MANAGEMENT AND BUSINESS CONSULTING SERVICES IN THE FIELD OF ORGANIC FARMING AND GARDENING (U.S. CLS. 100, 101 AND 102).
LESLEY LAMOTHE, EXAMINING ATTORNEY

SN 77-145,843. CREATIVE DIRECT RESPONSE, INC., BO-
WIE, MD. FILED 4-2-2007.

SN 77-146,078. RESTIVO, EDMOND J., CARRIERE, MS.
FILED 4-2-2007.

**CDR FUNDRAISING GROUP
LEADING. CREATING.
DELIVERING.**

THE MARK CONSISTS OF STANDARD CHARACTERS
WITHOUT CLAIM TO ANY PARTICULAR FONT, STYLE,
SIZE, OR COLOR.

NO CLAIM IS MADE TO THE EXCLUSIVE RIGHT TO
USE "FUNDRAISING GROUP", APART FROM THE MARK
AS SHOWN.

CLASS 35—ADVERTISING AND BUSINESS

FOR DIRECT MAIL ADVERTISING; MAILING LIST
PREPARATION; DIRECT MARKETING SERVICES,
NAMELY, MARKET RESEARCH SERVICES, CONDUCT-
ING MARKETING STUDIES, MARKETING PLAN DE-
VELOPMENT, AND STATISTICAL EVALUATIONS OF
MARKET DATA; ADVERTISING AND ADVERTISE-
MENT SERVICES, NAMELY, CREATING BRAND IDEN-
TITY FOR OTHERS; BUSINESS CONSULTATION,
NAMELY, BUSINESS ORGANIZATIONAL CONSULTA-
TION; BUSINESS MARKETING CONSULTING SER-
VICES; AND BUSINESS MANAGEMENT CONSULTING
AND ADVISORY SERVICES FOR NONPROFIT ORGA-
NIZATIONS AND CHARITIES (U.S. CLS. 100, 101 AND
102).

CLASS 36—INSURANCE AND FINANCIAL

FOR CHARITABLE FUNDRAISING (U.S. CLS. 100, 101
AND 102).

**CLASS 42—SCIENTIFIC AND COMPUTER
SERVICES**

FOR GRAPHIC DESIGN SERVICES (U.S. CLS. 100
AND 101).

APRIL ROACH, EXAMINING ATTORNEY

SN 77-145,933. ABBOTT LABORATORIES, ABBOTT PARK,
IL. FILED 4-2-2007.



CLASS 5—PHARMACEUTICALS

FOR MEDICAL DIAGNOSTIC REAGENTS, MEDICAL
DIAGNOSTIC TEST STRIPS FOR USE IN THE FIELD OF
MONITORING BLOOD GLUCOSE LEVELS (U.S. CLS. 6,
18, 44, 46, 51 AND 52).

CLASS 10—MEDICAL APPARATUS

FOR LANCING DEVICES FOR EXTRACTING BLOOD,
LANCETS AND DIAGNOSTIC INSTRUMENTS,
NAMELY, BLOOD GLUCOSE MONITORS (U.S. CLS. 26,
39 AND 44).

TINA KUAN, EXAMINING ATTORNEY



NO CLAIM IS MADE TO THE EXCLUSIVE RIGHT TO
USE "PROSTHETICS & ORTHOTICS LIMBCARE LLC",
APART FROM THE MARK AS SHOWN.

THE COLOR(S) GREEN, YELLOW, BLACK IS/ARE
CLAIMED AS A FEATURE OF THE MARK.

THE MARK CONSISTS OF THE WORD LIMBCARE WITH
A PICTORIAL REPRESENTATION OF A LEG AS THE
LETTER "L" AND THE RX SYMBOL AS THE LETTER
"R." THE COLOR GREEN APPEARS IN THE WORD
LIMBCARE, THE COLOR BLACK APPEARS IN THE
WORDS "PROSTHETICS & ORTHOTICS LLC" AND THE
COLOR YELLOW APPEARS IN THE UNDERLINE UNDER-
NEATH THE WORD "LIMBCARE"

CLASS 10—MEDICAL APPARATUS

FOR ARTIFICIAL LIMBS; BRACES FOR LIMBS (U.S.
CLS. 26, 39 AND 44).

CLASS 44—MEDICAL, BEAUTY AND AGRICULTURAL SERVICES

FOR PROVIDING MEDICAL CARE TO PATIENTS IN
CONNECTION WITH THE MEDICAL EVALUATION,
FITTING AND ADJUSTMENT OF PROSTHETIC AND
ORTHOTIC DEVICES; MEDICAL COUNSELING,
NAMELY, ADDRESSING THE PHYSICAL AND EMOTIONAL
NEEDS OF PATIENTS LIVING WITH DISEASE,
TRAUMA, BIRTH DEFECTS AND INJURIES (U.S. CLS.
100 AND 101).

CARYN GLASSER, EXAMINING ATTORNEY

SN 77-146,418. BILLY BURNETT, EASTWOOD, KY. FILED 4-
2-2007.

SO FULL OF IT

THE MARK CONSISTS OF STANDARD CHARACTERS
WITHOUT CLAIM TO ANY PARTICULAR FONT, STYLE,
SIZE, OR COLOR.

CLASS 18—LEATHER GOODS

FOR BOOK BAGS; BRIEF CASES; TOTE BAGS (U.S.
CLS. 1, 2, 3, 22 AND 41).

CLASS 25—CLOTHING

FOR ANKLE SOCKS; APRONS; BABY BIBS NOT OF PAPER; BANDANAS; BANDEAUX; BASEBALL CAPS; BATHING SUITS; BATHING TRUNKS; BEACH COVER-UPS; BEACHWEAR; BELTS; BERETS; BERMUDA SHORTS; BLOOMERS; BOOTIES; BOW TIES; BOXER BRIEFS; BOXER SHORTS; BRIEFS; CAMISOLES; CAMP SHIRTS; CAP VISORS; CAPRIS; CAPS; CLOTH DIAPERS; CREEPERS; CROP TOPS; DEMIN JACKETS; FLEECE PULLOVERS; GYM SHORTS; HALTER TOPS; HEADBANDS; JEANS; JERSEYS; JOGGING OUTFITS; KERCHEIFS; KNEE HIGHS; KNIT SHIRTS; MEN AND WOMEN JACKETS, COATS, TROUSERS AND VESTS; NECKTIES, NIGHT SHIRTS, PAJAMAS; PANTIES, SHORTS, BRIEFS; POLO SHIRTS; PONCHOS; PULL-OVERS; RAINWEAR; ROMPERS; RUGBY TOPS; SCARVES; SHIRTS; SHORTS; SKI WEAR; SLEEPING GARMENTS; SOCKS AND STOCKINGS; SPORTS SHIRTS; SUSPENDERS; SWEAT BANDS; SWEATERS; SWIMWEAR; T-SHIRTS; TANK TOPS, TOBOGGAN HATS, PANT AND BOOTS; TRUNKS; TURTLENECKS; UNDERWEAR; VESTS; WARM UP SUITS; WIND JACKETS; WRIST BANDS (U.S. CLS. 22 AND 39).

CLASS 35—ADVERTISING AND BUSINESS

FOR ADVERTISING, MARKETING AND PROMOTION SERVICES TO PROMOTE TRAVEL AND TOURISM FOR OTHERS (U.S. CLS. 100, 101 AND 102).
BENJAMIN ALLEN, EXAMINING ATTORNEY

SN 77-146,796. INTERNATIONAL MERCHANDISING SERVICE, INC., FULLERTON, CA. FILED 4-2-2007.



NO CLAIM IS MADE TO THE EXCLUSIVE RIGHT TO USE "TOOLS" AND THE MAP OF THE CONTINENTAL UNITED STATES, APART FROM THE MARK AS SHOWN.
THE COLOR(S) RED, BLUE, WHITE, AND BLACK IS/ARE CLAIMED AS A FEATURE OF THE MARK.

THE OUTLINE OF THE CONTINENTAL UNITED STATES IS BLACK; US IS BLUE, WITH BLACK OUTLINING AND WHITE SHADOW/EMBOSSING EFFECT; T IS RED WITH BLACK OUTLINING AND WHITE SHADOW/EMBOSSING EFFECT; ULTIMATE SOLUTION TOOLS IS BLACK, WITH WHITE OUTLINING.

CLASS 7—MACHINERY

FOR AIR COMPRESSORS; PORTABLE ELECTRIC POWER GENERATORS (U.S. CLS. 13, 19, 21, 23, 31, 34 AND 35).
FIRST USE 2-1-2003; IN COMMERCE 2-1-2003.

CLASS 8—HAND TOOLS

FOR HAND TOOLS, NAMELY, HAMMERS, SCREWDRIVERS, WRENCHES (U.S. CLS. 23, 28 AND 44).
FIRST USE 2-1-2003; IN COMMERCE 2-1-2003.
PAUL E. FAHRENKOPF, EXAMINING ATTORNEY

SN 77-146,857. THE KROGER CO. OF MICHIGAN, LIVONIA, MI. FILED 4-2-2007.

ACTIVE LIFESTYLE

THE MARK CONSISTS OF STANDARD CHARACTERS WITHOUT CLAIM TO ANY PARTICULAR FONT, STYLE, SIZE, OR COLOR.

OWNER OF U.S. REG. NO. 3,234,765.

CLASS 3—COSMETICS AND CLEANING PREPARATIONS

FOR HAIR CARE PREPARATIONS; NON-MEDICATED SKIN CARE PREPARATIONS (U.S. CLS. 1, 4, 6, 50, 51 AND 52).

CLASS 5—PHARMACEUTICALS

FOR MEAL REPLACEMENT DRINKS; VITAMINS (U.S. CLS. 6, 18, 44, 46, 51 AND 52).

CLASS 29—MEATS AND PROCESSED FOODS

FOR FROZEN OR REFRIGERATED ENTREES CONSISTING OF PRIMARILY MEAT OR VEGETABLES; SOUPS; PEANUT BUTTER; PROTEIN-BASED SNACK BARS (U.S. CL. 46).

CLASS 30—STAPLE FOODS

FOR FROZEN OR REFRIGERATED ENTREES CONSISTING PRIMARILY OF PASTA; MAYONNAISE; COOKIES; BREAKFAST BARS; GRANOLA-BASED SNACK BARS; COFFEE; TEA; READY-TO-EAT CEREAL-BASED SNACK FOOD, NAMELY, ENERGY BARS (U.S. CL. 46).

CLASS 32—LIGHT BEVERAGES

FOR BOTTLED WATER; ENERGY DRINKS (U.S. CLS. 45, 46 AND 48).
YAT SYE, LEE, EXAMINING ATTORNEY

SN 77-147,122. PRODUCT PARTNERS LLC, BEVERLY HILLS, CA. FILED 4-3-2007.

ROCKIN' BODY

THE MARK CONSISTS OF STANDARD CHARACTERS WITHOUT CLAIM TO ANY PARTICULAR FONT, STYLE, SIZE, OR COLOR.

NO CLAIM IS MADE TO THE EXCLUSIVE RIGHT TO USE "BODY", APART FROM THE MARK AS SHOWN.

CLASS 9—ELECTRICAL AND SCIENTIFIC APPARATUS

FOR PRE-RECORDED VIDEO TAPES, CASSETTES, DVDS, AND CDS, FEATURING EXERCISE, FITNESS AND DIETARY INFORMATION AND INSTRUCTION (U.S. CLS. 21, 23, 26, 36 AND 38).

CLASS 41—EDUCATION AND ENTERTAINMENT

FOR EDUCATIONAL SERVICES, NAMELY, INSTRUCTION IN THE USE OF EXERCISE EQUIPMENT; PROVIDING INSTRUCTION IN THE FIELD OF NUTRITION, EXERCISE, FITNESS AND HEALTH; PROVIDING INSTRUCTION IN THE FIELD OF PHYSICAL EXERCISE; PROVIDING ON-LINE COMPUTER DATABASE FEATURING INFORMATION IN EXERCISE AND PHYSICAL FITNESS (U.S. CLS. 100, 101 AND 107).
 HANNO RITTNER, EXAMINING ATTORNEY

CLASS 41—EDUCATION AND ENTERTAINMENT

FOR ENTERTAINMENT IN THE NATURE OF VISUAL AND AUDIO PERFORMANCES, AND MUSICAL, VARIETY, NEWS AND COMEDY SHOWS; ENTERTAINMENT IN THE NATURE OF VISUAL AND AUDIO PERFORMANCES, NAMELY, MUSICAL BAND, ROCK GROUP, GYMNASTIC, DANCE, AND BALLET PERFORMANCES; ENTERTAINMENT NAMELY, LIVE PERFORMANCES BY A MUSICAL BAND; ENTERTAINMENT, NAMELY LIVE MUSIC CONCERTS; ENTERTAINMENT, NAMELY LIVE PERFORMANCES BY MUSICAL BANDS; PRESENTATION OF LIVE SHOW PERFORMANCES; PRESENTATION OF MUSICAL PERFORMANCE (U.S. CLS. 100, 101 AND 107).

SN 77-147,297. T. TIME CONSULTING, INC., DBA SENIOR LIFESTYLE TRENDS, SHOREVIEW, MN. FILED 4-3-2007.

CLASS 43—HOTEL AND RESTAURANT SERVICES

FOR RESTAURANT AND BAR SERVICES (U.S. CLS. 100 AND 101).
 LESLEY LAMOTHE, EXAMINING ATTORNEY

AMENISIZING YOUR LIFE

THE MARK CONSISTS OF STANDARD CHARACTERS WITHOUT CLAIM TO ANY PARTICULAR FONT, STYLE, SIZE, OR COLOR.

SN 77-147,385. HOWARD C. BERKSON, SAN DIEGO, CA. FILED 4-3-2007.

CLASS 16—PAPER GOODS AND PRINTED MATTER

FOR PRINTED MATERIALS, NAMELY, EDUCATIONAL MATERIALS AND BOOKLETS FEATURING INFORMATION AND INSTRUCTIONAL MATERIALS IN THE FIELD OF ASSISTING SENIOR CITIZENS AND THOSE WORKING WITH SENIOR CITIZENS IN MAKING DECISIONS ABOUT LIFESTYLE CHANGES AND TRANSITIONS (U.S. CLS. 2, 5, 22, 23, 29, 37, 38 AND 50).



CLASS 41—EDUCATION AND ENTERTAINMENT

FOR EDUCATIONAL SERVICES, NAMELY, PROVIDING SEMINARS AND PROGRAMS TO SENIOR CITIZENS AND THOSE WORKING WITH SENIOR CITIZENS TO HELP MAKE DECISIONS AND OVERCOME OBJECTIONS AND OBSTACLES WHICH MAY BE ASSOCIATED WITH MAKING DECISIONS ABOUT LIFESTYLE CHANGES AND TRANSITIONS (U.S. CLS. 100, 101 AND 107).
 MATTHEW EINSTEIN, EXAMINING ATTORNEY

NO CLAIM IS MADE TO THE EXCLUSIVE RIGHT TO USE "MUSIC & CUISINE", APART FROM THE MARK AS SHOWN.
 THE MARK CONSISTS OF THE STYLIZED WORDS "ANTHOLOGY FINE TUNED MUSIC & CUISINE" PRINTED ON A MUSICAL STAFF COMPRISED OF FIVE HORIZONTAL LINES.

SN 77-147,336. HOWARD C. BERKSON, SAN DIEGO, CA. FILED 4-3-2007.

ANTHOLOGY FINE TUNED MUSIC & CUISINE

CLASS 41—EDUCATION AND ENTERTAINMENT

FOR ENTERTAINMENT IN THE NATURE OF VISUAL AND AUDIO PERFORMANCES, AND MUSICAL, VARIETY, NEWS AND COMEDY SHOWS; ENTERTAINMENT IN THE NATURE OF VISUAL AND AUDIO PERFORMANCES, NAMELY, MUSICAL BAND, ROCK GROUP, GYMNASTIC, DANCE, AND BALLET PERFORMANCES; ENTERTAINMENT NAMELY, LIVE PERFORMANCES BY A MUSICAL BAND; ENTERTAINMENT, NAMELY LIVE PERFORMANCES BY MUSICAL BANDS; ENTERTAINMENT, NAMELY LIVE MUSIC CONCERTS; PRESENTATION OF LIVE SHOW PERFORMANCES; PRESENTATION OF MUSICAL PERFORMANCE (U.S. CLS. 100, 101 AND 107).

THE MARK CONSISTS OF STANDARD CHARACTERS WITHOUT CLAIM TO ANY PARTICULAR FONT, STYLE, SIZE, OR COLOR.
 NO CLAIM IS MADE TO THE EXCLUSIVE RIGHT TO USE "MUSIC & CUISINE", APART FROM THE MARK AS SHOWN.

CLASS 43—HOTEL AND RESTAURANT SERVICES

FOR RESTAURANT AND BAR SERVICES (U.S. CLS. 100 AND 101).
 LESLEY LAMOTHE, EXAMINING ATTORNEY

SN 77-147,402. FOG KIST OF SANTA CRUZ, LLC, SANTA CRUZ, CA. FILED 4-3-2007.

SN 77-147,810. LYLES CAROLINA HERITAGE CORP., FORT COLLINS, CO. FILED 4-3-2007.

FOG KIST

THE MARK CONSISTS OF STANDARD CHARACTERS WITHOUT CLAIM TO ANY PARTICULAR FONT, STYLE, SIZE, OR COLOR.

CLASS 31—NATURAL AGRICULTURAL PRODUCTS

FOR FRESH FRUIT AND VEGETABLES EXCEPT FOR CITRUS FRUIT, BANANAS, MELONS, MANGOS, KIWI, PAPAYAS, GUAVAS AND PINEAPPLES (U.S. CLS. 1 AND 46).

CLASS 43—HOTEL AND RESTAURANT SERVICES

FOR RESTAURANT SERVICES (U.S. CLS. 100 AND 101).
SCOTT BIBB, EXAMINING ATTORNEY

SN 77-147,415. T. TIME CONSULTING, INC., DBA SENIOR LIFESTYLE TRENDS, SHOREVIEW, MN. FILED 4-3-2007.

THE FLICCCCK FACTORS

THE MARK CONSISTS OF STANDARD CHARACTERS WITHOUT CLAIM TO ANY PARTICULAR FONT, STYLE, SIZE, OR COLOR.

CLASS 16—PAPER GOODS AND PRINTED MATTER

FOR PRINTED MATERIALS, NAMELY, EDUCATIONAL MATERIALS AND BOOKLETS FEATURING INFORMATION AND INSTRUCTIONAL MATERIALS IN THE FIELD OF ASSISTING SENIOR CITIZENS AND THOSE WORKING WITH SENIOR CITIZENS IN MAKING DECISIONS ABOUT LIFESTYLE CHANGES AND TRANSITIONS (U.S. CLS. 2, 5, 22, 23, 29, 37, 38 AND 50).

CLASS 41—EDUCATION AND ENTERTAINMENT

FOR EDUCATIONAL SERVICES, NAMELY, PROVIDING SEMINARS AND PROGRAMS TO SENIOR CITIZENS AND THOSE WORKING WITH SENIOR CITIZENS TO HELP MAKE DECISIONS AND OVERCOME OBJECTIONS AND OBSTACLES WHICH MAY BE ASSOCIATED WITH MAKING DECISIONS ABOUT LIFESTYLE CHANGES AND TRANSITIONS (U.S. CLS. 100, 101 AND 107).
MATTHEW EINSTEIN, EXAMINING ATTORNEY

AVALIS

THE MARK CONSISTS OF STANDARD CHARACTERS WITHOUT CLAIM TO ANY PARTICULAR FONT, STYLE, SIZE, OR COLOR.

CLASS 9—ELECTRICAL AND SCIENTIFIC APPARATUS

FOR LUMINOUS SIGNS (U.S. CLS. 21, 23, 26, 36 AND 38).

CLASS 16—PAPER GOODS AND PRINTED MATTER

FOR DIRECTORIES OF DESTINATION AREAS, NAMELY, BUILDINGS, FACILITIES, AND CAMPUSES (U.S. CLS. 2, 5, 22, 23, 29, 37, 38 AND 50).

CLASS 19—NON-METALLIC BUILDING MATERIALS

FOR NON-LUMINOUS, NON-MECHANICAL SIGNS NOT OF METAL (U.S. CLS. 1, 12, 33 AND 50).

CLASS 35—ADVERTISING AND BUSINESS

FOR BUSINESS MANAGEMENT AND BUSINESS CONSULTING SERVICES IN THE FIELD OF NAVIGATION SYSTEMS IN AND ABOUT BUILDINGS, FACILITIES, AND CAMPUSES (U.S. CLS. 100, 101 AND 102).
STEVEN JACKSON, EXAMINING ATTORNEY

SN 77-147,891. U8ONLINE, LLC, BEND, OR. FILED 4-3-2007.

U8online

THE MARK CONSISTS OF STANDARD CHARACTERS WITHOUT CLAIM TO ANY PARTICULAR FONT, STYLE, SIZE, OR COLOR.

CLASS 9—ELECTRICAL AND SCIENTIFIC APPARATUS

FOR COMPUTER SOFTWARE FOR USE IN DATABASE MANAGEMENT IN THE FIELD OF CUSTOMER RELATIONSHIP MANAGEMENT, MARKETING, AND YIELD MANAGEMENT IN THE FOOD SERVICE INDUSTRY (U.S. CLS. 21, 23, 26, 36 AND 38).

CLASS 25—CLOTHING

FOR APPAREL, NAMELY, SHIRTS, SWEATSHIRTS, HATS, T-SHIRTS, POLO SHIRTS, AND CAPS (U.S. CLS. 22 AND 39).

CLASS 35—ADVERTISING AND BUSINESS

FOR ADVERTISING, NAMELY, SERVICES, FOR THE PROMOTION OF GOODS; ADVERTISING SERVICES, NAMELY, PROMOTING THE FOOD AND WINE OF OTHERS; ADVERTISING, MARKETING AND PROMOTION SERVICES; PROVIDING ON-LINE DATABASE MANAGEMENT FOR RESTAURANTS (U.S. CLS. 100, 101 AND 102).

CLASS 42—SCIENTIFIC AND COMPUTER SERVICES

FOR COMPUTER SERVICE, NAMELY, ACTING AS AN APPLICATION SERVICE PROVIDER IN THE FIELD OF KNOWLEDGE MANAGEMENT TO HOST COMPUTER APPLICATION SOFTWARE FOR THE COLLECTION, EDITING, ORGANIZING, MODIFYING, BOOK MARKING, TRANSMISSION, STORAGE AND SHARING OF DATA AND INFORMATION (U.S. CLS. 100 AND 101).

LINDSEY RUBIN, EXAMINING ATTORNEY

CLASS 25—CLOTHING

FOR CLOTHING NAMELY T-SHIRTS, HATS, SWEAT-SHIRTS AND JACKETS (U.S. CLS. 22 AND 39).

CLASS 41—EDUCATION AND ENTERTAINMENT

FOR ENTERTAINMENT SERVICES, NAMELY, PROVIDING PRERECORDED MUSIC AND CONDUCTING CONTESTS ON-LINE VIA A GLOBAL COMPUTER NETWORK (U.S. CLS. 100, 101 AND 107).

TAMARA FRAZIER, EXAMINING ATTORNEY

SN 77-148,060. LINDVALL, PAUL, ROCKFORD, IL. FILED 4-4-2007.

SN 77-149,264. AMIE STREET, INC., OAKLAND, CA. FILED 4-5-2007.

HMIPFY?

THE MARK CONSISTS OF STANDARD CHARACTERS WITHOUT CLAIM TO ANY PARTICULAR FONT, STYLE, SIZE, OR COLOR.

CLASS 14—JEWELRY

FOR JEWELRY (U.S. CLS. 2, 27, 28 AND 50).

CLASS 25—CLOTHING

FOR CLOTHING, NAMELY, SHIRTS AND TIES (U.S. CLS. 22 AND 39).

JESSICA FATHY, EXAMINING ATTORNEY



SN 77-148,385. LAND IN THE BAND LLC, WESTON, FL. FILED 4-4-2007.

LAND IN THE BAND

THE MARK CONSISTS OF STANDARD CHARACTERS WITHOUT CLAIM TO ANY PARTICULAR FONT, STYLE, SIZE, OR COLOR.

CLASS 9—ELECTRICAL AND SCIENTIFIC APPARATUS

FOR PRE-RECORDED AUDIO CASSETTES AND COMPACT DISKS FEATURING MUSIC AND INSTRUMENTAL TRACKS; DOWNLOADABLE MUSICAL SOUND RECORDINGS FEATURING MUSIC AND INSTRUMENTAL TRACKS (U.S. CLS. 21, 23, 26, 36 AND 38).

THE COLOR(S) BLUE AND WHITE IS/ARE CLAIMED AS A FEATURE OF THE MARK.

THE MARK CONSISTS OF A LIGHT BLUE RECTANGLE-SHAPED STREET SIGN WITH THE WORDS 'AMIE ST' DEPICTED IN WHITE LETTERS. THE LETTER 'M' CONSISTS OF A DOWNWARD-POINTING ARROW AND THE LETTER 'I' CONSISTS OF AN UPWARD-POINTING ARROW. THE WORDS ARE CONTAINED IN A WHITE RECTANGULAR BORDER WITHIN THE BLUE BACKGROUND.

THE FOREIGN WORDING IN THE MARK TRANSLATES INTO ENGLISH AS FRIEND.

CLASS 9—ELECTRICAL AND SCIENTIFIC APPARATUS

FOR DOWNLOADABLE MUSIC VIA THE INTERNET AND WIRELESS DEVICES (U.S. CLS. 21, 23, 26, 36 AND 38).

FIRST USE 2-15-2006; IN COMMERCE 7-4-2006.

CLASS 35—ADVERTISING AND BUSINESS

FOR ON-LINE RETAIL STORE SERVICES FEATURING DOWNLOADABLE PRE-RECORDED MUSIC AND VIDEO (U.S. CLS. 100, 101 AND 102).

FIRST USE 2-15-2006; IN COMMERCE 7-4-2006.
ODESSA BIBBINS, EXAMINING ATTORNEY

SN 77-149,795. THE PACIFIC COASTAL COMPANY LLC,
HUNTINGTON BEACH, CA. FILED 4-5-2007.



OWNER OF U.S. REG. NOS. 3,201,969 AND 3,208,304.
NO CLAIM IS MADE TO THE EXCLUSIVE RIGHT TO
USE "COMPANY", APART FROM THE MARK AS SHOWN.
THE MARK CONSISTS OF A RISING SUN ABOVE THE
WORDS THE PACIFIC COASTAL COMPANY APARTMENT
COMMUNITIES.

**CLASS 16—PAPER GOODS AND PRINTED
MATTER**

FOR PAPER BAGS (U.S. CLS. 2, 5, 22, 23, 29, 37, 38
AND 50).

CLASS 24—FABRICS

FOR TOWELS (U.S. CLS. 42 AND 50).

CLASS 25—CLOTHING

FOR CLOTHING, NAMELY, DRESS SHIRTS, SWEAT-
SHIRTS, T-SHIRTS, AND BATH ROBES; AND ACTIVE
WEAR, NAMELY, JACKETS, COATS, SWEATERS,
SHIRTS, SWEATSHIRTS, SWEATSHORTS, SWEAT-
SUITS, BLOUSES, SKIRTS, SHORTS, PANTS, TOPS,
AND BOTTOMS; FOOTWEAR, NAMELY, SLIPPERS
(U.S. CLS. 22 AND 39).

DAWN FELDMAN, EXAMINING ATTORNEY

SN 77-149,946. TRIPLE DIAMOND ENTERPRISES, LLC,
NORTH VENICE, FL. FILED 4-5-2007.



NO CLAIM IS MADE TO THE EXCLUSIVE RIGHT TO
USE "PLASTICS", APART FROM THE MARK AS SHOWN.

**CLASS 20—FURNITURE AND ARTICLES NOT
OTHERWISE CLASSIFIED**

FOR INJECTION MOLDED DISTRIBUTION PACKA-
GING MATERIALS, NAMELY, PALLETS AND BINS
(U.S. CLS. 2, 13, 22, 25, 32 AND 50).

CLASS 40—MATERIAL TREATMENT

FOR MANUFACTURE OF ARTICLES OF PLASTIC TO
THE ORDER AND SPECIFICATIONS OF OTHERS (U.S.
CLS. 100, 103 AND 106).

JOHN GARTNER, EXAMINING ATTORNEY

SN 77-150,469. TOPCODER, INC., GLASTONBURY, CT.
FILED 4-6-2007.



THE MARK CONSISTS OF A RECTANGULAR SHAPE
APPROXIMATING A VIDEO DISPLAY.

CLASS 25—CLOTHING

FOR CLOTHING, NAMELY, SHIRTS, CAPS, AND
JACKETS (U.S. CLS. 22 AND 39).

**CLASS 41—EDUCATION AND ENTERTAIN-
MENT**

FOR ENTERTAINMENT SERVICES, NAMELY PRO-
VIDING A WEBSITE FEATURING VIDEO PRESENTA-
TIONS CONCERNING COMPUTER SOFTWARE
DEVELOPMENT, THE COMPUTER INDUSTRY, AND
GAMES AND COMPETITIONS (U.S. CLS. 100, 101 AND
107).

ROBERT STRUCK, EXAMINING ATTORNEY

SN 77-150,472. TOPCODER, INC., GLASTONBURY, CT.
FILED 4-6-2007.



NO CLAIM IS MADE TO THE EXCLUSIVE RIGHT TO
USE "CHANNEL", APART FROM THE MARK AS SHOWN.
THE MARK CONSISTS OF THE WORDS "TC CHANNEL"
SURROUNDED BY A RECTANGULAR SHAPE APPROX-
IMATING A VIDEO DISPLAY.

CLASS 25—CLOTHING

FOR CLOTHING, NAMELY, SHIRTS, CAPS, AND JACKETS (U.S. CLS. 22 AND 39).

CLASS 41—EDUCATION AND ENTERTAINMENT

FOR ENTERTAINMENT SERVICES, NAMELY, PROVIDING A WEBSITE FEATURING VIDEO PRESENTATIONS CONCERNING COMPUTER SOFTWARE DEVELOPMENT, THE COMPUTER INDUSTRY, AND GAMES AND COMPETITIONS (U.S. CLS. 100, 101 AND 107).

ROBERT STRUCK, EXAMINING ATTORNEY

SN 77-150,476. TOPCODER, INC., GLASTONBURY, CT. FILED 4-6-2007.

TC CHANNEL

THE MARK CONSISTS OF STANDARD CHARACTERS WITHOUT CLAIM TO ANY PARTICULAR FONT, STYLE, SIZE, OR COLOR.

NO CLAIM IS MADE TO THE EXCLUSIVE RIGHT TO USE "CHANNEL", APART FROM THE MARK AS SHOWN.

CLASS 25—CLOTHING

FOR CLOTHING, NAMELY, SHIRTS, CAPS, AND JACKETS (U.S. CLS. 22 AND 39).

CLASS 41—EDUCATION AND ENTERTAINMENT

FOR ENTERTAINMENT SERVICES, NAMELY, PROVIDING A WEBSITE FEATURING VIDEO PRESENTATIONS CONCERNING COMPUTER SOFTWARE DEVELOPMENT, THE COMPUTER INDUSTRY, AND GAMES AND COMPETITIONS (U.S. CLS. 100, 101 AND 107).

ROBERT STRUCK, EXAMINING ATTORNEY

SN 77-150,731. CLOSET PERFECT LLC, EVANSTON, IL. FILED 4-6-2007.

Closet Perfect

THE MARK CONSISTS OF STANDARD CHARACTERS WITHOUT CLAIM TO ANY PARTICULAR FONT, STYLE, SIZE, OR COLOR.

CLASS 6—METAL GOODS

FOR DECORATIVE COVERS, NAMELY, COVERS USED FOR COVERING METAL SHELF BRACKETS (U.S. CLS. 2, 12, 13, 14, 23, 25 AND 50).

FIRST USE 7-26-2005; IN COMMERCE 12-29-2006.

CLASS 9—ELECTRICAL AND SCIENTIFIC APPARATUS

FOR DECORATIVE MAGNETS; MAGNETS; MAGNETS FOR COVERING SHELVING HARDWARE (U.S. CLS. 21, 23, 26, 36 AND 38).

FIRST USE 7-26-2005; IN COMMERCE 12-29-2006.

JANICE KIM, EXAMINING ATTORNEY

SN 77-150,889. ACIST MEDICAL SYSTEMS, INC., EDEN PRAIRIE, MN. FILED 4-6-2007.



THE MARK CONSISTS OF THE WORD ACIST PRECEDED BY A LEAF DESIGN.

CLASS 9—ELECTRICAL AND SCIENTIFIC APPARATUS

FOR COMPUTER SOFTWARE FOR MANAGING THE ADMINISTRATION OF CONTRAST AGENTS FOR USE IN MEDICAL RADIOLOGICAL IMAGING (U.S. CLS. 21, 23, 26, 36 AND 38).

FIRST USE 7-0-2004; IN COMMERCE 7-0-2004.

CLASS 10—MEDICAL APPARATUS

FOR CONTRAST DELIVERY SYSTEM FOR USE IN MEDICAL RADIOLOGICAL IMAGING (U.S. CLS. 26, 39 AND 44).

FIRST USE 7-0-2004; IN COMMERCE 7-0-2004.

ERIN FALK, EXAMINING ATTORNEY

SN 77-150,980. MEDICAL TRANSCRIPTION BILLING, CORP., SOMERSET, NJ. FILED 4-6-2007.

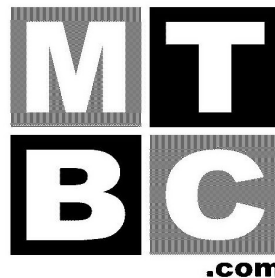

NO CLAIM IS MADE TO THE EXCLUSIVE RIGHT TO USE ".COM", APART FROM THE MARK AS SHOWN.
"THE MARK CONSISTS OF MTBC IN STYLIZED FORM."

CLASS 35—ADVERTISING AND BUSINESS

FOR BILLING; COMPUTERISED OFFICE MANAGEMENT; DATA PROCESSING SERVICES; MEDICAL TRANSCRIPTION SERVICES; BOOKKEEPING FOR ELECTRONIC FUNDS TRANSFER; BUSINESS INVOICING SERVICES; INVOICING SERVICES; INVOICING SERVICES IN THE FIELD OF MEDICINE (U.S. CLS. 100, 101 AND 102).

FIRST USE 11-1-2005; IN COMMERCE 11-1-2005.

CLASS 36—INSURANCE AND FINANCIAL

FOR ELECTRONIC PROCESSING OF INSURANCE CLAIMS AND PAYMENT DATA; INSURANCE CLAIMS PROCESSING; INSURANCE CONSULTATION (U.S. CLS. 100, 101 AND 102).

FIRST USE 11-1-2005; IN COMMERCE 11-1-2005.
DANNEAN HETZEL, EXAMINING ATTORNEY

CLASS 35—ADVERTISING AND BUSINESS

FOR PROVIDING AN ON-LINE SHOWROOM FOR THE GOODS OF OTHERS IN THE FIELD OF FINE ART, GRAPHIC DESIGN, SCULPTURE AND OTHER MERCHANDISE FEATURING LICENSED CREATIVE WORKS; PROVIDING INFORMATION IN THE FIELD OF MARKETING AND ON-LINE MARKETING MEDIA VIA THE INTERNET; COMMERCIAL ADMINISTRATION OF THE LICENSING OF THE GOODS AND SERVICES OF OTHERS (U.S. CLS. 100, 101 AND 102).

SN 77-150,992. WALTER SMITH, NEW CANAAN, CT. FILED 4-6-2007.

FUTURE BEAUTY

THE MARK CONSISTS OF STANDARD CHARACTERS WITHOUT CLAIM TO ANY PARTICULAR FONT, STYLE, SIZE, OR COLOR.

NO CLAIM IS MADE TO THE EXCLUSIVE RIGHT TO USE "BEAUTY", APART FROM THE MARK AS SHOWN.

CLASS 3—COSMETICS AND CLEANING PREPARATIONS

FOR NON-MEDICATED SKINCARE PREPARATIONS (U.S. CLS. 1, 4, 6, 50, 51 AND 52).

CLASS 5—PHARMACEUTICALS

FOR NUTRITIONAL SUPPLEMENTS (U.S. CLS. 6, 18, 44, 46, 51 AND 52).

CLASS 16—PAPER GOODS AND PRINTED MATTER

FOR PRINTED PUBLICATIONS, NAMELY, NEWSLETTERS IN THE FIELDS OF HEALTH, NUTRITION AND BEAUTY (U.S. CLS. 2, 5, 22, 23, 29, 37, 38 AND 50).

CLASS 42—SCIENTIFIC AND COMPUTER SERVICES

FOR TESTING FOR NEW PRODUCT DEVELOPMENT; PRODUCT SAFETY AND EFFICACY TESTING AND CONSULTATION (U.S. CLS. 100 AND 101).

GIANCARLO CASTRO, EXAMINING ATTORNEY

SN 77-151,026. LUSORY.COM, INC., ROCKVILLE, MD. FILED 4-6-2007.

LUSORY

THE MARK CONSISTS OF STANDARD CHARACTERS WITHOUT CLAIM TO ANY PARTICULAR FONT, STYLE, SIZE, OR COLOR.

CLASS 41—EDUCATION AND ENTERTAINMENT

FOR EDUCATION SERVICES, NAMELY, PROVIDING WORKSHOPS AND TUTORIALS IN THE FIELD OF FINE ART, EXPERIMENTAL ART, THE CREATIVE PROCESS AND PLAY; CUSTOM WRITING SERVICES; ON-LINE PUBLICATION OF MAGAZINES IN THE FIELDS OF CULTURAL NEWS, ART NEWS, FEATURES AND OPINIONS (U.S. CLS. 100, 101 AND 107).

CLASS 42—SCIENTIFIC AND COMPUTER SERVICES

FOR COMPUTER SERVICES, NAMELY, CREATING AN ONLINE COMMUNITY FOR REGISTERED USERS TO PARTICIPATE IN COMPETITIONS, SHOWCASE THEIR SKILLS, GET FEEDBACK FROM THEIR PEERS, FORM VIRTUAL COMMUNITIES, ENGAGE IN SOCIAL NETWORKING AND IMPROVE THEIR TALENT (U.S. CLS. 100 AND 101).

VIVIAN MICZNIK FIRST, EXAMINING ATTORNEY

SN 77-151,042. LIFE COMMUNICATIONS, INC., HENDERSON, NV. FILED 4-6-2007.

LIFE COMMUNICATIONS

THE MARK CONSISTS OF STANDARD CHARACTERS WITHOUT CLAIM TO ANY PARTICULAR FONT, STYLE, SIZE, OR COLOR.

NO CLAIM IS MADE TO THE EXCLUSIVE RIGHT TO USE "COMMUNICATIONS", APART FROM THE MARK AS SHOWN.

CLASS 9—ELECTRICAL AND SCIENTIFIC APPARATUS

FOR DIGITAL MATERIALS, NAMELY, CDS, DVDS, AND DOWNLOADABLE AUDIO FILES FEATURING INFORMATION RELATED TO PERSONAL DEVELOPMENT, SELF HELP, AND BUSINESS DEVELOPMENT (U.S. CLS. 21, 23, 26, 36 AND 38).

CLASS 41—EDUCATION AND ENTERTAINMENT

FOR EDUCATION SERVICES, NAMELY, PROVIDING WORKSHOPS AND SEMINARS IN THE FIELD OF PERSONAL DEVELOPMENT, SELF HELP, AND BUSINESS DEVELOPMENT;; ENTERTAINMENT SERVICES, NAMELY, PERSONAL APPEARANCES BY A MOTIVATIONAL SPEAKER (U.S. CLS. 100, 101 AND 107).

LAURA KOVALSKY, EXAMINING ATTORNEY

SN 77-151,133. ALLAC ENTERPRISES, LLC, TOLEDO, OH.
FILED 4-6-2007.

SN 77-151,258. BEILIS ORIT, DANIA BEACH, FL. AND
BEILIS ALON, DANIA BEACH, FL. FILED 4-7-2007.

easy countertops

THE MARK CONSISTS OF STANDARD CHARACTERS WITHOUT CLAIM TO ANY PARTICULAR FONT, STYLE, SIZE, OR COLOR.

NO CLAIM IS MADE TO THE EXCLUSIVE RIGHT TO USE "COUNTERTOPS", APART FROM THE MARK AS SHOWN.

CLASS 37—CONSTRUCTION AND REPAIR

FOR INSTALLATION OF CUSTOM COUNTERTOPS (U.S. CLS. 100, 103 AND 106).
FIRST USE 8-15-2006; IN COMMERCE 1-3-2007.

CLASS 40—MATERIAL TREATMENT

FOR CUSTOM MANUFACTURE OF COUNTERTOPS (U.S. CLS. 100, 103 AND 106).
FIRST USE 8-15-2006; IN COMMERCE 1-3-2007.
DAVID HOFFMAN, EXAMINING ATTORNEY

RELAXTIVITY

THE MARK CONSISTS OF STANDARD CHARACTERS WITHOUT CLAIM TO ANY PARTICULAR FONT, STYLE, SIZE, OR COLOR.

CLASS 41—EDUCATION AND ENTERTAINMENT

FOR CHILDREN'S ENTERTAINMENT AND AMUSEMENT CENTERS, NAMELY, INTERACTIVE PLAY AREAS (U.S. CLS. 100, 101 AND 107).

CLASS 44—MEDICAL, BEAUTY AND AGRICULTURAL SERVICES

FOR HEALTH SPA SERVICES FOR HEALTH AND WELLNESS OF THE MIND, BODY AND SPIRIT OFFERED IN OR FROM A REMOTE, MOBILE OR TEMPORARY ON-SITE LOCATION (U.S. CLS. 100 AND 101).
JESSICA FATHY, EXAMINING ATTORNEY

SN 77-151,147. FOOD DISTRIBUTION ALLIANCE INC., ELK GROVE VILLAGE, IL. FILED 4-6-2007.

SN 77-151,584. VITA PROSPERA ENTERPRISES, LLC, AVON, CO. FILED 4-9-2007.

VITALLA

THE MARK CONSISTS OF STANDARD CHARACTERS WITHOUT CLAIM TO ANY PARTICULAR FONT, STYLE, SIZE, OR COLOR.

CLASS 29—MEATS AND PROCESSED FOODS

FOR JAMS; FRUIT PRESERVES; FRUITS, NAMELY, PRESERVED STRAWBERRY, RASPBERRY, BLUEBERRY, APRICOT, ORANGE, PLUM, CHERRY, POMEGRANATE AND APPLE; VEGETABLES, NAMELY, PRESERVED VEGETABLES; PRESERVED FRUITS (U.S. CL. 46).

CLASS 32—LIGHT BEVERAGES

FOR FRUIT JUICE CONCENTRATES; FRUIT JUICES; FRUIT JUICES, NAMELY, POMAGRANATE JUICE; NON-ALCOHOLIC BEVERAGES CONTAINING FRUIT JUICES; NON-ALCOHOLIC FRUIT JUICE BEVERAGES (U.S. CLS. 45, 46 AND 48).
PRISCILLA MILTON, EXAMINING ATTORNEY

VITA PROSPERA

THE MARK CONSISTS OF STANDARD CHARACTERS WITHOUT CLAIM TO ANY PARTICULAR FONT, STYLE, SIZE, OR COLOR.

THE ENGLISH TRANSLATION OF VITA PROSPERA IS "THRIVING LIFE."

CLASS 41—EDUCATION AND ENTERTAINMENT

FOR PROVIDING FITNESS AND EXERCISE FACILITIES (U.S. CLS. 100, 101 AND 107).

CLASS 43—HOTEL AND RESTAURANT SERVICES

FOR HEALTH RESORT SERVICES, NAMELY, PROVIDING FOOD AND LODGING THAT SPECIALIZE IN PROMOTING A PATRON'S GENERAL HEALTH AND WELLBEING (U.S. CLS. 100 AND 101).
MELVIN AXILBUND, EXAMINING ATTORNEY

SN 77-151,828. COGNITECH, INC., PASADENA, CA. FILED 4-9-2007.

3D RAMA

THE MARK CONSISTS OF STANDARD CHARACTERS WITHOUT CLAIM TO ANY PARTICULAR FONT, STYLE, SIZE, OR COLOR.

NO CLAIM IS MADE TO THE EXCLUSIVE RIGHT TO USE "3D", APART FROM THE MARK AS SHOWN.

CLASS 9—ELECTRICAL AND SCIENTIFIC APPARATUS

FOR COMPUTER HARDWARE AND COMPUTER SOFTWARE FOR THREE DIMENSIONAL DESIGN, VIRTUAL COMPUTER-ASSISTED TOURING, AND VIRTUAL COMPUTER-ASSISTED TOURING VIA THE INTERNET, OF THREE DIMENSIONAL PHOTO AND VIDEO REALISTIC MODELS CONSTRUCTED FROM ACTUAL PHOTOGRAPHS AND VIDEOS OF BUILDINGS, HOUSES AND OTHER ARCHITECTURAL AND OTHER MAN-MADE AND NATURAL STRUCTURES (U.S. CLS. 21, 23, 26, 36 AND 38).

CLASS 42—SCIENTIFIC AND COMPUTER SERVICES

FOR CONSULTING SERVICES IN THE FIELD OF DATA CONVERSION, NAMELY, CONVERTING PHOTOGRAPHIC IMAGES AND VIDEOS OF BUILDINGS, HOUSES AND OTHER ARCHITECTURAL AND OTHER MAN-MADE AND NATURAL STRUCTURES INTO DIGITAL 3D MODELS FOR PURPOSES OF PROVIDING VIRTUAL COMPUTER-ASSISTED VISUALIZATION, AND TOURING OF SUCH MODELS OVER THE INTERNET (U.S. CLS. 100 AND 101).

AMEETA JORDAN, EXAMINING ATTORNEY

CLASS 9—ELECTRICAL AND SCIENTIFIC APPARATUS

FOR COMPUTER HARDWARE AND COMPUTER SOFTWARE FOR VIDEO IMAGE PROCESSING AND ANALYSIS, NAMELY, FOR IMAGE PATTERN RECOGNITION, FOR IMAGE DATABASE MANAGEMENT, FOR MULTIPLE IMAGE AND VIDEO REGISTRATION, FOR MOTION ESTIMATION, FOR MULTI-DIMENSIONAL IMAGE RECONSTRUCTION, AND FOR VIDEO IMAGE ENHANCEMENT THROUGH THE PHOTO-REALISTIC PRINTING, CLARIFICATION AND ENLARGEMENT OF VIDEO IMAGES FOR USE IN THE FIELD OF INVESTIGATIVE IMAGE PROCESSING, EACH FOR USE WITH ALL RADIATION TYPES, NAMELY, OPTICAL, ELECTROMAGNETIC, INFRARED, ACOUSTIC SONAR AND ULTRASOUND, AND EACH FOR USE IN THE FIELDS OF FORENSICS, CARTOGRAPHY AND PHOTOGRAMMETRY (U.S. CLS. 21, 23, 26, 36 AND 38).

CLASS 42—SCIENTIFIC AND COMPUTER SERVICES

FOR TECHNICAL CONSULTING SERVICES IN THE FIELDS OF FORENSIC DIGITAL IMAGE ANALYSIS AND FORENSIC VIDEO ANALYSIS AND INVESTIGATIVE DIGITAL AND VIDEO IMAGE PROCESSING; IMAGE PROCESSING, NAMELY, DATA CONVERSION OF COMPUTER PROGRAM IMAGE DATA OR INFORMATION (U.S. CLS. 100 AND 101).

AMEETA JORDAN, EXAMINING ATTORNEY

SN 77-151,986. DALSA INC., WATERLOO, CANADA, FILED 4-9-2007.

FLASHMAG

SN 77-151,916. COGNITECH, INC., PASADENA, CA. FILED 4-9-2007.

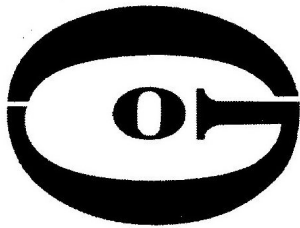

THE MARK CONSISTS OF THE LETTER G , WITH THE LETTER O IN THE CENTER.

THE MARK CONSISTS OF STANDARD CHARACTERS WITHOUT CLAIM TO ANY PARTICULAR FONT, STYLE, SIZE, OR COLOR.

PRIORITY CLAIMED UNDER SEC. 44(D) ON CANADA APPLICATION NO. 1,341,075, FILED 3-27-2007.

CLASS 9—ELECTRICAL AND SCIENTIFIC APPARATUS

FOR DIGITAL CINEMATOGRAPHY CAMERAS (U.S. CLS. 21, 23, 26, 36 AND 38).

CLASS 41—EDUCATION AND ENTERTAINMENT

FOR RENTAL OF DIGITAL CINEMATOGRAPHY CAMERAS (U.S. CLS. 100, 101 AND 107).

MARTHA SANTOMARTINO, EXAMINING ATTORNEY

SN 77-152,063. MARK ANTHONY INTERNATIONAL SRL, ROCKLEY, CHRIST CHURCH, BARBADOS, FILED 4-9-2007.

SN 77-152,102. MARK ANTHONY INTERNATIONAL SRL, ROCKLEY, CHRIST CHURCH, BARBADOS, FILED 4-9-2007.



OWNER OF U.S. REG. NOS. 2,501,401, 3,130,572 AND OTHERS.

NO CLAIM IS MADE TO THE EXCLUSIVE RIGHT TO USE "LIGHT HARD TEA" AND "LEMON", APART FROM THE MARK AS SHOWN.

THE STIPPLING IS A FEATURE OF THE MARK AND DOES NOT INDICATE COLOR.

THE MARK CONSISTS OF THE WORDS "MIKE'S LIGHT HARD TEA WITH A LEMON KICK" IN A STYLIZED FONT. THE WORD "MIKE'S" IS SHOWN WITHIN THE STYLIZED DRAWING OF A LEMON, THE WORDS "LIGHT HARD" AND "WITH A LEMON KICK" ARE IN WHITE ON A BLACK RECTANGLE BACKGROUND, AND BELOW THE ENTIRE MARK IS A STYLIZED DRAWING OF A LEMON SLICE WITH A LEAF.

CLASS 18—LEATHER GOODS

FOR BAGS, NAMELY, ALL-PURPOSE CARRYING BAGS, DUFFLE BAGS, GYM BAGS, BRIEFCASES, BEACH BAGS, FANNY PACKS AND BACK PACKS (U.S. CLS. 1, 2, 3, 22 AND 41).

CLASS 25—CLOTHING

FOR CLOTHING, NAMELY, SHIRTS, BLOUSES, T-SHIRTS, JACKETS, WINDSHIRTS, VESTS, SWEATERS, SWEATSHIRTS, HATS, CAPS (U.S. CLS. 22 AND 39).

CLASS 32—LIGHT BEVERAGES

FOR FLAVORED BREWED MALT-BASED ALCOHOLIC BEVERAGES IN THE NATURE OF BEER (U.S. CLS. 45, 46 AND 48).

CLASS 33—WINES AND SPIRITS

FOR ALCOHOLIC FLAVORED MALT COOLERS (U.S. CLS. 47 AND 49).
CARYN GLASSER, EXAMINING ATTORNEY

OWNER OF U.S. REG. NOS. 2,501,401, 3,125,866 AND OTHERS.

NO CLAIM IS MADE TO THE EXCLUSIVE RIGHT TO USE "HARD TEA" AND "LEMON" WITH RESPECT TO CLASSES 032 AND 033, APART FROM THE MARK AS SHOWN.

THE STIPPLING IS A FEATURE OF THE MARK AND DOES NOT INDICATE COLOR.

THE MARK CONSISTS OF THE WORDS "MIKE'S HARD TEA WITH A LEMON KICK" IN A STYLIZED FONT. THE WORD "MIKE'S" IS SHOWN WITHIN THE STYLIZED DRAWING OF A LEMON, THE WORDS "HARD" AND "WITH A LEMON KICK" ARE IN WHITE ON A BLACK RECTANGLE BACKGROUND, AND BELOW THE ENTIRE MARK IS A STYLIZED DRAWING OF A LEMON SLICE WITH A LEAF.

CLASS 18—LEATHER GOODS

FOR BAGS, NAMELY ALL-PURPOSE CARRYING BAGS, DUFFLE BAGS, GYM BAGS, BRIEFCASES, BEACH BAGS, FANNY PACKS AND BACK PACKS (U.S. CLS. 1, 2, 3, 22 AND 41).

CLASS 25—CLOTHING

FOR CLOTHING, NAMELY, SHIRTS, BLOUSES, T-SHIRTS, JACKETS, WINDSHIRTS, VESTS, SWEATERS, SWEATSHIRTS, HATS, CAPS (U.S. CLS. 22 AND 39).

CLASS 32—LIGHT BEVERAGES

FOR FLAVORED BREWED MALT-BASED ALCOHOLIC BEVERAGES IN THE NATURE OF BEER (U.S. CLS. 45, 46 AND 48).

CLASS 33—WINES AND SPIRITS

FOR ALCOHOLIC FLAVORED MALT COOLERS (U.S. CLS. 47 AND 49).
CARYN GLASSER, EXAMINING ATTORNEY

SN 77-152,284. IRIS INTERNATIONAL, INC., CHATSWORTH, CA. FILED 4-9-2007.

SN 77-152,519. EPAM SYSTEMS, INC., LAWRENCEVILLE, NJ. FILED 4-10-2007.

3GEMS

THE MARK CONSISTS OF STANDARD CHARACTERS WITHOUT CLAIM TO ANY PARTICULAR FONT, STYLE, SIZE, OR COLOR.

CLASS 10—MEDICAL APPARATUS

FOR MEDICAL DIAGNOSTIC ANALYZER FOR ANALYZING HUMAN SAMPLES SUCH AS URINE, BLOOD AND BODY FLUIDS (U.S. CLS. 26, 39 AND 44).

CLASS 44—MEDICAL, BEAUTY AND AGRICULTURAL SERVICES

FOR MEDICAL TESTING SERVICES, NAMELY, ANALYZING HUMAN SAMPLES, SUCH AS URINE, BLOOD AND BODY FLUIDS (U.S. CLS. 100 AND 101).
JOHN E. MICHOS, EXAMINING ATTORNEY

SN 77-152,335. COBLENTZ, RACHEL K, SAN CLEMENTE, CA. FILED 4-9-2007.



Cinema Solutions

Home Theater & Automation

NO CLAIM IS MADE TO THE EXCLUSIVE RIGHT TO USE CINEMA AND HOME THEATER & AUTOMATION, APART FROM THE MARK AS SHOWN.

THE MARK CONSISTS OF A SHIELD WITH A LAUREL WREATH AROUND IT, A STYLIZED C AND S INSIDE OF THE SHIELD. A STYLIZED CINEMA SOLUTIONS. A FADED LINE UNDERNEATH THE STYLIZED CINEMA SOLUTIONS

CLASS 37—CONSTRUCTION AND REPAIR

FOR INSTALLATION OF HOME THEATRES AND RELATED STRUCTURED WIRING (U.S. CLS. 100, 103 AND 106).

FIRST USE 3-1-2007; IN COMMERCE 3-1-2007.

CLASS 42—SCIENTIFIC AND COMPUTER SERVICES

FOR NETWORKING OF HOME CONTROLS, NAMELY, WIRELESS AND WIRED LIGHTING CONTROLS, THERMOSTAT AND HEATING CONTROLS, ROLLING SHUTTERS AND DOOR CONTROLS, APPLIANCE CONTROLS, NAMELY, OVEN, WASHER, DRYER, REFRIGERATOR, DISHWASHER, LAWN AND GARDEN IRRIGATION CONTROLS, HOME AUDIO AND VIDEO CONTROLS (U.S. CLS. 100 AND 101).

FIRST USE 3-1-2007; IN COMMERCE 3-1-2007.
SALLY SHIH, EXAMINING ATTORNEY

EPAM SYSTEMS

THE MARK CONSISTS OF STANDARD CHARACTERS WITHOUT CLAIM TO ANY PARTICULAR FONT, STYLE, SIZE, OR COLOR.

NO CLAIM IS MADE TO THE EXCLUSIVE RIGHT TO USE SYSTEMS, APART FROM THE MARK AS SHOWN.

CLASS 9—ELECTRICAL AND SCIENTIFIC APPARATUS

FOR COMPUTER SOFTWARE FOR USE IN THE AUTOMATION OF BUSINESS PROCESSES, APPLICATION AND DATABASE INTEGRATION (U.S. CLS. 21, 23, 26, 36 AND 38).

FIRST USE 12-23-1993; IN COMMERCE 12-23-1993.

CLASS 35—ADVERTISING AND BUSINESS

FOR OUTSOURCING SERVICES IN THE FIELD OF COMPUTER SOFTWARE DEVELOPMENT (U.S. CLS. 100, 101 AND 102).

FIRST USE 12-23-1993; IN COMMERCE 12-23-1993.

CLASS 42—SCIENTIFIC AND COMPUTER SERVICES

FOR COMPUTER SOFTWARE DEVELOPMENT SERVICES FOR OTHERS; CONSULTING SERVICES NAMELY IN THE FIELDS OF INFORMATION TECHNOLOGY AND COMPUTER SOFTWARE INTEGRATION (U.S. CLS. 100 AND 101).

FIRST USE 12-23-1993; IN COMMERCE 12-23-1993.
DAVID H. STINE, EXAMINING ATTORNEY

SN 77-152,523. EPAM SYSTEMS, INC., LAWRENCEVILLE, NJ. FILED 4-10-2007.

EPAM

THE MARK CONSISTS OF STANDARD CHARACTERS WITHOUT CLAIM TO ANY PARTICULAR FONT, STYLE, SIZE, OR COLOR.

CLASS 9—ELECTRICAL AND SCIENTIFIC APPARATUS

FOR COMPUTER SOFTWARE FOR USE IN THE AUTOMATION OF BUSINESS PROCESSES, APPLICATION AND DATABASE INTEGRATION (U.S. CLS. 21, 23, 26, 36 AND 38).

FIRST USE 12-23-1993; IN COMMERCE 12-23-1993.

CLASS 35—ADVERTISING AND BUSINESS

FOR OUTSOURCING SERVICES IN THE FIELD OF COMPUTER SOFTWARE DEVELOPMENT (U.S. CLS. 100, 101 AND 102).

FIRST USE 12-23-1993; IN COMMERCE 12-23-1993.

CLASS 42—SCIENTIFIC AND COMPUTER SERVICES

FOR COMPUTER SOFTWARE DEVELOPMENT SERVICES FOR OTHERS; CONSULTING SERVICES IN THE FIELDS OF INFORMATION TECHNOLOGY AND COMPUTER SOFTWARE INTEGRATION (U.S. CLS. 100 AND 101).

FIRST USE 12-23-1993; IN COMMERCE 12-23-1993.
DAVID H. STINE, EXAMINING ATTORNEY

CLASS 39—TRANSPORTATION AND STORAGE

FOR PROVIDING AN ON-LINE COMPUTER DATABASE IN THE FIELD OF TRAVEL INFORMATION SERVICES; TRAVEL AGENCY SERVICES, NAMELY, MAKING RESERVATIONS AND BOOKINGS FOR TRANSPORTATION FOR OTHERS; TRAVEL AND TOUR TICKET RESERVATION SERVICES (U.S. CLS. 100 AND 105).

FIRST USE 5-18-2004; IN COMMERCE 5-18-2004.

SN 77-152,626. ONETRAVEL GROUP, INC., ATLANTA, GA.
FILED 4-10-2007.

CLASS 43—HOTEL AND RESTAURANT SERVICES

FOR MAKING RESERVATIONS AND BOOKINGS FOR TEMPORARY LODGING ON AN INTERACTIVE WEB SITE; TRAVEL AGENCY SERVICES, NAMELY, MAKING RESERVATIONS AND BOOKINGS FOR TEMPORARY LODGING (U.S. CLS. 100 AND 101).

FIRST USE 5-18-2004; IN COMMERCE 5-18-2004.
BENJAMIN ALLEN, EXAMINING ATTORNEY

TRAVEL ALL IN ONE

THE MARK CONSISTS OF STANDARD CHARACTERS WITHOUT CLAIM TO ANY PARTICULAR FONT, STYLE, SIZE, OR COLOR.

NO CLAIM IS MADE TO THE EXCLUSIVE RIGHT TO USE "TRAVEL", APART FROM THE MARK AS SHOWN.

CLASS 39—TRANSPORTATION AND STORAGE

FOR PROVIDING AN ON-LINE COMPUTER DATABASE IN THE FIELD OF TRAVEL INFORMATION SERVICES; TRAVEL AGENCY SERVICES, NAMELY, MAKING RESERVATIONS AND BOOKINGS FOR TRANSPORTATION FOR OTHERS; TRAVEL AND TOUR TICKET RESERVATION SERVICES (U.S. CLS. 100 AND 105).

FIRST USE 10-18-2000; IN COMMERCE 10-18-2000.

CLASS 43—HOTEL AND RESTAURANT SERVICES

FOR MAKING RESERVATIONS AND BOOKINGS FOR TEMPORARY LODGING ON AN INTERACTIVE WEB SITE; TRAVEL AGENCY SERVICES, NAMELY, MAKING RESERVATIONS AND BOOKINGS FOR TEMPORARY LODGING (U.S. CLS. 100 AND 101).

FIRST USE 10-18-2000; IN COMMERCE 10-18-2000.
BENJAMIN ALLEN, EXAMINING ATTORNEY

SN 77-152,630. ONETRAVEL GROUP, INC., ATLANTA, GA.
FILED 4-10-2007.

TRAVEL PRICED TO GO

THE MARK CONSISTS OF STANDARD CHARACTERS WITHOUT CLAIM TO ANY PARTICULAR FONT, STYLE, SIZE, OR COLOR.

NO CLAIM IS MADE TO THE EXCLUSIVE RIGHT TO USE "TRAVEL", APART FROM THE MARK AS SHOWN.

SN 77-152,713. SCHILLER DISKIN BARBARA A, ASHLAND, OR. FILED 4-10-2007.

We are the Green Kids

THE MARK CONSISTS OF STANDARD CHARACTERS WITHOUT CLAIM TO ANY PARTICULAR FONT, STYLE, SIZE, OR COLOR.

CLASS 16—PAPER GOODS AND PRINTED MATTER

FOR A SERIES OF BOOKS, WRITTEN ARTICLES, HANDOUTS AND WORKSHEETS IN THE FIELD OF TEACHING CHILDREN ABOUT RECYCLING, SELF-ESTEEM AND TOOLS FOR DEVELOPING SELF-ESTEEM; ADDRESS BOOKS; APPOINTMENT BOOKS; AUTOGRAPH BOOKS; BABY BOOKS; BIRTHDAY BOOKS; BOOK COVERS; BOOK-COVER PAPER; BRAG BOOKS; CHILDREN'S ACTIVITY BOOKS; CHILDREN'S BOOKS; CHILDREN'S INTERACTIVE EDUCATIONAL BOOKS; CHILDREN'S STORYBOOKS; COLORING BOOKS; COMIC BOOKS; COOK BOOKS; DATE BOOKS; DISPOSABLE SWIM PANTS FOR CHILDREN AND INFANTS; EDUCATIONAL BOOKS FEATURING CHILDREN, NAMELY, EDUCATIONAL BOOK FOR USE IN TEACHING CHILDREN ABOUT RECYCLING, SELF-ESTEEM AND TOOLS FOR DEVELOPING SELF-ESTEEM; EDUCATIONAL PUBLICATIONS, NAMELY, EDUCATIONAL LEARNING CARDS, FLASH CARDS, ACTIVITY CARDS, WORKBOOKS, TEXTBOOKS, ACTIVITY BOOKS, STORY BOOKS, PUZZLE BOOKS, PUZZLES, TEACHER GUIDES, MANUALS, POSTERS, EDUCATIONAL CARD GAMES AND EDUCATIONAL BOOKLETS IN THE FIELD OF TEACHING CHILDREN ABOUT RECYCLING, SELF-ESTEEM AND TOOLS FOR DEVELOPING SELF-ESTEEM; EXERCISE BOOKS; EXERCISE-BOOK COVERS; GIFT BOOKS FEATURING PHOTOGRAPHS OF CHILDREN; MANUSCRIPT BOOKS; MODELING CLAY FOR CHILDREN; MODELING MATERIALS AND COMPOUNDS FOR USE BY CHILDREN; NOTE BOOKS; PAINTING SETS FOR CHILDREN; PICTURE BOOKS; POCKET MEMORANDUM BOOKS; PRINTED MUSIC BOOKS; PROTECTIVE COVERS FOR BOOKS; ROLE PLAYING GAME EQUIPMENT IN THE NATURE OF GAME BOOK MANUALS; SCHOOL SUPPLY KITS CONTAINING VARIOUS COMBINATIONS OF SELECTED SCHOOL SUPPLIES, NAMELY, WRITING INSTRUMENTS, PENS, PENCILS, MECHANICAL PENCILS, ERASERS, MARKERS, CRAYONS, HIGHLIGHTERS, FOLDERS, NOTEBOOKS, PAPER, GRADUATED RULERS, PROTRACTORS, PAPER CLIPS, PENCIL

SHARPENERS, WRITING GRIPS, GLUE AND BOOK MARKS; SCHOOL WRITING BOOKS; SERIES OF FICTION BOOKS; SERIES OF NON-FICTION BOOKS IN THE FIELD OF CHILDREN, NAMELY, CHILD BEHAVIOR, PARENTING SKILLS AND TOOLS FOR DEVELOPING SELF-ESTEEM; SKETCH BOOKS; SONG BOOKS; STORY BOOKS; TALKING CHILDREN'S BOOKS (U.S. CLS. 2, 5, 22, 23, 29, 37, 38 AND 50).

SN 77-152,755. THE TRUSTEES OF COLUMBIA UNIVERSITY IN THE CITY OF NEW YORK, NEW YORK, NY. FILED 4-10-2007.

CLASS 25—CLOTHING

FOR CAPS; CHILDREN'S AND INFANTS' CLOTH BIBS; CHILDREN'S CLOTH EATING BIBS; CHILDREN'S HEADWEAR; CLOTH BIBS; CLOTH DIAPERS; CLOTHING FOR WEAR IN JUDO PRACTICES; CLOTHING, NAMELY, ARM WARMERS; CLOTHING, NAMELY, KNEE WARMERS; CLOTHING, NAMELY, NECK TUBES; CLOTHING, NAMELY, WRAP-AROUNDS; FOU-LARDS; HOODS; INFANT AND TODDLER ONE PIECE CLOTHING; INFANT CLOTH DIAPERS; JERSEYS; LEOTARDS AND TIGHTS FOR WOMEN, MEN AND CHILDREN OF NYLON, COTTON OR OTHER TEXTILE FIBERS; NON-DISPOSABLE CLOTH TRAINING PANTS; PAPER HATS FOR USE AS CLOTHING ITEMS; PARTS OF CLOTHING, NAMELY, GUSSETS FOR TIGHTS, GUSSETS FOR STOCKINGS, GUSSETS FOR BATHING SUITS, GUSSETS FOR UNDERWEAR, GUSSETS FOR LEOTARDS AND GUSSETS FOR FOOTLETS; PER-SPIRATION ABSORBENT UNDERWEAR CLOTHING; SHIRTS; SHORT SETS; TIES; TOPS; UNDERARM CLOTHING SHIELDS; WRAPS (U.S. CLS. 22 AND 39).
JENNIFER MARTIN, EXAMINING ATTORNEY



THE MARK CONSISTS OF A REPRESENTATION OF THE SIGN OF HERMES.

CLASS 16—PAPER GOODS AND PRINTED MATTER

FOR PUBLICATIONS, NAMELY, BULLETINS, CATALOGUES, MAGAZINES, NEWSLETTERS, JOURNALS, DIRECTORIES, BROCHURES, REPORTS AND ANNOUNCEMENTS ALL IN THE FIELD OF GRADUATE BUSINESS EDUCATION (U.S. CLS. 2, 5, 22, 23, 29, 37, 38 AND 50).

FIRST USE 2-6-1960; IN COMMERCE 2-6-1960.

CLASS 41—EDUCATION AND ENTERTAINMENT

FOR EDUCATIONAL SERVICES, NAMELY, PROVIDING COURSES OF INSTRUCTION AT THE GRADUATE BUSINESS SCHOOL LEVEL AND DISTRIBUTING COURSE MATERIALS IN CONNECTION THEREWITH (U.S. CLS. 100, 101 AND 107).

FIRST USE 2-6-1960; IN COMMERCE 2-6-1960.

BILL DAWE, EXAMINING ATTORNEY

SN 77-152,746. LILIEDAHL ENTERPRISES, INC., LA PORTE, TX. FILED 4-10-2007.

Art Instruction at its
Best!

THE MARK CONSISTS OF STANDARD CHARACTERS WITHOUT CLAIM TO ANY PARTICULAR FONT, STYLE, SIZE, OR COLOR.

NO CLAIM IS MADE TO THE EXCLUSIVE RIGHT TO USE "ART INSTRUCTION", APART FROM THE MARK AS SHOWN.

CLASS 9—ELECTRICAL AND SCIENTIFIC APPARATUS

FOR PRE-RECORDED CDS, VIDEO TAPES, LASER DISKS AND DVDS FEATURING ART INSTRUCTION (U.S. CLS. 21, 23, 26, 36 AND 38).

FIRST USE 6-1-1999; IN COMMERCE 6-1-1999.

CLASS 41—EDUCATION AND ENTERTAINMENT

FOR EDUCATION SERVICES, NAMELY, PROVIDING LIVE AND ON-LINE CLASSES AND WORKSHOPS IN THE FIELD OF ART (U.S. CLS. 100, 101 AND 107).

FIRST USE 6-1-1999; IN COMMERCE 6-1-1999.

DAVID I, EXAMINING ATTORNEY

SN 77-152,876. MICHAEL S. BRODER, PHILADELPHIA, PA. AND ARLENE GOLDMAN, PHILADELPHIA, PA. FILED 4-10-2007.

STAGE CLIMBING

THE MARK CONSISTS OF STANDARD CHARACTERS WITHOUT CLAIM TO ANY PARTICULAR FONT, STYLE, SIZE, OR COLOR.

CLASS 9—ELECTRICAL AND SCIENTIFIC APPARATUS

FOR PRE-RECORDED AUDIO TAPES AND VIDEO TAPES FEATURING LECTURES THE SUBJECT OF PSYCHOTHERAPY AND SELF-HELP PSYCHOLOGY; ELECTRONIC PUBLICATIONS, NAMELY BOOKS IN THE FIELD OF PSYCHOTHERAPY AND SELF-HELP PSYCHOLOGY RECORDED ON COMPUTER MEDIA (U.S. CLS. 21, 23, 26, 36 AND 38).

CLASS 41—EDUCATION AND ENTERTAINMENT

FOR EDUCATION SERVICES, NAMELY, PROVIDING LIVE AND ON-LINE CLASSES, SEMINARS, WORKSHOPS, CONFERENCES, TUTORING, MENTORING IN THE FIELD OF PSYCHOTHERAPY AND PSYCHOLOGY AND DISTRIBUTION OF COURSE MATERIAL IN CONNECTION THEREWITH; PROVIDING ONLINE NON-DOWNLOADABLE PRE-RECORDED AUDIO TAPES, VIDEO TAPES, AND AUDIO BOOKS FEATURING LECTURES ON THE SUBJECT OF PSYCHOTHERAPY AND SELF-HELP PSYCHOLOGY (U.S. CLS. 100, 101 AND 107).

DAVID MURRAY, EXAMINING ATTORNEY

SN 77-153,317. PAUL GREEN PRODUCTIONS, INC., DEL-
RAY BEACH, FL. FILED 4-10-2007.

KLEZMER EAST

THE MARK CONSISTS OF STANDARD CHARACTERS WITHOUT CLAIM TO ANY PARTICULAR FONT, STYLE, SIZE, OR COLOR.

NO CLAIM IS MADE TO THE EXCLUSIVE RIGHT TO USE "KLEZMER", APART FROM THE MARK AS SHOWN.

CLASS 9—ELECTRICAL AND SCIENTIFIC APPARATUS

FOR SOUND RECORDINGS, NAMELY, PHONOGRAPH RECORDS, PRE-RECORDED AUDIO TAPES, PRE-RECORDED CD'S, AND DOWNLOADABLE DIGITAL AUDIO FILES FEATURING VOCAL AND MUSICAL PERFORMANCES; VIDEO RECORDINGS, NAMELY, PRE-RECORDED VIDEO CASSETTES, PRE-RECORDED DVD'S AND DOWNLOADABLE DIGITAL VIDEO FILES FEATURING VOCAL AND MUSICAL PERFORMANCES (U.S. CLS. 21, 23, 26, 36 AND 38).

CLASS 41—EDUCATION AND ENTERTAINMENT

FOR ENTERTAINMENT SERVICES, NAMELY, LIVE MUSICAL PERFORMANCES BY A MUSICAL GROUP (U.S. CLS. 100, 101 AND 107).

REBECCA EISINGER, EXAMINING ATTORNEY

SN 77-153,254. BENNETT, STEPHANIE, NORTHRIDGE, CA.
FILED 4-10-2007.



THE MARK CONSISTS OF THE COMBINED IMAGES OF A GLOBE, A HARP, AND A MUSICAL NOTE.

CLASS 9—ELECTRICAL AND SCIENTIFIC APPARATUS

FOR AUDIO RECORDINGS FEATURING MUSIC (U.S. CLS. 21, 23, 26, 36 AND 38).

FIRST USE 4-13-1997; IN COMMERCE 4-13-1997.

CLASS 16—PAPER GOODS AND PRINTED MATTER

FOR SHEET MUSIC (U.S. CLS. 2, 5, 22, 23, 29, 37, 38 AND 50).

FIRST USE 4-13-1997; IN COMMERCE 4-13-1997.

CLASS 41—EDUCATION AND ENTERTAINMENT

FOR COMPOSITION OF MUSIC FOR OTHERS; ENTERTAINMENT NAMELY, LIVE PERFORMANCES BY A MUSICAL BAND; ENTERTAINMENT, NAMELY LIVE MUSIC CONCERTS; INSTRUCTION IN THE FIELD OF MUSIC; MUSIC COMPOSITION AND TRANSCRIPTION FOR OTHERS; PRESENTATION OF MUSICAL PERFORMANCE; RENTAL OF MUSICAL INSTRUMENTS (U.S. CLS. 100, 101 AND 107).

FIRST USE 4-13-1997; IN COMMERCE 4-13-1997.

LINDA M. KING, EXAMINING ATTORNEY

SN 77-153,334. BLUE RIDGE ANALYTICS, INC., CHAR-
LOTTE, NC. FILED 4-10-2007.

CAD WITH A BRAIN!

THE MARK CONSISTS OF STANDARD CHARACTERS WITHOUT CLAIM TO ANY PARTICULAR FONT, STYLE, SIZE, OR COLOR.

NO CLAIM IS MADE TO THE EXCLUSIVE RIGHT TO USE "CAD", APART FROM THE MARK AS SHOWN.

CLASS 9—ELECTRICAL AND SCIENTIFIC APPARATUS

FOR COMPUTER SOFTWARE FOR PLANNING, FEASIBILITY ANALYSIS, CIVIL ENGINEERING, AND OPTIMIZATION IN THE FIELD OF COMPUTER-ASSISTED LAND DEVELOPMENT AND DESIGN (U.S. CLS. 21, 23, 26, 36 AND 38).

CLASS 42—SCIENTIFIC AND COMPUTER SERVICES

FOR PROVIDING TEMPORARY USE OF ON-LINE NON-DOWNLOADABLE COMPUTER SOFTWARE FOR PLANNING, FEASIBILITY ANALYSIS, CIVIL ENGINEERING, AND OPTIMIZATION IN THE FIELD OF COMPUTER-ASSISTED LAND DEVELOPMENT AND DESIGN (U.S. CLS. 100 AND 101).

KATHERINE CHANG, EXAMINING ATTORNEY

SN 77-153,683. PRODUCT PARTNERS LLC, BEVERLY HILLS, PA. FILED 4-11-2007.

SN 77-153,735. WORLDPAC, INC., NEWARK, CA. FILED 4-11-2007.

COUNTDOWN THE POUNDS

THE MARK CONSISTS OF STANDARD CHARACTERS WITHOUT CLAIM TO ANY PARTICULAR FONT, STYLE, SIZE, OR COLOR.

NO CLAIM IS MADE TO THE EXCLUSIVE RIGHT TO USE "POUNDS", APART FROM THE MARK AS SHOWN.

CLASS 9—ELECTRICAL AND SCIENTIFIC APPARATUS

FOR PRE-RECORDED VIDEO TAPES, CASSETTES DVD'S AND CDS, FEATURING EXERCISE, FITNESS AND DIETARY INFORMATION AND INSTRUCTION; INSTRUCTIONAL VIDEO KITS FOR PHYSICAL FITNESS AND NUTRITION TRAINING CONSISTING PRIMARILY OF PRE-RECORDED VIDEO TAPES, CASSETTES, DVD'S AND CDS, FEATURING EXERCISE, FITNESS AND DIETARY INFORMATION AND INSTRUCTION AND COMPANION INSTRUCTIONAL PRINTED EXERCISE TRAINING AND DIETARY MANUALS (U.S. CLS. 21, 23, 26, 36 AND 38).

CLASS 41—EDUCATION AND ENTERTAINMENT

FOR EDUCATIONAL SERVICES, NAMELY INSTRUCTION IN THE USE OF EXERCISE EQUIPMENT; PROVIDING INSTRUCTION IN THE FIELD OF NUTRITION, EXERCISE, FITNESS AND HEALTH; PROVIDING INSTRUCTION IN THE FIELD OF PHYSICAL EXERCISE; PROVIDING ON-LINE COMPUTER DATABASE FEATURING INFORMATION IN EXERCISE AND PHYSICAL FITNESS (U.S. CLS. 100, 101 AND 107).

HANNO RITTNER, EXAMINING ATTORNEY

SN 77-153,701. A&A GLOBAL INDUSTRIES, COCKEYSVILLE, MD. FILED 4-11-2007.

Adopt A Puppy

THE MARK CONSISTS OF STANDARD CHARACTERS WITHOUT CLAIM TO ANY PARTICULAR FONT, STYLE, SIZE, OR COLOR.

CLASS 16—PAPER GOODS AND PRINTED MATTER

FOR TEMPORARY TATTOOS (U.S. CLS. 2, 5, 22, 23, 29, 37, 38 AND 50).

CLASS 30—STAPLE FOODS

FOR CANDY (U.S. CL. 46).
AMEETA JORDAN, EXAMINING ATTORNEY

WORLD SOURCEONE

THE MARK CONSISTS OF STANDARD CHARACTERS WITHOUT CLAIM TO ANY PARTICULAR FONT, STYLE, SIZE, OR COLOR.

OWNER OF U.S. REG. NO. 1,443,025.

CLASS 7—MACHINERY

FOR STARTER ALTERNATORS (U.S. CLS. 13, 19, 21, 23, 31, 34 AND 35).

FIRST USE 12-0-2006; IN COMMERCE 12-0-2006.

CLASS 9—ELECTRICAL AND SCIENTIFIC APPARATUS

FOR BATTERIES FOR VEHICLES (U.S. CLS. 21, 23, 26, 36 AND 38).

FIRST USE 8-0-2005; IN COMMERCE 8-0-2005.

B. PARADEWELAI, EXAMINING ATTORNEY

SN 77-153,866. DUNO, MILKA, MIAMI, FL. FILED 4-11-2007.



THE MARK CONSISTS OF A STAR.

CLASS 16—PAPER GOODS AND PRINTED MATTER

FOR STATIONERY; POSTERS; MAGAZINES FEATURING MOTOR SPORTS AND CAR RACING; BOOKS IN THE FIELD OF MOTOR SPORTS AND CAR RACING; AND CALENDARS (U.S. CLS. 2, 5, 22, 23, 29, 37, 38 AND 50).

CLASS 25—CLOTHING

FOR CLOTHING, NAMELY, FOOTWEAR, HEADWEAR, HATS AND CAPS, SOCKS, SHIRTS, SKIRTS, PANTS, SHORTS, JACKETS, AND SWEATSHIRTS (U.S. CLS. 22 AND 39).

CLASS 41—EDUCATION AND ENTERTAINMENT

FOR ENTERTAINMENT SERVICES, NAMELY, AN ON-GOING TELEVISION SERIES IN THE FIELD OF MOTOR SPORTS AND RACING FOR MOTOR SPORTS AND RACING FANS; ENTERTAINMENT SERVICES, NAMELY, PROVIDING A WEBSITE FEATURING PHOTOGRAPHIC, AUDIO, VIDEO AND PROSE PRESENTATIONS FOR MOTOR SPORTS AND RACING FANS (U.S. CLS. 100, 101 AND 107).
 MORENO, PAUL, EXAMINING ATTORNEY

CLASS 41—EDUCATION AND ENTERTAINMENT

FOR BUSINESS TRAINING; PERSONAL COACHING SERVICES IN THE FIELD OF MANAGEMENT (U.S. CLS. 100, 101 AND 107).
 FIRST USE 11-1-2006; IN COMMERCE 11-1-2006.
 THEODORE MCBRIDE, EXAMINING ATTORNEY

SN 77-153,895. DIVINE PHYSICS HOLISTIC LIFESTYLES, INC., CENTENNIAL, CO. FILED 4-11-2007.

SN 77-154,101. MICROPHAGE INCORPORATED, LONGMONT, CO. FILED 4-11-2007.

TEAM REGENERATION

THE MARK CONSISTS OF STANDARD CHARACTERS WITHOUT CLAIM TO ANY PARTICULAR FONT, STYLE, SIZE, OR COLOR.
 NO CLAIM IS MADE TO THE EXCLUSIVE RIGHT TO USE "REGENERATION", APART FROM THE MARK AS SHOWN.

THE MARK CONSISTS OF STANDARD CHARACTERS WITHOUT CLAIM TO ANY PARTICULAR FONT, STYLE, SIZE, OR COLOR.

CLASS 41—EDUCATION AND ENTERTAINMENT

FOR EDUCATION SERVICES, NAMELY, PROVIDING CLASSES, SEMINARS AND WORKSHOPS IN THE FIELDS OF MEDICAL, SOCIAL, SPIRITUAL, POLITICAL, ENVIRONMENTAL, HEALTH CARE AND CULTURAL ISSUES (U.S. CLS. 100, 101 AND 107).

CLASS 9—ELECTRICAL AND SCIENTIFIC APPARATUS

FOR TESTING APPARATUS AND DIAGNOSTIC APPARATUS, NOT IN THE MEDICAL FIELD, NAMELY IMMUNOASSAY APPARATUS FOR DETECTING THE PRESENCE OF AND IDENTIFYING BACTERIUM, VIRUSES OR OTHER PATHOGENS (U.S. CLS. 21, 23, 26, 36 AND 38).

CLASS 44—MEDICAL, BEAUTY AND AGRICULTURAL SERVICES

FOR CULTURAL MEDICAL, HEALTH CARE AND HYGIENIC SERVICES IN THE NATURE OF IN-HOUSE, CORPORATE AND INDIVIDUALIZED PROGRAMS OFFERING MASSAGE, CHIROPRACTIC, NATUROPATHIC, NUTRITIONAL AND HOLISTIC MEDICAL SERVICES, AND HOMEOPATHY AND ENERGY MEDICAL SERVICES; PSYCHOTHERAPY AND HEALTH SPA SERVICES FOR THE HEALTH AND WELLNESS OF THE BODY AND SPIRIT (U.S. CLS. 100 AND 101).
 MORENO, PAUL, EXAMINING ATTORNEY

CLASS 10—MEDICAL APPARATUS

FOR TESTING APPARATUS AND DIAGNOSTIC APPARATUS, IN THE MEDICAL FIELD, NAMELY IMMUNOASSAY APPARATUS FOR DETECTING THE PRESENCE OF AND IDENTIFYING BACTERIUM, VIRUSES OR OTHER PATHOGENS (U.S. CLS. 26, 39 AND 44).
 MICHELE SWAIN, EXAMINING ATTORNEY

SN 77-154,090. DECISIVE DIRECTIONS LLC, RIDGEFIELD, CT. FILED 4-11-2007.

SN 77-154,309. KONICA MINOLTA MEDICAL IMAGING USA, INC., WAYNE, NJ. FILED 4-11-2007.

Decisive Directions

THE MARK CONSISTS OF STANDARD CHARACTERS WITHOUT CLAIM TO ANY PARTICULAR FONT, STYLE, SIZE, OR COLOR.

CODA

THE MARK CONSISTS OF STANDARD CHARACTERS WITHOUT CLAIM TO ANY PARTICULAR FONT, STYLE, SIZE, OR COLOR.

CLASS 35—ADVERTISING AND BUSINESS

FOR BUSINESS CONSULTATION SERVICES; BUSINESS CONSULTING AND INFORMATION SERVICES (U.S. CLS. 100, 101 AND 102).
 FIRST USE 11-1-2006; IN COMMERCE 11-1-2006.

CLASS 9—ELECTRICAL AND SCIENTIFIC APPARATUS

FOR MEDICAL SOFTWARE FOR PROCESSING AND DISPLAYING X-RAY IMAGES (U.S. CLS. 21, 23, 26, 36 AND 38).

CLASS 10—MEDICAL APPARATUS

FOR MEDICAL EQUIPMENT, NAMELY, MEDICAL X-RAY APPARATUS (U.S. CLS. 26, 39 AND 44).
 TOBY BULLOFF, EXAMINING ATTORNEY

SN 77-154,324. SIGMA-ALDRICH BIOTECHNOLOGY L.P., ST. LOUIS, MO. FILED 4-11-2007.

LOPAC

THE MARK CONSISTS OF STANDARD CHARACTERS WITHOUT CLAIM TO ANY PARTICULAR FONT, STYLE, SIZE, OR COLOR.

CLASS 1—CHEMICALS

FOR ASSAY VALIDATIONS FOR USE IN ACADEMIC AND COMMERCIAL LIFE SCIENCE, PHARMACEUTICAL, MEDICAL AND BIOTECHNOLOGY RESEARCH; FULL LINE OF CHEMICALS FOR MANUFACTURING, RESEARCH AND SCIENTIFIC USE; CHEMICAL COMPOUNDS FOR USE IN THE MANUFACTURE OF PHARMACEUTICAL PREPARATIONS; CHEMICALS FOR USE IN INDUSTRY AND SCIENCE; PHOTOGRAPHIC CHEMICALS; UNPROCESSED ARTIFICIAL RESINS, UNPROCESSED PLASTICS; MANURES; FIRE EXTINGUISHING COMPOSITIONS; CHEMICAL SUBSTANCES FOR PRESERVING FOODSTUFFS; ADHESIVES FOR GENERAL INDUSTRIAL USE; A FULL LINE OF CHEMICALS FOR MANUFACTURING, RESEARCH AND SCIENTIFIC USE (U.S. CLS. 1, 5, 6, 10, 26 AND 46).

CLASS 5—PHARMACEUTICALS

FOR A FULL LINE OF COMPOUNDS, NAMELY VITAMIN AND MINERAL PREPARATIONS FOR USE AS INGREDIENTS IN PHARMACEUTICAL PREPARATIONS (U.S. CLS. 6, 18, 44, 46, 51 AND 52).

CLASS 40—MATERIAL TREATMENT

FOR CUSTOM MANUFACTURE FOR OTHERS OF CHEMICALS FOR USE IN MANUFACTURE, RESEARCH AND SCIENCE; CUSTOM MANUFACTURE FOR OTHERS OF COMPOUNDS FOR USE IN PHARMACEUTICALS (U.S. CLS. 100, 103 AND 106).

CLASS 42—SCIENTIFIC AND COMPUTER SERVICES

FOR PRODUCT DEVELOPMENT, NAMELY DEVELOPMENT OF CHEMICALS, COMPOUNDS, AND INGREDIENTS FOR MANUFACTURE, PHARMACEUTICALS, RESEARCH AND FOR SCIENTIFIC PURPOSES; CHEMICAL AND SCIENTIFIC RESEARCH FOR OTHERS; DEVELOPMENT FOR OTHERS OF CHEMICALS, COMPOUNDS AND INGREDIENTS FOR USE IN MANUFACTURE, PHARMACEUTICALS, RESEARCH AND FOR SCIENTIFIC PURPOSES (U.S. CLS. 100 AND 101).
LAURIE KAUFMAN, EXAMINING ATTORNEY

SN 77-154,585. KORANGY PUBLICATIONS, INC., NEW YORK, NY. FILED 4-11-2007.

THE REAL DEAL

THE MARK CONSISTS OF STANDARD CHARACTERS WITHOUT CLAIM TO ANY PARTICULAR FONT, STYLE, SIZE, OR COLOR.

OWNER OF U.S. REG. NO. 3,198,005.

CLASS 9—ELECTRICAL AND SCIENTIFIC APPARATUS

FOR DIGITAL MEDIA, NAMELY, DOWNLOADABLE WEBCASTS AND PODCASTS FEATURING REAL ESTATE MATTERS; DOWNLOADABLE ELECTRONIC PUBLICATIONS IN THE NATURE OF MAGAZINES AND NEWSLETTERS IN THE FIELD OF REAL ESTATE; DOWNLOADABLE MAGAZINES, NEWSLETTERS, WEBCASTS AND PODCASTS IN THE FIELD OF REAL ESTATE, VIA THE INTERNET AND WIRELESS DEVICES (U.S. CLS. 21, 23, 26, 36 AND 38).

FIRST USE 7-0-2003; IN COMMERCE 7-0-2003.

CLASS 41—EDUCATION AND ENTERTAINMENT

FOR ENTERTAINMENT IN THE NATURE OF ONGOING PODCASTS, WEBCASTS AND TELEVISION PROGRAMS IN THE FIELD OF REAL ESTATE (U.S. CLS. 100, 101 AND 107).

FIRST USE 7-0-2005; IN COMMERCE 7-0-2005.
AMEETA JORDAN, EXAMINING ATTORNEY

SN 77-154,701. BIOMET MICROFIXATION, INC., JACKSONVILLE, FL. FILED 4-12-2007.



BIOMET
MICROFIXATION

Anticipate. Innovate.

NO CLAIM IS MADE TO THE EXCLUSIVE RIGHT TO USE "MICROFIXATION", APART FROM THE MARK AS SHOWN.

THE MARK CONSISTS OF STYLIZED LETTERS AND NO COLOR IS BEING CLAIMED.

CLASS 9—ELECTRICAL AND SCIENTIFIC APPARATUS

FOR MULTIMEDIA SOFTWARE RECORDED ON CD-ROM AND DVD FEATURING INSTRUCTIONAL AND INFORMATIONAL MATERIALS FOR SURGICAL AND MEDICAL CLINICIANS AND PRACTITIONERS (U.S. CLS. 21, 23, 26, 36 AND 38).

CLASS 10—MEDICAL APPARATUS

FOR CRANIOFACIAL, ORAL, MAXILLOFACIAL, PECTUS EXCAVATUM, NEUROSURGICAL, AND PLASTIC SURGERY SURGICAL INSTRUMENTS AND TOOLS (U.S. CLS. 26, 39 AND 44).

TINA KUAN, EXAMINING ATTORNEY

SN 77-154,755. FARMERS GROUP, INC., LOS ANGELES, CA. FILED 4-12-2007.

FARMERS BUSINESS INSURANCE EXPRESS

THE MARK CONSISTS OF STANDARD CHARACTERS WITHOUT CLAIM TO ANY PARTICULAR FONT, STYLE, SIZE, OR COLOR.

OWNER OF U.S. REG. NOS. 1,657,608, 1,821,672 AND OTHERS.

NO CLAIM IS MADE TO THE EXCLUSIVE RIGHT TO USE "BUSINESS INSURANCE EXPRESS", APART FROM THE MARK AS SHOWN.

CLASS 9—ELECTRICAL AND SCIENTIFIC APPARATUS

FOR COMPUTER SOFTWARE FOR THE MANAGEMENT AND ADMINISTRATION OF INSURANCE UNDERWRITING, CLAIMS ADMINISTRATION AND AGENCY SERVICES FOR USE BY INSURANCE AGENTS (U.S. CLS. 21, 23, 26, 36 AND 38).

CLASS 36—INSURANCE AND FINANCIAL

FOR INSURANCE BROKERAGE SERVICES; INSURANCE SERVICES, NAMELY, PROVIDING A FULL RANGE OF BUSINESS INSURANCE AND RISK MANAGEMENT SERVICES FOR BUSINESSES, INSURANCE UNDERWRITING, CLAIMS ADMINISTRATION AND AGENCY SERVICES (U.S. CLS. 100, 101 AND 102). REGINA DRUMMOND, EXAMINING ATTORNEY

SN 77-154,830. LANCESOFT, INC., CHANTILLY, VA. FILED 4-12-2007.

LANCESOFT

THE MARK CONSISTS OF STANDARD CHARACTERS WITHOUT CLAIM TO ANY PARTICULAR FONT, STYLE, SIZE, OR COLOR.

CLASS 35—ADVERTISING AND BUSINESS

FOR DATABASE MANAGEMENT; OUTSOURCING SERVICES (U.S. CLS. 100, 101 AND 102). FIRST USE 2-0-2000; IN COMMERCE 2-0-2000.

CLASS 42—SCIENTIFIC AND COMPUTER SERVICES

FOR INFORMATION TECHNOLOGY CONSULTATION; INTEGRATION OF COMPUTER SYSTEMS AND NETWORKS; COMPUTER SOFTWARE CONSULTATION; DESIGN AND DEVELOPMENT OF NETWORKS; TECHNICAL SUPPORT, NAMELY, MONITORING OF NETWORK SYSTEMS; TECHNICAL SUPPORT SERVICES, NAMELY, TROUBLESHOOTING OF COMPUTER HARDWARE AND SOFTWARE PROBLEMS; DATABASE DEVELOPMENT SERVICES; COMPUTER DIAGNOSTIC SERVICES; DATA WAREHOUSING; PROVIDING QUALITY ASSURANCE SERVICES IN THE FIELD OF INFORMATION TECHNOLOGY; DESIGN AND DEVELOPMENT OF ON-LINE COMPUTER SOFTWARE SYSTEMS; DESIGN, DEVELOPMENT AND IMPLEMENTATION OF SOFTWARE (U.S. CLS. 100 AND 101).

FIRST USE 2-0-2000; IN COMMERCE 2-0-2000. MICHAEL LEWIS, EXAMINING ATTORNEY

SN 77-154,892. THE COLISEUM MAUSOLEUM, INC., RENO, NV. FILED 4-12-2007.

COLISEUM MAUSOLEUM

THE MARK CONSISTS OF STANDARD CHARACTERS WITHOUT CLAIM TO ANY PARTICULAR FONT, STYLE, SIZE, OR COLOR.

CLASS 41—EDUCATION AND ENTERTAINMENT

FOR CASINO AND GAMING SERVICES; PROVIDING CASINO AND GAMING FACILITIES; AMUSEMENT CENTERS AND ARCADES (U.S. CLS. 100, 101 AND 107).

CLASS 43—HOTEL AND RESTAURANT SERVICES

FOR RESTAURANT, BAR AND LOUNGE SERVICES (U.S. CLS. 100 AND 101). ROBERT C. CLARK JR., EXAMINING ATTORNEY

SN 77-155,150. RYDAN LLC, SAN JOSE, CA. FILED 4-12-2007.



THE MARK CONSISTS OF WINGED CAPITAL LETTER "R".

CLASS 12—VEHICLES

FOR PANNIER BAGS FOR MOTORCYCLES; MOTORCYCLE SADDLEBAGS (U.S. CLS. 19, 21, 23, 31, 35 AND 44).

CLASS 25—CLOTHING

FOR GLOVES; MOTORCYCLE GLOVES; CHAPS; VESTS; JACKETS; LEATHER JACKETS (U.S. CLS. 22 AND 39).

ROBERT C. CLARK JR., EXAMINING ATTORNEY

SN 77-155,274. MMA ANIMAL, LLC, HOUSTON, TX. FILED 4-12-2007.

ANIMAL FIGHTWEAR

THE MARK CONSISTS OF STANDARD CHARACTERS WITHOUT CLAIM TO ANY PARTICULAR FONT, STYLE, SIZE, OR COLOR.

NO CLAIM IS MADE TO THE EXCLUSIVE RIGHT TO USE "FIGHTWEAR", APART FROM THE MARK AS SHOWN.

CLASS 25—CLOTHING

FOR CLOTHING, NAMELY, SHORTS, VALE TUDO SHORTS, FIGHT SHORTS, SHIRTS, SWEATPANTS, RASH GUARDS, TANK TOPS, T-SHIRTS, POLO SHIRTS, SPORTS SHIRTS, VESTS, SWEATERS, SWEAT SHIRTS, JACKETS, CAPS, SKULLCAPS, BEANIES, HATS, SLACKS, WARM-UP SUITS, MUSCLE SHIRTS, FIGHT ROBES, SHOES, SOCKS, MARTIAL ARTS BELTS, COMBAT SPORTS BELTS, MARTIAL ARTS KIMONOS, MARTIAL ARTS GIS, MARTIAL ARTS UNIFORMS, AND COMBATIVE SPORTS UNIFORMS (U.S. CLS. 22 AND 39).

CLASS 28—TOYS AND SPORTING GOODS

FOR ATHLETIC EQUIPMENT AND SPORTING GOODS, NAMELY, BOXING GLOVES, FIGHT GLOVES, TRAINING GLOVES, COMPETITION GLOVES, HAND WRAPS, KICKING SHIELDS, STRIKING BAGS, STRIKING TARGETS, STRIKING MITTS, SHIN GUARDS, KNEE PADS, CHEST PROTECTORS, GROIN PROTECTORS, HEAD GUARDS, FOCUS MITTS, THAI PADS, BODY PROTECTION SUITS, PROTECTIVE CRASH PADS AND PROTECTIVE THROWING PADS FOR MARTIAL ARTS AND COMBAT SPORTS, FIGHTING RINGS, BOXING RINGS, THROWING DUMMIES, AND MIXED MARTIAL ARTS CAGES (U.S. CLS. 22, 23, 38 AND 50).

ALEX KEAM, EXAMINING ATTORNEY

SN 77-155,301. PARTON, DOLLY, LOS ANGELES, CA. FILED 4-12-2007.

DOLLY'S DIXIE DINER

THE MARK CONSISTS OF STANDARD CHARACTERS WITHOUT CLAIM TO ANY PARTICULAR FONT, STYLE, SIZE, OR COLOR.

OWNER OF U.S. REG. NOS. 1,322,593 AND 1,367,078.

CLASS 7—MACHINERY

FOR ELECTRIC FOOD BLENDERS FOR DOMESTIC USE AND ELECTRIC MIXERS FOR HOUSEHOLD PURPOSES, ELECTRIC CAN OPENERS, AND ELECTRIC MEAT GRINDERS (U.S. CLS. 13, 19, 21, 23, 31, 34 AND 35).

CLASS 11—ENVIRONMENTAL CONTROL APPARATUS

FOR DOMESTIC ELECTRIC APPLIANCES, NAMELY, FRYING PANS, ELECTRIC GRILL PANS, ELECTRIC ROTISSERIES, DEEP FRYERS, ELECTRICAL ICE CREAM MACHINES, ELECTRIC TOASTER OVENS, ELECTRIC TOASTERS, MICROWAVE OVENS AND ELECTRIC WAFFLE IRONS (U.S. CLS. 13, 21, 23, 31 AND 34).

MARY MUNSON, EXAMINING ATTORNEY

SN 77-155,319. PARTON, DOLLY, LOS ANGELES, CA. FILED 4-12-2007.

DOLLY'S DIXIE DINER

THE MARK CONSISTS OF STANDARD CHARACTERS WITHOUT CLAIM TO ANY PARTICULAR FONT, STYLE, SIZE, OR COLOR.

OWNER OF U.S. REG. NOS. 1,322,593 AND 1,367,078.

CLASS 9—ELECTRICAL AND SCIENTIFIC APPARATUS

FOR PRE-RECORDED VIDEO TAPES, PHONOGRAPHIC RECORDS, VIDEO DISCS, AUDIO TAPES, COMPACT DISCS, DVDS, LASER DISCS, CD-ROMS FEATURING COOKING INSTRUCTIONS AND TECHNIQUES, FOOD PREPARATION, RECIPES, DIETARY AND HEALTH INFORMATION, AND FOOD STORAGE AND PRESERVATION INSTRUCTIONS AND TECHNIQUES; SOUND RECORDINGS FEATURING COOKING INSTRUCTIONS AND TECHNIQUES, FOOD PREPARATION, RECIPES, DIETARY AND HEALTH INFORMATION, AND FOOD STORAGE AND PRESERVATION INSTRUCTIONS AND TECHNIQUES; COMPUTER SOFTWARE FOR DATABASE MANAGEMENT FOR COOKING AND RECIPE COMPILATIONS; ELECTRONIC PUBLICATIONS, NAMELY, MAGAZINES, NEWSLETTERS AND BOOKS RECORDED ON COMPUTER MEDIA ALL FEATURING COOKING INSTRUCTIONS AND TECHNIQUES, FOOD PREPARATION, RECIPES, DIETARY AND HEALTH INFORMATION, AND FOOD STORAGE AND PRESERVATION INSTRUCTIONS AND TECHNIQUES (U.S. CLS. 21, 23, 26, 36 AND 38).

CLASS 41—EDUCATION AND ENTERTAINMENT

FOR EDUCATIONAL AND ENTERTAINMENT SERVICES IN THE NATURE OF AN ONGOING SERIES OF COOKING SHOWS, AND SINGLE COOKING SHOWS, BROADCAST OVER TELEVISION, SATELLITE, RADIO AND BY MEANS OF OTHER AUDIO AND VIDEO MEDIA (U.S. CLS. 100, 101 AND 107).

MARY MUNSON, EXAMINING ATTORNEY

SN 77-155,398. NUTRITION 21, INC., PURCHASE, NY.
FILED 4-12-2007.



THE MARK CONSISTS OF THE WORD "CORE4LIFE" IN A STYLIZED FONT OVER A FIGURE OF A PERSON RUNNING, ALL OF WHICH IS CONTAINED WITHIN AN OVAL DESIGN.

CLASS 3—COSMETICS AND CLEANING PREPARATIONS

FOR SKIN LOTIONS (U.S. CLS. 1, 4, 6, 50, 51 AND 52).

CLASS 5—PHARMACEUTICALS

FOR DIETARY AND NUTRITIONAL SUPPLEMENTS (U.S. CLS. 6, 18, 44, 46, 51 AND 52).
KATHLEEN LORENZO, EXAMINING ATTORNEY

SN 77-155,414. EBY GROUP, INC., OLATHE, KS. FILED 4-12-2007.



THE MARK CONSISTS OF IMAGE IS DESIGN OF A TREE.

CLASS 35—ADVERTISING AND BUSINESS

FOR BUSINESS MANAGEMENT OF SENIOR CARE CENTERS FOR OTHERS (U.S. CLS. 100, 101 AND 102).
FIRST USE 1-31-1999; IN COMMERCE 1-31-1999.

CLASS 36—INSURANCE AND FINANCIAL

FOR FINANCIAL SERVICES, NAMELY, ANALYSIS, EVALUATION AND CONSULTATION OF CONSTRUCTION PROJECT FINANCING; COMMERCIAL REAL ESTATE BROKERAGE SERVICES (U.S. CLS. 100, 101 AND 102).
FIRST USE 1-31-1999; IN COMMERCE 1-31-1999.

CLASS 43—HOTEL AND RESTAURANT SERVICES

FOR PROVIDING ASSISTED LIVING FACILITIES (U.S. CLS. 100 AND 101).
FIRST USE 1-31-1999; IN COMMERCE 1-31-1999.

CLASS 44—MEDICAL, BEAUTY AND AGRICULTURAL SERVICES

FOR MEDICAL SERVICES, NAMELY, PROVIDING A CARE CENTER FOR SENIOR CITIZENS (U.S. CLS. 100 AND 101).
WARREN L. OLANDRIA, EXAMINING ATTORNEY

SN 77-155,475. MARSICO, ROBERT, LAS VEGAS, NV. AND MARSICO, MARILYN, LAS VEGAS, NV. FILED 4-12-2007.

ZIG ZAG COFFEE

THE MARK CONSISTS OF STANDARD CHARACTERS WITHOUT CLAIM TO ANY PARTICULAR FONT, STYLE, SIZE, OR COLOR.

NO CLAIM IS MADE TO THE EXCLUSIVE RIGHT TO USE "COFFEE", APART FROM THE MARK AS SHOWN.

CLASS 30—STAPLE FOODS

FOR COFFEE (U.S. CL. 46).

CLASS 43—HOTEL AND RESTAURANT SERVICES

FOR COFFEE HOUSES (U.S. CLS. 100 AND 101).
AMY MCMENAMIN, EXAMINING ATTORNEY

SN 77-155,576. BIO-LOGIC AQUA TECHNOLOGIES, INC., GRANTS PASS, OR. FILED 4-12-2007.

H2O MEDICINE

THE MARK CONSISTS OF STANDARD CHARACTERS WITHOUT CLAIM TO ANY PARTICULAR FONT, STYLE, SIZE, OR COLOR.

NO CLAIM IS MADE TO THE EXCLUSIVE RIGHT TO USE "H2O", APART FROM THE MARK AS SHOWN.

CLASS 3—COSMETICS AND CLEANING PREPARATIONS

FOR PURIFIED WATER USED TO WASH, MOISTURIZE, AND REFRESH THE SKIN; STERILE SPRING WATER USED AS A MOISTURIZER FOR THE MOUTH AND TONGUE (U.S. CLS. 1, 4, 6, 50, 51 AND 52).

CLASS 5—PHARMACEUTICALS

FOR PURIFIED WATER USED TO WASH, MOISTURIZE, AND REFRESH THE EYES FOR MEDICAL USE; PURIFIED LIQUID, NAMELY, HIGHLY PURIFIED WATER SUITABLE FOR FIRST AID AND MEDICAL USE; EYE WASH, NAMELY, PURIFIED WATER IN A SPRAY CONTAINER FOR REFRESHING TEAR FILM FOR MEDICAL USE (U.S. CLS. 6, 18, 44, 46, 51 AND 52).

CLASS 32—LIGHT BEVERAGES

FOR SPRING WATER (U.S. CLS. 45, 46 AND 48).
KRISTIN DAHLING, EXAMINING ATTORNEY

SN 77-155,639. GONTANG, PETER, RANCHO SANTA MARGARITA, CA. AND LUCAS, MICHAEL, RANCHO SANTA MARGARITA, CA. AND LILLY, TABARAS, RANCHO SANTA MARGARITA, CA. AND CAMARATA, ANTHONY, RANCHO SANTA MARGARITA, CA. FILED 4-12-2007.

SN 77-155,632. GROENING, MATT, LOS ANGELES, CA.
FILED 4-12-2007.

LIFE IN HELL

THE MARK CONSISTS OF STANDARD CHARACTERS WITHOUT CLAIM TO ANY PARTICULAR FONT, STYLE, SIZE, OR COLOR.

CLASS 16—PAPER GOODS AND PRINTED MATTER

FOR PAPER GOODS AND PRINTED MATTER, NAMELY, COMIC BOOKS AND COMIC STRIPS; COMIC BOOK REFERENCE GUIDE BOOKS; A SERIES OF FICTION BOOKS FEATURING STORIES AND CHARACTERS IN ILLUSTRATED FORMS; GRAPHIC NOVELS; NOVELS; PRINTED POSTCARDS; PICTURE POSTCARDS; COMIC POSTCARDS; POSTCARDS; TRADING CARDS AND COLLECTORS CARDS FEATURING COMIC BOOK, COMIC STRIP, CARTOON AND LIVE ACTION CHARACTERS; NOTEBOOKS; BINDERS; DECALS; STICKERS; PHOTOGRAPH AND SCRAPBOOK ALBUMS; CALENDARS; FOLDERS; DESK PADS; WRITING PADS; STATIONERY FOLDERS AND STATIONERY (U.S. CLS. 2, 5, 22, 23, 29, 37, 38 AND 50).

CLASS 25—CLOTHING

FOR CLOTHING; NAMELY, SHIRTS, T-SHIRTS, SWEATSHIRTS, SWEATERS, VESTS, JACKETS, WARM-UP SUITS, ROBES, PANTS, SHORTS, CLOTHING BELTS, DRESSES, OVERALLS, INFANTWEAR, PLAYSUITS, CLOTH BABY BIBS, HEADWEAR, FOOTWEAR, BOOTS, SHOES, SOCKS, TIGHTS, BEACHWEAR, SWIMSUITS, SWIMWEAR, BATHING CAPS, TENNIS WEAR, RAINWEAR, JACKETS, COATS, GLOVES, MUFFLERS, HATS, SUN VISORS, NECKWEAR, CUMMERBUNDS, BANDANAS, SCARVES, PAJAMAS, NIGHTSHIRTS, NIGHTGOWNS, UNDERGARMENTS, APRONS, MASQUERADE COSTUMES, AND MASQUERADE COSTUMES WITH MASKS SOLD IN CONNECTION THEREWITH (U.S. CLS. 22 AND 39).

GIANCARLO CASTRO, EXAMINING ATTORNEY



DO THE MATH 247

THE MARK CONSISTS OF 4 EQUIDISTANT LINES WHICH SHARE AN OVERLAPPING MIDPOINT. THE FOUR LINES ARE SEPARATED BY ROTATING THEM AT THEIR MIDPOINTS FROM ONE ANOTHER AT 45 DEGREE ANGLES. PARALLEL TO THE HORIZONTAL AXIS LINE ARE TWO EQUIDISTANT LINES, ONE ABOVE AND ONE BELOW THE HORIZONTAL AXIS. JUST ABOVE AND BELOW THE ENDPOINTS OF THE VERTICAL AXIS LINE ARE TWO CIRCLES, EACH OF WHICH SHARE THE SAME DIAMETER AS THE WIDTH OF THE VERTICAL AXIS LINE. INTERSECTING THESE CIRCLES, BUT VISUALLY PLACED BEHIND THEM, IS A FINAL ENCOMPASSING CIRCLE WHICH ALSO SHARES THE WIDTH OF ALL OF THE AXIS LINES, VERTICAL, HORIZONTAL, AND AT 45 DEGREE ANGLES. BY SEPARATING SPECIFIC PIECES OF THE TRADEMARK, ONE COULD DERIVE THE FOLLOWING MATHEMATICAL SYMBOLS: A PLUS SIGN (+), AND MINUS SIGN (-), AND MULTIPLICATION SIGN (X), AND DIVISION SIGN (*) AND AN EQUAL SIGN (=).

CLASS 16—PAPER GOODS AND PRINTED MATTER

FOR STICKERS (U.S. CLS. 2, 5, 22, 23, 29, 37, 38 AND 50).

CLASS 25—CLOTHING

FOR HATS; PANTS; SHIRTS; SHORTS; SOCKS (U.S. CLS. 22 AND 39).

GIANCARLO CASTRO, EXAMINING ATTORNEY

SN 77-155,783. MAXVALUEIP CONSULTING, POTOMAC, MD. FILED 4-13-2007.

Max ValueIP

THE MARK CONSISTS OF STANDARD CHARACTERS WITHOUT CLAIM TO ANY PARTICULAR FONT, STYLE, SIZE, OR COLOR.

CLASS 35—ADVERTISING AND BUSINESS

FOR CONSULTING SERVICES IN THE FIELD OF MANAGING INTELLECTUAL PROPERTIES (U.S. CLS. 100, 101 AND 102).

FIRST USE 5-4-2006; IN COMMERCE 5-4-2006.

CLASS 45—PERSONAL AND LEGAL SERVICES

FOR INTELLECTUAL PROPERTY CONSULTATION; INTELLECTUAL PROPERTY WATCH SERVICES; LICENSING OF INTELLECTUAL PROPERTY; PATENT AND INDUSTRIAL PROPERTY CONSULTATION (U.S. CLS. 100 AND 101).

FIRST USE 5-4-2006; IN COMMERCE 5-4-2006.

KIMBERLY PERRY, EXAMINING ATTORNEY

SN 77-155,872. TONY ALAMO CHRISTIAN MINISTRIES, TEXARKANA, TX. FILED 4-13-2007.

**TONY ALAMO CHRISTIAN
MINISTRIES**

THE MARK CONSISTS OF STANDARD CHARACTERS WITHOUT CLAIM TO ANY PARTICULAR FONT, STYLE, SIZE, OR COLOR.

NO CLAIM IS MADE TO THE EXCLUSIVE RIGHT TO USE "CHRISTIAN MINISTRIES", APART FROM THE MARK AS SHOWN.

THE NAME(S), PORTRAIT(S), AND/OR SIGNATURE(S) SHOWN IN THE MARK IDENTIFIES TONY ALAMO, WHOSE CONSENT(S) TO REGISTER IS MADE OF RECORD.

CLASS 16—PAPER GOODS AND PRINTED MATTER

FOR RELIGIOUS BOOKS; RELIGIOUS CIRCULAR LETTERS; BOOKS IN THE FIELD OF RELIGION; PAMPHLETS IN THE FIELD OF RELIGION; NEWSLETTERS IN THE FIELD OF RELIGION (U.S. CLS. 2, 5, 22, 23, 29, 37, 38 AND 50).

FIRST USE 10-1-1997; IN COMMERCE 10-1-1997.

CLASS 41—EDUCATION AND ENTERTAINMENT

FOR PRODUCTION AND DISTRIBUTION OF RADIO PROGRAMS; PRODUCTION OF RADIO OR TELEVISION PROGRAMS; RADIO ENTERTAINMENT PRODUCTION; RADIO ENTERTAINMENT SERVICES, NAMELY RADIO PROGRAMS FEATURING PERFORMANCES BY A PASTOR (U.S. CLS. 100, 101 AND 107).

FIRST USE 10-1-1997; IN COMMERCE 10-1-1997.

CLASS 45—PERSONAL AND LEGAL SERVICES

FOR EVANGELISTIC AND MINISTERIAL SERVICES; EVANGELISTIC MINISTERIAL SERVICES; MINISTERIAL SERVICES (U.S. CLS. 100 AND 101).

FIRST USE 10-1-1997; IN COMMERCE 10-1-1997.

TASHIA BUNCH, EXAMINING ATTORNEY

SN 77-155,903. HENKEL CORPORATION, GULPH MILLS, PA. FILED 4-13-2007.

POWER GRAB

THE MARK CONSISTS OF STANDARD CHARACTERS WITHOUT CLAIM TO ANY PARTICULAR FONT, STYLE, SIZE, OR COLOR.

OWNER OF U.S. REG. NO. 2,782,429.

CLASS 16—PAPER GOODS AND PRINTED MATTER

FOR ADHESIVE TAPE FOR HOUSEHOLD PURPOSES (U.S. CLS. 2, 5, 22, 23, 29, 37, 38 AND 50).

CLASS 17—RUBBER GOODS

FOR ADHESIVE TAPE FOR USE IN HOME AND BUILDING CONSTRUCTION, RENOVATION, MAINTENANCE AND REPAIR (U.S. CLS. 1, 5, 12, 13, 35 AND 50).

BRIAN PINO, EXAMINING ATTORNEY

SN 77-156,102. CALLE SOCCER LLC, PROVO, UT. FILED 4-13-2007.

CALLE

THE MARK CONSISTS OF STANDARD CHARACTERS WITHOUT CLAIM TO ANY PARTICULAR FONT, STYLE, SIZE, OR COLOR.

CLASS 25—CLOTHING

FOR (BASED ON USE IN COMMERCE) CLOTHING, NAMELY, SHIRTS, SHORTS, SWEATSHIRTS, FOOTWEAR, AND HEADWEAR; (BASED ON INTENT TO USE) CLOTHING, NAMELY, SOCKS, WRISTBANDS, PANTS, JACKETS, UNDERWEAR, AND SPORTS BRAS (U.S. CLS. 22 AND 39).

FIRST USE 6-1-2006; IN COMMERCE 6-1-2006.

CLASS 28—TOYS AND SPORTING GOODS

FOR (BASED ON USE IN COMMERCE) SOCCER SPORTS EQUIPMENT, NAMELY, SOCCER BALLS AND SOCCER BALL SACKS; (BASED ON INTENT TO USE) SOCCER SPORTS EQUIPMENT, NAMELY, PORTABLE GOALS, CONES, AND BACKPACKS SPECIALLY ADAPTED AND DESIGNED FOR HOLDING SOCCER EQUIPMENT (U.S. CLS. 22, 23, 38 AND 50).

FIRST USE 6-1-2006; IN COMMERCE 6-1-2006.

JEFF DEFORD, EXAMINING ATTORNEY

SN 77-156,145. CREATIVE FAMILIES, LLC, MAITLAND, FL.
FILED 4-13-2007.

SN 77-156,171. CALLE SOCCER LLC, PROVO, UT. FILED 4-
13-2007.

CREATIVE FAMILY TRADITIONS
& IDEAS

THE MARK CONSISTS OF STANDARD CHARACTERS
WITHOUT CLAIM TO ANY PARTICULAR FONT, STYLE,
SIZE, OR COLOR.

**CLASS 9—ELECTRICAL AND SCIENTIFIC
APPARATUS**

FOR PRERECORDED VIDEOTAPES AND DIGITAL
VIDEO DISCS FEATURING INFORMATION ON HOLI-
DAY CELEBRATIONS, PARTIES, DECORATING,
COOKING AND FAMILY ACTIVITIES (U.S. CLS. 21, 23,
26, 36 AND 38).

**CLASS 16—PAPER GOODS AND PRINTED
MATTER**

FOR A SERIES OF BOOKS AND PERIODICAL PUB-
LICATIONS IN THE FIELD OF HOLIDAY CELEBRA-
TIONS, PARTIES, DECORATING, COOKING AND
FAMILY ACTIVITIES (U.S. CLS. 2, 5, 22, 23, 29, 37, 38
AND 50).

JEFF DEFORD, EXAMINING ATTORNEY

SN 77-156,158. LANGTON, BRENT, HOLLYWOOD, CA.
FILED 4-13-2007.

B2 Pro

THE MARK CONSISTS OF STANDARD CHARACTERS
WITHOUT CLAIM TO ANY PARTICULAR FONT, STYLE,
SIZE, OR COLOR.

**CLASS 9—ELECTRICAL AND SCIENTIFIC
APPARATUS**

FOR BALLASTS FOR GAS DISCHARGE LAMPS;
BALLASTS FOR HALOGEN LIGHTS; CAMERA
FLASHES; ELECTRIC IGNITERS USED IN CONNEC-
TION WITH BALLASTS TO START DISCHARGE
LAMPS; FLASH GUNS FOR CAMERAS AND PHOTO-
GRAPHY USE; FLASH LAMPS FOR CAMERAS AND
PHOTOGRAPHY USE; FLUORESCENT LAMP BALLAST
FOR ELECTRIC LIGHTS; LIGHTING BALLASTS;
PHOTOGRAPHIC FLASH UNITS FOR CAMERAS AND
PHOTOGRAPHY USE (U.S. CLS. 21, 23, 26, 36 AND 38).

CLASS 18—LEATHER GOODS

FOR BAGS FOR UMBRELLAS; FRAMES FOR UM-
BRELLAS; METAL PARTS OF UMBRELLAS; TELE-
SCOPIC UMBRELLAS; UMBRELLA BASES;
UMBRELLA COVERS; UMBRELLA FRAMES; UMBREL-
LA RINGS; UMBRELLAS; UMBRELLAS AND THEIR
PARTS (U.S. CLS. 1, 2, 3, 22 AND 41).

JEFF DEFORD, EXAMINING ATTORNEY



THE MARK CONSISTS OF A PIGEON.

CLASS 25—CLOTHING

FOR (BASED ON USE IN COMMERCE) CLOTHING,
NAMESLY, SHIRTS, SHORTS, SWEATSHIRTS, FOOT-
WEAR, AND HEADWEAR; (BASED ON INTENT TO
USE) CLOTHING, NAMESLY, SOCKS, WRISTBANDS,
PANTS, JACKETS, UNDERWEAR, AND SPORTS BRAS
(U.S. CLS. 22 AND 39).

FIRST USE 6-1-2006; IN COMMERCE 6-1-2006.

CLASS 28—TOYS AND SPORTING GOODS

FOR (BASED ON INTENT TO USE) SOCCER SPORTS
EQUIPMENT, NAMESLY, SOCCER BALLS, SOCCER
BALL SACKS, PORTABLE GOALS, CONES, AND BACK-
PACKS SPECIALLY ADAPTED AND DESIGNED FOR
HOLDING SOCCER EQUIPMENT (U.S. CLS. 22, 23, 38
AND 50).

JEFF DEFORD, EXAMINING ATTORNEY

SN 77-156,179. ROBISON'S, INC., IDAHO FALLS, ID. FILED
4-13-2007.

OVERBO

THE MARK CONSISTS OF STANDARD CHARACTERS
WITHOUT CLAIM TO ANY PARTICULAR FONT, STYLE,
SIZE, OR COLOR.

CLASS 18—LEATHER GOODS

FOR LUGGAGE; BACKPACKS; AND DUFFLE BAGS
(U.S. CLS. 1, 2, 3, 22 AND 41).

CLASS 25—CLOTHING

FOR CLOTHING, NAMESLY, JACKETS, SHIRTS,
PANTS, INSULATED BIBS FOR SNOW SPORTS FOR
PROTECTION AGAINST COLD, RAIN SUITS, RAIN
COATS, UNDERGARMENTS, SCARVES, BALACLAVAS,
GLOVES, MITTENS, BOOTS, SHOES, AND HATS; SKI
BOOT BAGS; THERMALLY INSULATED FACE-MASKS
FOR SNOW SPORTS (U.S. CLS. 22 AND 39).

CLASS 28—TOYS AND SPORTING GOODS

FOR BAGS SPECIALLY ADAPTED FOR SNOW
SPORTS EQUIPMENT; SKI-CARRYING BAGS; SNOW
BOARD-CARRYING BAGS (U.S. CLS. 22, 23, 38 AND 50).

SANDRA MANIOS, EXAMINING ATTORNEY

SN 77-156,188. GABRIEL KAFATI, INC., MIAMI, FL. FILED 4-13-2007.



NO CLAIM IS MADE TO THE EXCLUSIVE RIGHT TO USE "COFFEE SHOP & BAKERY", APART FROM THE MARK AS SHOWN.

THE COLOR(S) DARK YELLOW, BLACK, DARK ORANGE, LIGHT ORANGE, WHITE, LIGHT GRAY, GRAY, DARK GRAY IS/ARE CLAIMED AS A FEATURE OF THE MARK.

THE WORD "CAFEMANIA" IS DARK YELLOW AND LINED IN BLACK; THE WORDS "COFFEE SHOP & BAKERY" ARE DARK ORANGE AND LINED IN BOTH WHITE AND BLACK; THE CUP IS DARK ORANGE WITH A LIGHT ORANGE SHADOW AND IS LINED IN BLACK; THE THREE SPIRAL-SHAPED STEAM MARKS ARE LIGHT GRAY, GRAY, AND DARK GRAY; THE SLANTED OVAL IS IN SHADES OF LIGHT AND DARK GRAY; AND THE SHADOW SURROUNDING THE MARK IS LIGHT GRAY.

CLASS 29—MEATS AND PROCESSED FOODS

FOR MILK; MILK BASED BEVERAGES CONTAINING FRUIT JUICE; MILK BEVERAGES CONTAINING FRUITS; MILK DRINKS CONTAINING FRUITS; MILK-BASED BEVERAGE CONTAINING COFFEE; SOYBEAN MILK; FRUIT SALADS; DAIRY-BASED FOOD BEVERAGES (U.S. CL. 46).

CLASS 30—STAPLE FOODS

FOR BAGELS; BAKERY DESSERTS; BAKERY GOODS; BAKERY PRODUCTS, NAMELY, SWEET BAKERY GOODS; BEVERAGES MADE OF COFFEE; BEVERAGES MADE OF TEA; CAFFEINE-FREE COFFEE; CAPPUCCINO; COCOA BEVERAGES WITH MILK; COFFEE; COFFEE; COFFEE-BASED BEVERAGE CONTAINING MILK; COOKIES; CROISSANTS; HERBAL INFUSIONS; HERBAL TEA; HOT CHOCOLATE; MILK SHAKES; PASTRIES; PREPARED COCOA AND COCOA-BASED BEVERAGES; PREPARED COFFEE AND COFFEE-BASED BEVERAGES; SANDWICHES; SHAKES; TEA (U.S. CL. 46).

CLASS 32—LIGHT BEVERAGES

FOR FLAVORED WATERS; FRUIT BEVERAGES; FRUIT-FLAVORED BEVERAGES; MINERAL WATER; SPARKLING WATER; SPRING WATER; STILL WATER (U.S. CLS. 45, 46 AND 48).

CLASS 35—ADVERTISING AND BUSINESS

FOR WHOLESALE DISTRIBUTORSHIPS FEATURING GROUND AND WHOLE BEAN COFFEE, TEA, COCOA, COFFEE AND ESPRESSO BEVERAGES AND BEVERAGES MADE WITH A BASE OF COFFEE, ESPRESSO, AND/OR MILK, BAKED GOODS, CONSISTING OF COOKIES, PASTRIES, SANDWICHES, FRUIT SALADS, AND PREPARED FOODS; FRANCHISING, NAMELY, OFFERING TECHNICAL ASSISTANCE IN THE ESTABLISHMENT AND/OR OPERATION OF RESTAURANTS, COFFEE HOUSES, CAFES, AND SNACK BARS; PROVIDING TECHNICAL ASSISTANCE IN THE ESTABLISHMENT AND/OR OPERATION OF RESTAURANTS, CAFES, COFFEE HOUSES, AND SNACK BARS; RETAIL STORE SERVICES FEATURING COFFEE, TEA, COCOA, PACKAGED AND PREPARED FOODS (U.S. CLS. 100, 101 AND 102).

CLASS 38—COMMUNICATION

FOR INTERNET CAFE SERVICES, NAMELY, PROVIDING TELECOMMUNICATIONS CONNECTIONS TO THE INTERNET IN A CAFE ENVIRONMENT (U.S. CLS. 100, 101 AND 104).

CLASS 43—HOTEL AND RESTAURANT SERVICES

FOR RESTAURANT SERVICES; SERVING FOOD AND DRINKS; CAFE-RESTAURANTS; COFFEE SHOPS; COFFEE-HOUSE AND SNACK-BAR SERVICES; FOOD PREPARATION SERVICES (U.S. CLS. 100 AND 101).
KRISTINA MORRIS, EXAMINING ATTORNEY

SN 77-156,274. PRECIOUS PUPPIES OF FLORIDA, INC., PLANTATION, FL. FILED 4-13-2007.

PRECIOUS PUPPIES

THE MARK CONSISTS OF STANDARD CHARACTERS WITHOUT CLAIM TO ANY PARTICULAR FONT, STYLE, SIZE, OR COLOR.

NO CLAIM IS MADE TO THE EXCLUSIVE RIGHT TO USE "PUPPIES", APART FROM THE MARK AS SHOWN.

CLASS 18—LEATHER GOODS

FOR (BASED ON INTENT TO USE) DOG CLOTHING (U.S. CLS. 1, 2, 3, 22 AND 41).

CLASS 35—ADVERTISING AND BUSINESS

FOR (BASED ON USE IN COMMERCE) RETAIL AND ONLINE PET STORE SERVICES (U.S. CLS. 100, 101 AND 102).

FIRST USE 4-28-2001; IN COMMERCE 4-28-2001.
BERNICE MIDDLETON, EXAMINING ATTORNEY

SN 77-156,299. RSF ENTERPRISES LLC, LAS VEGAS, NV. FILED 4-13-2007.

THE COLOR(S) BLACK AND RED IS/ARE CLAIMED AS A FEATURE OF THE MARK.

THE MARK CONSISTS OF A STYLIZED, BLACK "CLEVER" WITH A RED THOUGHT CLOUD DESIGN LEADING UP TO A STYLIZED, RED "BOB".

CLASS 35—ADVERTISING AND BUSINESS

FOR PROVIDING CONSUMER INFORMATION SERVICES AND MAKING REFERRALS IN THE FIELD OF ENTERTAINMENT SERVICES FOR PRODUCTS, SERVICES, EVENTS, ACTIVITIES, FACILITIES AND LOCATIONS; PROVIDING INFORMATION ABOUT AND MAKING REFERRALS IN THE FIELD OF CONSUMER PRODUCTS AND SERVICES FOR RETAIL SERVICES CONCERNING PRODUCTS, SERVICES, EVENTS, ACTIVITIES, ATTRACTIONS AND FACILITIES IN PARTICULAR GEOGRAPHIC LOCATIONS (U.S. CLS. 100, 101 AND 102).

CLASS 41—EDUCATION AND ENTERTAINMENT

FOR ARRANGING FOR TICKET RESERVATIONS FOR SHOWS AND OTHER ENTERTAINMENT EVENTS; PROVIDING A WEB SITE WHERE USERS CAN POST RATINGS, REVIEWS AND RECOMMENDATIONS ON EVENTS AND ACTIVITIES IN THE FIELD OF ENTERTAINMENT AND EDUCATION (U.S. CLS. 100, 101 AND 107).

LINDA POWELL, EXAMINING ATTORNEY

SN 77-156,430. EOG RESOURCES, INC., HOUSTON, TX.
FILED 4-13-2007.



OWNER OF U.S. REG. NO. 2,633,937.
NO CLAIM IS MADE TO THE EXCLUSIVE RIGHT TO USE "PIPELINE", APART FROM THE MARK AS SHOWN.
THE MARK CONSISTS OF A FLAME WITH "PECAN PIPELINE" NEXT TO THE FLAME.

CLASS 39—TRANSPORTATION AND STORAGE

FOR NATURAL GAS TRANSMISSION (U.S. CLS. 100 AND 105).
FIRST USE 3-1-2007; IN COMMERCE 3-1-2007.

CLASS 40—MATERIAL TREATMENT

FOR COMPRESSION AND CONDITIONING OF NATURAL GAS (U.S. CLS. 100, 103 AND 106).
FIRST USE 3-1-2007; IN COMMERCE 3-1-2007.
KHANH LE, EXAMINING ATTORNEY

SN 77-156,360. THE HEALTH CHIC, INC., HAINES CITY, FL.
FILED 4-13-2007.

THE HEALTH CHIC

THE MARK CONSISTS OF STANDARD CHARACTERS WITHOUT CLAIM TO ANY PARTICULAR FONT, STYLE, SIZE, OR COLOR.

NO CLAIM IS MADE TO THE EXCLUSIVE RIGHT TO USE "HEALTH", APART FROM THE MARK AS SHOWN.

CLASS 16—PAPER GOODS AND PRINTED MATTER

FOR BOOKS IN THE FIELD OF WHOLE NATURAL LIVING, FITNESS AND NUTRITION; MAGAZINE COLUMNS ABOUT WHOLE NATURAL LIVING, FITNESS AND NUTRITION; NEWSLETTERS IN THE FIELD OF WHOLE NATURAL LIVING, FITNESS AND NUTRITION (U.S. CLS. 2, 5, 22, 23, 29, 37, 38 AND 50).

CLASS 41—EDUCATION AND ENTERTAINMENT

FOR ON-LINE JOURNALS, NAMELY, BLOGS FEATURING INFORMATION REGARDING WHOLE NATURAL LIVING, FITNESS AND NUTRITION; EDUCATION SERVICES, NAMELY, PROVIDING CLASSES, SEMINARS AND WORKSHOPS IN THE FIELD OF WHOLE NATURAL LIVING, FITNESS AND NUTRITION; ENTERTAINMENT SERVICES NAMELY PROVIDING A WEBSITE FEATURING, PHOTOGRAPHIC, AUDIO, VIDEO AND PROSE PRESENTATIONS FEATURING INFORMATION REGARDING WHOLE NATURAL LIVING, FITNESS AND NUTRITION (U.S. CLS. 100, 101 AND 107).

FIRST USE 3-27-2007; IN COMMERCE 3-27-2007.
JAMES LOVELACE, EXAMINING ATTORNEY

SN 77-156,453. E. LAND LTD., SEOUL, REPUBLIC OF KOREA, FILED 4-13-2007.



OWNER OF U.S. REG. NO. 2,893,670.
THE MARK CONSISTS OF THE WORDING "WHO.A.U" AND A DESIGN OF A FRUIT LIKE AN ORANGE WITH A LEAF.

CLASS 14—JEWELRY

FOR CLOCKS; WATCHES; ALARM CLOCKS; CASES FOR WATCHES AND CLOCKS; CHRONOMETERS; DIVING WATCHES; PARTS FOR CLOCKS; POCKET WATCHES; STOP WATCHES; TABLE CLOCKS; TIMEPIECES; WALL CLOCKS; WATCH CHAINS; WATCH STRAPS; WRISTWATCHES; JEWELRY; BRACELETS; BROOCHES; EARRINGS; NECKLACES; RINGS; CUFFLINKS; TIE PINS; PRECIOUS METALS; DIAMONDS; PEARLS; SAPPHIRES; GOLD INGOTS; KEY HOLDERS OF PRECIOUS METALS; MEDALS; ORNAMENTS OF PRECIOUS METAL; BADGES OF PRECIOUS METAL; PENDANTS (U.S. CLS. 2, 27, 28 AND 50).

CLASS 16—PAPER GOODS AND PRINTED MATTER

FOR STATIONERY; BALL POINT PENS; CRAYONS; DRAWING RULERS; NOTE BOOKS; PENCILS; PENS; ENVELOPES; ERASERS; FELT PENS; INK RIBBONS; LOOSE LEAF BINDERS; BUSINESS FORMS; MEMO PADS; STICKERS; ADHESIVE LABELS; ADHESIVES FOR STATIONERY AND HOUSEHOLD USE; DOCUMENT FILES; ACCOUNT BOOKS; ADDRESS BOOKS; ALBUMS FOR PHOTOGRAPHS; BOOKMARKS; BOOKS IN THE FIELD OF FASHION; PAMPHLETS IN THE FIELD OF FASHION; MAGAZINES IN THE FIELD OF FASHION; BUSINESS CARDS; CALENDARS; CHILDREN'S BOOKS; COMIC BOOKS; NEWSPAPERS; DIARIES; GIFT CARDS; MAPS; MONEY CLIPS; NAPKIN PAPER; PACKING PAPER; PAINTING SETS FOR CHILDREN; PAPER TOWELS; PASSPORT CASES; PHOTOGRAPHS; PICTURES; DISPOSABLE NAPKINS; DUPLICATING PAPER; CARDBOARD; BABIES' DIAPERS OF PAPER (U.S. CLS. 2, 5, 22, 23, 29, 37, 38 AND 50).

CLASS 18—LEATHER GOODS

FOR BACKPACKS; BAGS FOR SPORTS; BEACH BAGS; BELT BAGS; BRIEFCASES; HANDBAGS; RUCKSACKS; SCHOOL BAGS; TRAVEL BAGS; WALLETS; VANITY CASES SOLD EMPTY; BUSINESS CARD CASES; PARASOLS; UMBRELLAS (U.S. CLS. 1, 2, 3, 22 AND 41).

CLASS 24—FABRICS

FOR TOWELS; BATH TOWELS; BEACH TOWELS; HANDKERCHIEFS; COTTON FABRIC; SYNTHETIC FIBER FABRICS; RAMIE FABRIC; WOOLEN FABRIC; QUILTS; BED BLANKETS; DINING LINENS; FELTS; MATTRESS COVERS; MOSQUITO NETS; PILLOW COVERS; CURTAINS; SHOWER CURTAINS; TEXTILE TABLECLOTHS (U.S. CLS. 42 AND 50).

CLASS 25—CLOTHING

FOR JACKETS; JEANS; JUMPERS; COATS; RAINCOATS; DRESSES; MASQUERADE COSTUMES; PANTS; PAJAMAS; PARKAS; POLO SHIRTS; PULLOVERS; DRESS SHIRTS; SCHOOL UNIFORMS; UNIFORMS; BEACHWEAR; SPORT SHIRTS; SUITS; SWEAT SHIRTS; SWIM WEAR; ATHLETIC UNIFORMS; COMBINATIONS; BATHROBES; BLOUSES; SHORTS; SKIRTS; SLACKS; TROUSERS; T-SHIRTS; SHOES; ATHLETIC SHOES; BEACH SHOES; BELTS FOR CLOTHING; RAIN BOOTS; SANDALS; RUNNING SHOES; SNEAKERS; BRASSIERES; CAMISOLES; UNDERWEAR; GLOVES; CHEMISES; NIGHTWEAR; SCARVES; SHAWLS; MANTLES; NECKTIES; MUFFLERS; CAPS; HATS; MONEY BELTS; SOCKS; TIGHTS; TOPCOATS; CUFFS (U.S. CLS. 22 AND 39).

CLASS 26—FANCY GOODS

FOR BUTTONS FOR CLOTHING; BELT BUCKLES FOR CLOTHING; DECORATIVE CORDS; HAIR BANDS; HAIR PINS; ORNAMENTAL NOVELTY PINS; SHOE ORNAMENTS; WIGS; RIBBONS; ARTIFICIAL FLOWERS; HAIR ORNAMENTS (U.S. CLS. 37, 39, 40, 42 AND 50).

CLASS 35—ADVERTISING AND BUSINESS

FOR RETAIL CLOTHING STORE SERVICES; RETAIL STORE SERVICES FEATURING FOOTWEAR; RETAIL STORE SERVICES FEATURING BAGS; RETAIL JEWELRY STORES (U.S. CLS. 100, 101 AND 102).
CORY BOONE, EXAMINING ATTORNEY

SN 77-156,588. LEGACY SPORTS INTERNATIONAL LLC, RENO, NV. FILED 4-13-2007.

RANCLAND SECURITY

THE MARK CONSISTS OF STANDARD CHARACTERS WITHOUT CLAIM TO ANY PARTICULAR FONT, STYLE, SIZE, OR COLOR.

NO CLAIM IS MADE TO THE EXCLUSIVE RIGHT TO USE "SECURITY", APART FROM THE MARK AS SHOWN.

CLASS 13—FIREARMS

FOR FIREARMS, GUN CASES, GUN BAGS (U.S. CLS. 2 AND 9).

CLASS 25—CLOTHING

FOR CLOTHES, NAMELY, SHIRTS AND HATS (U.S. CLS. 22 AND 39).

KATHERINE E. HALMEN, EXAMINING ATTORNEY

SN 77-156,617. NORTHUP, CHRISTIE, LAKE DALLAS, TX. AND NORTHUP, ROBERT, LAKE DALLAS, TX. FILED 4-13-2007.

PAIR-A-BOWLS

THE MARK CONSISTS OF STANDARD CHARACTERS WITHOUT CLAIM TO ANY PARTICULAR FONT, STYLE, SIZE, OR COLOR.

CLASS 16—PAPER GOODS AND PRINTED MATTER

FOR PRINTED INSTRUCTIONAL, EDUCATIONAL, AND TEACHING MATERIALS IN THE FIELD OF FOOD PREPARATION, COOKING AND INSPIRATION; PUBLICATIONS, NAMELY, BROCHURES, BOOKLETS, AND TEACHING MATERIALS IN THE FIELD OF FOOD PREPARATION, COOKING AND INSPIRATION; PAMPHLETS IN THE FIELD OF FOOD PREPARATION, COOKING AND INSPIRATION; INFORMATIONAL FLYERS FEATURING FOOD PREPARATION, COOKING AND INSPIRATION; BOOKS IN THE FIELD OF FOOD PREPARATION, COOKING AND INSPIRATION; PARCHMENT PAPER; RECIPE BOOKS (U.S. CLS. 2, 5, 22, 23, 29, 37, 38 AND 50).

FIRST USE 6-21-2005; IN COMMERCE 12-29-2006.

CLASS 41—EDUCATION AND ENTERTAINMENT

FOR EDUCATIONAL AND ENTERTAINMENT SERVICES, NAMELY, PROVIDING MOTIVATIONAL AND EDUCATIONAL SPEAKERS; EDUCATION SERVICES, NAMELY, PROVIDING CLASSES, SEMINARS, WORKSHOPS IN THE FIELDS OF MOTIVATIONAL AND INSPIRATIONAL INSTRUCTION; ENTERTAINMENT IN THE NATURE OF ON-GOING TELEVISION PROGRAMS IN THE FIELD OF MOTIVATIONAL AND EDUCATIONAL SPEAKERS; ENTERTAINMENT SERVICES, NAMELY, PROVIDING A TELEVISION PROGRAM IN THE FIELD OF MOTIVATIONAL AND EDUCATIONAL SPEAKERS VIA A GLOBAL COMPUTER NETWORK (U.S. CLS. 100, 101 AND 107).

FIRST USE 6-21-2005; IN COMMERCE 12-29-2006.
JENNIFER MARTIN, EXAMINING ATTORNEY

CLASS 41—EDUCATION AND ENTERTAINMENT

FOR RENTAL OF INFLATABLE TOYS; INFLATABLE TOY STRUCTURES; INFLATABLE TOY STRUCTURES FOR BOUNCING; INFLATABLE TOY STRUCTURES FOR SLIDING; INFLATABLE TOY STRUCTURES FOR CLIMBING; INFLATABLE TOY TUNNEL STRUCTURES; INFLATABLE BALLS FOR SITTING ON AND BOUNCING, INFLATABLE RIDE-ON TOYS; AND PLAYGROUND EQUIPMENT (U.S. CLS. 100, 101 AND 107).

GENE MACIOL, EXAMINING ATTORNEY

SN 77-156,769. ZAHIRA A CABRERA, HONOLULU, HI. FILED 4-13-2007.

SN 77-156,717. NINJA JUMP, INC., LOS ANGELES, CA. FILED 4-13-2007.

NINJA JUMP

THE MARK CONSISTS OF STANDARD CHARACTERS WITHOUT CLAIM TO ANY PARTICULAR FONT, STYLE, SIZE, OR COLOR.

CLASS 28—TOYS AND SPORTING GOODS

FOR INFLATABLE TOYS; INFLATABLE TOY STRUCTURES; INFLATABLE TOY STRUCTURES FOR BOUNCING; INFLATABLE TOY STRUCTURES FOR SLIDING; INFLATABLE TOY STRUCTURES FOR CLIMBING; INFLATABLE TOY TUNNEL STRUCTURES; INFLATABLE BALLS FOR SITTING ON AND BOUNCING, INFLATABLE RIDE-ON TOYS (U.S. CLS. 22, 23, 38 AND 50).

CLASS 35—ADVERTISING AND BUSINESS

FOR RETAIL STORE SERVICES FEATURING INFLATABLE TOYS; INFLATABLE TOY STRUCTURES; INFLATABLE TOY STRUCTURES FOR BOUNCING; INFLATABLE TOY STRUCTURES FOR SLIDING; INFLATABLE TOY STRUCTURES FOR CLIMBING; INFLATABLE TOY TUNNEL STRUCTURES; INFLATABLE BALLS FOR SITTING ON AND BOUNCING, INFLATABLE RIDE-ON TOYS; AND PLAYGROUND EQUIPMENT (U.S. CLS. 100, 101 AND 102).

CLASS 40—MATERIAL TREATMENT

FOR MANUFACTURING SERVICES FOR OTHERS IN THE FIELD OF INFLATABLE TOYS; INFLATABLE TOY STRUCTURES; INFLATABLE TOY STRUCTURES FOR BOUNCING; INFLATABLE TOY STRUCTURES FOR SLIDING; INFLATABLE TOY STRUCTURES FOR CLIMBING; INFLATABLE TOY TUNNEL STRUCTURES; INFLATABLE BALLS FOR SITTING ON AND BOUNCING, INFLATABLE RIDE-ON TOYS; AND PLAYGROUND EQUIPMENT (U.S. CLS. 100, 103 AND 106).

zahira kelly

THE MARK CONSISTS OF STANDARD CHARACTERS WITHOUT CLAIM TO ANY PARTICULAR FONT, STYLE, SIZE, OR COLOR.

CLASS 16—PAPER GOODS AND PRINTED MATTER

FOR ART PRINTS (U.S. CLS. 2, 5, 22, 23, 29, 37, 38 AND 50).

CLASS 25—CLOTHING

FOR FOOTWEAR; DRESSES (U.S. CLS. 22 AND 39).
GENE MACIOL, EXAMINING ATTORNEY

SN 77-156,834. TERES, SARAH E, ANDOVER, MA. FILED 4-14-2007.

Motherwords

THE MARK CONSISTS OF A STYLIZED MARK CONSISTING OF REGULAR AND ITALICIZED SERIF CHARACTERS.

CLASS 16—PAPER GOODS AND PRINTED MATTER

FOR GENERAL FEATURE MAGAZINES (U.S. CLS. 2, 5, 22, 23, 29, 37, 38 AND 50).

CLASS 41—EDUCATION AND ENTERTAINMENT

FOR MAGAZINE PUBLISHING (U.S. CLS. 100, 101 AND 107).
SOPHIA S. KIM, EXAMINING ATTORNEY

SN 77-156,863. RAMOS, SYLVIA, CHICAGO, IL. FILED 4-14-2007.

SN 77-156,937. C R K MANAGEMENT, LLC, PITTSBURGH, PA. FILED 4-14-2007.

Let Your Voice Be Heard

THE MARK CONSISTS OF STANDARD CHARACTERS WITHOUT CLAIM TO ANY PARTICULAR FONT, STYLE, SIZE, OR COLOR.

CLASS 35—ADVERTISING AND BUSINESS

FOR BUSINESS SERVICES, NAMELY, MOTIVATION CONSULTING SERVICES FOR BUSINESSES (U.S. CLS. 100, 101 AND 102).

CLASS 45—PERSONAL AND LEGAL SERVICES

FOR PERSONAL GROWTH AND MOTIVATION CONSULTING SERVICES FOR INDIVIDUALS (U.S. CLS. 100 AND 101).
JENNIFER KRISP, EXAMINING ATTORNEY

SN 77-156,900. VADHERA, SHALINI, ENCINITAS, CA. FILED 4-14-2007.

GLOBAL GODDESS

THE MARK CONSISTS OF STANDARD CHARACTERS WITHOUT CLAIM TO ANY PARTICULAR FONT, STYLE, SIZE, OR COLOR.

CLASS 14—JEWELRY

FOR JEWELRY (U.S. CLS. 2, 27, 28 AND 50).

CLASS 25—CLOTHING

FOR ADULT, CHILDREN AND INFANT CLOTHING, NAMELY, BANDANAS, BANDEAUX, BATHING CAPS, BELTS, BLAZERS, BLOUSES, BRAS, BOXER SHORTS, CARDIGANS, COATS, RAIN COATS, DRESSES, GLOVES, DRESSING GOWNS, HATS, JACKETS, JEANS, NEGLIGEEES, NIGHT GOWNS, PANTS, POLO SHIRTS, PULLOVERS, SCARVES, SHAWLS, SHIRTS, SHORTS, SKIRTS, SOCKS, SUITS, SWEAT SHIRTS, SWEATERS, TEE-SHIRTS, TIES, TIGHTS, TROUSERS, TURBANS, UNDERPANTS, HEADWEAR, FOOTWEAR (U.S. CLS. 22 AND 39).
MICHELE SWAIN, EXAMINING ATTORNEY

FOOD YOU LUV TO LOVE

THE MARK CONSISTS OF STANDARD CHARACTERS WITHOUT CLAIM TO ANY PARTICULAR FONT, STYLE, SIZE, OR COLOR.

CLASS 25—CLOTHING

FOR SHIRTS (U.S. CLS. 22 AND 39).

CLASS 43—HOTEL AND RESTAURANT SERVICES

FOR RESTAURANT AND BAR SERVICES (U.S. CLS. 100 AND 101).
ANGELA M. MICHELI, EXAMINING ATTORNEY

SN 77-156,942. JEFFREY JOYCE, PITTSBURGH, PA. AND MICHAEL FORNEAR, VENETIA, PA. FILED 4-14-2007.

JBJ FATHER'S DAY BASEBALL CLASSIC

THE MARK CONSISTS OF STANDARD CHARACTERS WITHOUT CLAIM TO ANY PARTICULAR FONT, STYLE, SIZE, OR COLOR.

NO CLAIM IS MADE TO THE EXCLUSIVE RIGHT TO USE "FATHER'S DAY" AND "BASEBALL CLASSIC", APART FROM THE MARK AS SHOWN.

CLASS 35—ADVERTISING AND BUSINESS

FOR ASSISTANCE, ADVISORY SERVICES AND CONSULTANCY WITH REGARD TO BUSINESS PLANNING, BUSINESS ANALYSIS, BUSINESS MANAGEMENT, AND BUSINESS ORGANIZATION (U.S. CLS. 100, 101 AND 102).

CLASS 41—EDUCATION AND ENTERTAINMENT

FOR ENTERTAINMENT IN THE NATURE OF BASEBALL GAMES (U.S. CLS. 100, 101 AND 107).
ANGELA M. MICHELI, EXAMINING ATTORNEY

SN 77-156,974. MAXVALUEIP CONSULTING, POTOMAC, MD. FILED 4-15-2007.

Adding IP Value to Your Company

THE MARK CONSISTS OF STANDARD CHARACTERS WITHOUT CLAIM TO ANY PARTICULAR FONT, STYLE, SIZE, OR COLOR.

CLASS 35—ADVERTISING AND BUSINESS

FOR CONSULTING SERVICES IN THE FIELD OF MANAGING INTELLECTUAL PROPERTIES (U.S. CLS. 100, 101 AND 102).

FIRST USE 1-21-2006; IN COMMERCE 1-21-2006.

CLASS 45—PERSONAL AND LEGAL SERVICES

FOR PATENT AGENT SERVICES; PATENT AND INDUSTRIAL PROPERTY CONSULTATION; PATENT LICENSING; INTELLECTUAL PROPERTY CONSULTATION; INTELLECTUAL PROPERTY WATCH SERVICES; LICENSING OF INTELLECTUAL PROPERTY (U.S. CLS. 100 AND 101).

FIRST USE 1-21-2006; IN COMMERCE 1-21-2006.

KIMBERLY PERRY, EXAMINING ATTORNEY

SN 77-157,063. PAM'S BOUTIQUE, LLC, BETTENDORF, IA. FILED 4-15-2007.



NO CLAIM IS MADE TO THE EXCLUSIVE RIGHT TO USE CHARM, FOR INTERNATIONAL CLASS 014, APART FROM THE MARK AS SHOWN.

THE COLOR(S) GOLD AND BROWN IS/ARE CLAIMED AS A FEATURE OF THE MARK.

THE MARK CONSISTS OF THE WORD "CHARM" IN THE COLOR BROWN ABOVE AND SEPARATED BY A LINE, IN THE COLOR GOLD, FROM THE WORD "BOUTIQUE" WHICH IS IN THE COLOR BROWN.

CLASS 14—JEWELRY

FOR JEWELRY NAMELY, BRACELETS, CUFFS, EARRINGS, NECKLACES, CHOKERS, PINS, RINGS AND PENDANTS COMPRISED OF PRECIOUS METALS AND OR GLASS (U.S. CLS. 2, 27, 28 AND 50).

CLASS 25—CLOTHING

FOR CLOTHING AND ACCESSORIES, NAMELY, DRESSES, COATS, TOPS, SHIRTS, SKIRTS, BLOUSES, PANTS, SHORTS, WRAPS, LINGERIE, AND BELTS (U.S. CLS. 22 AND 39).

LINDA E. BLOHM, EXAMINING ATTORNEY

SN 77-156,982. SOCIETE HOTELS AND RESORTS LLC, LAS VEGAS, NV. FILED 4-15-2007.

SAMOURÄI

SN 77-157,072. KWAN, JOSEPH F., ARLINGTON, MA. FILED 4-15-2007.

GOD SHOT

THE MARK CONSISTS OF STANDARD CHARACTERS WITHOUT CLAIM TO ANY PARTICULAR FONT, STYLE, SIZE, OR COLOR.

CLASS 35—ADVERTISING AND BUSINESS

FOR OPERATION OF COMMERCIAL AND RESIDENTIAL PROPERTY FOR OTHERS, NAMELY, HOTELS, CONDOMINIUMS, APARTMENTS, PARKING GARAGES AND GENERAL RETAIL SPACE; COOPERATIVE REAL ESTATE MARKETING (U.S. CLS. 100, 101 AND 102).

CLASS 36—INSURANCE AND FINANCIAL

FOR REAL ESTATE SERVICES, NAMELY, THE LISTING, LEASING, AND MANAGEMENT OF COMMERCIAL AND RESIDENTIAL PROPERTY, NAMELY, HOTELS, CONDOMINIUMS, APARTMENTS, PARKING GARAGES AND GENERAL RETAIL SPACE; REAL ESTATE BROKERAGE (U.S. CLS. 100, 101 AND 102).

CLASS 37—CONSTRUCTION AND REPAIR

FOR GENERAL CONTRACTING SERVICES, RENOVATION AND REHABILITATION OF BUILDINGS (U.S. CLS. 100, 103 AND 106).

JULIE THOMAS, EXAMINING ATTORNEY

THE MARK CONSISTS OF STANDARD CHARACTERS WITHOUT CLAIM TO ANY PARTICULAR FONT, STYLE, SIZE, OR COLOR.

CLASS 30—STAPLE FOODS

FOR BEVERAGES MADE OF COFFEE; CAFFEINE-FREE COFFEE; CHICORY BASED COFFEE SUBSTITUTE; COFFEE; COFFEE BEANS; COFFEE FLAVORED SYRUP USED IN MAKING FOOD BEVERAGES; COFFEE PODS; COFFEE SUBSTITUTES; COFFEE-BASED BEVERAGE CONTAINING MILK; GROUND COFFEE BEANS; INSTANT COFFEE; PREPARED COFFEE AND COFFEE-BASED BEVERAGES; ROASTED COFFEE BEANS; SUGAR-COATED COFFEE BEANS (U.S. CL. 46).

CLASS 43—HOTEL AND RESTAURANT SERVICES

FOR COFFEE SHOPS; COFFEE SUPPLY SERVICES FOR OFFICES; COFFEE-HOUSE AND SNACK-BAR SERVICES (U.S. CLS. 100 AND 101).

TOBY BULLOFF, EXAMINING ATTORNEY

SN 77-157,284. BLD INTERNATIONAL, LEESBURG, FL.
FILED 4-16-2007.

SN 77-157,428. ACTION LANDSCAPING, LLC, PLEASANT-
VILLE, NJ. FILED 4-16-2007.

BLD INTERNATIONAL

THE MARK CONSISTS OF STANDARD CHARACTERS WITHOUT CLAIM TO ANY PARTICULAR FONT, STYLE, SIZE, OR COLOR.

NO CLAIM IS MADE TO THE EXCLUSIVE RIGHT TO USE "INTERNATIONAL", APART FROM THE MARK AS SHOWN.

CLASS 35—ADVERTISING AND BUSINESS

FOR RETAIL STORE AND ONLINE RETAIL STORE SERVICES, ALL IN THE FIELDS OF LABORATORY EQUIPMENT AND SUPPLIES FOR MEDICAL AND INDUSTRIAL RESEARCH, LABORATORY SAFETY EQUIPMENT AND SUPPLIES, MEDICAL EQUIPMENT FOR OUTPATIENT USE, HEALTH CARE PRODUCTS, OFFICE FURNITURE, OFFICE SUPPLIES, OFFICE EQUIPMENT AND RELATED PRODUCTS AND ACCESSORIES (U.S. CLS. 100, 101 AND 102).

CLASS 37—CONSTRUCTION AND REPAIR

FOR REPAIR OR MAINTENANCE OF LABORATORY APPARATUS AND INSTRUMENTS (U.S. CLS. 100, 103 AND 106).

CLASS 42—SCIENTIFIC AND COMPUTER SERVICES

FOR PIPETTE CALIBRATION SERVICES AND LABORATORY EQUIPMENT VALIDATION SERVICES (U.S. CLS. 100 AND 101).

JASON BLAIR, EXAMINING ATTORNEY

SN 77-157,427. LIFELINE CELL TECHNOLOGY, WALKERS-
VILLE, MD. FILED 4-16-2007.

NeuraLife

THE MARK CONSISTS OF STANDARD CHARACTERS WITHOUT CLAIM TO ANY PARTICULAR FONT, STYLE, SIZE, OR COLOR.

CLASS 1—CHEMICALS

FOR REAGENTS FOR RESEARCH PURPOSES, NAMELY, FOR RESEARCH FOR THE CULTURE OF NERVE CELLS (U.S. CLS. 1, 5, 6, 10, 26 AND 46).

CLASS 5—PHARMACEUTICALS

FOR MEDIA FOR NERVE CELL CULTURE (U.S. CLS. 6, 18, 44, 46, 51 AND 52).

ADA HAN, EXAMINING ATTORNEY



THE MARK CONSISTS OF THE WORDING "ACTION", A SPRINKLER HEAD, AND INDIVIDUAL WATER DROPS BEFORE, ACROSS, ABOVE AND AFTER THE WORDING "ACTION" FROM LEFT TO RIGHT.

CLASS 37—CONSTRUCTION AND REPAIR

FOR INSTALLING SOD; INSTALLING FENCING; INSTALLATION, MAINTENANCE, AND REMOVAL OF INTERIOR AND EXTERIOR CUSTOM SEASONAL DECORATIONS FOR OTHERS; INSTALLATION OF CONCRETE, PAVERS AND WALL SYSTEMS; INSTALLATION AND MAINTENANCE OF IRRIGATION SYSTEMS; SNOW REMOVAL SERVICES; PRESSURE WASHING SERVICES (U.S. CLS. 100, 103 AND 106).

FIRST USE 7-1-1995; IN COMMERCE 3-18-2006.

CLASS 44—MEDICAL, BEAUTY AND AGRICULTURAL SERVICES

FOR LANDSCAPE DESIGN; LANDSCAPE GARDENING; LANDSCAPE GARDENING DESIGN FOR OTHERS; LAWN CARE; LAWN MOWING SERVICES (U.S. CLS. 100 AND 101).

FIRST USE 7-1-1995; IN COMMERCE 3-18-2006.
ADA HAN, EXAMINING ATTORNEY

SN 77-157,505. THE ROUND-UP ASSOCIATION, PENDLE-
TON, OR. FILED 4-16-2007.



OWNER OF U.S. REG. NOS. 1,280,965, 2,093,320 AND 3,197,188.

THE MARK CONSISTS OF A COWBOY RIDING A BUCKING HORSE.

CLASS 16—PAPER GOODS AND PRINTED MATTER

FOR PRINTED MATTER, NAMELY, PHOTOGRAPHS, STATIONERY, CALENDARS AND POSTERS (U.S. CLS. 2, 5, 22, 23, 29, 37, 38 AND 50).

CLASS 18—LEATHER GOODS

FOR SADDLES, HORSE HALTERS, HORSE BRIDLES, HORSE BLANKETS, BRIEFCASES, AND LEATHER GOODS ASSOCIATED WITH EQUESTRIAN ACTIVITIES IN THE NATURE OF HORSE TACK, NAMELY, BRIDLES, HALTERS AND HORSE BREAST COLLARS (U.S. CLS. 1, 2, 3, 22 AND 41).

CLASS 21—HOUSEWARES AND GLASS

FOR BEVERAGE GLASSWARE, FIGURINES OF PORCELAIN AND EARTHENWARE; DISHES (U.S. CLS. 2, 13, 23, 29, 30, 33, 40 AND 50).

CLASS 30—STAPLE FOODS

FOR SAUCES, MUSTARDS, COFFEE (U.S. CL. 46).
JENNIFER MARTIN, EXAMINING ATTORNEY

SN 77-157,527. STARSHIP ENTERPRISE MEDIA INC., DEL-
RAY BEACH, FL. FILED 4-16-2007.

THE STARSHIP ENTERPRISE

THE MARK CONSISTS OF STANDARD CHARACTERS WITHOUT CLAIM TO ANY PARTICULAR FONT, STYLE, SIZE, OR COLOR.

CLASS 35—ADVERTISING AND BUSINESS

FOR DISSEMINATION OF ADVERTISING FOR OTHERS VIA A DIRIGIBLE (U.S. CLS. 100, 101 AND 102).

CLASS 41—EDUCATION AND ENTERTAINMENT

FOR PROVIDING RIDES ON A DIRIGIBLE (U.S. CLS. 100, 101 AND 107).
JILL C. ALT, EXAMINING ATTORNEY

SN 77-157,536. PARAGON ENTERPRISES, INC., MESA, AZ.
FILED 4-16-2007.

TIRE PARTNERS

THE MARK CONSISTS OF STANDARD CHARACTERS WITHOUT CLAIM TO ANY PARTICULAR FONT, STYLE, SIZE, OR COLOR.

NO CLAIM IS MADE TO THE EXCLUSIVE RIGHT TO USE "TIRE", APART FROM THE MARK AS SHOWN.

CLASS 35—ADVERTISING AND BUSINESS

FOR RETAIL STORES FEATURING TIRES, WHEELS, AND AUTOMOTIVE PARTS AND ACCESSORIES; ON-LINE ORDERING SERVICES FEATURING TIRES, WHEELS, AND AUTOMOTIVE PARTS AND ACCESSORIES; WHOLESALE STORES FEATURING TIRES, WHEELS, AND AUTOMOTIVE PARTS AND ACCESSORIES; WHOLESALE DISTRIBUTORSHIPS FEATURING TIRES, WHEELS, AND AUTOMOTIVE PARTS AND ACCESSORIES; WHOLESALE ORDERING SERVICES IN THE FIELD OF TIRES, WHEELS, AND AUTOMOTIVE PARTS AND ACCESSORIES; FRANCHISING SERVICES, NAMELY, OFFERING TECHNICAL ASSISTANCE IN THE ESTABLISHMENT AND/OR OPERATION OF RETAIL STORES FEATURING TIRES, WHEELS, AND AUTOMOTIVE PARTS AND ACCESSORIES (U.S. CLS. 100, 101 AND 102).

CLASS 37—CONSTRUCTION AND REPAIR

FOR AUTOMOTIVE REPAIR AND MAINTENANCE SERVICES; INSTALLATION SERVICES FOR AUTOMOTIVE PARTS AND ACCESSORIES; TIRE ROTATING AND BALANCING SERVICES (U.S. CLS. 100, 103 AND 106).

NICHOLAS ALTREE, EXAMINING ATTORNEY

SN 77-157,537. TRISTRAM, TRIS, NEWTON, NJ. FILED 4-16-2007.

STUDMUFFIN

THE MARK CONSISTS OF STANDARD CHARACTERS WITHOUT CLAIM TO ANY PARTICULAR FONT, STYLE, SIZE, OR COLOR.

CLASS 21—HOUSEWARES AND GLASS

FOR CERAMIC FIGURINES; FIGURINES MADE OUT OF FIBERGLASS; TERRA COTTA FIGURINES; CARDBOARD CUPS; COFFEE CUPS; CUPS; DRINKING CUPS; PAPER CUPS; PLASTIC CUPS; BEER MUGS; EARTHENWARE MUGS; GLASS MUGS; MUG TREES; MUGS; PORCELAIN MUGS (U.S. CLS. 2, 13, 23, 29, 30, 33, 40 AND 50).

CLASS 25—CLOTHING

FOR GOLF SHIRTS; NIGHT SHIRTS; OPEN-NECKED SHIRTS; SHIRTS; SHORT-SLEEVED OR LONG-SLEEVED T-SHIRTS; SHORT-SLEEVED SHIRTS; SLEEP SHIRTS; SPORT SHIRTS; SPORTS SHIRTS; SPORTS SHIRTS WITH SHORT SLEEVES; SWEAT SHIRTS; T-SHIRTS; HATS; BASEBALL CAPS; CAP VISORS; CAPS; CAPS WITH VISORS; GOLF CAPS; KNITTED CAPS; BERMUDA SHORTS; BOXER SHORTS; GYM SHORTS; PANTIES, SHORTS AND BRIEFS; RUGBY SHORTS; SHORTS; SWEAT SHORTS; WALKING SHORTS; HOODS; JERSEYS; MUFFLERS; TIES; TOPS (U.S. CLS. 22 AND 39).

CLASS 28—TOYS AND SPORTING GOODS

FOR MODELED PLASTIC TOY FIGURINES; BEAN BAG DOLLS; BOBBLE HEAD DOLLS; DOLLS; DOLLS AND ACCESSORIES THEREFOR; PORCELAIN DOLLS; RAG DOLLS; STUFFED DOLLS AND ANIMALS; TRADITIONALLY DRESSED WESTERN DOLLS (U.S. CLS. 22, 23, 38 AND 50).

DAVID MURRAY, EXAMINING ATTORNEY

SN 77-157,538. CRAMDEN COACH CORPORATION, AUSTIN, TX. FILED 4-16-2007.

Asleep at the Wheel

THE MARK CONSISTS OF STANDARD CHARACTERS WITHOUT CLAIM TO ANY PARTICULAR FONT, STYLE, SIZE, OR COLOR.

CLASS 9—ELECTRICAL AND SCIENTIFIC APPARATUS

FOR AUDIO RECORDINGS FEATURING MUSIC; DOWNLOADABLE MP3 FILES, MP3 RECORDINGS, ONLINE DISCUSSION BOARDS, WEB CASTS, POD CASTS FEATURING MUSIC, AUDIO BOOKS AND NEWS BROADCASTS; DOWNLOADABLE MUSICAL SOUND RECORDINGS; MUSICAL SOUND RECORDINGS; MUSICAL VIDEO RECORDINGS; SOUND RECORDINGS FEATURING MUSIC; VIDEO RECORDINGS FEATURING MUSIC VIDEOS (U.S. CLS. 21, 23, 26, 36 AND 38).

FIRST USE 1-1-1970; IN COMMERCE 1-1-1970.

CLASS 41—EDUCATION AND ENTERTAINMENT

FOR ENTERTAINMENT IN THE NATURE OF VISUAL AND AUDIO PERFORMANCES, AND MUSICAL, VARIETY, NEWS AND COMEDY SHOWS; ENTERTAINMENT IN THE NATURE OF VISUAL AND AUDIO PERFORMANCES, NAMELY, MUSICAL BAND, ROCK GROUP, GYMNASTIC, DANCE, AND BALLET PERFORMANCES; ENTERTAINMENT NAMELY, LIVE PERFORMANCES BY A MUSICAL BAND; ENTERTAINMENT SERVICES, NAMELY, PROVIDING A WEB SITE FEATURING MUSICAL PERFORMANCES, MUSICAL VIDEOS, RELATED FILM CLIPS, PHOTOGRAPHS, AND OTHER MULTIMEDIA MATERIALS; ENTERTAINMENT, NAMELY, LIVE MUSIC CONCERTS; ENTERTAINMENT, NAMELY, LIVE PERFORMANCES BY MUSICAL BANDS; PLANNING ARRANGEMENT OF SHOWING MOVIES, SHOWS, PLAYS OR MUSICAL PERFORMANCES; PRESENTATION OF MUSICAL PERFORMANCE; PRODUCTION OF SOUND AND MUSIC VIDEO RECORDINGS (U.S. CLS. 100, 101 AND 107).

FIRST USE 1-1-1970; IN COMMERCE 1-1-1970.
LYDIA BELZER, EXAMINING ATTORNEY

SN 77-157,542. PARAGON ENTERPRISES, INC., MESA, AZ. FILED 4-16-2007.



NO CLAIM IS MADE TO THE EXCLUSIVE RIGHT TO USE "TIRE", APART FROM THE MARK AS SHOWN.

CLASS 35—ADVERTISING AND BUSINESS

FOR RETAIL STORES FEATURING TIRES, WHEELS, AND AUTOMOTIVE PARTS AND ACCESSORIES; ONLINE ORDERING SERVICES FEATURING TIRES, WHEELS, AND AUTOMOTIVE PARTS AND ACCESSORIES; WHOLESALE STORES FEATURING TIRES, WHEELS, AND AUTOMOTIVE PARTS AND ACCESSORIES; WHOLESALE DISTRIBUTORSHIPS FEATURING TIRES, WHEELS, AND AUTOMOTIVE PARTS AND ACCESSORIES; WHOLESALE ORDERING SERVICES IN THE FIELD OF TIRES, WHEELS, AND AUTOMOTIVE PARTS AND ACCESSORIES; FRANCHISING SERVICES, NAMELY, OFFERING TECHNICAL ASSISTANCE IN THE ESTABLISHMENT AND/OR OPERATION OF RETAIL STORES FEATURING TIRES, WHEELS, AND AUTOMOTIVE PARTS AND ACCESSORIES (U.S. CLS. 100, 101 AND 102).

CLASS 37—CONSTRUCTION AND REPAIR

FOR AUTOMOTIVE REPAIR AND MAINTENANCE SERVICES; INSTALLATION SERVICES FOR AUTOMOTIVE PARTS AND ACCESSORIES; TIRE ROTATING AND BALANCING SERVICES (U.S. CLS. 100, 103 AND 106).

NICHOLAS ALTREE, EXAMINING ATTORNEY

SN 77-157,575. GUARDIAN ALARMS, INC., ARLINGTON, TX. FILED 4-16-2007.

METRO GUARDIAN

THE MARK CONSISTS OF STANDARD CHARACTERS WITHOUT CLAIM TO ANY PARTICULAR FONT, STYLE, SIZE, OR COLOR.

CLASS 37—CONSTRUCTION AND REPAIR

FOR INSTALLATION AND MAINTENANCE OF BURGLAR ALARMS, FIRE ALARMS AND SECURITY SYSTEMS (U.S. CLS. 100, 103 AND 106).

CLASS 42—SCIENTIFIC AND COMPUTER SERVICES

FOR MONITORING OF BURGLAR ALARMS, FIRE ALARMS AND SECURITY SYSTEMS (U.S. CLS. 100 AND 101).

CAROLINE WOOD, EXAMINING ATTORNEY

SN 77-157,641. OCEAN QUEST DIVE CENTER, LLC, ISLAMORADA, FL. FILED 4-16-2007.

B'LOW ME

THE MARK CONSISTS OF STANDARD CHARACTERS WITHOUT CLAIM TO ANY PARTICULAR FONT, STYLE, SIZE, OR COLOR.

CLASS 25—CLOTHING

FOR SHIRTS, T-SHIRTS, SWEATSHIRTS, SWEAT-PANTS, SUN VISORS, HATS AND CAPS (U.S. CLS. 22 AND 39).

CLASS 39—TRANSPORTATION AND STORAGE

FOR PROVIDING CRUISES FOR DIVING AND OTHER EXCURSIONS; AND PLEASURE BOAT CRUISES (U.S. CLS. 100 AND 105).
ALEX KEAM, EXAMINING ATTORNEY

SN 77-157,795. ILLINOIS CPA SOCIETY, CHICAGO, IL.
FILED 4-16-2007.



SN 77-157,687. EAST CAROLINA UNIVERSITY, GREENVILLE, NC. FILED 4-16-2007.



OWNER OF U.S. REG. NOS. 2,266,402, 2,858,176 AND OTHERS.

THE MARK CONSISTS OF A SABER HOLDING UP A FLAG FEATURING A DESIGN OF A SKULL AND CROSS BONES WEARING A PIRATE HAT.

CLASS 16—PAPER GOODS AND PRINTED MATTER

FOR ANNUAL YEARBOOKS, NOTEBOOKS, LOOSE-LEAF BINDERS, WRITING PAPER AND ENVELOPES, DESK PADS, NOTEPAD HOLDERS, LETTER OPENERS, PENCIL CUPS, PLASTIC CONTAINERS FOR PAPER CLIPS, APPOINTMENT BOOKS, ADDRESS BOOKS, CALENDARS, PROTECTIVE BINDERS FOR DIPLOMAS, PENS, PEN AND PENCIL SETS, BOOK ENDS, LAP BOARD FOR HOLDING BOOKS AND PAPER, DECALS, POSTCARDS, BUMPER STICKERS, AND PAPER NAPKINS (U.S. CLS. 2, 5, 22, 23, 29, 37, 38 AND 50).
FIRST USE 12-31-2004; IN COMMERCE 12-31-2004.

CLASS 25—CLOTHING

FOR SLEEP SHIRTS, ROBES, SHIRTS, T-SHIRTS, TENNIS SHIRTS, TOPS, JERSEYS, SWEAT SHIRTS, SWEAT PANTS, WARM-UP SUITS, SWEATERS, BLAZERS, JACKETS, VESTS, SHORTS, BABY PANTS, CLOTH BABY BIBS, TIES, SHOES, MITTENS, SCARVES, SOCKS, CAPS AND VISORS (U.S. CLS. 22 AND 39).
FIRST USE 12-31-2004; IN COMMERCE 12-31-2004.
LESLIE RICHARDS, EXAMINING ATTORNEY

CLASS 16—PAPER GOODS AND PRINTED MATTER

FOR PUBLICATIONS, NAMELY, MAGAZINES AND NEWLETTERS IN THE FIELD OF ACCOUNTING AND FINANCIAL SERVICES AND BUSINESS TOPICS OF INTEREST TO PROFESSIONALS IN THE ACCOUNTING AND FINANCIAL SERVICES FIELDS (U.S. CLS. 2, 5, 22, 23, 29, 37, 38 AND 50).

CLASS 35—ADVERTISING AND BUSINESS

FOR ASSOCIATION SERVICES, NAMELY, PROMOTING THE INTERESTS OF CERTIFIED PUBLIC ACCOUNTANTS AND OTHER PROFESSIONALS IN THE FIELD OF ACCOUNTING AND FINANCIAL SERVICES (U.S. CLS. 100, 101 AND 102).

CLASS 41—EDUCATION AND ENTERTAINMENT

FOR EDUCATIONAL SERVICES, NAMELY, PROVIDING COURSES, CLASSES, CONFERENCES AND FORUMS IN THE FIELDS OF ACCOUNTING AND FINANCIAL SERVICES AND BUSINESS TOPICS OF INTEREST TO PROFESSIONALS IN THE ACCOUNTING AND FINANCIAL SERVICES FIELDS (U.S. CLS. 100, 101 AND 107).
LINDSEY RUBIN, EXAMINING ATTORNEY

SN 77-157,854. WALDMAN, PARRI, OVERLAND PARK, KS.
FILED 4-16-2007.

SHARE THE YOGA

THE MARK CONSISTS OF STANDARD CHARACTERS WITHOUT CLAIM TO ANY PARTICULAR FONT, STYLE, SIZE, OR COLOR.

NO CLAIM IS MADE TO THE EXCLUSIVE RIGHT TO USE "YOGA", APART FROM THE MARK AS SHOWN.

CLASS 25—CLOTHING

FOR SHIRTS, TOPS, CAMISOLES, PANTS, SHORTS, HATS, CAPS, HEADBANDS, SCARVES, SOCKS, AND SHOES (U.S. CLS. 22 AND 39).
FIRST USE 2-25-2007; IN COMMERCE 3-5-2007.

CLASS 41—EDUCATION AND ENTERTAINMENT

FOR YOGA INSTRUCTION AND AYURVEDA PHYSICAL FITNESS INSTRUCTION FOR GROUPS AND INDIVIDUALS (U.S. CLS. 100, 101 AND 107).

FIRST USE 2-25-2007; IN COMMERCE 3-5-2007.
JUDITH HELFMAN, EXAMINING ATTORNEY

CLASS 41—EDUCATION AND ENTERTAINMENT

FOR VIDEO SIGN LANGUAGE INTERPRETATION SERVICES FOR THE HEARING IMPAIRED (U.S. CLS. 100, 101 AND 107).

HEATHER THOMPSON, EXAMINING ATTORNEY

SN 77-157,884. GLOBAL COMMUNICATIONS, INC., BEAUMONT, TX. FILED 4-16-2007.



THE MARK CONSISTS OF A SPHERE WITH THREE PROJECTING RIDGES WRAPING AROUND THE SPHERE AND AN O PARTIALLY SUPERIMPOSED OVER THE SPHERE AND PASSING THROUGH TWO OF THE PROJECTING RIDGES.

CLASS 38—COMMUNICATION

FOR CAPTIONED TELEPHONE SERVICES FOR INDIVIDUALS WHO ARE DEAF, HARD OF HEARING OR SPEECH IMPAIRED (U.S. CLS. 100, 101 AND 104).

CLASS 41—EDUCATION AND ENTERTAINMENT

FOR VIDEO SIGN LANGUAGE INTERPRETATION SERVICES FOR THE HEARING IMPAIRED (U.S. CLS. 100, 101 AND 107).

HEATHER THOMPSON, EXAMINING ATTORNEY

SN 77-157,889. GLOBAL COMMUNICATIONS, INC., BEAUMONT, TX. FILED 4-16-2007.

GLOBAL ORBIT MATRIX

THE MARK CONSISTS OF STANDARD CHARACTERS WITHOUT CLAIM TO ANY PARTICULAR FONT, STYLE, SIZE, OR COLOR.

CLASS 38—COMMUNICATION

FOR CAPTIONED TELEPHONE SERVICES FOR INDIVIDUALS WHO ARE DEAF, HARD OF HEARING OR SPEECH IMPAIRED (U.S. CLS. 100, 101 AND 104).

SN 77-157,942. JAMES MCBRIDE, CHICAGO, IL. FILED 4-16-2007.

Mr. Skin

THE MARK CONSISTS OF STANDARD CHARACTERS WITHOUT CLAIM TO ANY PARTICULAR FONT, STYLE, SIZE, OR COLOR.

OWNER OF U.S. REG. NOS. 2,318,435 AND 3,060,965.

THE NAME MR. SKIN IDENTIFIES A LIVING INDIVIDUAL WHOSE CONSENT IS OF RECORD.

CLASS 9—ELECTRICAL AND SCIENTIFIC APPARATUS

FOR VIDEO GAME SOFTWARE; PRE-RECORDED SOUND AND VIDEO RECORDINGS FEATURING NEWS AND COMMENTARY REGARDING MOTION PICTURES AND CELEBRITIES (U.S. CLS. 21, 23, 26, 36 AND 38).

CLASS 18—LEATHER GOODS

FOR SPORTS BAGS, FANNY PACKS, BACKPACKS (U.S. CLS. 1, 2, 3, 22 AND 41).

CLASS 21—HOUSEWARES AND GLASS

FOR MUGS (U.S. CLS. 2, 13, 23, 29, 30, 33, 40 AND 50).

CLASS 25—CLOTHING

FOR CLOTHING AND APPAREL, NAMELY, SHIRTS, SKIRTS, PANTS, TANK TOPS, UNDERWEAR, LINGERIE, BELTS, SOCKS, HATS (U.S. CLS. 22 AND 39).

CLASS 28—TOYS AND SPORTING GOODS

FOR TOYS AND GAMES, NAMELY, BOARD GAMES, TRIVIA GAMES; ACTION FIGURES (U.S. CLS. 22, 23, 38 AND 50).

KATHLEEN M. VANSTON, EXAMINING ATTORNEY

SN 77-158,086. EASTWOOD, LLOYD, GRANDBURY, TX. FILED 4-16-2007.

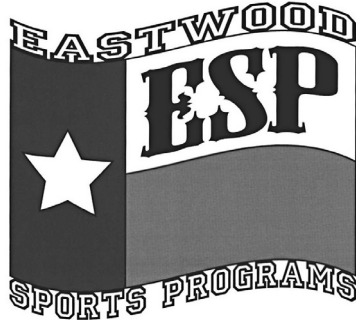

NO CLAIM IS MADE TO THE EXCLUSIVE RIGHT TO USE "SPORTS PROGRAMS", APART FROM THE MARK AS SHOWN.

CLASS 40—MATERIAL TREATMENT

FOR PRINTING SERVICES (U.S. CLS. 100, 103 AND 106).

CLASS 42—SCIENTIFIC AND COMPUTER SERVICES

FOR GRAPHIC DESIGN SERVICES (U.S. CLS. 100 AND 101).
JUDITH HELFMAN, EXAMINING ATTORNEY

SN 77-158,184. UNICA CORPORATION, MIAMI, FL. FILED 4-17-2007.

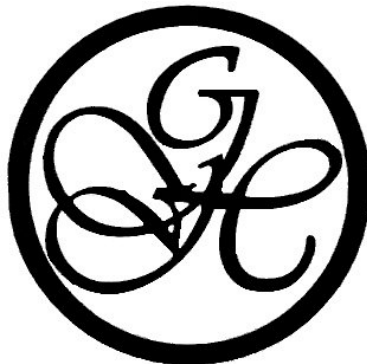

THE MARK CONSISTS OF THE LETTERS G AND H INSIDE OF A CIRCLE IN A STYLIZED FORM.

CLASS 3—COSMETICS AND CLEANING PREPARATIONS

FOR BODY CREAM (U.S. CLS. 1, 4, 6, 50, 51 AND 52).
FIRST USE 10-30-2001; IN COMMERCE 10-30-2001.

CLASS 5—PHARMACEUTICALS

FOR POWDERED NUTRITIONAL SUPPLEMENT DRINK MIX (U.S. CLS. 6, 18, 44, 46, 51 AND 52).
FIRST USE 3-31-2006; IN COMMERCE 3-31-2006.

CLASS 30—STAPLE FOODS

FOR TEA (U.S. CL. 46).
FIRST USE 1-31-2006; IN COMMERCE 1-31-2006.

CLASS 35—ADVERTISING AND BUSINESS

FOR ONLINE RETAIL STORE SERVICES FEATURING MASSAGE THERAPY RELATED PRODUCTS (U.S. CLS. 100, 101 AND 102).
FIRST USE 9-30-2006; IN COMMERCE 9-30-2006.
JUDITH HELFMAN, EXAMINING ATTORNEY

SN 77-158,207. EMERIKA, INC, DBA DIGI CRAFT, ORLANDO, FL. FILED 4-17-2007.



THE MARK CONSISTS OF ASTERISK ABOVE THE 2ND LETTER "I" IN THE WORD DIGI.

CLASS 35—ADVERTISING AND BUSINESS

FOR ADVERTISING AGENCIES; ADVERTISING AGENCIES, NAMELY, PROMOTING THE GOODS AND SERVICES OF OTHERS; ADVERTISING AGENCIES, NAMELY, PROMOTING THE SERVICES OF VARIOUS INDUSTRIES THROUGH THE DISTRIBUTION OF PRINTED AND AUDIO PROMOTIONAL MATERIALS AND BY RENDERING SALES PROMOTION ADVICE; DIRECT MARKETING ADVERTISING FOR OTHERS; MEDIA BUYING ADVICE, NAMELY, ADVISING THE CLIENT HOW MUCH MEDIA TIME, AND AT WHAT TIMES THE CLIENT SHOULD BE PURCHASING ADVERTISING; ADVERTISING AND PUBLICITY SERVICES, NAMELY, PROMOTING THE GOODS, SERVICES, BRAND IDENTITY AND COMMERCIAL INFORMATION AND NEWS OF THIRD PARTIES THROUGH PRINT, AUDIO, VIDEO, DIGITAL AND ON-LINE MEDIUM; DESIGN OF ADVERTISING MATERIALS FOR OTHERS; ON-LINE ADVERTISING AND MARKETING SERVICES; PROVIDING A WEB SITE WHICH FEATURES ADVERTISEMENTS FOR THE GOODS AND SERVICES OF OTHERS ON A GLOBAL COMPUTER NETWORK (U.S. CLS. 100, 101 AND 102).
FIRST USE 11-1-2005; IN COMMERCE 11-1-2005.

CLASS 42—SCIENTIFIC AND COMPUTER SERVICES

FOR COMPUTER SERVICES, NAMELY, DESIGNING AND IMPLEMENTING WEB SITES FOR OTHERS; COMPUTER SERVICES, NAMELY MONITORING, TESTING, ANALYZING, AND REPORTING ON THE INTERNET TRAFFIC CONTROL AND CONTENT CONTROL OF THE WEBSITES OF OTHERS; COMPUTER SERVICES, NAMELY, CREATING AND MAINTAINING WEB SITES FOR OTHERS; COMPUTER SERVICES, NAMELY, MONITORING THE WEBSITES OF OTHERS TO IMPROVE SCALABILITY AND PERFORMANCE OF WEBSITES OF OTHERS; DESIGN, CREATION, HOSTING, MAINTENANCE OF WEBSITES FOR OTHERS; DESIGNING WEBSITES FOR ADVERTISING PURPOSES (U.S. CLS. 100 AND 101).
FIRST USE 11-1-2005; IN COMMERCE 11-1-2005.
FRANK LATTUCA, EXAMINING ATTORNEY

SN 77-158,273. PRODUCT DESIGN, INC., RALEIGH, NC. FILED 4-17-2007.

SN 77-158,467. SHOPTEXT, INC., NEW YORK, NY. FILED 4-17-2007.

Mighty Signs

THE MARK CONSISTS OF STANDARD CHARACTERS WITHOUT CLAIM TO ANY PARTICULAR FONT, STYLE, SIZE, OR COLOR.

NO CLAIM IS MADE TO THE EXCLUSIVE RIGHT TO USE SIGNS, APART FROM THE MARK AS SHOWN.

CLASS 9—ELECTRICAL AND SCIENTIFIC APPARATUS

FOR ILLUMINATED, NON-METAL SIGNS, INCLUDING MOLDED PLASTIC SIGNS, SIGNAGE PANELS, AND BLANKS (U.S. CLS. 21, 23, 26, 36 AND 38).

FIRST USE 3-28-2007; IN COMMERCE 3-28-2007.

CLASS 19—NON-METALLIC BUILDING MATERIALS

FOR NON-ILLUMINATED, NON-MECHANICAL, NON-METAL SIGNS, INCLUDING MOLDED PLASTIC SIGNS, SIGNAGE PANELS, AND BLANKS (U.S. CLS. 1, 12, 33 AND 50).

FIRST USE 3-28-2007; IN COMMERCE 3-28-2007.

BRIAN PINO, EXAMINING ATTORNEY

SN 77-158,382. HELEN OF TROY LIMITED, ST. MICHAEL, BARBADOS, FILED 4-17-2007.

Beauty Skins

THE MARK CONSISTS OF STANDARD CHARACTERS WITHOUT CLAIM TO ANY PARTICULAR FONT, STYLE, SIZE, OR COLOR.

NO CLAIM IS MADE TO THE EXCLUSIVE RIGHT TO USE "BEAUTY", APART FROM THE MARK AS SHOWN.

CLASS 9—ELECTRICAL AND SCIENTIFIC APPARATUS

FOR ELECTRIC HAIR STRAIGHTENING IRONS; ELECTRIC HAND-HELD HAIR STYLING IRONS (U.S. CLS. 21, 23, 26, 36 AND 38).

FIRST USE 10-1-2006; IN COMMERCE 10-1-2006.

CLASS 11—ENVIRONMENTAL CONTROL APPARATUS

FOR HAND-HELD ELECTRIC HAIR DRYERS (U.S. CLS. 13, 21, 23, 31 AND 34).

FIRST USE 10-1-2006; IN COMMERCE 10-1-2006.

LAURA HAMMEL, EXAMINING ATTORNEY

SHOPTEXT

THE MARK CONSISTS OF STANDARD CHARACTERS WITHOUT CLAIM TO ANY PARTICULAR FONT, STYLE, SIZE, OR COLOR.

CLASS 35—ADVERTISING AND BUSINESS

FOR PROMOTING THE GOODS AND SERVICES OF OTHERS BY MEANS OF OPERATING A SHOPPING SERVICE FROM A MOBILE PHONE USING TEXT MESSAGING (U.S. CLS. 100, 101 AND 102).

FIRST USE 11-3-2006; IN COMMERCE 11-3-2006.

CLASS 36—INSURANCE AND FINANCIAL

FOR PROCESSING OF FINANCIAL TRANSACTIONS FROM A MOBILE PHONE USING TEXT MESSAGING (U.S. CLS. 100, 101 AND 102).

FIRST USE 11-3-2006; IN COMMERCE 11-3-2006.

DEZMONA MIZELLE, EXAMINING ATTORNEY

SN 77-158,483. WILMINGTON TRUST CORPORATION, WILMINGTON, DE. FILED 4-17-2007.

WAVEIT!

THE MARK CONSISTS OF STANDARD CHARACTERS WITHOUT CLAIM TO ANY PARTICULAR FONT, STYLE, SIZE, OR COLOR.

CLASS 9—ELECTRICAL AND SCIENTIFIC APPARATUS

FOR CREDIT CARDS AND DEBIT CARDS FEATURING MEMORY CHIPS (U.S. CLS. 21, 23, 26, 36 AND 38).

CLASS 36—INSURANCE AND FINANCIAL

FOR CREDIT AND DEBIT CARD SERVICES (U.S. CLS. 100, 101 AND 102).

DAVID C. REIHNER, EXAMINING ATTORNEY

SN 77-158,546. UNIVERSITY OF NORTH CAROLINA AT WILMINGTON, WILMINGTON, NC. FILED 4-17-2007.

MARBIONC

THE MARK CONSISTS OF STANDARD CHARACTERS WITHOUT CLAIM TO ANY PARTICULAR FONT, STYLE, SIZE, OR COLOR.

CLASS 41—EDUCATION AND ENTERTAINMENT

FOR EDUCATIONAL SERVICES, NAMELY DEVELOPING AND DISSEMINATING EDUCATIONAL MATERIALS AND ARRANGING AND CONDUCTING EXHIBITS, SEMINARS AND CONFERENCES IN THE FIELD OF MARINE BIOTECHNOLOGY; EDUCATION SERVICES IN THE NATURE OF COURSES AT THE UNIVERSITY LEVEL (U.S. CLS. 100, 101 AND 107).

FIRST USE 8-9-2004; IN COMMERCE 8-9-2004.

CLASS 42—SCIENTIFIC AND COMPUTER SERVICES

FOR SCIENTIFIC RESEARCH SERVICES IN THE FIELD OF MARINE BIOTECHNOLOGY; DEVELOPMENT OF NEW PRODUCTS AND TECHNOLOGY FOR OTHERS IN THE FIELD OF MARINE BIOTECHNOLOGY (U.S. CLS. 100 AND 101).

FIRST USE 8-9-2004; IN COMMERCE 8-9-2004.

CLASS 44—MEDICAL, BEAUTY AND AGRICULTURAL SERVICES

FOR AQUACULTURE SERVICES, NAMELY THE CULTIVATION AND BREEDING OF MARINE LIFE (U.S. CLS. 100 AND 101).

FIRST USE 8-9-2004; IN COMMERCE 8-9-2004.
ROBERT LAVACHE, EXAMINING ATTORNEY

SN 77-158,557. FLIPPIN' OUT ENTERPRISES, NEWBURY, MA. FILED 4-17-2007.



NO CLAIM IS MADE TO THE EXCLUSIVE RIGHT TO USE "NEWBURYPORT", APART FROM THE MARK AS SHOWN.

THE COLOR(S) LIGHT PINK, PINK, GREEN, AND PERIWINKLE IS/ARE CLAIMED AS A FEATURE OF THE MARK.

THE MARK CONSISTS OF A PAIR OF FLIP FLOPS WITH GREEN FOOT BEDS, PERIWINKLE SOLES AND LIGHT PINK STRAPS. THE FLIP FLOPS APPEAR TO THE LEFT OF THE WORDING. THE ENTIRE BACKGROUND IS PINK WITH STYLIZED PERIWINKLE LETTERING THAT STATES "FLIPPIN' OUT NEWBURYPORT". THERE IS A PERIWINKLE FRAME THAT SURROUNDS THE ENTIRE DESIGN. BEYOND THIS FRAME THERE IS ANOTHER GREEN FRAME. BEYOND THIS, THERE IS ANOTHER PERIWINKLE FRAME. THIS PERIWINKLE FRAME IS THE OUTERMOST PART OF THE ENTIRE DESIGN. THE FLIP FLOPS OCCUPY THE LEFT SIDE OF THE DESIGN. "FLIPPIN' OUT" OCCUPIES THE MIDDLE AND RIGHT PORTIONS AND NEWBURYPORT IS CENTERED DIRECTLY BELOW "FLIPPIN' OUT".

CLASS 18—LEATHER GOODS

FOR BAGS AND HOLDALLS FOR SPORTS CLOTHING; BEACH BAGS; BOOK BAGS; CARRY-ALL BAGS; CLUTCH BAGS; SHOULDER BAGS; TOTE BAGS; ALL-PURPOSE CARRYING BAGS; DIAPER BAGS; EVENING HANDBAGS; HANDBAGS (U.S. CLS. 1, 2, 3, 22 AND 41).

CLASS 25—CLOTHING

FOR BERMUDA SHORTS; BOARD SHORTS; BOXER SHORTS; CAMP SHIRTS; DRESS SHIRTS; FLEECE SHORTS; GOLF SHIRTS; KNIT SHIRTS; PIQUE SHIRTS; POLO SHIRTS; SHIRTS; SHORT-SLEEVED OR LONG-SLEEVED T-SHIRTS; SHORT-SLEEVED SHIRTS; SPORT SHIRTS; SWEAT SHIRTS; T-SHIRTS; WALKING SHORTS; FLIP FLOPS (U.S. CLS. 22 AND 39).

KATHERINE E. HALMEN, EXAMINING ATTORNEY

SN 77-158,563. METROCONNECTIONS, INC., MINNEAPOLIS, MN. FILED 4-17-2007.

ATTEND-ESOURCE

THE MARK CONSISTS OF STANDARD CHARACTERS WITHOUT CLAIM TO ANY PARTICULAR FONT, STYLE, SIZE, OR COLOR.

CLASS 35—ADVERTISING AND BUSINESS

FOR CONSULTING SERVICES FOR PLANNING, ORGANIZING, AND IMPLEMENTING MEETINGS, BUSINESS CONFERENCES, CONVENTIONS, AND TRADE SHOWS (U.S. CLS. 100, 101 AND 102).

CLASS 42—SCIENTIFIC AND COMPUTER SERVICES

FOR DEVELOPING, HOSTING, AND OPERATING WEBSITES FOR OTHERS, THAT ARE USED TO PROMOTE MEETINGS, BUSINESS CONFERENCES, CONVENTIONS, AND TRADE SHOWS, AND TO ENABLE PARTICIPANTS TO RECEIVE INFORMATION ABOUT, REGISTER FOR, AND PARTICIPATE IN, MEETINGS, BUSINESS CONFERENCES, CONVENTIONS, AND TRADE SHOWS (U.S. CLS. 100 AND 101).

JESSICA A. POWERS, EXAMINING ATTORNEY

SN 77-158,577. KOLCRAFT ENTERPRISES, INC., CHICAGO, IL. FILED 4-17-2007.

SHAPE YOUR STYLE

THE MARK CONSISTS OF STANDARD CHARACTERS WITHOUT CLAIM TO ANY PARTICULAR FONT, STYLE, SIZE, OR COLOR.

CLASS 12—VEHICLES

FOR BABY STROLLERS (U.S. CLS. 19, 21, 23, 31, 35 AND 44).

FIRST USE 4-0-2006; IN COMMERCE 11-0-2006.

CLASS 20—FURNITURE AND ARTICLES NOT OTHERWISE CLASSIFIED

FOR BASSINETS; PLAYPENS; CRIBS; HIGH CHAIRS; HIGH CHAIRS FOR BABIES (U.S. CLS. 2, 13, 22, 25, 32 AND 50).

FIRST USE 4-0-2006; IN COMMERCE 11-0-2006.

CLASS 28—TOYS AND SPORTING GOODS

FOR BABY SWINGS; INFANT SWINGS (U.S. CLS. 22, 23, 38 AND 50).
MICHELE SWAIN, EXAMINING ATTORNEY

CLASS 8—HAND TOOLS

FOR HAND-OPERATED CRIMPING COMPRESSION TOOLS FOR ATTACHING CONNECTORS TO WIRES AND CABLES (U.S. CLS. 23, 28 AND 44).

CLASS 9—ELECTRICAL AND SCIENTIFIC APPARATUS

FOR AUDIO AND VIDEO EQUIPMENT, NAMELY, INTERCONNECTING CABLES, CABLE CONNECTORS, TRANSFORMERS, SIGNAL CONVERTERS, AMPLIFIERS, ELECTRICAL PLUGS, SPEAKERS, STEREO TUNERS, AND RECEIVERS; COMPUTER CABLE CONNECTORS, CIRCUIT BOARDS FOR USE IN HOME ELECTRONIC DEVICES FOR ROUTING, PROCESSING AND CONVERSION OF VIDEO SIGNALS (U.S. CLS. 21, 23, 26, 36 AND 38).

DAVID H. STINE, EXAMINING ATTORNEY

SN 77-158,617. LOWSON, LINDA M., HUNTINGTON, NY.
FILED 4-17-2007.

CIVILIZATION TRENDS

THE MARK CONSISTS OF STANDARD CHARACTERS WITHOUT CLAIM TO ANY PARTICULAR FONT, STYLE, SIZE, OR COLOR.

NO CLAIM IS MADE TO THE EXCLUSIVE RIGHT TO USE "TRENDS", APART FROM THE MARK AS SHOWN.

SN 77-158,628. SCHWAN'S IP, LLC, MARSHALL, MN. FILED 4-17-2007.

CLASS 35—ADVERTISING AND BUSINESS

FOR BUSINESS CONSULTING AND INFORMATION SERVICES; BUSINESS MANAGEMENT CONSULTING AND ADVISORY SERVICES; BUSINESS MARKETING CONSULTING SERVICES; BUSINESS RESEARCH CONSULTATION; DEMOGRAPHIC CONSULTATION AND STUDIES; MARKET RESEARCH CONSULTATION; MARKET SEGMENTATION CONSULTATION; POLITICAL CONSULTANCY; BUSINESS RESEARCH AND SURVEYS; MARKET RESEARCH SERVICES; MARKET RESEARCH STUDIES; ARRANGING AND CONDUCTING BUSINESS CONFERENCES (U.S. CLS. 100, 101 AND 102).

CLASS 41—EDUCATION AND ENTERTAINMENT

FOR CONSULTATION IN THE FIELD OF K-12 EDUCATIONAL SYSTEMS; ARRANGING AND CONDUCTING EDUCATIONAL CONFERENCES; ARRANGING OF EXHIBITIONS, SEMINARS AND CONFERENCES; EDUCATION SERVICES, NAMELY, PROVIDING EDUCATIONAL CONFERENCES, SEMINARS, WORKSHOPS, AND CLASSES IN THE FIELDS OF SOCIAL AND CULTURAL TRENDS, DEMOGRAPHIC TRENDS, LIFESTYLE TRENDS, ECONOMIC TRENDS, POLITICAL TRENDS, BUSINESS TRENDS, INDUSTRY TRENDS, AND CONSUMER TRENDS; ENTERTAINMENT SERVICES, NAMELY, PROVIDING ON-LINE COMPUTER GAMES; MOBILE MEDIA AND ENTERTAINMENT SERVICES IN THE NATURE OF CONTENT PREPARATION (U.S. CLS. 100, 101 AND 107).

MICHAEL TANNER, EXAMINING ATTORNEY



OWNER OF U.S. REG. NOS. 2,173,137, 3,046,569 AND OTHERS.

NO CLAIM IS MADE TO THE EXCLUSIVE RIGHT TO USE "BUILD & BAKE", APART FROM THE MARK AS SHOWN.

THE MARK CONSISTS OF MISCELLANEOUS DESIGN WITH AN OVERALL RECTANGULAR SHAPE AND INCLUDES A TWO SEPARATE BANNERS AND PALM OR FERN BRANCHES.

CLASS 29—MEATS AND PROCESSED FOODS

FOR BACON; PEPPERONI; CHEESE (U.S. CL. 46).
FIRST USE 7-1-2006; IN COMMERCE 7-1-2006.

CLASS 30—STAPLE FOODS

FOR PIZZA CRUST; PIZZA SAUCE (U.S. CL. 46).
FIRST USE 7-1-2006; IN COMMERCE 7-1-2006.
GISELLE AGOSTO, EXAMINING ATTORNEY

SN 77-158,625. GORDON J. GOW TECHNOLOGIES, INC.,
ORLANDO, FL. FILED 4-17-2007.

JOE KNOWS CABLE

THE MARK CONSISTS OF STANDARD CHARACTERS WITHOUT CLAIM TO ANY PARTICULAR FONT, STYLE, SIZE, OR COLOR.

SN 77-158,791. YOGIZMO YOGURT COMPANY, INC.,
SCOTTS VALLEY, CA. FILED 4-17-2007.

YOGIZMO

THE MARK CONSISTS OF STANDARD CHARACTERS WITHOUT CLAIM TO ANY PARTICULAR FONT, STYLE, SIZE, OR COLOR.

CLASS 30—STAPLE FOODS

FOR FROZEN YOGURT; FROZEN YOGURT MIXES (U.S. CL. 46).

CLASS 35—ADVERTISING AND BUSINESS

FOR RESTAURANT FRANCHISING (U.S. CLS. 100, 101 AND 102).
AISHA CLARKE, EXAMINING ATTORNEY

SN 77-158,928. LORD OF THE WIND FILMS, LLC, CHEHALIS, WA. FILED 4-17-2007.

SN 77-158,804. THE NEXT SOLUTIONS, INC., YORBA LINDA, CA. FILED 4-17-2007.

THE NEXT UP

THE MARK CONSISTS OF STANDARD CHARACTERS WITHOUT CLAIM TO ANY PARTICULAR FONT, STYLE, SIZE, OR COLOR.

CLASS 9—ELECTRICAL AND SCIENTIFIC APPARATUS

FOR COMPUTER SOFTWARE FOR MANAGING SALESFORCE, INCLUDING ASSIGNING SALESPERSONS TO CUSTOMERS AND TRACKING SALESPERSON INTERACTIONS WITH CUSTOMERS, AND FOR USE IN MAINTAINING AND MANAGING CUSTOMER RELATIONSHIPS (U.S. CLS. 21, 23, 26, 36 AND 38).

CLASS 42—SCIENTIFIC AND COMPUTER SERVICES

FOR PROVIDING ON-LINE NON-DOWNLOADABLE SOFTWARE FOR MANAGING SALESFORCE, INCLUDING ASSIGNING SALESPERSONS TO CUSTOMERS AND TRACKING SALESPERSON INTERACTIONS WITH CUSTOMERS, AND FOR USE IN MAINTAINING AND MANAGING CUSTOMER RELATIONSHIPS (U.S. CLS. 100 AND 101).
KATHRYN COWARD, EXAMINING ATTORNEY

SN 77-158,838. ROBERTS, JERRY C., OKLAHOMA CITY, OK. AND ROBERTS, CHLOE A., OKLAHOMA CITY, OK. AND ROBERTS JR., JOHN C., OKLAHOMA CITY, OK. FILED 4-17-2007.

RIP DOG

THE MARK CONSISTS OF STANDARD CHARACTERS WITHOUT CLAIM TO ANY PARTICULAR FONT, STYLE, SIZE, OR COLOR.

NO CLAIM IS MADE TO THE EXCLUSIVE RIGHT TO USE DOG, APART FROM THE MARK AS SHOWN.

CLASS 16—PAPER GOODS AND PRINTED MATTER

FOR PLASTIC BAGS FOR DISPOSING OF PET WASTE (U.S. CLS. 2, 5, 22, 23, 29, 37, 38 AND 50).

CLASS 21—HOUSEWARES AND GLASS

FOR SCOOPS FOR DISPOSING OF PET WASTE (U.S. CLS. 2, 13, 23, 29, 30, 33, 40 AND 50).
JORDAN BAKER, EXAMINING ATTORNEY

DOCTOR QUANTUM

THE MARK CONSISTS OF STANDARD CHARACTERS WITHOUT CLAIM TO ANY PARTICULAR FONT, STYLE, SIZE, OR COLOR.

CLASS 25—CLOTHING

FOR SHIRTS, JACKETS, PANTS, HATS, AND SHOES (U.S. CLS. 22 AND 39).

CLASS 41—EDUCATION AND ENTERTAINMENT

FOR PUBLICATION OF BOOKS, MAGAZINES, ALMANACS AND JOURNALS PERTAINING TO QUANTUM PHYSICS, SPIRITUALITY AND NEW AGE CULTURE (U.S. CLS. 100, 101 AND 107).
GISELLE AGOSTO, EXAMINING ATTORNEY

SN 77-158,931. TALBO, LAURIE F, HAGATNA, GUAM, FILED 4-17-2007.

Ai Adai

THE MARK CONSISTS OF STANDARD CHARACTERS WITHOUT CLAIM TO ANY PARTICULAR FONT, STYLE, SIZE, OR COLOR.

THE FOREIGN WORDING IN THE MARK TRANSLATES INTO ENGLISH AS OH MY GOSH.

CLASS 16—PAPER GOODS AND PRINTED MATTER

FOR STICKERS (U.S. CLS. 2, 5, 22, 23, 29, 37, 38 AND 50).

CLASS 40—MATERIAL TREATMENT

FOR IMPRINTING MESSAGES ON WEARING APPAREL, ACCESSORIES AND MUGS (U.S. CLS. 100, 103 AND 106).
MICHAEL WEBSTER, EXAMINING ATTORNEY

SN 77-158,980. PELIKAN TECHNOLOGIES, INC., PALO ALTO, CA. FILED 4-17-2007.

PELIKAN TECHNOLOGIES

THE MARK CONSISTS OF STANDARD CHARACTERS WITHOUT CLAIM TO ANY PARTICULAR FONT, STYLE, SIZE, OR COLOR.

OWNER OF U.S. REG. NO. 3,139,705.

NO CLAIM IS MADE TO THE EXCLUSIVE RIGHT TO USE "TECHNOLOGIES", APART FROM THE MARK AS SHOWN.

CLASS 5—PHARMACEUTICALS

FOR MEDICAL TEST KITS FOR SELF-MONITORING OF DIABETES, COMPRISED PRIMARILY OF DIAGNOSTIC REAGENTS, TEST STRIPS AND LANCETS; BLOOD GLUCOSE TEST STRIPS FOR DIAGNOSIS, TESTING, AND MONITORING OF DIABETES; DIAGNOSTIC REAGENTS FOR CLINICAL OR MEDICAL LABORATORY OR HOME USE FOR THE DIAGNOSIS, TESTING AND MONITORING OF DIABETES (U.S. CLS. 6, 18, 44, 46, 51 AND 52).

CLASS 10—MEDICAL APPARATUS

FOR MEDICAL DEVICES FOR TESTING AND MONITORING OF DIABETES, NAMELY, BLOOD GLUCOSE MONITORS, BLOOD GLUCOSE TESTING METERS, AND BLOOD GLUCOSE TESTING DEVICES IN THE NATURE OF LANCETS, AUTOMATIC LANCETS, MECHANICAL LANCETS, ELECTRONIC LANCETS, ELECTRO-MECHANICAL LANCETS AND ELECTRONICALLY CONTROLLED LANCETS SEPARATELY OR INTEGRATED INTO BLOOD GLUCOSE MONITORS OR METERS (U.S. CLS. 26, 39 AND 44).

DEIRDRE ROBERTSON, EXAMINING ATTORNEY

SN 77-158,992. PELIKAN TECHNOLOGIES, INC., PALO ALTO, CA. FILED 4-17-2007.



OWNER OF U.S. REG. NO. 3,139,705.

NO CLAIM IS MADE TO THE EXCLUSIVE RIGHT TO USE "TECHNOLOGIES", APART FROM THE MARK AS SHOWN.

THE MARK CONSISTS OF AN ABSTRACT STYLIZATION OF A PELICAN'S EYE AND THE LOWER PART OF A PELICAN'S BEAK, AND THE WORDING PELIKAN TECHNOLOGIES SEPARATED BY A SHADED OVAL BETWEEN THE TWO WORDS.

CLASS 5—PHARMACEUTICALS

FOR MEDICAL TEST KITS FOR SELF-MONITORING OF DIABETES, COMPRISED PRIMARILY OF DIAGNOSTIC REAGENTS, TEST STRIPS AND LANCETS; BLOOD GLUCOSE TEST STRIPS FOR DIAGNOSIS, TESTING, AND MONITORING OF DIABETES; DIAGNOSTIC REAGENTS FOR CLINICAL OR MEDICAL LABORATORY OR HOME USE FOR THE DIAGNOSIS, TESTING AND MONITORING OF DIABETES (U.S. CLS. 6, 18, 44, 46, 51 AND 52).

CLASS 10—MEDICAL APPARATUS

FOR MEDICAL DEVICES FOR TESTING AND MONITORING OF DIABETES, NAMELY, BLOOD GLUCOSE MONITORS, BLOOD GLUCOSE TESTING METERS, AND BLOOD GLUCOSE TESTING DEVICES IN THE NATURE OF LANCETS, AUTOMATIC LANCETS, MECHANICAL LANCETS, ELECTRONIC LANCETS, ELECTRO-MECHANICAL LANCETS AND ELECTRONICALLY CONTROLLED LANCETS SEPARATELY OR INTEGRATED INTO BLOOD GLUCOSE MONITORS OR METERS (U.S. CLS. 26, 39 AND 44).

DEIRDRE ROBERTSON, EXAMINING ATTORNEY

SN 77-159,003. PELIKAN TECHNOLOGIES, INC., PALO ALTO, CA. FILED 4-17-2007.

PELIKAN SUN

THE MARK CONSISTS OF STANDARD CHARACTERS WITHOUT CLAIM TO ANY PARTICULAR FONT, STYLE, SIZE, OR COLOR.

OWNER OF U.S. REG. NO. 3,139,705.

CLASS 5—PHARMACEUTICALS

FOR MEDICAL TEST KITS FOR SELF-MONITORING OF DIABETES, COMPRISED PRIMARILY OF DIAGNOSTIC REAGENTS, TEST STRIPS AND LANCETS; BLOOD GLUCOSE TEST STRIPS FOR DIAGNOSIS, TESTING, AND MONITORING OF DIABETES; DIAGNOSTIC REAGENTS FOR CLINICAL OR MEDICAL LABORATORY OR HOME USE FOR THE DIAGNOSIS, TESTING AND MONITORING OF DIABETES (U.S. CLS. 6, 18, 44, 46, 51 AND 52).

CLASS 10—MEDICAL APPARATUS

FOR MEDICAL DEVICES FOR TESTING AND MONITORING OF DIABETES, NAMELY, BLOOD GLUCOSE MONITORS, BLOOD GLUCOSE TESTING METERS, AND BLOOD GLUCOSE TESTING DEVICES IN THE NATURE OF LANCETS, AUTOMATIC LANCETS, MECHANICAL LANCETS, ELECTRONIC LANCETS, ELECTRO-MECHANICAL LANCETS AND ELECTRONICALLY CONTROLLED LANCETS SEPARATELY OR INTEGRATED INTO BLOOD GLUCOSE MONITORS OR METERS (U.S. CLS. 26, 39 AND 44).

DEIRDRE ROBERTSON, EXAMINING ATTORNEY

SN 77-159,013. PELIKAN TECHNOLOGIES, INC., PALO ALTO, CA. FILED 4-17-2007.

ENABLING TECHNOLOGIES FOR DIAGNOSTICS

THE MARK CONSISTS OF STANDARD CHARACTERS WITHOUT CLAIM TO ANY PARTICULAR FONT, STYLE, SIZE, OR COLOR.

OWNER OF U.S. REG. NO. 3,124,169.

CLASS 5—PHARMACEUTICALS

FOR MEDICAL TEST KITS FOR SELF-MONITORING OF DIABETES, COMPRISED PRIMARILY OF DIAGNOSTIC REAGENTS, TEST STRIPS AND LANCETS; BLOOD GLUCOSE TEST STRIPS FOR DIAGNOSIS, TESTING, AND MONITORING OF DIABETES; DIAGNOSTIC REAGENTS FOR CLINICAL OR MEDICAL LABORATORY OR HOME USE FOR THE DIAGNOSIS, TESTING AND MONITORING OF DIABETES (U.S. CLS. 6, 18, 44, 46, 51 AND 52).

SN 77-159,244. REALTY PRESENTATIONS, INC., WILMINGTON, NC. FILED 4-18-2007.

HOW TO CHOOSE THE RIGHT PLACE**CLASS 10—MEDICAL APPARATUS**

FOR MEDICAL DEVICES FOR TESTING AND MONITORING OF DIABETES, NAMELY, BLOOD GLUCOSE MONITORS, BLOOD GLUCOSE TESTING METERS, AND BLOOD GLUCOSE TESTING DEVICES IN THE NATURE OF LANCETS, AUTOMATIC LANCETS, MECHANICAL LANCETS, ELECTRONIC LANCETS, ELECTRO-MECHANICAL LANCETS AND ELECTRONICALLY CONTROLLED LANCETS SEPARATELY OR INTEGRATED INTO BLOOD GLUCOSE MONITORS OR METERS (U.S. CLS. 26, 39 AND 44).
DEIRDRE ROBERTSON, EXAMINING ATTORNEY

THE MARK CONSISTS OF STANDARD CHARACTERS WITHOUT CLAIM TO ANY PARTICULAR FONT, STYLE, SIZE, OR COLOR.

CLASS 16—PAPER GOODS AND PRINTED MATTER

FOR PRINTED PUBLICATIONS, NAMELY, MAGAZINES FEATURING REAL ESTATE, HOMES, LAND AND REAL ESTATE RELATED SERVICES (U.S. CLS. 2, 5, 22, 23, 29, 37, 38 AND 50).

CLASS 36—INSURANCE AND FINANCIAL

FOR PROVIDING INFORMATION IN THE FIELD OF REAL ESTATE VIA AN ONLINE ELECTRONIC COMMUNICATIONS NETWORK (U.S. CLS. 100, 101 AND 102).

ALICE SUE CARRUTHERS, EXAMINING ATTORNEY

SN 77-159,229. REALTY PRESENTATIONS, INC., WILMINGTON, NC. FILED 4-18-2007.

IDEAL LIVING

SN 77-159,257. REALTY PRESENTATIONS, INC., WILMINGTON, NC. FILED 4-18-2007.

CHOOSE THE RIGHT PLACE

THE MARK CONSISTS OF STANDARD CHARACTERS WITHOUT CLAIM TO ANY PARTICULAR FONT, STYLE, SIZE, OR COLOR.

CLASS 16—PAPER GOODS AND PRINTED MATTER

FOR PRINTED PUBLICATIONS, NAMELY, MAGAZINES FEATURING REAL ESTATE, HOMES, LAND AND REAL ESTATE RELATED SERVICES (U.S. CLS. 2, 5, 22, 23, 29, 37, 38 AND 50).

THE MARK CONSISTS OF STANDARD CHARACTERS WITHOUT CLAIM TO ANY PARTICULAR FONT, STYLE, SIZE, OR COLOR.

CLASS 16—PAPER GOODS AND PRINTED MATTER

FOR PRINTED PUBLICATIONS, NAMELY, MAGAZINES FEATURING REAL ESTATE, HOMES, LAND AND REAL ESTATE RELATED SERVICES (U.S. CLS. 2, 5, 22, 23, 29, 37, 38 AND 50).

CLASS 35—ADVERTISING AND BUSINESS

FOR PROMOTING AND CONDUCTING TRADE SHOWS AND EXHIBITIONS IN THE FIELD OF REAL ESTATE (U.S. CLS. 100, 101 AND 102).

CLASS 36—INSURANCE AND FINANCIAL

FOR PROVIDING INFORMATION IN THE FIELD OF REAL ESTATE VIA AN ONLINE ELECTRONIC COMMUNICATIONS NETWORK (U.S. CLS. 100, 101 AND 102).

ALICE SUE CARRUTHERS, EXAMINING ATTORNEY

CLASS 36—INSURANCE AND FINANCIAL

FOR PROVIDING INFORMATION IN THE FIELD OF REAL ESTATE VIA AN ONLINE ELECTRONIC COMMUNICATIONS NETWORK (U.S. CLS. 100, 101 AND 102).

ALICE SUE CARRUTHERS, EXAMINING ATTORNEY

SN 77-159,475. RESOURCE GUIDES, INC., SAN ANTONIO, TX. FILED 4-18-2007.

Physicians' **ReSource** Guide

OWNER OF U.S. REG. NO. 2,192,235.
NO CLAIM IS MADE TO THE EXCLUSIVE RIGHT TO USE "GUIDE", APART FROM THE MARK AS SHOWN.
THE MARK CONSISTS OF THE WORD RESOURCE IN BLOCK LETTERS WITH A CAPITAL LETTER S AND A FIRST CAPITAL LETTER R PARTIALLY COVERED WITH A BLOCK LETTER PLUS SIGN, AND THE WORD PHYSICIANS' CENTERED ABOVE THE WORD RESOURCE AND THE WORD GUIDE CENTERED BELOW...
SEC. 2(F) AS TO PHYSICIANS' RESOURCE.

CLASS 16—PAPER GOODS AND PRINTED MATTER

FOR DIRECTORIES OF AREA PHYSICIANS, HEALTH SERVICES, AND LOCAL BUSINESSES (U.S. CLS. 2, 5, 22, 23, 29, 37, 38 AND 50).
FIRST USE 1-0-1997; IN COMMERCE 1-0-1997.

CLASS 35—ADVERTISING AND BUSINESS

FOR ADVERTISING SERVICES, NAMELY PROVIDING ADVERTISING SPACE IN A PERIODICAL (U.S. CLS. 100, 101 AND 102).
FIRST USE 1-0-1997; IN COMMERCE 1-0-1997.
GEOFFREY FOSDICK, EXAMINING ATTORNEY

SN 77-159,493. MADCITYHOMES.COM, LLC, MADISON, WI. FILED 4-18-2007.

Madcity Homes

THE MARK CONSISTS OF STANDARD CHARACTERS WITHOUT CLAIM TO ANY PARTICULAR FONT, STYLE, SIZE, OR COLOR.
NO CLAIM IS MADE TO THE EXCLUSIVE RIGHT TO USE "HOMES", APART FROM THE MARK AS SHOWN.

CLASS 35—ADVERTISING AND BUSINESS

FOR REAL ESTATE ADVERTISING SERVICES; REAL ESTATE MARKETING SERVICES IN THE FIELD OF RESIDENTIAL, CONDOMINIUM, RESIDENTIAL INCOME, VACANT LAND, AND COMMERCIAL REAL ESTATE PROPERTY; REAL ESTATE MARKETING SERVICES, NAMELY, ON-LINE SERVICES FEATURING TOURS OF RESIDENTIAL AND COMMERCIAL REAL ESTATE (U.S. CLS. 100, 101 AND 102).
FIRST USE 2-1-2004; IN COMMERCE 2-1-2004.

CLASS 36—INSURANCE AND FINANCIAL

FOR LAND ACQUISITION, NAMELY, REAL ESTATE BROKERAGE; PROVIDING INFORMATION IN THE FIELD OF REAL ESTATE VIA THE INTERNET; PROVIDING REAL ESTATE LISTINGS AND REAL ESTATE INFORMATION VIA THE INTERNET; REAL ESTATE AGENCIES; REAL ESTATE BROKERAGE; REAL ESTATE INVESTMENT; REAL ESTATE LISTING; REAL ESTATE MULTIPLE LISTING SERVICES; REAL ESTATE PROCUREMENT FOR OTHERS (U.S. CLS. 100, 101 AND 102).
FIRST USE 2-1-2004; IN COMMERCE 2-1-2004.
CYNTHIA SLOAN, EXAMINING ATTORNEY

SN 77-159,535. GEOPIER FOUNDATION COMPANY, INC., ATLANTA, GA. FILED 4-18-2007.

RAMPACT

THE MARK CONSISTS OF STANDARD CHARACTERS WITHOUT CLAIM TO ANY PARTICULAR FONT, STYLE, SIZE, OR COLOR.

CLASS 37—CONSTRUCTION AND REPAIR

FOR CONSTRUCTION OF CIVIL ENGINEERING STRUCTURES, NAMELY, FOUNDATIONS FOR BUILDINGS AND OTHER COMMERCIAL, INDUSTRIAL, RESIDENTIAL, AND TRANSPORTATION-RELATED STRUCTURES (U.S. CLS. 100, 103 AND 106).

CLASS 42—SCIENTIFIC AND COMPUTER SERVICES

FOR ENGINEERING AND DESIGN SERVICES FOR CONSTRUCTION OF CIVIL ENGINEERING STRUCTURES, NAMELY, STRUCTURAL FOUNDATIONS (U.S. CLS. 100 AND 101).
JENNIFER HETU, EXAMINING ATTORNEY

SN 77-159,755. THE STAYWELL COMPANY, YARDLEY, PA. FILED 4-18-2007.

STAYWELL RX

THE MARK CONSISTS OF STANDARD CHARACTERS WITHOUT CLAIM TO ANY PARTICULAR FONT, STYLE, SIZE, OR COLOR.
NO CLAIM IS MADE TO THE EXCLUSIVE RIGHT TO USE "RX", APART FROM THE MARK AS SHOWN.

CLASS 16—PAPER GOODS AND PRINTED MATTER

FOR PUBLICATIONS, NAMELY, MAGAZINES, BOOKLETS, NEWSLETTERS, PAMPHLETS AND CATALOGS RELATING TO HEALTH WELLNESS, NUTRITION, AND SELF-IMPROVEMENT (U.S. CLS. 2, 5, 22, 23, 29, 37, 38 AND 50).

CLASS 44—MEDICAL, BEAUTY AND AGRICULTURAL SERVICES

FOR PROVIDING INFORMATION VIA THE INTERNET AND ELECTRONIC MAIL RELATING TO HEALTH, WELLNESS, AND NUTRITION (U.S. CLS. 100 AND 101).

CLASS 45—PERSONAL AND LEGAL SERVICES

FOR PROVIDING INFORMATION VIA THE INTERNET RELATING TO SELF-IMPROVEMENT (U.S. CLS. 100 AND 101).

LAURA KOVALSKY, EXAMINING ATTORNEY

SN 77-159,807. ARIA WORLDWIDE S.L., BARCELONA, SPAIN, FILED 4-18-2007.

Olivianti

THE MARK CONSISTS OF STANDARD CHARACTERS WITHOUT CLAIM TO ANY PARTICULAR FONT, STYLE, SIZE, OR COLOR.

CLASS 3—COSMETICS AND CLEANING PREPARATIONS

FOR SKIN AND BODY TOPICAL LOTIONS, CREAMS AND OILS FOR COSMETIC USE (U.S. CLS. 1, 4, 6, 50, 51 AND 52).

CLASS 29—MEATS AND PROCESSED FOODS

FOR OLIVE OIL (U.S. CL. 46).
GEORGE LORENZO, EXAMINING ATTORNEY

SN 77-159,808. JONATHAN JOSEPH, INC., LOS ANGELES, CA. FILED 4-18-2007.

JONATHAN JOSEPH

THE MARK CONSISTS OF STANDARD CHARACTERS WITHOUT CLAIM TO ANY PARTICULAR FONT, STYLE, SIZE, OR COLOR.

THE NAME(S), PORTRAIT(S), AND/OR SIGNATURE(S) SHOWN IN THE MARK IDENTIFIES A LIVING INDIVIDUAL, WHOSE CONSENT(S) TO REGISTER IS MADE OF RECORD.

CLASS 3—COSMETICS AND CLEANING PREPARATIONS

FOR AFTER-SHAVE; ANTI-AGING CREAM; ANTI-PERSPIRANTS; ANTI-WRINKLE CREAMS; BABY OILS; BABY POWDERS; BATH BEADS; BATH CRYSTALS; BATH MILKS; BATH OILS; BATH POWDER; BODY POWDER; BODY SPRAYS; COLOGNE; COSMETICS; COTTON FOR COSMETIC PURPOSES; CUTICLE CREAM; DEPILATORIES; ESSENTIAL OILS; FACE AND BODY GLITTER; FACE CREAMS; FACIAL CLEANSERS; FACIAL WASHES; FOOT POWDER; GEL EYE MASKS; HAIR CARE PREPARATIONS; HAIR CONDITIONERS; HAIR CREAMS; HAIR DYES; HAIR GELS; HAIR MOUSSES; HAIR NOURISHERS; HAIR OILS; HAIR RELAXERS; HAIR RINSES; HAIR SHAM-POO; HAIR SPRAY; HAND LOTIONS; HAND SOAPS; INCENSE; MAKE-UP; MAKE-UP REMOVER; MASSAGE OILS; NAIL POLISH; NAIL POLISH REMOVERS; NON-MEDICATED FOOT CREAM; PERFUMES; POMADES; POTPOURRI; SHAVING CREAMS; SHAVING PREPARATIONS; SKIN AND BODY TOPICAL LOTIONS, CREAMS AND OILS FOR COSMETIC USE; SOAPS FOR BODY CARE; SUN BLOCK; SUNTANNING PREPARATIONS (U.S. CLS. 1, 4, 6, 50, 51 AND 52).

CLASS 44—MEDICAL, BEAUTY AND AGRICULTURAL SERVICES

FOR BEAUTY SALONS; HAIR CUTTING; HAIR STYLING; HAIRDRESSING SALONS; HAIRDRESSING SERVICES; HEALTH SPA SERVICES, NAMELY, COSMETIC BODY CARE SERVICES (U.S. CLS. 100 AND 101).

BARBARA BROWN, EXAMINING ATTORNEY

SN 77-159,813. THE STAYWELL COMPANY, YARDLEY, PA. FILED 4-18-2007.

STAYWELL MD

THE MARK CONSISTS OF STANDARD CHARACTERS WITHOUT CLAIM TO ANY PARTICULAR FONT, STYLE, SIZE, OR COLOR.

NO CLAIM IS MADE TO THE EXCLUSIVE RIGHT TO USE "MD", APART FROM THE MARK AS SHOWN.

CLASS 16—PAPER GOODS AND PRINTED MATTER

FOR PUBLICATIONS, NAMELY, MAGAZINES, BOOKLETS, NEWSLETTERS, PAMPHLETS AND CATALOGS RELATING TO HEALTH, WELLNESS, NUTRITION, AND SELF-IMPROVEMENT (U.S. CLS. 2, 5, 22, 23, 29, 37, 38 AND 50).

CLASS 44—MEDICAL, BEAUTY AND AGRICULTURAL SERVICES

FOR PROVIDING INFORMATION VIA THE INTERNET AND ELECTRONIC MAIL RELATING TO HEALTH, WELLNESS, AND NUTRITION (U.S. CLS. 100 AND 101).

CLASS 45—PERSONAL AND LEGAL SERVICES

FOR PROVIDING INFORMATION VIA THE INTERNET RELATING TO SELF-IMPROVEMENT (U.S. CLS. 100 AND 101).

LAURA KOVALSKY, EXAMINING ATTORNEY

SN 77-159,847. JONATHAN JOSEPH, INC., LOS ANGELES, CA. FILED 4-18-2007.

J CARE

THE MARK CONSISTS OF STANDARD CHARACTERS WITHOUT CLAIM TO ANY PARTICULAR FONT, STYLE, SIZE, OR COLOR.

NO CLAIM IS MADE TO THE EXCLUSIVE RIGHT TO USE "CARE", APART FROM THE MARK AS SHOWN.

CLASS 3—COSMETICS AND CLEANING PREPARATIONS

FOR AFTER-SHAVE; ANTI-AGING CREAM; ANTI-PERSPIRANTS; ANTI-WRINKLE CREAMS; BABY OILS; BABY POWDERS; BATH BEADS; BATH CRYSTALS; BATH MILKS; BATH OILS; BATH POWDER; BODY POWDER; BODY SPRAYS; COLOGNE; COSMETICS; COTTON FOR COSMETIC PURPOSES; CUTICLE CREAM; DEPILATORIES; ESSENTIAL OILS; FACE AND BODY GLITTER; FACE CREAMS; FACIAL CLEANSERS; FACIAL WASHES; FOOT POWDER; GEL EYE MASKS; HAIR CARE PREPARATIONS; HAIR CONDITIONERS; HAIR CREAMS; HAIR DYES; HAIR GELS; HAIR MOUSSES; HAIR NOURISHERS; HAIR OILS; HAIR RELAXERS; HAIR RINSES; HAIR SHAMPOO; HAIR SPRAY; HAND LOTIONS; HAND SOAPS; INCENSE; MAKE-UP; MAKE-UP REMOVER; MASSAGE OILS; NAIL POLISH; NAIL POLISH REMOVERS; NON-MEDICATED FOOT CREAM; PERFUMES; POMADES; POTPOURRI; SHAVING CREAMS; SHAVING PREPARATIONS; SKIN AND BODY TOPICAL LOTIONS, CREAMS AND OILS FOR COSMETIC USE; SOAPS FOR BODY CARE; SUN BLOCK; SUNTANNING PREPARATIONS (U.S. CLS. 1, 4, 6, 50, 51 AND 52).

CLASS 44—MEDICAL, BEAUTY AND AGRICULTURAL SERVICES

FOR BEAUTY SALONS; HAIR CUTTING; HAIR STYLING; HAIRDRESSING SALONS; HAIRDRESSING SERVICES; HEALTH SPA SERVICES, NAMELY, COSMETIC BODY CARE SERVICES (U.S. CLS. 100 AND 101).
BARBARA BROWN, EXAMINING ATTORNEY

SN 77-159,861. 40 PLUS FACES, QUEEN CREEK, AZ. FILED 4-18-2007.

40 Plus Faces

THE MARK CONSISTS OF STANDARD CHARACTERS WITHOUT CLAIM TO ANY PARTICULAR FONT, STYLE, SIZE, OR COLOR.

CLASS 38—COMMUNICATION

FOR PROVIDING ON-LINE CHAT ROOMS AND ELECTRONIC BULLETIN BOARDS FOR TRANSMISSION OF MESSAGES AMONG USERS IN THE FIELD OF GENERAL INTEREST; PROVIDING EMAIL AND INSTANT MESSAGING AND VIDEO CONFERENCING SERVICES (U.S. CLS. 100, 101 AND 104).

CLASS 42—SCIENTIFIC AND COMPUTER SERVICES

FOR COMPUTER SERVICES, NAMELY, HOSTING ONLINE WEB FACILITIES FOR OTHERS FOR ORGANIZING AND CONDUCTING ONLINE MEETINGS, GATHERINGS, AND INTERACTIVE DISCUSSIONS; AND COMPUTER SERVICES IN THE NATURE OF CUSTOMIZED WEB PAGES FEATURING USER-DEFINED INFORMATION, PERSONAL PROFILES AND INFORMATION (U.S. CLS. 100 AND 101).
AMY BROZENIC, EXAMINING ATTORNEY

SN 77-160,054. MADDY'S MANAGEMENT, INC., LAS VEGAS, NV. FILED 4-18-2007.

MADDY'S

THE MARK CONSISTS OF STANDARD CHARACTERS WITHOUT CLAIM TO ANY PARTICULAR FONT, STYLE, SIZE, OR COLOR.

CLASS 35—ADVERTISING AND BUSINESS

FOR RETAIL STORE SERVICES FEATURING CONVENIENCE STORE ITEMS (U.S. CLS. 100, 101 AND 102).
FIRST USE 3-0-1995; IN COMMERCE 3-0-1995.

CLASS 41—EDUCATION AND ENTERTAINMENT

FOR GAMBLING SERVICES; LOTTERY SERVICES (U.S. CLS. 100, 101 AND 107).
FIRST USE 3-0-1995; IN COMMERCE 3-0-1995.
SAMUEL E. SHARPER JR., EXAMINING ATTORNEY

SN 77-160,070. WESTERN HOLDINGS, LLC., CHEYENNE, WY. FILED 4-18-2007.

EAT ALL YOU WANT AND STILL LOSE WEIGHT

THE MARK CONSISTS OF STANDARD CHARACTERS WITHOUT CLAIM TO ANY PARTICULAR FONT, STYLE, SIZE, OR COLOR.

CLASS 5—PHARMACEUTICALS

FOR DIETARY SUPPLEMENTS (U.S. CLS. 6, 18, 44, 46, 51 AND 52).

CLASS 16—PAPER GOODS AND PRINTED MATTER

FOR PRINTED MATERIALS, NAMELY FLIERS, BROCHURES, MAGAZINES, PAMPHLETS, PAPER LABELS, DECALS, AND INSERTS, IN THE FIELD OF HEALTH, BEAUTY, FASHION, COSMETICS, FITNESS AND DIETARY SUPPLEMENTS (U.S. CLS. 2, 5, 22, 23, 29, 37, 38 AND 50).
JILL PRATER, EXAMINING ATTORNEY

SN 77-160,140. COVIDIEN AG, NEUHAUSEN AM RHEINFALL, SWITZERLAND, FILED 4-18-2007.

COVIDIEN

THE MARK CONSISTS OF STANDARD CHARACTERS WITHOUT CLAIM TO ANY PARTICULAR FONT, STYLE, SIZE, OR COLOR.

PRIORITY CLAIMED UNDER SEC. 44(D) ON SWITZERLAND APPLICATION NO. 59512/2006, FILED 10-20-2006, REG. NO. 554876, DATED 10-20-2006, EXPIRES 10-20-2016.

CLASS 35—ADVERTISING AND BUSINESS

FOR NUCLEAR PHARMACY SERVICES (U.S. CLS. 100, 101 AND 102).

CLASS 37—CONSTRUCTION AND REPAIR

FOR MEDICAL WASTE DISPOSAL SERVICES VIA MAIL (U.S. CLS. 100, 103 AND 106).

CLASS 41—EDUCATION AND ENTERTAINMENT

FOR EDUCATIONAL SERVICES, NAMELY, DEVELOPING, ARRANGING, AND CONDUCTING EDUCATIONAL CONFERENCES AND PROGRAMS AND PROVIDING COURSES OF INSTRUCTION IN THE FIELDS OF HUMAN HEALTH, HEALTHCARE, PHARMACEUTICALS, MEDICAL DEVICES, MEDICAL RESEARCH, SURGERY, MEDICAL SCIENCE AND MEDICINE; DISTRIBUTION OF COURSE MATERIALS IN CONNECTION THEREWITH (U.S. CLS. 100, 101 AND 107).

STEVEN R. FINE, EXAMINING ATTORNEY

SN 77-160,166. CHEF MERITO, INC., VAN NUYS, CA. FILED 4-18-2007.

PIKOS FOODS

THE MARK CONSISTS OF STANDARD CHARACTERS WITHOUT CLAIM TO ANY PARTICULAR FONT, STYLE, SIZE, OR COLOR.

OWNER OF U.S. REG. NO. 1,777,939.

NO CLAIM IS MADE TO THE EXCLUSIVE RIGHT TO USE "FOODS", APART FROM THE MARK AS SHOWN.

CLASS 25—CLOTHING

FOR CAPS; SHIRTS; SHORTS; SWEAT PANTS; T-SHIRTS (U.S. CLS. 22 AND 39).

CLASS 29—MEATS AND PROCESSED FOODS

FOR DRIED FRUITS; SNACK MIX CONSISTING PRIMARILY OF PROCESSED FRUITS, PROCESSED NUTS AND/OR RAISINS; PROCESSED NUTS; ROASTED NUTS (U.S. CL. 46).

CLASS 30—STAPLE FOODS

FOR SAUCES; SEASONINGS; SPICES (U.S. CL. 46).
LAURIE MAYES, EXAMINING ATTORNEY

SN 77-160,178. CHEF MERITO, INC., VAN NUYS, CA. FILED 4-18-2007.

PIKOS SNACKS

THE MARK CONSISTS OF STANDARD CHARACTERS WITHOUT CLAIM TO ANY PARTICULAR FONT, STYLE, SIZE, OR COLOR.

OWNER OF U.S. REG. NO. 1,777,939.

NO CLAIM IS MADE TO THE EXCLUSIVE RIGHT TO USE "SNACKS", APART FROM THE MARK AS SHOWN.

CLASS 25—CLOTHING

FOR CAPS; SHIRTS; SHORTS; SWEAT PANTS; T-SHIRTS (U.S. CLS. 22 AND 39).

CLASS 29—MEATS AND PROCESSED FOODS

FOR DRIED FRUITS; SNACK MIX CONSISTING PRIMARILY OF PROCESSED FRUITS, PROCESSED NUTS AND/OR RAISINS; PROCESSED NUTS; ROASTED NUTS (U.S. CL. 46).

CLASS 30—STAPLE FOODS

FOR SAUCES; SEASONINGS; SPICES (U.S. CL. 46).
LAURIE MAYES, EXAMINING ATTORNEY

SN 77-160,234. PHILLIPS ANDREW FREDERICK, LAS VEGAS, NV. FILED 4-19-2007.

POWERWHEEL

THE MARK CONSISTS OF STANDARD CHARACTERS WITHOUT CLAIM TO ANY PARTICULAR FONT, STYLE, SIZE, OR COLOR.

CLASS 7—MACHINERY

FOR ELECTRIC MOTORS FOR MACHINES (U.S. CLS. 13, 19, 21, 23, 31, 34 AND 35).

CLASS 12—VEHICLES

FOR BICYCLE WHEELS (U.S. CLS. 19, 21, 23, 31, 35 AND 44).

CHERYL CLAYTON, EXAMINING ATTORNEY

SN 77-160,260. PALMEN, JUSTIN A., NEW YORK, NY.
FILED 4-19-2007.

EMAKER

THE MARK CONSISTS OF STANDARD CHARACTERS WITHOUT CLAIM TO ANY PARTICULAR FONT, STYLE, SIZE, OR COLOR.

CLASS 9—ELECTRICAL AND SCIENTIFIC APPARATUS

FOR COMPUTER PROGRAMS RECORDED ON DATA MEDIA (SOFTWARE) DESIGNED FOR USE IN CONSTRUCTION AND AUTOMATED MANUFACTURING (CAD/CAM); COMPUTER E-COMMERCE SOFTWARE TO ALLOW USERS TO PERFORM ELECTRONIC BUSINESS TRANSACTIONS VIA A GLOBAL COMPUTER NETWORK; COMPUTER SOFTWARE FOR CREATING SEARCHABLE DATABASES OF INFORMATION AND DATA; COMPUTER SOFTWARE TO AUTOMATE DATA WAREHOUSING; FACTORY AUTOMATION SOFTWARE, NAMELY, SOFTWARE TO INTEGRATE MANUFACTURING MACHINE OPERATIONS, TRACK PROBLEMS AND GENERATE PRODUCTION REPORTS; COMPUTER PROGRAMMES FOR DOCUMENT MANAGEMENT; COMPUTER SEARCH ENGINE SOFTWARE (U.S. CLS. 21, 23, 26, 36 AND 38).

CLASS 35—ADVERTISING AND BUSINESS

FOR ONLINE BUSINESS NETWORKING SERVICES; ELECTRONIC COMMERCE SERVICES, NAMELY, PROVIDING INFORMATION ABOUT PRODUCTS VIA TELECOMMUNICATION NETWORKS FOR ADVERTISING AND SALES PURPOSES; OPERATING ON-LINE MARKETPLACES FOR SELLERS OF GOODS AND/OR SERVICES; PROVIDING A SEARCHABLE ONLINE ADVERTISING GUIDE FEATURING THE GOODS AND SERVICES OF OTHER ON-LINE VENDORS ON THE INTERNET; ADVERTISING, MARKETING AND PROMOTION SERVICES; COMMERCIAL CONSULTANCY; BUSINESS ADVISORY SERVICES, CONSULTANCY AND INFORMATION; VALUE ENGINEERING, NAMELY, COST ANALYSIS; ADVICE ON THE ANALYSIS OF CONSUMER BUYING HABITS AND NEEDS PROVIDED WITH THE HELP OF SENSORY, QUALITY AND QUANTITY-RELATED DATA; INFOMEDIARY SERVICES, NAMELY, FACILITATING TRANSACTIONS BETWEEN BUYERS AND SELLERS THROUGH PROVIDING BUYERS WITH INFORMATION ABOUT SELLERS, GOODS, AND/OR SERVICES (U.S. CLS. 100, 101 AND 102).

CLASS 42—SCIENTIFIC AND COMPUTER SERVICES

FOR COMPUTER SERVICES, NAMELY, CREATING AN ONLINE COMMUNITY FOR REGISTERED USERS TO PARTICIPATE IN COMPETITIONS, SHOWCASE THEIR SKILLS, GET FEEDBACK FROM THEIR PEERS, FORM VIRTUAL COMMUNITIES, ENGAGE IN SOCIAL NETWORKING AND IMPROVE THEIR TALENT; COMPUTER SERVICES, NAMELY, HOSTING ON-LINE WEB FACILITIES FOR OTHERS FOR ORGANIZING AND CONDUCTING ONLINE MEETINGS, GATHERINGS, AND INTERACTIVE DISCUSSIONS; CREATION OF CONTROL PROGRAMS FOR AUTOMATED MEASUREMENT, ASSEMBLY, ADJUSTMENT, AND RELATED VISUALISATION; CONSULTING SERVICES IN THE FIELD OF OFFICE AND WORKPLACE AUTOMATION; DATA AUTOMATION AND COLLECTION SERVICE USING PROPRIETARY SOFTWARE TO EVALUATE, ANALYZE AND COLLECT SERVICE DATA; COMPUTER SERVICES, NAMELY, CREATING INDEXES OF INFORMATION, SITES AND OTHER RESOURCES AVAILABLE ON COMPUTER NETWORKS; COMPUTER AIDED DESIGN FOR OTHERS; PRODUCT RESEARCH AND DEVELOPMENT; SCIENTIFIC RESEARCH AND DEVELOPMENT (U.S. CLS. 100 AND 101).

SONYA STEPHENS, EXAMINING ATTORNEY

SN 77-160,390. GERUS, SHEILA JANE, PENNINGTON, NJ.
FILED 4-19-2007.

Renavatio

THE MARK CONSISTS OF STANDARD CHARACTERS WITHOUT CLAIM TO ANY PARTICULAR FONT, STYLE, SIZE, OR COLOR.

CLASS 35—ADVERTISING AND BUSINESS

FOR ADVERTISING AND MARKETING; ADVERTISING AND PUBLICITY SERVICES, NAMELY, PROMOTING THE GOODS, SERVICES, BRAND IDENTITY AND COMMERCIAL INFORMATION AND NEWS OF THIRD PARTIES THROUGH PRINT, AUDIO, VIDEO, DIGITAL AND ON-LINE MEDIUM; ADVERTISING RELATING TO PHARMACEUTICAL PRODUCTS AND IN-VIVO IMAGING PRODUCTS; ADVERTISING SERVICES, NAMELY, CREATING CORPORATE AND BRAND IDENTITY FOR OTHERS; ADVERTISING SERVICES, NAMELY, PROMOTING AND MARKETING THE GOODS AND SERVICES OF OTHERS THROUGH ALL PUBLIC COMMUNICATION MEANS; CREATING AND UPDATING ADVERTISING MATERIAL; CREATION OF MARKETING TOOLS DESIGNED TO INCREASE A CLIENT COMPANY'S KNOWLEDGE OF CUSTOMER NEEDS, AND ITS COMPETITORS' PRODUCTS AND SERVICES, PRICING, ADVERTISING STRATEGY AND SALES STRATEGY; DESIGN OF ADVERTISING MATERIALS FOR OTHERS; DESIGN OF INTERNET ADVERTISING; DIRECT MAIL ADVERTISING; DISSEMINATION OF ADVERTISING FOR OTHERS VIA AN ON-LINE COMMUNICATIONS NETWORK ON THE INTERNET; ISSUING AND UPDATING OF ADVERTISING TEXTS; LAYOUT SERVICES FOR ADVERTISING PURPOSES; MODELING SERVICES FOR ADVERTISING OR SALES PROMOTION; ON-LINE ADVERTISING AND MARKETING SERVICES; ORGANIZING EXHIBITIONS FOR MEDICAL AND CONSUMER CONVENTIONS; PREPARING AUDIO-VISUAL DISPLAYS IN THE FIELD OF HEALTHCARE; PREPARING AUDIO-VISUAL PRESENTATIONS FOR USE IN ADVERTISING; PROMOTING THE GOODS AND SERVICES OF OTHERS BY DISTRIBUTING ADVERTISING MATERIALS THROUGH A VARIETY OF METHODS; PROMOTION, ADVERTISING AND MARKETING OF ON-LINE WEBSITES; PROVIDING ADVERTISING SERVICES USING 3D AND ANIMATION DESIGNS; MARKET

RESEARCH CONSULTATION; MARKET SEGMENTATION CONSULTATION; MARKETING CONSULTING (U.S. CLS. 100, 101 AND 102).

SN 77-160,516. STORYBRIDGE STUDIO LLC, MADISON, WI. FILED 4-19-2007.

CLASS 41—EDUCATION AND ENTERTAINMENT

FOR LAYOUT SERVICES OTHER THAN FOR ADVERTISING PURPOSES; WRITING OF ARTICLES FOR JOURNALS OTHER THAN FOR ADVERTISING OR PUBLICITY; WRITING OF ARTICLES FOR PERIODICALS OTHER THAN FOR ADVERTISING OR PUBLICITY; WRITING OF ARTICLES FOR PROFESSIONAL JOURNALS OTHER THAN FOR ADVERTISING OR PUBLICITY; SPECIAL EVENT PLANNING CONSULTATION (U.S. CLS. 100, 101 AND 107).

StoryBridge

THE MARK CONSISTS OF STANDARD CHARACTERS WITHOUT CLAIM TO ANY PARTICULAR FONT, STYLE, SIZE, OR COLOR.

CLASS 42—SCIENTIFIC AND COMPUTER SERVICES

FOR DESIGNING WEBSITES FOR ADVERTISING PURPOSES; PRODUCT DEVELOPMENT CONSULTATION; DESIGNING THEME GRAPHICS AND MULTIMEDIA SHOWS FOR CONVENTIONS, PRODUCT LAUNCHES, TRADE SHOWS, KEY NOTE ADDRESSES AND AWARD CEREMONIES FOR OTHERS; GRAPHIC DESIGN SERVICES; DESIGN AND DEVELOPMENT OF MULTIMEDIA PRODUCTS; DESIGN, CREATION, HOSTING, MAINTENANCE OF WEBSITES FOR OTHERS (U.S. CLS. 100 AND 101).

CLASS 35—ADVERTISING AND BUSINESS

FOR ADVERTISING AND PUBLICITY SERVICES, NAMELY, PROMOTING THE GOODS, SERVICES, BRAND IDENTITY AND COMMERCIAL INFORMATION AND NEWS OF THIRD PARTIES THROUGH PRINT, AUDIO, VIDEO, DIGITAL AND ON-LINE MEDIUM (U.S. CLS. 100, 101 AND 102).
FIRST USE 3-5-2007; IN COMMERCE 3-5-2007.

CLASS 44—MEDICAL, BEAUTY AND AGRICULTURAL SERVICES

FOR MEDICAL AND PHARMACEUTICAL CONSULTATION; PROVIDING MEDICAL INFORMATION, CONSULTANCY AND ADVISORY SERVICES (U.S. CLS. 100 AND 101).
SANJEEV VOHRA, EXAMINING ATTORNEY

CLASS 38—COMMUNICATION

FOR VIDEO BROADCASTING; TRANSMISSION OF NEWS; TELEVISION BROADCASTING; STREAMING OF VIDEO MATERIAL ON THE INTERNET; COMMUNICATIONS SERVICES, NAMELY, TRANSMITTING STREAMED SOUND AND AUDIO-VISUAL RECORDINGS VIA THE INTERNET; BROADCASTING PROGRAMS VIA A GLOBAL COMPUTER NETWORK (U.S. CLS. 100, 101 AND 104).
FIRST USE 3-5-2007; IN COMMERCE 3-5-2007.

CLASS 41—EDUCATION AND ENTERTAINMENT

FOR ENTERTAINMENT IN THE NATURE OF ONGOING TELEVISION PROGRAMS IN THE FIELD OF NEWS; ENTERTAINMENT IN THE NATURE OF TELEVISION NEWS SHOWS; ENTERTAINMENT IN THE NATURE OF VISUAL AND AUDIO PERFORMANCES, AND MUSICAL, VARIETY, NEWS AND COMEDY SHOWS; ENTERTAINMENT, NAMELY A CONTINUING NEWS SHOW BROADCAST OVER TELEVISION, SATELLITE, AUDIO, AND VIDEO MEDIA; ENTERTAINMENT, NAMELY, TELEVISION NEWS SHOWS; NEWS AGENCIES, NAMELY, GATHERING AND DISSEMINATION OF NEWS; NEWS ANALYSIS AND FEATURES DISTRIBUTION; NEWS REPORTING SERVICES; PROVIDING NEWS IN THE NATURE OF CURRENT EVENT REPORTING; ON-LINE JOURNALS, NAMELY, BLOGS FEATURING NEWS (U.S. CLS. 100, 101 AND 107).
FIRST USE 3-5-2007; IN COMMERCE 3-5-2007.
BARBARA RUTLAND, EXAMINING ATTORNEY

SN 77-160,418. COZMEDIC SURGERY ASSOCIATES, LLC, TROY, MI. FILED 4-19-2007.

BEYOUTHFUL

THE MARK CONSISTS OF STANDARD CHARACTERS WITHOUT CLAIM TO ANY PARTICULAR FONT, STYLE, SIZE, OR COLOR.

CLASS 5—PHARMACEUTICALS

FOR DIETARY SUPPLEMENTS (U.S. CLS. 6, 18, 44, 46, 51 AND 52).

CLASS 44—MEDICAL, BEAUTY AND AGRICULTURAL SERVICES

FOR MEDICAL SERVICES, NAMELY, HORMONE REPLACEMENT THERAPY, ANTI-AGING AND ANTI-GROWTH HORMONE TREATMENTS, AND WEIGHT CONTROL CLINICS (U.S. CLS. 100 AND 101).
KATHERINE E. HALMEN, EXAMINING ATTORNEY

SN 77-160,537. MAJESCOMASTEK, EDISON, NJ. FILED 4-19-2007.

Delivering The Value Ordinary Solutions Miss

THE MARK CONSISTS OF STANDARD CHARACTERS WITHOUT CLAIM TO ANY PARTICULAR FONT, STYLE, SIZE, OR COLOR.

CLASS 35—ADVERTISING AND BUSINESS

FOR OUTSOURCING IN THE FIELDS OF BUSINESS PROCESS AND INFORMATION TECHNOLOGY (U.S. CLS. 100, 101 AND 102).

FIRST USE 1-6-2006; IN COMMERCE 1-6-2006.

CLASS 42—SCIENTIFIC AND COMPUTER SERVICES

FOR INFORMATION TECHNOLOGY CONSULTATION, NAMELY, PROVIDING INFORMATION TECHNOLOGY (U.S. CLS. 100 AND 101).

FIRST USE 1-6-2006; IN COMMERCE 1-6-2006.

COLLEEN DOMBROW, EXAMINING ATTORNEY

CLASS 5—PHARMACEUTICALS

FOR DIETARY AND NUTRITIONAL SUPPLEMENTS; DIETARY FOOD SUPPLEMENTS; DIETARY SUPPLEMENTAL DRINKS; DIETARY SUPPLEMENTS; DIETARY SUPPLEMENTS FOR HUMAN CONSUMPTION; FOOD SUPPLEMENTS; HERBAL SUPPLEMENTS; MEAL REPLACEMENT AND DIETARY SUPPLEMENT DRINK MIXES; NUTRACEUTICALS FOR USE AS A DIETARY SUPPLEMENT; NUTRITIONAL SUPPLEMENTS; POWDERED NUTRITIONAL SUPPLEMENT DRINK MIX; VITAMIN SUPPLEMENTS; BISCUITS, BREAD, BREAD ROLLS, CAKES, CEREAL PRODUCTS, CONFECTIONERY, CRACKERS, NOODLES, FISH SAUCE, RELISH, SAUCES, CEREAL-BASED SNACK-FOODS AND PREPARED DIETARY ITEMS THAT ARE GLUTEN-FREE TO ACCOMMODATE SPECIAL MEDICAL AND HEALTH CONDITIONS; DIETARY FIBER AS AN ADDITIVE FOR FOOD PRODUCTS; MULTI-VITAMIN PREPARATIONS; VITAMINS (U.S. CLS. 6, 18, 44, 46, 51 AND 52).

SN 77-160,781. CARLSON, JEVRETT, MARINA DEL REY, CA. FILED 4-19-2007.

CLASS 25—CLOTHING

FOR TOPS (U.S. CLS. 22 AND 39).

CLASS 43—HOTEL AND RESTAURANT SERVICES

FOR FAST FOOD AND NON-STOP RESTAURANT SERVICES; FAST-FOOD RESTAURANTS; FAST-FOOD RESTAURANTS AND SNACKBARS; FOOD PREPARATION SERVICES; PREPARATION OF FOOD AND BEVERAGES; SERVING FOOD AND DRINKS; SERVING OF FOOD AND DRINK/BEVERAGES; CAFE-RESTAURANTS; CARRY-OUT RESTAURANTS; RESTAURANT AND BAR SERVICES; RESTAURANT SERVICES; RESTAURANTS; TAKE-OUT RESTAURANT SERVICES (U.S. CLS. 100 AND 101).

MIDGE BUTLER, EXAMINING ATTORNEY

CITIZEN BANG

THE MARK CONSISTS OF STANDARD CHARACTERS WITHOUT CLAIM TO ANY PARTICULAR FONT, STYLE, SIZE, OR COLOR.

CLASS 9—ELECTRICAL AND SCIENTIFIC APPARATUS

FOR BULLET-PROOF VESTS; BULLET-PROOF VESTS AND CLOTHING (U.S. CLS. 21, 23, 26, 36 AND 38).

CLASS 25—CLOTHING

FOR BELTS; CAPS; CLOTHING, NAMELY, WRAP-AROUNDS; HOODS; JERSEYS; MANTLES; MUFFLERS; SHIRTS; SHORT SETS; TIES; TOPS; WRAPS; HEADBANDS AGAINST SWEATING; STOCKINGS; SWEAT BANDS; SWEAT PANTS; SWEAT SHIRTS; SWEAT SHORTS; SWEAT SUITS; DRESS SHIRTS; SHIRTS; SPORT SHIRTS; T-SHIRTS; BATHING SUITS; BATHING SUITS FOR MEN; BODY SUITS; DRY SUITS; GYM SUITS; LADIES' SUITS; MEN'S SUITS; SUITS; COATS; DRESS SUITS; DRESSES; SHORTS; SHOES; TROUSERS; UNDERWEAR; SOCKS (U.S. CLS. 22 AND 39).

ESTHER BELENKER, EXAMINING ATTORNEY

SN 77-160,887. HOROLOS GROUP INC., LONG ISLAND CITY, NY. FILED 4-19-2007.

HOROLOS

THE MARK CONSISTS OF STANDARD CHARACTERS WITHOUT CLAIM TO ANY PARTICULAR FONT, STYLE, SIZE, OR COLOR.

CLASS 14—JEWELRY

FOR JEWELRY; WATCHES (U.S. CLS. 2, 27, 28 AND 50).

CLASS 25—CLOTHING

FOR CLOTHING, NAMELY SHIRTS, TOPS, PANTS, SHORTS, SOCKS, SHOES, AND JACKETS (U.S. CLS. 22 AND 39).

JASON ROTH, EXAMINING ATTORNEY

SN 77-160,804. NRS-NUTRITION RESOURCE SERVICES, INC., BETHLEHEM, PA. FILED 4-19-2007.

Fuggedaboutit

THE MARK CONSISTS OF STANDARD CHARACTERS WITHOUT CLAIM TO ANY PARTICULAR FONT, STYLE, SIZE, OR COLOR.

SN 77-160,939. HOROLOS GROUP INC., LONG ISLAND CITY, NY. FILED 4-19-2007.

SN 77-161,006. ON LOCATION TOURS, NEW YORK, NY. FILED 4-19-2007.

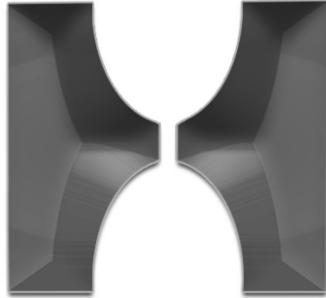

CLASS 14—JEWELRY

FOR JEWELRY; WATCHES (U.S. CLS. 2, 27, 28 AND 50).

CLASS 25—CLOTHING

FOR CLOTHING, NAMELY SHIRTS, TOPS, PANTS, SHORTS, SOCKS, SHOES, AND JACKETS (U.S. CLS. 22 AND 39).

JASON ROTH, EXAMINING ATTORNEY

Shot on this Spot

THE MARK CONSISTS OF STANDARD CHARACTERS WITHOUT CLAIM TO ANY PARTICULAR FONT, STYLE, SIZE, OR COLOR.

CLASS 6—METAL GOODS

FOR NON-LUMINOUS AND NON-MECHANICAL METAL SIGNS (U.S. CLS. 2, 12, 13, 14, 23, 25 AND 50).

CLASS 16—PAPER GOODS AND PRINTED MATTER

FOR STICKERS (U.S. CLS. 2, 5, 22, 23, 29, 37, 38 AND 50).

STEPHEN AQUILA, EXAMINING ATTORNEY

SN 77-160,955. MEDICAL DEVELOPMENT INTERNATIONAL LTD., INC., JACKSONVILLE, FL. FILED 4-19-2007.

SN 77-161,088. STELLA 58, INC., NEW YORK, NY. FILED 4-19-2007.

GIVING YOU THE POWER TO
PROVIDE TRUSTED HEALTHCARE
SERVICES

HOLY BIRD

THE MARK CONSISTS OF STANDARD CHARACTERS WITHOUT CLAIM TO ANY PARTICULAR FONT, STYLE, SIZE, OR COLOR.

CLASS 35—ADVERTISING AND BUSINESS

FOR COST CONTAINMENT, REVIEW AND UTILIZATION ANALYSIS IN THE FIELD OF HEALTHCARE SERVICES; INTERACTIVE MEDICAL RECORDKEEPING SERVICES FOR USE IN RISK MANAGEMENT, CLAIMS PAYMENT, ADMINISTRATION AND REGULATORY COMPLIANCE; VERIFYING AND MONITORING THE CREDENTIALS OF DOCTORS AND OTHER MEDICAL PROFESSIONALS (U.S. CLS. 100, 101 AND 102).

FIRST USE 4-9-2007; IN COMMERCE 4-9-2007.

CLASS 36—INSURANCE AND FINANCIAL

FOR MEDICAL HEALTH PLAN AND CLAIMS ADMINISTRATION; ORGANIZATION AND ADMINISTRATION OF PREFERRED PROVIDER PLANS IN THE MEDICAL FIELD (U.S. CLS. 100, 101 AND 102).

FIRST USE 4-9-2007; IN COMMERCE 4-9-2007.
TANYA AMOS, EXAMINING ATTORNEY

THE MARK CONSISTS OF STANDARD CHARACTERS WITHOUT CLAIM TO ANY PARTICULAR FONT, STYLE, SIZE, OR COLOR.

NO CLAIM IS MADE TO THE EXCLUSIVE RIGHT TO USE "BIRD", APART FROM THE MARK AS SHOWN.

CLASS 35—ADVERTISING AND BUSINESS

FOR ON-LINE ORDERING SERVICES IN THE FIELD OF RESTAURANT TAKE-OUT AND DELIVERY; FRANCHISING, NAMELY, OFFERING TECHNICAL ASSISTANCE IN THE ESTABLISHMENT AND/OR OPERATION OF RESTAURANTS; RESTAURANT FRANCHISING; RESTAURANT MANAGEMENT FOR OTHERS (U.S. CLS. 100, 101 AND 102).

CLASS 43—HOTEL AND RESTAURANT SERVICES

FOR CARRY-OUT RESTAURANTS; TAKE-OUT RESTAURANT SERVICES; RESTAURANTS; FAST FOOD AND NON-STOP RESTAURANT SERVICES; RESTAURANT SERVICES (U.S. CLS. 100 AND 101).

MICHAEL SOUDERS, EXAMINING ATTORNEY

SN 77-161,104. SOUTH WASHINGTON COUNTY SCHOOLS
COMMUNITY EDUCATION, COTTAGE GROVE, MN.
FILED 4-19-2007.

WHERE LEARNING COMES ALIVE

THE MARK CONSISTS OF STANDARD CHARACTERS
WITHOUT CLAIM TO ANY PARTICULAR FONT, STYLE,
SIZE, OR COLOR.

CLASS 41—EDUCATION AND ENTERTAINMENT

FOR OPERATION OF SPORTS CAMPS; PHYSICAL FITNESS CONDITIONING CLASSES; SWIMMING INSTRUCTION; EDUCATION SERVICES, NAMELY, PROVIDING CLASSES IN THE FIELDS OF FITNESS, COOKING, ART, DRIVING, TAX PREPARATION, COMPUTERS, LITERACY, WRITING, LANGUAGE LEARNING, AQUATICS, SPORTS AND RECREATION, PHOTOGRAPHY, PARENT EDUCATION, HIGH SCHOOL COMPLETION, GED, ACT/PSAT PREP, FINANCE, SELF HELP, HEALTH AND WELLNESS; EDUCATION SERVICES, NAMELY, PROVIDING TUTORING IN THE FIELDS OF ALL SUBJECTS AT THE ELEMENTARY LEVEL; PROVIDING COURSES OF INSTRUCTION AT THE HIGH SCHOOL LEVEL (U.S. CLS. 100, 101 AND 107).

CLASS 43—HOTEL AND RESTAURANT SERVICES

FOR CHILD CARE (U.S. CLS. 100 AND 101).
DARRYL SPRUILL, EXAMINING ATTORNEY

SN 77-161,209. INNOFONE.COM, INC., SANTA MONICA,
CA. FILED 4-19-2007.

SuiteCase

THE MARK CONSISTS OF STANDARD CHARACTERS
WITHOUT CLAIM TO ANY PARTICULAR FONT, STYLE,
SIZE, OR COLOR.

CLASS 9—ELECTRICAL AND SCIENTIFIC APPARATUS

FOR DOWNLOADABLE RING TONES, VIDEO CONTENT, AUDIO CONTENT, GAMES, IMAGES, GRAPHICS AND MUSIC VIA THE INTERNET, WIRED AND WIRELESS NETWORKS FOR USE WITH WIRELESS AND HANDHELD DEVICES (U.S. CLS. 21, 23, 26, 36 AND 38).

CLASS 38—COMMUNICATION

FOR TRANSMISSION OF VOICE, DATA, IMAGES, GAMES, GRAPHICS, VIDEO CONTENT AND AUDIO CONTENT VIA THE INTERNET, WIRED AND WIRELESS NETWORKS TO WIRELESS AND HANDHELD DEVICES; WIRELESS DIGITAL MESSAGING SERVICES; WEB MESSAGING; ELECTRONIC MAIL SERVICES; PROVIDING ON-LINE CHAT ROOMS FOR TRANSMISSION OF MESSAGES AMONG COMPUTER USERS CONCERNING MUSIC AND ENTERTAINMENT; AUDIO BROADCASTING; AUDIO TELECONFERENCING; BROADCASTING PROGRAMS VIA A GLOBAL COMPUTER NETWORK; BROADCASTING SERVICES AND PROVISION OF TELECOMMUNICATION ACCESS TO FILMS AND TV PROGRAMS PROVIDED VIA A VIDEO-ON-DEMAND SERVICE AND TO VIDEO AND AUDIO CONTENT PROVIDED VIA A VIDEO-ON-DEMAND SERVICE VIA THE INTERNET; CELLULAR TELEPHONE COMMUNICATION; CELLULAR TELEPHONE SERVICES; COMMUNICATION BY MOBILE TELEPHONE; COMMUNICATION SERVICES, NAMELY, ELECTRONIC TRANSMISSION OF DATA AND DOCUMENTS AMONG USERS OF COMPUTERS; COMMUNICATIONS BY COMPUTER TERMINALS; COMMUNICATIONS BY MEANS OF MOBILE PHONES; COMMUNICATIONS BY MOBILE PHONES; COMMUNICATIONS SERVICES, NAMELY, TRANSMITTING STREAMED SOUND AND AUDIO-VISUAL RECORDINGS VIA THE INTERNET; COMMUNICATIONS VIA MULTINATIONAL TELECOMMUNICATION NETWORKS; COMPUTER AIDED TRANSMISSION OF INFORMATION AND IMAGES; DATA AND VOICE TELECOMMUNICATIONS; DATA COMMUNICATION BY ELECTRONIC MAIL; DATA TRANSMISSION AND RECEPTION SERVICES VIA TELECOMMUNICATION MEANS; DELIVERY OF MESSAGES BY ELECTRONIC TRANSMISSION; ELECTRONIC DATA INTERCHANGE; ELECTRONIC DATA TRANSMISSION; ELECTRONIC DELIVERY OF IMAGES AND PHOTOGRAPHS VIA A GLOBAL COMPUTER NETWORK; ELECTRONIC EXCHANGE OF DATA STORED IN DATABASES ACCESSIBLE VIA TELECOMMUNICATION NETWORKS; ELECTRONIC MAIL SERVICES; ELECTRONIC MESSAGE SENDING; ELECTRONIC MESSAGE TRANSMISSION; ELECTRONIC MESSAGING SYSTEM, NAMELY, ELECTRONIC QUEUING SERVICES; ELECTRONIC STORE-AND-FORWARD MESSAGING; ELECTRONIC TRANSMISSION OF DATA AND DOCUMENTS VIA COMPUTER TERMINALS; ELECTRONIC TRANSMISSION OF MESSAGES AND DATA; ELECTRONIC VOICE MESSAGING, NAMELY, THE RECORDING AND SUBSEQUENT TRANSMISSION OF VOICE MESSAGES BY TELEPHONE; ELECTRONIC, ELECTRIC AND DIGITAL TRANSMISSION OF VOICE, DATA, IMAGES, SIGNALS, AND MESSAGES; E-MAIL FORWARDING SERVICES; HIGH BIT-RATE DATA TRANSMISSION SERVICES FOR TELECOMMUNICATION NETWORK OPERATORS; INFORMATION TRANSMISSION SERVICES VIA DIGITAL NETWORKS; INFORMATION TRANSMISSION VIA ELECTRONIC COMMUNICATIONS NETWORKS; INSTANT MESSAGING SERVICES; INTERNATIONAL TELEPHONE SERVICES; INTERSTATE TELEPHONE SERVICES; INTRASTATE TELEPHONE SERVICES; LOCAL AND LONG DISTANCE TELEPHONE SERVICES; LONG DISTANCE TELEPHONE COMMUNICATION SERVICES; MOBILE TELEPHONE COMMUNICATION; MOBILE TELEPHONY; NETWORK CONFERENCING SERVICES; PREPAID LONG DISTANCE TELEPHONE SERVICES; PROVIDING ACCESS TO TELECOMMUNICATION NETWORKS; PROVIDING ELECTRONIC TELECOMMUNICATION CONNECTIONS; PROVIDING E-MAIL SERVICES; PROVIDING FACILITIES AND EQUIPMENT FOR VIDEO CONFERENCING; PROVIDING MULTIPLE USE ACCESS TO GLOBAL COMPUTER INFORMATION NETWORKS FOR THE TRANSFER AND DISSEMINATION OF A WIDE RANGE OF INFORMATION; PROVIDING MULTIPLE-USER ACCESS TO A GLOBAL COMPUTER INFORMATION NETWORK; PROVIDING ON-LINE COMMUNICATIONS LINKS WHICH TRANSFER THE WEBSITE USER TO OTHER LOCAL AND GLOBAL WEB PAGES; PROVIDING TELECOMMUNICATIONS CONNECTIONS TO A GLOBAL COMPUTER NETWORK; PROVIDING TELEPHONE CONFERENCING SERVICES; PROVIDING THIRD PARTY USERS WITH ACCESS TO TELECOMMUNICATION INFRASTRUCTURE; PROVISION OF ACCESS TO DATA OR DOCUMENTS STORED ELECTRONICALLY IN CENTRAL FILES FOR REMOTE

CONSULTATION; PROVISION OF ACCESS TO ELECTRONIC SITES; RADIO, TELEPHONE, TELEGRAPH COMMUNICATION SERVICES; RADIO/TELEPHONE PAGING SERVICES; SATELLITE, CABLE, NETWORK TRANSMISSION OF SOUNDS, IMAGES, SIGNALS AND DATA; SECURE E-MAIL SERVICES; SIGNAL TRANSMISSION FOR ELECTRONIC COMMERCE VIA TELECOMMUNICATION SYSTEMS AND DATA COMMUNICATION SYSTEMS; STREAMING OF AUDIO MATERIAL ON THE INTERNET; STREAMING OF VIDEO MATERIAL ON THE INTERNET; TELECOMMUNICATION ACCESS SERVICES; TELECOMMUNICATION SERVICES, NAMELY, LOCAL AND LONG DISTANCE TRANSMISSION OF VOICE, DATA, GRAPHICS BY MEANS OF TELEPHONE, TELEGRAPHIC, CABLE, AND SATELLITE TRANSMISSIONS; TELECOMMUNICATION SERVICES IN THE FIELD OF PROVIDING LONG DISTANCE SERVICE WITH AUDIO ADVERTISING FOR OTHERS AS A COMPONENT OF THE LONG DISTANCE SERVICE; TELECOMMUNICATIONS BY E-MAIL; TELECOMMUNICATIONS RESELLER SERVICES, NAMELY, PROVIDING LONG DISTANCE TELECOMMUNICATION SERVICES; TELEPHONE COMMUNICATION SERVICES; TELEPHONE VOICE MESSAGING SERVICES; TEXT AND NUMERIC WIRELESS DIGITAL MESSAGING SERVICES; TRANSFER OF DATA BY TELECOMMUNICATION; TRANSFER OF DATA BY TELECOMMUNICATIONS; TRANSMISSION OF DATA, SOUND AND IMAGES BY SATELLITE; TRANSMISSION OF DATABASE INFORMATION VIA TELECOMMUNICATIONS NETWORKS; TRANSMISSION OF INFORMATION BY ELECTRONIC COMMUNICATIONS NETWORKS; TRANSMISSION OF INFORMATION IN THE AUDIOVISUAL FIELD; TRANSMISSION OF INFORMATION THROUGH VIDEO COMMUNICATION SYSTEMS; TRANSMISSION OF INFORMATION VIA NATIONAL AND INTERNATIONAL NETWORKS; TRANSMISSION OF MESSAGES OVER ELECTRONIC MEDIA; TRANSMISSION OF NEWS; TRANSMISSION OF SHORT MESSAGES; TRANSMISSION OF SOUND AND VISION VIA SATELLITE OR INTERACTIVE MULTIMEDIA NETWORKS; TRANSMISSION OF SOUND PICTURE AND DATA SIGNALS; TRANSMISSION OF SOUND, VIDEO AND INFORMATION; TRANSMISSION OF STOCK MARKET INFORMATION WITH THE HELP OF TELECOMMUNICATIONS MEDIA; VIDEO BROADCASTING; VIDEO TELECONFERENCING; VIDEO-ON-DEMAND TRANSMISSION SERVICES; VIRTUAL CHATROOMS ESTABLISHED VIA TEXT MESSAGING; VOICE MAIL SERVICES; VOICE OVER IP SERVICES; VOICE OVER INTERNET PROTOCOL (VOIP) SERVICES; VOICE OVER IP SERVICES; VOICE TELECOMMUNICATION; VOICE ACTIVATED DIALING SERVICES; WEB MESSAGING; WEB SITE FORWARDING SERVICES; WEBCASTING SERVICES; WIRELESS BROADBAND COMMUNICATION SERVICES; WIRELESS COMMUNICATIONS SERVICES, NAMELY, TRANSMISSION OF GRAPHICS TO MOBILE TELEPHONES; WIRELESS DIGITAL MESSAGING SERVICES; WIRELESS ELECTRONIC TRANSMISSION OF VOICE SIGNALS, DATA, FACSIMILES, IMAGES AND INFORMATION; WIRELESS VOICE MAIL SERVICES; WORLDWIDE SWITCHED TEXT AND MESSAGE TRANSMISSION SERVICES (U.S. CLS. 100, 101 AND 104).

CLASS 41—EDUCATION AND ENTERTAINMENT

FOR ONLINE JOURNALS, NAMELY, BLOGS FEATURING CONTENT FROM MOBILE USERS IN THE FIELDS OF GENERAL INTEREST INFORMATION, MUSIC, SPORTS, ENTERTAINMENT AND NEWS EVENTS VIA COMPUTER NETWORKS, WIRED AND WIRELESS NETWORKS (U.S. CLS. 100, 101 AND 107).
LINDA ORNDORFF, EXAMINING ATTORNEY

SN 77-161,215. INNOFONE.COM, INC., SANTA MONICA, CA. FILED 4-19-2007.

2Dpocket

THE MARK CONSISTS OF STANDARD CHARACTERS WITHOUT CLAIM TO ANY PARTICULAR FONT, STYLE, SIZE, OR COLOR.

CLASS 9—ELECTRICAL AND SCIENTIFIC APPARATUS

FOR DOWNLOADABLE 2-D IMAGES, RINGTONES, VIDEO CONTENT, AUDIO CONTENT, GAMES, IMAGES, GRAPHICS AND MUSIC VIA THE INTERNET, WIRED AND WIRELESS NETWORKS FOR USE WITH WIRELESS AND HANDHELD DEVICES (U.S. CLS. 21, 23, 26, 36 AND 38).

CLASS 38—COMMUNICATION

FOR TRANSMISSION OF VOICE, DATA, IMAGES, 2-D IMAGES, GAMES, GRAPHICS, VIDEO CONTENT AND AUDIO CONTENT VIA THE INTERNET, WIRED AND WIRELESS NETWORKS TO WIRELESS AND HANDHELD DEVICES; WIRELESS DIGITAL MESSAGING SERVICES; WEB MESSAGING; ELECTRONIC MAIL SERVICES; PROVIDING ON-LINE CHAT ROOMS FOR TRANSMISSION OF MESSAGES AMONG COMPUTER USERS CONCERNING MUSIC AND ENTERTAINMENT; AUDIO BROADCASTING; AUDIO TELECONFERENCING; BROADCASTING PROGRAMS VIA A GLOBAL COMPUTER NETWORK; BROADCASTING SERVICES AND PROVISION OF TELECOMMUNICATION ACCESS TO FILMS AND TV PROGRAMS PROVIDED VIA A VIDEO-ON-DEMAND SERVICE AND TO VIDEO AND AUDIO CONTENT PROVIDED VIA A VIDEO-ON-DEMAND SERVICE VIA THE INTERNET; CELLULAR TELEPHONE COMMUNICATION; CELLULAR TELEPHONE SERVICES; COMMUNICATION BY MOBILE TELEPHONE; COMMUNICATION SERVICES, NAMELY, ELECTRONIC TRANSMISSION OF DATA AND DOCUMENTS AMONG USERS OF COMPUTERS; COMMUNICATIONS BY COMPUTER TERMINALS; COMMUNICATIONS BY MEANS OF MOBILE PHONES; COMMUNICATIONS BY MOBILE PHONES; COMMUNICATIONS SERVICES, NAMELY, TRANSMITTING STREAMED SOUND AND AUDIO-VISUAL RECORDINGS VIA THE INTERNET; COMMUNICATIONS VIA MULTINATIONAL TELECOMMUNICATION NETWORKS; COMPUTER AIDED TRANSMISSION OF INFORMATION AND IMAGES; DATA AND VOICE TELECOMMUNICATIONS; DATA COMMUNICATION BY ELECTRONIC MAIL; DATA TRANSMISSION AND RECEPTION SERVICES VIA TELECOMMUNICATION MEANS; DELIVERY OF MESSAGES BY ELECTRONIC TRANSMISSION; ELECTRONIC DATA INTERCHANGE; ELECTRONIC DATA TRANSMISSION; ELECTRONIC DELIVERY OF IMAGES AND PHOTOGRAPHS VIA A GLOBAL COMPUTER NETWORK; ELECTRONIC EXCHANGE OF DATA STORED IN DATABASES ACCESSIBLE VIA TELECOMMUNICATION NETWORKS; ELECTRONIC MESSAGE SENDING; ELECTRONIC MESSAGE TRANSMISSION; ELECTRONIC MESSAGING SYSTEM, NAMELY, ELECTRONIC QUEUING SERVICES; ELECTRONIC STORE-AND-FORWARD MESSAGING; ELECTRONIC TRANSMISSION OF DATA AND DOCUMENTS VIA COMPUTER TERMINALS; ELECTRONIC TRANSMISSION OF MESSAGES AND DATA; ELECTRONIC VOICE MESSAGING, NAMELY, THE RECORDING AND SUBSEQUENT TRANSMISSION OF VOICE MESSAGES BY TELEPHONE; ELECTRONIC, ELECTRIC AND DIGITAL TRANSMISSION OF VOICE, DATA, IMAGES, SIGNALS, AND MESSAGES; E-MAIL FORWARDING SERVICES; HIGH BIT-RATE DATA TRANSMISSION SERVICES FOR TELECOMMUNICATION NETWORK OPERATORS; INFORMATION TRANSMISSION SERVICES VIA DIGITAL NETWORKS; INFORMATION TRANSMISSION VIA ELECTRONIC

COMMUNICATIONS NETWORKS; INSTANT MESSAGING SERVICES; INTERNATIONAL TELEPHONE SERVICES; INTERSTATE TELEPHONE SERVICES; INTRASTATE TELEPHONE SERVICES; LOCAL AND LONG DISTANCE TELEPHONE SERVICES; LONG DISTANCE TELEPHONE COMMUNICATION SERVICES; MOBILE TELEPHONE COMMUNICATION; MOBILE TELEPHONY; NETWORK CONFERENCING SERVICES; PREPAID LONG DISTANCE TELEPHONE SERVICES; PROVIDING ACCESS TO TELECOMMUNICATION NETWORKS; PROVIDING ELECTRONIC TELECOMMUNICATION CONNECTIONS; PROVIDING E-MAIL SERVICES; PROVIDING FACILITIES AND EQUIPMENT FOR VIDEO CONFERENCING; PROVIDING MULTIPLE USE ACCESS TO GLOBAL COMPUTER INFORMATION NETWORKS FOR THE TRANSFER AND DISSEMINATION OF A WIDE RANGE OF INFORMATION; PROVIDING MULTIPLE-USER ACCESS TO A GLOBAL COMPUTER INFORMATION NETWORK; PROVIDING ON-LINE COMMUNICATIONS LINKS WHICH TRANSFER THE WEBSITE USER TO OTHER LOCAL AND GLOBAL WEB PAGES; PROVIDING TELECOMMUNICATIONS CONNECTIONS TO A GLOBAL COMPUTER NETWORK; PROVIDING TELEPHONE CONFERENCING SERVICES; PROVIDING THIRD PARTY USERS WITH ACCESS TO TELECOMMUNICATION INFRASTRUCTURE; PROVISION OF ACCESS TO DATA OR DOCUMENTS STORED ELECTRONICALLY IN CENTRAL FILES FOR REMOTE CONSULTATION; PROVISION OF ACCESS TO ELECTRONIC SITES; RADIO, TELEPHONE, TELEGRAPH COMMUNICATION SERVICES; RADIO/TELEPHONE PAGING SERVICES; SATELLITE, CABLE, NETWORK TRANSMISSION OF SOUNDS, IMAGES, SIGNALS AND DATA; SECURE E-MAIL SERVICES; SIGNAL TRANSMISSION FOR ELECTRONIC COMMERCE VIA TELECOMMUNICATION SYSTEMS AND DATA COMMUNICATION SYSTEMS; STREAMING OF AUDIO MATERIAL ON THE INTERNET; STREAMING OF VIDEO MATERIAL ON THE INTERNET; TELECOMMUNICATION ACCESS SERVICES; TELECOMMUNICATION SERVICES, NAMELY, LOCAL AND LONG DISTANCE TRANSMISSION OF VOICE, DATA, GRAPHICS BY MEANS OF TELEPHONE, TELEGRAPHIC, CABLE, AND SATELLITE TRANSMISSIONS; TELECOMMUNICATION SERVICES IN THE FIELD OF PROVIDING LONG DISTANCE SERVICE WITH AUDIO ADVERTISING FOR OTHERS AS A COMPONENT OF THE LONG DISTANCE SERVICE; TELECOMMUNICATIONS BY E-MAIL; TELECOMMUNICATIONS RESELLER SERVICES, NAMELY, PROVIDING LONG DISTANCE TELECOMMUNICATION SERVICES; TELEPHONE COMMUNICATION SERVICES; TELEPHONE VOICE MESSAGING SERVICES; TEXT AND NUMERIC WIRELESS DIGITAL MESSAGING SERVICES; TRANSFER OF DATA BY TELECOMMUNICATION; TRANSFER OF DATA BY TELECOMMUNICATIONS; TRANSMISSION OF DATA, SOUND AND IMAGES BY SATELLITE; TRANSMISSION OF DATABASE INFORMATION VIA TELECOMMUNICATIONS NETWORKS; TRANSMISSION OF INFORMATION BY ELECTRONIC COMMUNICATIONS NETWORKS; TRANSMISSION OF INFORMATION IN THE AUDIO-VISUAL FIELD; TRANSMISSION OF INFORMATION THROUGH VIDEO COMMUNICATION SYSTEMS; TRANSMISSION OF INFORMATION VIA NATIONAL AND INTERNATIONAL NETWORKS; TRANSMISSION OF MESSAGES OVER ELECTRONIC MEDIA; TRANSMISSION OF NEWS; TRANSMISSION OF SHORT MESSAGES; TRANSMISSION OF SOUND AND VISION VIA SATELLITE OR INTERACTIVE MULTIMEDIA NETWORKS; TRANSMISSION OF SOUND PICTURE AND DATA SIGNALS; TRANSMISSION OF SOUND, VIDEO AND INFORMATION; TRANSMISSION OF STOCK MARKET INFORMATION WITH THE HELP OF TELECOMMUNICATIONS MEDIA; VIDEO BROADCASTING; VIDEO TELECONFERENCING; VIDEO-ON-DEMAND TRANSMISSION SERVICES; VIRTUAL CHATROOMS ESTABLISHED VIA TEXT MESSAGING; VOICE MAIL SERVICES; VOICE OVER INTERNET PROTOCOL (VOIP) SERVICES; VOICE OVER IP SERVICES; VOICE TELECOMMUNICATION; VOICE ACTIVATED DIALING SERVICES; WEB MESSAGING; WEB SITE FORWARDING SERVICES; WEBCASTING SERVICES; WIRELESS BROADBAND COMMUNICATION SERVICES; WIRELESS COMMUNICATIONS SERVICES, NAMELY, TRANSMISSION OF GRAPHICS TO MOBILE TELEPHONES; WIRELESS DIGITAL MESSAGING SERVICES; WIRELESS ELECTRONIC TRANSMISSION OF VOICE SIGNALS, DATA, FACSIMILES, IMAGES AND INFOR-

MATION; WIRELESS VOICE MAIL SERVICES; WORLD-WIDE SWITCHED TEXT AND MESSAGE TRANSMISSION SERVICES (U.S. CLS. 100, 101 AND 104).

CLASS 41—EDUCATION AND ENTERTAINMENT

FOR ONLINE JOURNALS, NAMELY, BLOGS FEATURING CONTENT FROM MOBILE USERS IN THE FIELDS OF GENERAL INTEREST INFORMATION, MUSIC, SPORTS, ENTERTAINMENT AND NEWS EVENTS VIA COMPUTER NETWORKS, WIRED AND WIRELESS NETWORKS (U.S. CLS. 100, 101 AND 107).
LINDA ORNDORFF, EXAMINING ATTORNEY

SN 77-161,220. FIND A MEANING, NEW YORK, NY. FILED 4-19-2007.

Find A Meaning

THE MARK CONSISTS OF STANDARD CHARACTERS WITHOUT CLAIM TO ANY PARTICULAR FONT, STYLE, SIZE, OR COLOR.

CLASS 16—PAPER GOODS AND PRINTED MATTER

FOR POSTERS MADE OF PAPER; STICKERS; POSTER BOARD; POSTERS (U.S. CLS. 2, 5, 22, 23, 29, 37, 38 AND 50).

CLASS 25—CLOTHING

FOR JEANS; SHIRT FRONTS; SHIRTS; SWEAT SHIRTS; T-SHIRTS; PANTS; SHORT-SLEEVED OR LONG-SLEEVED T-SHIRTS; SHORT-SLEEVED SHIRTS; BASEBALL CAPS; CAPS WITH VISORS; HATS; HEADGEAR, NAMELY, BASEBALL CAPS; KNITTED CAPS (U.S. CLS. 22 AND 39).

KATHRYN COWARD, EXAMINING ATTORNEY

SN 77-161,320. WEAVER, RONIECE A., WINDERMERE, FL. AND RONIECE WEAVER AND ASSOCIATES, WINDERMERE, FL. FILED 4-19-2007.

Our Foods Our Weigh

THE MARK CONSISTS OF STANDARD CHARACTERS WITHOUT CLAIM TO ANY PARTICULAR FONT, STYLE, SIZE, OR COLOR.

CLASS 21—HOUSEWARES AND GLASS

FOR BIODEGRADABLE PAPER PULP-BASED PLATES, BOWLS AND CUPS; BOWLS; CARDBOARD CUPS; CERAMIC SCULPTURES, VASES, VESSELS, BOWLS, PLATES AND POTS; COFFEE CUPS; COMMEMORATIVE PLATES; CUPS; DECORATIVE PLATES; DINNERWARE; DINNERWARE, NAMELY, PLATES, CUPS, SAUCERS, AND BOWLS MADE OF PAPER, PLASTIC OR CERAMIC COMPOSITIONS; DISHES AND PLATES; DISPOSABLE TABLE PLATES; DRINKING CUPS; EARTHENWARE BASINS; FRUIT BOWLS; FRUIT BOWLS OF GLASS; GLASS BOWLS; PAPER CUPS; PAPER PLATES; PLASTIC CUPS; PLASTIC PLATES; PLATES; PLATES FOR HORS D'OEUVRE; SALAD BOWLS; SALAD BOWLS; SAUCERS; SAUCERS NOT OF PRECIOUS METALS; SERVING BOWLS (HACHI); SHALLOW BOWLS (U.S. CLS. 2, 13, 23, 29, 30, 33, 40 AND 50).

CLASS 42—SCIENTIFIC AND COMPUTER SERVICES

FOR DESIGN SKETCHING OF PACKAGING, CONTAINERS, DINNERWARE AND TABLE UTENSILS (U.S. CLS. 100 AND 101).

CHRIS DONINGER, EXAMINING ATTORNEY

CLASS 35—ADVERTISING AND BUSINESS

FOR ADVERTISING AGENCIES; ADVERTISING AGENCIES, NAMELY, PROMOTING THE GOODS AND SERVICES OF OTHERS; ADVERTISING AND ADVERTISEMENT SERVICES; ADVERTISING AND MARKETING; ADVERTISING AND PROMOTION SERVICES AND RELATED CONSULTING; ADVERTISING AND PUBLICITY SERVICES; ADVERTISING AND PUBLICITY SERVICES, NAMELY, PROMOTING THE GOODS, SERVICES, BRAND IDENTITY AND COMMERCIAL INFORMATION AND NEWS OF THIRD PARTIES THROUGH PRINT, AUDIO, VIDEO, DIGITAL AND ON-LINE MEDIUM; ADVERTISING CONSULTATION; ADVERTISING PARTICULARLY SERVICES FOR THE PROMOTION OF GOODS; ADVERTISING SERVICES; ADVERTISING SERVICES, NAMELY, CREATING CORPORATE AND BRAND IDENTITY FOR OTHERS; ADVERTISING SERVICES, NAMELY, CREATING CORPORATE LOGOS FOR OTHERS; ADVERTISING SERVICES, NAMELY, PROMOTING AND MARKETING THE GOODS AND SERVICES OF OTHERS THROUGH ALL PUBLIC COMMUNICATION MEANS; ADVERTISING THROUGH ALL PUBLIC COMMUNICATION MEANS; ADVERTISING VIA ELECTRONIC MEDIA AND SPECIFICALLY THE INTERNET; ADVERTISING, MARKETING AND PROMOTION SERVICES; COOPERATIVE ADVERTISING AND MARKETING; COOPERATIVE ADVERTISING AND MARKETING SERVICES BY WAY OF SOLICITATION, CUSTOMER SERVICE AND PROVIDING MARKETING INFORMATION VIA WEBSITES ON A GLOBAL COMPUTER NETWORK; CREATING AND UPDATING ADVERTISING MATERIAL; CREATION OF MARKETING TOOLS DESIGNED TO INCREASE A CLIENT COMPANY'S KNOWLEDGE OF CUSTOMER NEEDS, AND ITS COMPETITORS' PRODUCTS AND SERVICES, PRICING, ADVERTISING STRATEGY AND SALES STRATEGY; DESIGN OF ADVERTISING MATERIALS FOR OTHERS; DESIGN OF INTERNET ADVERTISING; DIRECT MARKETING ADVERTISING FOR OTHERS; LAYOUT SERVICES FOR ADVERTISING PURPOSES; PREPARATION OF CUSTOM ADVERTISEMENTS FOR OTHERS; PREPARING ADVERTISEMENTS FOR OTHERS; PREPARING AUDIO-VISUAL PRESENTATIONS FOR USE IN ADVERTISING; CREATIVE MARKETING DESIGN SERVICES (U.S. CLS. 100, 101 AND 102).

FIRST USE 12-1-2005; IN COMMERCE 1-1-2006.

SN 77-161,458. CAG DESIGN STUDIO, INC., HACKETTS-TOWN, NJ. FILED 4-20-2007.

CLASS 42—SCIENTIFIC AND COMPUTER SERVICES

FOR DESIGNING WEBSITES FOR ADVERTISING PURPOSES; COMMERCIAL ART DESIGN; COMPUTER AIDED DESIGN FOR OTHERS; DESIGN OF HOMEPAGES AND WEB-SITES; DESIGN OF HOMEPAGES AND WEBSITES; DESIGNING OF PACKAGING AND WRAPPING MATERIALS; GRAPHIC ART DESIGN; GRAPHIC DESIGN SERVICES; PACKAGING DESIGN FOR OTHERS (U.S. CLS. 100 AND 101).

FIRST USE 12-1-2005; IN COMMERCE 1-1-2006.

SANJEEV VOHRA, EXAMINING ATTORNEY

BrandFirst

SN 77-161,545. CAG DESIGN STUDIO, INC., HACKETTS-TOWN, NJ. FILED 4-20-2007.

ThinkFirst

THE MARK CONSISTS OF "BRANDFIRST" AS A COMPOUND WORD; "FIRST" IS IN ITALICS.

THE MARK CONSISTS OF "THINKFIRST" AS A COMPOUND WORD; "FIRST" IS IN ITALICS.

CLASS 35—ADVERTISING AND BUSINESS

FOR ADVERTISING AGENCIES; ADVERTISING AGENCIES, NAMELY, PROMOTING THE GOODS AND SERVICES OF OTHERS; ADVERTISING AND ADVERTISEMENT SERVICES; ADVERTISING AND MARKETING; ADVERTISING AND PROMOTION SERVICES AND RELATED CONSULTING; ADVERTISING AND PUBLICITY SERVICES; ADVERTISING AND PUBLICITY SERVICES, NAMELY, PROMOTING THE GOODS, SERVICES, BRAND IDENTITY AND COMMERCIAL INFORMATION AND NEWS OF THIRD PARTIES THROUGH PRINT, AUDIO, VIDEO, DIGITAL AND ON-LINE MEDIUM; ADVERTISING CONSULTATION; ADVERTISING PARTICULARLY SERVICES FOR THE PROMOTION OF GOODS; ADVERTISING SERVICES; ADVERTISING SERVICES, NAMELY, CREATING CORPORATE AND BRAND IDENTITY FOR OTHERS; ADVERTISING SERVICES, NAMELY, CREATING CORPORATE LOGOS FOR OTHERS; ADVERTISING SERVICES, NAMELY, PROMOTING AND MARKETING THE GOODS AND SERVICES OF OTHERS THROUGH ALL PUBLIC COMMUNICATION MEANS; ADVERTISING THROUGH ALL PUBLIC COMMUNICATION MEANS; ADVERTISING VIA ELECTRONIC MEDIA AND SPECIFICALLY THE INTERNET; ADVERTISING, MARKETING AND PROMOTION SERVICES; COOPERATIVE ADVERTISING AND MARKETING; COOPERATIVE ADVERTISING AND MARKETING SERVICES BY WAY OF SOLICITATION, CUSTOMER SERVICE AND PROVIDING MARKETING INFORMATION VIA WEBSITES ON A GLOBAL COMPUTER NETWORK; CREATING AND UPDATING ADVERTISING MATERIAL; CREATION OF MARKETING TOOLS DESIGNED TO INCREASE A CLIENT COMPANY'S KNOWLEDGE OF CUSTOMER NEEDS, AND ITS COMPETITORS' PRODUCTS AND SERVICES, PRICING, ADVERTISING STRATEGY AND SALES STRATEGY; DESIGN OF ADVERTISING MATERIALS FOR OTHERS; DESIGN OF INTERNET ADVERTISING; DIRECT MARKETING ADVERTISING FOR OTHERS; LAYOUT SERVICES FOR ADVERTISING PURPOSES; PREPARATION AND REALIZATION OF MEDIA AND ADVERTISING PLANS AND CONCEPTS; PREPARATION OF CUSTOM ADVERTISEMENTS FOR OTHERS; PREPARING ADVERTISEMENTS FOR OTHERS; PREPARING AUDIO-VISUAL PRESENTATIONS FOR USE IN ADVERTISING; CREATIVE MARKETING DESIGN SERVICES (U.S. CLS. 100, 101 AND 102).

FIRST USE 12-1-2005; IN COMMERCE 1-1-2006.

CLASS 42—SCIENTIFIC AND COMPUTER SERVICES

FOR DESIGNING WEBSITES FOR ADVERTISING PURPOSES; COMMERCIAL ART DESIGN; COMPUTER AIDED DESIGN FOR OTHERS; DESIGN OF HOMEPAGES AND WEBSITES; DESIGNING OF PACKAGING AND WRAPPING MATERIALS; GRAPHIC ART DESIGN; GRAPHIC DESIGN SERVICES; PACKAGING DESIGN FOR OTHERS (U.S. CLS. 100 AND 101).

FIRST USE 12-1-2005; IN COMMERCE 1-1-2006.
SANJEEV VOHRA, EXAMINING ATTORNEY

CLASS 35—ADVERTISING AND BUSINESS

FOR ADVERTISING AGENCIES; ADVERTISING AGENCIES, NAMELY, PROMOTING THE GOODS AND SERVICES OF OTHERS; ADVERTISING AND ADVERTISEMENT SERVICES; ADVERTISING AND MARKETING; ADVERTISING AND PROMOTION SERVICES AND RELATED CONSULTING; ADVERTISING AND PUBLICITY SERVICES; ADVERTISING AND PUBLICITY SERVICES, NAMELY, PROMOTING THE GOODS, SERVICES, BRAND IDENTITY AND COMMERCIAL INFORMATION AND NEWS OF THIRD PARTIES THROUGH PRINT, AUDIO, VIDEO, DIGITAL AND ON-LINE MEDIUM; ADVERTISING CONSULTATION; ADVERTISING PARTICULARLY SERVICES FOR THE PROMOTION OF GOODS; ADVERTISING SERVICES; ADVERTISING SERVICES, NAMELY, CREATING CORPORATE AND BRAND IDENTITY FOR OTHERS; ADVERTISING SERVICES, NAMELY, CREATING CORPORATE LOGOS FOR OTHERS; ADVERTISING SERVICES, NAMELY, PROMOTING AND MARKETING THE GOODS AND SERVICES OF OTHERS THROUGH ALL PUBLIC COMMUNICATION MEANS; ADVERTISING THROUGH ALL PUBLIC COMMUNICATION MEANS; ADVERTISING VIA ELECTRONIC MEDIA AND SPECIFICALLY THE INTERNET; ADVERTISING, MARKETING AND PROMOTION SERVICES; COOPERATIVE ADVERTISING AND MARKETING; COOPERATIVE ADVERTISING AND MARKETING SERVICES BY WAY OF SOLICITATION, CUSTOMER SERVICE AND PROVIDING MARKETING INFORMATION VIA WEBSITES ON A GLOBAL COMPUTER NETWORK; CREATING AND UPDATING ADVERTISING MATERIAL; CREATION OF MARKETING TOOLS DESIGNED TO INCREASE A CLIENT COMPANY'S KNOWLEDGE OF CUSTOMER NEEDS, AND ITS COMPETITORS' PRODUCTS AND SERVICES, PRICING, ADVERTISING STRATEGY AND SALES STRATEGY; DESIGN OF ADVERTISING MATERIALS FOR OTHERS; DESIGN OF INTERNET ADVERTISING; DIRECT MARKETING ADVERTISING FOR OTHERS; LAYOUT SERVICES FOR ADVERTISING PURPOSES; PREPARATION AND REALIZATION OF MEDIA AND ADVERTISING PLANS AND CONCEPTS; PREPARATION OF CUSTOM ADVERTISEMENTS FOR OTHERS; PREPARING ADVERTISEMENTS FOR OTHERS; PREPARING AUDIO-VISUAL PRESENTATIONS FOR USE IN ADVERTISING; CREATIVE MARKETING DESIGN SERVICES (U.S. CLS. 100, 101 AND 102).

FIRST USE 12-1-2005; IN COMMERCE 1-1-2006.

CLASS 42—SCIENTIFIC AND COMPUTER SERVICES

FOR DESIGNING WEBSITES FOR ADVERTISING PURPOSES; COMMERCIAL ART DESIGN; COMPUTER AIDED DESIGN FOR OTHERS; DESIGN OF HOMEPAGES AND WEBSITES; DESIGNING OF PACKAGING AND WRAPPING MATERIALS; GRAPHIC ART DESIGN; GRAPHIC DESIGN SERVICES; PACKAGING DESIGN FOR OTHERS (U.S. CLS. 100 AND 101).

FIRST USE 12-1-2005; IN COMMERCE 1-1-2006.
SANJEEV VOHRA, EXAMINING ATTORNEY

SN 77-161,714. CAG DESIGN STUDIO, INC., HACKETTSTOWN, NJ. FILED 4-20-2007.

SN 77-161,969. THE LUTHERAN CHURCH-MISSOURI SYNOD, KIRKWOOD, MO. FILED 4-20-2007.

Start Strong. Finish *First*.

THE 72

THE MARK CONSISTS OF "START STRONG. FINISHFIRST," WHERE "FINISHFIRST" APPEARS AS A COMPOUND WORD AND "FIRST" IS IN ITALICS.

THE MARK CONSISTS OF STANDARD CHARACTERS WITHOUT CLAIM TO ANY PARTICULAR FONT, STYLE, SIZE, OR COLOR.

CLASS 36—INSURANCE AND FINANCIAL

FOR CHARITABLE FUND RAISING SERVICES (U.S. CLS. 100, 101 AND 102).

CLASS 41—EDUCATION AND ENTERTAINMENT

FOR TRAINING PROGRAMS IN THE FIELD OF MISSIONARY, EVANGELISTIC AND MINISTERIAL SERVICES (U.S. CLS. 100, 101 AND 107).

CLASS 45—PERSONAL AND LEGAL SERVICES

FOR RELIGIOUS SERVICES, NAMELY, MISSIONARY, EVANGELISTIC AND MINISTERIAL SERVICES (U.S. CLS. 100 AND 101).

LYDIA BELZER, EXAMINING ATTORNEY

SN 77-161,974. THE LUTHERAN CHURCH-MISSOURI SYNOD, KIRKWOOD, MO. FILED 4-20-2007.

PARTNERS ON THE ROAD

THE MARK CONSISTS OF STANDARD CHARACTERS WITHOUT CLAIM TO ANY PARTICULAR FONT, STYLE, SIZE, OR COLOR.

CLASS 36—INSURANCE AND FINANCIAL

FOR CHARITABLE FUND RAISING SERVICES (U.S. CLS. 100, 101 AND 102).

CLASS 41—EDUCATION AND ENTERTAINMENT

FOR TRAINING PROGRAMS IN THE FIELD OF MISSIONARY, EVANGELISTIC AND MINISTERIAL SERVICES (U.S. CLS. 100, 101 AND 107).

CLASS 45—PERSONAL AND LEGAL SERVICES

FOR RELIGIOUS SERVICES, NAMELY, MISSIONARY, EVANGELISTIC AND MINISTERIAL SERVICES (U.S. CLS. 100 AND 101).

LYDIA BELZER, EXAMINING ATTORNEY

SN 77-162,200. BOUNCING CRANBERRIES LLC, NARRAGANSETT, RI. FILED 4-20-2007.

GAGASTICK

THE MARK CONSISTS OF STANDARD CHARACTERS WITHOUT CLAIM TO ANY PARTICULAR FONT, STYLE, SIZE, OR COLOR.

CLASS 16—PAPER GOODS AND PRINTED MATTER

FOR CARTOON PRINTS; PHOTOGRAPHIC PRINTS; BUSINESS CARDS; SOCIAL NOTE CARDS; CARDS BEARING UNIVERSAL GREETINGS; GREETING CARDS; TRADING CARDS; STATIONERY; ANNOUNCEMENT CARDS; CARD FILES; CHRISTMAS CARDS; HOLIDAY CARDS; INVITATION CARDS; MOTIVATIONAL CARDS; NOTE CARDS; OCCASION CARDS; PLACE CARDS; BOXES OF PAPER OR CARDBOARD; CARDBOARD BOXES; PAPER BOXES; PAPER BOXES FOR STORING GREETING CARDS (U.S. CLS. 2, 5, 22, 23, 29, 37, 38 AND 50).

CLASS 35—ADVERTISING AND BUSINESS

FOR ADVERTISING AND ADVERTISEMENT SERVICES; ADVERTISING AND MARKETING; ADVERTISING AND PUBLICITY SERVICES; ADVERTISING PARTICULARLY SERVICES FOR THE PROMOTION OF GOODS; ADVERTISING SERVICES; ADVERTISING SERVICES, NAMELY, PROMOTING AND MARKETING THE GOODS AND SERVICES OF OTHERS THROUGH ALL PUBLIC COMMUNICATION MEANS; ADVERTISING VIA ELECTRONIC MEDIA AND SPECIFICALLY THE INTERNET; ADVERTISING, MARKETING AND PROMOTION SERVICES; DESIGN OF ADVERTISING MATERIALS FOR OTHERS (U.S. CLS. 100, 101 AND 102).

RAY THOMAS, EXAMINING ATTORNEY

SN 77-162,216. CIRCLE K STORES INC., TEMPE, AZ. FILED 4-20-2007.



THE MARK CONSISTS OF THE WORDS DOWN HOME KITCHEN AND THE DESIGN OF A CHICKEN IN A CIRCLE, THE WHOLE ENCLOSED IN A RECTANGLE SHAPE.

CLASS 29—MEATS AND PROCESSED FOODS

FOR PREPARED OR PACKAGED MEALS CONSISTING PRIMARILY OF MEAT, FISH, POULTRY, VEGETABLES OR EGGS; MARINATED MEATS, SEAFOOD, FISH, POULTRY, OR VEGETABLES; POTATO PANCAKES; FRIED POTATOES; POTATOES CRISPS; LIVER; PROCESSED MEAT; PREPARED MEAT; BAKED BEANS; DRIED BEANS; VEGETABLE-BASED SNACK FOOD; JELLIES; POTATO SALAD, GARDEN SALADS, VEGETABLE SALADS, FRUIT SALADS; DAIRY-BASED SNACK FOODS EXCLUDING ICE CREAM, ICE MILK AND FROZEN YOGURT; MILK AND MILK BASED-BEVERAGES (U.S. CL. 46).

CLASS 30—STAPLE FOODS

FOR PREPARED OR PACKAGED MEALS CONSISTING PRIMARILY OF PASTA OR RICE; GRITS; PANCAKES; FRENCH TOASTS; BISCUITS; BREAKFAST CEREALS; CEREAL BASED SNACK FOOD; MEAT GRAVIES; PREPARED MEAT PIES; BREAD; SWEET BAKERY GOODS; PREPARED SANDWICHES; PASTA SALADS, RICE SALADS; PREPARED COFFEE AND COFFEE-BASED BEVERAGES; TEA (U.S. CL. 46).

CLASS 43—HOTEL AND RESTAURANT SERVICES

FOR RESTAURANT SERVICES; TAKE-OUT RESTAURANT SERVICES; CAFE AND COFFEE-HOUSE SERVICES (U.S. CLS. 100 AND 101).

KEVIN DINALLO, EXAMINING ATTORNEY

CLASS 16—PAPER GOODS AND PRINTED MATTER

FOR PRINTED MATERIALS, NAMELY FLIERS, BROCHURES, MAGAZINES, PAMPHLETS, PAPER LABELS, DECALS, AND INSERTS, IN THE FIELD OF HEALTH, BEAUTY, FASHION, COSMETICS, FITNESS AND DIETARY SUPPLEMENTS (U.S. CLS. 2, 5, 22, 23, 29, 37, 38 AND 50).

JILL PRATER, EXAMINING ATTORNEY

SN 77-162,621. CHEF MERITO, INC., VAN NUYS, CA. FILED 4-22-2007.

SN 77-163,160. WESTERN HOLDINGS, LLC., CHEYENNE, WY. FILED 4-23-2007.



OWNER OF U.S. REG. NO. 1,777,939.
THE MARK CONSISTS OF THE WORD PIKOS WITH A SPECIAL DESIGN SIMILAR TO A ROOSTER'S COMB APPEARING ABOVE THE WORD.

CLASS 25—CLOTHING

FOR CAPS; SHIRTS; SHORTS; SWEAT PANTS; T-SHIRTS (U.S. CLS. 22 AND 39).

CLASS 29—MEATS AND PROCESSED FOODS

FOR DRIED FRUITS; SNACK MIX CONSISTING PRIMARILY OF PROCESSED FRUITS, PROCESSED NUTS AND/OR RAISINS; PROCESSED NUTS; ROASTED NUTS (U.S. CL. 46).

CLASS 30—STAPLE FOODS

FOR SAUCES; SEASONINGS; SPICES (U.S. CL. 46).
LAURIE MAYES, EXAMINING ATTORNEY

SN 77-163,152. WESTERN HOLDINGS, LLC., CHEYENNE, WY. FILED 4-23-2007.

AND WE COULDN'T SAY IT ON
TV

THE MARK CONSISTS OF STANDARD CHARACTERS WITHOUT CLAIM TO ANY PARTICULAR FONT, STYLE, SIZE, OR COLOR.

CLASS 5—PHARMACEUTICALS

FOR DIETARY SUPPLEMENTS (U.S. CLS. 6, 18, 44, 46, 51 AND 52).

AND WE COULDN'T SAY IT ON
RADIO

THE MARK CONSISTS OF STANDARD CHARACTERS WITHOUT CLAIM TO ANY PARTICULAR FONT, STYLE, SIZE, OR COLOR.

CLASS 5—PHARMACEUTICALS

FOR DIETARY SUPPLEMENTS (U.S. CLS. 6, 18, 44, 46, 51 AND 52).

CLASS 16—PAPER GOODS AND PRINTED MATTER

FOR PRINTED MATERIALS, NAMELY FLIERS, BROCHURES, MAGAZINES, PAMPHLETS, PAPER LABELS, DECALS, AND INSERTS, IN THE FIELD OF HEALTH, BEAUTY, FASHION, COSMETICS, FITNESS AND DIETARY SUPPLEMENTS (U.S. CLS. 2, 5, 22, 23, 29, 37, 38 AND 50).

JILL PRATER, EXAMINING ATTORNEY

SN 77-163,376. FLUM, PAUL L., ST. LOUIS, MO. FILED 4-23-2007.

ACPAC AMERICAN CITIZENS
POLITICAL ACTION COMMITTEE

THE MARK CONSISTS OF STANDARD CHARACTERS WITHOUT CLAIM TO ANY PARTICULAR FONT, STYLE, SIZE, OR COLOR.

NO CLAIM IS MADE TO THE EXCLUSIVE RIGHT TO USE "AMERICAN CITIZENS POLITICAL ACTION COMMITTEE", APART FROM THE MARK AS SHOWN.

CLASS 16—PAPER GOODS AND PRINTED MATTER

FOR PRINTED MATERIALS, NAMELY, ARTICLES, BOOKLETS, PAMPHLETS, BROCHURES, MAGAZINES, AND BOOKS PUBLISHED PERIODICALLY ON MATTERS RELATING TO WORLD PEACE, NATIONAL SECURITY, EDUCATION, ECOLOGY, MILITARY AFFAIRS, HUMAN RIGHTS, HEALTH AND NUTRITION, COMMERCE, NATURE AND THE ENVIRONMENT, HUMAN SERVICES ECONOMICS AND BUSINESS, JUSTICE AND POLITICS (U.S. CLS. 2, 5, 22, 23, 29, 37, 38 AND 50).

CLASS 41—EDUCATION AND ENTERTAINMENT

FOR PROVIDING ON-LINE PUBLICATIONS IN THE NATURE OF ARTICLES, BOOKLETS, PAMPHLETS, BROCHURES, MAGAZINES, AND BOOKS IN THE FIELD OF INFORMATION RELATING TO WORLD PEACE, NATIONAL SECURITY, EDUCATION, ECOLOGY, MILITARY AFFAIRS, HUMAN RIGHTS, HEALTH AND NUTRITION, COMMERCE, NATURE AND THE ENVIRONMENT, HUMAN SERVICES ECONOMICS AND BUSINESS, JUSTICE AND POLITICS (U.S. CLS. 100, 101 AND 107).

JENNIFER MARTIN, EXAMINING ATTORNEY

SN 77-164,374. KABUSHIKI KAISHA SQUARE ENIX, TA SQUARE ENIX CO., LTD., TOKYO, JAPAN, FILED 4-24-2007.

THE LAST REMNANT

THE MARK CONSISTS OF STANDARD CHARACTERS WITHOUT CLAIM TO ANY PARTICULAR FONT, STYLE, SIZE, OR COLOR.

SN 77-164,199. AFTI, LLC., MIAMI, FL. AND AERONAUTICAL SYSTEMS ENGINEERING INC., ODESSA, FL. FILED 4-24-2007.

Very Lite Simulator (VLS)

THE MARK CONSISTS OF STANDARD CHARACTERS WITHOUT CLAIM TO ANY PARTICULAR FONT, STYLE, SIZE, OR COLOR.

NO CLAIM IS MADE TO THE EXCLUSIVE RIGHT TO USE "VERY LITE SIMULATOR", APART FROM THE MARK AS SHOWN.

CLASS 9—ELECTRICAL AND SCIENTIFIC APPARATUS

FOR FLIGHT SIMULATORS FOR AIRCRAFT (U.S. CLS. 21, 23, 26, 36 AND 38).

CLASS 41—EDUCATION AND ENTERTAINMENT

FOR AIRPLANE FLIGHT INSTRUCTION (U.S. CLS. 100, 101 AND 107).

JUDITH HELFMAN, EXAMINING ATTORNEY

CLASS 9—ELECTRICAL AND SCIENTIFIC APPARATUS

FOR COMPUTER GAME SOFTWARE; VIDEO GAME SOFTWARE; SOUND RECORDINGS IN THE FORM OF OPTICAL DISCS, MAGNETIC DISCS AND SEMICONDUCTOR ROMS FEATURING MUSIC AND/OR FICTIONAL STORIES; AUDIO VISUAL RECORDINGS IN THE FORM OF OPTICAL DISCS, MAGNETIC DISCS AND SEMICONDUCTOR ROMS FEATURING MUSIC AND/OR ANIMATED FICTIONAL STORIES; PRERECORDED COMPACT DISCS FEATURING MUSIC; PRERECORDED VIDEO DISCS FEATURING MUSIC AND/OR ANIMATED FICTIONAL STORIES; PRERECORDED VIDEO CASSETTES FEATURING MUSIC AND/OR ANIMATED FICTIONAL STORIES; DECORATIVE MAGNETS, MOUSE PADS; STRAPS FOR CELLULAR PHONES; SUNGLASSES; BLANK MEMORY CARDS; MEMORY CARD CASES; CD CASES; VIDEO GAME CONTROLLERS; DOWNLOADABLE COMPUTER GRAPHIC SOFTWARE CONTAINING WALLPAPERS FOR COMPUTERS OR MOBILE PHONES; DOWNLOADABLE SCREENSAVERS FOR COMPUTERS AND/OR MOBILE PHONES; DOWNLOADABLE VIDEO RECORDINGS FEATURING CARTOON CHARACTERS AND/OR VIDEO GAME CHARACTERS; DOWNLOADABLE MUSICAL SOUND RECORDINGS; DOWNLOADABLE SOUND RECORDINGS USING HUMAN VOICES FEATURING MORNING CALLS OR WAKE-UP CALL MESSAGES; DOWNLOADABLE RING TONES FOR MOBILE PHONES; DOWNLOADABLE ELECTRONIC PUBLICATIONS IN THE NATURE OF MAGAZINES, JOURNALS OR NEWSLETTERS IN THE FIELD OF COMPUTER GAMES, VIDEO GAMES, CARTOONS AND GENERAL ENTERTAINMENT (U.S. CLS. 21, 23, 26, 36 AND 38).

SN 77-164,299. AFTI, LLC., MIAMI, FL. FILED 4-24-2007.

THE AVENGER

THE MARK CONSISTS OF STANDARD CHARACTERS WITHOUT CLAIM TO ANY PARTICULAR FONT, STYLE, SIZE, OR COLOR.

CLASS 9—ELECTRICAL AND SCIENTIFIC APPARATUS

FOR FLIGHT SIMULATORS FOR AIRCRAFT (U.S. CLS. 21, 23, 26, 36 AND 38).

CLASS 41—EDUCATION AND ENTERTAINMENT

FOR AIRPLANE FLIGHT INSTRUCTION (U.S. CLS. 100, 101 AND 107).

JUDITH HELFMAN, EXAMINING ATTORNEY

CLASS 16—PAPER GOODS AND PRINTED MATTER

FOR COMPUTER GAME STRATEGY GUIDE BOOKS; VIDEO GAME STRATEGY GUIDEBOOKS; SERIES OF BOOKS FEATURING FICTIONAL OR FANTASY STORIES; GRAPHIC ART BOOKS; SONG BOOKS; MUSICAL SCORE BOOKS; COMIC BOOKS; MAGAZINES FEATURING COMPUTER GAMES, VIDEO GAMES OR CARTOONS; POSTERS; STICKERS; PAPER BANNERS; CALENDARS; POST CARDS; PENS; PENCILS; PENCIL CAPS; PEN CASES; DRAWING RULERS; RUBBER STAMPS; NOTEBOOKS; COLLECTORS' CARDS; TRADING CARDS; PHOTOGRAPHS (U.S. CLS. 2, 5, 22, 23, 29, 37, 38 AND 50).

CLASS 28—TOYS AND SPORTING GOODS

FOR DOLLS; TOY FIGURES; PLUSH TOYS; STUFFED TOYS; INFLATABLE TOYS; TOY VEHICLES; TOY GUNS; TOY SWORDS; PLAYING CARDS; CARD GAMES; BOARD GAMES; JIGSAW PUZZLES; HAND HELD VIDEO GAME UNITS (U.S. CLS. 22, 23, 38 AND 50).

SCOTT BIBB, EXAMINING ATTORNEY

SN 77-164,931. WEATHERGUARD BUILDING PRODUCTS, INC., WEST PALM BEACH, FL. FILED 4-25-2007.

USSA

THE MARK CONSISTS OF STANDARD CHARACTERS WITHOUT CLAIM TO ANY PARTICULAR FONT, STYLE, SIZE, OR COLOR.

CLASS 6—METAL GOODS

FOR PROTECTIVE AND SECURITY METAL WINDOWS, METAL DOORS, AND METAL BUILDING SHUTTERS (U.S. CLS. 2, 12, 13, 14, 23, 25 AND 50).

CLASS 19—NON-METALLIC BUILDING MATERIALS

FOR PROTECTIVE AND SECURITY NON-METAL WINDOWS, NON-METAL DOORS, AND NON-METAL BUILDING SHUTTERS (U.S. CLS. 1, 12, 33 AND 50).

CLASS 35—ADVERTISING AND BUSINESS

FOR ASSOCIATION SERVICES, NAMELY, PROMOTING THE INTERESTS OF MANUFACTURERS AND SUPPLIERS OF COMPONENTS OF WIND, STORM HURRICANE METAL PROTECTIVE AND SECURITY WINDOW, DOOR AND BUILDING SHUTTERS (U.S. CLS. 100, 101 AND 102).

ANGELA GAW, EXAMINING ATTORNEY

SN 77-165,394. RED HAT, INC., RALEIGH, NC. FILED 4-25-2007.

RHX

THE MARK CONSISTS OF STANDARD CHARACTERS WITHOUT CLAIM TO ANY PARTICULAR FONT, STYLE, SIZE, OR COLOR.

CLASS 9—ELECTRICAL AND SCIENTIFIC APPARATUS

FOR COMPUTER SOFTWARE, NAMELY, COMPUTER PROGRAMS FOR OPERATING SYSTEMS, COMPUTER PROGRAMS FOR SYSTEM ADMINISTRATION, COMPUTER PROGRAMS FOR NETWORK ADMINISTRATION SERVICES DELIVERED OVER A GLOBAL COMPUTER NETWORK, NAMELY, SOFTWARE USED TO PROVIDE SOFTWARE MAINTENANCE, UPDATES AND ENHANCEMENTS AND SOFTWARE USED TO PROVIDE NETWORK SECURITY MAINTENANCE, UPDATES AND ENHANCEMENTS AND SOFTWARE USED FOR MANAGING NETWORK ASSETS; COMPUTER SOFTWARE USED FOR PERFORMANCE MEASUREMENT, BENCHMARKING AND CAPACITY PLANNING OF COMPUTER NETWORKS; COMPUTER SOFTWARE TO FACILITATE ON-LINE COMMERCIAL TRANSACTIONS, NAMELY, SOFTWARE TO PERFORM VERIFICATIONS OF CREDIT CARD AND OTHER TYPES OF NON-CASH TRANSACTIONS OVER A GLOBAL COMPUTER NETWORK; COMPUTER SOFTWARE FOR USE IN DEVELOPMENT, MODIFICATION, DEBUGGING, TROUBLESHOOTING, ENHANCEMENT OF SPEED STABILITY OF COMPUTER SYSTEMS, PROFILING AND SIMULATION OF SOFTWARE; COMPUTER SOFTWARE AND COMPUTER HARDWARE FOR HOST AND EMBEDDED MICROPROCESSOR SYSTEMS FOR USE IN DEVELOPMENT, MODIFICATION, DEBUGGING, TROUBLESHOOTING, PERFORMANCE ENHANCEMENT, PROFILING AND SIMULATION OF SOFTWARE; EMBEDDED SYSTEM COMPUTER HARDWARE, REAL-TIME SYSTEM COMPUTER HARDWARE AND COMPUTER SOFTWARE FOR USE AS AN OPERATING SYSTEM AND FOR USE IN CONTROLLING EMBEDDED COMPUTING DEVICES, NAMELY, CELL PHONES, INTERNET ACCESS DEVICES, PERSONAL DATA ASSISTANTS AND MICROPROCESSORS, IN REAL TIME; EMBEDDED APPLICATION PROGRAMMING INTERFACE SOFTWARE; COMPUTER SOFTWARE DEVELOPMENT TOOLS; INSTRUCTIONAL MANUALS FOR ALL OF THE FOREGOING SOLD AS A UNIT THEREWITH (U.S. CLS. 21, 23, 26, 36 AND 38).

CLASS 35—ADVERTISING AND BUSINESS

FOR COMPUTERIZED ON LINE ORDERING SERVICE FEATURING MULTIMEDIA PRODUCTS AND COMPUTER SOFTWARE IN THE FORM OF COMPACT DISCS, CD ROMS, AND DIRECT DIGITAL TRANSMISSION (U.S. CLS. 100, 101 AND 102).

CLASS 38—COMMUNICATION

FOR PROVIDING ON-LINE ELECTRONIC BULLETIN BOARDS FOR THE TRANSMISSION OF MESSAGES AMONG COMPUTER USERS AND SUBSCRIBERS CONCERNING GENERAL OPEN SOURCE SOFTWARE REVIEWS AND PRICES (U.S. CLS. 100, 101 AND 104).

CLASS 42—SCIENTIFIC AND COMPUTER SERVICES

FOR COMPUTER SERVICES, NAMELY, PROVIDING SEARCH ENGINES FOR OBTAINING DATA ON A GLOBAL COMPUTER NETWORK (U.S. CLS. 100 AND 101).

LINDA M. KING, EXAMINING ATTORNEY

SN 77-165,445. GEMOLOGY HEADQUARTERS INTERNATIONAL, LLC, WILMINGTON, DE. FILED 4-25-2007.

SN 77-166,308. AMERICAN MANAGEMENT ASSOCIATION INTERNATIONAL, NEW YORK, NY. FILED 4-26-2007.

CMP SYSTEM

THE MARK CONSISTS OF STANDARD CHARACTERS WITHOUT CLAIM TO ANY PARTICULAR FONT, STYLE, SIZE, OR COLOR.

NO CLAIM IS MADE TO THE EXCLUSIVE RIGHT TO USE "SYSTEM", APART FROM THE MARK AS SHOWN.

CLASS 16—PAPER GOODS AND PRINTED MATTER

FOR PRINTED CERTIFICATES OF AUTHENTICITY OF JEWELRY; PRINTED CERTIFICATES OF GRADING OF JEWELRY (U.S. CLS. 2, 5, 22, 23, 29, 37, 38 AND 50).

CLASS 42—SCIENTIFIC AND COMPUTER SERVICES

FOR PROVIDING IDENTIFICATION, AUTHENTICATION, AND GRADING OF JEWELRY; ISSUING PRINTED AND ELECTRONIC CERTIFICATES RELATING TO SUCH JEWELRY GRADING; PRECIOUS METAL ASSAYING (U.S. CLS. 100 AND 101).
TONI HICKEY, EXAMINING ATTORNEY

SN 77-166,020. CLINSYS CLINICAL RESEARCH, INC., BERKELEY HEIGHTS, NJ. FILED 4-26-2007.

Global Project Solution

THE MARK CONSISTS OF STANDARD CHARACTERS WITHOUT CLAIM TO ANY PARTICULAR FONT, STYLE, SIZE, OR COLOR.

NO CLAIM IS MADE TO THE EXCLUSIVE RIGHT TO USE "SOLUTION", APART FROM THE MARK AS SHOWN.

CLASS 35—ADVERTISING AND BUSINESS

FOR ADMINISTRATION AND MANAGEMENT OF RESEARCH GRANTS (U.S. CLS. 100, 101 AND 102).

CLASS 42—SCIENTIFIC AND COMPUTER SERVICES

FOR MEDICAL AND SCIENTIFIC RESEARCH IN THE FIELD OF BIOTECHNOLOGY AND PHARMACEUTICALS; MEDICAL AND SCIENTIFIC RESEARCH INFORMATION IN THE FIELD OF BIOTECHNOLOGY AND PHARMACEUTICALS; MEDICAL AND SCIENTIFIC RESEARCH SERVICES IN THE FIELD OF CANCER TREATMENT AND DIAGNOSIS; MEDICAL AND SCIENTIFIC RESEARCH, NAMELY, CONDUCTING CLINICAL TRIALS; MEDICAL RESEARCH (U.S. CLS. 100 AND 101).

CLASS 44—MEDICAL, BEAUTY AND AGRICULTURAL SERVICES

FOR MEDICAL AND PHARMACEUTICAL CONSULTATION (U.S. CLS. 100 AND 101).
MICHAEL LITZAU, EXAMINING ATTORNEY



NO CLAIM IS MADE TO THE EXCLUSIVE RIGHT TO USE EXECUTIVE AND LEARNING SOLUTIONS, APART FROM THE MARK AS SHOWN.

THE COLOR(S) NAVY BLUE, SKY BLUE AND GREY IS/ARE CLAIMED AS A FEATURE OF THE MARK.

THE MARK CONSISTS OF VANTAGE EXECUTIVE LEARNING SOLUTIONS WITH A DOT DESIGN ABOVE EXECUTIVE. THE COLOR NAVY BLUE APPEARS IN THE LETTERING FOR VANTAGE AND LEARNING SOLUTIONS AND IN SOME OF THE DOTS IN THE DESIGN ELEMENT. THE COLOR SKY BLUE APPEARS IN THE LETTERING FOR EXECUTIVE. THE COLOR GREY APPEARS IN SOME OF THE DOTS IN THE DESIGN ELEMENT.

CLASS 16—PAPER GOODS AND PRINTED MATTER

FOR EDUCATIONAL BOOKS RELATING TO BUSINESS MANAGEMENT; PRINTED INFORMATIONAL MATERIALS IN THE FORM OF BROCHURES RELATING TO BUSINESS MANAGEMENT; PAMPHLETS RELATING TO BUSINESS MANAGEMENT; CATALOGS FOR USE IN THE FIELD OF BUSINESS MANAGEMENT; SEMINAR PROGRAM MATERIALS, NAMELY COURSE OUTLINES AND NOTEBOOKS CONTAINING INSTRUCTIONAL PROGRAMS, QUESTION AND ANSWER SHEETS AND FACTUAL MATERIAL FOR USE AS TEACHING DEVICES ALL FOR USE IN THE FIELD OF BUSINESS MANAGEMENT (U.S. CLS. 2, 5, 22, 23, 29, 37, 38 AND 50).

CLASS 35—ADVERTISING AND BUSINESS

FOR PROVIDING INFORMATION IN THE FIELD OF BUSINESS MANAGEMENT VIA WEBSITES ON A GLOBAL COMPUTER NETWORK (U.S. CLS. 100, 101 AND 102).

CLASS 41—EDUCATION AND ENTERTAINMENT

FOR EDUCATIONAL SERVICES, NAMELY, PROVIDING ON-LINE COURSES IN THE FIELD OF BUSINESS MANAGEMENT VIA THE INTERNET; EDUCATION SERVICES, NAMELY CONDUCTING SEMINARS IN THE FIELD OF BUSINESS MANAGEMENT; ORGANIZING EXHIBITIONS FOR EDUCATIONAL PURPOSES IN THE FIELD OF BUSINESS MANAGEMENT (U.S. CLS. 100, 101 AND 107).

ERNEST SHOSHÓ, EXAMINING ATTORNEY

SN 77-166,368. ROQUETTE FRERES, LESTREM, FRANCE, FILED 4-26-2007.

ALGOHUB

THE MARK CONSISTS OF STANDARD CHARACTERS WITHOUT CLAIM TO ANY PARTICULAR FONT, STYLE, SIZE, OR COLOR.

CLASS 1—CHEMICALS

FOR CHEMICAL ADDITIVES FOR USE IN THE FOOD AND PHARMACEUTICAL INDUSTRY, NAMELY FOR USE IN THE MANUFACTURE OF FOOD AND PHARMACEUTICALS; CHEMICALS FOR USE IN SCIENCE; CHEMICAL PRODUCTS FOR THE PRESERVING OF FOOD; CHEMICAL REAGENTS FOR NON-MEDICAL AND NON-VETERINARY PURPOSES (U.S. CLS. 1, 5, 6, 10, 26 AND 46).

CLASS 3—COSMETICS AND CLEANING PREPARATIONS

FOR COSMETICS MADE WITH ALGAE AND ALGAE EXTRACTS; ALL PURPOSE CLEANING PREPARATIONS; POLISHING PREPARATIONS; SCOURING PREPARATIONS, NAMELY SCOURING LIQUIDS AND POWDERS; SKIN ABRASIVE PREPARATIONS; SOAPS; COSMETICS; BODY AND FACE LOTION CONTAINING ALGAE; HAIR LOTIONS; DENTIFRICES (U.S. CLS. 1, 4, 6, 50, 51 AND 52).

CLASS 5—PHARMACEUTICALS

FOR DIETETIC FOODS ADAPTED FOR MEDICAL USE; FOOD FOR BABIES (U.S. CLS. 6, 18, 44, 46, 51 AND 52).

CLASS 31—NATURAL AGRICULTURAL PRODUCTS

FOR FOOD FOR ANIMALS COMPRISED OF ALGAE AND ALGAE AND ALGAE EXTRACTS (U.S. CLS. 1 AND 46).

CLASS 42—SCIENTIFIC AND COMPUTER SERVICES

FOR PRODUCT RESEARCH, NAMELY, EVALUATION, ESTIMATION, AND RESEARCH OF PRODUCTS BY EXPERTS; FOOD RESEARCH ON NEW FOOD PRODUCTS FOR OTHERS; TECHNICAL PROJECT STUDIES, NAMELY, TECHNICAL ANALYSIS OF A PRODUCT AND PROCESS TO DETERMINE HOW TO MAKE IT MORE ENVIRONMENTALLY SOUND (U.S. CLS. 100 AND 101).

SIMON TENG, EXAMINING ATTORNEY

SN 77-166,832. AMERICAN MANAGEMENT ASSOCIATION INTERNATIONAL, NEW YORK, NY. FILED 4-26-2007.



NO CLAIM IS MADE TO THE EXCLUSIVE RIGHT TO USE EXECUTIVE AND LEARNING SOLUTIONS, APART FROM THE MARK AS SHOWN.

THE MARK CONSISTS OF VANTAGE EXECUTIVE LEARNING SOLUTIONS WITH A DOT DESIGN ABOVE EXECUTIVE.

CLASS 16—PAPER GOODS AND PRINTED MATTER

FOR EDUCATIONAL BOOKS RELATING TO BUSINESS MANAGEMENT; PRINTED INFORMATIONAL MATERIALS IN THE FORM OF BROCHURES RELATING TO BUSINESS MANAGEMENT; PAMPHLETS RELATING TO BUSINESS MANAGEMENT; CATALOGS FOR USE IN THE FIELD OF BUSINESS MANAGEMENT; SEMINAR PROGRAM MATERIALS, NAMELY COURSE OUTLINES AND NOTEBOOKS CONTAINING INSTRUCTIONAL PROGRAMS, QUESTION AND ANSWER SHEETS AND FACTUAL MATERIAL FOR USE AS TEACHING DEVICES ALL FOR USE IN THE FIELD OF BUSINESS MANAGEMENT (U.S. CLS. 2, 5, 22, 23, 29, 37, 38 AND 50).

CLASS 35—ADVERTISING AND BUSINESS

FOR PROVIDING INFORMATION IN THE FIELD OF BUSINESS MANAGEMENT VIA WEBSITES ON A GLOBAL COMPUTER NETWORK (U.S. CLS. 100, 101 AND 102).

CLASS 41—EDUCATION AND ENTERTAINMENT

FOR EDUCATIONAL SERVICES, NAMELY, PROVIDING ON-LINE COURSES IN THE FIELD OF BUSINESS MANAGEMENT VIA THE INTERNET; EDUCATION SERVICES, NAMELY CONDUCTING SEMINARS IN THE FIELD OF BUSINESS MANAGEMENT; ORGANIZING EXHIBITIONS FOR EDUCATIONAL PURPOSES IN THE FIELD OF BUSINESS MANAGEMENT (U.S. CLS. 100, 101 AND 107).

ERNEST SHOSHO, EXAMINING ATTORNEY

SN 77-166,879. NEWAYS, INC., SPRINGVILLE, UT. FILED 4-26-2007.

MAX FLASH TECHNOLOGY

THE MARK CONSISTS OF STANDARD CHARACTERS WITHOUT CLAIM TO ANY PARTICULAR FONT, STYLE, SIZE, OR COLOR.

NO CLAIM IS MADE TO THE EXCLUSIVE RIGHT TO USE "TECHNOLOGY", APART FROM THE MARK AS SHOWN.

CLASS 35—ADVERTISING AND BUSINESS

FOR ASEPTIC PACKAGING OF MERCHANDISE, NAMELY, DIETARY SUPPLEMENTS (U.S. CLS. 100, 101 AND 102).

CLASS 40—MATERIAL TREATMENT

FOR CUSTOM ASEPTIC MANUFACTURING OF DIETARY SUPPLEMENTS (U.S. CLS. 100, 103 AND 106).

CORY BOONE, EXAMINING ATTORNEY

SN 77-166,884. MCBRIDE, JAMES, CHICAGO, IL. FILED 4-26-2007.



THE PORTRAIT IN THE MARK IDENTIFIES A LIVING INDIVIDUAL WHOSE CONSENT IS OF RECORD.

THE MARK CONSISTS OF MR. SKIN CHARACTER LOGO.

CLASS 9—ELECTRICAL AND SCIENTIFIC APPARATUS

FOR VIDEO GAME SOFTWARE; PRE-RECORDED SOUND AND VIDEO RECORDINGS FEATURING NEWS AND COMMENTARY REGARDING MOTION PICTURES AND CELEBRITIES (U.S. CLS. 21, 23, 26, 36 AND 38).

CLASS 18—LEATHER GOODS

FOR SPORTS BAGS, FANNY PACKS, BACKPACKS (U.S. CLS. 1, 2, 3, 22 AND 41).

CLASS 21—HOUSEWARES AND GLASS

FOR MUGS (U.S. CLS. 2, 13, 23, 29, 30, 33, 40 AND 50).

CLASS 25—CLOTHING

FOR CLOTHING AND APPAREL, NAMELY, SHIRTS, SKIRTS, PANTS, TANK TOPS, UNDERWEAR, LINGERIE, BELTS, SOCKS, HATS (U.S. CLS. 22 AND 39).

CLASS 28—TOYS AND SPORTING GOODS

FOR TOYS AND GAMES, NAMELY, BOARD GAMES, TRIVIA GAMES; ACTION FIGURES (U.S. CLS. 22, 23, 38 AND 50).

KATHLEEN M. VANSTON, EXAMINING ATTORNEY

SN 77-167,654. WARNER, GIA, BLOOMFIELD HILLS, MI. FILED 4-27-2007.

GIA WARNER

THE MARK CONSISTS OF STANDARD CHARACTERS WITHOUT CLAIM TO ANY PARTICULAR FONT, STYLE, SIZE, OR COLOR.

CLASS 9—ELECTRICAL AND SCIENTIFIC APPARATUS

FOR MUSICAL SOUND RECORDINGS; MUSICAL VIDEO RECORDINGS; DOWNLOADABLE MUSICAL SOUND RECORDINGS; DOWNLOADABLE VIDEO RECORDINGS FEATURING MUSIC AND MUSIC PERFORMANCES (U.S. CLS. 21, 23, 26, 36 AND 38).

CLASS 41—EDUCATION AND ENTERTAINMENT

FOR (BASED ON USE IN COMMERCE) ENTERTAINMENT SERVICES, NAMELY, PERSONAL APPEARANCES BY A MUSIC ARTIST; ENTERTAINMENT, NAMELY LIVE MUSIC CONCERTS; ENTERTAINMENT SERVICES NAMELY PROVIDING A WEBSITE FEATURING, PHOTOGRAPHIC, AUDIO, VIDEO AND PROSE PRESENTATIONS FEATURING MUSIC (BASED ON INTENT TO USE) MUSIC PRODUCTION SERVICES; PRODUCTION OF SOUND AND MUSIC VIDEO RECORDINGS; COMPOSITION OF MUSIC FOR OTHERS; SONG WRITING SERVICES; POEM AND LYRIC WRITING; MUSIC PUBLISHING SERVICES; ENTERTAINMENT SERVICES, NAMELY, NON-DOWNLOADABLE RINGTONES, PRE-RECORDED MUSIC, VIDEO AND GRAPHICS PRESENTED TO MOBILE COMMUNICATIONS DEVICES VIA A GLOBAL COMPUTER NETWORK AND WIRELESS NETWORKS; ENTERTAINMENT NAMELY, PRODUCTION OF MUSIC CONCERTS; ENTERTAINMENT SERVICES, NAMELY, PROVIDING PRERECORDED MUSIC, INFORMATION IN THE FIELD OF MUSIC, AND COMMENTARY AND ARTICLES ABOUT MUSIC, ALL ON-LINE VIA A GLOBAL COMPUTER NETWORK; INSTRUCTION IN THE FIELD OF MUSIC AND SINGING (U.S. CLS. 100, 101 AND 107).

FIRST USE 0-0-1996; IN COMMERCE 0-0-1996. SKYE YOUNG, EXAMINING ATTORNEY

SN 77-167,870. WESTERN HOLDINGS, LLC, CHEYENNE, WY. FILED 4-27-2007.

AND WE COULDN'T SAY IT ON TV IF IT WASN'T TRUE

THE MARK CONSISTS OF STANDARD CHARACTERS WITHOUT CLAIM TO ANY PARTICULAR FONT, STYLE, SIZE, OR COLOR.

CLASS 5—PHARMACEUTICALS

FOR DIETARY SUPPLEMENTS (U.S. CLS. 6, 18, 44, 46, 51 AND 52).

CLASS 16—PAPER GOODS AND PRINTED MATTER

FOR PRINTED MATERIALS, NAMELY FLIERS, BROCHURES, MAGAZINES, PAMPHLETS, PAPER LABELS, DECALS, AND INSERTS, IN THE FIELD OF HEALTH, BEAUTY, FASHION, COSMETICS, FITNESS AND DIETARY SUPPLEMENTS (U.S. CLS. 2, 5, 22, 23, 29, 37, 38 AND 50).

JILL PRATER, EXAMINING ATTORNEY

SN 77-167,906. WESTERN HOLDINGS, LLC, CHEYENNE, WY. FILED 4-27-2007.

SN 77-168,122. BADER, GARIN B., LAS VEGAS, NV. FILED 4-27-2007.

AND WE COULDN'T SAY IT ON
THE RADIO IF IT WASN'T TRUE

THE MARK CONSISTS OF STANDARD CHARACTERS WITHOUT CLAIM TO ANY PARTICULAR FONT, STYLE, SIZE, OR COLOR.

CLASS 5—PHARMACEUTICALS

FOR DIETARY SUPPLEMENTS (U.S. CLS. 6, 18, 44, 46, 51 AND 52).

CLASS 16—PAPER GOODS AND PRINTED MATTER

FOR PRINTED MATERIALS, NAMELY FLIERS, BROCHURES, MAGAZINES, PAMPHLETS, PAPER LABELS, DECALS, AND INSERTS, IN THE FIELD OF HEALTH, BEAUTY, FASHION, COSMETICS, FITNESS AND DIETARY SUPPLEMENTS (U.S. CLS. 2, 5, 22, 23, 29, 37, 38 AND 50).

JILL PRATER, EXAMINING ATTORNEY

SN 77-167,925. WESTERN HOLDINGS, LLC, CHEYENNE, WY. FILED 4-27-2007.

AND WE COULDN'T SAY IT IN
PRINT IF IT WASN'T TRUE

THE MARK CONSISTS OF STANDARD CHARACTERS WITHOUT CLAIM TO ANY PARTICULAR FONT, STYLE, SIZE, OR COLOR.

CLASS 5—PHARMACEUTICALS

FOR DIETARY SUPPLEMENTS (U.S. CLS. 6, 18, 44, 46, 51 AND 52).

CLASS 16—PAPER GOODS AND PRINTED MATTER

FOR PRINTED MATERIALS, NAMELY FLIERS, BROCHURES, MAGAZINES, PAMPHLETS, PAPER LABELS, DECALS, AND INSERTS, IN THE FIELD OF HEALTH, BEAUTY, FASHION, COSMETICS, FITNESS AND DIETARY SUPPLEMENTS (U.S. CLS. 2, 5, 22, 23, 29, 37, 38 AND 50).

JILL PRATER, EXAMINING ATTORNEY

The Power of Zeus

THE MARK CONSISTS OF STANDARD CHARACTERS WITHOUT CLAIM TO ANY PARTICULAR FONT, STYLE, SIZE, OR COLOR.

CLASS 9—ELECTRICAL AND SCIENTIFIC APPARATUS

FOR DVDS FEATURING SPIRITUAL, MENTAL AND PHYSICAL FITNESS (U.S. CLS. 21, 23, 26, 36 AND 38).

CLASS 41—EDUCATION AND ENTERTAINMENT

FOR CONDUCTING WORKSHOPS AND SEMINARS IN SPIRITUAL, MENTAL AND PHYSICAL FITNESS (U.S. CLS. 100, 101 AND 107).

JENNIFER MARTIN, EXAMINING ATTORNEY

SN 77-168,158. BADER, GARIN B., LAS VEGAS, NV. FILED 4-27-2007.

Hot Burning Body

THE MARK CONSISTS OF STANDARD CHARACTERS WITHOUT CLAIM TO ANY PARTICULAR FONT, STYLE, SIZE, OR COLOR.

CLASS 9—ELECTRICAL AND SCIENTIFIC APPARATUS

FOR DVDS FEATURING EXERCISE, DIET, AND PHYSICAL FITNESS (U.S. CLS. 21, 23, 26, 36 AND 38).

CLASS 41—EDUCATION AND ENTERTAINMENT

FOR CONDUCTING WORKSHOPS AND SEMINARS IN EXERCISE, DIET AND PHYSICAL FITNESS (U.S. CLS. 100, 101 AND 107).

JENNIFER MARTIN, EXAMINING ATTORNEY

SN 77-170,753. ONLINE PLANET, DUBLIN, CA. FILED 5-2-2007.

CallSense

THE MARK CONSISTS OF STANDARD CHARACTERS WITHOUT CLAIM TO ANY PARTICULAR FONT, STYLE, SIZE, OR COLOR.

CLASS 9—ELECTRICAL AND SCIENTIFIC APPARATUS

FOR SOFTWARE FOR TELEPHONE AND COMMUNICATIONS SERVICE PLAN ANALYSIS (U.S. CLS. 21, 23, 26, 36 AND 38).

FIRST USE 4-25-2000; IN COMMERCE 4-25-2000.

CLASS 35—ADVERTISING AND BUSINESS

FOR PROVIDING A WEBSITE FEATURING COST ANALYSIS FOR TELEPHONE AND COMMUNICATIONS SERVICE PLANS (U.S. CLS. 100, 101 AND 102).

FIRST USE 4-25-2000; IN COMMERCE 4-25-2000.
KIM SAITO, EXAMINING ATTORNEY

SN 77-171,027. ABCO REFRIGERATION SUPPLY CORP., LONG ISLAND, NY. FILED 5-2-2007.

ABCO TODAY: EMBRACING OUR CUSTOMERS

THE MARK CONSISTS OF STANDARD CHARACTERS WITHOUT CLAIM TO ANY PARTICULAR FONT, STYLE, SIZE, OR COLOR.
OWNER OF U.S. REG. NOS. 2,599,977, 3,046,505 AND OTHERS.

CLASS 16—PAPER GOODS AND PRINTED MATTER

FOR CATALOGS IN THE FIELD OF REFRIGERATION SYSTEMS, ICE MACHINES, VENTILATION EQUIPMENT, AIR CONDITIONING UNITS, HVAC/REFRIGERATION, HEATING UNITS, AND PARTS, SUPPLIES AND MATERIALS THEREFOR (U.S. CLS. 2, 5, 22, 23, 29, 37, 38 AND 50).

FIRST USE 11-0-2006; IN COMMERCE 11-0-2006.

CLASS 35—ADVERTISING AND BUSINESS

FOR DISTRIBUTORSHIP SERVICES IN THE FIELD OF REFRIGERATION SYSTEMS, ICE MACHINES, VENTILATION EQUIPMENT, AIR CONDITIONING UNITS, HVAC/REFRIGERATION, HEATING UNITS, AND PARTS, SUPPLIES AND MATERIALS THEREFOR (U.S. CLS. 100, 101 AND 102).

FIRST USE 11-0-2006; IN COMMERCE 11-0-2006.
DAVID H. STINE, EXAMINING ATTORNEY

SN 77-171,072. LEAK DETECTION PROS, INC., PETALUMA, CA. FILED 5-2-2007.



NO CLAIM IS MADE TO THE EXCLUSIVE RIGHT TO USE "LEAK DETECTION PROS VIDEO INSPECTION UTILITY LOCATING", APART FROM THE MARK AS SHOWN.

THE COLOR(S) BURGUNDY, WHITE AND BLACK IS/ARE CLAIMED AS A FEATURE OF THE MARK.

THE COLOR BLACK APPEARS IN THE CIRCLE

AROUND THE DESIGN OF THE WATER DROP, AND IN THE WORDING "LEAK DETECTION PROS"; THE COLOR BURGUNDY APPEARS IN THE LOWER HALF OF THE WATER DROP STRIPES, IN THE BACKGROUND WITHIN THE CIRCLE, AND IN THE TWO BANNERS; THE COLOR WHITE APPEAR IN THE UPPER HALF OF THE WATER DROP AND IN THE LOWER HALF OF THE WATER DROP STRIPES, THE SEMI-CIRCLE UNDER THE WATER DROP, AND IN THE WORDING "VIDEO INSPECTION UTILITY LOCATING."

CLASS 37—CONSTRUCTION AND REPAIR

FOR PLUMBING CONTRACTOR SERVICES; PLUMBING SERVICES (U.S. CLS. 100, 103 AND 106).

FIRST USE 2-27-2007; IN COMMERCE 2-27-2007.

CLASS 42—SCIENTIFIC AND COMPUTER SERVICES

FOR LOCATING AND MARKING PLACEMENT OF UNDERGROUND UTILITY PIPES, CABLE OR WIRES; PIPELINE INSPECTION SERVICES (U.S. CLS. 100 AND 101).

FIRST USE 2-27-2007; IN COMMERCE 2-27-2007.
TASNEEM HUSSAIN, EXAMINING ATTORNEY

SN 77-171,328. IDEASONE, INC., KAMUELA, HI. FILED 5-2-2007.

THE TWISTED SPATULA

THE MARK CONSISTS OF STANDARD CHARACTERS WITHOUT CLAIM TO ANY PARTICULAR FONT, STYLE, SIZE, OR COLOR.

CLASS 30—STAPLE FOODS

FOR FOOD, NAMELY, MARINADES AND SEASONINGS (U.S. CL. 46).

CLASS 41—EDUCATION AND ENTERTAINMENT

FOR TELEVISION AND RADIO ENTERTAINMENT PROGRAMMING, NAMELY, A COOKING TALK SHOW (U.S. CLS. 100, 101 AND 107).

AISHA CLARKE, EXAMINING ATTORNEY

SN 77-171,346. IDEASONE, INC., KAMUELA, HI. FILED 5-2-2007.

WHAT FREQUENCY ARE YOU ON?

THE MARK CONSISTS OF STANDARD CHARACTERS WITHOUT CLAIM TO ANY PARTICULAR FONT, STYLE, SIZE, OR COLOR.

CLASS 5—PHARMACEUTICALS

FOR DIETARY SUPPLEMENTS (U.S. CLS. 6, 18, 44, 46, 51 AND 52).

CLASS 35—ADVERTISING AND BUSINESS

FOR GENERAL BUSINESS MERCHANDISING SERVICES, NAMELY, MARKETING OVER A GLOBAL COMPUTER NETWORK (U.S. CLS. 100, 101 AND 102).
AISHA CLARKE, EXAMINING ATTORNEY

SN 77-171,678. THE NEW YORK TIMES COMPANY, NEW YORK, NY. FILED 5-3-2007.

Preoccupations

THE MARK CONSISTS OF STANDARD CHARACTERS WITHOUT CLAIM TO ANY PARTICULAR FONT, STYLE, SIZE, OR COLOR.

CLASS 16—PAPER GOODS AND PRINTED MATTER

FOR COLUMNS ON THE SUBJECT OF BUSINESS AND FINANCE (U.S. CLS. 2, 5, 22, 23, 29, 37, 38 AND 50).

CLASS 41—EDUCATION AND ENTERTAINMENT

FOR ON-LINE JOURNALS, NAMELY, BLOGS FEATURING BUSINESS AND FINANCE; PROVIDING ON-LINE PUBLICATIONS IN THE NATURE OF NEWS-PAPER COLUMNS IN THE FIELD OF BUSINESS AND FINANCE (U.S. CLS. 100, 101 AND 107).
AMY HELLA, EXAMINING ATTORNEY

SN 77-172,288. TIM BRECHEISEN, WICHITA, KS. FILED 5-3-2007.

Ambassador Club

NO CLAIM IS MADE TO THE EXCLUSIVE RIGHT TO USE "CLUB", AS TO THE SERVICES IN CLASS 44, APART FROM THE MARK AS SHOWN.

THE COLOR(S) GOLD AND BURGUNDY IS/ARE CLAIMED AS A FEATURE OF THE MARK.

THE MARK CONSISTS OF GOLD LETTERS WITH BURGUNDY OUTLINE. CAPITAL "A" ON AMBASSADOR AND CAPITAL "C" ON CLUB.

CLASS 10—MEDICAL APPARATUS

FOR ASSISTIVE LISTENING DEVICE FOR THE HEARING IMPAIRED; ELECTRIC HEARING AIDS; ELECTRICAL HEARING AIDS; ELECTRICALLY OPERATED HEARING AIDS; HEARING AIDS; HEARING AIDS FOR THE DEAF (U.S. CLS. 26, 39 AND 44).

CLASS 44—MEDICAL, BEAUTY AND AGRICULTURAL SERVICES

FOR HEARING AID SERVICES (U.S. CLS. 100 AND 101).
BARBARA A. LOUGHRAN, EXAMINING ATTORNEY

SN 77-173,315. T-SYSTEMS INTERNATIONAL, INC., SAN DIEGO, CA. FILED 5-4-2007.



OWNER OF U.S. REG. NOS. 2,661,260, 2,661,261 AND OTHERS.

THE COLOR(S) GREEN, BLUE, AND BROWN IS/ARE CLAIMED AS A FEATURE OF THE MARK.

THE MARKS CONSIST OF A DESIGN OF A WAVE AND THE WORDING "T-SYSTEMS". THE WAVE DESIGN APPEARS TO THE LEFT OF THE WORDING AND CONSISTS OF THREE CURVED SHAPES RESTING ON TOP OF EACH OTHER. THE SHAPES ARE GREEN, BLUE, AND BROWN RESPECTIVELY, AND THE WORDING IN THE MARK IS BLUE.

CLASS 9—ELECTRICAL AND SCIENTIFIC APPARATUS

FOR SOIL MOISTURE SENSORS AND ELECTRONIC CONTROLLERS FOR REGULATING MOISTURE CONTENT (U.S. CLS. 21, 23, 26, 36 AND 38).

CLASS 44—MEDICAL, BEAUTY AND AGRICULTURAL SERVICES

FOR ADVISORY SERVICES IN THE FIELDS OF IRRIGATION AND FERTIGATION, NAMELY FERTILIZATION VIA IRRIGATION; GENERATING REPORTS TO ASSIST FARMERS IN THE FIELDS OF IRRIGATION AND FERTIGATION (U.S. CLS. 100 AND 101).

CORY BOONE, EXAMINING ATTORNEY

SN 77-173,392. T-SYSTEMS INTERNATIONAL, INC., SAN DIEGO, CA. FILED 5-4-2007.



OWNER OF U.S. REG. NOS. 1,105,584, 1,652,307 AND OTHERS.

THE COLOR(S) GREEN, BLUE AND BROWN IS/ARE CLAIMED AS A FEATURE OF THE MARK.

THE MARK CONSISTS OF GREEN BLUE AND BROWN STACK WAVE DESIGN FOLLOWED BY THE WORD T-TAPE IN BLUE.

CLASS 9—ELECTRICAL AND SCIENTIFIC APPARATUS

FOR SOIL MOISTURE SENSORS AND ELECTRONIC CONTROLLERS FOR REGULATING MOISTURE CONTENT (U.S. CLS. 21, 23, 26, 36 AND 38).

CLASS 44—MEDICAL, BEAUTY AND AGRICULTURAL SERVICES

FOR ADVISORY SERVICES IN THE FIELDS OF IRRIGATION AND FERTIGATION, NAMELY FERTILIZATION VIA IRRIGATION; GENERATING REPORTS TO ASSIST FARMERS IN THE FIELDS OF IRRIGATION AND FERTIGATION (U.S. CLS. 100 AND 101).

CORY BOONE, EXAMINING ATTORNEY

SN 77-174,593. KABUSHIKI KAISHA SQUARE ENIX, DBA/ AKA SQUARE ENIX CO., LTD., TOKYO, JAPAN, FILED 5-7-2007.

SECOND EVOLUTION

THE MARK CONSISTS OF STANDARD CHARACTERS WITHOUT CLAIM TO ANY PARTICULAR FONT, STYLE, SIZE, OR COLOR.

CLASS 9—ELECTRICAL AND SCIENTIFIC APPARATUS

FOR COMPUTER GAME SOFTWARE; VIDEO GAME SOFTWARE; SOUND RECORDINGS IN THE FORM OF OPTICAL DISCS, MAGNETIC DISCS AND SEMICONDUCTOR ROMS FEATURING MUSIC AND/OR FICTIONAL STORIES; AUDIO VISUAL RECORDINGS IN THE FORM OF OPTICAL DISCS, MAGNETIC DISCS AND/OR SEMICONDUCTOR ROMS FEATURING MUSIC AND/OR ANIMATED FICTIONAL STORIES; PRE-RECORDED COMPACT DISCS FEATURING MUSIC; PRERECORDED VIDEO DISCS FEATURING MUSIC AND/OR ANIMATED FICTIONAL STORIES; MOUSE PADS; STRAPS FOR CELLULAR PHONES; DOWNLOADABLE MUSICAL SOUND RECORDINGS; DOWNLOADABLE RING TONES FOR MOBILE PHONES VIA A GLOBAL COMMUNICATION NETWORK; DOWNLOADABLE ENTERTAINMENT SOFTWARE CONTAINING WALLPAPER GRAPHICS FOR MOBILE PHONES VIA A GLOBAL COMMUNICATION NETWORK; DOWNLOADABLE ELECTRONIC PUBLICATIONS IN THE NATURE OF MAGAZINES, JOURNALS OR NEWSLETTERS IN THE FIELD OF COMPUTER GAMES AND/OR VIDEO GAMES (U.S. CLS. 21, 23, 26, 36 AND 38).

CLASS 16—PAPER GOODS AND PRINTED MATTER

FOR COMPUTER GAME STRATEGY GUIDE BOOKS; VIDEO GAME STRATEGY GUIDEBOOKS; SONG BOOKS; MUSICAL SCORE BOOKS; COMIC BOOKS; MAGAZINES FEATURING COMPUTER GAMES AND/OR VIDEO GAMES; POSTERS; STICKERS; CALENDARS; POST CARDS; PENS; COLLECTORS' CARDS; TRADING CARDS; PHOTOGRAPHS (U.S. CLS. 2, 5, 22, 23, 29, 37, 38 AND 50).

SCOTT BIBB, EXAMINING ATTORNEY

SN 77-174,596. KABUSHIKI KAISHA SQUARE ENIX, DBA/ AKA SQUARE ENIX CO., LTD., TOKYO, JAPAN, FILED 5-7-2007.

FIRST DEPARTURE

THE MARK CONSISTS OF STANDARD CHARACTERS WITHOUT CLAIM TO ANY PARTICULAR FONT, STYLE, SIZE, OR COLOR.

CLASS 9—ELECTRICAL AND SCIENTIFIC APPARATUS

FOR COMPUTER GAME SOFTWARE; VIDEO GAME SOFTWARE; SOUND RECORDINGS IN THE FORM OF OPTICAL DISCS, MAGNETIC DISCS AND SEMICONDUCTOR ROMS FEATURING MUSIC AND/OR FICTIONAL STORIES; AUDIO VISUAL RECORDINGS IN THE FORM OF OPTICAL DISCS, MAGNETIC DISCS AND/OR SEMICONDUCTOR ROMS FEATURING MUSIC AND/OR ANIMATED FICTIONAL STORIES; PRE-RECORDED COMPACT DISCS FEATURING MUSIC; PRERECORDED VIDEO DISCS FEATURING MUSIC AND/OR ANIMATED FICTIONAL STORIES; MOUSE PADS; STRAPS FOR CELLULAR PHONES; DOWNLOADABLE MUSICAL SOUND RECORDINGS; DOWNLOADABLE RING TONES FOR MOBILE PHONES VIA A GLOBAL COMMUNICATION NETWORK; DOWNLOADABLE ENTERTAINMENT SOFTWARE CONTAINING WALLPAPER GRAPHICS FOR MOBILE PHONES VIA A GLOBAL COMMUNICATION NETWORK; DOWNLOADABLE ELECTRONIC PUBLICATIONS IN THE NATURE OF MAGAZINES, JOURNALS OR NEWSLETTERS IN THE FIELD OF COMPUTER GAMES AND/OR VIDEO GAMES (U.S. CLS. 21, 23, 26, 36 AND 38).

CLASS 16—PAPER GOODS AND PRINTED MATTER

FOR COMPUTER GAME STRATEGY GUIDE BOOKS; VIDEO GAME STRATEGY GUIDEBOOKS; SONG BOOKS; MUSICAL SCORE BOOKS; COMIC BOOKS; MAGAZINES FEATURING COMPUTER GAMES AND/OR VIDEO GAMES; POSTERS; STICKERS; CALENDARS; POST CARDS; PENS; COLLECTORS' CARDS; TRADING CARDS; PHOTOGRAPHS (U.S. CLS. 2, 5, 22, 23, 29, 37, 38 AND 50).

SCOTT BIBB, EXAMINING ATTORNEY

SN 77-174,616. BLOOMSBURY PUBLISHING PLC, LONDON, UNITED KINGDOM, FILED 5-7-2007.



THE MARK CONSISTS OF A LION WITH A MANE MADE UP OF "W'S".

CLASS 9—ELECTRICAL AND SCIENTIFIC APPARATUS

FOR DATA RECORDINGS NAMELY AUDIO, VIDEO, STILL AND MOVING IMAGES AND TEXT ON A VARIETY OF TOPICS; VIDEO CASSETTES, AUDIOCASSETTES, COMPACT DISCS, AND CD-ROMS ALL ON A VARIETY OF TOPICS; DOWNLOADABLE ELECTRONIC BOOKS AND AUDIO BOOKS ON A VARIETY OF TOPICS; DOWNLOADABLE MP3 FILES, MP3 RECORDINGS, ONLINE DISCUSSION BOARDS, WEB CASTS, POD CASTS FEATURING MUSIC, AUDIO BOOKS; ELECTRONIC PUBLICATIONS, NAMELY, BOOK, MAGAZINE, MANUAL ON A VARIETY OF TOPICS RECORDED ON COMPUTER MEDIA (U.S. CLS. 21, 23, 26, 36 AND 38).

CLASS 41—EDUCATION AND ENTERTAINMENT

FOR PROVISION OF EDUCATION, INSTRUCTION, INFORMATION AND TRAINING IN RELATION TO LITERATURE, WRITING AND DRAMATIC WORKS; PUBLICATION OF ELECTRONIC BOOKS, AUDIO BOOKS AND JOURNALS ON-LINE; THE PROVISION OF DISCUSSION FORUMS RELATED TO LITERATURE, WRITING, MUSIC AND FILMS; PROVIDING ON-LINE PUBLICATIONS IN THE NATURE OF BOOKS, MAGAZINES, AND JOURNALS ON A VARIETY OF TOPICS; PROVISION OF INFORMATION AND ADVISORY SERVICES RELATING TO LITERATURE, DRAMATIC WORKS FOR THEATRE OR BROADCAST, AUTHORSHIP, MUSIC AND FILM; ENTERTAINMENT SERVICES, NAMELY, PROVIDING ON-LINE REVIEWS OF MOVIES, BOOKS, MUSIC, COMPUTER GAMES; ENTERTAINMENT SERVICES NAMELY PROVIDING A WEB SITE ON A VARIETY OF FICTION AND NON-FICTION TOPICS INCLUDING MUSIC, CONCERTS, FILM, VIDEOS, THEATRE, RADIO, TELEVISION, NEWS, SPORTS, GAMES AND CULTURAL EVENTS AND ENTERTAINMENT-RELATED PROGRAMS (U.S. CLS. 100, 101 AND 107).

JOHN HWANG, EXAMINING ATTORNEY

SN 77-175,318. IDEASONE, INC., KAMUELA, HI. FILED 5-8-2007.

FROM POLITICS TO POLICY --
EVOLUTION: MAN

THE MARK CONSISTS OF STANDARD CHARACTERS WITHOUT CLAIM TO ANY PARTICULAR FONT, STYLE, SIZE, OR COLOR.

CLASS 5—PHARMACEUTICALS

FOR DIETARY SUPPLEMENTS (U.S. CLS. 6, 18, 44, 46, 51 AND 52).

CLASS 35—ADVERTISING AND BUSINESS

FOR GENERAL BUSINESS MERCHANDISING SERVICES, NAMELY, MARKETING OVER A GLOBAL COMPUTER NETWORK (U.S. CLS. 100, 101 AND 102).

AISHA CLARKE, EXAMINING ATTORNEY

SN 77-176,570. WITTE, TROY F., COLORADO SPRINGS, CO. FILED 5-9-2007.

BODY PUBLIC

THE MARK CONSISTS OF STANDARD CHARACTERS WITHOUT CLAIM TO ANY PARTICULAR FONT, STYLE, SIZE, OR COLOR.

CLASS 25—CLOTHING

FOR CLOTHING, NAMELY, T-SHIRTS, SHIRTS, SWEAT SHIRTS, SWEAT PANTS, HEADWEAR, FOOTWEAR, AND TOPS (U.S. CLS. 22 AND 39).

CLASS 41—EDUCATION AND ENTERTAINMENT

FOR ENTERTAINMENT IN THE NATURE OF ONGOING TELEVISION PROGRAMS IN THE FIELD OF DRAMA AND DANCE; ENTERTAINMENT SERVICES, NAMELY, PROVIDING A TELEVISION PROGRAM IN THE FIELD OF DRAMA AND DANCE VIA A GLOBAL COMPUTER NETWORK; ENTERTAINMENT IN THE NATURE OF DANCE PERFORMANCES; ENTERTAINMENT IN THE NATURE OF LIVE PERFORMANCES BY A THEATRICAL GROUP; ENTERTAINMENT SERVICES, NAMELY, PROVIDING A WEB SITE FEATURING DANCE AND THEATRICAL PERFORMANCES; PROVIDING ON-LINE PUBLICATIONS IN THE NATURE OF MAGAZINES IN THE FIELDS OF FITNESS, DANCE, AND ENTERTAINMENT; PHYSICAL FITNESS CONSULTATION; PHYSICAL FITNESS INSTRUCTION; PROVIDING FITNESS AND EXERCISE FACILITIES (U.S. CLS. 100, 101 AND 107).

EDWARD NELSON, EXAMINING ATTORNEY

SN 77-177,808. KABUSHIKI KAISHA SQUARE ENIX, DBA/ AKA SQUARE ENIX CO., LTD., TOKYO, JAPAN, FILED 5-10-2007.

THE WAR OF THE LIONS

THE MARK CONSISTS OF STANDARD CHARACTERS WITHOUT CLAIM TO ANY PARTICULAR FONT, STYLE, SIZE, OR COLOR.

CLASS 9—ELECTRICAL AND SCIENTIFIC APPARATUS

FOR COMPUTER GAME SOFTWARE; VIDEO GAME SOFTWARE; SOUND RECORDINGS IN THE FORM OF OPTICAL DISCS, MAGNETIC DISCS AND SEMICONDUCTOR ROMS FEATURING MUSIC AND/OR FICTIONAL STORIES; AUDIO VISUAL RECORDINGS IN THE FORM OF OPTICAL DISCS, MAGNETIC DISCS AND SEMICONDUCTOR ROMS FEATURING MUSIC AND/OR ANIMATED FICTIONAL STORIES; PRERECORDED COMPACT DISCS FEATURING MUSIC; PRERECORDED VIDEO DISCS FEATURING MUSIC AND/OR ANIMATED FICTIONAL STORIES; MOUSE PADS; STRAPS FOR CELLULAR PHONES; DOWNLOADABLE MUSICAL SOUND RECORDINGS; DOWNLOADABLE RING TONES FOR MOBILE PHONES VIA A GLOBAL COMMUNICATION NETWORK; DOWNLOADABLE ENTERTAINMENT SOFTWARE CONTAINING WALLPAPER GRAPHICS FOR MOBILE PHONES VIA A GLOBAL COMMUNICATION NETWORK; DOWNLOADABLE ELECTRONIC PUBLICATIONS IN THE NATURE OF MAGAZINES, JOURNALS OR NEWSLETTERS IN THE FIELD OF COMPUTER GAMES AND/OR VIDEO GAMES (U.S. CLS. 21, 23, 26, 36 AND 38).

CLASS 16—PAPER GOODS AND PRINTED MATTER

FOR COMPUTER GAME STRATEGY GUIDE BOOKS; VIDEO GAME STRATEGY GUIDEBOOKS; SONG BOOKS; MUSICAL SCORE BOOKS; COMIC BOOKS; MAGAZINES FEATURING COMPUTER GAMES AND/OR VIDEO GAMES; POSTERS; STICKERS; CALENDARS; POST CARDS; PENS; COLLECTORS' CARDS; TRADING CARDS; PHOTOGRAPHS (U.S. CLS. 2, 5, 22, 23, 29, 37, 38 AND 50).

SCOTT BIBB, EXAMINING ATTORNEY

SN 77-178,142. MOLLY BURGESS, REDLANDS, CA. AND RON BURGESS, REDLANDS, CA. FILED 5-10-2007.

SN 77-179,831. LIVE GREEN, LIVE SMART, LLC, WAYZATA, MN. FILED 5-14-2007.



NO CLAIM IS MADE TO THE EXCLUSIVE RIGHT TO USE "MEDIA", APART FROM THE MARK AS SHOWN.

CLASS 35—ADVERTISING AND BUSINESS

FOR DESIGN OF PRINTED AND ONLINE MARKETING MATERIALS FOR OTHERS; CONSULTATION IN THE FILED OF AND DESIGN OF ONLINE MARKETING BANNER ADVERTISEMENTS FOR OTHERS (U.S. CLS. 100, 101 AND 102).

FIRST USE 5-5-2002; IN COMMERCE 5-5-2002.

CLASS 42—SCIENTIFIC AND COMPUTER SERVICES

FOR COMPUTER SERVICES, NAMELY, DESIGN CONSULTATION, CONTENT MANAGEMENT, MAINTENANCE AND OPTIMIZATION OF WEB SITES; HOSTING AND MAINTAINING WEBSITES OF OTHERS FOR ADVERTISING AND SALES PURPOSES; AND MONITORING, TESTING, ANALYZING, AND REPORTING ON THE INTERNET TRAFFIC CONTROL AND CONTENT CONTROL OF THE WEBSITES OF OTHERS (U.S. CLS. 100 AND 101).

FIRST USE 5-5-2002; IN COMMERCE 5-5-2002.

PAUL F. GAST, EXAMINING ATTORNEY



Live Green, Live Smart

THE MARK CONSISTS OF THE OUTLINE OF A HOUSE WITH A SUN ABOVE THE ROOF AND A BRANCH WITH THREE LEAVES ACROSS THE BODY OF THE HOUSE AND THE WORDS LIVE GREEN, LIVE SMART BELOW THE HOUSE.

CLASS 35—ADVERTISING AND BUSINESS

FOR PROVIDING LINKS TO THE WEBSITES OF OTHERS FEATURING INFORMATION ABOUT GOODS AND SERVICES OF OTHERS THAT PROMOTE ENVIRONMENTALLY RESPONSIBLE LIFESTYLE CHOICES VIA THE INTERNET (U.S. CLS. 100, 101 AND 102).

FIRST USE 4-22-2007; IN COMMERCE 4-22-2007.

CLASS 37—CONSTRUCTION AND REPAIR

FOR PROVIDING INFORMATION IN THE FIELD OF HOME RENOVATION, CONSTRUCTION, AND IMPROVEMENT FOR AN ENVIRONMENTALLY RESPONSIBLE, RESOURCE EFFICIENT HOME VIA THE INTERNET (U.S. CLS. 100, 103 AND 106).

FIRST USE 4-22-2007; IN COMMERCE 4-22-2007.

CLASS 39—TRANSPORTATION AND STORAGE

FOR PROVIDING LINKS TO THE WEBSITES OF OTHERS FEATURING INFORMATION IN THE FIELD OF ENVIRONMENTALLY RESPONSIBLE TRANSPORTATION VIA THE INTERNET (U.S. CLS. 100 AND 105).

FIRST USE 4-22-2007; IN COMMERCE 4-22-2007.

CLASS 42—SCIENTIFIC AND COMPUTER SERVICES

FOR PROVIDING LINKS TO THE WEBSITES OF OTHERS FEATURING INFORMATION IN THE FIELD OF HOME DESIGN FOR AN ENVIRONMENTALLY RESPONSIBLE, RESOURCE-EFFICIENT HOME VIA THE INTERNET (U.S. CLS. 100 AND 101).

FIRST USE 4-22-2007; IN COMMERCE 4-22-2007.

ANTHONY RINKER, EXAMINING ATTORNEY

SN 77-179,198. TOPCODER, INC., GLASTONBURY, CT. FILED 5-11-2007.



THE MARK CONSISTS OF THE WORDS THE BALL WITH A CIRCULAR COMPONENT SURROUNDED BY CIRCULAR RINGS.

CLASS 35—ADVERTISING AND BUSINESS

FOR CONTESTS AND INCENTIVE AWARD PROGRAMS TO PROMOTE THE SALE OF PRODUCTS AND SERVICES OF OTHERS (U.S. CLS. 100, 101 AND 102).

CLASS 41—EDUCATION AND ENTERTAINMENT

FOR CONDUCTING PUZZLE-SOLVING AND SCAVENGER HUNT CONTESTS OVER THE INTERNET (U.S. CLS. 100, 101 AND 107).

ROBERT STRUCK, EXAMINING ATTORNEY

SN 77-179,888. LEACHCO, INC., ADA, OK. FILED 5-14-2007.

SN 77-179,944. WASTE MANAGEMENT, INC., HOUSTON, TX. FILED 5-14-2007.

GOOD TO KNOW GOOD TO GO

ORGANIC SMART

THE MARK CONSISTS OF STANDARD CHARACTERS WITHOUT CLAIM TO ANY PARTICULAR FONT, STYLE, SIZE, OR COLOR.

NO CLAIM IS MADE TO THE EXCLUSIVE RIGHT TO USE "ORGANIC", APART FROM THE MARK AS SHOWN.

CLASS 10—MEDICAL APPARATUS

FOR BABY BOTTLE HOLDERS, PILLOWS FOR MEDICAL AND THERAPEUTIC PURPOSES, THERAPEUTIC BODY PILLOWS FOR PRE AND POST SURGICAL AND MEDICAL CARE, THERAPEUTIC BODY PILLOWS FOR USE BY PREGNANT WOMEN AND NURSING MOTHERS, THERAPEUTIC SUPPORT PILLOWS FOR PREMATURE INFANTS (U.S. CLS. 26, 39 AND 44).

CLASS 12—VEHICLES

FOR FITTED COVERS FOR SHOPPING CARTS, COVERS FOR BABY STROLLERS, FITTED COVERS FOR THE CARRIERS IN VEHICLE SAFETY SEATS FOR INFANTS AND CHILDREN (U.S. CLS. 19, 21, 23, 31, 35 AND 44).

CLASS 20—FURNITURE AND ARTICLES NOT OTHERWISE CLASSIFIED

FOR PILLOWS, BODY PILLOWS, NURSING PILLOWS, MATERNITY PILLOWS, CHILDREN'S PILLOWS, INFANT SUPPORT PILLOWS WITH TEXTILE BODY WRAPS, TRAVEL PILLOWS, HEAD SUPPORT PILLOWS FOR BABIES, HEAD AND NECK SUPPORT PILLOWS WITH ATTACHED BLANKETS, HEAD AND NECK SUPPORT PILLOWS WITH ATTACHED BLANKET FOR SMALL AND PREMATURE INFANTS, TRAVEL PILLOWS, NAP MATS, BUMPER GUARDS FOR PORTABLE BEDS, PORTABLE CONVERTIBLE BABY BEDS, PORTABLE BEDS FOR INFANTS AND BABIES, SLEEPING MATS, BOTTLE-HOLDING PILLOWS (U.S. CLS. 2, 13, 22, 25, 32 AND 50).

CLASS 24—FABRICS

FOR PILLOW COVERS, FABRIC CRIB BUMPER USED TO DIVIDE CRIBS, CRIB RAIL COVERS, INFANT BLANKETS, BUMPER PADS FOR PORTABLE BEDS (U.S. CLS. 42 AND 50).

CLASS 25—CLOTHING

FOR SKULL CAPS, CLOTH BIBS, BABY BIBS NOT OF PAPER, INFANT AND TODDLER ONE PIECE CLOTHING, SLEEPWEAR, CLOTH DIAPERS, INFANT SLEEPERS, INFANTWEAR, SWADDLING CLOTHES, T-SHIRTS (U.S. CLS. 22 AND 39).

CLASS 28—TOYS AND SPORTING GOODS

FOR PLAY MATS HAVING POCKETS FOR CONTAINING TOYS (U.S. CLS. 22, 23, 38 AND 50).
KATHRYN COWARD, EXAMINING ATTORNEY

THE MARK CONSISTS OF STANDARD CHARACTERS WITHOUT CLAIM TO ANY PARTICULAR FONT, STYLE, SIZE, OR COLOR.

CLASS 37—CONSTRUCTION AND REPAIR

FOR WASTE DISPOSAL FOR OTHERS AND COLLECTION OF TRASH (U.S. CLS. 100, 103 AND 106).

CLASS 39—TRANSPORTATION AND STORAGE

FOR GARBAGE COLLECTION AND TRANSPORT BY TRUCK (U.S. CLS. 100 AND 105).
KIMBERLY FRYE, EXAMINING ATTORNEY

SN 77-180,165. LEACHCO, INC., ADA, OK. FILED 5-14-2007.

IT'S ALL THAT YOU'RE EXPECTING...NATURALLY.

THE MARK CONSISTS OF STANDARD CHARACTERS WITHOUT CLAIM TO ANY PARTICULAR FONT, STYLE, SIZE, OR COLOR.

CLASS 10—MEDICAL APPARATUS

FOR BABY BOTTLE HOLDERS, PILLOWS FOR MEDICAL AND THERAPEUTIC PURPOSES, THERAPEUTIC BODY PILLOWS FOR PRE AND POST SURGICAL AND MEDICAL CARE, THERAPEUTIC BODY PILLOWS FOR USE BY PREGNANT WOMEN AND NURSING MOTHERS, THERAPEUTIC SUPPORT PILLOWS FOR PREMATURE INFANTS (U.S. CLS. 26, 39 AND 44).

CLASS 12—VEHICLES

FOR FITTED COVERS FOR SHOPPING CARTS, COVERS FOR BABY STROLLERS, FITTED COVERS FOR THE CARRIERS IN VEHICLE SAFETY SEATS FOR INFANTS AND CHILDREN (U.S. CLS. 19, 21, 23, 31, 35 AND 44).

CLASS 20—FURNITURE AND ARTICLES NOT OTHERWISE CLASSIFIED

FOR PILLOWS, BODY PILLOWS, NURSING PILLOWS, MATERNITY PILLOWS, CHILDREN'S PILLOWS, INFANT SUPPORT PILLOWS WITH TEXTILE BODY WRAPS, TRAVEL PILLOWS, HEAD SUPPORT PILLOWS FOR BABIES, HEAD AND NECK SUPPORT PILLOWS WITH ATTACHED BLANKETS, HEAD AND NECK SUPPORT PILLOWS WITH ATTACHED BLANKET FOR SMALL AND PREMATURE INFANTS, TRAVEL PILLOWS, NAP MATS, BUMPER GUARDS FOR PORTABLE BEDS, PORTABLE CONVERTIBLE BABY BEDS, PORTABLE BEDS FOR INFANTS AND BABIES, SLEEPING MATS, BOTTLE-HOLDING PILLOWS (U.S. CLS. 2, 13, 22, 25, 32 AND 50).

CLASS 24—FABRICS

FOR PILLOW COVERS, FABRIC CRIB BUMPERS USED TO DIVIDE CRIBS, CRIB RAIL COVERS, INFANT BLANKETS, BUMPER PADS FOR PORTABLE BEDS (U.S. CLS. 42 AND 50).

CLASS 25—CLOTHING

FOR SKULL CAPS, CLOTH BIBS, BABY BIBS NOT OF PAPER, INFANT AND TODDLER ONE PIECE CLOTHING, SLEEPWEAR, CLOTH DIAPERS, INFANT SLEEPERS, INFANTWEAR, SWADDLING CLOTHES, T-SHIRTS (U.S. CLS. 22 AND 39).

CLASS 28—TOYS AND SPORTING GOODS

FOR PLAY MATS HAVING POCKETS FOR CONTAINING TOYS (U.S. CLS. 22, 23, 38 AND 50).
KATHRYN COWARD, EXAMINING ATTORNEY

SN 77-181,153, ARBOR NETWORKS, INC., LEXINGTON, MA. FILED 5-15-2007.

HOW NETWORKS GROW

THE MARK CONSISTS OF STANDARD CHARACTERS WITHOUT CLAIM TO ANY PARTICULAR FONT, STYLE, SIZE, OR COLOR.

CLASS 9—ELECTRICAL AND SCIENTIFIC APPARATUS

FOR ANTI-SPYWARE SOFTWARE; COMPUTER SEARCH ENGINE SOFTWARE; COMPUTER SOFTWARE FOR ACCESSING INFORMATION DIRECTORIES THAT MAY BE DOWNLOADED FROM THE GLOBAL COMPUTER NETWORK; COMPUTER SOFTWARE FOR COMPUTER SYSTEM AND APPLICATION DEVELOPMENT, DEPLOYMENT AND MANAGEMENT; COMPUTER SOFTWARE FOR CONTROLLING AND MANAGING ACCESS SERVER APPLICATIONS; COMPUTER SOFTWARE FOR CREATING SEARCHABLE DATABASES OF INFORMATION AND DATA; COMPUTER SOFTWARE FOR ENCRYPTION; COMPUTER SOFTWARE FOR PROVIDING AN ON-LINE DATABASE IN THE FIELD OF TRANSACTION PROCESSING TO UPLOAD TRANSACTIONAL DATA, PROVIDE STATISTICAL ANALYSIS, AND PRODUCE NOTIFICATIONS AND REPORTS; COMPUTER SOFTWARE FOR THE CREATION OF FIREWALLS; COMPUTER SOFTWARE FOR USE IN THE SAFEGUARDING OF DIGITAL FILES, INCLUDING AUDIO, VIDEO, TEXT, BINARY, STILL IMAGES, GRAPHICS AND MULTIMEDIA FILES; COMPUTER SOFTWARE FOR USE IN NETWORK SECURITY, MONITORING AND OPTIMIZATION; COMPUTER SOFTWARE THAT PROVIDES REAL-TIME, INTEGRATED BUSINESS MANAGEMENT INTELLIGENCE BY COMBINING INFORMATION FROM VARIOUS DATABASES AND PRESENTING IT IN AN EASY-TO-UNDERSTAND USER INTERFACE; COMPUTER SOFTWARE TO AUTOMATE DATA WAREHOUSING; DECODER SOFTWARE; ENTERPRISE SOFTWARE IN THE NATURE OF A DATABASE FOR NON-TRANSACTIONAL DATA AND A SEARCH ENGINE FOR DATABASE CONTENT; NETWORK ACCESS SERVER OPERATING SOFTWARE; SOFTWARE FOR ENSURING THE SECURITY OF ELECTRONIC MAIL; COMPUTER HARDWARE; COMPUTER HARDWARE, NAMELY, FIREWALLS; COMPUTER NETWORKING HARDWARE; GATEWAY ROUTERS IN THE NATURE OF COMPUTER CONTROL HARDWARE; NETWORK ACCESS SERVER HARDWARE; COMPUTER HARDWARE AND SOFTWARE FOR SETTING UP AND CONFIGURING LOCAL AREA NETWORKS; COMPUTER NETWORK HUBS,

SWITCHES AND ROUTERS; COMPUTER PROGRAMS FOR SEARCHING THE CONTENTS OF COMPUTERS AND COMPUTER NETWORKS BY REMOTE CONTROL (U.S. CLS. 21, 23, 26, 36 AND 38).

CLASS 42—SCIENTIFIC AND COMPUTER SERVICES

FOR APPLICATION SERVICE PROVIDER (ASP), NAMELY, HOSTING COMPUTER SOFTWARE APPLICATIONS OF OTHERS; APPLICATION SERVICE PROVIDER FEATURING SOFTWARE FOR PROVIDING AN ON-LINE DATABASE IN THE FIELD OF TRANSACTION PROCESSING TO UPLOAD TRANSACTIONAL DATA, PROVIDE STATISTICAL ANALYSIS, AND PRODUCE NOTIFICATIONS AND REPORTS; COMPUTER SERVICE, NAMELY, ACTING AS AN APPLICATION SERVICE PROVIDER IN THE FIELD OF KNOWLEDGE MANAGEMENT TO HOST COMPUTER APPLICATION SOFTWARE FOR SEARCHING AND RETRIEVING INFORMATION FROM DATABASES AND COMPUTER NETWORKS; COMPUTER SERVICE, NAMELY, ACTING AS AN APPLICATION SERVICE PROVIDER IN THE FIELD OF KNOWLEDGE MANAGEMENT TO HOST COMPUTER APPLICATION SOFTWARE FOR THE COLLECTION, EDITING, ORGANIZING, MODIFYING, BOOK MARKING, TRANSMISSION, STORAGE AND SHARING OF DATA AND INFORMATION; COMPUTER SOFTWARE CONSULTANCY; COMPUTER SOFTWARE CONSULTATION; COMPUTER SOFTWARE DEVELOPMENT; CONSULTATION SERVICES IN THE FIELDS OF SELECTION, IMPLEMENTATION AND USE OF COMPUTER HARDWARE AND SOFTWARE SYSTEMS FOR OTHERS; CUSTOMIZATION OF COMPUTER HARDWARE AND SOFTWARE; DATA AUTOMATION AND COLLECTION SERVICE USING PROPRIETARY SOFTWARE TO EVALUATE, ANALYZE AND COLLECT SERVICE DATA; DEVELOPMENT OF SOFTWARE FOR SECURE NETWORK OPERATIONS; DEVELOPMENT, UPDATING AND MAINTENANCE OF SOFTWARE AND DATA BASES; INSTALLATION OF COMPUTER SOFTWARE; MAINTENANCE OF COMPUTER SOFTWARE; PERIODIC UPGRADING OF COMPUTER SOFTWARE FOR OTHERS; TECHNICAL SUPPORT SERVICES, NAMELY, TROUBLESHOOTING OF COMPUTER HARDWARE AND SOFTWARE PROBLEMS; TECHNICAL SUPPORT SERVICES, NAMELY, TROUBLESHOOTING OF COMPUTER SOFTWARE PROBLEMS; UP-DATING OF COMPUTER SOFTWARE FOR OTHERS; COMPUTER HARDWARE DEVELOPMENT; COMPUTER MONITORING SERVICE WHICH TRACKS HARDWARE PERFORMANCE AND PROCESSES AND SENDS OUT HISTORICAL REPORTS AND ALERTS; DESIGN OF COMPUTER HARDWARE, INTEGRATED CIRCUITS, COMMUNICATIONS HARDWARE AND SOFTWARE AND COMPUTER NETWORKS FOR OTHERS; COMPUTER CONSULTATION IN THE FIELD OF COMPUTER SECURITY; COMPUTER SECURITY SERVICE, NAMELY, RESTRICTING ACCESS TO AND BY COMPUTER NETWORKS TO AND OF UNDESIRE WEB SITES, MEDIA AND INDIVIDUALS AND FACILITIES; RESEARCH IN THE FIELD OF INTELLIGENCE AND SECURITY; COMPUTER SERVICES, NAMELY MONITORING AND REPORTING ON THE PERFORMANCE, AVAILABILITY, AND ERRORS OF WEBSITES OF OTHERS; COMPUTER SERVICES, NAMELY, MONITORING, TESTING, ANALYZING, AND REPORTING ON THE INTERNET TRAFFIC CONTROL AND CONTENT CONTROL OF THE WEBSITES OF OTHERS; MONITORING THE COMPUTER SYSTEMS OF OTHERS FOR TECHNICAL PURPOSES AND PROVIDING BACK-UP COMPUTER PROGRAMS AND FACILITIES; TECHNICAL SUPPORT, NAMELY, MONITORING OF NETWORK SYSTEMS; INTEGRATION OF COMPUTER SYSTEMS AND NETWORKS (U.S. CLS. 100 AND 101).

CLASS 45—PERSONAL AND LEGAL SERVICES

FOR CONSULTING SERVICES IN THE FIELD OF MAINTAINING THE SECURITY AND INTEGRITY OF DATABASES; ELECTRONIC MONITORING SERVICES FOR SECURITY PURPOSES IN THE FIELD OF NETWORK USE AND SECURITY (U.S. CLS. 100 AND 101).
INGRID C. EULIN, EXAMINING ATTORNEY

SN 77-184,316. LIVE GREEN, LIVE SMART, LLC, WAYZATA, MN. FILED 5-18-2007.

LIVE GREEN, LIVE SMART

THE MARK CONSISTS OF STANDARD CHARACTERS WITHOUT CLAIM TO ANY PARTICULAR FONT, STYLE, SIZE, OR COLOR.

CLASS 35—ADVERTISING AND BUSINESS

FOR PROVIDING LINKS TO THE WEBSITES OF OTHERS FEATURING INFORMATION ABOUT GOODS AND SERVICES OF OTHERS THAT PROMOTE ENVIRONMENTALLY RESPONSIBLE LIFESTYLE CHOICES VIA THE INTERNET (U.S. CLS. 100, 101 AND 102).
FIRST USE 4-22-2007; IN COMMERCE 4-22-2007.

CLASS 39—TRANSPORTATION AND STORAGE

FOR PROVIDING LINKS TO THE WEBSITES OF OTHERS FEATURING INFORMATION IN THE FIELD OF ENVIRONMENTALLY RESPONSIBLE TRANSPORTATION VIA THE INTERNET (U.S. CLS. 100 AND 105).
FIRST USE 4-22-2007; IN COMMERCE 4-22-2007.
ANTHONY RINKER, EXAMINING ATTORNEY

SN 77-184,564. DALLAGO, KAREN, MERRICK, NY. FILED 5-18-2007.

ONE IS BETTER THAN NONE

THE MARK CONSISTS OF STANDARD CHARACTERS WITHOUT CLAIM TO ANY PARTICULAR FONT, STYLE, SIZE, OR COLOR.

CLASS 35—ADVERTISING AND BUSINESS

FOR ON-LINE RETAIL STORE SERVICES AND RETAIL STORE SERVICES FEATURING, SHIRTS, HATS, JACKETS, BRACELETS, JEWELRY, MUGS, CALENDARS AND NOTE CARDS (U.S. CLS. 100, 101 AND 102).

CLASS 36—INSURANCE AND FINANCIAL

FOR CHARITABLE FUNDRAISING SERVICES (U.S. CLS. 100, 101 AND 102).
ERNEST SHOSHO, EXAMINING ATTORNEY

SN 77-185,672. INTECH SOFTWARE SOLUTIONS, INC., NORCROSS, GA. FILED 5-21-2007.

BioSecureAccess

THE MARK CONSISTS OF STANDARD CHARACTERS WITHOUT CLAIM TO ANY PARTICULAR FONT, STYLE, SIZE, OR COLOR.

CLASS 9—ELECTRICAL AND SCIENTIFIC APPARATUS

FOR COMPUTER HARDWARE AND SOFTWARE FOR BIOMETRIC AUTHENTICATION AND AUTHORIZATION OF WEB-BASED APPLICATION USERS (U.S. CLS. 21, 23, 26, 36 AND 38).

CLASS 42—SCIENTIFIC AND COMPUTER SERVICES

FOR CONSULTANCY SERVICES FOR INTEGRATING AND TAILORING SOFTWARE APPLICATIONS TO USE BIOMETRIC AUTHENTICATION AND AUTHORIZATION (U.S. CLS. 100 AND 101).
SHAUNIA CARLYLE, EXAMINING ATTORNEY

SN 77-186,575. PAYNE, KIMBERLI, BALTIMORE, MD. FILED 5-21-2007.

K. LOVE THE INFINITE

THE MARK CONSISTS OF STANDARD CHARACTERS WITHOUT CLAIM TO ANY PARTICULAR FONT, STYLE, SIZE, OR COLOR.

CLASS 35—ADVERTISING AND BUSINESS

FOR ON-LINE RETAIL STORE SERVICES FEATURING CDS AND VENDOR SERVICES FEATURING CDS (U.S. CLS. 100, 101 AND 102).

CLASS 41—EDUCATION AND ENTERTAINMENT

FOR ENTERTAINMENT IN THE NATURE OF LIVE PERFORMANCES BY A RAPPER (U.S. CLS. 100, 101 AND 107).
BARBARA BROWN, EXAMINING ATTORNEY

SN 77-187,146. ANNCO, INC., MILFORD, CT. FILED 5-22-2007.

ANN CARES

THE MARK CONSISTS OF STANDARD CHARACTERS WITHOUT CLAIM TO ANY PARTICULAR FONT, STYLE, SIZE, OR COLOR.
OWNER OF U.S. REG. NO. 3,020,741.

CLASS 35—ADVERTISING AND BUSINESS

FOR RETAIL STORE SERVICES FEATURING ENVIRONMENTALLY RESPONSIBLE PRACTICES IN THE FIELD OF CLOTHING, FOOTWEAR, HANDBAGS, SMALL LEATHER ACCESSORIES, JEWELRY, TOILETRIES, BATH PRODUCTS, AND COSMETIC PRODUCTS (U.S. CLS. 100, 101 AND 102).

CLASS 36—INSURANCE AND FINANCIAL

FOR CHARITABLE FUND RAISING SERVICES, NAMELY, SHARING PROFITS FROM PRODUCT SALES WITH NOT-FOR-PROFIT ORGANIZATIONS; AND CHARITABLE FUND RAISING (U.S. CLS. 100, 101 AND 102).

JUSTINE D. PARKER, EXAMINING ATTORNEY

SN 77-187,767. NATURAL INTERACTION SYSTEMS, LLC, DBA ADAPX, SEATTLE, WA. FILED 5-22-2007.

ADAPX

THE MARK CONSISTS OF STANDARD CHARACTERS WITHOUT CLAIM TO ANY PARTICULAR FONT, STYLE, SIZE, OR COLOR.

CLASS 9—ELECTRICAL AND SCIENTIFIC APPARATUS

FOR OPTICAL LIGHT PENS, COMPUTER STYLUS; COMPUTER SOFTWARE, NAMELY COMPUTER SOFTWARE FOR SCANNING DIGITAL IMAGES AND TEXT; PERSONAL DIGITAL ASSISTANT SOFTWARE, NAMELY COMPUTER SOFTWARE FOR MEETING AND EVENT SCHEDULING, MANAGING CALENDARS, MANAGING AND DELEGATING TASKS AND RECORDING NOTES; STYLUS SOFTWARE, NAMELY SOFTWARE FOR INTERPRETING GESTURES MADE WITH A STYLUS OR DIGITAL PEN; HANDWRITING SOFTWARE, NAMELY SOFTWARE FOR INTERPRETING HANDWRITING FOR PERSONAL DIGITAL ASSISTANT DEVICES, PHONES, AND COMPUTERS; COMPUTER SOFTWARE, NAMELY HANDWRITING RECOGNITION SOFTWARE FOR MAP-BASED PLANNING, LOGISTICS, DATA COLLECTION AND OTHER GEO-SPATIAL APPLICATION (U.S. CLS. 21, 23, 26, 36 AND 38).

CLASS 16—PAPER GOODS AND PRINTED MATTER

FOR PENS, DIGITAL PAPER PRINTED WITH A PATTERN WHICH IS REGISTERED BY A DIGITAL PEN WHEN WRITING THEREON (U.S. CLS. 2, 5, 22, 23, 29, 37, 38 AND 50).

TANYA AMOS, EXAMINING ATTORNEY

SN 77-187,770. NATURAL INTERACTION SYSTEMS, LLC, DBA ADAPX, SEATTLE, WA. FILED 5-22-2007.

PENX

THE MARK CONSISTS OF STANDARD CHARACTERS WITHOUT CLAIM TO ANY PARTICULAR FONT, STYLE, SIZE, OR COLOR.

CLASS 9—ELECTRICAL AND SCIENTIFIC APPARATUS

FOR OPTICAL LIGHT PENS, COMPUTER STYLUS; COMPUTER SOFTWARE, NAMELY COMPUTER SOFTWARE FOR SCANNING DIGITAL IMAGES AND TEXT; PERSONAL DIGITAL ASSISTANT SOFTWARE, NAMELY COMPUTER SOFTWARE FOR MEETING AND EVENT SCHEDULING, MANAGING CALENDARS, MANAGING AND DELEGATING TASKS AND RECORDING NOTES; STYLUS SOFTWARE, NAMELY SOFTWARE FOR INTERPRETING GESTURES MADE WITH A STYLUS OR DIGITAL PEN; HANDWRITING SOFTWARE, NAMELY SOFTWARE FOR INTERPRETING HANDWRITING FOR PERSONAL DIGITAL ASSISTANT DEVICES, PHONES, AND COMPUTERS; COMPUTER SOFTWARE, NAMELY HANDWRITING RECOGNITION SOFTWARE FOR MAP-BASED PLANNING, LOGISTICS, DATA COLLECTION AND OTHER GEO-SPATIAL APPLICATION (U.S. CLS. 21, 23, 26, 36 AND 38).

CLASS 16—PAPER GOODS AND PRINTED MATTER

FOR PENS, DIGITAL PAPER PRINTED WITH A PATTERN WHICH IS REGISTERED BY A DIGITAL PEN WHEN WRITING THEREON (U.S. CLS. 2, 5, 22, 23, 29, 37, 38 AND 50).

TANYA AMOS, EXAMINING ATTORNEY

SN 77-187,774. NATURAL INTERACTION SYSTEMS, LLC, DBA ADAPX, SEATTLE, WA. FILED 5-22-2007.

JOURNALX

THE MARK CONSISTS OF STANDARD CHARACTERS WITHOUT CLAIM TO ANY PARTICULAR FONT, STYLE, SIZE, OR COLOR.

CLASS 9—ELECTRICAL AND SCIENTIFIC APPARATUS

FOR OPTICAL LIGHT PENS, COMPUTER STYLUS; COMPUTER SOFTWARE, NAMELY COMPUTER SOFTWARE FOR SCANNING DIGITAL IMAGES AND TEXT; PERSONAL DIGITAL ASSISTANT SOFTWARE, NAMELY COMPUTER SOFTWARE FOR MEETING AND EVENT SCHEDULING, MANAGING CALENDARS, MANAGING AND DELEGATING TASKS AND RECORDING NOTES; STYLUS SOFTWARE, NAMELY SOFTWARE FOR INTERPRETING GESTURES MADE WITH A STYLUS OR DIGITAL PEN; HANDWRITING SOFTWARE, NAMELY SOFTWARE FOR INTERPRETING HANDWRITING FOR PERSONAL DIGITAL ASSISTANT DEVICES, PHONES, AND COMPUTERS; COMPUTER SOFTWARE, NAMELY HANDWRITING RECOGNITION SOFTWARE FOR MAP-BASED PLANNING, LOGISTICS, DATA COLLECTION AND OTHER GEO-SPATIAL APPLICATION (U.S. CLS. 21, 23, 26, 36 AND 38).

CLASS 16—PAPER GOODS AND PRINTED MATTER

FOR PENS, DIGITAL PAPER PRINTED WITH A PATTERN WHICH IS REGISTERED BY A DIGITAL PEN WHEN WRITING THEREON (U.S. CLS. 2, 5, 22, 23, 29, 37, 38 AND 50).

TANYA AMOS, EXAMINING ATTORNEY

SN 77-188,163. PATH PARTNERS, LOS ANGELES, CA.
FILED 5-23-2007.

THE MARK CONSISTS OF THE WORD PATH WRITTEN
IN BLOCK LETTERS.

**CLASS 16—PAPER GOODS AND PRINTED
MATTER**

FOR PAPER GOODS, NAMELY, PRINTED AWARD
CERTIFICATES, NOTE CARDS, STICKERS, AND BUSI-
NESS FORMS (U.S. CLS. 2, 5, 22, 23, 29, 37, 38 AND 50).

**CLASS 43—HOTEL AND RESTAURANT SER-
VICES**

FOR PROVIDING TEMPORARY TO LONG-TERM
HOUSING ACCOMODATIONS TO THE HOMELESS;
PROVIDING FOOD AND SHELTER TO THE HOMELESS
(U.S. CLS. 100 AND 101).

ROBIN MITTLER, EXAMINING ATTORNEY

SN 77-188,167. AMIDEE CAPITAL GROUP, LLC, HOUSTON,
TX. FILED 5-23-2007.

THE MARK CONSISTS OF STANDARD CHARACTERS
WITHOUT CLAIM TO ANY PARTICULAR FONT, STYLE,
SIZE, OR COLOR.

CLASS 36—INSURANCE AND FINANCIAL

FOR APPRAISAL OF REAL ESTATE; APPRAISALS
FOR INSURANCE CLAIMS OF REAL ESTATE; ASSESS-
MENT AND MANAGEMENT OF REAL ESTATE; ES-
TATE PLANNING; ESTATE TRUST MANAGEMENT;
EVALUATION OF REAL PROPERTY; FINANCIAL IN-
VESTMENT IN THE FIELD OF REAL ESTATE; FINAN-
CIAL SERVICES, NAMELY ESTATE SETTLEMENT
SERVICES; FINANCIAL VALUATION OF PERSONAL
PROPERTY AND REAL ESTATE; HOUSING SERVICES,
NAMELY, REAL PROPERTY ACQUISITION AND CON-
SUMER FINANCING TO FACILITATE HOME OWNER-
SHIP; LAND ACQUISITION, NAMELY, REAL ESTATE
BROKERAGE; LEASING OF REAL ESTATE; LEASING
OF REAL PROPERTY; PROVIDING INFORMATION IN
THE FIELD OF REAL ESTATE BY MEANS OF LINKING
THE WEB SITE TO OTHER WEB SITES FEATURING
REAL ESTATE INFORMATION; PROVIDING INFOR-
MATION IN THE FIELD OF REAL ESTATE VIA THE
INTERNET; PROVIDING ONLINE INFORMATION IN
THE FIELD CHARITABLE MONETARY GIVING
THROUGH FINANCIAL AND ESTATE PLANNING;
PROVIDING REAL ESTATE LISTINGS AND REAL
ESTATE INFORMATION VIA THE INTERNET; REAL
ESTATE ACQUISITION SERVICES; REAL ESTATE
AGENCIES; REAL ESTATE APPRAISAL; REAL ESTATE
BROKERAGE; REAL ESTATE CONSULTANCY; REAL
ESTATE CONSULTATION; REAL ESTATE EQUITY
SHARING, NAMELY, MANAGING AND ARRANGING
FOR CO-OWNERSHIP OF REAL ESTATE; REAL ES-
TATE ESCROW SERVICES; REAL ESTATE INVEST-
MENT; REAL ESTATE INVESTMENT SERVICES IN
THE NATURE OF PURCHASING AND SELLING OF
REAL ESTATE FOR OTHERS; REAL ESTATE LENDING
SERVICES; REAL ESTATE LISTING; REAL ESTATE
MANAGEMENT; REAL ESTATE MANAGEMENT CON-
SULTATION; REAL ESTATE MULTIPLE LISTING SER-
VICES; REAL ESTATE PROCUREMENT FOR OTHERS;
REAL ESTATE SERVICES, NAMELY, RENTAL OF
VACATION HOMES, CONDOMINIUMS, CABINS, AND
VILLAS USING PAY PER CLICK ADVERTISING ON A
GLOBAL COMPUTER NETWORK; REAL ESTATE SYN-
DICATION; REAL ESTATE TIME-SHARING; REAL ES-
TATE TRUSTEE SERVICES; REAL ESTATE
VALUATION SERVICES; REAL ESTATE VALUATIONS;
VACATION REAL ESTATE TIME SHARE EXCHANGE
SERVICES; VACATION REAL ESTATE TIME-SHARING;
VACATION REAL ESTATE TIMESHARE SERVICES
(U.S. CLS. 100, 101 AND 102).

FIRST USE 1-2-2004; IN COMMERCE 3-22-2004.

CLASS 37—CONSTRUCTION AND REPAIR

FOR HOUSING SERVICES, NAMELY, DEVELOP-
MENT OF REAL PROPERTY, NAMELY, REPAIR, IM-
PROVEMENT, AND NEW CONSTRUCTION; HOUSING
SERVICES, NAMELY, REPAIR, IMPROVEMENT, AND
CONSTRUCTION OF RESIDENTIAL REAL PROPERTY;
REAL ESTATE DEVELOPMENT; REAL ESTATE SITE
SELECTION (U.S. CLS. 100, 103 AND 106).

FIRST USE 1-2-2004; IN COMMERCE 8-3-2004.

NAAKWAMA ANKRAH, EXAMINING ATTORNEY

SN 77-188,273. PATH PARTNERS, LOS ANGELES, CA.
FILED 5-23-2007.



THE MARK CONSISTS OF THE WORDS PATH PARTNERS, WITH THE WORD PATH WRITTEN IN BLOCK LETTERS ABOVE THE WORD PARTNERS, AND THE LETTER "A" IN THE WORD PARTNERS IS WRITTEN IN THE DESIGN OF A HOUSE.

CLASS 16—PAPER GOODS AND PRINTED MATTER

FOR PAPER GOODS, NAMELY, PRINTED AWARD CERTIFICATES, NOTE CARDS, STICKERS, AND BUSINESS FORMS (U.S. CLS. 2, 5, 22, 23, 29, 37, 38 AND 50).

CLASS 25—CLOTHING

FOR CLOTHING, NAMELY, SHIRTS, SWEATSHIRTS, AND HEADWEAR (U.S. CLS. 22 AND 39).

CLASS 36—INSURANCE AND FINANCIAL

FOR CHARITABLE FUNDRAISING SERVICES (U.S. CLS. 100, 101 AND 102).
ROBIN MITTLER, EXAMINING ATTORNEY

SN 77-188,310. NATURAL INTERACTION SYSTEMS, LLC,
DBA ADAPX, SEATTLE, WA. FILED 5-23-2007.

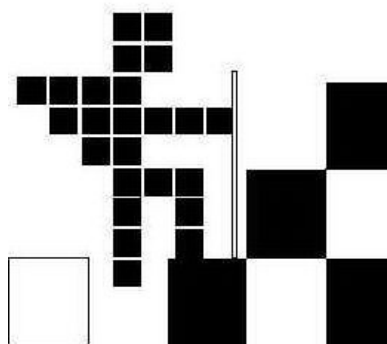

THE MARK CONSISTS OF A STICK FIGURE OF A PERSON IN BLOCK FORM HOLDING A CLIMBING-AID ASCENDING AN OBJECT..

CLASS 9—ELECTRICAL AND SCIENTIFIC APPARATUS

FOR OPTICAL LIGHT PENS, COMPUTER STYLUS; COMPUTER SOFTWARE, NAMELY COMPUTER SOFTWARE FOR SCANNING DIGITAL IMAGES AND TEXT; PERSONAL DIGITAL ASSISTANT SOFTWARE, NAMELY COMPUTER SOFTWARE FOR MEETING AND EVENT SCHEDULING, MANAGING CALENDARS, MANAGING AND DELEGATING TASKS AND RECORDING NOTES; STYLUS SOFTWARE, NAMELY SOFTWARE FOR INTERPRETING GESTURES MADE WITH A STYLUS OR DIGITAL PEN; HANDWRITING SOFTWARE, NAMELY SOFTWARE FOR INTERPRETING HANDWRITING FOR PERSONAL DIGITAL ASSISTANT DEVICES, PHONES, AND COMPUTERS; COMPUTER SOFTWARE, NAMELY HANDWRITING RECOGNITION SOFTWARE FOR MAP-BASED PLANNING, LOGISTICS, DATA COLLECTION AND OTHER GEO-SPATIAL APPLICATION (U.S. CLS. 21, 23, 26, 36 AND 38).

CLASS 16—PAPER GOODS AND PRINTED MATTER

FOR PENS, DIGITAL PAPER PRINTED WITH A PATTERN WHICH IS REGISTERED BY A DIGITAL PEN WHEN WRITING THEREON (U.S. CLS. 2, 5, 22, 23, 29, 37, 38 AND 50).

TANYA AMOS, EXAMINING ATTORNEY

SN 77-188,835. PECHANGA BAND OF LUISENO MISSION INDIANS OF THE PECHANGA RESERVATION, CALIFORNIA, TEMECULA, CA. FILED 5-23-2007.



OWNER OF U.S. REG. NOS. 3,221,965, 3,247,029 AND OTHERS.

NO CLAIM IS MADE TO THE EXCLUSIVE RIGHT TO USE "DEVELOPMENT CORPORATION", APART FROM THE MARK AS SHOWN.

THE MARK CONSISTS OF THE WORDS PECHANGA DEVELOPMENT CORPORATION WITH DOWNWARD FEATHERS.

CLASS 41—EDUCATION AND ENTERTAINMENT

FOR CASINOS; CONDUCTING AND PROVIDING FACILITIES FOR SPECIAL EVENTS FEATURING GAMING CONTESTS AND TOURNAMENTS; PROVIDING FACILITIES FOR SPORTS TOURNAMENTS; PROVIDING SPORTING FACILITIES; ORGANIZING COMMUNITY CULTURAL EVENTS; CASINO AND CARD GAME SERVICES; GAMING SERVICES (U.S. CLS. 100, 101 AND 107).

FIRST USE 6-24-2002; IN COMMERCE 6-24-2002.

CLASS 43—HOTEL AND RESTAURANT SERVICES

FOR HOTEL, BAR, SNACK BAR, COFFEE BAR AND RESTAURANT SERVICES (U.S. CLS. 100 AND 101).

FIRST USE 6-24-2002; IN COMMERCE 6-24-2002.
KATHY DE JONGE, EXAMINING ATTORNEY

SN 77-189,725. TELEFLEX INCORPORATED, LIMERICK, PA. FILED 5-24-2007.

SN 77-191,402. ABERTIS INFRAESTRUCTURAS, S.A., BARCELONA, SPAIN, FILED 5-28-2007.

CONNECTING WITH CAR MAKERS
AROUND THE WORLD

THE MARK CONSISTS OF STANDARD CHARACTERS WITHOUT CLAIM TO ANY PARTICULAR FONT, STYLE, SIZE, OR COLOR.

CLASS 9—ELECTRICAL AND SCIENTIFIC APPARATUS

FOR ELECTRONIC CONTROLS FOR GASOLINE ENGINES FOR LAND VEHICLES; CRUISE CONTROLS FOR MOTOR VEHICLES (U.S. CLS. 21, 23, 26, 36 AND 38).

CLASS 12—VEHICLES

FOR VEHICLE SEATS; HOOD AND DOOR CABLE RELEASES; PARK, LOCK AND BRAKE CABLES; ACCELERATOR AND CRUISE CONTROL CABLES; GEAR SHIFTS; SHIFT KNOBS; SHIFT TOWERS; SHIFT MECHANISMS AND SHIFT CABLES FOR AUTO AND OTHER VEHICLE MANUFACTURERS (U.S. CLS. 19, 21, 23, 31, 35 AND 44).

G. MAYERSCHOFF, EXAMINING ATTORNEY

SN 77-189,970. THE STAND, LLC, ENCINO, CA. FILED 5-24-2007.

THE STAND "ALWAYS THE
FINEST"

THE MARK CONSISTS OF STANDARD CHARACTERS WITHOUT CLAIM TO ANY PARTICULAR FONT, STYLE, SIZE, OR COLOR.

OWNER OF U.S. REG. NO. 3,109,045.

CLASS 29—MEATS AND PROCESSED FOODS

FOR BAKED BEANS; CHILI; COLE SLAW; FRANKFURTERS; HOT DOGS; PROCESSED CABBAGE; SAUERKRAUT; SAUSAGES; TURKEY BURGER PATTIES; VEGGIE BURGER PATTIES; UNCOOKED HAMBURGER PATTIES (U.S. CL. 46).

CLASS 30—STAPLE FOODS

FOR RELISH; FRUIT COBBLERS; MUSTARD; SAUCES (U.S. CL. 46).

GEORGE LORENZO, EXAMINING ATTORNEY

ABERTIS BRINGING THE WORLD
CLOSER

THE MARK CONSISTS OF STANDARD CHARACTERS WITHOUT CLAIM TO ANY PARTICULAR FONT, STYLE, SIZE, OR COLOR.

CLASS 16—PAPER GOODS AND PRINTED MATTER

FOR PUBLICATIONS, NAMELY, MAGAZINES, BROCHURES, BOOKLETS, AND TEACHING MATERIALS IN THE FIELD OF MOTORWAYS, TELECOMMUNICATIONS INFRASTRUCTURE, CAR PARKING, AIRPORTS AND LOGISTIC PLATFORMS (U.S. CLS. 2, 5, 22, 23, 29, 37, 38 AND 50).

CLASS 35—ADVERTISING AND BUSINESS

FOR BUSINESS MANAGEMENT OF MOTORWAYS, TELECOMMUNICATIONS INFRASTRUCTURE, CAR PARKING, AIRPORTS AND LOGISTIC PLATFORMS (U.S. CLS. 100, 101 AND 102).

MARK SPARACINO, EXAMINING ATTORNEY

SN 77-192,517. PECHANGA BAND OF LUISENO MISSION INDIANS OF THE PECHANGA RESERVATION, CALIFORNIA, TEMECULA, CA. FILED 5-29-2007.

JOURNEY AT PECHANGA

THE MARK CONSISTS OF STANDARD CHARACTERS WITHOUT CLAIM TO ANY PARTICULAR FONT, STYLE, SIZE, OR COLOR.

OWNER OF U.S. REG. NOS. 3,192,746, 3,247,029 AND OTHERS.

CLASS 35—ADVERTISING AND BUSINESS

FOR RETAIL STORE FEATURING GOLF CLOTHING, GOLF SUPPLIES AND GOLF EQUIPMENT (U.S. CLS. 100, 101 AND 102).

CLASS 41—EDUCATION AND ENTERTAINMENT

FOR CONDUCTING AND PROVIDING FACILITIES FOR SPECIAL EVENTS FEATURING GOLF TOURNAMENTS; ENTERTAINMENT IN THE NATURE OF GOLF TOURNAMENTS; GOLF COURSES; GOLF CLUB SERVICES; GOLF DRIVING RANGE SERVICES; GOLF INSTRUCTION RENTAL OF GOLF EQUIPMENT; GOLF CADDIE SERVICES; CONDUCTING AND PROVIDING FACILITIES FOR SPECIAL EVENTS FEATURING CASINO AND GAMING TOURNAMENTS; ENTERTAINMENT IN THE NATURE OF CASINO AND GAMING TOURNAMENTS (U.S. CLS. 100, 101 AND 107).

KATHY DE JONGE, EXAMINING ATTORNEY

SN 77-192,939. HYATT CORPORATION, CHICAGO, IL.
FILED 5-30-2007.

SN 77-195,487. JTM PROVISIONS COMPANY, INC., HARRISON, OH. FILED 6-1-2007.

EASY BAG

THE MARK CONSISTS OF STANDARD CHARACTERS WITHOUT CLAIM TO ANY PARTICULAR FONT, STYLE, SIZE, OR COLOR.

CLASS 43—HOTEL AND RESTAURANT SERVICES

FOR HOTELS; MOTELS; RESORT HOTELS; AND SPECIALIZED HOTEL SERVICES RENDERED AS PART OF A PROGRAM FOR FREQUENT HOTEL GUESTS (U.S. CLS. 100 AND 101).

CLASS 45—PERSONAL AND LEGAL SERVICES

FOR HOTEL CONCIERGE SERVICES (U.S. CLS. 100 AND 101).
KARANENDRA S. CHHINA, EXAMINING ATTORNEY

SN 77-195,054. IPME, LLLP, WESTMINSTER, CO. FILED 5-31-2007.

SUCCESSFUL LIVING

THE MARK CONSISTS OF STANDARD CHARACTERS WITHOUT CLAIM TO ANY PARTICULAR FONT, STYLE, SIZE, OR COLOR.

CLASS 35—ADVERTISING AND BUSINESS

FOR BUSINESS CONSULTING SERVICES (U.S. CLS. 100, 101 AND 102).
FIRST USE 12-7-2005; IN COMMERCE 12-7-2005.

CLASS 41—EDUCATION AND ENTERTAINMENT

FOR EDUCATIONAL SERVICES, NAMELY, CONDUCTING CLASSES IN THE FIELDS OF BUSINESS, FINANCE AND REAL ESTATE INVESTMENTS, AND DISTRIBUTING TEXTBOOKS AND WORKBOOKS IN CONNECTION THEREWITH (U.S. CLS. 100, 101 AND 107).

FIRST USE 12-7-2005; IN COMMERCE 12-7-2005.
GENE MACIOL, EXAMINING ATTORNEY



THE MARK CONSISTS OF THE WORDS CABIN CREEK APPEARING WITHIN A TWO-DIMENSIONAL CIRCLE.

CLASS 29—MEATS AND PROCESSED FOODS

FOR SOUPS (U.S. CL. 46).

CLASS 30—STAPLE FOODS

FOR SAUCES; MIXES FOR MAKING COMBINED NOODLE AND SAUCE DISHES (U.S. CL. 46).
CHRISTOPHER OTT, EXAMINING ATTORNEY

SN 77-196,046. HELEN OF TROY LIMITED, ST. MICHAEL, BARBADOS, FILED 6-1-2007.



OWNER OF U.S. REG. NOS. 1,652,173, 1,917,087 AND OTHERS.

THE MARK CONSISTS OF THE TERM "OXO" CONTAINED WITHIN A DARKENED OVAL SHAPE.

CLASS 8—HAND TOOLS

FOR FLATWARE, NAMELY, FORKS, KNIVES, AND SPOONS; CAN OPENERS; MANUALLY OPERATED HAND TOOLS, NAMELY, PLIERS, HAMMERS, SCREWDRIVERS, CUTTERS IN THE NATURE OF UTILITY KNIVES, SAWS, SCRAPERS, WRENCHES, FILES, CLAMPS, CHISELS; GARDENING TOOLS, NAMELY TROWELS, WEEDING FORKS, CULTIVATORS; SCISSORS; HOUSEHOLD KNIVES; HAND-OPERATED SLICERS; MEAT TENDERIZER, NAMELY, A KITCHEN Mallet; HAND-OPERATED CHOPPERS; HAND TOOLS, NAMELY, SCRAPERS; NON-ELECTRIC CAN OPENERS; NON-ELECTRIC FRUIT AND VEGETABLE PEELERS; FRUIT CORERS; GRAPEFRUIT TRIMMER, NAMELY, A KITCHEN KNIFE WITH SERRATED EDGES; ZESTERS; PIZZA CUTTERS; CHEESE SLICERS (U.S. CLS. 23, 28 AND 44).

FIRST USE 8-1-1990; IN COMMERCE 8-1-1990.

CLASS 9—ELECTRICAL AND SCIENTIFIC APPARATUS

FOR MEASURING CUPS; MEASURING SPOONS (U.S. CLS. 21, 23, 26, 36 AND 38).
FIRST USE 8-1-1990; IN COMMERCE 8-1-1990.

CLASS 21—HOUSEWARES AND GLASS

FOR HOUSEHOLD UTENSILS, NAMELY, CAKE AND PIE SERVERS, JAR OPENERS, ICE CREAM SCOOPS, BOTTLE OPENERS, GARLIC PRESSES, PRESSES IN THE NATURE OF LEMON SQUEEZERS, PRESSES IN THE NATURE OF POTATO RICERS, TURNERS, SPATULAS, COOKING SPOONS, COOKING FORKS, VEGETABLE MASHERS, WHISKS, GRATERS; CONTAINERS FOR HOUSEHOLD OR KITCHEN USE NOT OF PRECIOUS METAL; PORTABLE PLASTIC CONTAINERS FOR STORING HOUSEHOLD AND KITCHEN GOODS; BOWLS; SALAD SPINNERS; PET BRUSHES; CONTAINERS FOR HOUSEHOLD USE; COOKING POTS AND PANS; BROOMS; MOPS; DUSTING BRUSHES; TOILET BRUSHES; SCRUBBING BRUSHES; UTENSILS FOR BARBECUES, NAMELY, FORKS, TONGS, TURNERS; DUST BINS; DUST-PANS; NON-ELECTRIC JUICERS; COLANDERS; CORK SCREWS; NON-ELECTRIC KETTLES; PLUNGERS FOR CLEARING BLOCKED DRAINS (U.S. CLS. 2, 13, 23, 29, 30, 33, 40 AND 50).
FIRST USE 8-1-1990; IN COMMERCE 8-1-1990.
LAURA HAMMEL, EXAMINING ATTORNEY

SN 77-197,510. HATTERAS HAMMOCKS, INC., GREENVILLE, NC. FILED 6-5-2007.

SIESTA

THE MARK CONSISTS OF STANDARD CHARACTERS WITHOUT CLAIM TO ANY PARTICULAR FONT, STYLE, SIZE, OR COLOR.

CLASS 20—FURNITURE AND ARTICLES NOT OTHERWISE CLASSIFIED

FOR PILLOWS (U.S. CLS. 2, 13, 22, 25, 32 AND 50).
FIRST USE 4-1-1993; IN COMMERCE 4-1-1993.

CLASS 22—CORDAGE AND FIBERS

FOR HAMMOCKS; HAMMOCK SWINGS; HAMMOCK STANDS, AND HAMMOCK ACCESSORIES, NAMELY, HANGING HARDWARE SOLD WITH THE SWING; ROCKING KITS SPECIFICALLY DESIGNED FOR USE WITH HAMMOCKS; DRINK HOLDERS AND FOOD CADDIES SPECIFICALLY DESIGNED TO ATTACH TO HAMMOCKS (U.S. CLS. 1, 2, 7, 19, 22, 42 AND 50).
FIRST USE 4-1-1993; IN COMMERCE 4-1-1993.
ANGELA M. MICHELI, EXAMINING ATTORNEY

SN 77-197,759. LANCER INSURANCE COMPANY, LONG BEACH, NY. FILED 6-5-2007.

TRUXFAX

THE MARK CONSISTS OF STANDARD CHARACTERS WITHOUT CLAIM TO ANY PARTICULAR FONT, STYLE, SIZE, OR COLOR.

CLASS 16—PAPER GOODS AND PRINTED MATTER

FOR PROVIDING NEWSLETTERS IN THE FIELDS OF MOTORIZED VEHICLE SAFETY, MOTORIZED VEHICLE OPERATIONS, AND INSURANCE SERVICES (U.S. CLS. 2, 5, 22, 23, 29, 37, 38 AND 50).
FIRST USE 0-0-1999; IN COMMERCE 0-0-1999.

CLASS 41—EDUCATION AND ENTERTAINMENT

FOR PROVIDING ELECTRONIC NEWSLETTERS VIA E-MAIL IN THE FIELDS OF MOTORIZED VEHICLE SAFETY, MOTORIZED VEHICLE OPERATIONS, AND INSURANCE SERVICES; PROVIDING ELECTRONIC NEWSLETTERS AVAILABLE ONLINE IN THE FIELDS OF MOTORIZED VEHICLE SAFETY, MOTORIZED VEHICLE OPERATIONS, AND INSURANCE SERVICES (U.S. CLS. 100, 101 AND 107).
FIRST USE 0-0-1999; IN COMMERCE 0-0-1999.
DAVID I, EXAMINING ATTORNEY

SN 77-197,799. PLAYSTAR, INC., JANESVILLE, WI. FILED 6-5-2007.

PLAYSTAR

THE MARK CONSISTS OF STANDARD CHARACTERS WITHOUT CLAIM TO ANY PARTICULAR FONT, STYLE, SIZE, OR COLOR.
OWNER OF U.S. REG. NOS. 2,250,557, 2,770,825 AND OTHERS.

CLASS 6—METAL GOODS

FOR METAL GOODS, NAMELY, HOOKS SHELVING BRACKETS, BINS, GENERAL PURPOSE STORAGE CONTAINERS (U.S. CLS. 2, 12, 13, 14, 23, 25 AND 50).

CLASS 20—FURNITURE AND ARTICLES NOT OTHERWISE CLASSIFIED

FOR SHELVES; NON-METAL GOODS, NAMELY, HOOKS, SHELVING BRACKETS, BINS, PACKING CONTAINERS OF PLASTIC MATERIAL; WORK TABLES HAVING ADJUSTABLE WORK SURFACES; AND DRAWERS (U.S. CLS. 2, 13, 22, 25, 32 AND 50).
RONALD MCMORROW, EXAMINING ATTORNEY

SN 77-198,579. CLIF BAR & CO., BERKELEY, CA. FILED 6-5-2007.

CLIF SHOT

THE MARK CONSISTS OF STANDARD CHARACTERS WITHOUT CLAIM TO ANY PARTICULAR FONT, STYLE, SIZE, OR COLOR.

OWNER OF U.S. REG. NOS. 2,089,043, 3,057,646 AND OTHERS.

CLASS 5—PHARMACEUTICALS

FOR POWDERED FRUIT-FLAVORED DIETARY SUPPLEMENT DRINK MIX (U.S. CLS. 6, 18, 44, 46, 51 AND 52).

FIRST USE 4-0-2005; IN COMMERCE 4-0-2005.

CLASS 32—LIGHT BEVERAGES

FOR POWDERS USED IN THE PREPARATION OF ISOTONIC SPORTS DRINKS (U.S. CLS. 45, 46 AND 48).

FIRST USE 4-0-2005; IN COMMERCE 4-0-2005.

ALEXANDER L. POWERS, EXAMINING ATTORNEY

SN 77-199,147. THE KROGER CO. OF MICHIGAN, LIVONIA, MI. FILED 6-6-2007.

CLOUDBURST

THE MARK CONSISTS OF STANDARD CHARACTERS WITHOUT CLAIM TO ANY PARTICULAR FONT, STYLE, SIZE, OR COLOR.

CLASS 4—LUBRICANTS AND FUELS

FOR SCENTED CANDLES (U.S. CLS. 1, 6 AND 15).

CLASS 5—PHARMACEUTICALS

FOR AIR FRESHENERS (U.S. CLS. 6, 18, 44, 46, 51 AND 52).

CHERYL CLAYTON, EXAMINING ATTORNEY

SN 77-199,711. THE KROGER CO. OF MICHIGAN, LIVONIA, MI. FILED 6-6-2007.

PURE OUTDOORS

THE MARK CONSISTS OF STANDARD CHARACTERS WITHOUT CLAIM TO ANY PARTICULAR FONT, STYLE, SIZE, OR COLOR.

CLASS 4—LUBRICANTS AND FUELS

FOR SCENTED CANDLES (U.S. CLS. 1, 6 AND 15).

CLASS 5—PHARMACEUTICALS

FOR AIR FRESHENERS (U.S. CLS. 6, 18, 44, 46, 51 AND 52).

CHERYL CLAYTON, EXAMINING ATTORNEY

SN 77-199,875. THE KROGER CO. OF MICHIGAN, LIVONIA, MI. FILED 6-7-2007.

SUN DRENCHED CITRUS

THE MARK CONSISTS OF STANDARD CHARACTERS WITHOUT CLAIM TO ANY PARTICULAR FONT, STYLE, SIZE, OR COLOR.

NO CLAIM IS MADE TO THE EXCLUSIVE RIGHT TO USE "CITRUS", APART FROM THE MARK AS SHOWN.

CLASS 4—LUBRICANTS AND FUELS

FOR SCENTED CANDLES (U.S. CLS. 1, 6 AND 15).

CLASS 5—PHARMACEUTICALS

FOR AIR FRESHENERS (U.S. CLS. 6, 18, 44, 46, 51 AND 52).

CHERYL CLAYTON, EXAMINING ATTORNEY

SN 77-200,489. THE KROGER CO. OF MICHIGAN, LIVONIA, MI. FILED 6-7-2007.

BLUE SKY

THE MARK CONSISTS OF STANDARD CHARACTERS WITHOUT CLAIM TO ANY PARTICULAR FONT, STYLE, SIZE, OR COLOR.

CLASS 4—LUBRICANTS AND FUELS

FOR SCENTED CANDLES (U.S. CLS. 1, 6 AND 15).

CLASS 5—PHARMACEUTICALS

FOR AIR FRESHENERS (U.S. CLS. 6, 18, 44, 46, 51 AND 52).

CHERYL CLAYTON, EXAMINING ATTORNEY

SN 77-200,669. THE KROGER CO. OF MICHIGAN, LIVONIA, MI. FILED 6-7-2007.

CHANCE

THE MARK CONSISTS OF STANDARD CHARACTERS WITHOUT CLAIM TO ANY PARTICULAR FONT, STYLE, SIZE, OR COLOR.

CLASS 4—LUBRICANTS AND FUELS

FOR SCENTED CANDLES (U.S. CLS. 1, 6 AND 15).

CLASS 5—PHARMACEUTICALS

FOR AIR FRESHENERS (U.S. CLS. 6, 18, 44, 46, 51 AND 52).
CHERYL CLAYTON, EXAMINING ATTORNEY

SN 77-204,664. BROOKSTONE PURCHASING, INC., MERRIMACK, NH. FILED 6-13-2007.

Better Than Down

THE MARK CONSISTS OF STANDARD CHARACTERS WITHOUT CLAIM TO ANY PARTICULAR FONT, STYLE, SIZE, OR COLOR.

CLASS 20—FURNITURE AND ARTICLES NOT OTHERWISE CLASSIFIED

FOR PILLOWS; MATTRESS TOPPERS (U.S. CLS. 2, 13, 22, 25, 32 AND 50).

CLASS 24—FABRICS

FOR COMFORTERS; BED LINEN; BED BLANKETS; BLANKET THROWS; DUVET COVERS; DUVETS (U.S. CLS. 42 AND 50).

JAMES LOVELACE, EXAMINING ATTORNEY

SN 77-206,652. SOUTH CONE, INC., CARLSBAD, CA. FILED 6-14-2007.

REEF

THE MARK CONSISTS OF STANDARD CHARACTERS WITHOUT CLAIM TO ANY PARTICULAR FONT, STYLE, SIZE, OR COLOR.

OWNER OF U.S. REG. NOS. 2,244,373, 2,418,438 AND OTHERS.

CLASS 20—FURNITURE AND ARTICLES NOT OTHERWISE CLASSIFIED

FOR SLEEPING BAGS (U.S. CLS. 2, 13, 22, 25, 32 AND 50).

CLASS 22—CORDAGE AND FIBERS

FOR TENTS; HAMMOCKS (U.S. CLS. 1, 2, 7, 19, 22, 42 AND 50).
MAUREEN DALL, EXAMINING ATTORNEY

SN 77-206,665. SOUTH CONE, INC., CARLSBAD, CA. FILED 6-14-2007.

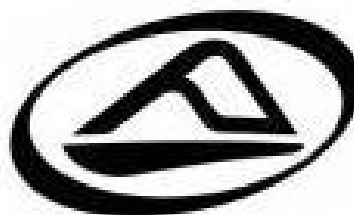

OWNER OF U.S. REG. NOS. 2,315,934 AND 2,889,412.
THE MARK CONSISTS OF THE STYLIZED DESIGN OF A WAVE ENCLOSED IN AN OVAL BORDER.

CLASS 20—FURNITURE AND ARTICLES NOT OTHERWISE CLASSIFIED

FOR SLEEPING BAGS (U.S. CLS. 2, 13, 22, 25, 32 AND 50).

CLASS 22—CORDAGE AND FIBERS

FOR TENTS; HAMMOCKS (U.S. CLS. 1, 2, 7, 19, 22, 42 AND 50).
MAUREEN DALL, EXAMINING ATTORNEY

SN 77-208,905. SNAPWARE CORPORATION, MIRA LOMA, CA. FILED 6-18-2007.

DURAPLAST

THE MARK CONSISTS OF STANDARD CHARACTERS WITHOUT CLAIM TO ANY PARTICULAR FONT, STYLE, SIZE, OR COLOR.

CLASS 20—FURNITURE AND ARTICLES NOT OTHERWISE CLASSIFIED

FOR PORTABLE PLASTIC STORAGE CONTAINERS FOR COMMERCIAL OR INDUSTRIAL USE (U.S. CLS. 2, 13, 22, 25, 32 AND 50).
FIRST USE 5-15-2007; IN COMMERCE 5-15-2007.

CLASS 21—HOUSEWARES AND GLASS

FOR PORTABLE PLASTIC STORAGE CONTAINERS FOR STORING HOUSEHOLD, GARAGE AND OFFICE GOODS (U.S. CLS. 2, 13, 23, 29, 30, 33, 40 AND 50).
FIRST USE 5-15-2007; IN COMMERCE 5-15-2007.
GEORGE LORENZO, EXAMINING ATTORNEY

SN 77-209,309. MANHEIM AUCTIONS, INC., ATLANTA, GA.
FILED 6-19-2007.



OWNER OF U.S. REG. NOS. 1,699,332, 3,229,428 AND OTHERS.

NO CLAIM IS MADE TO THE EXCLUSIVE RIGHT TO USE "RIVERSIDE", APART FROM THE MARK AS SHOWN. THE COLOR(S) GOLD, BLUE, BROWN, GREY, BLACK AND WHITE IS/ARE CLAIMED AS A FEATURE OF THE MARK.

THE MARK CONSISTS OF A GOLD "M" OVER A BLUE CIRCULAR BACKGROUND AND WITHIN TWO GOLD OUTER RINGS. THE COLOR BROWN OUTLINES THE MARK. TO THE RIGHT OF THE M IS THE WORD "MANHEIM" IN THE COLOR BLACK. A BLACK LINE SEPARATES THE ABOVE DESIGN AND THE WORD "MANHEIM" AND THE WORD "RIVERSIDE" IN THE COLOR BLACK AND A STYLIZED LETTER "R" IN THE COLOR WHITE WITH THE DESIGN OF A PALM TREE IN THE CENTER OF THE LETTER "R" IN THE COLOR BLUE ON A BLUE BACKGROUND, INSIDE CONCENTRIC WHITE AND GREY SQUARES TO THE RIGHT OF THE WORD "RIVERSIDE".

CLASS 35—ADVERTISING AND BUSINESS

FOR AUTOMOBILE AUCTION SERVICES; AUTOMOBILE AUCTION SERVICES PROVIDED VIA THE INTERNET (U.S. CLS. 100, 101 AND 102).

CLASS 36—INSURANCE AND FINANCIAL

FOR AUTOMOBILE FINANCING SERVICES (U.S. CLS. 100, 101 AND 102).

CLASS 37—CONSTRUCTION AND REPAIR

FOR AUTOMOTIVE DETAILING, RECONDITIONING, REPAIR, CONVERSION, AND CUSTOMIZATION SERVICES (U.S. CLS. 100, 103 AND 106).

CLASS 39—TRANSPORTATION AND STORAGE

FOR BUSINESS-TO-BUSINESS AUTOMOTIVE TRANSPORTATION AND STORAGE SERVICES (U.S. CLS. 100 AND 105).

CLASS 42—SCIENTIFIC AND COMPUTER SERVICES

FOR AUTOMOTIVE INSPECTION SERVICES (U.S. CLS. 100 AND 101).
GRETTA YAO, EXAMINING ATTORNEY

SN 77-209,694. UCB PHARMA, S.A., BRUXELLES, BELGIUM, FILED 6-19-2007.

The X-Y-Z- of A-L-lergy
relief

THE MARK CONSISTS OF STANDARD CHARACTERS WITHOUT CLAIM TO ANY PARTICULAR FONT, STYLE, SIZE, OR COLOR.

CLASS 5—PHARMACEUTICALS

FOR PHARMACEUTICAL PRODUCTS FOR THE TREATMENT OF RESPIRATORY DISEASES, NAMELY, ANTI-ALLERGIC AND ANTI-ASTHMATIC DECONGESTANTS (U.S. CLS. 6, 18, 44, 46, 51 AND 52).

CLASS 16—PAPER GOODS AND PRINTED MATTER

FOR PRINTED MATERIALS, NAMELY, INFORMATIONAL BOOKLETS, BROCHURES, LEAFLETS, DIAGRAMS AND CHARTS ON THE SUBJECT OF ALLERGIES (U.S. CLS. 2, 5, 22, 23, 29, 37, 38 AND 50).

CLASS 44—MEDICAL, BEAUTY AND AGRICULTURAL SERVICES

FOR DISEASE MANAGEMENT SERVICES, NAMELY, PROVIDING INFORMATION ABOUT ALLERGIES, THEIR CAUSES AND TREATMENTS, AND EFFECTIVE USES OF APPROPRIATE MEDICINES TO HEALTH CARE PROFESSIONALS AND PATIENTS (U.S. CLS. 100 AND 101).

REBECCA POVARCHUK, EXAMINING ATTORNEY

SN 77-211,962. MEDICAL DEVELOPMENT INTERNATIONAL LTD., INC., PONTE VEDRA BEACH, FL. FILED 6-21-2007.

EARL

THE MARK CONSISTS OF STANDARD CHARACTERS WITHOUT CLAIM TO ANY PARTICULAR FONT, STYLE, SIZE, OR COLOR.

CLASS 9—ELECTRICAL AND SCIENTIFIC APPARATUS

FOR MEDICAL CARE SOFTWARE FOR ADMINISTRATION, TRACKING AND ANALYSIS OF HEALTH ISSUES, SEVERITY, TREATMENT, CLAIMS, AND SPECIFIC EXPENDITURES PER INDIVIDUAL PATIENT (U.S. CLS. 21, 23, 26, 36 AND 38).

CLASS 42—SCIENTIFIC AND COMPUTER SERVICES

FOR PROVIDING TEMPORARY USE OF NONDOWNLOADABLE MEDICAL CARE SOFTWARE ON THE INTERNET FOR ADMINISTRATION, TRACKING AND ANALYSIS OF HEALTH ISSUES, SEVERITY, TREATMENT, CLAIMS AND SPECIFIC EXPENDITURES PER INDIVIDUAL PATIENT (U.S. CLS. 100 AND 101).

TANYA AMOS, EXAMINING ATTORNEY

SN 77-212,370. MEDICAL DEVELOPMENT INTERNATIONAL LTD., INC., PONTE VEDRA BEACH, FL. FILED 6-21-2007.



THE MARK CONSISTS OF SILHOUETTE OF MALE FIGURE COMPOSED OF GEOMETRIC SHAPES WITH ARMS OUTSTRETCHED AND LEGS IN RUNNING POSITION.

CLASS 9—ELECTRICAL AND SCIENTIFIC APPARATUS

FOR MEDICAL CARE SOFTWARE FOR ADMINISTRATION, TRACKING AND ANALYSIS OF HEALTH ISSUES, SEVERITY, TREATMENT, CLAIMS, AND SPECIFIC EXPENDITURES PER INDIVIDUAL PATIENT (U.S. CLS. 21, 23, 26, 36 AND 38).

CLASS 42—SCIENTIFIC AND COMPUTER SERVICES

FOR PROVIDING TEMPORARY USE OF NONDOWNLOADABLE MEDICAL CARE SOFTWARE ON THE INTERNET FOR ADMINISTRATION, TRACKING AND ANALYSIS OF HEALTH ISSUES, SEVERITY, TREATMENT, CLAIMS AND SPECIFIC EXPENDITURES PER INDIVIDUAL PATIENT (U.S. CLS. 100 AND 101).
TANYA AMOS, EXAMINING ATTORNEY

SN 77-213,618. WAL-MART STORES, INC., BENTONVILLE, AR. FILED 6-22-2007.

CANOPY

THE MARK CONSISTS OF STANDARD CHARACTERS WITHOUT CLAIM TO ANY PARTICULAR FONT, STYLE, SIZE, OR COLOR.

CLASS 4—LUBRICANTS AND FUELS

FOR CANDLES (U.S. CLS. 1, 6 AND 15).

CLASS 20—FURNITURE AND ARTICLES NOT OTHERWISE CLASSIFIED

FOR PICTURE FRAMES; PLASTIC TISSUE BOX COVERS; SHOWER CURTAIN RINGS (U.S. CLS. 2, 13, 22, 25, 32 AND 50).

CLASS 21—HOUSEWARES AND GLASS

FOR BATH ACCESSORIES, NAMELY, CUP HOLDERS; TOOTHBRUSH HOLDERS; SHOWER CADDIES; SOAP DISHES; TOILET BRUSH HOLDERS; TOILET PAPER DISPENSERS; TOILET TISSUE HOLDERS; SOAP DISPENSERS; LOTION DISPENSERS; COTTON BALL DISPENSERS; TRASH CANS (U.S. CLS. 2, 13, 23, 29, 30, 33, 40 AND 50).

CLASS 24—FABRICS

FOR TOWELS; SHOWER CURTAINS; THROWS (U.S. CLS. 42 AND 50).

CLASS 27—FLOOR COVERINGS

FOR RUGS (U.S. CLS. 19, 20, 37, 42 AND 50).
SCOTT SISUN, EXAMINING ATTORNEY

SN 77-213,696. ORACLE INTERNATIONAL CORPORATION, REDWOOD CITY, CA. FILED 6-22-2007.



OWNER OF U.S. REG. NOS. 1,200,239, 3,030,079 AND OTHERS.

NO CLAIM IS MADE TO THE EXCLUSIVE RIGHT TO USE "ARENA" FOR CLASS 41, APART FROM THE MARK AS SHOWN.

THE COLOR(S) RED, WHITE AND BLACK IS/ARE CLAIMED AS A FEATURE OF THE MARK.

THE MARK CONSISTS OF THE WORDS "ORACLE ARENA" WITH THE WORD "ORACLE" ON A RECTANGULAR SHAPE. THE COLOR RED APPEARS IN THE RECTANGULAR SHAPE. THE COLOR WHITE APPEARS IN THE WORD "ORACLE". THE COLOR BLACK APPEARS IN THE WORD "ARENA".

CLASS 9—ELECTRICAL AND SCIENTIFIC APPARATUS

FOR SPORTS HELMETS, TELEPHONES, CELL PHONE COVERS, CELL PHONE STRAPS, MAGNETICALLY ENCODED PREPAID TELEPHONE CALLING CARDS, MAGNETIC CODED CHARGE CARDS, DECORATIVE MAGNETS, PRE-RECORDED CDS, VIDEOTAPES, LASERDISKS AND DVDS FEATURING SPORTS, MUSIC AND ENTERTAINMENT, COMPUTER GAME SOFTWARE, COMPUTER GAME DISKS, VIDEO GAME CARTRIDGES, COMPUTER MOUSE PADS, CAMERA CASES, SUNGLASSES, EYEGLOSS CASES, EYEGLOSS CHAINS, BINOCULARS, LIGHT SWITCH COVERS, NEON SIGNS, SWIMMING GOGGLES (U.S. CLS. 21, 23, 26, 36 AND 38).

CLASS 16—PAPER GOODS AND PRINTED MATTER

FOR PRINTED PAPER SIGNS, POSTERS, TRADING CARDS, MAGAZINES RELATING TO SPORTS AND ENTERTAINMENT, POSTCARDS, CALENDARS, WRAPPING PAPER, PAPER AND CARDBOARD GIFT BOXES, PAPER STICKERS, BOOKS RELATING TO SPORTS AND ENTERTAINMENT, POSTERBOOKS, NOTEPADS, PAPER HATS, GREETING CARDS, BUSINESS CARDS, STICKERS, PAPER NAPKINS, PAPER TOWELS, LUNCH BAGS, FOOD WRAPPERS, PLASTIC BAGS AND PAPER FOR FOOD PACKAGING, STATIONERY, PRINTED TICKETS, CARDBOARD FLOOR DISPLAY UNITS FOR MERCHANDISING, PAPER PENNANTS, PAPER BANNERS, PENCILS, PENS AND PEN SETS; PHOTOGRAPHS, SPORTS COLLECTIBLES AND SPORTS MEMORABILIA, NAMELY, BASEBALL, BASKETBALL, AND FOOTBALL CARDS, PHOTOGRAPHS, PAPER PENNANTS AND POSTERS (U.S. CLS. 2, 5, 22, 23, 29, 37, 38 AND 50).

CLASS 21—HOUSEWARES AND GLASS

FOR CUPS, MUGS, SHOT GLASSES, TUMBLERS, PLASTIC WATER BOTTLES SOLD EMPTY, SPORTS BOTTLES SOLD EMPTY, TRAVEL CUPS (U.S. CLS. 2, 13, 23, 29, 30, 33, 40 AND 50).

CLASS 25—CLOTHING

FOR MEN'S, WOMEN'S AND CHILDREN'S CLOTHING, NAMELY, CAPS, HATS, VISORS, HEADBANDS, EAR MUFFS, HATS WHICH LOWER TO COVER THE FACE, BELTS, WRISTBANDS, T-SHIRTS, TANK TOPS, PAJAMAS AND SLEEP WEAR, SHIRTS, SWEATERS, SHORTS, SWEATSHIRTS, JACKETS, NECKTIES, SUSPENDERS, CLOTH BIBS, JERSEYS, COATS, ROBES, PARKAS, PONCHOS, GLOVES, SCARVES, SNOW SUITS, MITTENS, APRONS, SWEATPANTS, JEANS, PANTS, SOCKS, UNDERWEAR, UNIFORMS, AND SWIMWEAR (U.S. CLS. 22 AND 39).

CLASS 28—TOYS AND SPORTING GOODS

FOR SPORTS BALLS OF ALL TYPES; WEIGHTS FOR EXERCISE AND FOR LIFTING; WEIGHT LIFTING BELTS; PROTECTIVE PADDING FOR PLAYING BASEBALL, BASKETBALL, AND FOOTBALL; ATHLETIC EQUIPMENT, NAMELY, GUARDS AND BODY PROTECTORS FOR THE HEAD, FACE, ELBOWS, KNEES, AND GROIN; GOLF BAGS, HEAD COVERS FOR GOLF CLUBS, GOLF TEES AND BALL MARKERS; BASEBALL, AND SOFTBALL BATS; MITTS AND GLOVES FOR BASEBALL; ICE SKATES (U.S. CLS. 22, 23, 38 AND 50).

CLASS 41—EDUCATION AND ENTERTAINMENT

FOR PROVIDING STADIUM FACILITIES FOR SPORTS AND ENTERTAINMENT; ARRANGING AND CONDUCTING ATHLETIC COMPETITIONS; ENTERTAINMENT IN THE NATURE OF SPORTING EVENTS AND ATHLETIC COMPETITIONS; ENTERTAINMENT IN THE NATURE OF LIVE PERFORMANCES BY A MUSICAL BAND, DANCE PERFORMANCES, ORCHESTRAL PERFORMANCES, PLANNING ARRANGEMENT OF SHOWING MOVIES, ELECTRONIC LIGHTING, AND LASER DISPLAYS; PROVIDING INFORMATION IN THE FIELD OF SPORTS AND ENTERTAINMENT BY MEANS OF THE INTERNET, TELEPHONE AND DIGITAL TRANSMISSION; PRODUCTION OF CABLE TELEVISION SYSTEMS; PRODUCTION OF RADIO AND TELEVISION PROGRAMS AND DISTRIBUTION OF TELEVISION PROGRAMMING TO CABLE TELEVISION SYSTEMS; EDUCATIONAL SERVICES, NAMELY, PROVIDING SEMINARS AND COURSES OF INSTRUCTION IN THE FIELD OF TRADE SHOWS AND EXHIBITIONS (U.S. CLS. 100, 101 AND 107).

MORENO, PAUL, EXAMINING ATTORNEY

SN 77-218,969. SCHWAN'S IP, LLC, MARSHALL, MN. FILED 6-29-2007.



THE MARK CONSISTS OF A FILE FOLDER TAB LIKE IMAGE WITH THE WORD "LIVESMART"; THE HORIZONTAL LINE OF THE "L" FORMS AN UNDERLINE OF THE WORD; THE "S" BREAKS THE UNDERLINE.

CLASS 18—LEATHER GOODS

FOR ALL-PURPOSE ATHLETIC BAGS; ALL-PURPOSE CARRYING BAGS (U.S. CLS. 1, 2, 3, 22 AND 41).
FIRST USE 3-1-2007; IN COMMERCE 3-1-2007.

CLASS 25—CLOTHING

FOR GOLF SHIRTS; POLO SHIRTS; SHORT-SLEEVED OR LONG-SLEEVED T-SHIRTS (U.S. CLS. 22 AND 39).
FIRST USE 3-1-2007; IN COMMERCE 3-1-2007.
GISELLE AGOSTO, EXAMINING ATTORNEY

SN 77-219,826. WASTE MANAGEMENT, INC., HOUSTON, TX. FILED 6-30-2007.



THE MARK CONSISTS OF THE WORDS GREEN TEAM AND THE NUMBER 1.

CLASS 37—CONSTRUCTION AND REPAIR

FOR WASTE DISPOSAL FOR OTHERS AND COLLECTION OF TRASH (U.S. CLS. 100, 103 AND 106).

CLASS 39—TRANSPORTATION AND STORAGE

FOR GARBAGE COLLECTION (U.S. CLS. 100 AND 105).
KIMBERLY FRYE, EXAMINING ATTORNEY

SN 77-226,436. FINANCIAL INDUSTRY REGULATORY AUTHORITY, INC., WASHINGTON, DC. FILED 7-10-2007.

FINRA

THE MARK CONSISTS OF STANDARD CHARACTERS WITHOUT CLAIM TO ANY PARTICULAR FONT, STYLE, SIZE, OR COLOR.

CLASS 18—LEATHER GOODS

FOR TOTE BAGS AND UMBRELLAS (U.S. CLS. 1, 2, 3, 22 AND 41).

SN 77-227,795. WAL-MART STORES, INC., BENTONVILLE, AR. FILED 7-12-2007.

CLASS 21—HOUSEWARES AND GLASS

FOR MUGS AND DRINKING GLASSES (U.S. CLS. 2, 13, 23, 29, 30, 33, 40 AND 50).

CLASS 25—CLOTHING

FOR CLOTHING NAMELY, T-SHIRTS, HATS, SWEAT-SHIRTS, JACKETS, VISORS AND SCARVES (U.S. CLS. 22 AND 39).

BONNIE LUKEN, EXAMINING ATTORNEY

PARENT'S CHOICE

THE MARK CONSISTS OF STANDARD CHARACTERS WITHOUT CLAIM TO ANY PARTICULAR FONT, STYLE, SIZE, OR COLOR.

OWNER OF U.S. REG. NOS. 2,360,617, 2,972,528 AND OTHERS.

CLASS 5—PHARMACEUTICALS

FOR BABY FOOD; DIETARY SUPPLEMENTAL DRINKS (U.S. CLS. 6, 18, 44, 46, 51 AND 52).

CLASS 9—ELECTRICAL AND SCIENTIFIC APPARATUS

FOR DISPENSERS THAT COUNT OR MEASURE OUTPUT FOR USE WITH POWDERED BABY FORMULA (U.S. CLS. 21, 23, 26, 36 AND 38).

CLASS 10—MEDICAL APPARATUS

FOR DISPOSABLE BABY BOTTLE LINERS; CUPS ADAPTED FOR FEEDING BABIES AND CHILDREN (U.S. CLS. 26, 39 AND 44).

CLASS 11—ENVIRONMENTAL CONTROL APPARATUS

FOR ELECTRIC HEATERS FOR BABY BOTTLES; ELECTRIC FOOD WARMERS (U.S. CLS. 13, 21, 23, 31 AND 34).

CLASS 21—HOUSEWARES AND GLASS

FOR SCRUBBING BRUSHES (U.S. CLS. 2, 13, 23, 29, 30, 33, 40 AND 50).

CLASS 29—MEATS AND PROCESSED FOODS

FOR DEHYDRATED FRUIT SNACKS; FRUIT-BASED SNACK FOOD (U.S. CL. 46).

SCOTT SISUN, EXAMINING ATTORNEY

SN 77-227,726. WAL-MART STORES, INC., BENTONVILLE, AR. FILED 7-12-2007.

PARENT'S CHOICE

THE MARK CONSISTS OF STANDARD CHARACTERS WITHOUT CLAIM TO ANY PARTICULAR FONT, STYLE, SIZE, OR COLOR.

OWNER OF U.S. REG. NOS. 2,360,617, 2,839,128 AND 2,972,528.

CLASS 5—PHARMACEUTICALS

FOR NURSING PADS (U.S. CLS. 6, 18, 44, 46, 51 AND 52).

CLASS 20—FURNITURE AND ARTICLES NOT OTHERWISE CLASSIFIED

FOR PILLOWS; NURSING PILLOWS (U.S. CLS. 2, 13, 22, 25, 32 AND 50).

CLASS 21—HOUSEWARES AND GLASS

FOR DISHES; BOWLS; PLATES; CUPS (U.S. CLS. 2, 13, 23, 29, 30, 33, 40 AND 50).

CLASS 24—FABRICS

FOR BED SHEETS; BED SKIRTS; CHILDREN'S BLANKETS; RECEIVING BLANKETS; COMFORTERS; THROWS; PILLOW CASES; PILLOW SHAMS; CRIB BUMPER PADS; BURP CLOTHS (U.S. CLS. 42 AND 50).

CLASS 25—CLOTHING

FOR CHILDREN'S AND INFANTS' CLOTH BIBS; PLASTIC BABY BIBS (U.S. CLS. 22 AND 39).

SCOTT SISUN, EXAMINING ATTORNEY

SN 78-158,957. BIOHIT OYJ, HELSINKI, FINLAND, FILED 8-28-2002.

GASTROSOFT

OWNER OF FINLAND REG. NO. 224055, DATED 6-14-2002, EXPIRES 6-14-2012.

CLASS 9—ELECTRICAL AND SCIENTIFIC APPARATUS

FOR (BASED ON 44(E)) COMPUTER PROGRAMS FOR DRAWING UP A DIAGNOSIS OF H.PYLORI-INFECTION AND ATROPHIC GASTRITIS, AND FOR DETERMINING RISK FACTORS FOR GASTRIC CANCER AND PEPTIC ULCER; AND FOR PROVIDING RECOMMENDATIONS FOR TREATMENT AS WELL AS FOR THE NEED AND URGENCY OF FURTHER EXAMINATION, E.G. OF GASTROSCOPY (U.S. CLS. 21, 23, 26, 36 AND 38).

CLASS 42—SCIENTIFIC AND COMPUTER SERVICES

FOR (BASED ON USE IN COMMERCE) PROVIDING TEMPORARY USE OF ON-LINE NON-DOWNLOADABLE SOFTWARE FOR DRAWING UP A DIAGNOSIS OF H.PYLORI-INFECTION AND ATROPHIC GASTRITIS, AND FOR DETERMINING RISK FACTORS FOR GASTRIC CANCER AND PEPTIC ULCER; AND FOR PROVIDING RECOMMENDATIONS FOR TREATMENT AS WELL AS FOR THE NEED AND URGENCY OF FURTHER EXAMINATION, E.G. OF GASTROSCOPY (U.S. CLS. 100 AND 101).

FIRST USE 10-0-2001; IN COMMERCE 10-0-2001.
CAROL SPILS, EXAMINING ATTORNEY

SN 78-303,471. LESAFFRE ET COMPAGNIE, PARIS, FRANCE, FILED 9-22-2003.

NUTRIBIO**CLASS 30—STAPLE FOODS**

FOR YEAST FOR ANIMALS AND YEAST USED AS A RAW MATERIAL IN FOODSTUFFS FOR ANIMALS, ALL OF THE FOREGOING FOR USE IN COMPANION ANIMAL FOODS AND TREATS; YEAST FOR USE AS GROWTH MEDIUM FOR DROSOPHILA (FRUIT FLIES) (U.S. CL. 46).

CLASS 31—NATURAL AGRICULTURAL PRODUCTS

FOR ANIMAL FOODSTUFFS FOR USE IN COMPANION ANIMAL FOODS AND TREATS OR AS GROWTH MEDIUM FOR DROSOPHILA (FRUIT FLIES) (U.S. CLS. 1 AND 46).

SUSAN LESLIE DUBOIS, EXAMINING ATTORNEY

SN 78-284,447. SAN DONATO S.R.L., 53013 GAIOLE IN CHIANTI (SI), ITALY, FILED 8-7-2003.



OWNER OF ITALY REG. NO. 908488, DATED 9-22-2003, EXPIRES 7-25-2013.

THE COLOR(S) GOLD AND BLACK IS/ARE CLAIMED AS A FEATURE OF THE MARK.

THE MARK CONSISTS OF A BLACK OVAL SHIELD, WITH A GOLD BORDER, SURROUNDED BY GOLD LEAFY BRANCHES AND LEAVES, CONTAINING THREE GOLD CURVE DESIGNS WITHIN THE OVAL SHIELD, ALL OF THE GOLD FEATURES HAVING LINING AND OTHER DETAILS IN BLACK.

THE MARK CONSISTS OF AN OVAL SHIELD SURROUNDED BY LEAFY BRANCHES AND LEAVES.

CLASS 25—CLOTHING

FOR TROUSERS, JACKETS, SHIRTS, COATS, OVERCOATS, SWEATERS, T-SHIRTS, PULLOVERS, SUITS, DRESSES, SKIRTS, SOCKS, STOCKINGS, FOOTWEAR (U.S. CLS. 22 AND 39).

CLASS 29—MEATS AND PROCESSED FOODS

FOR OLIVE OIL, EXTRA-VIRGIN OLIVE OIL (U.S. CL. 46).

CLASS 33—WINES AND SPIRITS

FOR WINES, SPARKLING WINES, DISTILLED LIQUORS, GRAPPA BRANDY (U.S. CLS. 47 AND 49).
RICHARD A. STRASER, EXAMINING ATTORNEY

SN 78-342,445. MANSELL CONSTRUCTION LIMITED, WEST ACTON, UNITED KINGDOM, FILED 12-17-2003.

BENDYGIRL

THE MARK CONSISTS OF STANDARD CHARACTERS WITHOUT CLAIM TO ANY PARTICULAR FONT, STYLE, SIZE, OR COLOR.

PRIORITY CLAIMED UNDER SEC. 44(D) ON UNITED KINGDOM APPLICATION NO. 2351441B, FILED 12-16-2003, REG. NO. 2351441B, DATED 12-16-2003, EXPIRES 12-16-2013.

CLASS 3—COSMETICS AND CLEANING PREPARATIONS

FOR NON-MEDICATED SKIN CARE, NAIL CARE AND NON-MEDICATED HAIR CARE PREPARATIONS; MAKEUP, COSMETICS AND SKIN CARE PRODUCTS, NAMELY NON-MEDICATED TOILETRIES, SOAPS, DENTIFRICES, FRAGRANCED BODY SPRAYS; EAU DE TOILETTE; PERFUME; ANTI-PERSPIRANT; PERSONAL DEODORANT; COLOGNE; INCENSE; LIPSTICK; LIP GLOSS; AROMATHERAPY OILS (U.S. CLS. 1, 4, 6, 50, 51 AND 52).

CLASS 9—ELECTRICAL AND SCIENTIFIC APPARATUS

FOR PRE-RECORDED AUDIO AND VIDEO TAPES, CASSETTES, COMPACT DISCS, AUDIO DIGITAL TAPES, CDS AND DVDS ON THE SUBJECT OF HEALTH, FITNESS, FASHION AND PERSONAL LIFESTYLES; DOWNLOADABLE ELECTRONIC PUBLICATIONS IN THE NATURE OF MAGAZINES AND PERIODICALS IN THE FIELDS OF HEALTH, FITNESS, FASHION AND PERSONAL LIFESTYLES; EYEWEAR, NAMELY EYEGLASSES, SUNGLASSES, SWIM GOGGLES, SKI GOGGLES AND STRUCTURAL PARTS THEREFOR; APPARATUS FOR CONVERTING ELECTRONIC RADIATION TO ELECTRICAL ENERGY, NAMELY PHOTOVOLTAIC CLADDING PANELS; PHOTOGRAPHIC SLIDE TRANSPARENCIES (U.S. CLS. 21, 23, 26, 36 AND 38).

CLASS 14—JEWELRY

FOR PRECIOUS METALS AND THEIR ALLOYS AND GOODS IN PRECIOUS METALS OR COATED THEREWITH NOT INCLUDED IN OTHER CLASSES, NAMELY BEVERAGEWARE AND DISHES OF PRECIOUS METAL, CANDLE SNUFFERS AND CANDLESTICKS OF PRECIOUS METAL, NAPKIN RINGS OF PRECIOUS METALS, VASES OF PRECIOUS METAL, JEWELRY CASES OF PRECIOUS METAL, STATUES OF PRECIOUS METAL, RINGS, NECKLACES, BRACELETS, EARRINGS, BROOCHES, DIADEMS MADE OF PRECIOUS METALS OR COATED THEREWITH; JEWELRY AND IMITATION JEWELRY, GEMSTONES; PRECIOUS STONES; SEMI-PRECIOUS GEMSTONES; DIAMONDS; WATCHES, CLOCKS; HOROLOGICAL AND CHRONOMETRIC INSTRUMENTS, NAMELY, CHRONOMETERS; CHRONOGRAPHS FOR USE AS WATCHES, WATCH BRACELETS, WATCH CASES, POCKET WATCHES, WRIST WATCHES, WATCH MOVEMENTS; REPLACEMENT STRUCTURAL PARTS FOR ALL THE AFORESAID GOODS (U.S. CLS. 2, 27, 28 AND 50).

CLASS 16—PAPER GOODS AND PRINTED MATTER

FOR PRINTED MATTER, NAMELY, TAGS AND LABELS MADE OF PAPER; PERSONAL ORGANIZERS AND DAILY PLANNERS; ADDRESS BOOKS; AGENDAS; PHOTOGRAPH ALBUMS; CALENDARS; STATIONERY; DESK ACCESSORIES COMPRISING PENCIL HOLDERS, PENCIL CASES, ERASERS, PENCILS AND PENS, AND PENCIL SHARPENERS; PAPER FOLDERS; DOCUMENT PORTFOLIOS; BOOKMARKS; POSTCARDS; STICKERS; GIFT WRAPPING PAPER; PAPER GIFT BOXES; TISSUE PAPER FOR PACKAGING; SHOPPING BAGS MADE OF PAPER; AND CATALOGS AND NEWSLETTERS IN THE FIELDS OF HEALTH, FITNESS, FASHION AND PERSONAL LIFESTYLES; MOUNTED AND UNMOUNTED PHOTOGRAPHS AND POSTERS; PAPER BABY BIBS (U.S. CLS. 2, 5, 22, 23, 29, 37, 38 AND 50).

CLASS 18—LEATHER GOODS

FOR LUGGAGE; ALL-PURPOSE SPORT BAGS; ATHLETIC BAGS; DUFFEL BAGS; BACKPACKS; HANDBAGS; TEXTILE SHOPPING BAGS; TOTE BAGS; UMBRELLAS; BEACH BAGS; TRAVEL KIT BAGS SOLD EMPTY; BRIEFCASES; WALLETS; PURSES; AND COSMETIC CASES SOLD EMPTY (U.S. CLS. 1, 2, 3, 22 AND 41).

CLASS 25—CLOTHING

FOR CLOTHING, NAMELY, COATS, RAINCOATS, ANORAKS, PARKAS, BLAZERS, JACKETS, CARDIGANS, BOLEROS, SPORT COATS, WIND RESISTANT JACKETS, SUITS, TUXEDOS, VESTS, DRESSES, EVENING GOWNS, JUMPERS, SKIRTS, PANTS, SLACKS, TROUSERS, JEANS, DUNGAREES, JUMPSUITS, OVERALLS, COVERALLS, FLIGHT SUITS, GYM SUITS, JOGGING SUITS, SWEAT PANTS, THERMAL UNDERWEAR, SHORTS, ROMPERS, CULOTTES, SHORTALLS, SHIRTS, SWEATERS, JERSEYS, BLOUSES, TUNICS, SWEATSHIRTS, T-SHIRTS, HALTER TOPS, TANK TOPS, BODY SUITS, UNITARDS, CAMISOLES, CHEMISES, UNDERSHIRTS, SLIPS, FOUNDATION GARMENTS, BODYSHAPERS, BRASSIERES, BUSTIERS, GARTER BELTS, BRIEFS, BOXER SHORTS, BLOOMERS; UNDERGARMENTS NAMELY, PANTIES, LINGERIE; LOUNGEWEAR, NIGHTGOWNS, NIGHT SHIRTS, NEGLIGENCES, ROBES, PYJAMAS, HOSE, PANTYHOSE, TIGHTS, KNEE HIGHS, LEG WARMERS, LEGGINGS, SOCKS, HEAD WEAR, HATS, CAPS, HOODS, HEAD BANDS, NECKTIES, BOW TIES, ASCOTS, POCKET SQUARES, SCARVES, SHAWLS, NECKERCHIEFS, GLOVES, MITTENS, BELTS, SASHES, CUMMERBUNDS, SHOES, FOOTWEAR, BOOTS, ATHLETIC SHOES, ATHLETIC FOOTWEAR, GALOSHES, SWIMWEAR, BATHING SUITS, BATHING TRUNKS, BEACHWEAR, BEACH COVER-UPS, SARONGS, SKI WEAR, SKI SUITS, SKI PANTS, SKI GLOVES, THERMAL SOCKS, INFANT WEAR, CLOTH BIBS, BOOTIES, BABY BUNTING, PLAYSUITS (U.S. CLS. 22 AND 39).

CLASS 41—EDUCATION AND ENTERTAINMENT

FOR PROVIDING FITNESS AND EXERCISE FACILITIES; HEALTH CLUB SERVICES, NAMELY PROVIDING INSTRUCTION AND EQUIPMENT IN THE FIELDS OF PHYSICAL EXERCISE; PHYSICAL FITNESS CONDITIONING CLASSES FEATURING ATHLETICS, GYMNASTICS, YOGA, AEROBICS, CHEER LEADING, TUMBLING, KICK BOXING, DANCE, STRENGTH AND FITNESS EXERCISES; PROVIDING CLASSES, WORKSHOPS, SEMINARS AND PERSONALIZED INSTRUCTION IN THE FIELD OF HEALTH, FITNESS, FASHION AND PERSONAL LIFESTYLES; INSTRUCTION IN THE FIELDS OF PHYSICAL ACTIVITY, ATHLETICS, GYMNASTICS, YOGA, AEROBICS, CHEER LEADING, TUMBLING, KICK BOXING, DANCE, STRENGTH AND FITNESS CONDITIONING, FEATURING ANIMATED COMPONENTS PROVIDED THROUGH THE MEDIA OF TELEVISION AND ON A GLOBAL COMPUTER NETWORK (U.S. CLS. 100, 101 AND 107).
DAVID HOFFMAN, EXAMINING ATTORNEY

SN 78-415,351. NATIONAL ASSOCIATION OF COLLEGE AND UNIVERSITY BUSINESS OFFICERS, WASHINGTON, DC. FILED 5-7-2004.

**CLASS 16—PAPER GOODS AND PRINTED MATTER**

FOR PRINTED REPORTS, BOOKS, MAGAZINES, AND MEMBERSHIP DIRECTORIES, ALL IN THE FIELD OF BUSINESS AND FINANCIAL ADMINISTRATION OF COLLEGES AND UNIVERSITIES (U.S. CLS. 2, 5, 22, 23, 29, 37, 38 AND 50).

FIRST USE 7-0-2003. THE MARK WAS FIRST USED ANYWHERE IN A DIFFERENT FORM OTHER THAN THAT SOUGHT TO BE REGISTERED ON 00/00/1963.; IN COMMERCE 7-0-2003. THE MARK WAS FIRST USED IN COMMERCE IN A DIFFERENT FORM OTHER THAN THAT SOUGHT TO BE REGISTERED ON 00/00/1963..

CLASS 35—ADVERTISING AND BUSINESS

FOR ASSOCIATION SERVICES, NAMELY, PROMOTING SOUND MANAGEMENT AND FINANCIAL ADMINISTRATION IN THE FIELD OF HIGHER EDUCATION; CAREER PLACEMENT SERVICES IN THE FIELD OF THE BUSINESS AND FINANCIAL ADMINISTRATION IN COLLEGES AND UNIVERSITIES; COLLECTING, EXCHANGING, DEVELOPING AND DISSEMINATING BUSINESS INFORMATION RELATING TO SOUND AND ETHICAL BUSINESS AND FINANCIAL MANAGEMENT PRACTICES AND ADMINISTRATION IN COLLEGES AND UNIVERSITIES; ASSISTING OTHER NATIONAL EDUCATIONAL ASSOCIATIONS, NAMELY, PROVIDING ASSISTANCE IN MANAGEMENT OF BUSINESS ACTIVITIES; PROVIDING INFORMATION VIA A COMPUTER WEBSITE IN THE FIELD OF BUSINESS AND FINANCIAL ADMINISTRATION OF COLLEGES AND UNIVERSITIES; PROVIDING ONLINE DIRECTORY INFORMATION SERVICES FEATURING AN ONLINE DIRECTORY OF ASSOCIATION MEMBERS; PROVIDING BUSINESS NETWORKING SERVICES IN THE FIELD OF BUSINESS AND FINANCIAL ADMINISTRATION OF COLLEGES AND UNIVERSITIES THROUGH AN ON-LINE COMMUNITY; PROVIDING TECHNICAL ASSISTANCE TO POLICY MAKERS AND STANDARD SETTING AGENCIES ON ISSUES RELATED TO THE SETTING AND IMPLEMENTATION OF HIGHER EDUCATION POLICY (U.S. CLS. 100, 101 AND 102).

FIRST USE 7-0-2003, THE MARK WAS FIRST USED ANYWHERE IN A DIFFERENT FORM OTHER THAN THAT SOUGHT TO BE REGISTERED ON 00/00/1963.; IN COMMERCE 7-0-2003, THE MARK WAS FIRST USED IN COMMERCE IN A DIFFERENT FORM OTHER THAN THAT SOUGHT TO BE REGISTERED ON 00/00/1963..

CLASS 38—COMMUNICATION

FOR PROVIDING ON-LINE COMMUNICATION FORUMS AND BULLETIN BOARDS FOR TRANSMISSION OF MESSAGES AMONG COMPUTER USERS IN THE FIELDS OF HIGHER EDUCATION AND THE BUSINESS AND FINANCIAL ADMINISTRATION OF COLLEGES AND UNIVERSITIES (U.S. CLS. 100, 101 AND 104).

FIRST USE 3-5-2004, THE MARK WAS FIRST USED ANYWHERE IN A DIFFERENT FORM OTHER THAN THAT SOUGHT TO BE REGISTERED ON 00/00/1963.; IN COMMERCE 3-5-2004, THE MARK WAS FIRST USED IN COMMERCE IN A DIFFERENT FORM OTHER THAN THAT SOUGHT TO BE REGISTERED ON 00/00/1963..

CLASS 41—EDUCATION AND ENTERTAINMENT

FOR EDUCATIONAL SERVICES, NAMELY, CONDUCTING WORKSHOPS, SEMINARS, CONVENTIONS AND PROVIDING DISTANCE LEARNING SERVICES IN THE FIELD OF BUSINESS AND FINANCIAL ADMINISTRATION OF COLLEGES AND UNIVERSITIES, AND DISTRIBUTING COURSE MATERIALS IN CONNECTION THEREWITH; PROMOTING EXCELLENCE WITHIN THE FIELDS OF COLLEGE AND UNIVERSITY MANAGEMENT AND FINANCIAL ADMINISTRATION, AND PROVIDING INCENTIVES FOR INDIVIDUALS TO DEMONSTRATE EXCELLENCE THROUGH THE ISSUANCE OF AWARDS; EDUCATIONAL RESEARCH AND DEVELOPMENT RELATING TO SOUND AND ETHICAL BUSINESS AND FINANCIAL ADMINISTRATION OF COLLEGES AND UNIVERSITIES (U.S. CLS. 100, 101 AND 107).

FIRST USE 8-0-2003, THE MARK WAS FIRST USED ANYWHERE IN A DIFFERENT FORM OTHER THAN THAT SOUGHT TO BE REGISTERED ON 00/00/1963.; IN COMMERCE 8-0-2003, THE MARK WAS FIRST USED IN COMMERCE IN A DIFFERENT FORM OTHER THAN THAT SOUGHT TO BE REGISTERED ON 00/00/1963..

GEORGE LORENZO, EXAMINING ATTORNEY

SN 78-439,833, NBS TECHNOLOGIES INC., TORONTO, CANADA, FILED 6-23-2004.



PRIORITY CLAIMED UNDER SEC. 44(D) ON CANADA APPLICATION NO. 1215002, FILED 4-28-2004, REG. NO. TMA662,494, DATED 4-11-2006, EXPIRES 4-11-2021.

THE MARK IS NOT IN COLOR.

CLASS 7—MACHINERY

FOR MACHINERY AND HARDWARE NAMELY EMBOSsing, MILLING, EMBEDDING AND LAMINATING MACHINERY FOR CUSTOMIZING CARDS, NAMELY, FOR EMBOSsing AND ENCODING FINANCIAL CREDIT AND DEBIT CARDS, MAGNETIC CODED CARDS, PERSONAL IDENTIFICATION CARDS, PROMOTIONAL CARDS AND SMART CARDS (U.S. CLS. 13, 19, 21, 23, 31, 34 AND 35).

CLASS 9—ELECTRICAL AND SCIENTIFIC APPARATUS

FOR PRINTERS FOR CUSTOMIZING CARDS, NAMELY, FOR TRANSPOSING CUSTOM GRAPHICS AND PHOTOGRAPHIC IMAGES ONTO FINANCIAL CREDIT AND DEBIT CARDS, MAGNETIC CODED CARDS, PERSONAL IDENTIFICATION CARDS, PROMOTIONAL CARDS AND SMART CARDS; POINT OF SALE TERMINALS FOR PROCESSING DEBIT AND CREDIT CARD TRANSACTIONS AND RETAIL GIFT CARD AND REWARD PROGRAMS; SECURE IDENTIFICATION AND ACCESS CONTROL HARDWARE AND SOFTWARE; COMPUTER SOFTWARE FOR USE IN CUSTOMIZING FINANCIAL CREDIT AND DEBIT CARDS, MAGNETIC CODED CARDS, PERSONAL IDENTIFICATION CARDS, PROMOTIONAL CARDS AND SMART CARDS; COMPUTER SOFTWARE FOR USE IN PRINTERS FOR CUSTOMIZING FINANCIAL CREDIT AND DEBIT CARDS, MAGNETIC CODED CARDS, PERSONAL IDENTIFICATION CARDS, PROMOTIONAL CARDS AND SMART CARDS; COMPUTER SOFTWARE FOR USE IN DEVELOPING CUSTOMIZED TELECOMMUNICATION GATEWAYS; COMPUTER SOFTWARE FOR USE IN DEBIT AND CREDIT TRANSACTIONS; COMPUTER SOFTWARE FOR USE IN SECURING ELECTRONIC TRANSACTIONS; COMPUTER SOFTWARE FOR USE IN INTEGRATING RETAIL GIFT CARD AND REWARD PROGRAMS AT POINT OF SALE; COMPUTER SOFTWARE FOR USE IN CUSTOMIZING POINT OF SALE TERMINALS; COMPUTER SOFTWARE FOR USE IN DEVELOPING DIAL-IN AND WIRELESS COMMUNICATION APPLICATIONS IN CONJUNCTION WITH FINANCIAL CREDIT AND DEBIT CARDS, MAGNETIC CODED CARDS, PERSONAL IDENTIFICATION CARDS, PROMOTIONAL CARDS, AND SMART CARDS; SOFTWARE FOR USE IN ELECTRONIC CASH REGISTERS (U.S. CLS. 21, 23, 26, 36 AND 38).

CLASS 36—INSURANCE AND FINANCIAL

FOR CREDIT AND DEBIT CARD TRANSACTION PROCESSING SERVICES (U.S. CLS. 100, 101 AND 102).

CLASS 37—CONSTRUCTION AND REPAIR

FOR PROVIDING MAINTENANCE SERVICES, NAMELY FOR MACHINERY AND HARDWARE FOR EMBOSSING AND ENCODING FINANCIAL CREDIT AND DEBIT CARDS, MAGNETIC CODED CARDS, PERSONAL IDENTIFICATION CARDS, PROMOTIONAL CARDS AND SMART CARDS; PROVIDING MAINTENANCE SERVICES, NAMELY FOR PRINTERS FOR TRANSPOSING CUSTOM GRAPHICS AND PHOTOGRAPHIC IMAGES ONTO FINANCIAL CREDIT AND DEBIT CARDS, MAGNETIC CODED CARDS, PERSONAL IDENTIFICATION CARDS, PROMOTIONAL CARDS AND SMART CARDS; PROVIDING REPAIR SERVICES, NAMELY FOR EQUIPMENT FOR EMBOSSING AND ENCODING FINANCIAL CREDIT AND DEBIT CARDS, MAGNETIC CODED CARDS, PERSONAL IDENTIFICATION CARDS, PROMOTIONAL CARDS AND SMART CARDS; PROVIDING REPAIR SERVICES, NAMELY FOR POINT OF SALE TERMINALS FOR PROCESSING DEBIT AND CREDIT CARD TRANSACTIONS AND RETAIL GIFT CARD AND REWARD PROGRAMS (U.S. CLS. 100, 103 AND 106).

CLASS 38—COMMUNICATION

FOR TELECOMMUNICATION GATEWAY SERVICES FOR PROCESSING FINANCIAL DEBIT AND CREDIT CARD TRANSACTIONS; ELECTRONIC TRANSMISSION OF DATA AND DOCUMENTS (U.S. CLS. 100, 101 AND 104).

CLASS 40—MATERIAL TREATMENT

FOR CARD PRINTING, NAMELY TRANSPOSING CUSTOM GRAPHICS AND PHOTOGRAPHIC IMAGES ONTO FINANCIAL CREDIT AND DEBIT CARDS, MAGNETIC CODED CARDS, PERSONAL IDENTIFICATION CARDS, PROMOTIONAL CARDS AND SMART CARDS; CARD CUSTOMIZATION, NAMELY EMBOSSING AND ENCODING FINANCIAL CREDIT AND DEBIT CARDS, MAGNETIC CODED CARDS, PERSONAL IDENTIFICATION CARDS, PROMOTIONAL CARDS AND SMART CARDS (U.S. CLS. 100, 103 AND 106).

CLASS 42—SCIENTIFIC AND COMPUTER SERVICES

FOR COMPUTER SOFTWARE DESIGN, NAMELY, OF COMPUTER SOFTWARE FOR USE IN PRINTING CUSTOM GRAPHICS AND PHOTOGRAPHIC IMAGES ONTO FINANCIAL CREDIT AND DEBIT CARDS, MAGNETIC CODED CARDS, PERSONAL IDENTIFICATION CARDS, PROMOTIONAL CARDS AND SMART CARDS; COMPUTER SOFTWARE DESIGN, NAMELY, OF COMPUTER SOFTWARE FOR USE IN DEVELOPING CUSTOMIZED TELECOMMUNICATION GATEWAYS; COMPUTER SOFTWARE DESIGN, NAMELY, OF COMPUTER SOFTWARE FOR USE IN DEBIT AND CREDIT TRANSACTIONS; COMPUTER SOFTWARE DESIGN, NAMELY, OF COMPUTER SOFTWARE FOR USE IN SECURING ELECTRONIC TRANSACTIONS; COMPUTER SOFTWARE DESIGN, NAMELY, OF COMPUTER SOFTWARE FOR USE IN INTEGRATING RETAIL GIFT CARD AND REWARD PROGRAMS AT POINT OF SALE; COMPUTER SOFTWARE DESIGN, NAMELY, OF COMPUTER SOFTWARE FOR USE IN CUSTOMIZING POINT OF SALE TERMINALS; COMPUTER SOFTWARE DESIGN, NAMELY, OF COMPUTER SOFTWARE FOR USE IN CUSTOMIZING FINANCIAL CREDIT AND DEBIT CARDS, MAGNETIC CODED CARDS, PERSONAL IDENTIFICATION CARDS, PROMOTIONAL CARDS AND SMART CARDS (U.S. CLS. 100 AND 101).

DOMINICK J. SALEMI, EXAMINING ATTORNEY

SN 78-469,664. ESSENTIS LIMITED, WATFORD, UNITED KINGDOM, FILED 8-18-2004.

ESSENTIS

THE MARK CONSISTS OF STANDARD CHARACTERS WITHOUT CLAIM TO ANY PARTICULAR FONT, STYLE, SIZE, OR COLOR.

CLASS 9—ELECTRICAL AND SCIENTIFIC APPARATUS

FOR COMPUTER FIRMWARE AND SOFTWARE, NAMELY, COMPUTER FIRMWARE AND SOFTWARE FOR USE IN ISSUING AND PROCESSING CREDIT, DEBIT AND SMART CARD PAYMENT; ELECTRICAL AND ELECTRONIC APPARATUS AND INSTRUMENTS FOR THE TRANSMISSION, RECEPTION, ANALYSIS, MONITORING, PROCESSING, INPUT, OUTPUT, STORAGE, RETRIEVAL, DISPLAY AND PRINTOUT OF SOUNDS, IMAGES AND DATA, NAMELY, RADIO TRANSMITTERS, SATELLITES, ANTENNAS, ELECTRIC CURRENT CONTROLLERS AND TRANSFORMERS, ELECTRIC CABLES, WIRES, PLUGS, ASSEMBLY CONNECTORS, ELECTRICAL CONNECTIONS FOR DATA PROCESSING; DATA PROCESSING APPARATUS AND INSTRUMENTS, NAMELY, COMPUTER HARDWARE, TELECOMMUNICATIONS APPARATUS AND INSTRUMENTS, NAMELY, TELEPHONES, FACSIMILE MACHINES; COMPONENTS PARTS THEREFOR FOR ALL THE AFORESAID GOODS; NONE OF THE FOREGOING RELATING TO INDUSTRIES CONCERNED WITH THE PRODUCTION, DISTRIBUTION AND/OR SALE OF CONSUMER PRODUCTS INCLUDING SOFTGOODS, APPAREL, FOOTWEAR, FASHION, FASHION ACCESSORIES, LEATHER GOODS, JEWELRY, TOILETRIES, MAKE-UP, HOME FURNISHINGS, DRY GOODS, FOODSTUFFS AND HARDWARE, SAVE IN RESPECT OF GOODS RELATING TO PAYMENT CARD SYSTEMS (U.S. CLS. 21, 23, 26, 36 AND 38).

CLASS 35—ADVERTISING AND BUSINESS

FOR DATA PROCESSING; BUSINESS APPRAISALS; BUSINESS MANAGEMENT CONSULTING; BUSINESS ORGANIZATION CONSULTING; BUSINESS RESEARCH; COMPUTERIZED DATABASE MANAGEMENT SERVICES; NONE OF THE FOREGOING RELATING TO INDUSTRIES CONCERNED WITH THE PRODUCTION, DISTRIBUTION AND/OR SALE OF CONSUMER PRODUCTS INCLUDING SOFTGOODS, APPAREL, FOOTWEAR, FASHION, FASHION ACCESSORIES, LEATHER GOODS, JEWELRY, TOILETRIES, MAKE-UP, HOME FURNISHINGS, DRY GOODS, FOODSTUFFS AND HARDWARE, SAVE IN RESPECT OF SERVICES RELATING TO PAYMENT CARD SYSTEMS; RENTAL OF DATA PROCESSING EQUIPMENT (U.S. CLS. 100, 101 AND 102).

CLASS 37—CONSTRUCTION AND REPAIR

FOR INSTALLATION, REPAIR AND MAINTENANCE OF COMPUTER HARDWARE, DATA PROCESSING APPARATUS AND INSTRUMENTS AND TELECOMMUNICATION APPARATUS AND INSTRUMENTS; NONE OF THE FOREGOING RELATING TO INDUSTRIES CONCERNED WITH THE PRODUCTION, DISTRIBUTION AND/OR SALE OF CONSUMER PRODUCTS INCLUDING SOFTGOODS, APPAREL, FOOTWEAR, FASHION, FASHION ACCESSORIES, LEATHER GOODS, JEWELRY, TOILETRIES, MAKE-UP, HOME FURNISHINGS, DRY GOODS, FOODSTUFFS AND HARDWARE, SAVE IN RESPECT OF SERVICES RELATING TO PAYMENT CARD SYSTEMS (U.S. CLS. 100, 103 AND 106).

CLASS 38—COMMUNICATION

FOR TELECOMMUNICATION CONSULTATION SERVICES, NAMELY, CONSULTING SERVICES IN THE FIELD OF SELECTION, IMPLEMENTATION AND USE OF TELECOMMUNICATIONS EQUIPMENT FOR VOICE, DATA AND VIDEO TRANSMISSIONS (U.S. CLS. 100, 101 AND 104).

CLASS 42—SCIENTIFIC AND COMPUTER SERVICES

FOR DESIGN OF TELECOMMUNICATIONS EQUIPMENT; MAINTAINING AND UPDATING COMPUTER FIRMWARE AND SOFTWARE FOR OTHERS; COMPUTER PROGRAMMING FOR OTHERS; DESIGN FOR OTHERS OF COMPUTER SOFTWARE, HARDWARE, FIRMWARE AND DATA PROCESSING EQUIPMENT; TECHNICAL CONSULTATION AND RESEARCH IN THE FIELD OF COMPUTER SOFTWARE, FIRMWARE, HARDWARE AND DATA PROCESSING EQUIPMENT; TECHNICAL RESEARCH IN THE FIELD OF TELECOMMUNICATIONS APPARATUS AND INSTRUMENTS; INSTALLATION AND MAINTENANCE OF COMPUTER SOFTWARE AND FIRMWARE; RENTAL OF COMPUTER HARDWARE, SOFTWARE, FIRMWARE AND DATA PROCESSING EQUIPMENT; NONE OF THE FOREGOING RELATING TO INDUSTRIES CONCERNED WITH THE PRODUCTION, DISTRIBUTION AND/OR SALE OF CONSUMER PRODUCTS INCLUDING SOFTGOODS, APPAREL, FOOTWEAR, FASHION, FASHION ACCESSORIES, LEATHER GOODS, JEWELRY, TOILETRIES, MAKE-UP, HOME FURNISHINGS, DRY GOODS, FOODSTUFFS AND HARDWARE, SAVE IN RESPECT OF SERVICES RELATING TO PAYMENT CARD SYSTEMS (U.S. CLS. 100 AND 101).
MICHELE SWAIN, EXAMINING ATTORNEY

CLASS 9—ELECTRICAL AND SCIENTIFIC APPARATUS

FOR DOWNLOADABLE ELECTRONIC PUBLICATIONS, NAMELY, MAGAZINES, NEWSLETTERS, REPORTS, BULLETINS AND MULTI-MEDIA COMMUNIQUE RELATING TO THE FIELD OF INFORMATION TECHNOLOGY IN HIGHER EDUCATION (U.S. CLS. 21, 23, 26, 36 AND 38).

CLASS 16—PAPER GOODS AND PRINTED MATTER

FOR PRINTED PUBLICATIONS, NAMELY, MAGAZINES, NEWSLETTERS, REPORTS, BULLETINS AND TRADE JOURNALS IN THE FIELD OF INFORMATION TECHNOLOGY IN HIGHER EDUCATION (U.S. CLS. 2, 5, 22, 23, 29, 37, 38 AND 50).

CLASS 35—ADVERTISING AND BUSINESS

FOR ORGANIZING AND CONDUCTING BUSINESS EXPOSITIONS AND CONFERENCES IN THE FIELD OF INFORMATION TECHNOLOGY IN HIGHER EDUCATION; MAILING LIST RENTAL SERVICES FOR OTHERS (U.S. CLS. 100, 101 AND 102).

CLASS 42—SCIENTIFIC AND COMPUTER SERVICES

FOR COMPUTER SERVICES, NAMELY, PROVIDING A WEBSITE CONTAINING INFORMATION IN THE FIELD OF INFORMATION TECHNOLOGY USED IN HIGHER EDUCATION (U.S. CLS. 100 AND 101).
ROBERT C. CLARK JR., EXAMINING ATTORNEY

SN 78-500,049. LIDESTRI FOODS, INC., FAIRPORT, NY. FILED 10-14-2004.

SANTA FE PACKING CO.

SN 78-481,956. 101COMMUNICATIONS LLC, CHATSWORTH, CA. FILED 9-10-2004.

CAMPUS TECHNOLOGY

THE MARK CONSISTS OF STANDARD CHARACTERS WITHOUT CLAIM TO ANY PARTICULAR FONT, STYLE, SIZE, OR COLOR.
NO CLAIM IS MADE TO THE EXCLUSIVE RIGHT TO USE "TECHNOLOGY", APART FROM THE MARK AS SHOWN.

THE MARK CONSISTS OF STANDARD CHARACTERS WITHOUT CLAIM TO ANY PARTICULAR FONT, STYLE, SIZE, OR COLOR.

NO CLAIM IS MADE TO THE EXCLUSIVE RIGHT TO USE "SANTA FE" AND "CO.", APART FROM THE MARK AS SHOWN.

CLASS 29—MEATS AND PROCESSED FOODS

FOR BEAN DIP (U.S. CL. 46).
FIRST USE 1-28-2004; IN COMMERCE 1-28-2004.

CLASS 30—STAPLE FOODS

FOR PREPARED MEXICAN, SOUTHWESTERN AND TEX-MEX-BASED FOODS, NAMELY, SALSA, PIQUANTE SAUCE AND QUESO SAUCE (U.S. CL. 46).
FIRST USE 1-28-2004; IN COMMERCE 1-28-2004.
SALLY SHIH, EXAMINING ATTORNEY

SN 78-508,469, BADIOLI, LUIGINO, LONDON, UNITED KINGDOM, FILED 10-29-2004.

Imatra R.C., Inc.

THE MARK CONSISTS OF STANDARD CHARACTERS WITHOUT CLAIM TO ANY PARTICULAR FONT, STYLE, SIZE, OR COLOR.

PRIORITY CLAIMED UNDER SEC. 44(D) ON ITALY APPLICATION NO. 000044, FILED 5-10-2004, REG. NO. 0000934758, DATED 8-5-2004, EXPIRES 5-10-2014.

NO CLAIM IS MADE TO THE EXCLUSIVE RIGHT TO USE "INC.", APART FROM THE MARK AS SHOWN.

CLASS 3—COSMETICS AND CLEANING PREPARATIONS

FOR LAUNDRY BLEACH; FABRIC SOFTENERS FOR LAUNDRY USE; DETERGENTS FOR LAUNDRY USE; GENERAL PURPOSE CLEANING, POLISHING, SCOURING AND ABRASIVE PREPARATIONS; SOAP; PERFUMERY; ESSENTIAL OILS FOR PERSONAL USE; COSMETICS; HAIR LOTIONS; DENTIFRICES (U.S. CLS. 1, 4, 6, 50, 51 AND 52).

CLASS 9—ELECTRICAL AND SCIENTIFIC APPARATUS

FOR PHOTOGRAPHIC APPARATUS AND INSTRUMENTS, NAMELY, LENSES AND LENS HOODS; CINEMATOGRAPHIC APPARATUS AND INSTRUMENTS, NAMELY, CINEMATOGRAPHIC FILM; OPTICAL APPARATUS AND INSTRUMENTS, NAMELY, CORRECTIVE OPTICAL LENSES, FRAMES FOR EYEGLASSES AND SUNGLASSES, MAGNIFYING GLASSES, INSTRUMENTS CONTAINING EYEPIECES, NAMELY, MICROSCOPES, TELESCOPES, OPTICAL SIGHTS, TELESCOPIC LENS SIGHTS, AND PEEPHOLES FOR DOORS; MEASURING APPARATUS AND INSTRUMENTS, NAMELY, MEASURING GLASSWARE, GRADUATED GLASSWARE; EYE GLASSES AND SUNGLASSES; PINCENEZ; PROTECTIVE EYEPIECES; GOGGLES FOR SPORTS; APPARATUS AND INSTRUMENTS FOR CONDUCTING, SWITCHING, TRANSFORMING, ACCUMULATING, REGULATING OR CONTROLLING ELECTRICITY, NAMELY, CAPACITORS; APPARATUS FOR RECORDING, TRANSMISSION OR REPRODUCTION OF DATA, SOUND, AND IMAGES, NAMELY, VIDEO TELEPHONES, PORTABLE TELEPHONES, PERSONAL AUDIO PLAYERS, ELECTRONIC AGENDAS, JUKEBOXES, VIDEO GAME MACHINES FOR USE WITH TELEVISIONS, ELECTRONIC GAME CONSOLES FOR USE WITH TELEVISIONS, FACSIMILE MACHINES, RADIOS, VEHICLE RADIOS; BLANK MAGNETIC DATA CARRIERS, NAMELY, VIDEO CASSETTES, AUDIO CASSETTES, AND RECORDING DISCS, NAMELY, FLOPPY DISCS, CDS, CD-ROMS AND DVDS; PRERECORDED PHONOGRAPH RECORDS, AUDIO CASSETTES, VIDEOCASSETTES, AND COMPACT DISCS FEATURING AUDIO CONTENT IN THE NATURE OF MUSIC AND INTERVIEWS AND VIDEO CONTENT IN THE FIELD OF SPORTS AND MOTORCYCLE RACING; PRERECORDED COMPACT DISCS FEATURING COMPUTER GAME PROGRAMS AND INTERACTIVE VIDEO GAME PROGRAMS; PRERECORDED VIDEO GAME MEMORY CARTRIDGES; AUTOMATIC VENDING MACHINES; CASH REGISTERS; CALCULATING MACHINES, NAMELY, ACCOUNTING MACHINES, ADDING MACHINES, POCKET CALCULATORS; DATA PROCESSING EQUIPMENT, NAMELY, NOTEBOOK COMPUTERS, LAPTOP COMPUTERS; COMPUTER HARDWARE; COMPUTER SOFTWARE, NAMELY, COMPUTER GAMES AND COMPUTER OPERATING SYSTEMS; VIDEO DISCS AND VIDEO TAPES WITH RECORDED ANIMATED CARTOONS; PROTECTIVE FACEMASKS, PROTECTIVE HELMETS, DIVING HELMETS, DIVING MASKS, DIVING SUITS (U.S. CLS. 21, 23, 26, 36 AND 38).

CLASS 14—JEWELRY

FOR PRECIOUS METALS AND THEIR ALLOYS; GOODS IN PRECIOUS METALS OR COATED THEREWITH, NAMELY, AMULETS, BADGES, JEWELRY BOXES, BELT BUCKLES, BUCKLES FOR WATCH-STRAPS, JEWELRY CASES, JEWELRY CHAINS, WATCH CHAINS, KEY CHAINS, CHARMS, CIGAR AND CIGARETTE HOLDERS, COMMEMORATIVE COINS, NON-MONETARY COINS, CONTAINERS FOR JEWELRY, CONTAINERS FOR SNUFF, MEDALS, ORNAMENTAL PINS, ORNAMENTS, PURSES, STATUETTES, WATCH STRAPS, TIE CLIPS, TIE PINS, CUFF LINKS, TOBACCO JARS, AND TRINKETS, NAMELY, RINGS AND CHARMS; JEWELRY; PRECIOUS STONES; NECKLACES; BRACELETS; RINGS; EARRINGS; ANKLE BRACELETS; PENDANTS; BROOCHES; WRISTWATCHES; POCKET WATCHES; TABLE CLOCKS; PENDULUM CLOCKS; HOROLOGICAL AND CHRONOMETRIC INSTRUMENTS (U.S. CLS. 2, 27, 28 AND 50).

CLASS 18—LEATHER GOODS

FOR LEATHER; IMITATION LEATHER SOLD IN BULK; GOODS MADE OF LEATHER AND IMITATION LEATHER, NAMELY, LEATHER BOXES FOR STORING GREETING CARDS, CASES, LEASHES FOR ANIMALS, SHOULDER STRAPS, THONGS, RIDING SADDLES, AND VANITY CASES SOLD EMPTY; ANIMAL SKINS; TRUNKS; SUITCASES; BAGS, NAMELY, BACKPACKS, BEACH BAGS, HANDBAGS, HAVERSACKS, MESH SHOPPING BAGS, LEATHER POUCHES, PURSES, RUCKSACKS, SACHELS, SCHOOL BAGS, SCHOOL SACHELS, LEATHER SHOPPING BAGS, SLING BAGS FOR CARRYING INFANTS, TOOL BAGS SOLD EMPTY, TRAVELING BAGS, VALISES, AND WHEELED SHOPPING BAGS; WALLET; BRIEFCASES; UMBRELLAS; PARASOLS; WALKING STICKS (U.S. CLS. 1, 2, 3, 22 AND 41).

CLASS 25—CLOTHING

FOR GOODS MADE OF LEATHER AND IMITATION LEATHER, NAMELY, HEADBANDS, ARMBANDS, WRISTBANDS, SASHES AND BELTS; CLOTHING, NAMELY, APRONS, ASCOTS, BABIES' PANTS, BANDANAS AND NECKERCHIEFS, BATHROBES, BATHING DRAWERS, BATHING SUITS, BATHING TRUNKS, BEACHWEAR, BOAS, BODICES, BRASSIERES, BREECHES, CAMISOLES, CAP VISORS, CAPS, CHEMISETTES, GYMNASTICS WEAR, NAMELY, LEOTARDS, TRACK SUITS, SHORTS AND LEGWARMERS, COATS, TOPCOATS, CYCLIST CLOTHING, NAMELY, JERSEYS, SHORTS, PANTS, HATS AND GLOVES, DRAWERS, DRESS SHIELDS, DRESSING GOWNS, FOOT MUFFS, FROCKS, FUR STOLE, FUR COATS, GABARDINES, ANKLE GARTERS, GARTER BELTS, GIRDLES, GLOVES, HOSIERY, JACKETS, JERSEYS, JUMPERS, KNITWEAR, NAMELY, SWEATERS, SCARVES, HATS, GLOVES, PULLOVERS AND DRESSES, BODY LINEN, NAMELY, PANTIES, BRASSIERES AND UNDERWEAR, MITTENS, MONEY BELTS, MUFFS, NECKTIES, OUTERWEAR, NAMELY, COATS, RAINCOATS AND OVERCOATS, OVERALLS, OVERCOATS, PAJAMAS, PANTS, PELERINES, PELISSES, PULLOVERS, SASHES, SCARVES, SHAWLS, SHIRT YOKES, SHIRTS, SHOULDER WRAPS, SINGLETS, SKIRTS, SLIPS, SMOCKS, SOCK SUSPENDERS, SOCKS, SPATS, SPORTS JERSEYS, STOCKINGS, SWEAT-ABSORBENT STOCKINGS, SUITS, SUN VISORS, SWEATERS, SWIMSUITS, TEDDIES, T-SHIRTS, TIGHTS, TROUSERS, UNDERGARMENTS, UNDERPANTS, UNDERWEAR, UNIFORMS, VEILS, VESTS, VISORS, WATERPROOF PANTS, WATERPROOF SHIRTS, WATERPROOF JACKETS, WATERPROOF COATS, RAIN SLICKERS, WIMPLES, AND WRISTBANDS; FOOTWEAR; HEADGEAR, NAMELY, HATS, BERETS, HOODS, SKULL CAPS, TOP HATS, TURBANS, AND HEADBANDS (U.S. CLS. 22 AND 39).

CLASS 28—TOYS AND SPORTING GOODS

FOR PLAYTHINGS, NAMELY, BALLS FOR GAMES, AND PLAY BALLOONS; TOYS, NAMELY, BATH TOYS, INFLATABLE BATH TOYS, DOLLS AND PUPPETS; TOY MODEL VEHICLES; GYMNASTIC APPARATUS; SPORTING ARTICLES, NAMELY, BATTING GLOVES, BOB-SLEIGHS, BODY BOARDS, BODY-BUILDING APPARATUS, NAMELY, EXERCISE WEIGHTS, WEIGHTLIFTING BENCHES, WEIGHTS WORK-OUT BENCHES, BODY-TRAINING APPARATUS, NAMELY, ELLIPTICAL EXERCISE MACHINES, ELECTRONIC SKI SIMULATORS AND ELECTRONIC JOGGING SIMULATORS, CHEST EXPANDERS, COVERINGS FOR SKIS, ELBOW GUARDS, FLIPPERS FOR SWIMMING, WEIGHT LIFTING GLOVES, SPORTS GLOVES, NAMELY, HOCKEY GLOVES, SOFTBALL GLOVES, BASEBALL GLOVES, BOXING GLOVES AND GOLF GLOVES, GOLF CLUBS, GOLF CLUB BAGS, SCUBA EQUIPMENT, NAMELY, SPEARFISHING HARPOON GUNS, HARNESSSES FOR SAILBOARDS, ICE SKATES, IN-LINE ROLLER SKATES, KNEE GUARDS, MASTS FOR SAILBOARDS, RACKETS, ROLLER SKATES, SAILBOARDS, SHIN GUARDS, SKATEBOARDS, SKIS, BOB-SLEIGHS, SLIDES FOR PLAY-GROUNDS, SNOWSHOES, STATIONARY EXERCISE BICYCLES, SURF BOARDS, AND WATER SKIS; DECORATIONS FOR CHRISTMAS TREES; AND PLAYING CARDS (U.S. CLS. 22, 23, 38 AND 50).

CLASS 32—LIGHT BEVERAGES

FOR BEERS; MINERAL WATER; AERATED WATERS; PREPARATIONS FOR MAKING AERATED WATER; NON-ALCOHOLIC DRINKS, NAMELY, FRUIT JUICES, FRUIT DRINKS, NON-ALCOHOLIC BEER, NON-ALCOHOLIC CIDER, NON-ALCOHOLIC COCKTAILS, FRUIT EXTRACTS, FRUIT NECTARS, UNFERMENTED GRAPE MUST, ISOTONIC DRINKS, LEMONADES, LITHIA WATER, ORGEAT, SARSAPARILLA, VEGETABLE JUICES, AND SELTZER; SYRUPS AND WHEY FOR MAKING NON-ALCOHOLIC BEVERAGES; BEER WORT FOR MAKING BEER; MALT WORT FOR MAKING BEER; EXTRACTS OF HOPS FOR MAKING BEER (U.S. CLS. 45, 46 AND 48).

YONG KIM, EXAMINING ATTORNEY

SN 78-567,599. PERFORMANCE BENCHMARKING, INC., GREENSBORO, NC. FILED 2-15-2005.

**CLASS 9—ELECTRICAL AND SCIENTIFIC APPARATUS**

FOR SOFTWARE IN THE FIELD OF JOB ASSESSMENT AND SELECTION, ASSESSMENT, TRAINING, MANAGEMENT AND DEVELOPMENT OF EMPLOYEES AND PROSPECTIVE EMPLOYEES FOR JOBS (U.S. CLS. 21, 23, 26, 36 AND 38).

FIRST USE 4-30-2003; IN COMMERCE 4-30-2003.

CLASS 16—PAPER GOODS AND PRINTED MATTER

FOR REPORTS AND FORMS IN THE FIELDS OF JOB ASSESSMENT AND SELECTION, ASSESSMENT, TRAINING, MANAGEMENT AND DEVELOPMENT OF EMPLOYEES AND PROSPECTIVE EMPLOYEES FOR JOBS (U.S. CLS. 2, 5, 22, 23, 29, 37, 38 AND 50).

FIRST USE 4-30-2003; IN COMMERCE 4-30-2003.

CLASS 35—ADVERTISING AND BUSINESS

FOR PERSONNEL MANAGEMENT CONSULTATION AND PREPARATION OF BUSINESS REPORTS; TESTING TO DETERMINE EMPLOYMENT SKILLS AND JOB COMPETENCY; TESTING TO DETERMINE NEEDS OF JOBS AND CONSULTING REGARDING NEEDS OF JOBS; ALL IN THE FIELD OF JOB ASSESSMENT AND SELECTION, ASSESSMENT, MANAGEMENT AND DEVELOPMENT OF EMPLOYEES AND PROSPECTIVE EMPLOYEES FOR JOBS, INCLUDING PROVISION OF SUCH SERVICES ON-LINE OR VIA THE INTERNET; CONSULTATION AND RESEARCH IN THE FIELD OF JOB ASSESSMENT AND SELECTION, ASSESSMENT, MANAGEMENT AND DEVELOPMENT OF EMPLOYEES AND PROSPECTIVE EMPLOYEES FOR JOBS; PREPARING, ADMINISTERING AND SCORING TESTS IN THE FIELD OF JOB ASSESSMENT AND SELECTION, ASSESSMENT, MANAGEMENT AND DEVELOPMENT OF EMPLOYEES AND PROSPECTIVE EMPLOYEES FOR JOBS (U.S. CLS. 100, 101 AND 102).

FIRST USE 4-30-2003; IN COMMERCE 4-30-2003.

CLASS 41—EDUCATION AND ENTERTAINMENT

FOR CONSULTATION AND RESEARCH IN THE FIELD OF TRAINING FOR JOB ASSESSMENT AND SELECTION, ASSESSMENT, MANAGEMENT AND DEVELOPMENT OF EMPLOYEES AND PROSPECTIVE EMPLOYEES FOR JOBS (U.S. CLS. 100, 101 AND 107).

FIRST USE 4-30-2003; IN COMMERCE 4-30-2003.

JACQUELINE A. LAVINE, EXAMINING ATTORNEY

SN 78-573,291. CONNAUGHT MOTOR CO. LTD., EYDON, NORTHAMPTON, UNITED KINGDOM, FILED 2-23-2005.



OWNER OF ERPN CMNTY TM OFC REG. NO. 004312559, DATED 4-18-2006, EXPIRES 2-22-2015.

CLASS 12—VEHICLES

FOR LAND VEHICLES, NAMELY, AUTOMOBILES; APPARATUS FOR LOCOMOTION BY LAND, NAMELY, AUTOMOBILES; MOTOR LAND VEHICLES, NAMELY, AUTOMOBILES AND STRUCTURAL PARTS THEREFOR AND FITTINGS FOR AUTOMOBILES, NAMELY, SEATS, TIRES, CHASSIS, AXLES, TORSION BARS, BRAKES, FRAMES, MUD GUARDS, DIRECTION SIGNALS, DRIVING MOTORS, ENGINES, GEARS, HEADRESTS FOR SEATS, MOTORS, SHOCK ABSORBERS, SHOCK ABSORBING SPRINGS, SUSPENSION SPRINGS, TRANSMISSIONS, WINDSCREEN WIPERS, ANTI-THEFT ALARMS, BRAKE LININGS, BUMPERS, CLUTCHES, HORNS AND WHEELS (U.S. CLS. 19, 21, 23, 31, 35 AND 44).

CLASS 14—JEWELRY

FOR PRECIOUS METALS AND THEIR ALLOYS; GOODS IN PRECIOUS METALS OR COATED THEREWITH, NAMELY, ASHTRAYS, BADGES, BELT BUCKLES, BRACELETS, CIGAR BOXES, CIGARETTE CASES, CIGARETTE LIGHTERS, STATUARY CUPS, DECORATIVE BOXES, FIGURINES, HAT PINS, INSIGNIAS, JEWELRY BOXES, TROPHIES, PURSES, SCULPTURES, SERVING PLATTERS AND STATUES; JEWELRY, PRECIOUS STONES; HOROLOGICAL AND CHRONOMETRIC INSTRUMENTS; WATCHES, STOP-WATCHES; CLOCKS; SERVING TRAYS OF PRECIOUS METAL, TANKARDS OF PRECIOUS METAL, JUGS OF PRECIOUS METAL; ASHTRAYS OF PRECIOUS METAL; KEY RINGS OF PRECIOUS METAL; MEDALS; NECKLACES; ORNAMENTS OF PRECIOUS METAL; TIE PINS; STATUES OF PRECIOUS METAL; DECORATIVE ARTWORKS OF PRECIOUS METAL (U.S. CLS. 2, 27, 28 AND 50).

CLASS 16—PAPER GOODS AND PRINTED MATTER

FOR PAPER; CARDBOARD; PRINTED MATTER, NAMELY PRINTED FORMS, PRINTED AWARD CERTIFICATES, PRINTED CALENDARS, PRINTED CHARTS, PRINTED EMBLEMS, PRINTED HOLOGRAMS, PRINTED INVITATIONS; BOOKBINDING MATERIAL, NAMELY BOOKBINDINGS, BOOKBINDING WIRE, BOOKBINDING TAPE; PHOTOGRAPHS; STATIONERY; ADHESIVES FOR STATIONERY OR HOUSEHOLD PURPOSES; ARTISTS' MATERIALS, NAMELY PENS, CRAYONS, PENCILS, DRAWING PAPER, PAINTING PALETTES, EASELS; PAINT BRUSHES; TYPEWRITERS; NON-FURNITURE OFFICE REQUISITES, NAMELY RUBBER BANDS, STAPLERS, PAPER FOLDING MACHINES, PAPER HOLE PUNCHES, DESK SETS, DESK BASKETS FOR DESK ACCESSORIES, HOLDERS FOR PENS, PENCILS AND INK; PRINTED INSTRUCTIONAL AND TEACHING MATERIAL IN THE FIELD OF TRANSPORTATION; PLASTIC MATERIALS FOR PACKAGING, NAMELY PLASTIC BUBBLE PACKS, PLASTIC BAGS; PRINTERS' TYPE; PRINTING BLOCKS; PRINTED PUBLICATIONS, NAMELY INFORMATION GUIDES IN THE FIELD OF TRANSPORTATION; BOOKS IN THE FIELD OF TRANSPORTATION; MANUALS IN THE FIELD OF TRANSPORTATION; PAMPHLETS IN THE FIELD OF TRANSPORTATION; NEWSLETTERS IN THE FIELD OF TRANSPORTATION; BROCHURES IN THE FIELD OF TRANSPORTATION; PHOTOGRAPH ALBUMS; NEWSPAPERS; MAGAZINES IN THE FIELD OF TRANSPORTATION; PERIODICALS IN THE FIELD OF TRANSPORTATION; PRINTED TICKETS, VOUCHERS AND COUPONS; TRAVEL DOCUMENTS, NAMELY PRINTED TICKETS; PERSONAL IDENTIFICATION CARDS; PAPER LABELS; PAPER TAGS; POSTERS; POSTCARDS; WRITING INSTRUMENTS; WRAPPING PAPER; CALENDARS; DIARIES; GIFT CARDS; GREETINGS CARDS; PRINTED VISUALS IN THE NATURE OF PROMOTIONAL AND ADVERTISING MATERIAL; PRINTED SIGNS OF PAPER OR CARDBOARD (U.S. CLS. 2, 5, 22, 23, 29, 37, 38 AND 50).

CLASS 18—LEATHER GOODS

FOR LEATHER AND IMITATIONS OF LEATHER; BAGS FOR SPORTS, TOOL BAGS SOLD EMPTY, CARRY ALL BAGS, LEATHER SHOPPING BAGS; SHOPPING BAGS OF IMITATION LEATHER; TEXTILE SHOPPING BAGS; SCHOOL BAGS, OVERNIGHT BAGS, TRAVEL BAGS, SHOULDER BAGS, SUITCASES AND WALLETS, ALL MADE OF LEATHER AND IMITATIONS OF LEATHER; TRUNKS AND TRAVELING BAGS; UMBRELLAS, PARASOLS AND WALKING STICKS; WHIPS, HARNESSES AND SADDLERY; ALL PURPOSE SPORT BAGS, ALL PURPOSE CARRYING BAGS, BAGS FOR SPORTS CLOTHING, BEACH BAGS, CLUTCH BAGS, GARMENT BAGS FOR TRAVEL, HIKING BAGS, KEY BAGS, SHOULDER BAGS, SUIT BAGS, TRAVEL BAGS; LUGGAGE; KEY CASES; WALLETS; PURSES; SCHOOL BAGS; SUITCASES; RUCKSACKS; HANDBAGS (U.S. CLS. 1, 2, 3, 22 AND 41).

CLASS 25—CLOTHING

FOR CLOTHING FOR MEN, WOMEN, CHILDREN AND BABIES, NAMELY UNDERWEAR, LINGERIE, SOCKS, HOSIERY; OUTERWEAR, NAMELY SHORTS, TOPS, BOTTOMS, SHIRTS, BLOUSES, T-SHIRTS; POLO SHIRTS, TUNICS, SWEATERS, TROUSERS, SKIRTS; NIGHTWEAR, BATH ROBES AND DRESSING GOWNS; SPORTSWEAR, NAMELY SHORTS, SHIRTS, SOCKS, CAPS AND SHOES ADAPTED FOR SPORTING PURPOSES, SWIMWEAR; FORMAL WEAR AND EVENINGWEAR, NAMELY DRESSES, CUMMERBUNDS, TIES, TUXEDOS, TUXEDO BELTS, TROUSERS, SHIRTS, BLOUSES, SHORTS AND COATS; SUITS, WORK WEAR, NAMELY BIB AND BRACE OVERALLS, UNIFORMS, CLOAKS, ANORAKS FOR MEN, WOMEN AND CHILDREN; FOOTWEAR; HEADGEAR, NAMELY CAPS AND HATS (U.S. CLS. 22 AND 39).

CLASS 37—CONSTRUCTION AND REPAIR

FOR REPAIR AND SERVICING OF MOTOR LAND VEHICLES; INSTALLATION OF ENGINES, BRAKES AND SEATS, IN MOTOR LAND VEHICLES (U.S. CLS. 100, 103 AND 106).

YONG KIM, EXAMINING ATTORNEY

SN 78-573,334. CONNAUGHT MOTOR CO. LTD., EYDON, NORTHAMPTON, UNITED KINGDOM, FILED 2-23-2005.

CONNAUGHT

PRIORITY CLAIMED UNDER SEC. 44(D) ON UNITED KINGDOM APPLICATION NO. 2371341, FILED 8-23-2004, REG. NO. 004312542, DATED 5-30-2006, EXPIRES 2-22-2015.

CLASS 12—VEHICLES

FOR LAND VEHICLES, NAMELY, AUTOMOBILES; APPARATUS FOR LOCOMOTION BY LAND, NAMELY, AUTOMOBILES; MOTOR LAND VEHICLES, NAMELY, AUTOMOBILES AND STRUCTURAL PARTS THEREFOR AND FITTINGS FOR AUTOMOBILES, NAMELY, SEATS, TIRES, CHASSIS, AXLES, TORSION BARS, BRAKES, FRAMES, MUD GUARDS, DIRECTION SIGNALS, DRIVING MOTORS, ENGINES, GEARS, HEADRESTS FOR SEATS, MOTORS, SHOCK ABSORBERS, SHOCK ABSORBING SPRINGS, SUSPENSION SPRINGS, TRANSMISSIONS, WINDSCREEN WIPERS, ANTI-THEFT ALARMS, BRAKE LININGS, BUMPERS, CLUTCHES, HORNS AND WHEELS (U.S. CLS. 19, 21, 23, 31, 35 AND 44).

CLASS 14—JEWELRY

FOR PRECIOUS METALS AND THEIR ALLOYS; GOODS IN PRECIOUS METALS OR COATED THEREWITH, NAMELY, ASHTRAYS, BADGES, BELT BUCKLES, BRACELETS, CIGAR BOXES, CIGARETTE CASES, CIGARETTE LIGHTERS, STATUARY CUPS, DECORATIVE BOXES, FIGURINES, HAT PINS, INSIGNIAS, JEWELRY BOXES, TROPHIES, PURSES, SCULPTURES, SERVING PLATTERS AND STATUES; JEWELRY, PRECIOUS STONES; HOROLOGICAL AND CHRONOMETRIC INSTRUMENTS; WATCHES, STOP-WATCHES; CLOCKS; SERVING TRAYS OF PRECIOUS METAL, TANKARDS OF PRECIOUS METAL, JUGS OF PRECIOUS METAL; ASHTRAYS OF PRECIOUS METAL; KEY RINGS OF PRECIOUS METAL; MEDALS; NECKLACES; ORNAMENTS OF PRECIOUS METAL; TIE PINS; STATUES OF PRECIOUS METAL; DECORATIVE ARTWORKS OF PRECIOUS METAL (U.S. CLS. 2, 27, 28 AND 50).

CLASS 16—PAPER GOODS AND PRINTED MATTER

FOR PAPER; CARDBOARD; PRINTED MATTER, NAMELY PRINTED FORMS, PRINTED AWARD CERTIFICATES, PRINTED CALENDARS, PRINTED CHARTS, PRINTED EMBLEMS, PRINTED HOLOGRAMS, PRINTED INVITATIONS; BOOKBINDING MATERIAL, NAMELY BOOKBINDINGS, BOOKBINDING WIRE, BOOKBINDING TAPE; PHOTOGRAPHS; STATIONERY; ADHESIVES FOR STATIONERY OR HOUSEHOLD PURPOSES; ARTISTS' MATERIALS, NAMELY PENS, CRAYONS, PENCILS, DRAWING PAPER, PAINTING PALETTES, EASELS; PAINT BRUSHES; TYPEWRITERS; NON-FURNITURE OFFICE REQUISITES, NAMELY RUBBER BANDS, STAPLERS, PAPER FOLDING MACHINES, PAPER HOLE PUNCHES, DESK SETS, DESK BASKETS FOR DESK ACCESSORIES, HOLDERS FOR PENS, PENCILS AND INK; PRINTED INSTRUCTIONAL AND TEACHING MATERIAL IN THE FIELD OF TRANSPORTATION; PLASTIC MATERIALS FOR PACKAGING, NAMELY PLASTIC BUBBLE PACKS, PLASTIC BAGS; PRINTERS' TYPE; PRINTING BLOCKS; PRINTED PUBLICATIONS, NAMELY INFORMATION GUIDES IN THE FIELD OF TRANSPORTATION; BOOKS IN THE FIELD OF TRANSPORTATION; MANUALS IN THE FIELD OF TRANSPORTATION; PAMPHLETS IN THE FIELD OF TRANSPORTATION; NEWSLETTERS IN THE FIELD OF TRANSPORTATION; BROCHURES IN THE FIELD OF TRANSPORTATION; PHOTOGRAPH ALBUMS; NEWSPAPERS; MAGAZINES IN THE FIELD OF TRANSPORTATION; PERIODICALS IN THE FIELD OF TRANSPORTATION; PRINTED TICKETS, VOUCHERS AND COUPONS; TRAVEL DOCUMENTS, NAMELY PRINTED TICKETS; PERSONAL IDENTIFICATION CARDS; PAPER LABELS; PAPER TAGS; POSTERS; POSTCARDS; WRITING INSTRUMENTS; WRAPPING PAPER; CALENDARS; DIARIES; GIFT CARDS; GREETINGS CARDS; PRINTED VISUALS IN THE NATURE OF PROMOTIONAL AND ADVERTISING MATERIAL; PRINTED SIGNS OF PAPER OR CARDBOARD (U.S. CLS. 2, 5, 22, 23, 29, 37, 38 AND 50).

CLASS 18—LEATHER GOODS

FOR LEATHER AND IMITATIONS OF LEATHER; BAGS FOR SPORTS, TOOL BAGS SOLD EMPTY, CARRY ALL BAGS, LEATHER SHOPPING BAGS; SHOPPING BAGS OF IMITATION LEATHER; TEXTILE SHOPPING BAGS; SCHOOL BAGS, OVERNIGHT BAGS, TRAVEL BAGS, SHOULDER BAGS, SUITCASES AND WALLETS, ALL MADE OF LEATHER AND IMITATIONS OF LEATHER; TRUNKS AND TRAVELING BAGS; UMBRELLAS, PARASOLS AND WALKING STICKS; WHIPS, HARNESSES AND SADDLERY; ALL PURPOSE SPORT BAGS, ALL PURPOSE CARRYING BAGS, BAGS FOR SPORTS CLOTHING, BEACH BAGS, CLUTCH BAGS, GARMENT BAGS FOR TRAVEL, HIKING BAGS, KEY BAGS, SHOULDER BAGS, SUIT BAGS, TRAVEL BAGS; LUGGAGE; KEY CASES; WALLETS; PURSES; SCHOOL BAGS; SUITCASES; RUCKSACKS; HANDBAGS (U.S. CLS. 1, 2, 3, 22 AND 41).

CLASS 25—CLOTHING

FOR CLOTHING FOR MEN, WOMEN, CHILDREN AND BABIES, NAMELY UNDERWEAR, LINGERIE, SOCKS, HOSIERY; OUTERWEAR, NAMELY SHORTS, TOPS, BOTTOMS, SHIRTS, BLOUSES, T-SHIRTS, POLO SHIRTS, TUNICS, SWEATERS, TROUSERS, SKIRTS; NIGHTWEAR, BATH ROBES AND DRESSING GOWNS; SPORTSWEAR, NAMELY SHORTS, SHIRTS, SOCKS, CAPS AND SHOES ADAPTED FOR SPORTING PURPOSES, SWIMWEAR; FORMAL WEAR AND EVENINGWEAR, NAMELY DRESSES, CUMMERBUNDS, TIES, TUXEDOS, TUXEDO BELTS, TROUSERS, SHIRTS, BLOUSES, SHORTS AND COATS; SUITS, WORK WEAR, NAMELY BIB AND BRACE OVERALLS, UNIFORMS, CLOAKS, ANORAKS FOR MEN, WOMEN AND CHILDREN; FOOTWEAR; HEADGEAR, NAMELY CAPS AND HATS (U.S. CLS. 22 AND 39).

CLASS 37—CONSTRUCTION AND REPAIR

FOR REPAIR AND SERVICING OF MOTOR LAND VEHICLES; INSTALLATION OF ENGINES, BRAKES AND SEATS, IN MOTOR LAND VEHICLES (U.S. CLS. 100, 103 AND 106).

YONG KIM, EXAMINING ATTORNEY

SN 78-573,758. VEER CORPORATION, CALGARY, CANADA, FILED 2-23-2005.



PRIORITY CLAIMED UNDER SEC. 44(D) ON CANADA APPLICATION NO. 1246320, FILED 2-7-2005, REG. NO. TMA676140, DATED 11-2-2006, EXPIRES 11-2-2021.

CLASS 9—ELECTRICAL AND SCIENTIFIC APPARATUS

FOR DVDS, CDS AND DOWNLOADABLE ELECTRONIC FILES FEATURING VISUAL MEDIA, NAMELY, STOCK PHOTOGRAPHS, ARCHIVAL PHOTOGRAPHS, REPRODUCTIONS OF WORKS OF ART, ILLUSTRATIONS AND GRAPHIC DESIGNS (U.S. CLS. 21, 23, 26, 36 AND 38).

CLASS 41—EDUCATION AND ENTERTAINMENT

FOR PUBLICATIONS OF BOOKS IN THE FIELD OF PHOTOGRAPHY, ART, GRAPHIC DESIGN; DIGITAL PUBLISHING OF BOOKS IN THE FIELD OF PHOTOGRAPHY, ART, GRAPHIC DESIGN AND DIGITAL PUBLISHING; PROVIDING AN INTERACTIVE COMPUTER DATABASE FEATURING STOCK PHOTOGRAPHS, ARCHIVAL PHOTOGRAPHS, ART IMAGES, ILLUSTRATIONS AND GRAPHIC ART DESIGNS (U.S. CLS. 100, 101 AND 107).

GINA HAYES, EXAMINING ATTORNEY

SN 78-598,307. ROYAL PET INCORPORATED, EAGAN, MN, FILED 3-30-2005.



NO CLAIM IS MADE TO THE EXCLUSIVE RIGHT TO USE "ESSENTIALS", APART FROM THE MARK AS SHOWN.

CLASS 3—COSMETICS AND CLEANING PREPARATIONS

FOR NON-MEDICATED GROOMING PREPARATIONS FOR PETS, NAMELY, SHAMPOO, CONDITIONER, SCALP AND DANDER CONDITIONER, HAIR DETANGLER, COLOGNE, BODY SPRITZER, LOTION, FUR POLISH, NAIL POLISH, BREATH FRESHENER TABLETS, DISPOSABLE WIPES IMPREGNATED WITH CLEANSING COMPOUNDS FOR PET HYGIENE (U.S. CLS. 1, 4, 6, 50, 51 AND 52).

CLASS 4—LUBRICANTS AND FUELS

FOR CANDLES (U.S. CLS. 1, 6 AND 15).

CLASS 5—PHARMACEUTICALS

FOR MEDICATED SKIN CARE PREPARATIONS FOR PETS, NAMELY, HEALING GEL AND ANALGESIC BALM; MEDICATED BREATH TABLETS, SUPPLEMENTS AND VITAMINS FOR PETS (U.S. CLS. 6, 18, 44, 46, 51 AND 52).

CLASS 24—FABRICS

FOR WASHING GLOVES (U.S. CLS. 42 AND 50).

CLASS 28—TOYS AND SPORTING GOODS

FOR PET TOYS (U.S. CLS. 22, 23, 38 AND 50).

CLASS 31—NATURAL AGRICULTURAL PRODUCTS

FOR PET TREATS (U.S. CLS. 1 AND 46).
GINA HAYES, EXAMINING ATTORNEY

SN 78-608,957. FOODCAP INTERNATIONAL LIMITED, PARNELL, AUCKLAND, NEW ZEALAND, FILED 4-14-2005.



PRIORITY CLAIMED UNDER SEC. 44(D) ON NEW ZEALAND APPLICATION NO. 719978, FILED 10-15-2004, REG. NO. 719978, DATED 10-15-2004, EXPIRES 10-15-2011.

CLASS 7—MACHINERY

FOR MACHINES FOR HANDLING, PROCESSING, TREATING, STORING AND TRANSPORTING PRODUCTS INCLUDING PERISHABLE PRODUCTS, FOOD PRODUCTS, BEVERAGES AND BEVERAGE PRODUCTS, INGREDIENTS FOR PERISHABLE PRODUCTS, FOOD PRODUCTS; MACHINES FOR STORAGE, TREATMENT, PREPARATION AND PRESENTATION OF PERISHABLE MATERIALS, NAMELY, FOOD AND BEVERAGES (U.S. CLS. 13, 19, 21, 23, 31, 34 AND 35).

CLASS 29—MEATS AND PROCESSED FOODS

FOR FRESH MEAT, FISH, POULTRY AND GAME; DRIED, CANNED, PRESERVED, PROCESSED AND/OR COOKED MEAT, FISH, POULTRY AND GAME; EGGS; EDIBLE OILS AND FATS; MILK AND MILK PRODUCTS, NAMELY, YOGURT, CHEESE, CREAM; PICKLES AND FRUIT PRESERVES; PREPARED FOODSTUFFS, NAMELY, PROCESSED FOODS CONSISTING PRIMARILY OF MEAT, FISH, POULTRY OR GAME OR EXTRACTS THEREOF (U.S. CL. 46).

CLASS 30—STAPLE FOODS

FOR PROCESSED GRAIN; FARINACEOUS FOOD AND FOOD PRODUCTS FOR HUMAN CONSUMPTION; BREAD; FLAVORING INGREDIENTS, NAMELY, SAUCES, SALT, MUSTARD AND VINEGAR (U.S. CL. 46).

CLASS 31—NATURAL AGRICULTURAL PRODUCTS

FOR FRESH FRUIT, VEGETABLES, RAW, FRESH AND UNPROCESSED GRAINS AND NUTS; FOODSTUFFS FOR ANIMALS (U.S. CLS. 1 AND 46).

CLASS 35—ADVERTISING AND BUSINESS

FOR WHOLESALE STORE FEATURING FOOD AND BEVERAGES, MACHINERY FOR STORAGE, TREATMENT, PREPARATION AND PRESENTATION OF PERISHABLE MATERIALS, NAMELY, FOOD AND BEVERAGES AND PARTS AND FITTINGS FOR THE FOREGOING; RETAIL STORE SERVICES FEATURING FOOD AND BEVERAGES, MACHINERY FOR STORAGE, TREATMENT, PREPARATION AND PRESENTATION OF PERISHABLE MATERIALS, NAMELY, FOOD AND BEVERAGES, PARTS AND FITTINGS FOR THE FOREGOING; ONLINE RETAIL STORE SERVICES FEATURING FOOD AND BEVERAGES, MACHINERY FOR STORAGE, TREATMENT, PREPARATION AND PRESENTATION OF PERISHABLE MATERIALS, NAMELY, FOOD AND BEVERAGES, PARTS AND FITTINGS FOR THE FOREGOING; BUSINESS ADVISORY CONSULTANCY, MANAGEMENT, ADMINISTRATION AND INFORMATION SERVICES; FRANCHISING, NAMELY, CONSULTATION AND ASSISTANCE IN BUSINESS MANAGEMENT, ORGANIZATION AND PROMOTION; LICENSING OF FOOD AND BEVERAGE PROCESSING KNOW HOW AND MACHINERY; CONDUCTING AN ONLINE TRADE SHOW EXHIBITION IN THE FIELD OF MACHINERY FOR STORAGE, TREATMENT, PREPARATION AND PRESENTATION OF PERISHABLE MATERIALS, NAMELY, FOOD AND BEVERAGES; PROVIDING AN ONLINE COMPUTER DATABASE FEATURING TRADE INFORMATION IN THE FIELD OF MACHINERY FOR STORAGE, TREATMENT, PREPARATION AND PRESENTATION OF PERISHABLE MATERIALS, NAMELY, FOOD AND BEVERAGES; ADVERTISING AGENCY; PUBLICITY AND SALES PROMOTION SERVICES; PRODUCT DEMONSTRATION (U.S. CLS. 100, 101 AND 102).

CLASS 37—CONSTRUCTION AND REPAIR

FOR CONSTRUCTION, REPAIR, MAINTENANCE AND INSTALLATION OF MACHINERY FOR STORAGE, TREATMENT, PREPARATION AND PRESENTATION OF PERISHABLE MATERIALS, FOOD AND BEVERAGE PRODUCTS; ADVISORY AND CONSULTANCY SERVICES IN THE FIELD OF CONSTRUCTION, REPAIR, MAINTENANCE AND INSTALLATION OF THE FOREGOING MACHINERY (U.S. CLS. 100, 103 AND 106).

CLASS 40—MATERIAL TREATMENT

FOR FOOD PROCESSING SERVICES; ADVISORY AND CONSULTANCY IN THE FIELD OF FOOD PROCESSING (U.S. CLS. 100, 103 AND 106).

CLASS 42—SCIENTIFIC AND COMPUTER SERVICES

FOR RESEARCH IN THE FIELD OF FOOD PROCESSING, SURVEYING AND ENGINEERING SERVICES, LICENSING OF INTELLECTUAL PROPERTY AND/OR TECHNOLOGY IN THE AREAS OF MATERIALS HANDLING, TREATMENT, PRESERVATION AND TRANSPORTATION OF PERISHABLE PRODUCTS; TESTING, INSPECTION AND RESEARCH ON AGRICULTURE, LIVESTOCK BREEDING OR FISHERIES; DESIGN FOR OTHERS IN THE FIELD OF FOOD PROCESSING (U.S. CLS. 100 AND 101).

JOANNA DUKOVIC, EXAMINING ATTORNEY

SN 78-619,081. KEEPER, LLC, AUSTIN, TX. FILED 4-28-2005.

Keeper

THE MARK CONSISTS OF STANDARD CHARACTERS WITHOUT CLAIM TO ANY PARTICULAR FONT, STYLE, SIZE, OR COLOR.

CLASS 42—SCIENTIFIC AND COMPUTER SERVICES

FOR PROVIDING TEMPORARY USE OF NON-DOWNLOADABLE SOFTWARE FOR COLLECTING, ORGANIZING, AND EDITING RECIPES, GENERATING GROCERY LISTS, DINNER PARTY PLANNING CHECKLIST, COMPLETE MENUS, PLACE CARD AND MENU TEMPLATES (U.S. CLS. 100 AND 101).

CLASS 43—HOTEL AND RESTAURANT SERVICES

FOR PROVIDING AN INTERACTIVE COMPUTER DATABASE IN THE FIELDS OF FOOD PREPARATION AND RESTAURANT SERVICES RELATED TO COOKING, WINE, BEVERAGES, BAKING, RECIPES, KITCHENWARE, WINE CHARACTERISTICS, UNIQUE COOKING EQUIPMENT AND ACCESSORIES AND PROVIDING INFORMATION IN THE FIELD OF FOOD PREPARATION, FOOD AND WINE PAIRING, COOKING, AND BAKING VIA A GLOBAL COMPUTER NETWORK (U.S. CLS. 100 AND 101).

BRIDGETT SMITH, EXAMINING ATTORNEY

SN 78-634,111. TORQUE SOLUTIONS LLC, SAN JUAN CAPISTRANO, CA. FILED 5-20-2005.

DNA Torque

THE MARK CONSISTS OF STANDARD CHARACTERS WITHOUT CLAIM TO ANY PARTICULAR FONT, STYLE, SIZE, OR COLOR.

NO CLAIM IS MADE TO THE EXCLUSIVE RIGHT TO USE "DNA", APART FROM THE MARK AS SHOWN.

CLASS 16—PAPER GOODS AND PRINTED MATTER

FOR PRINTED MATTER, NAMELY, PROVIDING WRITTEN PERSONALITY PROFILES, PERSONALITY APPLICATION CARDS, BUSINESS ASSESSMENT SURVEYS, EXECUTIVE ASSESSMENT SURVEYS, WORKBOOK AND OTHER WRITTEN MATERIALS DESIGNED TO ASSIST INDIVIDUALS AND BUSINESSES TO IMPROVE LEADERSHIP AND RELATIONSHIPS (U.S. CLS. 2, 5, 22, 23, 29, 37, 38 AND 50).

CLASS 35—ADVERTISING AND BUSINESS

FOR PROVIDING INFORMATION THROUGH WEB CASTS AND CONFERENCE CALLS VIA A GLOBAL COMPUTER NETWORK IN THE FIELDS OF LEADERSHIP, AND BUSINESS GROWTH AND TRANSFORMATION (U.S. CLS. 100, 101 AND 102).

CLASS 41—EDUCATION AND ENTERTAINMENT

FOR PROVIDING INFORMATION, TRAINING AND COACHING THROUGH SEMINARS, WEB CASTS, CONFERENCE CALLS AND WORKSHOPS VIA A GLOBAL COMPUTER NETWORK IN THE FIELDS OF LEADERSHIP, PERSONAL MASTERY AND BUSINESS GROWTH AND TRANSFORMATION (U.S. CLS. 100, 101 AND 107).

INGA ERVIN, EXAMINING ATTORNEY

SN 78-648,142. THE NEXT PHASE CONSULTANCY, INC., REDMOND, WA. FILED 6-10-2005.

MEDINTELLIGUIDE

THE MARK CONSISTS OF STANDARD CHARACTERS WITHOUT CLAIM TO ANY PARTICULAR FONT, STYLE, SIZE, OR COLOR.

CLASS 9—ELECTRICAL AND SCIENTIFIC APPARATUS

FOR DOWNLOADABLE ELECTRONIC PUBLICATIONS IN THE NATURE OF SERIES OF REFERENCE TABLES, CHARTS AND GUIDES TO INFORMATION ON PRODUCTS, TECHNOLOGIES, COMPANIES, TRENDS AND DEVELOPMENTS IN THE FIELD OF MEDICAL DEVICES, BIOTECHNOLOGY, AND PHARMACEUTICAL (U.S. CLS. 21, 23, 26, 36 AND 38).

CLASS 16—PAPER GOODS AND PRINTED MATTER

FOR PRINTED PUBLICATIONS IN THE NATURE OF SERIES OF REFERENCE TABLES, CHARTS AND GUIDES TO INFORMATION ON PRODUCTS, TECHNOLOGIES, COMPANIES, TRENDS AND DEVELOPMENTS IN THE FIELD OF MEDICAL DEVICES, BIOTECHNOLOGY, AND PHARMACEUTICAL (U.S. CLS. 2, 5, 22, 23, 29, 37, 38 AND 50).

JAMES GRIFFIN, EXAMINING ATTORNEY

SN 78-648,490. LEMON HEAVEN BEVERAGES I NC., DELTA, CANADA, FILED 6-10-2005.



PRIORITY CLAIMED UNDER SEC. 44(D) ON CANADA APPLICATION NO. 1260546, FILED 6-9-2005, REG. NO. TMA691770, DATED 7-10-2007, EXPIRES 7-10-2017.

NO CLAIM IS MADE TO THE EXCLUSIVE RIGHT TO USE "LEMON", APART FROM THE MARK AS SHOWN.

CLASS 35—ADVERTISING AND BUSINESS

FOR RETAIL STORE AND KIOSK SERVICES FEATURING FRUIT DRINKS; FRANCHISING, NAMELY, OFFERING BUSINESS CONSULTATION AND TECHNICAL ASSISTANCE IN THE ESTABLISHMENT AND/OR OPERATION OF RETAIL STORES AND KIOSKS FEATURING FRUIT DRINKS; SUPPORT SERVICES RENDERED BY A FRANCHISOR, NAMELY, ASSISTANCE IN THE OPERATION OR MANAGEMENT OF RETAIL STORES AND KIOSKS FEATURING FRUIT DRINKS (U.S. CLS. 100, 101 AND 102).

CLASS 41—EDUCATION AND ENTERTAINMENT

FOR EDUCATIONAL SERVICES FOR FRANCHISEES, NAMELY, PROVIDING TRAINING IN THE PREPARATION OF FRUIT DRINKS AND OPERATION AND MANAGEMENT OF RETAILS STORES AND KIOSKS FEATURING FRUIT DRINKS (U.S. CLS. 100, 101 AND 107).

MARTHA FROMM, EXAMINING ATTORNEY

SN 78-655,870. DIET FREEDOM LIMITED, MIDDLESEX, UNITED KINGDOM, FILED 6-22-2005.

DIET FREEDOM

THE MARK CONSISTS OF STANDARD CHARACTERS WITHOUT CLAIM TO ANY PARTICULAR FONT, STYLE, SIZE, OR COLOR.

PRIORITY CLAIMED UNDER SEC. 44(D) ON UNITED KINGDOM APPLICATION NO. 2381063, FILED 12-22-2004, REG. NO. 2381063, DATED 11-3-2006, EXPIRES 12-22-2014.

NO CLAIM IS MADE TO THE EXCLUSIVE RIGHT TO USE "DIET", APART FROM THE MARK AS SHOWN.

CLASS 5—PHARMACEUTICALS

FOR DIETETIC FOODS ADAPTED FOR MEDICAL USE; VITAMIN FORTIFIED BEVERAGES, NAMELY, BEVERAGE CONTAINING ADDED VITAMINS AND MINERALS; HEALTH FOOD SUPPLEMENTS; HEALTH FOOD SUPPLEMENTS MADE OF VITAMINS; DIETARY SUPPLEMENTS CONTAINING VITAMINS AND MINERALS; MEAL REPLACEMENT DRINKS; MEAL REPLACEMENT SNACK BARS; VITAMIN FORTIFIED BEVERAGES, NAMELY FRUIT AND VEGETABLE JUICES WITH ADDED VITAMINS; FOOD SUPPLEMENTS FOR HUMAN CONSUMPTION; BEVERAGES ENRICHED WITH ADDED VITAMINS; MEAL REPLACEMENT DRINKS (U.S. CLS. 6, 18, 44, 46, 51 AND 52).

CLASS 16—PAPER GOODS AND PRINTED MATTER

FOR PRINTED MATTER, NAMELY, BOOKS, MAGAZINES AND NEWSLETTERS ABOUT DIET NUTRITION, FOOD AND GENERAL HEALTH AND LIFESTYLE; BOOKS ABOUT DIET, NUTRITION, FOOD AND GENERAL HEALTH AND LIFESTYLE; MAGAZINES ABOUT DIET, NUTRITION, FOOD AND GENERAL HEALTH AND LIFESTYLE; BLANK CARDS, GIFT CARDS, PRINTED INFORMATIONAL CARDS PERTAINING TO DIET, NUTRITION, FOOD AND GENERAL HEALTH AND LIFESTYLE; POST CARDS; STATIONERY; PERIODICALS IN THE FIELD OF DIET, NUTRITION, FOOD AND GENERAL HEALTH AND LIFESTYLE; DIARIES; PRINTED INSTRUCTIONAL AND TEACHING MATERIALS IN THE FIELD OF DIET, NUTRITION, FOOD AND GENERAL HEALTH AND LIFESTYLE (U.S. CLS. 2, 5, 22, 23, 29, 37, 38 AND 50).

CLASS 29—MEATS AND PROCESSED FOODS

FOR MEAT, FISH, POULTRY AND GAME; MEAT EXTRACTS; FRUIT AND VEGETABLES, ALL BEING PRESERVED, DRIED, COOKED AND/OR FROZEN; JELLIES; DAIRY PRODUCTS EXCLUDING ICE CREAM, ICE MILK, AND FROZEN YOGHURT; JAMS; CRANBERRY SAUCE; APPLESAUCE, FRUIT PRESERVES; EGGS; MILK AND MILK PRODUCTS EXCLUDING ICE CREAM, ICE MILK, AND FROZEN YOGHURT; EDIBLE OILS AND FATS; READY PREPARED MEALS CONSISTING PRIMARILY OF MEAT, FISH, POULTRY OR VEGETABLES; PREPARED MEALS CONSISTING PRIMARILY OF MEAT, FISH, POULTRY OR VEGETABLES; INSTANT MEALS CONSISTING PRIMARILY OF MEAT, FISH, POULTRY OR VEGETABLES; INSTANT SOUP CONSISTING PRIMARILY OF MEAT, FISH, POULTRY OR VEGETABLES; SOUPS; REDUCED FAT CONTENT DAIRY PRODUCTS EXCLUDING ICE CREAM, ICE MILK, AND FROZEN YOGHURT; POTATO CRISPS AND POTATO CHIPS; CHEESE, FRUIT-BASED, HAZELNUT, PEANUT, ALMOND, MACADAMIA NUT, BRAZIL NUT, WALNUT, PECAN AND OTHER EDIBLE NUT BASED, AND VEGETABLE BASED, SPREADS; FRUIT AND SOY BASED SNACK FOODS; SNACK FOOD DIPS EXCLUDING SALSA AND OTHER SAUCES USED AS DIPS; VEGETABLE BASED SNACK FOODS; PROCESSED EDIBLE SEEDS; LIME PICKLE; VEGETABLE PRODUCTS, NAMELY, VEGETABLE CRISPS; SEED AND GRAIN BASED SNACKS, NAMELY, PROCESSED EDIBLE SEEDS IN THE NATURE OF FLOWER SEEDS, FRUIT SEEDS, SEEDS FOR FRUIT OR VEGETABLES AND PLANT SEED (U.S. CL. 46).

CLASS 30—STAPLE FOODS

FOR BREAKFAST CEREALS AND CEREAL BASED SNACK FOODS; BREAD; ICE CONFECTIONS, ICE CREAM; COFFEE; TEA; HERBAL TEA; COCOA; HOT CHOCOLATE; SUGAR, NAMELY, SUCROSE AND FRUIT SUGARS; TAPIOCA; SAGO; ARTIFICIAL COFFEE; FLOUR; BAKERY PRODUCTS; PASTRY AND LOW GLYCEMIC CONFECTIONERY PRODUCTS, NAMELY, CROISSANTS, DANISH PASTRIES, COOKIES, CAKES, CANDIES, CHOCOLATE; PIZZA BASES, NAMELY, PIZZA DOUGH, PIZZA CRUSTS; TORTILLA WRAPS; HONEY; CONDIMENTS, NAMELY, BARBECUE SAUCES, CHUTNEYS, COCKTAIL SAUCE, TOMATO KETCHUP, MAYONNAISE, MUSTARDS, PEPPER SAUCES, MINT SAUCE, SALSAS, AND TARTAR SAUCE; SAUCES; TREACLE; SWEET FLAVORED SYRUPS TYPICALLY TO BE SERVED ON ICE CREAM, SWEET FLAVORED SYRUPS TYPICALLY TO BE SERVED ON PANCAKES AND WAFFLES; LOW GLYCEMIC INSTANT MEALS CONSISTING PRIMARILY OF PASTA OR RICE; FLOUR-BASED CHIPS AND CEREAL BASED SNACK FOODS; PUDDINGS; DESSERTS, NAMELY, CHEESECAKES; FROZEN YOGHURTS, BAKERY DESSERTS, DESSERT MOUSSES, AND SOUFFLES; PASTA AND NOODLES; SAUCES MADE FROM PEAR, BLACKBERRY, BLUEBERRY, ORANGE, RHUBARB, LOGANBERRY, BOYSENBERRY, STRAWBERRY, RASPBERRY, REDCURRANT; BLACKCURRANT; GOOSEBERRY, PEACH, PLUM AND APRICOT, ALONE OR IN COMBINATION; PICKLE RELISH (U.S. CL. 46).

CLASS 31—NATURAL AGRICULTURAL PRODUCTS

FOR FRESH FRUIT AND VEGETABLES; UNPROCESSED GRAINS; SEED AND GRAIN BASED SNACKS, NAMELY, UNPROCESSED FLOWER SEEDS, FRUIT SEEDS, SEEDS FOR FRUIT OR VEGETABLES, AND PLANT SEEDS (U.S. CLS. 1 AND 46).

CLASS 32—LIGHT BEVERAGES

FOR NON-ALCOHOLIC BEVERAGES, NAMELY, LOW GLYCEMIC, CARBONATED SOFT DRINKS AND NON-CARBONATED SOFT DRINKS, FRUIT AND VEGETABLE JUICES AND FRUIT AND VEGETABLE BLENDED JUICES, AND PREPARATIONS FOR MAKING SUCH BEVERAGES; MINERAL AND AERATED WATERS; FRUIT DRINKS AND FRUIT JUICES; VEGETABLE JUICES; SYRUPS FOR ADDING TO BOTH WARM AND COLD BEVERAGES; SWEET FLAVORED SYRUPS TYPICALLY TO BE USED IN BEVERAGES (U.S. CLS. 45, 46 AND 48).

GINA FINK, EXAMINING ATTORNEY

SN 78-657,908. ADHESIVE TECHNOLOGIES, INC., HAMPTON, NH. FILED 6-24-2005.

ADHESIVE TECH

THE MARK CONSISTS OF STANDARD CHARACTERS WITHOUT CLAIM TO ANY PARTICULAR FONT, STYLE, SIZE, OR COLOR.

OWNER OF U.S. REG. NO. 2,719,700.

NO CLAIM IS MADE TO THE EXCLUSIVE RIGHT TO USE "ADHESIVE", APART FROM THE MARK AS SHOWN.

CLASS 1—CHEMICALS

FOR GLUE STICKS AND ALL PURPOSE ADHESIVES FOR GENERAL BONDING AND REPAIR PURPOSES; NON-STICK GLUE PAD FOR GENERAL BONDING AND REPAIR PURPOSES; ADHESIVES, OTHER THAN FOR STATIONERY OR HOUSEHOLD PURPOSES AND APPLICATORS SOLD AS A UNIT (U.S. CLS. 1, 5, 6, 10, 26 AND 46).

CLASS 7—MACHINERY

FOR HOT MELT GLUE GUNS; HOT MELT GLUE GUNS AND HOT MELT GLUE STICKS SOLD AS A UNIT (U.S. CLS. 13, 19, 21, 23, 31, 34 AND 35).

CLASS 16—PAPER GOODS AND PRINTED MATTER

FOR ADHESIVES FOR STATIONERY PURPOSES; ADHESIVE GLUE DISPENSERS FOR STATIONERY PURPOSES (U.S. CLS. 2, 5, 22, 23, 29, 37, 38 AND 50).

ANDREA SAUNDERS, EXAMINING ATTORNEY

SN 78-675,706. HANDLER, THAYER & DUGGAN, LLC, CHICAGO, IL. FILED 7-21-2005.

Stealth Premarital Arrangement

THE MARK CONSISTS OF STANDARD CHARACTERS WITHOUT CLAIM TO ANY PARTICULAR FONT, STYLE, SIZE, OR COLOR.

NO CLAIM IS MADE TO THE EXCLUSIVE RIGHT TO USE "PREMARITAL ARRANGEMENT", APART FROM THE MARK AS SHOWN.

CLASS 36—INSURANCE AND FINANCIAL

FOR FINANCIAL PLANNING (U.S. CLS. 100, 101 AND 102).

FIRST USE 12-1-1997; IN COMMERCE 12-1-1997.

CLASS 42—SCIENTIFIC AND COMPUTER SERVICES

FOR LEGAL SERVICES (U.S. CLS. 100 AND 101).

FIRST USE 12-1-1997; IN COMMERCE 12-1-1997.

WILLIAM VERHOSEK, EXAMINING ATTORNEY

SN 78-675,735. HANDLER, THAYER & DUGGAN, LLC, CHICAGO, IL. FILED 7-21-2005.

Stealth Prenuptial Arrangement

THE MARK CONSISTS OF STANDARD CHARACTERS WITHOUT CLAIM TO ANY PARTICULAR FONT, STYLE, SIZE, OR COLOR.

NO CLAIM IS MADE TO THE EXCLUSIVE RIGHT TO USE "PRENUPTIAL ARRANGEMENT", APART FROM THE MARK AS SHOWN.

CLASS 36—INSURANCE AND FINANCIAL

FOR FINANCIAL PLANNING (U.S. CLS. 100, 101 AND 102).

FIRST USE 12-1-1997; IN COMMERCE 12-1-1997.

CLASS 42—SCIENTIFIC AND COMPUTER SERVICES

FOR LEGAL SERVICES (U.S. CLS. 100 AND 101).

FIRST USE 12-1-1997; IN COMMERCE 12-1-1997.

WILLIAM VERHOSEK, EXAMINING ATTORNEY

SN 78-680,114. CRYPTO, INC., BROOKLYN, NY. FILED 7-27-2005.

SN 78-684,491. DANIEL, GLORIA, LONDON, UNITED KINGDOM, FILED 8-3-2005.

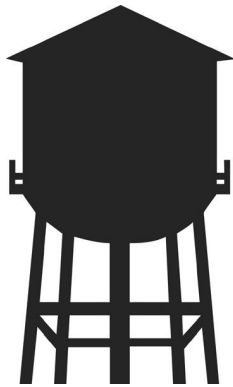

THE MARK CONSISTS OF IMAGE OF A WATERTOWER.

CLASS 18—LEATHER GOODS

FOR ATTACHE CASES; BACKPACKS; BEACH BAGS; BILLFOLDS; BOOK BAGS; BRIEFCASE TYPE PORTFOLIOS; BRIEFCASES; BUSINESS CARD CASES; CHANGE PURSES; COSMETIC BAGS SOLD EMPTY; CREDIT CARD CASES; DUFFEL BAGS; FANNY PACKS; GYM BAGS; HANDBAGS; KEY CASES; LUGGAGE; MESSENGER BAGS; POCKETBOOKS; POUCHES; PURSES; SCHOOL BAGS; SHOULDER BAGS; SUITCASES; TOTE BAGS; TRAVELING BAGS; AND WALLETS (U.S. CLS. 1, 2, 3, 22 AND 41).

FIRST USE 10-29-1998; IN COMMERCE 10-29-1998.

CLASS 25—CLOTHING

FOR CLOTHING, NAMELY, SWEATSHIRTS, SHORTS, PANTS, SHIRTS, T-SHIRTS, JERSEYS, TIGHTS, STRETCH PANTS, SOCKS, GLOVES, JACKETS, SWIMWEAR, COVERUPS, SWEATERS, CAPS, HATS, VISORS, PULL-OVERS, WARM-UP SUITS, SWEAT PANTS, SKIRTS, DRESSES, VESTS, LEOTARDS, COATS, BATHING SUITS, BELTS, BLOUSES, HOSIERY, SCARVES, SLIPPERS, SPORT JACKETS, SUITS, ROBES, PAJAMAS, SHOES, TROUSERS, TIES, SUSPENDERS, NECKWEAR, AND ONE PIECE GARMENTS FOR INFANTS AND TODDLERS (U.S. CLS. 22 AND 39).

FIRST USE 10-25-1998; IN COMMERCE 10-25-1998.
VERNA BETH RIRIE, EXAMINING ATTORNEY

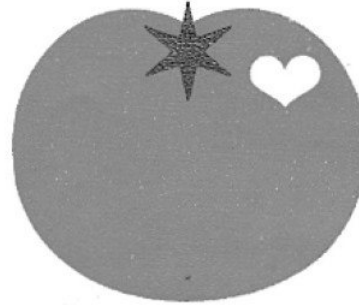

big tomato company

OWNER OF UNITED KINGDOM REG. NO. 2381764, DATED 1-10-2005, EXPIRES 1-10-2015.

NO CLAIM IS MADE TO THE EXCLUSIVE RIGHT TO USE "COMPANY", APART FROM THE MARK AS SHOWN. THE MARK CONSISTS OF THE DESIGN OF A TOMATO WITH THE WORDS "BIG TOMATO COMPANY" BELOW.

CLASS 16—PAPER GOODS AND PRINTED MATTER

FOR PAPER, CARDBOARD AND GOODS MADE FROM THESE MATERIALS, NAMELY, BOXES AND GIFT BOXES MADE THEREOF, ENVELOPES, GIFT CARDS, ANNOUNCEMENT CARDS, PRINTED SIGNS OF PAPER OR CARDBOARD, PRINTED INVITATIONS, PAPER BADGES, PRINTED GIFT WRAP, WRAPPING PAPER, PAPER HANG TAGS, BAGS OF PAPER, HANDKERCHIEFS OF PAPER, NAPKINS OF PAPER, COASTERS OF PAPER, TABLECLOTHS OF PAPER, PLACE MATS OF PAPER, SCRAPBOOKS, TRAVEL JOURNALS, POSTERS, CALENDARS, DIARIES; PRINTED MATTER, NAMELY, BOOKS, MANUALS, PAMPHLETS, NEWSLETTERS, ALBUMS, NEWSPAPERS, MAGAZINES AND PERIODICALS FEATURING A RANGE OF GIFTS FOR SALE; BOOKBINDING MATERIAL, NAMELY, BOOK BINDINGS, BOOKBINDING STRIPS, BOOKBINDING CLOTH, BOOKBINDING CORDS, CARDBOARD BACKING FOR BINDING BOOKS; PHOTOGRAPHS; STATIONERY; ADHESIVES FOR STATIONERY OR HOUSEHOLD PURPOSES; ARTISTS' MATERIALS, NAMELY, ARTISTS' PENCILS, ARTISTS' PENS, ARTISTS' PASTELS, CANVAS PANELS FOR ARTISTS, WATERCOLOR SAUCERS, EASELS, PALETTES FOR PAINTERS; PAINT BRUSHES; TYPEWRITERS AND OFFICE REQUISITES EXCEPT FURNITURE, NAMELY, CORRECTING FLUID FOR TYPE, PENS, BINDERS, STAPLERS, DRAWING RULERS, ERASERS, RUBBER BANDS, ADHESIVE TAPE DISPENSERS, PAPER CUTTERS, PAPER KNIVES; PRINTED INSTRUCTION AND TEACHING MATERIAL IN THE FIELD OF HISTORY, ANTIQUITIES, BUSINESS PRACTICES, ART OR DESIGN EXCEPT APPARATUS IN THE FIELD OF RETAIL SALES; PLASTIC MATERIALS FOR PACKAGING, NAMELY, PLASTIC FILM FOR HOUSEHOLD DOMESTIC PURPOSES AND FOR WRAPPING, GIFTS, NOT FOR COMMERCIAL OR INDUSTRIAL PURPOSES; PLASTIC WRAP FOR WRAPPING GIFTS AND FOR PACKAGING, PLASTIC BAGS FOR PACKAGING, PLASTIC BUBBLE PACKS FOR PACKAGING; PRINTERS' TYPE; PRINTING BLOCKS; BOOKS IN THE FIELD OF LEISURE INTEREST ENTERTAINMENT AND LEISURE INTEREST EDUCATION AS WELL AS BOOKS FOR TEACHING COOKERY, BUSINESS PRACTICES, HISTORY, ANTIQUITIES, ART OR DESIGN; POSTCARDS, JOURNALS CONCERNING RETAIL SALES; NOTEBOOKS; GREETING CARDS; PRINTED PAPER SIGNS; ADVERTISING MATERIAL, NAMELY, BROCHURES, PRODUCT CATALOGUES, PRODUCT LEAFLETS AND PRODUCT POSTERS, ALL RELATING TO THE SALE OF A VARIETY OF HOME WARES AND GIFTS (U.S. CLS. 2, 5, 22, 23, 29, 37, 38 AND 50).

CLASS 21—HOUSEWARES AND GLASS

FOR HOUSEHOLD OR KITCHEN UTENSILS AND CONTAINERS NOT OF PRECIOUS METAL OR COATED THEREWITH, NAMELY, JUGS, BOWLS, HOLDERS FOR TEABAGS, BREAD BINS, UTENSIL JARS, STORAGE JARS, BUTTER DISHES, POTS FOR PRESERVES, TOAST RACKS, EGG CUPS, PITCHERS, PLATES, TOOTH-BRUSH HOLDERS, BOWLS FOR PETS; COMBS AND SPONGES, NAMELY, HAIR COMBS, COMBS FOR USE ON DOMESTIC ANIMALS, EYELASH COMBS, SPONGES FOR HOUSEHOLD PURPOSES, KITCHEN SPONGES, ABRASIVE SPONGES FOR KITCHEN USE, SCOURING SPONGES; BRUSHES EXCEPT PAINT BRUSHES, NAMELY, BRUSHES FOR HOUSEHOLD PURPOSES, NAMELY, BATH BRUSHES, BOTTLE BRUSHES, DISH-WASHING BRUSHES, BRUSHES FOR CLEANING CONTAINERS, BRUSHES FOR CLEANING TEETH, HAIR BRUSHES, CLOTHES BRUSHES, MAKE-UP BRUSHES, EYEBROW BRUSHES, SCRUBBING BRUSHES, BRUSHES FOR GROOMING PET ANIMALS; BRUSH-MAKING MATERIALS, NAMELY, SYNTHETIC FIBERS FOR THE MANUFACTURE OF BRUSHES, FILAMENTS FOR MAKING BRUSHES, BRISTLES; ARTICLES FOR CLEANING PURPOSES, NAMELY, ABRASIVE PADS, ABRASIVE SPONGES, ABSORBENT PADS, BROOMS, BRUSHES ADAPTED TO RECEIVE A CLEANING AGENT, CLEANING CLOTHS, CLEANING WIPES, DUSTERS, GLOVES FOR CLEANING; STEEL WOOL FOR CLEANING; UNWORKED OR SEMI-WORKED GLASS EXCEPT GLASS USED IN BUILDING; BEVERAGE GLASSWARE, PORCELAIN CUPS, PORCELAIN SAUCERS, PORCELAIN MUGS AND EARTHENWARE CUPS, EARTHENWARE SAUCERS AND EARTHENWARE MUGS; MUGS; CONTAINERS FOR KITCHEN UTENSILS AND FOOD CONDIMENTS NOT OF PRECIOUS METAL; DISPENSERS FOR SAUCES, WASHING LIQUID, BODY LOTION, FOAM BATH; CONDIMENT DISPENSERS; CERAMICS FOR HOUSEHOLD PURPOSES, NAMELY, CERAMIC MUGS, CERAMIC CUPS, CERAMIC SAUCERS, CERAMIC PLATES, CERAMIC CANISTERS, CERAMIC BOXES, CERAMIC LIGHT PULLS, CERAMIC PLANTERS, CERAMIC VASES; CUPS; TRAYS NOT OF PRECIOUS METAL; DUSTBINS; CONTAINERS FOR HOUSEHOLD OR KITCHEN USE NOT OF PRECIOUS METAL; GLASS BOWLS, GLASS BOXES, DRINKING GLASSES, GLASS CUPS, GLASS DISHES, GLASS JARS; BOTTLES SOLD EMPTY; COFFEE POTS, NOT OF PRECIOUS METAL; COOLERS, NAMELY, BEVERAGE COOLERS, BOTTLE COOLERS, ICE PAILS; DRINKING VESSELS; PANS; NAPKIN HOLDERS; POTTERY DISHES; POTS; SAUCERS; SOAP HOLDERS; TABLEWARE, NAMELY, TEACUPS AND SAUCERS, COFFEE CUPS AND SAUCERS, PLATES, BOWLS, NOT MADE OF PRECIOUS METAL; TEAPOTS NOT OF PRECIOUS METAL; TOILET PAPER HOLDERS; TOOTH BRUSHES; VACUUM BOTTLES; WATERING CANS; WORKS OF ART OF PORCELAIN, TERRACOTTA OR GLASS, NAMELY, FIGURINES, PLATES, BOWLS, JUGS, PITCHERS, VASES; SAUCE DISPENSERS; PARTS AND FITTINGS FOR THE AFORESAID GOODS (U.S. CLS. 2, 13, 23, 29, 30, 33, 40 AND 50).

CLASS 24—FABRICS

FOR TEXTILES AND TEXTILE GOODS, NAMELY, TEA TOWELS, BEDSPREADS, CURTAINS, BED CLOTHES AND BED LINEN, NAMELY, SHEETS, PILLOW CASES, MATTRESS COVERS, DUVET COVERS, AND BLANKETS; BED AND TABLE COVERS; TOWELS OF TEXTILE; NAPKINS OF TEXTILE, PILLOWCASES, BEDDING, NAMELY, THROWS, BED BLANKETS, BED SHEETS, BED PADS, BEDSPREADS, TOWELS (U.S. CLS. 42 AND 50).

NAAKWAMA ANKRAH, EXAMINING ATTORNEY

SN 78-689,692. HANDLER, THAYER & DUGGAN, LLC, CHICAGO, IL. FILED 8-10-2005.

Stealth Prenup

THE MARK CONSISTS OF STANDARD CHARACTERS WITHOUT CLAIM TO ANY PARTICULAR FONT, STYLE, SIZE, OR COLOR.

NO CLAIM IS MADE TO THE EXCLUSIVE RIGHT TO USE "PRENUP", APART FROM THE MARK AS SHOWN.

CLASS 36—INSURANCE AND FINANCIAL

FOR FINANCIAL PLANNING (U.S. CLS. 100, 101 AND 102).

FIRST USE 12-1-1997; IN COMMERCE 12-1-1997.

CLASS 42—SCIENTIFIC AND COMPUTER SERVICES

FOR LEGAL SERVICES (U.S. CLS. 100 AND 101).

FIRST USE 12-1-1997; IN COMMERCE 12-1-1997.

WILLIAM VERHOSEK, EXAMINING ATTORNEY

SN 78-693,401. E-SMART TECHNOLOGIES, INC., NEW YORK, NY. FILED 8-16-2005.

SUPER SMART PAY

THE MARK CONSISTS OF STANDARD CHARACTERS WITHOUT CLAIM TO ANY PARTICULAR FONT, STYLE, SIZE, OR COLOR.

NO CLAIM IS MADE TO THE EXCLUSIVE RIGHT TO USE "SMART PAY", APART FROM THE MARK AS SHOWN.

CLASS 9—ELECTRICAL AND SCIENTIFIC APPARATUS

FOR ENCODED SMART CARDS CONTAINING PROGRAMMING USED TO PROTECT DATA, DOCUMENTS AND IDENTITIES; MAGNETICALLY ENCODED CREDIT AND DEBIT CARDS; ELECTRONIC AND MAGNETIC ID CARDS FOR USE IN CONNECTION WITH PAYMENT OF SERVICES (U.S. CLS. 21, 23, 26, 36 AND 38).

CLASS 36—INSURANCE AND FINANCIAL

FOR FINANCIAL SERVICES, NAMELY PROVIDING ELECTRONIC PROCESSING OF CREDIT CARD, DEBIT CARD, ELECTRONIC AND MAGNETIC ID CARD AND PRE-PAID AND STORED VALUE CARD TRANSACTIONS AND ELECTRONIC PAYMENTS VIA A GLOBAL COMPUTER NETWORK (U.S. CLS. 100, 101 AND 102).

TASHIA BUNCH, EXAMINING ATTORNEY

SN 78-694,615. COMPASS DIGITAL, LLC, PLYMOUTH, MI.
FILED 8-17-2005.

PASSUS

THE MARK CONSISTS OF STANDARD CHARACTERS WITHOUT CLAIM TO ANY PARTICULAR FONT, STYLE, SIZE, OR COLOR.

CLASS 38—COMMUNICATION

FOR PROVIDING SECURE TELECOMMUNICATIONS CONNECTIONS TO THE INTERNET FOR CUSTOMERS TO ACCESS TRACKING SYSTEMS DATA, ACTIVITY, AND REPORTS GENERATED AND COLLECTED BY TRACKING SYSTEMS AND DEVICES (U.S. CLS. 100, 101 AND 104).

CLASS 42—SCIENTIFIC AND COMPUTER SERVICES

FOR DESIGN AND DEVELOPMENT OF TRACKING SYSTEMS AND DEVICES FOR OTHERS; COMPUTER SERVICES, NAMELY, ACTING AS AN APPLICATION SERVICE PROVIDER IN THE FIELD OF KNOWLEDGE MANAGEMENT TO HOST COMPUTER APPLICATION SOFTWARE FOR THE COLLECTION AND STORAGE OF TRACKING SYSTEM DATA; PROVIDING USE OF NON-DOWNLOADABLE COMPUTER SOFTWARE FOR SHIPMENT PROCESSING, SHIPPING DOCUMENT PROCESSING AND COMPLETION INVENTORY DETERMINATION, TRACKING AND INTEGRATING DATA INTO LOGISTICS SYSTEMS AND TRACKING AND LOCATING DOCUMENTS AND ARTICLES OF ANY KIND OVER COMPUTER NETWORKS, INTRANETS AND THE INTERNET (U.S. CLS. 100 AND 101).

CAROLINE WOOD, EXAMINING ATTORNEY

SN 78-703,875. KMW U.S.A., INC., GARDEN GROVE, CA.
FILED 8-30-2005.

DUALPHASE

THE MARK CONSISTS OF STANDARD CHARACTERS WITHOUT CLAIM TO ANY PARTICULAR FONT, STYLE, SIZE, OR COLOR.

CLASS 9—ELECTRICAL AND SCIENTIFIC APPARATUS

FOR WIRELESS AND WIRELESS TELECOMMUNICATIONS HARDWARE, NAMELY ANTENNAS FOR USE IN CELLULAR, MOBILE AND/OR WIRELESS COMMUNICATION SYSTEMS AND IN TRANSMITTING AND RECEIVING AUDIO, VISUAL, AND/OR OTHER FORMS OF DATA AND/OR MESSAGES IN WIRELESS COMMUNICATION SYSTEMS; ANTENNAS FOR USE IN CELLULAR, MOBILE AND/OR WIRELESS COMMUNICATION SYSTEMS FEATURING CONTROLLABLE ELECTRONIC DOWN TILT, AND AZIMUTH BEAM STEERING; WIRELESS TELECOMMUNICATIONS HARDWARE IN THE NATURE OF WIRELESS VOICE AND DATA TRANSMITTERS AND RECEIVERS, TRANSCEIVERS, SIGNAL AMPLIFIERS, BASE STATIONS, AND MOBILE HANDSET SUBSCRIBER UNITS; APPARATUS AND INSTRUMENTS FOR CONDUCTING, SWITCHING, TRANSFORMING, ACCUMULATING, REGULATING OR CONTROLLING ELECTRICITY, NAMELY, AMPLIFIERS, ANTENNAS, TRANSFORMERS, ELECTRICAL CIRCUIT BOARDS, INTEGRATED CIRCUITS, AND/OR SYSTEM BOARDS (MOTHER CARDS) AND PROCESSORS FOR MOBILE NETWORKS; COMPONENTS OF MOBILE NETWORKS, NAMELY, ANTENNAS, TELECOMMUNICATION SWITCHES FOR NETWORKS, COMMUNICATION HUBS FOR NETWORKS, GATEWAY ROUTERS IN THE NATURE OF COMPUTER CONTROL HARDWARE FOR NETWORKS, COMPUTER HARDWARE FOR BILLING OPERATIONS IN MOBILE NETWORKS, QUALITY OF SERVICE ANALYZERS COMPRISING EMBEDDED SOFTWARE DESIGNED TO MONITOR AND IMPROVE THE QUALITY AND/OR THE SPEED OF THE TRANSMITTED COMMUNICATION SIGNALS; COMPUTER AND SYSTEMS SOFTWARE, NAMELY, WIRELESS AND TELECOMMUNICATIONS NETWORK MONITORING, MANAGEMENT, ADMINISTRATION, AND CONTROL SOFTWARE FOR USE IN MONITORING A MOBILE NETWORK OF BASE STATIONS AND SUBSCRIBER UNITS FOR USE IN WIRELESS COMMUNICATION SYSTEMS AND NETWORKS; SOFTWARE EMBEDDED IN INTEGRATED CIRCUITS USED TO OPERATE WIRELESS AND MOBILE TELECOMMUNICATIONS COMPUTER HARDWARE, MOBILE TELECOMMUNICATIONS DEVICES AND NETWORK PERIPHERALS; MOBILE TELECOMMUNICATIONS SOFTWARE USED TO MANAGE, DIRECT, ROUTE, TRANSMIT AND RECEIVE TELEPHONE CALLS, ELECTRONIC MESSAGES, AND OTHER AUDIO AND VISUAL AND OTHER FORMS OF DATA AND/OR MESSAGES OVER COMPUTER NETWORKS, WIRELESS AND MOBILE TELECOMMUNICATIONS ACCESS LINES (U.S. CLS. 21, 23, 26, 36 AND 38).

CLASS 35—ADVERTISING AND BUSINESS

FOR MANAGING QUALITY OF SERVICE (QOS) IN MOBILE TELECOMMUNICATIONS NETWORKS (U.S. CLS. 100, 101 AND 102).

CLASS 38—COMMUNICATION

FOR WIRELESS AND MOBILE TELECOMMUNICATION SERVICES, NAMELY, PROVIDING ACCESS TO MOBILE TELEPHONE COMMUNICATION NETWORKS (U.S. CLS. 100, 101 AND 104).

CLASS 42—SCIENTIFIC AND COMPUTER SERVICES

FOR MONITORING AND IMPROVING THE QUALITY AND THE SPEED OF THE TRANSMITTED AUDIO, VISUAL, DATA AND MESSAGE SIGNAL FOR MOBILE TELECOMMUNICATIONS NETWORKS (U.S. CLS. 100 AND 101).

KATHERINE M. DUBRAY, EXAMINING ATTORNEY

SN 78-712,155. SILBERBERG, COURTNEY, WOODLAND HILLS, CA. AND SILBERBERG, JACQUELYN, WOODLAND HILLS, CA. FILED 9-13-2005.

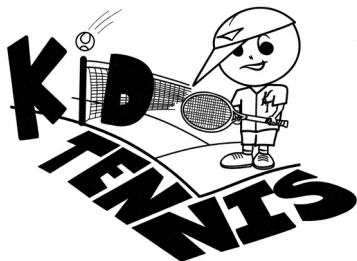

OWNER OF U.S. REG. NO. 2,828,835.

NO CLAIM IS MADE TO THE EXCLUSIVE RIGHT TO USE "KID TENNIS", APART FROM THE MARK AS SHOWN.

CLASS 9—ELECTRICAL AND SCIENTIFIC APPARATUS

FOR SERIES OF PRE-RECORDED AUDIO AND VIDEO CASSETTES, CDS, AND DVDS FEATURING YOUTH-ORIENTED LIVE-ACTION AND ANIMATED TENNIS INSTRUCTION AND ENTERTAINMENT, HOSTED BY AN ANIMATED CHARACTER. (U.S. CLS. 21, 23, 26, 36 AND 38).

CLASS 25—CLOTHING

FOR CLOTHING, NAMELY, HATS, SHIRTS, CAPS, SWEATSUITS, SHORTS, PANTS, SOCKS, WRISTBANDS, HEADBANDS, JACKETS AND SOCKS, FOR MEN, WOMEN AND CHILDREN. (U.S. CLS. 22 AND 39).

DANIEL RUSSELL, EXAMINING ATTORNEY

SN 78-714,201. NYGARD INTERNATIONAL PARTNERSHIP, WINNIPEG R2X 1R3, CANADA, FILED 9-15-2005.

NYGÅRD
HOME

OWNER OF U.S. REG. NOS. 2,080,489, 2,667,459 AND 2,716,981.

NO CLAIM IS MADE TO THE EXCLUSIVE RIGHT TO USE "HOME", APART FROM THE MARK AS SHOWN.

CLASS 8—HAND TOOLS

FOR FLATWARE, NAMELY, KNIVES, FORKS AND SPOONS; MULTI-PURPOSE SHEARS AND SHARPENING STEEL (U.S. CLS. 23, 28 AND 44).

CLASS 11—ENVIRONMENTAL CONTROL APPARATUS

FOR LIGHTING FIXTURES AND ACCESSORIES, NAMELY, TABLE AND FLOOR LAMPS, SCONCES, CHANDELIERS AND LAMP SHADES (U.S. CLS. 13, 21, 23, 31 AND 34).

CLASS 20—FURNITURE AND ARTICLES NOT OTHERWISE CLASSIFIED

FOR FURNITURE AND ACCESSORIES, NAMELY, SOFAS, CHAIRS, OTTOMANS, CHAISES, TABLES, ARMOIRES, BOOKCASES, CABINETS, SHELVES, STOOLS, MAGAZINE RACKS, FITTED FABRIC FURNITURE COVERS, DECORATIVE PILLOWS, CUSHIONS; DINING AND LIVING ROOM FURNITURE, NAMELY, DINING TABLES AND CHAIRS, SIDEBOARDS, CONSOLE TABLES AND BUFFETS, CABINETS, BAR STOOLS, WINE RACKS; BEDROOM FURNITURE, NAMELY, BEDS, HEADBOARDS, MATTRESSES, BEDSIDE TABLES, DRESSERS, WARDROBES AND ARMOIRES, BATHROOM VANITIES AND SCREENS, CRADLES AND COTS; HOME OFFICE FURNITURE, NAMELY, DESKS, FILE CABINETS, DESK CHAIRS, BOOKCASES AND SHELVES; OUTDOOR FURNITURE, NAMELY, TABLES, SEATING AND UMBRELLA STANDS; MIRRORS; PICTURE FRAMES NOT OF PRECIOUS METAL; WINDOW BLINDS AND SHADES; CURTAIN ACCESSORIES, NAMELY, CURTAIN HOOKS, RAILS, RINGS, RODS, ROLLERS, PILLOWS (U.S. CLS. 2, 13, 22, 25, 32 AND 50).

CLASS 21—HOUSEWARES AND GLASS

FOR DINNERWARE, NAMELY, PLATES, BOWLS, CUPS, SAUCERS, MUGS, PLATTERS AND SERVERS; GLASSWARE, NAMELY, STEMWARE, BEVERAGE GLASSES AND PITCHERS; COOKWARE, NAMELY, SKILLETS, SAUTÉ PANS, SAUCEPANS, WOKS, NON-ELECTRIC ROASTERS, GRIDDLES, STOCKPOTS, DUTCH OVENS, AND BAKING DISHES; BAKEWARE, NAMELY, BAKING SHEETS, CAKE PANS, LOAF PANS, MUFFIN PANS, PIE PANS AND PIZZA PANS OR STONES; KITCHEN UTENSILS AND CONTAINERS, NAMELY, KNIFE BLOCKS, CUTTING BOARDS, WOODEN SPOONS, WHISKS, SIFTERS, GRATERS, ROLLING PINS, CANISTER SETS, SALT AND PEPPER MILLS, SPICE RACKS, PAPER TOWEL HOLDERS AND NAPKIN HOLDERS; BATH ACCESSORIES, NAMELY, SOAP DISPENSERS, SOAP DISHES, TOOTHBRUSH HOLDERS, TUMBLERS, WASTEBASKETS, TOILET BOWL BRUSHES, TOILET BRUSH HOLDERS AND CERAMIC TISSUE BOX COVERS; WINE TRAYS; BASKETS OF WICKER, STRAW, WOOD AND CLOTH (U.S. CLS. 2, 13, 23, 29, 30, 33, 40 AND 50).

CLASS 24—FABRICS

FOR BED LINENS, NAMELY, SHEETS, PILLOW CASES, PILLOW SHAMS, BED SKIRTS, DUVET COVERS, COMFORTERS, BLANKETS, QUILTS, AND MATTRESS PADS; BATH LINENS, NAMELY, TOWELS AND SHOWER CURTAINS; TABLE LINENS, NAMELY, TEXTILE TABLECLOTHS, NAPKINS, RUNNERS, PLACE-MATS, KITCHEN TOWELS AND DISH CLOTHS, OVEN MITTS AND POT HOLDERS; CURTAINS, FABRIC CURTAIN TIE-BACKS; THROWS (U.S. CLS. 42 AND 50).

CLASS 27—FLOOR COVERINGS

FOR CARPETS, RUGS AND MATS FOR COVERING EXISTING FLOORS; WALLPAPER (U.S. CLS. 19, 20, 37, 42 AND 50).

NAAKWAMA ANKRAH, EXAMINING ATTORNEY

SN 78-717,199. WILDSIGHT PRODUCTIONS, INC., NEW YORK, NY. FILED 9-21-2005.

WILDTONES

THE MARK CONSISTS OF STANDARD CHARACTERS WITHOUT CLAIM TO ANY PARTICULAR FONT, STYLE, SIZE, OR COLOR.

CLASS 9—ELECTRICAL AND SCIENTIFIC APPARATUS

FOR DOWNLOADABLE MULTIMEDIA FILE CONTAINING SOUNDS, IMAGES AND INFORMATION ABOUT ANIMALS, NAMELY, SCREENSAVERS AND MESSAGE ALERTS, AND OTHER IMAGES, AUDIO, TEXT AND VIDEO CONTENT, ALL RELATING TO WILDLIFE INTERESTS AND ENTHUSIASTS, FOR USE ON MOBILE HANDSETS AND OTHER WIRELESS COMMUNICATION DEVICES (U.S. CLS. 21, 23, 26, 36 AND 38).

CLASS 41—EDUCATION AND ENTERTAINMENT

FOR PROVIDING RECREATIONAL INFORMATION OF INTEREST TO ANIMAL LOVERS AND WILDLIFE ENTHUSIASTS IN THE NATURE OF HABITAT, HABITS, STATUS IN THE WILD, WHAT PEOPLE CAN DO TO HELP ANIMALS, THE LATIN NAME FOR ANIMALS, AND ANIMAL FUN FACTS VIA MOBILE CARRIER NETWORKS AND AN INTERNET WEBSITE (U.S. CLS. 100, 101 AND 107).

ZACHARY BELLO, EXAMINING ATTORNEY

SN 78-723,637. HEALTHACCORD, INC., HALLENDALE, FL. FILED 9-29-2005.

HealthAccord

THE MARK CONSISTS OF STANDARD CHARACTERS WITHOUT CLAIM TO ANY PARTICULAR FONT, STYLE, SIZE, OR COLOR.

CLASS 35—ADVERTISING AND BUSINESS

FOR HEALTH CARE UTILIZATION AND REVIEW SERVICES; HEALTH CARE COST CONTAINMENT; INSURANCE CLAIMS AUDITING SERVICES (U.S. CLS. 100, 101 AND 102).

CLASS 36—INSURANCE AND FINANCIAL

FOR UNDERWRITING INSURANCE FOR PRE-PAID HEALTH CARE; ELECTRONIC PROCESSING OF INSURANCE CLAIMS AND PAYMENT DATA; ADMINISTRATION AND OPERATION OF PREPAID HEALTHCARE PLANS OR MANAGED CARE PLANS TO INDIVIDUALS, GROUPS, EMPLOYERS, GOVERNMENTAL ENTITIES, EMPLOYEE BENEFIT PLANS, EMPLOYEE PENSION PLANS AND EMPLOYEE WELFARE BENEFIT PLANS (U.S. CLS. 100, 101 AND 102).

CLASS 44—MEDICAL, BEAUTY AND AGRICULTURAL SERVICES

FOR HEALTH CARE; HEALTH CARE SERVICES THROUGH THE AUSPICES OF A PREPAID LIMITED HEALTH SERVICE ORGANIZATION OR OTHER MANAGED CARE ORGANIZATION (U.S. CLS. 100 AND 101).

ANNE MADDEN, EXAMINING ATTORNEY

SN 78-724,794. NATIONAL KIDNEY FOUNDATION, NEW YORK, NY. FILED 10-2-2005.



OWNER OF U.S. REG. NO. 1,267,908.
NO CLAIM IS MADE TO THE EXCLUSIVE RIGHT TO USE "KIDNEY WALK" AND "KIDNEY FOUNDATION", APART FROM THE MARK AS SHOWN.

THE COLOR(S) RED, ORANGE AND WHITE IS/ARE CLAIMED AS A FEATURE OF THE MARK.

THE OUTLINE OF THE INTERLOCKING KIDNEYS IN A CIRCULAR FORMATION SHAPED LOGO AND THE SQUARE AROUND THE WORD IS DEPICTED IN THE COLOR RED. THE WORDS NATIONAL KIDNEY FOUNDATION, THE LINES ABOVE AND BENEATH THE WORDING KIDNEY WALK AND THE WORDS THEMSELVES ARE DEPICTED IN THE COLOR WHITE. THE INSIDE OF THE TWO INTERLOCKING KIDNEY SHAPED DESIGNS ON THE RIGHT OF THE DRAWING ARE DEPICTED IN THE COLOR ORANGE AND THE REMAINING KIDNEY SHAPED OVALS ARE DEPICTED IN THE COLOR WHITES

THE MARK CONSISTS OF IN PART, OF A DEPICTION OF INTERLOCKING KIDNEYS IN A CIRCULAR FORMATION SHAPED LOGO.

SEC. 2(F) AS TO "NATIONAL KIDNEY FOUNDATION".

CLASS 35—ADVERTISING AND BUSINESS

FOR PROMOTING PUBLIC AWARENESS OF THE NEED FOR HUMAN ORGAN DONATIONS AND TRANSPLANTS (U.S. CLS. 100, 101 AND 102).

CLASS 36—INSURANCE AND FINANCIAL

FOR CHARITABLE FUND RAISING; ELEEMOSYNARY SERVICES IN THE FIELD OF MONETARY DONATIONS FOR BOTH EDUCATION AND RESEARCH INTO THE PREVENTION AND TREATMENT OF KIDNEY AND URINARY TRACT DISEASE (U.S. CLS. 100, 101 AND 102).

BRIDGETT SMITH, EXAMINING ATTORNEY

SN 78-729,577. EXCHANGE SOLUTIONS, INC., WALTHAM, MA. FILED 10-9-2005.



"THE COLOR(S) PURPLISH-RED AND WHITE IS/ARE CLAIMED AS A FEATURE OF THE MARK."

"THE MARK CONSISTS OF (A) A RECTANGLE THAT IS COLORED PURPLISH-RED ON THE LEFT SIDE AND WHITE ON THE RIGHT SIDE; (B) A OVAL THAT IS

COLORED PURPLISH-RED ON THE LEFT SIDE AND WHITE ON THE RIGHT SIDE WITH A BORDER PORTION OF THE OVAL BEING COLORED WHITE ON THE LEFT SIDE AND WITH A SEGMENT OF A BORDER PORTION OF THE OVAL ON THE RIGHT SIDE BEING COLORED PURPLISH-RED; (C) THE WORD "EXCHANGE" COLORED WHITE OVER THE PURPLISH-RED SIDE OF THE RECTANGLE; AND (D) THE WORD "SOLUTIONS" COLORED PURPLISH-RED OVER THE WHITE SIDE OF THE RECTANGLE."

SEC. 2(F) AS TO "EXCHANGE SOLUTIONS".

CLASS 35—ADVERTISING AND BUSINESS

FOR CUSTOMER RELATIONSHIP MANAGEMENT; BUSINESS CONSULTING IN THE FIELD OF CUSTOMER MANAGEMENT; CUSTOMER PARTICIPATION MANAGEMENT, NAMELY IDENTIFYING AND IMPLEMENTING INCENTIVE AWARD PROGRAMS TO ENCOURAGE DESIRABLE CUSTOMER BEHAVIOR; BUSINESS MANAGEMENT; ORGANIZATIONAL CONSULTANCY AND COMPUTERIZED DATA MANAGEMENT ON A COMPUTER SERVER AND NETWORK TO FACILITATE ONLINE TRANSACTIONS; PROVIDING ACCESS TO AN ONLINE INCENTIVE AWARD PROGRAM TO PROMOTE THE SALES OF PRODUCTS AND SERVICES OF OTHERS (U.S. CLS. 100, 101 AND 102).

FIRST USE 1-1-1999; IN COMMERCE 1-1-1999.

CLASS 42—SCIENTIFIC AND COMPUTER SERVICES

FOR COMPUTER CONSULTATION SERVICES RELATING TO THE USE OF COMPUTER SOFTWARE FOR MANAGING AND LEVERAGING BUSINESS RELATIONSHIPS; PROVIDING TEMPORARY USE OF NON-DOWNLOADABLE COMPUTER SOFTWARE FOR DATA MANAGEMENT; PROVIDING SOFTWARE APPLICATION SERVICES TO OTHERS THAT ALLOWS CUSTOMERS TO LEVERAGE BEHAVIORS AND RELATIONSHIPS IN NEGOTIATION WITH A SELLER (U.S. CLS. 100 AND 101).

FIRST USE 1-1-1999; IN COMMERCE 1-1-1999.
AMOS T. MATTHEWS, JR., EXAMINING ATTORNEY

SN 78-736,257. STUDIO 4 NETWORKS, INC., LOS ANGELES, CA. FILED 10-19-2005.

STUDIO 4

THE MARK CONSISTS OF STANDARD CHARACTERS WITHOUT CLAIM TO ANY PARTICULAR FONT, STYLE, SIZE, OR COLOR.

NO CLAIM IS MADE TO THE EXCLUSIVE RIGHT TO USE "STUDIO", APART FROM THE MARK AS SHOWN.

CLASS 38—COMMUNICATION

FOR BROADCASTING SERVICES AND PROVISION OF TELECOMMUNICATION ACCESS TO INSTRUCTIONAL VIDEO AND AUDIO CONTENT IN THE FIELD OF HEALTH, FITNESS, SPORTS, AND SELF DEVELOPMENT VIA TELEVISION, CABLE, SATELLITE AND VIDEO-ON-DEMAND SERVICE (U.S. CLS. 100, 101 AND 104).

FIRST USE 7-1-2003; IN COMMERCE 7-1-2003.

CLASS 41—EDUCATION AND ENTERTAINMENT

FOR PROVISION OF NON-DOWNLOADABLE INSTRUCTIONAL VIDEO PRESENTATIONS AND AUDIO CONTENT IN THE FIELD OF HEALTH, FITNESS, SPORTS, AND SELF-DEVELOPMENT VIA TELEVISION, CABLE, SATELLITE AND VIDEO-ON-DEMAND SERVICE (U.S. CLS. 100, 101 AND 107).

FIRST USE 7-1-2003; IN COMMERCE 7-1-2003.
KATHRYN COWARD, EXAMINING ATTORNEY

SN 78-738,801. ABSOLUTE DATA GROUP PTY LTD, BRISBANE, AUSTRALIA, FILED 10-24-2005.

R4i VIEWER

THE MARK CONSISTS OF STANDARD CHARACTERS WITHOUT CLAIM TO ANY PARTICULAR FONT, STYLE, SIZE, OR COLOR.

PRIORITY CLAIMED UNDER SEC. 44(D) ON AUSTRALIA APPLICATION NO. 1052795, FILED 4-29-2005, REG. NO. 1052795, DATED 4-29-2005, EXPIRES 4-29-2015.

NO CLAIM IS MADE TO THE EXCLUSIVE RIGHT TO USE "VIEWER", APART FROM THE MARK AS SHOWN.

CLASS 9—ELECTRICAL AND SCIENTIFIC APPARATUS

FOR RECORDED COMPUTER OPERATING PROGRAMMES, RECORDED COMPUTER PROGRAMMES FOR THE PRODUCTION OF INTERACTIVE ELECTRONIC TECHNICAL PUBLICATIONS AND ILLUSTRATED PARTS, RECORDED COMPUTER SOFTWARE FOR THE PRODUCTION OF INTERACTIVE ELECTRONIC TECHNICAL PUBLICATIONS AND ILLUSTRATED PARTS; ALL THE AFORESAID BEING FOR STORAGE AND DELIVERY OF CUSTOMER'S INFORMATION TO ENABLE PUBLICATION OF THAT INFORMATION IN MULTIPLE FORMS AND TO ENABLE SUBSEQUENT EFFICIENT REVISION OF THAT PUBLISHED INFORMATION USING STANDARD GENERALIZED MARKUP LANGUAGE SGML AND EXTENSIBLE MARKUP LANGUAGE XML TECHNOLOGIES, BUT EXCLUDING THE DEVELOPMENT OF INTERNET WEB PAGES (U.S. CLS. 21, 23, 26, 36 AND 38).

FIRST USE 5-0-2004; IN COMMERCE 5-2-2005.

CLASS 16—PAPER GOODS AND PRINTED MATTER

FOR PRINTED MATTER BEING TECHNICAL MANUALS (U.S. CLS. 2, 5, 22, 23, 29, 37, 38 AND 50).

FIRST USE 5-0-2004; IN COMMERCE 5-2-2005.

CLASS 42—SCIENTIFIC AND COMPUTER SERVICES

FOR DESIGN, MAINTENANCE AND UPDATING OF COMPUTER SOFTWARE; COMPUTER PROGRAMMING ANALYSIS; ALL THE AFORESAID SERVICES ENABLING THE STORAGE AND DELIVERY OF CUSTOMER'S INFORMATION TO ENABLE PUBLICATION OF THAT INFORMATION IN MULTIPLE FORMS AND TO ENABLE SUBSEQUENT EFFICIENT REVISION OF THAT PUBLISHED INFORMATION USING STANDARD GENERALIZED MARKUP LANGUAGE SGML AND EXTENSIBLE MARKUP LANGUAGE XML TECHNOLOGIES, BUT EXCLUDING THE DEVELOPMENT OF INTERNET WEB PAGES (U.S. CLS. 100 AND 101).

FIRST USE 5-0-2004; IN COMMERCE 5-2-2005.
MARLENE BELL, EXAMINING ATTORNEY

SN 78-746,690. GORDON BROTHERS GROUP, LLC, BOSTON, MA. FILED 11-3-2005.

GORDON BROTHERS INTERNATIONAL

THE MARK CONSISTS OF STANDARD CHARACTERS WITHOUT CLAIM TO ANY PARTICULAR FONT, STYLE, SIZE, OR COLOR.

OWNER OF U.S. REG. NOS. 3,052,167, 3,069,708 AND OTHERS.

NO CLAIM IS MADE TO THE EXCLUSIVE RIGHT TO USE "INTERNATIONAL", APART FROM THE MARK AS SHOWN.

CLASS 35—ADVERTISING AND BUSINESS

FOR BUSINESS MANAGEMENT AND CONSULTING IN THE FIELD OF RETAILING; BUSINESS CONSULTING IN THE FIELD OF RETAILER RESTRUCTURING AND TROUBLESHOOTING; RETAILER BUSINESS PLANNING SERVICES; REAL ESTATE AUCTION SERVICES FOR THE CONSUMER PRODUCTS AND RETAILING INDUSTRIES; BUSINESS APPRAISAL SERVICES FOR THE CONSUMER PRODUCTS AND RETAILING INDUSTRIES, NAMELY, INVENTORY, ASSET AND OPERATIONS VALUATION; INVENTORY LIQUIDATION SERVICES, NAMELY, DISPOSITION AND REDEPLOYMENT OF BUSINESS INVENTORY FOR THE CONSUMER PRODUCTS AND RETAILING INDUSTRIES; BUSINESS LIQUIDATION SERVICES NAMELY, ASSET DISPOSITION AND REDEPLOYMENT SERVICES FOR THE CONSUMER PRODUCTS AND RETAILING INDUSTRIES; LEASE NEGOTIATION IN THE FIELD OF REAL ESTATE, LEASE MANAGEMENT IN THE FIELD OF REAL ESTATE; BUSINESS CONSULTATION SERVICES IN THE FIELD OF LEASE RESTRUCTURING AND DISPOSITION SERVICES FOR THE CONSUMER PRODUCTS AND RETAILING INDUSTRIES (U.S. CLS. 100, 101 AND 102).

FIRST USE 9-0-2004; IN COMMERCE 9-0-2004.

CLASS 36—INSURANCE AND FINANCIAL

FOR BUSINESS LIQUIDATION; REAL ESTATE VALUATION SERVICES; REAL ESTATE CONSULTING; PROVIDING FINANCING FOR OTHERS, NAMELY, COMMERCIAL LENDING AND EQUITY INVESTING FOR THE CONSUMER PRODUCTS AND RETAILING INDUSTRIES (U.S. CLS. 100, 101 AND 102).

FIRST USE 9-0-2004; IN COMMERCE 9-0-2004.
MARLENE BELL, EXAMINING ATTORNEY

SN 78-746,701. GORDON BROTHERS GROUP, LLC, BOSTON, MA. FILED 11-3-2005.

GORDON BROTHERS INDUSTRIAL

THE MARK CONSISTS OF STANDARD CHARACTERS WITHOUT CLAIM TO ANY PARTICULAR FONT, STYLE, SIZE, OR COLOR.

OWNER OF U.S. REG. NOS. 3,052,167, 3,069,708 AND OTHERS.

NO CLAIM IS MADE TO THE EXCLUSIVE RIGHT TO USE "INDUSTRIAL", APART FROM THE MARK AS SHOWN.

CLASS 35—ADVERTISING AND BUSINESS

FOR BUSINESS APPRAISAL SERVICES; BUSINESS LIQUIDATION SERVICES, NAMELY, ASSET DISPOSITION AND REDEPLOYMENT SERVICES FOR THE INDUSTRIAL FIELD (U.S. CLS. 100, 101 AND 102).

CLASS 36—INSURANCE AND FINANCIAL

FOR BUSINESS LIQUIDATION (U.S. CLS. 100, 101 AND 102).

FIRST USE 6-0-2005; IN COMMERCE 6-0-2005.
MARLENE BELL, EXAMINING ATTORNEY

SN 78-747,825. MUCHNIK, BORIS, ROCKVILLE, MD. FILED 11-4-2005.

ACCUHANG

THE MARK CONSISTS OF STANDARD CHARACTERS WITHOUT CLAIM TO ANY PARTICULAR FONT, STYLE, SIZE, OR COLOR.

CLASS 6—METAL GOODS

FOR METAL HARDWARE, NAMELY, PICTURE HANGERS AND BRACKETS; METAL MIRROR HANGERS; METAL PICTURE HANGERS; METAL SHELF BRACKETS AND HANGERS (U.S. CLS. 2, 12, 13, 14, 23, 25 AND 50).

CLASS 9—ELECTRICAL AND SCIENTIFIC APPARATUS

FOR HAND TOOL FOR MEASUREMENT PURPOSES AND FOR SECURING A FASTENER THERETO, INCORPORATING A LEVEL, MARKING DEVICE, AND TOOL FOR ESTABLISHING AND MARKING A POSITION ON A SURFACE FOR IDENTIFYING A POSITION THEREON (U.S. CLS. 21, 23, 26, 36 AND 38).

PATRICIA EVANKO, EXAMINING ATTORNEY

SN 78-755,407. THE OLD MILL-TROY, INC., NORTH TROY, VT. FILED 11-16-2005.

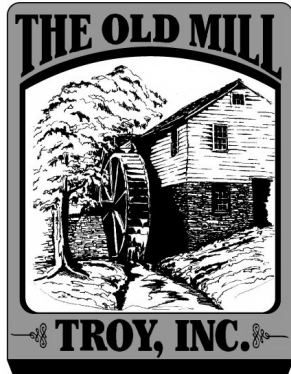

NO CLAIM IS MADE TO THE EXCLUSIVE RIGHT TO USE "TROY, INC.", APART FROM THE MARK AS SHOWN. THE MARK CONSISTS OF A BLACK-AND-WHITE ILLUSTRATION OF A MILL (CONSISTING OF A BRICK-AND-WOOD BARN STRUCTURE, WATER WHEEL, TREE AND STREAM) WITH THE WORDS THE OLD MILL ON TOP AND THE WORDS TROY, INC. ON BOTTOM.

CLASS 5—PHARMACEUTICALS

FOR ANIMAL FEED SUPPLEMENTS; FEED SUPPLEMENTS FOR LIVESTOCK (U.S. CLS. 6, 18, 44, 46, 51 AND 52).
FIRST USE 1-0-1990; IN COMMERCE 1-0-1990.

CLASS 31—NATURAL AGRICULTURAL PRODUCTS

FOR ANIMAL FEED; ANIMAL FEED ADDITIVES FOR NONNUTRITIONAL PURPOSES FOR USE AS FLAVORING, INGREDIENT OR FILLER; MIXED ANIMAL FEED (U.S. CLS. 1 AND 46).
FIRST USE 1-0-1990; IN COMMERCE 1-0-1990.
KATHLEEN M. VANSTON, EXAMINING ATTORNEY

SN 78-761,948. CORE RELATIONS DEVELOPMENT CORP., HENDERSON, NV. FILED 11-28-2005.

Big Huge Brain

THE MARK CONSISTS OF STANDARD CHARACTERS WITHOUT CLAIM TO ANY PARTICULAR FONT, STYLE, SIZE, OR COLOR.

CLASS 9—ELECTRICAL AND SCIENTIFIC APPARATUS

FOR COMPUTER PROGRAMS FOR KNOWLEDGE CORRELATION, NAMELY, KNOWLEDGE DISCOVERY BY MEANS OF ITERATIVE ASSOCIATION AND CHAINING OF INFORMATION FRAGMENTS INTO ANSWERS FOR IMPLEMENTING GLOBAL COMPUTER NETWORK SEARCH ENGINES FOR USE WITH SEARCHABLE DATABASES OF INFORMATION AND DATA, COLLECTION, EDITING ORGANIZING, MODIFYING, BOOK MARKING, TRANSMISSION, STORAGE AND SHARING OF DATA AND INFORMATION THROUGH A GLOBAL COMPUTER NETWORK (U.S. CLS. 21, 23, 26, 36 AND 38).

CLASS 42—SCIENTIFIC AND COMPUTER SERVICES

FOR APPLICATION SERVICE PROVIDER FEATURING SOFTWARE FOR KNOWLEDGE CORRELATION, NAMELY, KNOWLEDGE DISCOVERY BY MEANS OF ITERATIVE ASSOCIATION AND CHAINING OF INFORMATION FRAGMENTS INTO ANSWERS FOR USE WITH GLOBAL COMPUTER NETWORK SEARCH ENGINES, SEARCHABLE DATABASES OF INFORMATION AND DATA, COLLECTION, EDITING ORGANIZING, MODIFYING, BOOK MARKING, TRANSMISSION, STORAGE AND SHARING OF DATA AND INFORMATION THROUGH A GLOBAL COMPUTER NETWORK; AND PROVIDING ONLINE NON-DOWNLOADABLE SOFTWARE FOR KNOWLEDGE CORRELATION, NAMELY, KNOWLEDGE DISCOVERY BY MEANS OF ITERATIVE ASSOCIATION AND CHAINING OF INFORMATION FRAGMENTS INTO ANSWERS FOR USE WITH GLOBAL COMPUTER NETWORK SEARCH ENGINES, SEARCHABLE DATABASES OF INFORMATION AND DATA, COLLECTION, EDITING ORGANIZING, MODIFYING, BOOK MARKING, TRANSMISSION, STORAGE AND SHARING OF DATA AND INFORMATION THROUGH A GLOBAL COMPUTER NETWORK (U.S. CLS. 100 AND 101).
AMY MCMENAMIN, EXAMINING ATTORNEY

SN 78-762,106. CORE RELATIONS DEVELOPMENT CORP., HENDERSON, NV. FILED 11-29-2005.

RXY

THE MARK CONSISTS OF STANDARD CHARACTERS WITHOUT CLAIM TO ANY PARTICULAR FONT, STYLE, SIZE, OR COLOR.

CLASS 9—ELECTRICAL AND SCIENTIFIC APPARATUS

FOR COMPUTER PROGRAMS FOR KNOWLEDGE CORRELATION, NAMELY, KNOWLEDGE DISCOVERY BY MEANS OF ITERATIVE ASSOCIATION AND CHAINING OF INFORMATION FRAGMENTS INTO ANSWERS FOR IMPLEMENTING GLOBAL COMPUTER NETWORK SEARCH ENGINES FOR USE WITH SEARCHABLE DATABASES OF INFORMATION AND DATA, COLLECTION, EDITING ORGANIZING, MODIFYING, BOOK MARKING, TRANSMISSION, STORAGE AND SHARING OF DATA AND INFORMATION THROUGH A GLOBAL COMPUTER NETWORK (U.S. CLS. 21, 23, 26, 36 AND 38).

CLASS 42—SCIENTIFIC AND COMPUTER SERVICES

FOR APPLICATION SERVICE PROVIDER FEATURING SOFTWARE FOR KNOWLEDGE CORRELATION, NAMELY, KNOWLEDGE DISCOVERY BY MEANS OF ITERATIVE ASSOCIATION AND CHAINING OF INFORMATION FRAGMENTS INTO ANSWERS FOR USE WITH GLOBAL COMPUTER NETWORK SEARCH ENGINES, SEARCHABLE DATABASES OF INFORMATION AND DATA, COLLECTION, EDITING ORGANIZING, MODIFYING, BOOK MARKING, TRANSMISSION, STORAGE AND SHARING OF DATA AND INFORMATION THROUGH A GLOBAL COMPUTER NETWORK; AND PROVIDING ONLINE NON-DOWNLOADABLE SOFTWARE FOR KNOWLEDGE CORRELATION, NAMELY, KNOWLEDGE DISCOVERY BY MEANS OF ITERATIVE ASSOCIATION AND CHAINING OF INFORMATION FRAGMENTS INTO ANSWERS FOR USE WITH GLOBAL COMPUTER NETWORK SEARCH ENGINES, SEARCHABLE DATABASES OF INFORMATION AND DATA, COLLECTION, EDITING ORGANIZING, MODIFYING, BOOK MARKING, TRANSMISSION, STORAGE AND SHARING OF DATA AND INFORMATION THROUGH A GLOBAL COMPUTER NETWORK (U.S. CLS. 100 AND 101).

AMY MCMENAMIN, EXAMINING ATTORNEY

SN 78-763,160. CHINESE AMERICAN PLANNING, LTD., DBA TOSHIFILMS, BROOKLYN, NY. FILED 11-30-2005.

A TOSHI PARTY

THE MARK CONSISTS OF STANDARD CHARACTERS WITHOUT CLAIM TO ANY PARTICULAR FONT, STYLE, SIZE, OR COLOR.

NO CLAIM IS MADE TO THE EXCLUSIVE RIGHT TO USE "PARTY", APART FROM THE MARK AS SHOWN.

CLASS 35—ADVERTISING AND BUSINESS

FOR ARRANGING AND CONDUCTING MARKETING PROMOTIONAL EVENTS FOR OTHERS (U.S. CLS. 100, 101 AND 102).

FIRST USE 10-18-1991; IN COMMERCE 10-18-1991.

CLASS 41—EDUCATION AND ENTERTAINMENT

FOR ENTERTAINMENT SERVICES, NAMELY, PARTY PLANNING AND HOSTING, SPECIAL EVENT PLANNING, ENTERTAINMENT IN THE NATURE OF FASHION SHOWS, DISCOTHEQUES, LIVE CONCERT PERFORMANCES, DISC JOCKEYS AND VIDEO JOCKEY SERVICES FOR PARTIES AND SPECIAL EVENTS, VIDEO TAPE AND FILM PRODUCTION, DANCE AND DRAMATIC PERFORMANCES AND PRESENTATION OF MUSICAL PERFORMANCES (U.S. CLS. 100, 101 AND 107).

FIRST USE 10-18-1991; IN COMMERCE 10-18-1991.
LESLEY LAMOTHE, EXAMINING ATTORNEY

SN 78-763,428. CRUISESHIPCENTERS INTERNATIONAL INC., VANCOUVER, CANADA, FILED 11-30-2005.

INTERNATIONAL CRUISE ACADEMY

THE MARK CONSISTS OF STANDARD CHARACTERS WITHOUT CLAIM TO ANY PARTICULAR FONT, STYLE, SIZE, OR COLOR.

PRIORITY CLAIMED UNDER SEC. 44(D) ON CANADA APPLICATION NO. 1,280,494, FILED 11-22-2005.

NO CLAIM IS MADE TO THE EXCLUSIVE RIGHT TO USE "ACADEMY", APART FROM THE MARK AS SHOWN. SEC. 2(F).

CLASS 16—PAPER GOODS AND PRINTED MATTER

FOR PRINTED INSTRUCTIONAL MATERIALS IN THE FIELD OF TRAVEL (U.S. CLS. 2, 5, 22, 23, 29, 37, 38 AND 50).

FIRST USE 0-0-1991; IN COMMERCE 0-0-1997.

CLASS 35—ADVERTISING AND BUSINESS

FOR FRANCHISING, NAMELY, OFFERING TECHNICAL ASSISTANCE IN THE ESTABLISHMENT AND OPERATION OF TRAVEL AGENCIES AND CONSULTATION AND ASSISTANCE IN BUSINESS MANAGEMENT, ORGANIZATION AND PROMOTION (U.S. CLS. 100, 101 AND 102).

FIRST USE 0-0-1991; IN COMMERCE 0-0-1997.

CLASS 41—EDUCATION AND ENTERTAINMENT

FOR EDUCATION SERVICES, NAMELY, THE TRAINING OF INDEPENDENT TRAVEL CONSULTANTS (U.S. CLS. 100, 101 AND 107).

FIRST USE 0-0-1991; IN COMMERCE 0-0-1997.

SUZANNE BLANE, EXAMINING ATTORNEY

SN 78-763,933. TEA GARDEN & HERBAL EMPORIUM L.P., WEST HOLLYWOOD, CA. FILED 11-30-2005.

TEA GARDEN & HERBAL EMPORIUM

THE MARK CONSISTS OF STANDARD CHARACTERS WITHOUT CLAIM TO ANY PARTICULAR FONT, STYLE, SIZE, OR COLOR.

OWNER OF U.S. REG. NOS. 1,661,856 AND 2,851,002.

NO CLAIM IS MADE TO THE EXCLUSIVE RIGHT TO USE "TEA" AND "HERBAL EMPORIUM", APART FROM THE MARK AS SHOWN.

CLASS 5—PHARMACEUTICALS

FOR HERB TEAS FOR MEDICINAL PURPOSES, MEDICINAL HERB EXTRACTS (U.S. CLS. 6, 18, 44, 46, 51 AND 52).

FIRST USE 0-0-1988; IN COMMERCE 0-0-1988.

CLASS 30—STAPLE FOODS

FOR PROCESSED HERBS; TEAS (U.S. CL. 46).
FIRST USE 0-0-1988; IN COMMERCE 0-0-1988.
MICHAEL SOUDERS, EXAMINING ATTORNEY

SN 78-766,076. MIRACLE MEDIA, INC., PRINCETON, NJ.
FILED 12-3-2005.

CLASS 9—ELECTRICAL AND SCIENTIFIC APPARATUS

FOR COMPONENTS FOR EXHAUST GAS EMISSIONS SYSTEMS, NAMELY, CONTROL VALVES USED TO SUPPLY CHEMICAL ADDITIVES TO BOILERS FOR THE PURPOSE OF IMPROVING FLUE GAS CLEANING, AND ELECTRIC CONTROLS FOR OPERATING CHEMICAL STORAGE TANKS, TRANSFER PUMPS, INJECTORS AND CONTROL VALVES (U.S. CLS. 21, 23, 26, 36 AND 38).
ANNE FARRELL, EXAMINING ATTORNEY

BUCKET OF BALLS

THE MARK CONSISTS OF STANDARD CHARACTERS WITHOUT CLAIM TO ANY PARTICULAR FONT, STYLE, SIZE, OR COLOR.

CLASS 9—ELECTRICAL AND SCIENTIFIC APPARATUS

FOR DVDS, VIDEOCASSETTES, CD-ROMS FEATURING TALK SHOW CONTENT; VIDEO GAMES, NAMELY, VIDEO GAME SOFTWARE, VIDEO GAME CARTRIDGES, VIDEO GAME TAPE CASSETTES, VIDEO GAME DISCS, INTERACTIVE VIDEO GAME PROGRAMS (U.S. CLS. 21, 23, 26, 36 AND 38).

SN 78-767,266. FASHIONCRAFT-EXCELLO, INC., SYOSSET, NY. FILED 12-6-2005.

CLASS 41—EDUCATION AND ENTERTAINMENT

FOR ENTERTAINMENT SERVICES, NAMELY, ONGOING TELEVISION PROGRAMS IN THE NATURE OF TALK SHOWS (U.S. CLS. 100, 101 AND 107).
AMY HELLA, EXAMINING ATTORNEY



SN 78-766,712. ALSTOM POWER INC., WINDSOR, CT.
FILED 12-5-2005.

KNX

THE MARK CONSISTS OF STANDARD CHARACTERS WITHOUT CLAIM TO ANY PARTICULAR FONT, STYLE, SIZE, OR COLOR.

CLASS 1—CHEMICALS

FOR CHEMICAL ADDITIVES FOR CONTROLLING MERCURY EMISSIONS IN EXHAUST GAS (U.S. CLS. 1, 5, 6, 10, 26 AND 46).

CLASS 7—MACHINERY

FOR COMPONENTS FOR EXHAUST GAS EMISSIONS CONTROL SYSTEMS, NAMELY, STORAGE TANKS, TRANSFER PUMPS, AND INJECTORS, ALL USED TO SUPPLY CHEMICAL ADDITIVES TO BOILERS FOR THE PURPOSE OF IMPROVING FLUE GAS CLEANING (U.S. CLS. 13, 19, 21, 23, 31, 34 AND 35).

SEC. 2(F).

CLASS 4—LUBRICANTS AND FUELS

FOR CANDLES (U.S. CLS. 1, 6 AND 15).
FIRST USE 12-0-2001; IN COMMERCE 12-0-2001.

CLASS 21—HOUSEWARES AND GLASS

FOR HOUSEHOLD AND KITCHEN UTENSILS, NAMELY, COASTERS NOT MADE OF CLOTH OR PAPER, AND GOBLET RINGS, PACKAGED AND SOLD AS WEDDING GIFTS, WEDDING FAVORS, BRIDAL PARTY GIFTS, ASSORTED WEDDING ACCESSORIES AND/OR GIFT ITEMS (U.S. CLS. 2, 13, 23, 29, 30, 33, 40 AND 50).
FIRST USE 12-0-2003; IN COMMERCE 12-0-2003.
ANGELA M. MICHELI, EXAMINING ATTORNEY

SN 78-767,376. HOLLANDIA INTERNATIONAL THE SLEEP ENGINEERING CENTER INVESTMENTS (1992) LTD., SDEROT, ISRAEL, FILED 12-6-2005.

SN 78-769,989. VEVEO, INC., ANDOVER, MA. FILED 12-9-2005.



PRIORITY CLAIMED UNDER SEC. 44(D) ON ISRAEL APPLICATION NO. 183800, FILED 9-18-2005, REG. NO. 183800, DATED 5-2-2007, EXPIRES 5-2-2014.

PRIORITY CLAIMED UNDER SEC. 44(D) ON ISRAEL APPLICATION NO. 183798, FILED 9-18-2005, REG. NO. 183798, DATED 5-2-2007, EXPIRES 5-2-2014.

NO CLAIM IS MADE TO THE EXCLUSIVE RIGHT TO USE "INTERNATIONAL," "ENGINEERING CENTER", APART FROM THE MARK AS SHOWN.

CLASS 20—FURNITURE AND ARTICLES NOT OTHERWISE CLASSIFIED

FOR FURNITURE, BEDS, COUCHES, SETTEES, SOFAS, MATTRESSES, CUSHIONS, ARMCHAIRS, MIRROR, PICTURE FRAMES NOT OF PRECIOUS METAL (U.S. CLS. 2, 13, 22, 25, 32 AND 50).

CLASS 35—ADVERTISING AND BUSINESS

FOR RETAIL STORE AND RETAIL CHAIN STORE SERVICES; WHOLESALE SERVICES, NAMELY STORE DISTRIBUTORSHIP SERVICES; ADVERTISING AND MARKETING; BUSINESS MANAGEMENT; BUSINESS ADMINISTRATION; SALES PROMOTION SERVICES; IMPORT AND EXPORT AGENCY; BUSINESS CONSULTING; ELECTRONIC RETAILING SERVICES VIA COMPUTER; COMMERCIAL INFORMATION AGENCIES, ALL IN THE FIELD OF FURNITURE PRODUCTS, BEDS, MATTRESSES, SOFAS, ARMCHAIRS, MIRRORS, HOUSEHOLD AND KITCHEN GOODS AND RELATED ACCESSORIES (U.S. CLS. 100, 101 AND 102).

SARA THOMAS, EXAMINING ATTORNEY

SN 78-769,821. CTG ATHLETICS, LLC, BRONX, NY. FILED 12-8-2005.



CLASS 25—CLOTHING

FOR SHIRTS, SPORTS BRAS, LEGGINGS, SOCKS AND HEADBANDS (U.S. CLS. 22 AND 39).

CLASS 28—TOYS AND SPORTING GOODS

FOR SPORT EQUIPMENT BAGS, BASKETBALL BAGS, BASEBALL BAGS (U.S. CLS. 22, 23, 38 AND 50).

GEORGIA CARTY, EXAMINING ATTORNEY

INNOVATION AT YOUR FINGERTIPS

THE MARK CONSISTS OF STANDARD CHARACTERS WITHOUT CLAIM TO ANY PARTICULAR FONT, STYLE, SIZE, OR COLOR.

CLASS 38—COMMUNICATION

FOR PROVIDING ACCESS TO GLOBAL COMMUNICATIONS NETWORKS, TELECOMMUNICATIONS NETWORKS, VIDEO DISTRIBUTION NETWORKS, LAND-LINE, MOBILE TELECOMMUNICATION NETWORKS AND DATABASES FOR THE TRANSFER AND DISSEMINATION OF AUDIO, VIDEO, TEXT, AND MULTIMEDIA CONTENT (U.S. CLS. 100, 101 AND 104).

CLASS 42—SCIENTIFIC AND COMPUTER SERVICES

FOR COMPUTER SOFTWARE AND HARDWARE CONSULTATION SERVICES; CUSTOM COMPUTER SOFTWARE AND HARDWARE DESIGN AND DEVELOPMENT SERVICES FOR OTHERS; PORTING, NAMELY, MODIFYING COMPUTER SOFTWARE TO RUN ON A DIFFERENT COMPUTER OPERATING SYSTEM FOR OTHERS (U.S. CLS. 100 AND 101).

JOSETTE BEVERLY, EXAMINING ATTORNEY

SN 78-770,364. NASH, INC., LEXINGTON, KY. FILED 12-9-2005.

NASH

THE MARK CONSISTS OF STANDARD CHARACTERS WITHOUT CLAIM TO ANY PARTICULAR FONT, STYLE, SIZE, OR COLOR.

CLASS 3—COSMETICS AND CLEANING PREPARATIONS

FOR NON-MEDICATED GROOMING PREPARATIONS FOR PETS, NAMELY, SHAMPOOS, COAT AND SKIN CONDITIONERS, COLORANTS, FINISHING SPRAYS, NAIL CARE PREPARATIONS, BREATH FRESHENERS, AND TOOTHPASTES (U.S. CLS. 1, 4, 6, 50, 51 AND 52).

CLASS 5—PHARMACEUTICALS

FOR MEDICATED GROOMING PREPARATIONS FOR PETS, NAMELY, FLEA AND TICK COAT SPRAYS, ANTI-BACTERIAL SPRAYS AND POWDERS FOR CLEANING EARS, EYE WASHES, AND MEDICATED ANTIBIOTIC AND ANALGESIC PAD CREAMS (U.S. CLS. 6, 18, 44, 46, 51 AND 52).

CLASS 21—HOUSEWARES AND GLASS

FOR PET GROOMING IMPLEMENTS, NAMELY, BRUSHES, COMBS, SNAP ON COMBS FOR CLIPPERS, PET GROOMING DEVICES COMPRISING A BUILT-IN BRUSH HEAD AND ATTACHMENT THAT CONNECTS TO VACUUMS, AND TOOTHBRUSHES (U.S. CLS. 2, 13, 23, 29, 30, 33, 40 AND 50).

CLASS 35—ADVERTISING AND BUSINESS

FOR FRANCHISE SERVICES, NAMELY, OFFERING TECHNICAL AND BUSINESS MANAGEMENT ASSISTANCE IN THE ESTABLISHMENT AND OPERATION OF ANIMAL GROOMING BUSINESSES (U.S. CLS. 100, 101 AND 102).

CLASS 41—EDUCATION AND ENTERTAINMENT

FOR EDUCATIONAL SERVICES, NAMELY, CONDUCTING CLASSROOM INSTRUCTION AND PROVIDING ONLINE INSTRUCTION IN THE FIELDS OF ANIMAL GROOMING, ANIMAL HANDLING, ANIMAL CARE, AND ANIMAL BREEDING, AND IN THE FIELD OF JUDGING OF SHOW ANIMALS (U.S. CLS. 100, 101 AND 107).

CLASS 43—HOTEL AND RESTAURANT SERVICES

FOR ANIMAL BOARDING SERVICES (U.S. CLS. 100 AND 101).

CLASS 44—MEDICAL, BEAUTY AND AGRICULTURAL SERVICES

FOR ANIMAL GROOMING SERVICES (U.S. CLS. 100 AND 101).
LINDA ESTRADA, EXAMINING ATTORNEY

SN 78-777,194. SONCO WORLDWIDE INC., BLADENSBURG, MD. FILED 12-20-2005.

LONGEVITY VINYL

THE MARK CONSISTS OF STANDARD CHARACTERS WITHOUT CLAIM TO ANY PARTICULAR FONT, STYLE, SIZE, OR COLOR.

NO CLAIM IS MADE TO THE EXCLUSIVE RIGHT TO USE "VINYL", APART FROM THE MARK AS SHOWN.

CLASS 19—NON-METALLIC BUILDING MATERIALS

FOR PVC FENCING; PVC FENCING PRODUCTS, NAMELY, FENCE PANEL SECTIONS, POSTS AND GATES (U.S. CLS. 1, 12, 33 AND 50).

CLASS 20—FURNITURE AND ARTICLES NOT OTHERWISE CLASSIFIED

FOR PVC FENCING ACCESSORIES, NAMELY, PVC CAPS, HINGES, SCREWS AND LATCHES (U.S. CLS. 2, 13, 22, 25, 32 AND 50).
JASON BLAIR, EXAMINING ATTORNEY

SN 78-778,491. DR. LEONARD'S HEALTHCARE CORP., EDISON, NJ. FILED 12-21-2005.

DR. LEONARD'S

THE MARK CONSISTS OF STANDARD CHARACTERS WITHOUT CLAIM TO ANY PARTICULAR FONT, STYLE, SIZE, OR COLOR.

OWNER OF U.S. REG. NO. 1,818,850.

THE NAME SHOWN IN THE MARK DOES NOT IDENTIFY A PARTICULAR LIVING INDIVIDUAL.

CLASS 5—PHARMACEUTICALS

FOR INGESTIBLE ITEMS, NAMELY, DIETARY SUPPLEMENTS, VITAMINS, AND MINERAL SUPPLEMENTS; PAIN RELIEF MEDICATION; AND JOINT COMPOUNDS FOR MEDICAL USE (U.S. CLS. 6, 18, 44, 46, 51 AND 52).

CLASS 25—CLOTHING

FOR CLOTHING, NAMELY, SHOES, SOCKS, HOSIERY (U.S. CLS. 22 AND 39).

TINA L. SNAPP, EXAMINING ATTORNEY

SN 78-781,051. JOHNSBYRNE COMPANY, NILES, IL. FILED 12-27-2005.

Graphic Technologies
A JOHNSBYRNE COMPANY

NO CLAIM IS MADE TO THE EXCLUSIVE RIGHT TO USE "GRAPHIC TECHNOLOGIES" AND "COMPANY", APART FROM THE MARK AS SHOWN.

"THE MARK CONSISTS OF THE STYLIZED WORDS GRAPHIC TECHNOLOGIES A JOHNSBYRNE COMPANY IN WHICH THE WORD GRAPHIC APPEARS IN THE COLOR GRAY AND THE REMAINING WORDS APPEAR IN THE COLOR BLACK."

CLASS 40—MATERIAL TREATMENT

FOR PRINTING SERVICES; SPECIALTY PRINTING AND FINISHING SERVICES, NAMELY BINDERY SERVICES FOR MATERIALS PRINTED ON AND CONSISTING OF PAPER, PLASTIC AND OTHER PAPERBOARD MATERIALS CONSISTING OF HOT STAMPING, FOIL STAMPING, EMBOSsing, MOUNTING, DIE-CUTTING, SLITTING, COLLATING, PADDING, FOLDING, GLUING, ASSEMBLY, FILM LAMINATING, WINDOW PATCHING AND BINDING OF PRINTED MATERIALS (U.S. CLS. 100, 103 AND 106).

CLASS 42—SCIENTIFIC AND COMPUTER SERVICES

FOR GRAPHIC DESIGN SERVICES, NAMELY, STRUCTURAL DESIGN AND PROJECT ENGINEERING SERVICES FOR PRINTING AND FINISHING SERVICES (U.S. CLS. 100 AND 101).

JOSETTE BEVERLY, EXAMINING ATTORNEY

SN 78-781,269. ROLLING ACRES LANDSCAPE, INC., BRINKOW, MD. FILED 12-27-2005.

SN 78-782,953. LF, LLC, WILMINGTON, DE. FILED 12-30-2005.

ROLLING ACRES LANDSCAPE /
NURSERY



THE MARK CONSISTS OF STANDARD CHARACTERS WITHOUT CLAIM TO ANY PARTICULAR FONT, STYLE, SIZE, OR COLOR.

NO CLAIM IS MADE TO THE EXCLUSIVE RIGHT TO USE "LANDSCAPE" AND "NURSERY", APART FROM THE MARK AS SHOWN.

CLASS 35—ADVERTISING AND BUSINESS

FOR RETAIL AND WHOLESALE NURSERY STORE SERVICES (U.S. CLS. 100, 101 AND 102).

FIRST USE 9-30-1987, THE MARK WAS FIRST USED ANYWHERE IN A DIFFERENT FORM OTHER THAN THAT SOUGHT TO BE REGISTERED ON 10/31/1981.; IN COMMERCE 9-30-1987, THE MARK WAS FIRST USED IN COMMERCE IN A DIFFERENT FORM OTHER THAN THAT SOUGHT TO BE REGISTERED ON 10/31/1981..

CLASS 37—CONSTRUCTION AND REPAIR

FOR LANDSCAPE CONSTRUCTION (U.S. CLS. 100, 103 AND 106).

FIRST USE 9-30-1987, THE MARK WAS FIRST USED ANYWHERE IN A DIFFERENT FORM OTHER THAN THAT SOUGHT TO BE REGISTERED ON 10/31/1981.; IN COMMERCE 9-30-1987, THE MARK WAS FIRST USED IN COMMERCE IN A DIFFERENT FORM OTHER THAN THAT SOUGHT TO BE REGISTERED ON 10/31/1981..

CLASS 42—SCIENTIFIC AND COMPUTER SERVICES

FOR LANDSCAPE ARCHITECTURAL DESIGN (U.S. CLS. 100 AND 101).

FIRST USE 9-30-1987, THE MARK WAS FIRST USED ANYWHERE IN A DIFFERENT FORM OTHER THAN THAT SOUGHT TO BE REGISTERED ON 10/31/1981.; IN COMMERCE 9-30-1987, THE MARK WAS FIRST USED IN COMMERCE IN A DIFFERENT FORM OTHER THAN THAT SOUGHT TO BE REGISTERED ON 10/31/1981..

CLASS 44—MEDICAL, BEAUTY AND AGRICULTURAL SERVICES

FOR LANDSCAPING SERVICES FOR OTHERS, NAMELY, GARDENING DESIGN, PREPARATION, PLANTING AND INSTALLATION OF PLANTS IN LANDSCAPE SITES; HORTICULTURAL SERVICES, NAMELY, TREATMENT, MANAGEMENT AND MAINTENANCE OF LAWNS, TREES, SHRUBS, GARDENS AND LANDSCAPING (U.S. CLS. 100 AND 101).

FIRST USE 9-30-1987, THE MARK WAS FIRST USED ANYWHERE IN A DIFFERENT FORM OTHER THAN THAT SOUGHT TO BE REGISTERED ON 10/31/1981.; IN COMMERCE 9-30-1987, THE MARK WAS FIRST USED IN COMMERCE IN A DIFFERENT FORM OTHER THAN THAT SOUGHT TO BE REGISTERED ON 10/31/1981..
JENNY PARK, EXAMINING ATTORNEY

OWNER OF U.S. REG. NOS. 2,527,806, 3,019,629 AND 3,053,757.

THE STIPPLING IS A FEATURE OF THE MARK.
THE MARK CONSISTS OF THE WORD "PORTFOLIO" IN CAPITAL LETTERS APPEARING IN A SHADED RECTANGLE WITH THE FINAL LETTER "O" HAVING STIPPLING INSIDE.

CLASS 4—LUBRICANTS AND FUELS

FOR METAL BOTTLE ADAPTERS, NAMELY, METAL CAPS WITH WICKS USED TO CONVERT BOTTLES TO CANDLES (U.S. CLS. 1, 6 AND 15).

CLASS 6—METAL GOODS

FOR METAL REPLACEMENT PARTS FOR ELECTRICAL LIGHTING PRODUCTS, NAMELY, CHAINS, LOCK NUTS, LOCK-UP CAPS, CROSSBARS, BALLS, METAL SCREWS, COLLARS, NUTS, WASHERS, COUPLINGS, DETACHABLE HARPS, LOOPS, AND NIPPLES; METAL HARDWARE CANOPY KITS FOR LIGHTING, COMPRISED OF CENTER HOLE CANOPY, CENTER HOLE PLUG, MALE LOOP, CROSSBAR, SCREWS AND NUTS; BLANK-UP METAL HARDWARE KITS COMPRISED OF METAL RECEPTACLE BOX COVER AND SCREWS, RINGS, AND SOCKET KEYS FOR USE WITH CEILING RECEPTACLES; SWAG LIGHT METAL HARDWARE KITS COMPRISED OF FIXTURE CHAIN, FIXTURE WIRE AND SWAG HOOK; METAL WIRE COVERS, DECORATIVE PENDANTS FOR USE WITH ELECTRICAL LIGHTING PRODUCTS; METAL LIGHTING FIXTURE REPAIR KITS COMPRISED OF SCREWS AND NUTS; METAL CEILING LIGHT REPAIR KITS COMPRISED OF SCREWS, NUTS, LOOPS, AND CROSSBAR; LAMP SHADE RISERS, METAL KNOBS (U.S. CLS. 2, 12, 13, 14, 23, 25 AND 50).

CLASS 9—ELECTRICAL AND SCIENTIFIC APPARATUS

FOR ELECTRICAL OUTLET CONCEALERS; ELECTRICAL ACCESSORIES AND PARTS FOR DIMMERS AND TIMERS, NAMELY, REMOTE CONTROLS, DIMMERS, ADAPTERS, LIGHTING CONTROL DEVICES CONSISTING OF DIMMING BALLAST, CONSOLES, CONTROL PANELS, AND WALL MOUNT KITS COMPRISED OF SPLICE PANELS; PROGRAMMABLE TIMERS; ELECTRICAL DOOR BELLS AND DOOR CHIMES; ADAPTERS; ELECTRICAL SOCKETS; SOCKET COVERS; SOCKET CORD KITS COMPRISED OF LAMP CORD AND ATTACHED PLUG; ELECTRICAL CONNECTORS; ELECTRICAL SWITCHES; HALOGEN ELECTRICAL LIGHT DIMMERS (U.S. CLS. 21, 23, 26, 36 AND 38).

CLASS 11—ENVIRONMENTAL CONTROL APPARATUS

FOR ELECTRICAL LIGHT FIXTURES FOR WALLS AND BATHROOMS; LAMPS AND LAMPSHADES; LAMP AND LIGHTING ACCESSORIES, NAMELY, SWAGS, PULLS, PULL CHAINS AND FINIALS; CHANDELIER FIXTURE CHAINS, PENDANTS AND GLOBES; CEILING FIXTURES, NAMELY, CHANDELIERS; INDOOR AND OUTDOOR ELECTRICAL LANTERNS AND LIGHTING FIXTURES; ELECTRIC NIGHT LIGHTS, BATTERY-OPERATED ALL PURPOSE LIGHTS, FLASHLIGHTS, CLOSET LIGHTS, UTILITY LIGHTS, EMERGENCY POWER FAILURE LIGHTS, AND TOUCH LIGHTS; LIGHT BULBS; LIGHTING ACCESSORIES AND PARTS FOR OUTDOOR AND INDOOR LIGHTING, NAMELY, POST EYES CONSISTING OF LIGHTING FIXTURES THAT CAN BE MOUNTED TO A POLE AND THAT ROTATE IN VARIOUS DIRECTIONS, AND SWIVEL EYES CONSISTING OF LIGHTING FIXTURES THAT CAN BE MOUNTED TO CEILINGS AND THAT ROTATE IN VARIOUS DIRECTIONS; ACCENT LIGHTING FIXTURES FOR HOME INTERIORS AND EXTERIORS; PORTABLE LIGHTING, NAMELY, SPOTLIGHTS, FLUORESCENT LIGHTS, HALOGEN LIGHTS, INCANDESCENT LIGHTS, AND WORK LIGHTS; ELECTRIC CABLE LIGHTING FIXTURES; LAMP PIPES; ELECTRIFIED CANDLESTICKS (U.S. CLS. 13, 21, 23, 31 AND 34).

CLASS 19—NON-METALLIC BUILDING MATERIALS

FOR NON-METAL CEILING MEDALLIONS (U.S. CLS. 1, 12, 33 AND 50).

CLASS 20—FURNITURE AND ARTICLES NOT OTHERWISE CLASSIFIED

FOR PLASTIC LOCK-UP CAPS, NON-METAL SCREWS, NON-METAL NUTS, WASHERS OF PLASTIC USED TO TIGHTEN JOINTS AND SCREWS, NON-METAL HOOKS, NON-METAL WINDOW SHADE RISERS, OUTLET CONCEALERS, AND KITS COMPRISED OF THE FOREGOING; NON-METAL LIGHTING FIXTURE REPAIR KITS COMPRISED OF SCREWS AND NUTS; NON-METAL CEILING LIGHT REPAIR KITS COMPRISED OF SCREWS, NUTS, LOOPS, AND CROSS-BAR (U.S. CLS. 2, 13, 22, 25, 32 AND 50).

CLASS 22—CORDAGE AND FIBERS

FOR CANVAS CANOPY KITS COMPRISED OF CENTER HOLE CANOPY, CENTER HOLE PLUG, MALE LOOP, CROSS BAR, SCREWS AND NUTS, SOLD TOGETHER AS A UNIT (U.S. CLS. 1, 2, 7, 19, 22, 42 AND 50).

CLASS 37—CONSTRUCTION AND REPAIR

FOR INSTALLATION OF LIGHTING AND REPAIR OF LIGHTING (U.S. CLS. 100, 103 AND 106).
LAURA KOVALSKY, EXAMINING ATTORNEY

SN 78-783,093. 4POYNTZ DEZIGN INC, OTTAWA ONTARIO, CANADA, FILED 12-30-2005.

4POYNTZ DEZIGN

THE MARK CONSISTS OF STANDARD CHARACTERS WITHOUT CLAIM TO ANY PARTICULAR FONT, STYLE, SIZE, OR COLOR.

PRIORITY CLAIMED UNDER SEC. 44(D) ON CANADA APPLICATION NO. 1263286, FILED 6-30-2005, REG. NO. TMA693091, DATED 7-31-2007, EXPIRES 7-31-2022.

NO CLAIM IS MADE TO THE EXCLUSIVE RIGHT TO USE "DESIGN", APART FROM THE MARK AS SHOWN.

CLASS 9—ELECTRICAL AND SCIENTIFIC APPARATUS

FOR COMPUTER SOFTWARE FOR USE IN THE MANAGEMENT OF ONLINE CONTENT, NAMELY, WEB TOOLS TO ENABLE THE CREATION, EDITING AND MANAGEMENT OF WEBSITES WITHOUT THIRD PARTY ASSISTANCE (U.S. CLS. 21, 23, 26, 36 AND 38).

CLASS 35—ADVERTISING AND BUSINESS

FOR MARKETING AND COMMUNICATION SERVICES FOR OTHERS, NAMELY, PUBLIC RELATIONS AND CREATING BRAND IDENTITY FOR OTHERS (U.S. CLS. 100, 101 AND 102).

CLASS 42—SCIENTIFIC AND COMPUTER SERVICES

FOR GRAPHIC DESIGN, WEB SITE DEVELOPMENT AND HOSTING (U.S. CLS. 100 AND 101).
CHRISTOPHER OTT, EXAMINING ATTORNEY

SN 78-784,939. ERAVITA, INC., PLEASANT HILL, CA. FILED 1-4-2006.

STORY OF MY LIFE BY ERAVITA

THE MARK CONSISTS OF STANDARD CHARACTERS WITHOUT CLAIM TO ANY PARTICULAR FONT, STYLE, SIZE, OR COLOR.

THE NAME ERAVITA DOES NOT IDENTIFY A LIVING INDIVIDUAL.

CLASS 42—SCIENTIFIC AND COMPUTER SERVICES

FOR APPLICATION SERVICE PROVIDER (ASP), NAMELY, HOSTING COMPUTER SOFTWARE APPLICATIONS OF OTHERS THAT ENABLES FAMILIES AND INDIVIDUALS TO CREATE, DISPLAY, SHARE AND STORE DATA AND INFORMATION IN THE FIELD OF GENEALOGY, INCLUDING FAMILY HISTORIES, AUTOBIOGRAPHIES, BIOGRAPHIES AND HISTORICAL RECORDS; HOSTING OF DIGITAL CONTENT ON THE INTERNET IN THE NATURE OF PHOTOS, PHOTO ALBUMS, IMAGES, AND OTHER CONTENT RELATING TO GENEALOGY, INCLUDING FAMILY HISTORIES, AUTOBIOGRAPHIES, BIOGRAPHIES AND HISTORICAL RECORDS (U.S. CLS. 100 AND 101).

CLASS 45—PERSONAL AND LEGAL SERVICES

FOR PROVIDING AN ONLINE DATABASE FEATURING INFORMATION, PHOTOS, PHOTO ALBUMS, IMAGES, AND OTHER DATA IN THE FIELD OF GENEALOGY, INCLUDING FAMILY HISTORIES, AUTOBIOGRAPHIES, BIOGRAPHIES AND HISTORICAL RECORDS; PROVIDING GENEALOGICAL INFORMATION RELATING TO FAMILY HISTORIES, AUTOBIOGRAPHIES, BIOGRAPHIES AND HISTORICAL RECORDS (U.S. CLS. 100 AND 101).

NICHOLAS ALTREE, EXAMINING ATTORNEY

SN 78-785,476. CURTIS, THOMAS F., BETHESDA, MD. FILED 1-5-2006.

TOMMY THE MATCHMAKER

THE MARK CONSISTS OF STANDARD CHARACTERS WITHOUT CLAIM TO ANY PARTICULAR FONT, STYLE, SIZE, OR COLOR.

NO CLAIM IS MADE TO THE EXCLUSIVE RIGHT TO USE "THE MATCHMAKER", APART FROM THE MARK AS SHOWN.

SN 78-784,963. ERAVITA, INC., PLEASANT HILL, CA. FILED 1-4-2006.

ERAVITA

THE MARK CONSISTS OF STANDARD CHARACTERS WITHOUT CLAIM TO ANY PARTICULAR FONT, STYLE, SIZE, OR COLOR.

CLASS 41—EDUCATION AND ENTERTAINMENT

FOR AUDIO RECORDING AND PRODUCTION SERVICES; VIDEOTAPE AND VIDEODISC RECORDING AND PRODUCTION SERVICES; MOTION PICTURE FILM PRODUCTION SERVICES FEATURING GENEALOGICAL DOCUMENTARIES, BIOGRAPHIES AND AUTOBIOGRAPHIES (U.S. CLS. 100, 101 AND 107).

CLASS 42—SCIENTIFIC AND COMPUTER SERVICES

FOR APPLICATION SERVICE PROVIDER (ASP), NAMELY, HOSTING COMPUTER SOFTWARE APPLICATIONS OF OTHERS THAT ENABLES FAMILIES AND INDIVIDUALS TO CREATE, DISPLAY, SHARE AND STORE DATA AND INFORMATION IN THE FIELD OF GENEALOGY, INCLUDING FAMILY HISTORIES, AUTOBIOGRAPHIES, BIOGRAPHIES AND HISTORICAL RECORDS; HOSTING OF DIGITAL CONTENT ON THE INTERNET IN THE NATURE OF PHOTOS, PHOTO ALBUMS, IMAGES, AND OTHER CONTENT RELATING TO GENEALOGY, INCLUDING FAMILY HISTORIES, AUTOBIOGRAPHIES, BIOGRAPHIES AND HISTORICAL RECORDS (U.S. CLS. 100 AND 101).

CLASS 45—PERSONAL AND LEGAL SERVICES

FOR PROVIDING AN ONLINE DATABASE FEATURING INFORMATION, PHOTOS, PHOTO ALBUMS, IMAGES, AND OTHER DATA IN THE FIELD OF GENEALOGY, INCLUDING FAMILY HISTORIES, AUTOBIOGRAPHIES, BIOGRAPHIES AND HISTORICAL RECORDS; PROVIDING GENEALOGICAL INFORMATION RELATING TO FAMILY HISTORIES, AUTOBIOGRAPHIES, BIOGRAPHIES AND HISTORICAL RECORDS (U.S. CLS. 100 AND 101).

NICHOLAS ALTREE, EXAMINING ATTORNEY

CLASS 14—JEWELRY

FOR JEWELRY (U.S. CLS. 2, 27, 28 AND 50).

CLASS 35—ADVERTISING AND BUSINESS

FOR PRODUCING AUDIO OR VIDEO INFOMERCIALS; PRODUCING COMMERCIALS; AND PROMOTING THE GOODS, SERVICES, BRAND IDENTITY AND COMMERCIAL INFORMATION AND NEWS OF THIRD PARTIES THROUGH LIVE PERFORMANCES AND THROUGH PRINT, AUDIO, VIDEO AND ONLINE MEDIUM (U.S. CLS. 100, 101 AND 102).

FIRST USE 0-0-1989; IN COMMERCE 0-0-1989.

CLASS 41—EDUCATION AND ENTERTAINMENT

FOR ENTERTAINMENT SERVICES; NAMELY, PERSONAL APPEARANCES BY A CELEBRITY; LIVE PERFORMANCES BY A PROFESSIONAL ENTERTAINER; HOSTING DANCE SHOWS; NIGHTCLUB SERVICES; PRODUCING FILMS; PROVIDING RADIO ADVICE IN THE FIELD OF DATING AND MATCHMAKING; LIVE MULTIMEDIA APPEARANCES BY A CELEBRITY (U.S. CLS. 100, 101 AND 107).

FIRST USE 0-0-1989; IN COMMERCE 0-0-1989.

CLASS 45—PERSONAL AND LEGAL SERVICES

FOR DATING AND MATCHMAKING SERVICES (U.S. CLS. 100 AND 101).

FIRST USE 0-0-1989; IN COMMERCE 0-0-1989.

TARAH HARDY, EXAMINING ATTORNEY

SN 78-786,496. GREENSTEIN, MARK A., BETHESDA, MD. FILED 1-6-2006.

SAAFER

THE MARK CONSISTS OF STANDARD CHARACTERS WITHOUT CLAIM TO ANY PARTICULAR FONT, STYLE, SIZE, OR COLOR.

CLASS 35—ADVERTISING AND BUSINESS

FOR DATA COMPILING AND ANALYZING IN THE FINANCIAL FIELD, NAMELY, COLLECTION AND RETENTION OF DATA AND INFORMATION NECESSARY TO MAKE AND OR DETERMINE DEDUCTIONS FROM AND INVESTMENT OF WAGES, INCOME, ACCOUNTS, FUNDS, CAPITAL OR OTHER SOURCES OF MONETARY VALUE (U.S. CLS. 100, 101 AND 102).

CLASS 36—INSURANCE AND FINANCIAL

FOR FINANCIAL PLANNING, NAMELY, ADMINISTRATION OF APPROPRIATE SAVINGS LEVELS AND ALLOCATIONS OF WAGES, INCOME, ACCOUNTS, FUNDS, CAPITAL OR OTHER SOURCES OF MONETARY VALUE, FOR FINANCIAL INVESTMENT PURPOSES; INVESTMENT MANAGEMENT, NAMELY, ALLOCATION OF WAGES, INCOME, ACCOUNTS, FUNDS, CAPITAL OR OTHER SOURCES OF MONETARY VALUE, FOR FINANCIAL INVESTMENT PURPOSES (U.S. CLS. 100, 101 AND 102).

CLASS 42—SCIENTIFIC AND COMPUTER SERVICES

FOR COMPUTER SOFTWARE CONSULTATION SERVICES, NAMELY, CONSULTATION SERVICES RELATED TO COMPUTER SOFTWARE THAT COORDINATES THE CONTRIBUTIONS TO AND MANAGEMENT OF AMOUNTS DEDICATED TO FINANCIAL INVESTMENT OBJECTIVES (U.S. CLS. 100 AND 101).

TONI HICKEY, EXAMINING ATTORNEY

SN 78-787,558. THUNDER IN THE VALLEY OUTREACH, INC., DOUGLASSVILLE, PA. FILED 1-9-2006.

THUNDER OUTREACH

THE MARK CONSISTS OF STANDARD CHARACTERS WITHOUT CLAIM TO ANY PARTICULAR FONT, STYLE, SIZE, OR COLOR.

NO CLAIM IS MADE TO THE EXCLUSIVE RIGHT TO USE "OUTREACH", APART FROM THE MARK AS SHOWN.

CLASS 36—INSURANCE AND FINANCIAL

FOR CHARITABLE FUND RAISING; CONSULTATION SERVICES FOR PERSONNEL AND MEMBERS OF NONPROFITS RELATING TO CHARITABLE FUND RAISING, ORGANIZING, MANAGING AND COLLECTION OF FUNDS AND ITEMS FOR DISTRIBUTION TO NEEDY INDIVIDUALS (U.S. CLS. 100, 101 AND 102).

CLASS 41—EDUCATION AND ENTERTAINMENT

FOR TRAINING PERSONNEL AND MEMBERS OF NONPROFITS RELATING TO CHARITABLE FUND RAISING, ORGANIZING, MANAGING AND COLLECTION OF FUNDS AND ITEMS FOR DISTRIBUTION TO NEEDY INDIVIDUALS (U.S. CLS. 100, 101 AND 107).

AMOS T. MATTHEWS, JR., EXAMINING ATTORNEY

SN 78-790,791. NGUYEN, DAVID SON, IRVINE, CA. FILED 1-12-2006.



THE COLOR(S) YELLOW, RED, WHITE, BROWN, YELLOW/GOLD, BLACK AND RED IS/ARE CLAIMED AS A FEATURE OF THE MARK.

THE FLAMES COMPRISING THE WORD VIET ARE COLORED YELLOW AND RED; THE DRAGON FORMING THE WORD ROCK CONSISTS OF A BROWN BODY WITH YELLOW / GOLD EDGES, WHITE TEETH, BLACK CLAWS AND A RED TONGUE.

THE MARK CONSISTS OF THE TEXT VIET SYMBOLIZED IN THE RED, WHITE AND YELLOW FLAME AND THE TEXT ROCK SYMBOLIZED BY THE WHITE, YELLOW, RED AND BLACK DRAGON

CLASS 9—ELECTRICAL AND SCIENTIFIC APPARATUS

FOR (BASED ON USE) MUSIC AND MUSICAL PERFORMANCES RECORDED ON THE VIDEO TAPES, CD'S AND DVD'S (U.S. CLS. 21, 23, 26, 36 AND 38).

FIRST USE 2-2-2004; IN COMMERCE 3-19-2004.

CLASS 15—MUSICAL INSTRUMENTS

FOR (BASED ON INTENT TO USE) ACOUSTIC GUITARS; ELECTRIC GUITARS; GUITARS (U.S. CLS. 2, 21 AND 36).

JOHN SCHUYLER YARD, EXAMINING ATTORNEY

SN 78-796,921. REJUVEDENT, LLC, QUINCY, MA. FILED 1-23-2006.

REJUVEDENT

THE MARK CONSISTS OF STANDARD CHARACTERS WITHOUT CLAIM TO ANY PARTICULAR FONT, STYLE, SIZE, OR COLOR.

CLASS 3—COSMETICS AND CLEANING PREPARATIONS

FOR TOOTH WHITENING PREPARATIONS (U.S. CLS. 1, 4, 6, 50, 51 AND 52).

CLASS 5—PHARMACEUTICALS

FOR DENTAL RESTORATION COMPOUNDS FOR USE IN TOOTH ETCHING, CONDITIONING AND REMINERALIZATION; SEALING AGENTS FOR DENTAL PURPOSES, NAMELY DENTIN DESENSITIZERS; MATERIALS FOR DENTAL FILLINGS AND FOR SEALING PURPOSES; DENTAL VENEERS; DENTAL POLISH; PIT AND FISSURE SEALANTS FOR DENTAL AND DENTAL TECHNICAL PURPOSES; DENTAL HYBRID COMPOSITE MATERIALS; DENTAL CERAMICS; BONDING AND PRIMER MATERIALS FOR DENTAL PURPOSE; TOPICAL GEL FOR MEDICAL AND THERAPEUTIC TREATMENT OF DENTAL HARD AND SOFT TISSUES (U.S. CLS. 6, 18, 44, 46, 51 AND 52).

CLASS 10—MEDICAL APPARATUS

FOR DENTAL APPARATUS, DEVICES AND INSTRUMENTS, NAMELY, DENTAL HANDPIECES AND PROSTHETIC INSTRUMENTS FOR DENTAL PURPOSES; LASERS FOR DENTAL USE; GOODS RELATED TO LASERS FOR DENTAL USE, NAMELY, HANDPIECES, TIPS, AND CABLES; INTRA-ORAL DENTAL LIGHT SYSTEM; APPARATUS FOR DETECTING DENTAL CARIES; DENTAL BITE TRAYS; DENTAL INSTRUMENTS, NAMELY, DISPOSABLE PROPHYLAXIS ANGLES (U.S. CLS. 26, 39 AND 44).

DAWN HAN, EXAMINING ATTORNEY

SN 78-801,263. MILLER HEIMAN, INC., RENO, NV. FILED 1-27-2006.

**MILLER HEIMAN CERTIFIED
PROFESSIONAL**

THE MARK CONSISTS OF STANDARD CHARACTERS WITHOUT CLAIM TO ANY PARTICULAR FONT, STYLE, SIZE, OR COLOR.

OWNER OF U.S. REG. NOS. 1,551,921, 2,723,908 AND 2,726,897.

NO CLAIM IS MADE TO THE EXCLUSIVE RIGHT TO USE "CERTIFIED PROFESSIONAL", APART FROM THE MARK AS SHOWN.

THE NAME MILLER HEIMAN DOES NOT IDENTIFY A LIVING INDIVIDUAL.

CLASS 9—ELECTRICAL AND SCIENTIFIC APPARATUS

FOR COMPUTER SOFTWARE PROGRAMS FOR MANAGING SALES ACTIVITIES; TAPE SOUND RECORDINGS, COMPACT DISKS, VIDEO RECORDINGS, AUDIO VISUAL RECORDINGS, AND PHOTOGRAPHIC SLIDE TRANSPARENCIES FOR USE WITH COMPUTERS, ALL IN THE FIELD OF THE PRACTICE OF PLANNING AND EXECUTING SALES SITUATIONS, TRAINING, METHODOLOGY, AND PROCESSES (U.S. CLS. 21, 23, 26, 36 AND 38).

CLASS 16—PAPER GOODS AND PRINTED MATTER

FOR BOOKS, MANUALS, BROCHURES, AND NEWSLETTERS ALL IN THE FIELD OF THE PRACTICE OF PLANNING AND EXECUTING SALES SITUATIONS, TRAINING, METHODOLOGY, AND PROCESSES (U.S. CLS. 2, 5, 22, 23, 29, 37, 38 AND 50).

CLASS 35—ADVERTISING AND BUSINESS

FOR SALES PERFORMANCE RESEARCH, NAMELY, BUSINESS RESEARCH REGARDING SALES PERFORMANCES OF BUSINESSES; PROVIDING BUSINESS INFORMATION IN THE FIELD OF SALES TRAINING, METHODOLOGY, AND PROCESSES (U.S. CLS. 100, 101 AND 102).

CLASS 41—EDUCATION AND ENTERTAINMENT

FOR ARRANGING AND CONDUCTING EDUCATIONAL CONFERENCES; EDUCATION IN THE FIELD OF SALES TRAINING, METHODOLOGY, AND PROCESSES RENDERED THROUGH INTERNET-BASED CORRESPONDENCE COURSES; EDUCATION SERVICES, NAMELY, PROVIDING TRAINING SESSIONS FOR INDIVIDUALS AND GROUPS IN THE FIELD OF SALES TRAINING, METHODOLOGY, AND PROCESSES; EDUCATIONAL SERVICES, NAMELY, CONDUCTING PROGRAMS IN THE FIELD OF SALES TRAINING, METHODOLOGY, AND PROCESSES; EDUCATIONAL SPEECHES RELATING TO THE FIELD OF SALES TRAINING, METHODOLOGY AND PROCESSES; EDUCATIONAL SERVICES, NAMELY, PROVIDING COURSES OF INSTRUCTION IN THE FIELD OF SALES TRAINING, METHODOLOGY, AND PROCESSES, AND THE DISTRIBUTION OF COURSE MATERIAL IN CONNECTION THEREWITH; EDUCATION SERVICES, NAMELY, CONDUCTING ONLINE EXHIBITIONS AND DISPLAYS AND INTERACTIVE EXHIBITS IN THE FIELD OF SALES TRAINING, METHODOLOGY, AND PROCESSES; INSTRUCTION IN THE FIELD OF SALES TRAINING, METHODOLOGY, AND PROCESSES; PROVIDING COURSES OF INSTRUCTION AT THE PROFESSIONAL LEVEL IN THE FIELD OF SALES TRAINING, METHODOLOGY, AND PROCESSES; PUBLICATION OF DOCUMENTS IN THE FIELD OF SALES TRAINING, METHODOLOGY, AND PROCESSES; PUBLICATION OF TEXTS, JOURNALS, PAMPHLETS AND NEWSLETTERS IN THE FIELD OF SALES TRAINING, METHODOLOGY, AND PROCESSES; TEACHING IN THE FIELD OF SALES TRAINING, METHODOLOGY, AND PROCESSES; TRAINING SERVICES IN THE FIELD OF SALES TRAINING, METHODOLOGY, AND PROCESSES (U.S. CLS. 100, 101 AND 107).

ANDREW RHIM, EXAMINING ATTORNEY

SN 78-804,704. JACOBSON ACQUISITION CO., DES MOINES, IA. FILED 2-1-2006.

CAN DO LOGISTICS

THE MARK CONSISTS OF STANDARD CHARACTERS WITHOUT CLAIM TO ANY PARTICULAR FONT, STYLE, SIZE, OR COLOR.

NO CLAIM IS MADE TO THE EXCLUSIVE RIGHT TO USE "LOGISTICS", APART FROM THE MARK AS SHOWN.

CLASS 35—ADVERTISING AND BUSINESS

FOR SUPPLY CHAIN MANAGEMENT SERVICES; EMPLOYMENT HIRING, RECRUITING, PLACEMENT, STAFFING AND CAREER NETWORKING SERVICES (U.S. CLS. 100, 101 AND 102).

FIRST USE 6-0-2004; IN COMMERCE 6-0-2004.

CLASS 39—TRANSPORTATION AND STORAGE

FOR WAREHOUSE SERVICES; TRANSPORTATION OF FREIGHT BY TRUCK (U.S. CLS. 100 AND 105).

FIRST USE 6-0-2004; IN COMMERCE 6-0-2004.
STEVEN R. FINE, EXAMINING ATTORNEY

SN 78-805,796. MARS, INCORPORATED, MCLEAN, VA.
FILED 2-2-2006.

BANANA WHUP'D

THE MARK CONSISTS OF STANDARD CHARACTERS WITHOUT CLAIM TO ANY PARTICULAR FONT, STYLE, SIZE, OR COLOR.

NO CLAIM IS MADE TO THE EXCLUSIVE RIGHT TO USE "BANANA", APART FROM THE MARK AS SHOWN.

CLASS 5—PHARMACEUTICALS

FOR NUTRITIONALLY FORTIFIED BEVERAGES, NAMELY, NUTRITIONAL DRINK MIX FOR USE AS A MEAL REPLACEMENT; NUTRITIONAL SHAKES FOR USE AS MEAL SUBSTITUTE; NUTRITIONALLY FORTIFIED WATER (U.S. CLS. 6, 18, 44, 46, 51 AND 52).

CLASS 29—MEATS AND PROCESSED FOODS

FOR SOY-BASED BEVERAGES USED AS MILK SUBSTITUTES; VEGETABLE-BASED CHOCOLATE FOOD BEVERAGES; DAIRY-BASED CHOCOLATE FOOD BEVERAGES; NON-ALCOHOLIC BEVERAGES, NAMELY, DAIRY-BASED FOOD BEVERAGES, FRUIT-BASED FOOD BEVERAGES, MILK-BASED BEVERAGES CONTAINING FRUIT JUICE AND MILK BEVERAGES CONTAINING FRUITS (U.S. CL. 46).

CLASS 30—STAPLE FOODS

FOR CHOCOLATE FOOD BEVERAGES NOT BEING DAIRY-BASED OR VEGETABLE-BASED (U.S. CL. 46).

CLASS 32—LIGHT BEVERAGES

FOR NON-ALCOHOLIC BEVERAGES, NAMELY, CARBONATED BEVERAGES, AERATED FRUIT JUICES, AERATED WATER, SODA WATER, BOTTLED DRINKING WATER, FLAVORED WATERS, FRUIT BEVERAGES, FRUIT DRINKS, FRUIT-FLAVORED BEVERAGES, FRUIT-FLAVORED DRINKS, SPARKLING WATER, SPORTS DRINKS, SMOOTHIES; NON-ALCOHOLIC BEVERAGES CONTAINING FRUIT JUICES; SOY-BASED BEVERAGES NOT BEING MILK SUBSTITUTES (U.S. CLS. 45, 46 AND 48).

EVELYN BRADLEY, EXAMINING ATTORNEY

SN 78-805,876. WAL-MART STORES, INC., BENTONVILLE, AR. FILED 2-2-2006.

SUDDEN COLOR

THE MARK CONSISTS OF STANDARD CHARACTERS WITHOUT CLAIM TO ANY PARTICULAR FONT, STYLE, SIZE, OR COLOR.

CLASS 20—FURNITURE AND ARTICLES NOT OTHERWISE CLASSIFIED

FOR CLOTHES HAMPERS; CLOTHES HANGERS; PILLOWS; SHOWER CURTAIN RINGS; FITTED FABRIC FURNITURE COVERS (U.S. CLS. 2, 13, 22, 25, 32 AND 50).

CLASS 21—HOUSEWARES AND GLASS

FOR HOUSEWARES, NAMELY, PLATES, SAUCERS, BOWLS, MUGS, DRINKING GLASSES, CUPS, TRASH CANS, FOOD STORAGE CONTAINERS, PLASTIC STORAGE CONTAINERS FOR DOMESTIC USE, PLASTIC SERVING PLATTERS, CUTTING BOARDS, LINT ROLLERS, IRONING BOARD PADS (U.S. CLS. 2, 13, 23, 29, 30, 33, 40 AND 50).

CLASS 22—CORDAGE AND FIBERS

FOR LAUNDRY BAGS (U.S. CLS. 1, 2, 7, 19, 22, 42 AND 50).

CLASS 24—FABRICS

FOR TEXTILE FABRICS FOR HOME INTERIORS; BEDDING, NAMELY, BED SHEETS, PILLOWCASES, COMFORTERS, BED SPREADS, QUILTS, MATTRESS PADS, BED BLANKETS, SHAMS, DUST RUFFLES, MATTRESS COVERS, DUVETS; UNFITTED FABRIC FURNITURE COVERS; TABLE LINENS; BATH TOWELS; SHOWER CURTAINS (U.S. CLS. 42 AND 50).

CLASS 27—FLOOR COVERINGS

FOR RUGS (U.S. CLS. 19, 20, 37, 42 AND 50).
SHANNON TWOHIG, EXAMINING ATTORNEY

SN 78-806,877. THE CARE GROUP, LLC, INDIANAPOLIS, IN. FILED 2-3-2006.



THE MARK CONSISTS OF A DESIGN MARK OF A HEART RATE MONITOR CHART.

CLASS 41—EDUCATION AND ENTERTAINMENT

FOR CLASS 041: COMPREHENSIVE CARDIOVASCULAR PHYSICAL FITNESS TRAINING; BEHAVIOR MODIFICATION, NAMELY CAREER COUNSELING FOR THOSE SUFFERING FROM OR CONCERNED ABOUT CARDIOVASCULAR DISEASE OR WHO HAVE BEEN OR ARE INVOLVED IN SOME TYPE OF CARDIOVASCULAR SURGERY (U.S. CLS. 100, 101 AND 107).

FIRST USE 12-4-1996; IN COMMERCE 12-4-1996.

CLASS 44—MEDICAL, BEAUTY AND AGRICULTURAL SERVICES

FOR MEDICAL SERVICES, NAMELY, COMPREHENSIVE CARDIOVASCULAR DIAGNOSTIC EVALUATION, TESTING, INTERVENTION, TREATMENT AND REHABILITATION INCLUDING NUTRITIONAL, PSYCHOLOGICAL, AND PEDIATRIC CARDIOLOGY; CARDIAC RISK AND OUTREACH CLINICS, AND WELLNESS PROMOTIONAL PROGRAMS NAMELY, MEDICAL COUNSELING; PHYSICIAN SERVICES THROUGH A PRIMARY CARE NETWORK; COMPREHENSIVE CARDIOVASCULAR PHYSICAL CONSULTATION (U.S. CLS. 100 AND 101).

FIRST USE 12-4-1996; IN COMMERCE 12-4-1996.
NAKIA HENRY, EXAMINING ATTORNEY

SN 78-807,663. EXPRESS CAPITAL LIMITED, KOWLOON, HONG KONG, FILED 2-6-2006.

Y S A
MAKINO

"YSA MAKINO" DOES NOT IDENTIFY A LIVING INDIVIDUAL.

CLASS 14—JEWELRY

FOR JEWELRY, BROOCHES, EARRINGS, AND ORNAMENTAL PINS; HEADPIECES, NAMELY, TIARAS (U.S. CLS. 2, 27, 28 AND 50).

FIRST USE 2-0-2000; IN COMMERCE 2-0-2000.

CLASS 25—CLOTHING

FOR CLOTHING, NAMELY, WEDDING GOWNS, EVENING GOWNS, GOWNS, BALL GOWNS, DRESSES, SKIRTS, BUSTIERS, MEN'S AND WOMEN'S PANTS, SHIRTS, TOPS, T-SHIRTS, SWEATERS, JACKETS, SCARVES, SHAWLS, SUITS, FUR COATS, FUR JACKETS, FUR STOLE, FUR HATS, COATS, RAINCOATS, BELTS, TIES; FOOTWEAR; HEADWEAR; ARTICLES OF UNDERCLOTHING, NAMELY, MEN'S AND WOMEN'S UNDERWEAR, NIGHTWEAR AND LINGERIE; WEDDING ACCESSORIES, NAMELY, VEILS AND GLOVES; HEADPIECES, NAMELY, HEADBANDS (U.S. CLS. 22 AND 39).

FIRST USE 2-0-2000; IN COMMERCE 2-0-2000.

CLASS 35—ADVERTISING AND BUSINESS

FOR RETAIL, WHOLESALE AND ONLINE STORE SERVICES FEATURING FORMAL WEAR, WEDDING GOWNS, WEDDING ACCESSORIES, CLOTHING, JEWELRY, EYEWEAR, PERFUME AND COSMETICS, HANDBAGS, PURSES AND FOOTWEAR (U.S. CLS. 100, 101 AND 102).

FIRST USE 2-0-2000; IN COMMERCE 2-0-2000.
EVELYN BRADLEY, EXAMINING ATTORNEY

SN 78-808,963. NOVABIOTICS LIMITED, ABERDEEN, UNITED KINGDOM, FILED 2-7-2006.

NOVABIOTICS

THE MARK CONSISTS OF STANDARD CHARACTERS WITHOUT CLAIM TO ANY PARTICULAR FONT, STYLE, SIZE, OR COLOR.

PRIORITY CLAIMED UNDER SEC. 44(D) ON UNITED KINGDOM APPLICATION NO. 2400329, FILED 8-26-2005, REG. NO. 2400329, DATED 8-26-2005, EXPIRES 8-26-2015.

CLASS 5—PHARMACEUTICALS

FOR PHARMACEUTICAL AND VETERINARY PREPARATIONS AND SUBSTANCES, NAMELY, ANTI-INFECTION PREPARATIONS AND SUBSTANCES; ANTISEPTIC PREPARATIONS AND SUBSTANCES; ANTIMICROBIAL PREPARATIONS AND SUBSTANCES FOR USE IN THE TREATMENT OF DERMATOLOGIC AILMENTS; ANTIBACTERIAL PREPARATIONS AND SUBSTANCES FOR MEDICAL PURPOSES; ANTIFUNGAL MEDICATIONS; MEDICATED ANTIFUNGAL AND ANTIBACTERIAL PREPARATIONS AND SUBSTANCES, NAMELY, MOISTURIZERS, CREAMS, LOTIONS, GELS, TONERS, CLEANSERS, AND COSMETICS ALL FOR USE IN THE TREATMENT OF DERMATOLOGIC AILMENTS; ANTIVIRAL PREPARATIONS AND SUBSTANCES FOR THE PREVENTION AND TREATMENT OF INFECTIONS (U.S. CLS. 6, 18, 44, 46, 51 AND 52).

CLASS 42—SCIENTIFIC AND COMPUTER SERVICES

FOR SCIENTIFIC RESEARCH AND DEVELOPMENT, BIOLOGICAL RESEARCH, BIOTECHNOLOGICAL RESEARCH, TECHNICAL RESEARCH; ALL PERTAINING TO THE PREVENTION AND TREATMENT OF INFECTIONS AND ANTI-INFECTION, ANTISEPTIC, ANTIMICROBIAL, ANTIBACTERIAL, ANTIVIRAL AND ANTIFUNGAL PREPARATIONS AND SUBSTANCES (U.S. CLS. 100 AND 101).

SUNG IN, EXAMINING ATTORNEY

SN 78-811,249. HOME DIAGNOSTICS, INC., FORT LAUDERDALE, FL. FILED 2-9-2006.

TrueTrack Resolve

THE MARK CONSISTS OF STANDARD CHARACTERS WITHOUT CLAIM TO ANY PARTICULAR FONT, STYLE, SIZE, OR COLOR.

OWNER OF U.S. REG. NO. 2,865,685.

CLASS 5—PHARMACEUTICALS

FOR MEDICAL DIAGNOSTIC TEST STRIPS AND CONTROL SOLUTIONS FOR USE IN BLOOD GLUCOSE TESTING; GLUCOSE TEST STRIPS AND GLUCOSE CONTROL SOLUTIONS SOLD INDIVIDUALLY AND AS PART OF BLOOD GLUCOSE TESTING KITS (U.S. CLS. 6, 18, 44, 46, 51 AND 52).

CLASS 10—MEDICAL APPARATUS

FOR BLOOD GLUCOSE METERS SOLD INDIVIDUALLY AND AS PART OF BLOOD GLUCOSE TESTING KITS (U.S. CLS. 26, 39 AND 44).

TINA BROWN, EXAMINING ATTORNEY

SN 78-811,303. HOME DIAGNOSTICS, INC., FORT LAUDERDALE, FL. FILED 2-9-2006.

Resolve

THE MARK CONSISTS OF STANDARD CHARACTERS WITHOUT CLAIM TO ANY PARTICULAR FONT, STYLE, SIZE, OR COLOR.

CLASS 5—PHARMACEUTICALS

FOR MEDICAL DIAGNOSTIC TEST STRIPS AND CONTROL SOLUTIONS FOR USE IN BLOOD GLUCOSE TESTING; GLUCOSE TEST STRIPS AND GLUCOSE CONTROL SOLUTIONS SOLD INDIVIDUALLY AND AS PART OF BLOOD GLUCOSE TESTING KITS (U.S. CLS. 6, 18, 44, 46, 51 AND 52).

CLASS 10—MEDICAL APPARATUS

FOR BLOOD GLUCOSE METERS SOLD INDIVIDUALLY AND AS PART OF BLOOD GLUCOSE TESTING KITS (U.S. CLS. 26, 39 AND 44).

TINA BROWN, EXAMINING ATTORNEY

SN 78-811,501. ERAVITA, INC., PLEASANT HILL, CA. FILED 2-9-2006.

STORY OF MY LIFE FOUNDATION

THE MARK CONSISTS OF STANDARD CHARACTERS WITHOUT CLAIM TO ANY PARTICULAR FONT, STYLE, SIZE, OR COLOR.

NO CLAIM IS MADE TO THE EXCLUSIVE RIGHT TO USE "FOUNDATION", APART FROM THE MARK AS SHOWN.

CLASS 39—TRANSPORTATION AND STORAGE

FOR STORAGE SERVICES FOR ARCHIVING DATABASES, IMAGES AND OTHER ELECTRONIC DATA IN THE FIELD OF GENEALOGY, INCLUDING FAMILY HISTORIES, AUTOBIOGRAPHIES, BIOGRAPHIES AND HISTORICAL RECORDS; PERMANENT STORAGE OF GENEALOGICAL INFORMATION AND MATERIAL, INCLUDING FAMILY HISTORIES, AUTOBIOGRAPHIES, BIOGRAPHIES, HISTORICAL RECORDS, DOCUMENTS, PHOTOS, PHOTO ALBUMS, IMAGES, AND OTHER GENEALOGICAL DATA (U.S. CLS. 100 AND 105).

CLASS 42—SCIENTIFIC AND COMPUTER SERVICES

FOR APPLICATION SERVICE PROVIDER (ASP), NAMELY, HOSTING COMPUTER SOFTWARE APPLICATIONS OF OTHERS THAT ENABLES FAMILIES AND INDIVIDUALS TO CREATE, DISPLAY, SHARE AND STORE DATA AND INFORMATION IN THE FIELD OF GENEALOGY, INCLUDING FAMILY HISTORIES, AUTOBIOGRAPHIES, BIOGRAPHIES AND HISTORICAL RECORDS; HOSTING OF DIGITAL CONTENT ON THE INTERNET IN THE NATURE OF PHOTOS, PHOTO ALBUMS, IMAGES, AND OTHER CONTENT RELATING TO GENEALOGY, INCLUDING FAMILY HISTORIES, AUTOBIOGRAPHIES, BIOGRAPHIES AND HISTORICAL RECORDS (U.S. CLS. 100 AND 101).

CLASS 45—PERSONAL AND LEGAL SERVICES

FOR PROVIDING AN ONLINE DATABASE FEATURING INFORMATION, PHOTOS, PHOTO ALBUMS, IMAGES, AND OTHER DATA IN THE FIELD OF GENEALOGY, INCLUDING FAMILY HISTORIES, AUTOBIOGRAPHIES, BIOGRAPHIES AND HISTORICAL RECORDS; PROVIDING GENEALOGICAL INFORMATION RELATING TO FAMILY HISTORIES, AUTOBIOGRAPHIES, BIOGRAPHIES AND HISTORICAL RECORDS (U.S. CLS. 100 AND 101).

NICHOLAS ALTREE, EXAMINING ATTORNEY

SN 78-813,375. TOUCAN COVE ENTERTAINMENT L.L.C., SEATTLE, WA. FILED 2-13-2006.



THE COLOR(S) WHITE, BLACK AND YELLOW IS/ARE CLAIMED AS A FEATURE OF THE MARK.

THE MARK CONSISTS OF THE WORD TOUCAN IN BLACK LETTERING ABOVE THE WORD COVE IN BLACK LETTERING, AND A BIRD WITH A BLACK BODY, YELLOW BEAK AND WHITE NECK UNDERNEATH THE WORDS TOUCAN COVE OUTLINED IN THE SHAPE OF A SQUARE WITH A YELLOW AND BLACK BORDER.

CLASS 35—ADVERTISING AND BUSINESS

FOR PROMOTING AND MARKETING MUSICAL ARTISTS AND MUSICAL GROUPS BY PLACING AND DISSEMINATING PROMOTIONAL MATERIALS, MUSIC VIDEOS, AND DOWNLOADABLE PRERECORDED MUSIC VIA THE INTERNET, AND CONSULTING SERVICES RELATED THERETO, AND ONLINE RETAIL STORE SERVICES FEATURING DOWNLOADABLE PRERECORDED MUSIC (U.S. CLS. 100, 101 AND 102).

FIRST USE 3-18-2003; IN COMMERCE 3-18-2003.

CLASS 41—EDUCATION AND ENTERTAINMENT

FOR ENTERTAINMENT SERVICES, NAMELY, PROVIDING A WEBSITE ON A GLOBAL COMPUTER NETWORK FEATURING INFORMATION IN THE FIELD OF MUSICAL GROUPS AND MUSICAL ARTISTS; PRODUCTION OF SOUND AND MUSIC VIDEO RECORDINGS AND RADIO PROGRAMS, AND DISTRIBUTION OF RADIO PROGRAMS FOR OTHERS (U.S. CLS. 100, 101 AND 107).

FIRST USE 3-18-2003; IN COMMERCE 3-18-2003.
MIDGE BUTLER, EXAMINING ATTORNEY

SN 78-817,401. C.O. SENSE (US), INC., WILMINGTON, DE.
FILED 2-17-2006.

JIMALAYA

THE MARK CONSISTS OF STANDARD CHARACTERS WITHOUT CLAIM TO ANY PARTICULAR FONT, STYLE, SIZE, OR COLOR.

OWNER OF ISRAEL REG. NO. 182017, DATED 4-15-2007, EXPIRES 7-10-2015.

OWNER OF ISRAEL REG. NO. 182016, DATED 4-15-2007, EXPIRES 7-10-2015.

CLASS 9—ELECTRICAL AND SCIENTIFIC APPARATUS

FOR DOWNLOADABLE INTERNET SKILL-BASED GAMES SOFTWARE; INTERACTIVE TELEVISION SKILL-BASED GAMES SOFTWARE, INTERACTIVE ELECTRONIC GAMES SOFTWARE FOR USE WITH TELEVISION RECEIVERS, COMPUTERS, TELEPHONES, MOBILE PHONES, HANDHELD DEVICES, PERSONAL DIGITAL ASSISTANT (U.S. CLS. 21, 23, 26, 36 AND 38).

CLASS 41—EDUCATION AND ENTERTAINMENT

FOR ENTERTAINMENT SERVICES, NAMELY, PROVIDING ON-LINE SKILL-BASED GAMES; ENTERTAINMENT SERVICES, NAMELY, PROVIDING ON-LINE SKILL-BASED GAMES FOR USE WITH TELEPHONES AND MOBILE TELEPHONES; ENTERTAINMENT SERVICES, NAMELY, PRODUCTION AND DISTRIBUTION OF GAME SHOWS (U.S. CLS. 100, 101 AND 107).

JOANNA DUKOVIC, EXAMINING ATTORNEY

SN 78-820,126. ATRONIC INTERNATIONAL GMBH, LÜBBECKE, FED REP GERMANY, FILED 2-21-2006.

STAR OF AFRICA

THE MARK CONSISTS OF STANDARD CHARACTERS WITHOUT CLAIM TO ANY PARTICULAR FONT, STYLE, SIZE, OR COLOR.

PRIORITY CLAIMED UNDER SEC. 44(D) ON ERP CMNTY TM OFC APPLICATION NO. 4890554, FILED 2-9-2006, REG. NO. 4890554, DATED 3-5-2007, EXPIRES 2-9-2016.

CLASS 9—ELECTRICAL AND SCIENTIFIC APPARATUS

FOR ELECTRIC AND ELECTRONIC APPARATUS, DEVICES AND INSTRUMENTS, NAMELY, AUTOMATED DISPENSING MACHINES THAT DISPENSE AND ACCEPT COINS, PAPER MONEY, TOKENS, MAGNETIC STRIP CARDS, ELECTRONIC TOKENS, MEMORY CARDS, MICRO-PROCESSOR CARDS, CONTACTLESS CHIP CARDS, OPTICAL MEMORY CARDS, CHITS, EMBOSSED CARDS, AND READ AND WRITE TICKETS; COIN OPERATED MACHINES AND MACHINES OPERABLE WITH PAPER MONEY, TOKENS, MAGNETIC CARDS, MICRO-PROCESSOR DEVICES AND CHITS, NAMELY, SLOT MACHINES WITH OR WITHOUT VIDEO OUTPUT, GAMBLING AND GAMING MACHINES, BETTING MACHINES; MULTI-USER AND NETWORKED SLOT MACHINES WITH OR WITHOUT VIDEO OUTPUT; MECHANISMS FOR COIN-OPERATED MACHINES AND COIN CONTROLLED MACHINES, NAMELY, MOUNTING PARTS FOR AND SOLD AS A COMPONENT OF VENDING MACHINES, MONEY CHANGE MACHINES, GAMBLING AND GAMING MACHINES, OPERABLE WITH COINS, PAPER MONEY, TOKENS, MAGNETIC STRIP CARDS, ELECTRONIC TOKENS, MEMORY CARDS, MICRO-PROCESSOR CARDS, OPTICAL MEMORY CARDS, CHITS, EMBOSSED CARDS, READ AND WRITE TICKETS; COMPUTER PROGRAMS FOR OPERATING ELECTRIC AND ELECTRONIC MACHINES FOR GAMBLING, GAMING, AMUSEMENT AND ENTERTAINMENT PURPOSES; CALCULATORS FOR CALCULATING TRANSACTIONS PERFORMED ON MACHINES OPERATED WITH CURRENCY AND CURRENCY SURROGATE CARRIERS; DATA PRINTERS; PRINTED CIRCUIT BOARDS; MONEY CHANGE MACHINES AND VENDING MACHINES PROVIDING CHITS, COUPONS, AND GAME CARDS; MACHINE-READABLE DATA CARRIERS FEATURING ELECTRONIC GAMING INFORMATION; MEMORY CARDS FOR ELECTRONIC POCKET GAMES; VIDEO GAMING AND GAMBLING MACHINES NOT FOR USE AS ACCESSORY DEVICES WITH TELEVISIONS, NAMELY, SLOT MACHINES PROVIDED WITH A CRT MONITOR, A TFT MONITOR OR A SIMILAR DISPLAY MONITOR (U.S. CLS. 21, 23, 26, 36 AND 38).

CLASS 28—TOYS AND SPORTING GOODS

FOR STAND-ALONE COIN-OPERATED COMPACT SPORTS GAME MACHINES; STAND-ALONE COIN-OPERATED COMPACT SPORTS VIDEO GAME MACHINES FEATURING DARTS, TABLE SOCCER, POOL-BIL- LIARD, SNOOKER, SHOOTING GALLERIES; HANDHELD UNITS FOR PLAYING ELECTRONIC GAMES; TOYS, NAMELY, STUFFED TOY ANIMALS, TOY FIGURES, TOY VEHICLES; STAND-ALONE VIDEO GAME MACHINES FEATURING AMUSEMENT, ENTERTAINMENT AND SPORTS THEMES (U.S. CLS. 22, 23, 38 AND 50).

CLASS 41—EDUCATION AND ENTERTAINMENT

FOR ENTERTAINMENT IN THE NATURE OF CASINO SERVICES FEATURING A PROGRESSIVE SLOT MACHINE JACKPOT, NAMELY, A JACKPOT OR PRIZE WITH A FIXED MINIMUM VALUE THAT GROWS, UNTIL WON, IN PROPORTION TO PLAY UPON DESIGNATED SLOT MACHINES LINKED TO THE PRIZE (U.S. CLS. 100, 101 AND 107).

TANYA AMOS, EXAMINING ATTORNEY

SN 78-820,144. LEDER, LAURA, NEW HOPE, PA. FILED 2-21-2006.

COOL MANDOLIN COMPANY

THE MARK CONSISTS OF STANDARD CHARACTERS WITHOUT CLAIM TO ANY PARTICULAR FONT, STYLE, SIZE, OR COLOR.

NO CLAIM IS MADE TO THE EXCLUSIVE RIGHT TO USE "COMPANY", APART FROM THE MARK AS SHOWN.

CLASS 18—LEATHER GOODS

FOR TOTE BAGS (U.S. CLS. 1, 2, 3, 22 AND 41).

CLASS 25—CLOTHING

FOR BELTS; HATS; SHIRTS (U.S. CLS. 22 AND 39).
TARAH HARDY, EXAMINING ATTORNEY

SN 78-820,835. MARS, INCORPORATED, MCLEAN, VA. FILED 2-22-2006.

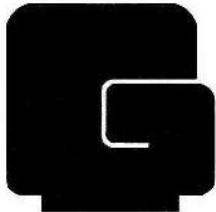

CLASS 5—PHARMACEUTICALS

FOR NUTRITIONALLY FORTIFIED ENERGY BARS FOR USE AS NUTRITIONAL SUPPLEMENTS OR MEAL REPLACEMENT; NUTRITIONALLY FORTIFIED ENERGY FOOD MIXES FOR USE AS NUTRITIONAL SUPPLEMENTS OR MEAL REPLACEMENT (U.S. CLS. 6, 18, 44, 46, 51 AND 52).

CLASS 29—MEATS AND PROCESSED FOODS

FOR SOY-BASED BEVERAGES USED AS MILK SUBSTITUTES; SOY-BASED, MEAT-BASED AND FRUIT-BASED SNACK FOODS; VEGETABLE-BASED CHOCOLATE FOOD BEVERAGES; DAIRY-BASED CHOCOLATE FOOD BEVERAGES; SOY-BASED SNACK FOODS; SOY-BASED SNACK BARS (U.S. CL. 46).

CLASS 30—STAPLE FOODS

FOR WHEAT-BASED AND RICE-BASED SNACK BARS; WHEAT-BASED AND RICE-BASED SNACK FOODS; CHOCOLATE FOOD BEVERAGES NOT BEING DAIRY-BASED OR VEGETABLE-BASED; GRANOLA BASED SNACK BARS; GRANOLA SNACKS; GRANOLA-BASED SNACK FOODS (U.S. CL. 46).

CLASS 32—LIGHT BEVERAGES

FOR NON-ALCOHOLIC BEVERAGES, NAMELY, CARBONATED AND NON-CARBONATED BEVERAGES, FRUIT DRINKS, AND SOY-BASED BEVERAGES NOT BEING MILK SUBSTITUTES; ENERGY DRINK MIXES (U.S. CLS. 45, 46 AND 48).

EVELYN BRADLEY, EXAMINING ATTORNEY

SN 78-822,377. MAYB TECHNOLOGIES LIMITED, TWICKENHAM, UNITED KINGDOM, FILED 2-24-2006.

yesnomayB

THE MARK CONSISTS OF STANDARD CHARACTERS WITHOUT CLAIM TO ANY PARTICULAR FONT, STYLE, SIZE, OR COLOR.

PRIORITY CLAIMED UNDER SEC. 44(D) ON ERP CMNTY TM OFC APPLICATION NO. 004903753, FILED 2-15-2006, REG. NO. 004903753, DATED 4-30-2007, EXPIRES 2-15-2016.

CLASS 42—SCIENTIFIC AND COMPUTER SERVICES

FOR COMPUTER TIME-SHARING SERVICES (U.S. CLS. 100 AND 101).

CLASS 45—PERSONAL AND LEGAL SERVICES

FOR INFORMATION AND CONSULTANCY SERVICES IN THE NATURE AND FIELD OF ON-LINE DATING AND SOCIAL INTRODUCTION AGENCIES SERVICES, CONSULTANCY AND ADVISORY SERVICES RELATING TO ON-LINE DATING AND DATING SERVICES PROVIDED ON-LINE FROM A COMPUTER DATABASE OR VIA THE INTERNET; PROVIDING SOCIAL INTRODUCTION AGENCY SERVICES; ADMINISTERING PERSONALITY AND PHYSICAL ATTRACTIVENESS TESTING AND CREATING PERSONALITY AND PHYSICAL ATTRACTIVENESS PROFILES OF OTHERS; DATING AGENCY SERVICES; MATCH-MAKING SERVICES; COMPUTER DATING SERVICES; PROVISION OF DATING AGENCY SERVICES VIA THE INTERNET; PROVISION OF DATING AGENCY SERVICES VIA TELEVISION, RADIO AND TELEPHONE; AGENCY SERVICES FOR ARRANGING PERSONAL SOCIAL INTRODUCTIONS; SOCIAL ESCORTING SERVICES; PREPARATIONS OF CURRICULA VITAE AND PERSONALITY PROFILES SERVICE BEING PART OF A DATING SERVICE (U.S. CLS. 100 AND 101).

SAMUEL E. SHARPER JR., EXAMINING ATTORNEY

SN 78-823,889. MUNIWIRELESS, LLC, GARDEN CITY PARK, NY. FILED 2-27-2006.



CLASS 35—ADVERTISING AND BUSINESS

FOR ADVERTISING, NAMELY, ADVERTISING FOR OTHERS (U.S. CLS. 100, 101 AND 102).
FIRST USE 9-28-2005; IN COMMERCE 9-28-2005.

CLASS 38—COMMUNICATION

FOR PROVIDING INFORMATION IN THE FIELD OF WIRELESS BROADBAND COMMUNICATIONS OVER A GLOBAL COMPUTER NETWORK (U.S. CLS. 100, 101 AND 104).
FIRST USE 9-28-2005; IN COMMERCE 9-28-2005.

CLASS 41—EDUCATION AND ENTERTAINMENT

FOR CONDUCTING AND PRESENTING SEMINARS, CONFERENCES AND SYMPOSIUMS IN THE FIELD OF WIRELESS BROADBAND COMMUNICATIONS (U.S. CLS. 100, 101 AND 107).
FIRST USE 9-28-2005; IN COMMERCE 9-28-2005.
DAVID MURRAY, EXAMINING ATTORNEY

SN 78-824,070. JT SPORTS LLC, BENTONVILLE, AR. FILED 2-27-2006.

WORR GAMES

THE MARK CONSISTS OF STANDARD CHARACTERS WITHOUT CLAIM TO ANY PARTICULAR FONT, STYLE, SIZE, OR COLOR.

OWNER OF U.S. REG. NO. 2,726,215.
NO CLAIM IS MADE TO THE EXCLUSIVE RIGHT TO USE "GAMES", APART FROM THE MARK AS SHOWN.

CLASS 9—ELECTRICAL AND SCIENTIFIC APPARATUS

FOR PAINTBALL EQUIPMENT AND ACCESSORIES, NAMELY, HELMETS, CHRONOGRAPHS, GOGGLES (U.S. CLS. 21, 23, 26, 36 AND 38).

CLASS 16—PAPER GOODS AND PRINTED MATTER

FOR PAINTBALL RELATED BANNERS MADE OF PAPER, POSTERS AND STICKERS (U.S. CLS. 2, 5, 22, 23, 29, 37, 38 AND 50).

CLASS 22—CORDAGE AND FIBERS

FOR LANYARDS; LANYARDS FOR CARRYING EQUIPMENT AND ACCESSORIES RELATED TO THE SPORT OF PAINTBALL (U.S. CLS. 1, 2, 7, 19, 22, 42 AND 50).

CLASS 24—FABRICS

FOR PAINTBALL RELATED BANNERS MADE OF CLOTH (U.S. CLS. 42 AND 50).

CLASS 25—CLOTHING

FOR CLOTHING FOR THE SPORT OF PAINTBALL, NAMELY, JERSEYS, T-SHIRTS, TANK TOPS, VISORS, CAPS, HATS, DO-RAGS, SOCKS (U.S. CLS. 22 AND 39).

CLASS 28—TOYS AND SPORTING GOODS

FOR EQUIPMENT AND ACCESSORIES FOR THE SPORT OF PAINTBALL, NAMELY, PAINTBALL MARKER LIGHTING SYSTEMS WHICH MOUNT TO PAINTBALL MARKERS FOR USE IN NIGHT PLAY; PAINTBALL MARKERS; PAINTBALL GUNS; PAINTBALL PISTOLS; REFILLABLE COMPRESSED AIR TANKS; SWABS FOR CLEANING PAINTBALL MARKER BARRELS; LOADERS; FEEDERS; PAINTBALLS; TAGGING PELLETS; BARREL PLUGS; MOPS; SQUEEGEES; FRONT BLOCK KITS, CONTAINING A FRONT BLOCK, BANJO BOLT, LOW PRESSURE REGULATOR, THREE WAY VALVE, BI-DIRECTIONAL RAM AND LOW PRESSURE HOSES; GRIP NECK FEED, RAM, NAMELY, A FEED PORT ATTACHED TO THE TOP OF A MARKER CONNECTING THE MARKER TO THE LOADER; FILL ADAPTERS; PRESSURE GAUGES; PAINTBALL PLAYERS KITS, CONTAINING A BARREL PLUG OR BARREL COVER, CO2 TANK, MASK, HOPPER OR LOADER; PAINTBALL PARTS KITS, CONTAINING AN ALLEN WRENCH, O-RINGS AND O-RING LUBRICANT, WASHERS, REGULATOR SPRINGS, BARREL PLUG, BALL STOP, BALL STOP COVER, BALL STOP SCREWS, COCKING PIN, VALVE STEM ASSEMBLY, SPACER, BUMPER, CONSTANT AIR FILTER, GRIP PIN O-RINGS, STRIKER PLUG PIN, STRIKER SPRING, STRIKER SPRING GUIDE; O-RING KITS; REGULATOR REBUILD KITS, CONTAINING REGULATOR SPRINGS OR WASHERS; HARNESES FOR HOLDING PAINTBALL SUPPLIES; BARREL COVERS, ALSO KNOWN AS BARREL SHROUD OR BARREL CONDOM THAT IS USED TO PROTECT PLAYERS FROM ACCIDENTALLY DISCHARGING PAINTBALLS; BARREL PROTECTORS, ALSO KNOWN AS BARREL SHROUD OR BARREL CONDOM THAT IS USED TO PROTECT PLAYERS FROM ACCIDENTALLY DISCHARGING PAINTBALLS; PAINTBALL MARKER RAILS; PAINTBALL MARKER BOLTS; PAINTBALL MARKER HAMMERS; PAINTBALL PISTOL, MARKER AND GUN GRIPS; PAINTBALL MARKER COTTON FOR CLEANING OF PAINTBALL MARKERS; PAINTBALL MARKER MOUNTS; PAINTBALL MARKER TRIGGERS; PAINTBALL PISTOL, MARKER AND GUN BARRELS; PAINTBALL REGULATORS, PAINTBALL MARKER SIGHTS, PAINTBALL MARKER TARGETING DEVICES, PAINTBALL EQUIPMENT AND ACCESSORIES, NAMELY, PAINTBALL MARKER SIGHTS, PAINTBALL MARKER TARGETING DEVICES (U.S. CLS. 22, 23, 38 AND 50).
NANCY CLARKE, EXAMINING ATTORNEY

SN 78-824,298. HOWARTH, ALAN STEVEN, LA CANADA, CA. FILED 2-27-2006.

RA MUSIC

THE MARK CONSISTS OF STANDARD CHARACTERS WITHOUT CLAIM TO ANY PARTICULAR FONT, STYLE, SIZE, OR COLOR.

NO CLAIM IS MADE TO THE EXCLUSIVE RIGHT TO USE "MUSIC", APART FROM THE MARK AS SHOWN.

CLASS 9—ELECTRICAL AND SCIENTIFIC APPARATUS

FOR COMPUTERS HAVING AUDIO AND VIDEO SOUND CAPABILITIES; COMPUTERS; COMPONENTS OF COMPUTERS AND OTHER DIGITAL DEVICES NAMELY, COMPUTER HARDWARE AND SOFTWARE USED TO ENHANCE AUDIO AND VIDEO SOUND; COMPUTER SOFTWARE FOR PLAYING AUDIO FILES; COMPUTER SOFTWARE THAT DELIVERS AUDIO SOUND FROM DVDS LOADED INTO A COMPUTER; COMPUTER PROGRAMS USED TO DIGITALLY PROCESS AND ENHANCE THE RECORDING AND PLAYBACK OF AUDIO SOUND, SOUND EFFECTS AND SOUND TRACKS; SOFTWARE USED TO DIGITALLY ENCODE AND DECODE MULTI-CHANNEL SOUND FOR PRE-RECORDED AUDIO DISCS, VIDEO DISCS, LASER DISCS, DVD VIDEO DISCS, AND DVD AUDIO DISCS; COMPUTER PROGRAMS USED FOR GENERATING, PROCESSING, AND PLAYING AUDIO SIGNALS AND SOUNDS; MOUSEPADS; FABRIC CARRYING CASES FOR DVDS AND CDS; DIGITAL SIGNAL PROCESSING CHIPS; INTEGRATED CIRCUITS; DVD VIDEO PLAYERS; DVD AUDIO PLAYERS; SET TOP CABLE BOXES; SATELLITE RECEIVERS; TELEVISION RECEIVERS; DIGITAL TELEVISION RECEIVERS; VIDEO GAME CONSOLES; AUDIO AND VIDEO SURROUND SOUND CONTROLLERS; AUTOMOBILE SOUND SPEAKERS; MULTIMEDIA SPEAKERS; PORTABLE AUDIO EQUIPMENT, NAMELY, CASSETTE PLAYERS AND RECORDERS, AND COMPACT-DISC PLAYERS; CINEMA SOUND PROCESSORS FOR MOTION PICTURE SOUND TRACKS AND CINEMATOGRAPHIC FILMS; VIDEO MONITORS; VIDEO TUNERS; AUDIO AND VIDEO RECORDERS; AUDIO AND VIDEO DISC PLAYERS; AUDIO AND VIDEO DISC DUBBING DECKS; DVD PLAYERS; CABLE TELEVISION RECEIVERS AND DECODERS; REMOTE CONTROL UNITS FOR CABLE TELEVISION RECEIVERS AND DECODERS; ELECTRONIC BROADCAST SIGNAL PROCESSORS; ELECTRONIC SATELLITE BROADCAST SIGNAL PROCESSORS; AUDIO TAPES RECORDED WITH SIGNALS ENCODED FOR PLAYBACK USING A NOISE REDUCTION SYSTEM; AUDIO AND VIDEO TAPE RECORDERS AND TAPE PLAYERS FOR PORTABLE, NON-PORTABLE OR IN-VEHICLE USE; AUDIO OR VIDEO TAPE RECORDERS OR TAPE PLAYERS IN COMBINATION WITH AT LEAST ONE OF THE FOLLOWING: AMPLIFIER, RECEIVER, RADIO OR TELEVISION TUNER VIDEO CAMERA, RECORD PLAYER, COMPACT DISC PLAYER, VIDEO MONITOR, LOUD SPEAKER; MULTI-CHANNEL SOUND PROCESSORS; AUDIO AND AUDIO-VIDEO AMPLIFIERS AND RECEIVERS; STEREO AUDIO RECEIVERS; COMPUTER PROGRAMS HAVING SOUND GENERATING CAPABILITY; AUDIO AND VIDEO TAPES AND VIDEO DISCS RECORDED WITH ENCODED SIGNALS FOR PLAYBACK USING A NOISE REDUCTION SYSTEM OR SURROUND SOUND DECODER; CINEMATOGRAPHIC FILMS FEATURING FREQUENCY SPECTRUM CONVERSION TO NATURAL HARMONIC FREQUENCIES AND RELATED RESEARCH; ELECTRICAL POWER SUPPLIES; OPTICAL SOUND PROCESSORS FOR MOTION PICTURE SOUND TRACKS AND CINEMATOGRAPHIC FILMS; ELECTRONIC RECORDING/REPRODUCING APPARATUS EMBODYING NOISE REDUCTION CIRCUITS FOR USE IN CONNECTION WITH AUDIO AND VIDEO SIGNALS, NAMELY, MAGNETIC TAPE RECORDERS, CASSETTE RECORDERS, RECORD PLAYERS, RADIO TRANSMIT-

TERS AND RECEIVERS, AND MOTION PICTURE SOUND TRACK RECORDERS; MAGNETIC TAPES, DISCS, AND MOTION PICTURE SOUND TRACKS FEATURING MUSIC AND IMAGES CREATED UTILIZING FREQUENCY SPECTRUM CONVERSION TO NATURAL HARMONIC FREQUENCIES, AND VIDEO RECORDINGS OF ELECTRICAL SIGNALS WHICH HAVE BEEN SUBJECTED TO DYNAMIC RANGE COMPRESSION PRIOR TO RECORDING (U.S. CLS. 21, 23, 26, 36 AND 38).

CLASS 16—PAPER GOODS AND PRINTED MATTER

FOR POSTERS, PRINTED INSTRUCTION AND PRINTED OPERATION MANUALS, HANDBOOKS, BOOKLETS, FOLDERS, LEAFLETS, AND PAMPHLETS, ALL RELATING TO ADJUSTING, ALIGNING, CALIBRATING, INSTALLING, MAINTAINING, OPERATING, REPAIRING, TESTING, AND USING APPARATUS FOR USE IN CONNECTION WITH PROCESSING, RECORDING, REPRODUCING, TRANSMITTING, AND RECEIVING ELECTRONIC SIGNALS, MOTION PICTURE FILM PRODUCTION, AND TRAINING SERVICES RELATING TO CINEMA TECHNOLOGY AND AUDIO ENGINEERING, AND TO CONSULTATION, INSPECTION AND QUALITY CONTROL SERVICES, ALL RELATING TO MAKING SOUND RECORDINGS, TO TRANSFERRING SOUND RECORDINGS ONTO FILM, TO DUPLICATING AUDIO OR VIDEO RECORDINGS, TO SURVEYING THEATERS AND CINEMAS FOR THE INSTALLATION OF SOUND REPRODUCING EQUIPMENT, TO INSTALLING, ALIGNING, AND MAINTAINING SOUND REPRODUCING EQUIPMENT IN THEATERS AND IN CINEMAS, AND TO DESIGNING AND MANUFACTURING CONSUMER AUDIO AND AUDIO/VIDEO EQUIPMENT AND PROFESSIONAL RECORDING AND REPRODUCING EQUIPMENT; AND STICKERS FOR USE WITH AUDIO AND VIDEO RECORDINGS AND MOTION PICTURE FILMS (U.S. CLS. 2, 5, 22, 23, 29, 37, 38 AND 50).

CLASS 42—SCIENTIFIC AND COMPUTER SERVICES

FOR INFORMATION SERVICES PROVIDED BY MEANS OF A WEBSITE ON A GLOBAL COMPUTER NETWORK FEATURING THE DESIGN OF SOUND REPRODUCTION AND RECORDING EQUIPMENT IN THE CINEMA, PROFESSIONAL, HOME THEATER, MULTI-MEDIA, TELECOMMUNICATIONS AND COMPUTER NETWORK FIELDS (U.S. CLS. 100 AND 101).

DAVID C. REIHNER, EXAMINING ATTORNEY

SN 78-827,837. KIDS LINE, LLC, SOUTH GATE, CA. FILED 3-2-2006.

KIDS LINE

THE MARK CONSISTS OF STANDARD CHARACTERS WITHOUT CLAIM TO ANY PARTICULAR FONT, STYLE, SIZE, OR COLOR.

OWNER OF U.S. REG. NO. 2,754,915.

NO CLAIM IS MADE TO THE EXCLUSIVE RIGHT TO USE "KIDS", APART FROM THE MARK AS SHOWN.

SEC. 2(F).

CLASS 11—ENVIRONMENTAL CONTROL APPARATUS

FOR LIGHTING DEVICES AND ACCESSORIES, NAMELY, LAMPS, LAMP BASES, LAMP SHADES, AND ELECTRIC NIGHTLIGHTS (U.S. CLS. 13, 21, 23, 31 AND 34).

FIRST USE 12-31-1987; IN COMMERCE 12-31-1987.

CLASS 20—FURNITURE AND ARTICLES NOT OTHERWISE CLASSIFIED

FOR INFANT AND CHILDREN'S BEDDING AND ACCESSORIES, NAMELY, TEXTILE HEADRESTS, PILLOWS, DIAPER STACKERS, HAMPERS, PICTURE FRAMES, AND CHAIR PADS (U.S. CLS. 2, 13, 22, 25, 32 AND 50).

FIRST USE 12-31-1987; IN COMMERCE 12-31-1987.

CLASS 21—HOUSEWARES AND GLASS

FOR BASKETS OF WICKER, STRAW, WOOD AND CLOTH (U.S. CLS. 2, 13, 23, 29, 30, 33, 40 AND 50).

FIRST USE 12-31-1987; IN COMMERCE 12-31-1987.

CLASS 24—FABRICS

FOR INFANT AND CHILDREN'S BEDDING AND ACCESSORIES, NAMELY, BLANKETS, COMFORTERS, QUILTS, FABRIC VALENCES, DRAPES, DUST RUFFLES, SHEETS, TEXTILE WALL HANGINGS; BASSINET BEDDING, NAMELY, BASSINET CANOPIES, BASSINET FITTED SHEETS, BASSINET SKIRTS, CRIB AND CRADLE CANOPIES; CRIB BEDDING SETS, NAMELY, COMFORTERS, QUILTS, VALENCES, DRAPES, DUST RUFFLES, SHEETS, BUMPERS; FULL BEDDING SETS, NAMELY, COMFORTERS, QUILTS, VALENCES, DRAPES, DUST RUFFLES, SHEETS, PILLOW SHAMS; CRADLE BEDDING SETS, NAMELY, COMFORTERS, QUILTS, BUMPERS, SHEETS; BATH TOWELS, HOODED TOWELS, AND FACE CLOTHS FOR WASHING (U.S. CLS. 42 AND 50).

FIRST USE 12-31-1987; IN COMMERCE 12-31-1987.

JORDAN BAKER, EXAMINING ATTORNEY

SN 78-834,890. SIX APART, LTD., SAN FRANCISCO, CA. FILED 3-10-2006.

VOX

THE MARK CONSISTS OF STANDARD CHARACTERS WITHOUT CLAIM TO ANY PARTICULAR FONT, STYLE, SIZE, OR COLOR.

OWNER OF U.S. REG. NO. 3,014,829.

THE FOREIGN WORDING IN THE MARK TRANSLATES INTO ENGLISH AS VOICE.

CLASS 41—EDUCATION AND ENTERTAINMENT

FOR PUBLISHING ELECTRONIC PUBLICATIONS (U.S. CLS. 100, 101 AND 107).

CLASS 42—SCIENTIFIC AND COMPUTER SERVICES

FOR COMMUNICATIONS SERVICES, NAMELY, HOSTING AND MAINTAINING WEB LOGS FOR OTHERS (U.S. CLS. 100 AND 101).

DAVID C. REIHNER, EXAMINING ATTORNEY

SN 78-835,265. GENERAL MILLS, INC., MINNEAPOLIS, MN. FILED 3-13-2006.

QUE RICA VIDA

THE MARK CONSISTS OF STANDARD CHARACTERS WITHOUT CLAIM TO ANY PARTICULAR FONT, STYLE, SIZE, OR COLOR.

THE FOREIGN WORDING IN THE MARK TRANSLATES INTO ENGLISH AS WHAT A RICH LIFE.

CLASS 16—PAPER GOODS AND PRINTED MATTER

FOR MAGAZINE PROVIDING INFORMATION REGARDING HEALTH AND WELLNESS, EDUCATION, FOOD AND NUTRITION, RECIPES AND OTHER TOPICS OF GENERAL INTEREST (U.S. CLS. 2, 5, 22, 23, 29, 37, 38 AND 50).

CLASS 29—MEATS AND PROCESSED FOODS

FOR FOOD PRODUCTS, NAMELY, INSTANT POTATOES; CANNED, FROZEN, COOKED OR PRESERVED VEGETABLES; DAIRY PRODUCTS, EXCLUDING ICE CREAM, ICE MILK, AND FROZEN YOGURT; FRUIT-BASED SNACK FOOD; SOY-BASED BEVERAGES USED AS A MILK SUBSTITUTE; CANNED SOUPS (U.S. CL. 46).

CLASS 30—STAPLE FOODS

FOR FOOD PRODUCTS, NAMELY, BAKING MIXES, CAKE MIXES, BROWNIE MIXES, COOKIES MIXES, MUFFIN MIXES, PIE CRUST MIXES, FROSTING MIXES, BISCUIT MIXES, PANCAKE AND WAFFLE MIXES, AND FROSTINGS; PROCESSED CEREAL-DERIVED FOOD PRODUCTS TO BE USED AS A BREAKFAST CEREAL, SNACK FOOD, OR INGREDIENT FOR MAKING FOOD; CANNED SPANISH RICE; CANNED AND BOTTLED SALSA; FLOUR TORTILLAS; KITS FOR TACO DINNERS CONTAINING TACO SHELLS, TACO SAUCE AND DRY TACO SEASONING MIX; PACKAGED DINNER MIXES CONSISTING PRIMARILY OF BREAD STUFFING AND GRAVY OR HAVING EITHER A CEREAL BASE, A PASTA BASE, A VEGETABLE BASE, A RICE BASE, OR A COMBINATION THEREOF; FROZEN PIZZA AND PIZZA SNACKS; BREAKFAST PASTRIES; REFRIGERATED AND FROZEN DOUGH; FROZEN BREAKFAST FOODS, NAMELY, PANCAKES, WAFFLES, FRENCH TOAST STICKS AND WAFFLE STICKS; POPCORN; READY-TO-EAT CEREAL-DERIVED BARS; AND VINEGAR (U.S. CL. 46).

CLASS 41—EDUCATION AND ENTERTAINMENT

FOR PRODUCTION OF RADIO AND TELEVISION PROGRAMS FEATURING INFORMATION REGARDING HEALTH AND WELLNESS, FOOD AND NUTRITION, AND RECIPES (U.S. CLS. 100, 101 AND 107).

CLASS 43—HOTEL AND RESTAURANT SERVICES

FOR PROVIDING INFORMATION REGARDING RECIPES VIA THE INTERNET (U.S. CLS. 100 AND 101).

CLASS 44—MEDICAL, BEAUTY AND AGRICULTURAL SERVICES

FOR PROVIDING INFORMATION REGARDING HEALTH AND WELLNESS, FOOD AND NUTRITION VIA THE INTERNET (U.S. CLS. 100 AND 101).

WILLIAM VERHOSEK, EXAMINING ATTORNEY

SN 78-841,012. LIFECARE, INC., WESTPORT, CT. FILED 3-20-2006.



OWNER OF U.S. REG. NOS. 2,162,965, 2,850,118 AND OTHERS.

THE COLOR(S) LIGHT BLUE, DARK BLUE, AND BLACK IS/ARE CLAIMED AS A FEATURE OF THE MARK.

THE MARK CONSISTS OF A FOUR-BY-FOUR GRID OF BLOCKS POSITIONED ABOVE THE LITERAL PORTION OF THE MARK. THE GRID IS MADE UP OF FOUR ROWS OF FOUR BLOCKS PER ROW, WITH THE THIRD BLOCK IN THE SECOND ROW BEING LIGHT BLUE AND THE REMAINING BLOCKS BEING DARK BLUE. THE WORD LIFECARE APPEARS BELOW THE GRID DESIGN; THE DOT OVER THE "I" IN THE WORD "LIFECARE" IS A LIGHT BLUE SQUARE AND THE REMAINDER OF THE WORD IS BLACK. THE PHRASE CARING TODAY FOR A BETTER TOMORROW APPEARS IN DARK BLUE DIRECTLY BENEATH THE WORD LIFECARE.

SEC. 2(F) AS TO "LIFECARE".

CLASS 16—PAPER GOODS AND PRINTED MATTER

FOR NEWSLETTERS, PRINTED INFORMATIONAL MATERIALS AND PRINTED EDUCATIONAL MATERIALS, NAMELY, PAMPHLETS AND BROCHURES IN THE FIELD OF GERIATRIC CARE, REPORTS AND REVIEWS OF HEALTH CARE PROVIDERS, GOVERNMENT BENEFITS AND ENTITLEMENTS, RETIREMENT PLANNING, POST-RETIREMENT PLANNING, POST-RETIREMENT ACTIVITIES, EMPLOYEE PENSION PLANS AND BENEFITS, RETIREMENT LIFESTYLE OPTIONS, RELOCATION, HOUSING, EMPLOYMENT, EMPLOYEE FINANCIAL PLANNING, CHILD CARE AND ADULT CARE, HEALTH AND WELLNESS, NUTRITION, MARRIAGE, TRAVEL, VOLUNTEERISM, PET CARE, EMERGENCY CARE, SUPPORT GROUPS FOR THE ELDERLY, ELDERCARE, DEPENDENT CARE, ADOPTION, SPECIAL NEEDS CHILDREN, PERSONAL SERVICES, RESPITE CARE, GRIEF AND BEREAVEMENT, DISEASE PREVENTION, STRESS, STRESS REDUCTION, HEALTHY AGING, DIABETES FIGHTING, CANCER FIGHTING, HEALTHY HEART MAINTENANCE, SMOKING CESSATION, HEALTH RISK ASSESSMENT, QUALITY OF LIFE ENHANCEMENT, HOUSE CLEANING, EVENT PLANNING, HOME IMPROVEMENT, SELF HELP, DIET, GENERAL HEALTH, MEDICATIONS, MEN'S, WOMEN'S, CHILDREN'S AND SENIOR HEALTH, PRENATAL HEALTH, WORKPLACE HEALTH, HOME SAFETY, WORKPLACE SAFETY, CHILD SAFETY, SENIOR COUNSELING, CHILD DEVELOPMENT, CHILD DISABILITIES, GIFTED AND TALENTED CHILDREN, PARENTING, PRENATAL CARE, SUMMER CAMP PROGRAMS, WORK AND FAMILY LIFE, ANXIETY, DEPRESSION, EDUCATION, FINANCIAL AID, TUTORING, EXTRACURRICULAR ACTIVITIES, CREDIT/DEBT MANAGEMENT, ESTATE PLANNING, FINANCE, GOVERNMENT PROGRAMS, WORKPLACE COUNSELING, LACTATION, BREASTFEEDING, AND WEANING (U.S. CLS. 2, 5, 22, 23, 29, 37, 38 AND 50).

FIRST USE 3-16-2006; IN COMMERCE 3-16-2006.

CLASS 35—ADVERTISING AND BUSINESS

FOR PREPARING BUSINESS MANAGEMENT REPORTS; BUSINESS MANAGEMENT CONSULTATION SERVICES FOR OTHERS; BUSINESS MEETING, EVALUATION, AND PLANNING SERVICES, NAMELY, ARRANGING FOR GERIATRIC CARE MANAGERS, IN-HOME ASSESSMENTS OF ELDER'S HOMES AND ACTIVITIES OF DAILY LIVING, VISITS AND TOURS TO ELDERCARE FACILITIES; BUSINESS CONSULTATION SERVICES, NAMELY, PROVIDING CONSULTATION TO EMPLOYERS IN IMPLEMENTING AND MANAGING PRE-RETIREMENT AND POST-RETIREMENT PROGRAMS AND COMMUNICATIONS, PENSION AND BENEFITS MODELING AND BUSINESS CONSULTATION PROVIDED TO EMPLOYERS, EVALUATING HUMAN RESOURCE POLICIES AND BENEFITS, BENCHMARKING HUMAN RESOURCE POLICIES AND BENEFITS AGAINST COMPETITORS' OFFERINGS, AUDITING EXISTING EMPLOYEE BENEFITS AND POLICIES TO IDENTIFY GAPS IN SERVICES, PERFORMING COMPARATIVE ANALYSES OF SIMILAR ORGANIZATIONS' EMPLOYEE BENEFITS AND POLICIES, DOCUMENTING AND QUANTIFYING THE PERFORMANCE OF EMPLOYER'S WORK/LIFE INITIATIVES, PROVIDING DATA ON UTILIZATION OF EMPLOYEE BENEFITS, PROVIDING DATA ON EMPLOYEE SATISFACTION, PROVIDING DATA ON RETURN ON INVESTMENT FOR EMPLOYEE BENEFITS, PROVIDING WEB-BASED MANAGEMENT OF EMPLOYEE FLEXIBLE WORK ARRANGEMENTS, AND PROMOTING USAGE OF BENEFIT PROGRAMS VIA PRINT, E-MAIL, VOICE MAIL, MULTIMEDIA, AND GLOBAL AND PROPRIETARY COMMUNICATION NETWORKS; REFERRAL SERVICES AND ONLINE REFERRAL SERVICES IDENTIFYING PROVIDERS OF SERVICES IN THE FIELDS OF RETIREMENT PLANNING, POST-RETIREMENT PLANNING, POST-RETIREMENT ACTIVITIES, EMPLOYEE BENEFITS, RETIREMENT LIFESTYLE OPTIONS, PERSONAL RELOCATION, HOUSING, EMPLOYMENT, EMPLOYEE FINANCIAL PLANNING, CHILD CARE AND ADULT CARE, HEALTH AND WELLNESS, MARRIAGE, TRAVEL, VOLUNTEERISM, PET CARE, EDUCATION, EMERGENCY MEDICAL CARE, SUPPORT GROUPS FOR THE ELDERLY, ELDERCARE, DEPENDENT CARE, ADOPTION, SPECIAL NEEDS CHILDREN, PERSONAL SERVICES IN THE NATURE OF COMPANIONSHIP FOR THE ELDERLY, HOME MEAL DELIVERY, AND RUNNING ERRANDS, RESPITE CARE, GRIEF AND BEREAVEMENT, PROFESSIONAL SERVICES, DISEASE PREVENTION, STRESS, STRESS REDUCTION, HEALTHY AGING, DIABETES FIGHTING, CANCER FIGHTING, HEALTHY HEART MAINTENANCE, SMOKING CESSATION, HEALTH RISK ASSESSMENT, QUALITY OF LIFE ENHANCEMENT, HOUSE CLEANING, EVENT PLANNING, HOME IMPROVEMENT, MOVING/RELOCATION, SELF HELP, DIET/NUTRITION, GENERAL HEALTH, MEDICATIONS, MEN'S, WOMEN'S, CHILDREN'S AND SENIOR HEALTH, PRENATAL HEALTH, WORKPLACE HEALTH, HOME SAFETY, WORKPLACE SAFETY, CHILD SAFETY, SENIOR COUNSELING, CHILD DEVELOPMENT, CHILD DISABILITIES, GIFTED AND TALENTED CHILDREN, PARENTING, PRENATAL CARE, SUMMER CAMP PROGRAMS, BALANCING WORK AND FAMILY LIFE, ANXIETY, DEPRESSION, FINANCIAL AID, TUTORING, EXTRACURRICULAR COMMUNITY ACTIVITIES, CREDIT/DEBT MANAGEMENT, ESTATE PLANNING, FINANCE, GOVERNMENT PROGRAMS, WORKPLACE COUNSELING, LACTATION, BREASTFEEDING, AND WEANING; PROVIDING INFORMATION IN THE FIELD OF HEALTH CARE UTILIZATION AND REVIEW SERVICES, NAMELY INFORMATION CONCERNING GERIATRIC CARE MANAGEMENT, IN-HOME ASSESSMENT OF PHYSICAL AND MENTAL CONDITION OF GERIATRIC CARE RECIPIENTS, HOME CARE PLANNING, ASSISTED LIVING AND LONG-TERM CARE PLANNING, EVALUATION OF GERIATRIC CARE FACILITIES AND PROVIDERS, GERIATRIC CARE RECIPIENT RELOCATION ASSISTANCE, GERIATRIC HEALTH CARE MONITORING, AND PERSONAL BUS AND AUTOMOBILE TRANSPORTATION PLANNING FOR GERIATRIC CARE RECIPIENTS; BUSINESS ADMINISTRATION IN THE FIELD OF DEPENDENT CARE; BUSINESS CONSULTATION SERVICES, NAMELY, ADVISING EMPLOYERS IN ESTABLISHING BREASTFEEDING CENTERS FOR NURSING EMPLOYEES; PROVIDING INFORMATION, ON-LINE INFORMATION VIA A COM-

PUTER NETWORK, TELEPHONE HOTLINE SUPPORT, AND CONSULTATION IN CONNECTION THEREWITH IN THE FIELDS OF PERSONAL RELOCATION SERVICES, VOLUNTEERISM AND EMPLOYMENT; ADMINISTRATION OF A DISCOUNT PROGRAM FOR ENABLING PARTICIPANTS TO OBTAIN DISCOUNTS ON GOODS AND SERVICES FROM PARTICIPATING PROVIDERS; ADVISORY SERVICES RELATED TO BUSINESS MANAGEMENT IN ASSISTING EMPLOYERS IN ESTABLISHING LACTATION CENTERS FOR NURSING MOTHERS; BUSINESS ANALYSES SERVICES, NAMELY, PROVIDING RETURN ON INVESTMENT ANALYSES TO EMPLOYERS RELATING TO THE PROVIDING OF VARIOUS WORK- AND LIFE-RELATED PROGRAMS AND SERVICES; APPOINTMENT SCHEDULING SERVICES FOR HEALTHCARE; PROVIDING HUMAN RESOURCE INFORMATION VIA A COMPUTER NETWORK; AND PRESCRIPTION DISCOUNT PROGRAMS FOR THE ELDERLY (U.S. CLS. 100, 101 AND 102).

FIRST USE 2-1-2006; IN COMMERCE 2-1-2006.

CLASS 36—INSURANCE AND FINANCIAL

FOR PROVIDING INFORMATION, ON-LINE INFORMATION VIA A COMPUTER NETWORK, TELEPHONE HOTLINE SUPPORT, AND CONSULTATION IN CONNECTION THEREWITH IN THE FIELDS OF RETIREMENT AND POST-RETIREMENT FINANCIAL PLANNING; ADMINISTRATION OF BREAST PUMP FINANCIAL SUBSIDY PROGRAMS FOR OTHERS; ESTATE PLANNING SERVICES; COUNSELING AND PROVIDING INFORMATION TO THE EMPLOYEES OF OTHERS IN THE FIELDS FINANCIAL RETIREMENT PLANNING AND ESTATE PLANNING (U.S. CLS. 100, 101 AND 102).

FIRST USE 2-1-2006; IN COMMERCE 2-1-2006.

CLASS 39—TRANSPORTATION AND STORAGE

FOR PROVIDING INFORMATION IN THE FIELD OF PERSONAL BUS AND AUTOMOBILE TRANSPORTATION PLANNING FOR GERIATRIC CARE RECIPIENTS; CONSULTATION REGARDING HOME MEAL DELIVERY PROGRAMS FOR THE ELDERLY (U.S. CLS. 100 AND 105).

FIRST USE 2-1-2006; IN COMMERCE 2-1-2006.

CLASS 41—EDUCATION AND ENTERTAINMENT

FOR EDUCATIONAL SERVICES, NAMELY, CONDUCTING CLASSES, SEMINARS AND WORKSHOPS RELATING TO ELDERCARE, RETIREMENT, RETIREMENT PLANNING, POST-RETIREMENT PLANNING, EMPLOYER PENSION PLANS AND BENEFITS, GOVERNMENT BENEFITS AND ENTITLEMENTS, HOUSING, FINANCIAL, WORK, LIFESTYLE, HEALTH AND WELLNESS OPTIONS RELATING TO ELDERCARE AND RETIREMENT, BREAST FEEDING AWARENESS IN THE WORK PLACE, AND SENSITIVITY AND TRAINING FOR MANAGERS RELATING TO BREAST FEEDING IN THE WORK PLACE; TRAINING BUSINESS MANAGERS, EMPLOYEES AND HUMAN RESOURCE STAFF ON HOW TO INITIATE, MANAGE AND TERMINATE FLEXIBLE WORK ARRANGEMENTS AND OTHER EMPLOYEE BENEFITS; COUNSELING IN THE FIELD OF EDUCATION; PERSONAL COACHING SERVICES IN THE FIELD OF HEALTH, NAMELY, COACHING IN THE FIELDS OF WEIGHT MANAGEMENT, TOBACCO CESSATION AND STRESS MANAGEMENT SERVICES; PROVIDING INFORMATION, ON-LINE INFORMATION VIA A COMPUTER NETWORK, TELEPHONE HOTLINE SUPPORT, AND CONSULTATION IN CONNECTION THEREWITH IN THE FIELDS OF EDUCATION, SPECIAL EVENT PLANNING, EDUCATIONAL PROGRAMS FOR GIFTED AND TALENTED CHILDREN, SUMMER CAMP PROGRAMS, TUTORING, EXTRACURRICULAR SPORTS AND EDUCATIONAL ACTIVITIES; AND PARENTING CONCERNING EDUCATION AND ENTERTAINMENT OF CHILDREN (U.S. CLS. 100, 101 AND 107).

FIRST USE 1-31-2006; IN COMMERCE 1-31-2006.

CLASS 42—SCIENTIFIC AND COMPUTER SERVICES

FOR COMPUTER SERVICES, NAMELY, DESIGNING AND IMPLEMENTING INTERACTIVE INTERNAL INFORMATION NETWORK WEB SITES FOR OTHERS IN THE FIELDS OF RETIREMENT PLANNING, POST-RETIREMENT PLANNING, POST-RETIREMENT ACTIVITIES, EMPLOYEE BENEFITS, RETIREMENT LIFESTYLE OPTIONS, RELOCATION, HOUSING, EMPLOYMENT, EMPLOYEE FINANCIAL PLANNING, CHILD CARE AND ADULT CARE, HEALTH AND WELLNESS, NUTRITION, MARRIAGE, TRAVEL, VOLUNTEERISM, PET CARE, EMERGENCY CARE, SUPPORT GROUPS FOR THE ELDERLY, ADOPTION, SPECIAL NEEDS CHILDREN, EDUCATION, PERSONAL SERVICES, RESPITE CARE, GRIEF AND BEREAVEMENT, DISEASE PREVENTION, STRESS, STRESS REDUCTION, HEALTHY AGING, DIABETES FIGHTING, CANCER FIGHTING, HEALTHY HEART MAINTENANCE, SMOKING CESSATION, HEALTH RISK ASSESSMENT, QUALITY OF LIFE ENHANCEMENT, CLEANING, EVENT PLANNING, HOME IMPROVEMENT, MOVING, SELF HELP, DIET, GENERAL HEALTH, MEDICATIONS, MEN'S, WOMEN'S, CHILDREN'S AND SENIOR HEALTH, PRENATAL HEALTH, WORKPLACE HEALTH, SAFETY, SENIOR COUNSELING, CHILD DEVELOPMENT, CHILD DISABILITIES, GIFTED AND TALENTED CHILDREN, PARENTING, PRENATAL CARE, SUMMER PROGRAMS, WORK AND FAMILY LIFE, ANXIETY, DEPRESSION, FINANCIAL AID, TUTORING, EXTRACURRICULAR ACTIVITIES, CREDIT/DEBT MANAGEMENT, ESTATE PLANNING, FINANCE, GOVERNMENT PROGRAMS, WORKPLACE COUNSELING, LACTATION, BREASTFEEDING, AND WEANING; COMPUTER SERVICES, NAMELY, INTEGRATING EXISTING BUSINESS EMPLOYEE RELATIONSHIP MANAGEMENT PROGRAMS INTO EMPLOYER'S WEB SITES TO PROVIDE ON-LINE INFORMATION SERVICES IN THE FIELDS OF PRE-RETIREMENT AND POST-RETIREMENT PLANNING; COMPUTER SOFTWARE DEVELOPMENT, NAMELY, DEVELOPMENT OF INTERACTIVE INFORMATION NETWORK USER INTERFACES FOR OTHERS; HOSTING THE WEB SITES OF OTHERS ON A COMPUTER SERVER FOR A GLOBAL COMMUNICATIONS NETWORK; APPLICATION SERVICE PROVIDER SERVICES, NAMELY, PROVIDING TEMPORARY USE OF NON-DOWNLOADABLE SOFTWARE IN THE FIELD OF EMPLOYEE BENEFITS AND RETIREMENT FOR PROVIDING INFORMATION RELATING TO EMPLOYEE BENEFITS AND RETIREMENT; TECHNICAL SUPPORT, NAMELY, MONITORING OF NETWORK SYSTEMS; MAINTAINING WEB SITES FOR OTHERS; AND PROVIDING QUALITY ASSURANCE SERVICES IN THE FIELD OF GERIATRIC CARE MANAGEMENT (U.S. CLS. 100 AND 101).

FIRST USE 2-1-2006; IN COMMERCE 2-1-2006.

CLASS 43—HOTEL AND RESTAURANT SERVICES

FOR CONSULTATION SERVICES IN THE FIELDS OF ADULT DAY CARE AND ASSISTED LIVING FACILITIES, RETIREMENT COMMUNITIES, AND LONG-TERM CARE FACILITIES; PROVIDING INFORMATION, ON-LINE INFORMATION VIA A COMPUTER NETWORK, TELEPHONE HOTLINE SUPPORT, AND CONSULTATION IN CONNECTION IN THE FIELDS OF RETIREMENT HOMES, ELDERCARE, AND ACTIVITIES PLANNED AND ORGANIZED IN FURTHERANCE THEREOF (U.S. CLS. 100 AND 101).

FIRST USE 2-1-2006; IN COMMERCE 2-1-2006.

CLASS 44—MEDICAL, BEAUTY AND AGRICULTURAL SERVICES

FOR PROVIDING INFORMATION, ON-LINE INFORMATION VIA A COMPUTER NETWORK, TELEPHONE HOTLINE SUPPORT, AND CONSULTATION IN CONNECTION THEREWITH IN THE FIELD OF PARENTING TOPICS, NAMELY, DRUG AWARENESS, ALCOHOL AWARENESS, AND THE HEALTH OF CHILDREN (U.S. CLS. 100 AND 101).

FIRST USE 2-1-2006; IN COMMERCE 2-1-2006.

CLASS 45—PERSONAL AND LEGAL SERVICES

SN 78-843,553. BOWTIE, INC., IRVINE, CA. FILED 3-22-2006.

FOR PROVIDING INFORMATION, ON-LINE INFORMATION VIA A COMPUTER NETWORK, TELEPHONE HOTLINE SUPPORT, AND CONSULTATION IN CONNECTION THEREWITH IN THE FIELDS OF ADOPTION, GRIEF AND BEREAVEMENT, SELF HELP, HOME SAFETY, WORKPLACE SAFETY, CHILD SAFETY, PARENTING CONCERNING INTRAFAMILY RELATIONSHIPS, AND PERSONAL SERVICES IN THE NATURE OF COMPANIONSHIP FOR THE ELDERLY, HOME MEAL DELIVERY, AND RUNNING ERRANDS (U.S. CLS. 100 AND 101).

FIRST USE 2-1-2006; IN COMMERCE 2-1-2006.
KATHERINE CHANG, EXAMINING ATTORNEY



OWNER OF U.S. REG. NO. 2,708,126.
NO CLAIM IS MADE TO THE EXCLUSIVE RIGHT TO USE "PRESS", APART FROM THE MARK AS SHOWN.
THE MARK CONSISTS OF THE WORDS HOBBY FARM PRESS, THE LETTERS HF WITHIN A SQUARE WITH CONTRASTING SHADES OF GRAY, AND A STALK OF WHEAT.

SEC. 2(F) AS TO "HOBBY FARM".

SN 78-843,392. DIGITAL PHOTOGRAPHY INNOVATIONS, INC., CHARLOTTE, NC. FILED 3-22-2006.

CLASS 16—PAPER GOODS AND PRINTED MATTER

FOR BOOKS IN THE FIELD OF ANIMALS, HORTICULTURE AND AGRICULTURE (U.S. CLS. 2, 5, 22, 23, 29, 37, 38 AND 50).

FIRST USE 5-0-2005; IN COMMERCE 5-0-2005.

DIRECTORY INNOVATIONS**CLASS 41—EDUCATION AND ENTERTAINMENT**

FOR PUBLICATION OF BOOKS (U.S. CLS. 100, 101 AND 107).

FIRST USE 5-0-2005; IN COMMERCE 5-0-2005.
SCOTT SISUN, EXAMINING ATTORNEY

THE MARK CONSISTS OF STANDARD CHARACTERS WITHOUT CLAIM TO ANY PARTICULAR FONT, STYLE, SIZE, OR COLOR.

NO CLAIM IS MADE TO THE EXCLUSIVE RIGHT TO USE "DIRECTORY", APART FROM THE MARK AS SHOWN.

SN 78-854,429. BASF AKTIENGESELLSCHAFT, LUDWIGSHAFEN, FED REP GERMANY, FILED 4-5-2006.

CLASS 35—ADVERTISING AND BUSINESS

FOR PREPARING PICTORIAL DIRECTORIES FOR CHURCHES, SCHOOLS, FAMILIES, CLUBS, ASSOCIATIONS, BANDS, BROTHERHOODS, BUSINESSES, CIRCLES, COMPANIES, COOPERATIVES, CORPORATIONS, ESTABLISHMENTS, FEDERATIONS, FELLOWSHIPS, FRATERNITIES, GUILDS, INDUSTRIES, INSTITUTIONS, LEAGUES, LODGES, MUSICAL GROUPS, ORCHESTRAS, PROFESSIONS, SORORITIES, SQUADS, TEAMS, TRADE ASSOCIATIONS, TROUPES, AND UNIONS (U.S. CLS. 100, 101 AND 102).

FIRST USE 2-1-2005; IN COMMERCE 2-1-2005.

**CLASS 41—EDUCATION AND ENTERTAINMENT**

FOR PHOTOGRAPHY SERVICES (U.S. CLS. 100, 101 AND 107).

FIRST USE 2-1-2005; IN COMMERCE 2-1-2005.
AMOS T. MATTHEWS, JR., EXAMINING ATTORNEY

OWNER OF FED REP GERMANY REG. NO. 30503435, DATED 7-6-2005, EXPIRES 1-31-2015.

OWNER OF U.S. REG. NOS. 809,060, 2,478,348 AND OTHERS.

CLASS 1—CHEMICALS

FOR CHEMICAL PRODUCTS FOR INDUSTRIAL PURPOSES, NAMELY, RAW MATERIALS AND AUXILIARY AGENTS FOR THE PLASTICS MANUFACTURING AND PROCESSING INDUSTRIES; UNPROCESSED PLASTICS IN THE CRUDE STATE IN THE FORM OF POWDERS, GRANULES, PASTES, LIQUIDS (U.S. CLS. 1, 5, 6, 10, 26 AND 46).

CLASS 17—RUBBER GOODS

FOR SEMI-PROCESSED AND INSULATING MATERIALS MADE FROM PLASTICS IN THE FORM OF BOARDS, RODS OR PIPES; SEMI-PROCESSED AND INSULATING MATERIALS MADE FROM PLASTICS IN THE FORM OF BLOCKS MOLDED PARTS, NAMELY, BLOCKS AND OTHER PRE-SHAPED FORMS (U.S. CLS. 1, 5, 12, 13, 35 AND 50).

SAMUEL E. SHARPER JR., EXAMINING ATTORNEY

SN 78-855,747. GENERAL MILLS MARKETING, INC., MINNEAPOLIS, MN. FILED 4-6-2006.

NOURISHING LIVES

THE MARK CONSISTS OF STANDARD CHARACTERS WITHOUT CLAIM TO ANY PARTICULAR FONT, STYLE, SIZE, OR COLOR.

CLASS 29—MEATS AND PROCESSED FOODS

FOR FOOD PRODUCTS, NAMELY, INSTANT POTATOES; CANNED, FROZEN, COOKED OR PRESERVED VEGETABLES; FROZEN VEGETABLE COMBINATION; DAIRY PRODUCTS, EXCLUDING ICE CREAM, ICE MILK, AND FROZEN YOGURT; FRUIT-BASED SNACK FOOD; SOY-BASED BEVERAGES BEING USED AS A MILK SUBSTITUTE; CANNED SOUPS (U.S. CL. 46).

CLASS 30—STAPLE FOODS

FOR FOOD PRODUCTS, NAMELY, BAKING MIXES, CAKE MIXES, BROWNIE MIXES, COOKIE MIXES, MUFFIN MIXES, PIE CRUST MIXES, FROSTING MIXES, BISCUIT MIXES, PANCAKE AND WAFFLE MIXES, AND FROSTINGS; PROCESSED CEREAL-DERIVED FOOD PRODUCTS TO BE USED AS A BREAKFAST CEREAL, SNACK FOOD, OR INGREDIENT FOR MAKING FOOD; CANNED SPANISH RICE; CANNED AND BOTTLED SALSA; FLOUR TORTILLAS; KITS FOR TACO DINNERS CONTAINING TACO SHELLS, TACO SAUCE AND DRY TACO SEASONING MIX; PACKAGED DINNER MIXES CONSISTING PRIMARILY OF STUFFING MIXES CONTAINING BREAD AND GRAVY OR HAVING EITHER A CEREAL BASE, A PASTA BASE, A VEGETABLE BASE, A RICE BASE, OR A COMBINATION THEREOF; FROZEN PIZZA AND PIZZA SNACKS; BREAKFAST PASTRIES; REFRIGERATED AND FROZEN DOUGH; FROZEN BREAKFAST FOODS, NAMELY, PANCAKES, WAFFLES, FRENCH TOAST STICKS AND WAFFLE STICKS; POPCORN; READY-TO-EAT, CEREAL-DERIVED FOOD BARS; AND VINEGAR (U.S. CL. 46).

WON TEAK OH, EXAMINING ATTORNEY

SN 78-858,805. BORDERWARE TECHNOLOGIES INC., MISSISSAUGA, ONTARIO, CANADA, FILED 4-11-2006.

SIPASSURE

THE MARK CONSISTS OF STANDARD CHARACTERS WITHOUT CLAIM TO ANY PARTICULAR FONT, STYLE, SIZE, OR COLOR.

PRIORITY CLAIMED UNDER SEC. 44(D) ON ERPNCMNTY TM OFC APPLICATION NO. 005033071, FILED 4-4-2006, REG. NO. 005033071, DATED 2-13-2007, EXPIRES 4-4-2016.

CLASS 9—ELECTRICAL AND SCIENTIFIC APPARATUS

FOR COMPUTER HARDWARE AND SOFTWARE THAT PROVIDES DIGITAL COMMUNICATIONS SECURITY BY SCANNING, FILTERING, IDENTIFYING, DETECTING, AUTHENTICATING, AUTHORIZING AND/OR BLOCKING DIGITAL COMMUNICATIONS (U.S. CLS. 21, 23, 26, 36 AND 38).

FIRST USE 2-0-2005; IN COMMERCE 2-0-2005.

CLASS 35—ADVERTISING AND BUSINESS

FOR BUSINESS MANAGEMENT AND MARKETING CONSULTING IN THE FIELD OF SOFTWARE SECURITY FOR DIGITAL COMMUNICATIONS (U.S. CLS. 100, 101 AND 102).

FIRST USE 2-0-2005; IN COMMERCE 2-0-2005.

CLASS 42—SCIENTIFIC AND COMPUTER SERVICES

FOR TECHNICAL SUPPORT SERVICES, NAMELY, TROUBLESHOOTING OF COMPUTER HARDWARE AND SOFTWARE THAT PROVIDES DIGITAL COMMUNICATIONS SECURITY (U.S. CLS. 100 AND 101).

FIRST USE 2-0-2005; IN COMMERCE 2-0-2005.

LESLEY LAMOTHE, EXAMINING ATTORNEY

SN 78-860,795. PURICORE, INC., MALVERN, PA. FILED 4-13-2006.

PURICORE

THE MARK CONSISTS OF STANDARD CHARACTERS WITHOUT CLAIM TO ANY PARTICULAR FONT, STYLE, SIZE, OR COLOR.

CLASS 10—MEDICAL APPARATUS

FOR FLUID CHEMICAL BIOCIDES DISPENSING MACHINES FOR CLEANSING, DISINFECTING, STERILIZING OR WASHING WOUNDS, BURNS, INVASIVE SURGICAL OPENINGS, HANDS, OTHER SKIN AREAS AND MEDICAL AND DENTAL INSTRUMENTS; MEDICAL ELECTRIC GENERATORS SOLD AS A COMPONENT OF STERILIZING AND DISINFECTION SOLUTION DISPENSING MACHINES RELATING TO WOUND CARE; STERILIZATION AND DISINFECTION GENERATORS AND UNITS FOR MEDICAL AND DENTAL USE AND MEDICAL AND DENTAL INSTRUMENTS AND APPLICATIONS; GENERATORS FOR PRODUCING ALL-PURPOSE STERILIZING AND DISINFECTION SOLUTIONS AND RINSE WATER FOR MEDICAL, DENTAL AND OPERATING ROOM DECONTAMINATION USE (U.S. CLS. 26, 39 AND 44).

CLASS 11—ENVIRONMENTAL CONTROL APPARATUS

FOR GENERATORS FOR PRODUCING ALL-PURPOSE STERILIZING AND DISINFECTION SOLUTIONS AND RINSE WATER FOR FOOD SAFETY AND HOSPITALITY ROOM DECONTAMINATION USE (U.S. CLS. 13, 21, 23, 31 AND 34).

ALICIA COLLINS, EXAMINING ATTORNEY

SN 78-863,332. ISABELL, LLC, RED HOOK, NY. FILED 4-18-2006.

FRESH CUTTINGS

THE MARK CONSISTS OF STANDARD CHARACTERS WITHOUT CLAIM TO ANY PARTICULAR FONT, STYLE, SIZE, OR COLOR.

CLASS 3—COSMETICS AND CLEANING PREPARATIONS

FOR HOME SPRAYS, NAMELY SCENTED ROOM SPRAYS; FRAGRANCES FOR PERSONAL USE; PERFUMES; SKIN SOAPS, BODY LOTIONS, BATH AND SHOWER GELS, BODY SCRUBS, SACHETS (U.S. CLS. 1, 4, 6, 50, 51 AND 52).

FIRST USE 2-0-1999; IN COMMERCE 2-0-1999.

CLASS 4—LUBRICANTS AND FUELS

FOR CANDLES (U.S. CLS. 1, 6 AND 15).
FIRST USE 2-0-1999; IN COMMERCE 2-0-1999.
JOHN KELLY, EXAMINING ATTORNEY

SN 78-866,779. GERARD GROUP INTERNATIONAL LLC, TYNGSBOROUGH, MA. FILED 4-21-2006.

COLLABORATIVE ANALYTICS

THE MARK CONSISTS OF STANDARD CHARACTERS WITHOUT CLAIM TO ANY PARTICULAR FONT, STYLE, SIZE, OR COLOR.

CLASS 42—SCIENTIFIC AND COMPUTER SERVICES

FOR RESEARCH, DEVELOPMENT, PLANNING AND DESIGN OF SECURITY, ANTI-TERRORISM AND DISASTER PREPAREDNESS PLANS AND PROCEDURES FOR OTHERS (U.S. CLS. 100 AND 101).

FIRST USE 11-30-2005; IN COMMERCE 11-30-2005.

CLASS 45—PERSONAL AND LEGAL SERVICES

FOR CONSULTING IN THE FIELDS OF SECURITY, ANTI-TERRORISM AND DISASTER PREPAREDNESS; REVIEW AND ANALYSIS OF OTHERS' SECURITY ANTI-TERRORISM AND DISASTER PREPAREDNESS PLANS AND PROCEDURES (U.S. CLS. 100 AND 101).

FIRST USE 11-30-2005; IN COMMERCE 11-30-2005.

JACQUELINE A. LAVINE, EXAMINING ATTORNEY

SN 78-877,812. TULLETT PREBON HOLDINGS CORP., NEW YORK, NY. FILED 5-5-2006.

PREBON LATAMLIVE!

THE MARK CONSISTS OF STANDARD CHARACTERS WITHOUT CLAIM TO ANY PARTICULAR FONT, STYLE, SIZE, OR COLOR.

CLASS 9—ELECTRICAL AND SCIENTIFIC APPARATUS

FOR COMPUTER SOFTWARE FOR USE IN PROVIDING ELECTRONIC BROKERAGE TRADING (U.S. CLS. 21, 23, 26, 36 AND 38).

CLASS 36—INSURANCE AND FINANCIAL

FOR FINANCIAL CONSULTATION; FINANCIAL SERVICES, NAMELY INTER-DEALER BROKERAGE SERVICES IN CURRENCY AND CURRENCY DERIVATIVE MARKETS (U.S. CLS. 100, 101 AND 102).

CLASS 42—SCIENTIFIC AND COMPUTER SERVICES

FOR PROVIDING TEMPORARY USE OF ON-LINE NON-DOWNLOADABLE SOFTWARE FOR USE IN PROVIDING ELECTRONIC BROKERAGE TRADING (U.S. CLS. 100 AND 101).

LINDA POWELL, EXAMINING ATTORNEY

SN 78-886,257. FUNFACTOR LLC, NEWPORT BEACH, CA. FILED 5-17-2006.

FUNFACTOR

THE MARK CONSISTS OF STANDARD CHARACTERS WITHOUT CLAIM TO ANY PARTICULAR FONT, STYLE, SIZE, OR COLOR.

CLASS 38—COMMUNICATION

FOR TEXT WIRELESS DIGITAL MESSAGING SERVICES, NAMELY, TRANSMISSION OF TEXT MESSAGES ABOUT FUN FACTS TO WIRELESS PHONES (U.S. CLS. 100, 101 AND 104).

CLASS 41—EDUCATION AND ENTERTAINMENT

FOR ENTERTAINMENT TEXT SERVICES IN THE NATURE OF PRERECORDED MESSAGES CONTAINING FUN AND INTERESTING FACTS BY DIGITAL TEXT MESSAGING TO WIRELESS TELEPHONES (U.S. CLS. 100, 101 AND 107).

HANNO RITTNER, EXAMINING ATTORNEY

SN 78-888,346. STELOR TECHNOLOGIES, LLC, DARNES-TOWN, MD. FILED 5-19-2006.

**APPROVED BY PARENTS,
LOVED BY KIDS,
PROTECTED BY PIXKEY**

THE MARK CONSISTS OF STANDARD CHARACTERS WITHOUT CLAIM TO ANY PARTICULAR FONT, STYLE, SIZE, OR COLOR.

CLASS 9—ELECTRICAL AND SCIENTIFIC APPARATUS

FOR COMPUTER SOFTWARE, NAMELY, OPERATING SYSTEM PROGRAMS AND UTILITIES, WORD PROCESSING PROGRAMS, ADDRESS BOOK PROGRAMS, CALCULATOR PROGRAMS, TERMINAL EMULATION PROGRAMS, PROGRAMS FOR DOWNLOADING AND PLAYING AUDIO AND VIDEO, PROGRAMS FOR MANAGING COMPUTER POWER SUPPLIES, PROGRAMS FOR USE IN TRANSMITTING DATA BETWEEN COMPUTERS AND OTHER ELECTRONIC DEVICES, COMPUTER MAINTENANCE PROGRAMS, PROGRAMS FOR USE IN ACCESSING AND PLAYING CDS, PROGRAMS FOR USE IN ACCESSING AND VIEWING DVDS, BROWSER PROGRAMS, PAINT PROGRAMS; ELECTRONIC MAIL PROGRAMS; PROGRAMS FOR ELECTRONIC CONFERENCING; COMPUTERS AND PARTS THEREFOR, COMPUTER PERIPHERALS, AND FULL LINE OF COMPUTER APPLICATION PROGRAMS; COMPUTERS AND PARTS THEREFOR, COMPUTER PERIPHERALS, COMPUTER PROGRAMS, AND MANUALS THEREFOR SOLD AS A UNIT, FOR USE IN APPLICATIONS WITH GRAPHICAL USER INTERFACES; COMPUTER SERVERS; OPERATING SYSTEM PROGRAMS THEREFORE AND A FULL LINE OF COMPUTER APPLICATION PROGRAMS FOR USE THEREWITH; COMPUTER PROGRAMS FOR MANAGING COMMUNICATIONS AND DATA EXCHANGE BETWEEN COMPUTERS AND ELECTRONIC DEVICES; COMPUTER HARDWARE AND PERIPHERALS; COMPUTER KEYBOARDS; COMPUTER AND VIDEO GAME JOYSTICKS AND GAME CONTROLLERS; COMPUTER GAME PADS AND CONTROLLERS; COMPUTER PERIPHERALS, NAMELY, COMPUTER MICE AND OTHER POINTING DEVICES; COMPUTER SOFTWARE FOR PLAYING VIDEO GAMES AND COMPUTER GAMES; COMPUTER SOFTWARE FOR ADAPTIVE TRAINING OF THE USER, INCORPORATING REAL-TIME INTERFACE OF THE USER WITH REALISTIC ENVIRONMENTS UNDER CHANGING CONDITIONS GUIDED BY THE SOFTWARE IN RESPONSE TO USER ACTIONS AND CHOICES; COMPUTER ANTIVIRUS SOFTWARE; INTERNET SECURITY SOFTWARE; INTRUSION DETECTION SOFTWARE; FIREWALL SOFTWARE; PRIVACY CONTROL SOFTWARE; CONTENT

FILTERING SOFTWARE; COMPUTER SOFTWARE FOR THE CREATION OF A VIRTUAL PRIVATE NETWORK; COMPUTER UTILITY SOFTWARE FOR REMOVAL OF COMPUTER APPLICATIONS AND SOFTWARE; COMPUTER SOFTWARE AND DOWNLOADABLE COMPUTER SOFTWARE FOR USE IN UPDATING OTHER COMPUTER SOFTWARE; COMPUTER SOFTWARE FOR USE IN NETWORKING APPLICATIONS, NAMELY, COMMUNICATIONS SOFTWARE FOR CONNECTING COMPUTER NETWORK USERS; COMPUTER SOFTWARE FOR PROVIDING SECURITY TO REMOTE COMPUTER USERS, COMPUTER SOFTWARE FOR FILE MANAGEMENT AND TRANSFER; COMPUTER HARDWARE APPLIANCES THAT PROVIDE FIREWALL, CONTENT FILTERING, INTRUSION ALERT, VIRUS PROTECTION, VIRTUAL PRIVATE NETWORKING AND OTHER SECURITY FUNCTIONS; USER MANUALS SUPPLIED WITH ALL OF THE FOREGOING (U.S. CLS. 21, 23, 26, 36 AND 38).

CLASS 28—TOYS AND SPORTING GOODS

FOR ELECTRONIC EDUCATIONAL GAME MACHINES; LEARNING TOYS FOR CHILDREN; EQUIPMENT SOLD AS A UNIT FOR PLAYING ELECTRONIC GAMES WITH LCD SCREEN WHICH FEATURES ANIMATION AND SOUND EFFECTS; ELECTRONIC ACTION TOYS; HAND HELD UNIT FOR PLAYING ELECTRONIC GAMES; AND HAND HELD UNIT FOR PLAYING VIDEO GAMES. (U.S. CLS. 22, 23, 38 AND 50).

CLASS 38—COMMUNICATION

FOR TELECOMMUNICATIONS SERVICES, NAMELY, ELECTRONIC TRANSMISSION OF DATA, IMAGES AND DOCUMENTS VIA COMPUTER TERMINALS; ELECTRONIC MAIL SERVICES; AND FACSIMILE TRANSMISSION (U.S. CLS. 100, 101 AND 104).

ALEXANDER L. POWERS, EXAMINING ATTORNEY

SN 78-889,082. ATRONIC INTERNATIONAL GMBH, LÜB-BECKE, FED REP GERMANY, FILED 5-22-2006.

Deep Diamonds

THE MARK CONSISTS OF STANDARD CHARACTERS WITHOUT CLAIM TO ANY PARTICULAR FONT, STYLE, SIZE, OR COLOR.

PRIORITY CLAIMED UNDER SEC. 44(D) ON ERPN CMNTY TM OFC APPLICATION NO. 005076625, FILED 5-16-2006, REG. NO. 005076625, DATED 6-8-2007, EXPIRES 5-16-2016.

CLASS 9—ELECTRICAL AND SCIENTIFIC APPARATUS

FOR ELECTRIC AND ELECTRONIC, COIN AND TOKEN-OPERATED GAMING MACHINES, NAMELY, SLOT MACHINES WITH OR WITHOUT VIDEO OUTPUT AND VIDEO LOTTERY TERMINALS; MULTI-USER AND NETWORKED GAMING MACHINES WITH OR WITHOUT VIDEO OUTPUT OR VIDEO LOTTERY TERMINALS, COMPUTER PROGRAMS FOR OPERATING ELECTRIC AND ELECTRONIC MACHINES FOR GAMING AND/OR AMUSEMENT PURPOSES; ACCOUNTING APPARATUS FOR COIN AND TOKEN OPERATED MACHINES FOR GAMING AND AMUSEMENT PURPOSES, AND PARTS FOR THE AFORESAID GOODS (U.S. CLS. 21, 23, 26, 36 AND 38).

CLASS 41—EDUCATION AND ENTERTAINMENT

FOR ENTERTAINMENT IN THE NATURE OF CASINO SERVICES FEATURING A PROGRESSIVE GAMING MACHINE JACKPOT INVOLVING ONE OR MORE GAMING MACHINES, NAMELY, A JACKPOT OR PRIZE WITH A FIXED MINIMUM VALUE WHICH INCREASES UNTIL THE JACKPOT IS WON (U.S. CLS. 100, 101 AND 107).

KYLE PEETE, EXAMINING ATTORNEY

SN 78-893,180. FLEETNET AMERICA, INC., CHERRYVILLE, NC. FILED 5-25-2006.

TMCARE

THE MARK CONSISTS OF STANDARD CHARACTERS WITHOUT CLAIM TO ANY PARTICULAR FONT, STYLE, SIZE, OR COLOR.

CLASS 35—ADVERTISING AND BUSINESS

FOR LOGISTICS MANAGEMENT IN THE FIELD OF DELIVERY VEHICLE MAINTENANCE (U.S. CLS. 100, 101 AND 102).

FIRST USE 6-1-2006; IN COMMERCE 6-1-2006.

CLASS 37—CONSTRUCTION AND REPAIR

FOR VEHICLE MAINTENANCE AND REPAIR SERVICES. (U.S. CLS. 100, 103 AND 106).

FIRST USE 6-1-2006; IN COMMERCE 6-1-2006.

JILL PRATER, EXAMINING ATTORNEY

SN 78-895,487. BRUNO SPECIALTY FOODS, INC., WEST SAYVILLE, NY. FILED 5-30-2006.



THE COLOR(S) RED, WHITE AND GREEN IS/ARE CLAIMED AS A FEATURE OF THE MARK.

THE MARK CONSISTS OF THE WORD BRUNO IN RED, SURROUNDED BY A RECTANGLE OUTLINED IN GREEN. A RED LINE PASSES BEHIND THE BOTTOM OF THE RECTANGLE, AND THE BACKGROUND OF THE MARK IS WHITE.

CLASS 29—MEATS AND PROCESSED FOODS

FOR PREPARED FOOD PRODUCTS NAMELY MEAT, CHEESE, TOMATO AND OTHER SAUCES FOR FOOD SERVICES, INSTITUTIONAL FOOD SALES AND CATERING; PROCESSED AND COOKED FRUITS AND VEGETABLES FOR FOOD SERVICES, INSTITUTIONAL FOOD SALES AND CATERING (U.S. CL. 46).

FIRST USE 8-12-1988; IN COMMERCE 8-12-1988.

CLASS 30—STAPLE FOODS

FOR PRE-PACKAGED DINNERS CONSISTING PRIMARILY OF MEAT AND CHEESE FILLED PASTA, BREADS, PASTAS, PREPARED FOODS FROM FLOUR, CEREAL, YEAST, BAKING SODA, NAMELY STUFFED SHELLS, CAVATELLI, LASAGNA, RAVIOLI, RAVIOLLETTI, MANICOTTI, TORTELLINI, GNOCCHI, BAKED ZITI, MACARONI AND CHEESE, PASTRIES, SAUCES, NAMELY, TOMATO SAUCE, MARINARA SAUCE, CHEESE SAUCE, BROWN GRAVY, MARSALA SAUCE, FRANCAISE SAUCE, PIZZA SAUCE AND MEAT SAUCE, ALL FOR FOOD SERVICES, INSTITUTIONAL FOOD SALES AND CATERING (U.S. CL. 46).

FIRST USE 8-12-1988; IN COMMERCE 8-12-1988.

AMY BROZENIC, EXAMINING ATTORNEY

SN 78-895,729. FERRA-GILMORE, CHRISTINA, STEVENSON RANCH, CA. FILED 5-30-2006.

The 7 Steps to Stardom

THE MARK CONSISTS OF STANDARD CHARACTERS WITHOUT CLAIM TO ANY PARTICULAR FONT, STYLE, SIZE, OR COLOR.

NO CLAIM IS MADE TO THE EXCLUSIVE RIGHT TO USE "7 STEPS", APART FROM THE MARK AS SHOWN.

CLASS 9—ELECTRICAL AND SCIENTIFIC APPARATUS

FOR DVDS FEATURING INFORMATION ON THE BUSINESS SIDE OF PROMOTING ONESELF IN THE ENTERTAINMENT INDUSTRY (U.S. CLS. 21, 23, 26, 36 AND 38).

FIRST USE 4-14-1990; IN COMMERCE 4-14-1990.

CLASS 16—PAPER GOODS AND PRINTED MATTER

FOR SERIES OF BOOKS FEATURING INFORMATION ON THE BUSINESS SIDE OF PROMOTING ONESELF IN THE ENTERTAINMENT INDUSTRY (U.S. CLS. 2, 5, 22, 23, 29, 37, 38 AND 50).

FIRST USE 4-14-1990; IN COMMERCE 4-14-1990.

SKYE YOUNG, EXAMINING ATTORNEY

SN 78-897,907. WINE RANGER, INC., MOSS BEACH, CA. FILED 6-1-2006.

WINE RANGER CELLARS

THE MARK CONSISTS OF STANDARD CHARACTERS WITHOUT CLAIM TO ANY PARTICULAR FONT, STYLE, SIZE, OR COLOR.

NO CLAIM IS MADE TO THE EXCLUSIVE RIGHT TO USE "WINE" AND "CELLARS", APART FROM THE MARK AS SHOWN.

CLASS 35—ADVERTISING AND BUSINESS

FOR ONLINE RETAIL STORE SERVICES FEATURING WINE AND WINE-RELATED PRODUCTS AND SERVICES; ONLINE CONSIGNMENT STORE SERVICES FEATURING WINE AND WINE-RELATED PRODUCTS AND SERVICES OF OTHERS; ONLINE ADVERTISING OF WINES AND WINE-RELATED PRODUCTS AND SERVICES OF OTHERS; PROCUREMENT SERVICES NAMELY PURCHASING WINES AND WINE-RELATED PRODUCTS AND SERVICES FOR OTHERS; PROVIDING INFORMATION ABOUT WINE AVAILABILITY, PRICE INFORMATION, SALES, AUCTIONS AND INVENTORIES; PROVIDING BUSINESS INFORMATION ABOUT THE WINE INDUSTRY (U.S. CLS. 100, 101 AND 102).

SN 78-897,915. WINE RANGER, INC., MOSS BEACH, CA. FILED 6-1-2006.



NO CLAIM IS MADE TO THE EXCLUSIVE RIGHT TO USE "WINE", APART FROM THE MARK AS SHOWN.

THE COLOR(S) BURGUNDY, TAN, BLACK AND WHITE IS/ARE CLAIMED AS A FEATURE OF THE MARK.

THE MARK CONSISTS OF THE WORDS "WINE" AND "RANGER" IN BLACK ADJACENT TO A BURGUNDY-COLORED WINE BOTTLE DESIGN WITH TAN-COLORED CORK AND BLACK-COLORED FACE MASK WITH DANGLING BLACK STRAPS AND WHITE EYE HOLES.

CLASS 36—INSURANCE AND FINANCIAL

FOR PROVIDING INFORMATION ABOUT WINE APPRAISALS (U.S. CLS. 100, 101 AND 102).

CLASS 35—ADVERTISING AND BUSINESS

FOR ONLINE RETAIL STORE SERVICES FEATURING WINE AND WINE-RELATED PRODUCTS AND SERVICES; ONLINE CONSIGNMENT STORE SERVICES FEATURING WINE AND WINE-RELATED PRODUCTS AND SERVICES OF OTHERS; ONLINE ADVERTISING OF WINES AND WINE-RELATED PRODUCTS AND SERVICES OF OTHERS; PROCUREMENT SERVICES, NAMELY PURCHASING WINES AND WINE-RELATED PRODUCTS AND SERVICES FOR OTHERS; PROVIDING INFORMATION ABOUT WINE AVAILABILITY, PRICE INFORMATION, SALES, AUCTIONS AND INVENTORIES; PROVIDING BUSINESS INFORMATION ABOUT THE WINE INDUSTRY (U.S. CLS. 100, 101 AND 102).

CLASS 40—MATERIAL TREATMENT

FOR PROVIDING INFORMATION IN THE FIELD OF OENOLOGY, NAMELY PROVIDING INFORMATION ABOUT WINEMAKING; PROVIDING INFORMATION ABOUT WINERY SERVICES (U.S. CLS. 100, 103 AND 106).

CLASS 36—INSURANCE AND FINANCIAL

FOR PROVIDING INFORMATION ABOUT WINE APPRAISALS (U.S. CLS. 100, 101 AND 102).

CLASS 41—EDUCATION AND ENTERTAINMENT

FOR PROVIDING INFORMATION IN THE FIELD OF WINE TASTING AND WINE-RELATED ACTIVITIES, NAMELY WINERY TOURS, FESTIVALS, WINE TASTINGS AND WINE TASTING COMPETITIONS; PROVIDING INFORMATION ABOUT WINERY TOURS; PUBLISHING OF WINE REVIEWS AND WINE RATINGS (U.S. CLS. 100, 101 AND 107).

CLASS 40—MATERIAL TREATMENT

FOR PROVIDING INFORMATION IN THE FIELD OF OENOLOGY, NAMELY PROVIDING INFORMATION ABOUT WINEMAKING; PROVIDING INFORMATION ABOUT WINERY SERVICES (U.S. CLS. 100, 103 AND 106).

CLASS 43—HOTEL AND RESTAURANT SERVICES

FOR PROVIDING INFORMATION IN THE FIELDS OF WINE CHARACTERISTICS, ANTIQUE WINE CHARACTERISTICS AND COLLECTIBLE WINE CHARACTERISTICS (U.S. CLS. 100 AND 101).

CLASS 41—EDUCATION AND ENTERTAINMENT

FOR PROVIDING INFORMATION IN THE FIELD OF WINE TASTING AND WINE-RELATED ACTIVITIES, NAMELY WINERY TOURS, FESTIVALS, WINE TASTINGS AND WINE TASTING COMPETITIONS; PUBLISHING OF WINE REVIEWS AND WINE RATINGS (U.S. CLS. 100, 101 AND 107).

CLASS 43—HOTEL AND RESTAURANT SERVICES

FOR PROVIDING INFORMATION IN THE FIELDS OF WINE CHARACTERISTICS, ANTIQUE WINE CHARACTERISTICS AND COLLECTIBLE WINE CHARACTERISTICS (U.S. CLS. 100 AND 101).

CLASS 44—MEDICAL, BEAUTY AND AGRICULTURAL SERVICES

FOR PROVIDING INFORMATION IN THE FIELD OF VITICULTURE; PROVIDING HORTICULTURAL INFORMATION ABOUT WINE REGIONS AND VINEYARDS (U.S. CLS. 100 AND 101).

ROBERT STRUCK, EXAMINING ATTORNEY

CLASS 44—MEDICAL, BEAUTY AND AGRICULTURAL SERVICES

FOR PROVIDING INFORMATION IN THE FIELD OF VITICULTURE; PROVIDING HORTICULTURAL INFORMATION ABOUT WINE REGIONS AND VINEYARDS (U.S. CLS. 100 AND 101).

ROBERT STRUCK, EXAMINING ATTORNEY

SN 78-901,525. DELTATHREE, INC., NEW YORK, NY.
FILED 6-6-2006.

SN 78-901,627. INTERNATIONAL MYELOMA FOUNDATION, SUITE 206, CA. FILED 6-6-2006.



THE COLOR(S) BLUE AND ORANGE IS/ARE CLAIMED AS A FEATURE OF THE MARK.

THE LETTERS "JO" ARE BLUE AND THE LETTERS "IP" ARE ORANGE. THE SPACE WITHIN THE LETTER "O" IS ORANGE AND THE SPACE WITHIN THE LETTER "P" IS BLUE.

CLASS 9—ELECTRICAL AND SCIENTIFIC APPARATUS

FOR TELECOMMUNICATIONS DEVICES, NAMELY, PORTABLE AND HANDHELD ELECTRONIC DEVICES FOR WIRELESS AND WIRED COMMUNICATIONS, NAMELY, TELEPHONES, HANDSETS, HEADSETS, SPEAKERS, MICROPHONES, EARPHONES; REMOTE CONTROL UNITS FOR ELECTRONIC HOME AUDIO AND VIDEO DEVICES; SET TOP BOXES; PORTABLE AND HANDHELD DIGITAL ELECTRONIC DEVICES FOR RECORDING, ORGANIZING, TRANSMITTING, MANIPULATING, AND REVIEWING TEXT, DATA, AND AUDIO FILES; DOWNLOADABLE SOFTWARE FOR USE IN VOIP COMMUNICATIONS SERVICES (U.S. CLS. 21, 23, 26, 36 AND 38).

CLASS 35—ADVERTISING AND BUSINESS

FOR ONLINE ADVERTISING SERVICES; ADVERTISING SERVICES INVOLVING COUPONS, REBATES AND DISCOUNTS (U.S. CLS. 100, 101 AND 102).

CLASS 38—COMMUNICATION

FOR ELECTRONIC, ELECTRIC, AND DIGITAL TRANSMISSION OF VOICE, DATA, IMAGES, SIGNALS, AND MESSAGES; PROVIDING BROADBAND COMMUNICATIONS; PROVIDING VOICE OVER INTERNET PROTOCOL PEER-TO-PEER COMMUNICATIONS (U.S. CLS. 100, 101 AND 104).

CLASS 42—SCIENTIFIC AND COMPUTER SERVICES

FOR COMPUTER SERVICES AND SOFTWARE DEVELOPMENT FOR OTHERS, NAMELY, DESIGN OF COMPUTER SOFTWARE AND HARDWARE FOR USE IN TELECOMMUNICATIONS AND VOICE OVER INTERNET PROTOCOL (VOIP) APPLICATIONS, DATA TRANSMISSION AND INSTANT MESSAGING SERVICES; INSTALLATION AND MAINTENANCE OF COMPUTER SOFTWARE; PROVIDING TEMPORARY USE OF ONLINE, NON-DOWNLOADABLE COMPUTER SOFTWARE THAT ALLOWS SUBSCRIBERS TO UTILIZE VOIP COMMUNICATION SERVICES (U.S. CLS. 100 AND 101).

JANICE L. MCMORROW, EXAMINING ATTORNEY

MYELOMA TODAY

THE MARK CONSISTS OF STANDARD CHARACTERS WITHOUT CLAIM TO ANY PARTICULAR FONT, STYLE, SIZE, OR COLOR.

OWNER OF U.S. REG. NO. 2,351,688.

NO CLAIM IS MADE TO THE EXCLUSIVE RIGHT TO USE "MYELOMA", APART FROM THE MARK AS SHOWN.

CLASS 9—ELECTRICAL AND SCIENTIFIC APPARATUS

FOR ELECTRONIC PUBLICATIONS RECORDED ON COMPUTER MEDIA OR DOWNLOADABLE, NAMELY, NEWSLETTERS AND JOURNALS ON THE SUBJECT OF AND CONTAINING INFORMATION ABOUT TREATMENT, CARE, MANAGEMENT, PREVENTION, RESEARCH, AND CURE OF MULTIPLE MYELOMA (U.S. CLS. 21, 23, 26, 36 AND 38).

FIRST USE 1-0-2001; IN COMMERCE 1-0-2001.

CLASS 16—PAPER GOODS AND PRINTED MATTER

FOR PRINT NEWSLETTERS AND JOURNALS ON THE SUBJECT OF AND CONTAINING INFORMATION ABOUT TREATMENT, CARE, MANAGEMENT, PREVENTION, RESEARCH, AND CURE OF MULTIPLE MYELOMA (U.S. CLS. 2, 5, 22, 23, 29, 37, 38 AND 50).

FIRST USE 0-0-1992; IN COMMERCE 0-0-1992.

BRIAN PINO, EXAMINING ATTORNEY

SN 78-904,237. INTEGRATIVE NUTRITION, INC., NEW YORK, NY. FILED 6-8-2006.

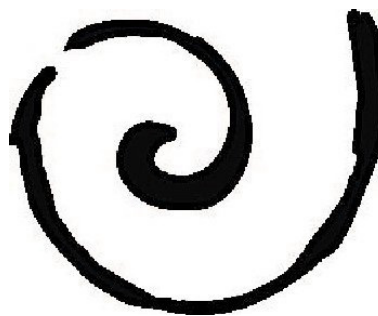

CLASS 9—ELECTRICAL AND SCIENTIFIC APPARATUS

FOR MAGNETS; DVDS AND VIDEO TAPES FEATURING HEALTH AND NUTRITION INFORMATION (U.S. CLS. 21, 23, 26, 36 AND 38).

FIRST USE 1-1-2003; IN COMMERCE 1-1-2003.

CLASS 10—MEDICAL APPARATUS

FOR MESSAGE APPARATUS (U.S. CLS. 26, 39 AND 44).

FIRST USE 1-1-2003; IN COMMERCE 1-1-2003.

CLASS 16—PAPER GOODS AND PRINTED MATTER

FOR BINDERS; BOOKS IN THE FIELD OF HEALTH AND NUTRITION; CALENDARS; BLANK JOURNAL BOOKS; MAGAZINES FEATURING HEALTH AND NUTRITION; NEWSLETTERS FEATURING HEALTH AND NUTRITION; POSTCARDS; NOTEBOOKS; PAPER STATIONERY; BUSINESS CARDS (U.S. CLS. 2, 5, 22, 23, 29, 37, 38 AND 50).

FIRST USE 1-1-2003; IN COMMERCE 1-1-2003.

CLASS 18—LEATHER GOODS

FOR CARRY-ALL BAGS (U.S. CLS. 1, 2, 3, 22 AND 41).
FIRST USE 1-1-2003; IN COMMERCE 1-1-2003.

CLASS 21—HOUSEWARES AND GLASS

FOR VACUUM BOTTLES; MUGS; TRAVEL MUGS; PLASTIC WATER BOTTLES SOLD EMPTY; LUNCH BOXES (U.S. CLS. 2, 13, 23, 29, 30, 33, 40 AND 50).

FIRST USE 1-1-2003; IN COMMERCE 1-1-2003.

CLASS 25—CLOTHING

FOR APRONS (U.S. CLS. 22 AND 39).
FIRST USE 1-1-2003; IN COMMERCE 1-1-2003.

CLASS 41—EDUCATION AND ENTERTAINMENT

FOR EDUCATIONAL SERVICES, NAMELY CONDUCTING CLASSES, SEMINARS, CONFERENCES, TELECONFERENCES AND WORKSHOPS, IN THE FIELD OF HEALTH AND NUTRITION; EDUCATIONAL SERVICES IN THE NATURE OF COURSES AT THE PRIMARY, SECONDARY, COLLEGE, AND GRADUATE LEVEL IN THE FIELD OF HEALTH AND NUTRITION; PUBLISHING OF BOOKS AND MAGAZINES (U.S. CLS. 100, 101 AND 107).

FIRST USE 1-1-2001; IN COMMERCE 1-1-2001.

CLASS 42—SCIENTIFIC AND COMPUTER SERVICES

FOR DESIGN, CREATION, HOSTING, MAINTENANCE OF WEBSITES FOR OTHERS. (U.S. CLS. 100 AND 101).

FIRST USE 1-1-2001; IN COMMERCE 1-1-2001.

CLASS 44—MEDICAL, BEAUTY AND AGRICULTURAL SERVICES

FOR FOOD NUTRITION CONSULTATION AND HEALTH COUNSELING; DISSEMINATION OF HEALTH AND NUTRITION INFORMATION ON THE INTERNET. (U.S. CLS. 100 AND 101).

FIRST USE 1-1-2001; IN COMMERCE 1-1-2001.
KATHRYN COWARD, EXAMINING ATTORNEY

SN 78-906,828. KABUSHIKI KAISHA VOLKS, KYOTO, JAPAN, FILED 6-13-2006.

ロサンゼルス少年物語

LOS ANGELES BOYS STORY

OWNER OF JAPAN REG. NO. 4927136, DATED 2-10-2006, RENEWED AS REG. NO. 3, EXPIRES 2-10-2016.

OWNER OF JAPAN REG. NO. 4927136, DATED 2-10-2006, EXPIRES 2-10-2016.

NO CLAIM IS MADE TO THE EXCLUSIVE RIGHT TO USE "LOS ANGELES, THE NON-LATIN CHARACTERS THAT MEAN LOS ANGELES, AND THE TRANSLITERATION OF THOSE FOREIGN CHARACTERS WHICH IS RO-SA-N-ZE-RU-SU, IN INTERNATIONAL CLASS 9" , APART FROM THE MARK AS SHOWN.

"THE NON-LATIN CHARACTER(S) IN THE MARK TRANSLITERATES INTO RO-SA-N-ZE-RU-SU SHO-O-NEN MO-NO-GA-TA-N , AND THIS MEANS LOS ANGELES BOYS STORY IN ENGLISH."

CLASS 9—ELECTRICAL AND SCIENTIFIC APPARATUS

FOR COMPUTER GAME SOFTWARE RECORDED ON ROM CARTRIDGES FOR USE WITH VIDEO GAME MACHINES FOR USE WITH TELEVISIONS FOR HOME USE; VIDEO GAME SOFTWARE; COMPUTER GAME SOFTWARE RECORDED ON CD-ROM; ELECTRONIC EQUIPMENT, NAMELY, VIDEO GAME MACHINES FOR USE WITH TELEVISIONS (U.S. CLS. 21, 23, 26, 36 AND 38).

CLASS 16—PAPER GOODS AND PRINTED MATTER

FOR MAGAZINES FEATURING COMPUTERS, VIDEO GAMES, TOYS, DOLLS; NEWSPAPERS (U.S. CLS. 2, 5, 22, 23, 29, 37, 38 AND 50).

CLASS 28—TOYS AND SPORTING GOODS

FOR LCD GAME MACHINES; TOYS, NAMELY, DOLLS, DOLL CLOTHING, AND DOLL ACCESSORIES (U.S. CLS. 22, 23, 38 AND 50).

JIM RINGLE, EXAMINING ATTORNEY

SN 78-915,076. ELAINE HOYO, ABERDEEN, NJ. FILED 6-22-2006.

LASER MIND

THE MARK CONSISTS OF STANDARD CHARACTERS WITHOUT CLAIM TO ANY PARTICULAR FONT, STYLE, SIZE, OR COLOR.

NO CLAIM IS MADE TO THE EXCLUSIVE RIGHT TO USE "MIND", APART FROM THE MARK AS SHOWN.

CLASS 16—PAPER GOODS AND PRINTED MATTER

FOR EDUCATIONAL BOOKS FEATURING SELF EMPOWERMENT, SELF HELP, MENTAL TRAINING, LIFE COACHING, PERSONAL IMPROVEMENT, GOAL SETTING, FUTURE PLANNING, OR SELF DISCIPLINE; SERIES OF NON-FICTION BOOKS IN THE FIELD OF SELF EMPOWERMENT, SELF HELP, MENTAL TRAINING, LIFE COACHING, PERSONAL IMPROVEMENT, GOAL SETTING, FUTURE PLANNING, OR SELF DISCIPLINE (U.S. CLS. 2, 5, 22, 23, 29, 37, 38 AND 50).

CLASS 41—EDUCATION AND ENTERTAINMENT

FOR EDUCATIONAL SERVICES, NAMELY, CONDUCTING CLASSES, SEMINARS, CONFERENCES, AND WORKSHOPS IN THE FIELD OF SELF EMPOWERMENT, SELF HELP, MENTAL TRAINING, LIFE COACHING, PERSONAL IMPROVEMENT, GOAL SETTING, FUTURE PLANNING, OR SELF DISCIPLINE AND DISTRIBUTION OF COURSE MATERIAL IN CONNECTION THEREWITH (U.S. CLS. 100, 101 AND 107).

FIRST USE 6-13-2006; IN COMMERCE 6-13-2006.
ERNEST SHOSHO, EXAMINING ATTORNEY

CLASS 3—COSMETICS AND CLEANING PREPARATIONS

FOR MASSAGE OILS; FACIAL CLEANSERS; FACIAL CREAMS; FACIAL LOTIONS; FACIAL WASHES; SKIN CLARIFIERS; SKIN CLEANSERS; SKIN CREAMS; SKIN CONDITIONERS; SKIN LOTIONS; SKIN MOISTURIZER; SKIN SOAPS; SKIN TONERS; HAIR DRESSINGS FOR MEN; HAIR CONDITIONER; HAIR SHAMPOO; HAIR GELS; HAIR CARE PREPARATIONS; HAIR CLEANING PREPARATIONS; HAIR STYLING PREPARATIONS; HAIR CREAMS; BEAUTY CREAMS FOR BODY CARE; BODY AND BEAUTY CARE COSMETICS; BODY AND BEAUTY CARE PREPARATIONS; BODY CREAMS; BODY CREAM SOAP; BODY LOTIONS; BODY OILS; BODY POWDER; BODY SCRUB; BODY SPRAYS; COSMETIC PREPARATIONS FOR BODY CARE; COSMETIC PRODUCTS FOR THE FACE AND BODY, NAMELY, CREAMS, LOTIONS, GELS, MISTS, SCRUBS AND OILS; DEODORANTS FOR BODY CARE; BODY SPRAY USED AS A PERSONAL DEODORANT AND AS FRAGRANCE; DEODORANT FOR PERSONAL USE; FACE AND BODY BEAUTY CREAMS; FACE AND BODY CREAMS; LIQUID SOAPS FOR HANDS, FACE AND BODY; HAIR LOTIONS; LOTIONS FOR FACE AND BODY CARE; MAKE-UP PRODUCTS FOR THE FACE AND BODY; NON-MEDICATED BODY SOAPS; SOAPS FOR BODY CARE; TONING LOTION, FOR THE FACE, BODY AND HANDS; COLOGNE WATER; TOILET WATER; BATH BEADS; BATH CRYSTALS; SHOWER AND BATH FOAMS; SHOWER AND BATH GELS; BATH LOTION; BATH OILS; BATH POWDER; BATH SALTS; BATH SOAPS IN LIQUID, SOLID OR GEL FORM; MINERAL SALT IN THE NATURE OF BATH SALTS NOT FOR MEDICAL PURPOSES; HAIR TONICS; HAIR CLEANSERS; HAIR WAVING LOTION; SCENTED OILS USED TO PRODUCE AROMAS WHEN HEATED; AROMATHERAPY CREAMS; AROMATHERAPY LOTIONS; AROMATHERAPY OILS; ESSENTIAL OILS FOR PERSONAL USE; BODY AND BEAUTY CARE COSMETICS; COSMETIC CLEANSING CREAMS; COSMETIC CREAMS; COSMETIC OILS; COSMETIC PREPARATIONS FOR SKIN RENEWAL; COSMETIC PREPARATIONS AND PRODUCTS FOR SKIN AND BODY CARE, NAMELY, CREAMS, LOTIONS, GELS, MISTS, SCRUBS AND OILS; COSMETIC PRODUCTS FOR THE FACE AND BODY, NAMELY, CREAMS, LOTIONS, GELS, MISTS, SCRUBS AND OILS; COSMETIC SOAPS; FACE CREAMS FOR COSMETIC USE; SHAVING PREPARATIONS; SHAVING BALMS; MAKE-UP PRODUCTS FOR THE FACE AND BODY; MAKE-UP REMOVERS; PERFUMES; BEAUTY MASKS; SKIN MASKS; BEAUTY SERUMS; SKIN CARE PRODUCTS, NAMELY, NON-MEDICATED SKIN SERUM; LIP BALM; BALMS FOR SKIN; BATH MILKS; BEAUTY MILKS; FACE AND BODY MILKS; CLEANSING MILKS; COSMETIC MILKS; MOISTURIZING MILKS; MAKE-UP REMOVING MILK, GEL, LOTIONS AND CREAMS; EYE COMPRESSES FOR COSMETIC PURPOSES; AFTER SUN CREAMS; AFTER SUN LOTIONS; NON-MEDICATED SUN CARE PREPARATIONS; SUN CARE LOTIONS; SUN CREAMS; AFTER-SHAVE BALMS; AFTER-SHAVE CREAMS; AFTER-SHAVE EMULSIONS; AFTER-SHAVE GEL; AFTER-SHAVE LOTIONS; NON-MEDICATED SKIN CREAMS FOR HEALING INGROWN HAIRS (U.S. CLS. 1, 4, 6, 50, 51 AND 52).

SN 78-916,775. SODASHI PTY LTD., NORTH FREMANTLE, AUSTRALIA, FILED 6-26-2006.

SODASHI

CLASS 5—PHARMACEUTICALS

FOR PREPARATIONS FOR AIDING JET LAG RECOVERY, NAMELY, TOPICAL GELS FOR THE MEDICAL AND THERAPEUTIC TREATMENT OF SWELLING BROUGHT ON BY JET LAG, AND MEDICATED SKIN CARE PREPARATIONS IN THE NATURE OF A MIST TO SPRAY ON AND AROUND THE FACE AND BODY (U.S. CLS. 6, 18, 44, 46, 51 AND 52).

CLASS 30—STAPLE FOODS

FOR TEA (U.S. CL. 46).

THE MARK CONSISTS OF STANDARD CHARACTERS WITHOUT CLAIM TO ANY PARTICULAR FONT, STYLE, SIZE, OR COLOR.

PRIORITY CLAIMED UNDER SEC. 44(D) ON SWITZERLAND APPLICATION NO. 518352006, FILED 3-1-2006.

CLASS 44—MEDICAL, BEAUTY AND AGRICULTURAL SERVICES

FOR HEALTH SPA SERVICES FOR HEALTH AND WELLNESS OF THE BODY AND SPIRIT OFFERED AT A HEALTH RESORT; HEALTH SPA SERVICES, NAMELY, COSMETIC BODY CARE SERVICES; MASSAGE SERVICES. (U.S. CLS. 100 AND 101).

ELI HELLMAN, EXAMINING ATTORNEY

SN 78-919,238. FOUR UNLIKELY FRIENDS, LLC, CHICAGO, IL. FILED 6-28-2006.

CUPCAKES MAKE PEOPLE HAPPY

THE MARK CONSISTS OF STANDARD CHARACTERS WITHOUT CLAIM TO ANY PARTICULAR FONT, STYLE, SIZE, OR COLOR.

CLASS 16—PAPER GOODS AND PRINTED MATTER

FOR PRINTED GOODS, NAMELY COOK BOOKS, AGENDAS, ALBUMS TO HOLD RECIPE CARDS, ANNOUNCEMENT CARDS, ART PADS, ART PRINTS, ARTISTS' PENCILS, AUTOGRAPH BOOKS, BALL POINT PENS, BINDERS, BLANK CARDS, BLANK NOTE CARDS, BOOK COVERS, BOOKMARKS, BOOKS FEATURING RECIPES, COOKING INFORMATION, GENERAL KNOWLEDGE AND TRIVIA; CALENDARS, WALL CALENDARS, CARDBOARD CARRIER FOR FOOD AND BEVERAGES, RECIPE CARDS, CHILDREN'S ACTIVITY BOOKS, CHILDREN'S BOOKS, CHILDREN'S STORYBOOKS, CHRISTMAS CARDS, COLORING BOOKS, COMIC BOOKS, COMIC STRIPS, COUPON BOOKS, CRAYONS, CROSSWORD PUZZLES, DESK STANDS AND HOLDERS FOR PENS, PENCILS AND INK, DIARIES, EDUCATIONAL BOOKS CONTAINING FOOD AND COOKERY INFORMATION, GIFT WRAPPING PAPER, GLOBES, GREETING CARDS, HIGHLIGHTING MARKERS, HIGHLIGHTING PENS, ARTS AND CRAFTS PAINT KITS COMPRISING PAINTS PENCILS AND CRAYONS, MEMO PADS, MODELING MATERIAL AND COMPOUNDS FOR USE BY CHILDREN, MUSICAL GREETING CARDS, NOTEBOOKS, NOTE PADS, PAINTING SETS FOR CHILDREN, PAPER CAKE DECORATIONS, PAPER EGG CARTONS, PAPER GIFT BAGS, PAPER NAPKINS, PAPER PARTY BAGS, PAPER PARTY DECORATIONS, PAPER PARTY FAVORS, PAPER PARTY HATS, PAPER PLACE MATS, PAPER SHOPPING BAGS, PAPER TABLECLOTHS, PAPER TAKE-OUT CARTONS FOR FOOD, PAPER TRAY COVERS, PENCIL CASES, PICTURE BOOKS, PICTURE POSTCARDS, POSTERS, PRINTED GREETING CARDS WITH ELECTRONIC INFORMATION STORED THEREIN, PRINTED INVITATIONS, PRINTED MENUS, PRINTED RECIPES SOLD AS A COMPONENT OF FOOD PACKAGING, GROCERY BAGS, FOOD WRAPPERS, SANDWICH BAGS, BAGS FOR MICROWAVE COOKING, STATIONERY, STICKERS, TRADING CARD DISCS OF PAPER OR CARDBOARD, TRADING CARDS, IRON-ON AND PLASTIC TRANSFERS, AND TRIVIA CARDS (U.S. CLS. 2, 5, 22, 23, 29, 37, 38 AND 50).

CLASS 30—STAPLE FOODS

FOR FLOUR AND PREPARATIONS MADE FROM CEREALS, NAMELY, BAKERY DESSERTS AND PREPARATIONS FOR MAKING DESSERTS, NAMELY, BAKING SODA, BAKING POWDER AND SUGAR, MIXES FOR BAKERY GOODS, CUPCAKES, WAFERS, BISCUITS, CAKES, PIES, DONUTS, COOKIES, CREAM-FILLED COOKIES, SHORTBREAD, PASTRIES, BAKERY PRODUCTS, CREAM-FILLED BAKERY PRODUCTS, SNACKS, NAMELY GRANOLA BASED SNACK BARS, BREAD, FLAT BREAD, CONFECTIONERY, NAMELY BUNS, SWEETMEATS, BONBONS, CHOCOLATE BARS, CANDY BARS, ICE CREAMS, SAUCES, SPICES, COFFEE, TEA, COCOA, SUGAR, RICE, TAPIOCA, SAGO, ARTIFICIAL COFFEE, HONEY, TREACLE, YEAST, AND BAKING POWDER (U.S. CL. 46).

CLASS 43—HOTEL AND RESTAURANT SERVICES

FOR BAKERY RESTAURANT SERVICES; COFFEE SHOP SERVICES; CAFE RESTAURANT SERVICES; CAFE SERVICES; CAFETERIA SERVICES; CANTEN SERVICES; SNACK-BAR SERVICES; RESTAURANT SERVICES; SELF-SERVICE RESTAURANT SERVICES; AND CATERING SERVICES FOR FOOD AND BEVERAGES (U.S. CLS. 100 AND 101).

MICHAEL KEATING, EXAMINING ATTORNEY

SN 78-920,694. RMACS, LLC, CHANTILLY, VA. FILED 6-30-2006.

RMACS

THE MARK CONSISTS OF STANDARD CHARACTERS WITHOUT CLAIM TO ANY PARTICULAR FONT, STYLE, SIZE, OR COLOR.

CLASS 37—CONSTRUCTION AND REPAIR

FOR MAINTENANCE, TROUBLESHOOTING, AND REPAIR OF COMPUTER HARDWARE, SYSTEMS, AND NETWORKS; COMPUTER INSTALLATION AND REPAIR (U.S. CLS. 100, 103 AND 106).

FIRST USE 4-6-2005; IN COMMERCE 4-6-2005.

CLASS 42—SCIENTIFIC AND COMPUTER SERVICES

FOR CONSULTATION SERVICES IN THE FIELDS OF DESIGN, SELECTION, IMPLEMENTATION, BACK-UP, AND USE OF COMPUTER SOFTWARE, SYSTEMS, AND NETWORKS; TECHNICAL SUPPORT, NAMELY, PROVIDING BACK-UP COMPUTER PROGRAMS AND FACILITIES; DESIGN, DEVELOPMENT, IMPLEMENTATION, AND MAINTENANCE OF COMPUTER SOFTWARE; COMPUTER DISASTER RECOVERY PLANNING; RECOVERY OF LOST, DAMAGED, OR CORRUPTED COMPUTER DATA; MAINTENANCE AND REPAIR OF COMPUTER SOFTWARE (U.S. CLS. 100 AND 101).

FIRST USE 4-6-2005; IN COMMERCE 4-6-2005.

ROSELLE HERRERA, EXAMINING ATTORNEY

SN 78-922,035. KESHAN JINDING LINEN TEXTILE CO. LTD., KESHAN COUNTY, CHINA, FILED 7-3-2006.



THE MARK CONSISTS OF TWO CHINESE CHARACTERS AT THE CENTER OF THE DESIGN AND THEIR ENGLISH transliteration "CAILIAN" ABOVE THE CHINESE CHARACTERS.

"THE FOREIGN WORDING IN THE MARK TRANSLATES INTO ENGLISH AS COLORFUL LOTUS FLOWERS."

"THE NON-LATIN CHARACTER(S) IN THE MARK TRANSLITERATES INTO CAILIAN, AND THIS MEANS COLORFUL LOTUS FLOWERS IN ENGLISH."

CLASS 23—YARNS AND THREADS

FOR DARNING THREAD; DARNING YARN; HEMP THREAD; HEMP YARN; JUTE THREAD; JUTE YARN; LINEN THREAD; LINEN YARN; SPUN WOOL; THREAD; WOOL THREAD; WOOL YARN; YARN (U.S. CL. 43).

FIRST USE 3-15-1989; IN COMMERCE 3-15-1989.

CLASS 24—FABRICS

FOR BED BLANKETS; BED LINEN; CURTAINS; FELT AND NON-WOVEN TEXTILE FABRICS; FIBERGLASS FABRICS FOR TEXTILE USE; HEMP CLOTH; LINEN; PLACE MATS NOT OF PAPER; TABLE CLOTHS NOT OF PAPER; TOWELS (U.S. CLS. 42 AND 50).

FIRST USE 12-20-1994; IN COMMERCE 12-20-1994.
LYDIA BELZER, EXAMINING ATTORNEY

SN 78-923,236. SHOWING BEACON, L.L.C., LENEXA, KS. FILED 7-6-2006.

SHOWING BEACON

THE MARK CONSISTS OF STANDARD CHARACTERS WITHOUT CLAIM TO ANY PARTICULAR FONT, STYLE, SIZE, OR COLOR.

CLASS 9—ELECTRICAL AND SCIENTIFIC APPARATUS

FOR WIRELESS ELECTRONIC TRANSMITTERS AND RECEIVERS, NAMELY FOR USE IN CONNECTION WITH PROVIDING EVENT ALERT SERVICES TO SUBSCRIBING CUSTOMERS (U.S. CLS. 21, 23, 26, 36 AND 38).

FIRST USE 2-21-2005; IN COMMERCE 9-6-2005.

CLASS 38—COMMUNICATION

FOR TELECOMMUNICATION SERVICES, NAMELY THE ELECTRONIC TRANSMISSION AND DELIVERY OF TELEPHONIC OR DIGITAL EVENT ALERT MESSAGES TO SUBSCRIBERS (U.S. CLS. 100, 101 AND 104).

FIRST USE 2-21-2005; IN COMMERCE 9-6-2005.
SANJEEV VOHRA, EXAMINING ATTORNEY

SN 78-924,400. ADIRI, INC., PALO ALTO, CA. FILED 7-7-2006.

ADIRI

THE MARK CONSISTS OF STANDARD CHARACTERS WITHOUT CLAIM TO ANY PARTICULAR FONT, STYLE, SIZE, OR COLOR.

CLASS 10—MEDICAL APPARATUS

FOR BABY BOTTLES; NURSING BOTTLES; NIPPLES FOR BABY BOTTLES; TEATS; DISPOSABLE TEATS; BREAST MILK STORAGE BOTTLES; BREAST PUMPS. (U.S. CLS. 26, 39 AND 44).

CLASS 11—ENVIRONMENTAL CONTROL APPARATUS

FOR ELECTRIC APPARATUS, NAMELY, BABY BOTTLE WARMERS AND BABY BOTTLE WARMING CONTAINERS (U.S. CLS. 13, 21, 23, 31 AND 34).

CLASS 21—HOUSEWARES AND GLASS

FOR COLD PACKS USED TO KEEP FOOD AND DRINK COLD; THERMAL INSULATED CONTAINERS FOR FOOD OR BEVERAGES, NAMELY, THERMAL INSULATED BOTTLE CARRIERS; PORTABLE COOLERS, NAMELY, BOTTLE COOLER BAGS (U.S. CLS. 2, 13, 23, 29, 30, 33, 40 AND 50).

KENNETH E. SHARPERSON, EXAMINING ATTORNEY

SN 78-926,342. GRAHAM, MAURICE, RICHMOND, VA. FILED 7-10-2006.



THE MARK CONSISTS OF A STYLIZED P THAT IS ALSO INTENDED TO FORM THE BODY OF A PERSON WITH A PASTOR'S COLLAR, TOGETHER WITH A STYLIZED I THIS IS ALSO INTENDED TO FORM THE BODY OF A PERSON.

CLASS 16—PAPER GOODS AND PRINTED MATTER

FOR PRINTED MATERIALS, NAMELY, INSTRUCTIONAL, EDUCATIONAL AND TEACHING MATERIALS, BOOKS, CURRICULUM BOOKS, EXAMINATION BOOKLETS, EXERCISE WORKBOOKS, PAPER MASTERS FOR PREPARATION OF OVERHEAD PROJECTOR TRANSPARENCIES, BROCHURES AND NEWSLETTERS, ALL IN THE FIELD OF CHRISTIAN RELIGION (U.S. CLS. 2, 5, 22, 23, 29, 37, 38 AND 50).
FIRST USE 7-10-2006; IN COMMERCE 7-10-2006.

CLASS 41—EDUCATION AND ENTERTAINMENT

FOR PREPARING, ADMINISTERING AND ANALYZING EXAMINATIONS IN THE FIELD OF CHRISTIAN RELIGION, INCLUDING SUCH SERVICES ACCESSED IN-PERSON OR THROUGH A GLOBAL COMPUTER NETWORK; PERSONAL COACHING SERVICES IN THE FIELD OF CHRISTIAN RELIGION; EDUCATIONAL SERVICES, NAMELY, CONFERENCES, WORKSHOPS, INDIVIDUAL INSTRUCTION AND SEMINARS IN THE RELIGIOUS FIELD, AND DISTRIBUTION OF COURSE MATERIAL IN CONNECTION THEREWITH, ACCESSED IN-PERSON OR THROUGH A GLOBAL COMPUTER NETWORK; EDUCATIONAL CONSULTING SERVICES FOR TRAINING, TEACHING AND EQUIPPING CHRISTIAN LEADERS (U.S. CLS. 100, 101 AND 107).
FIRST USE 7-10-2006; IN COMMERCE 7-10-2006.
INGRID C. EULIN, EXAMINING ATTORNEY

CLASS 44—MEDICAL, BEAUTY AND AGRICULTURAL SERVICES

FOR PROVIDING MEDICAL INFORMATION; PROVIDING INFORMATION FOR THE PURPOSES OF EMERGENCY MEDICAL ASSISTANCE (U.S. CLS. 100 AND 101).
AISHA CLARKE, EXAMINING ATTORNEY

SN 78-928,159. ROAM CORPORATION, ST. ALBERT, ALBERTA, FILED 7-12-2006.

SN 78-928,099. ROAM CORPORATION, ST. ALBERT, CANADA, FILED 7-12-2006.

ROAM

THE MARK CONSISTS OF STANDARD CHARACTERS WITHOUT CLAIM TO ANY PARTICULAR FONT, STYLE, SIZE, OR COLOR.
PRIORITY CLAIMED UNDER SEC. 44(D) ON CANADA APPLICATION NO. 1,308,820, FILED 7-12-2006, REG. NO. TMA694,601, DATED 8-22-2007, EXPIRES 8-22-2022.

CLASS 9—ELECTRICAL AND SCIENTIFIC APPARATUS

FOR COMPUTER PROGRAMS AND COMPUTER HARDWARE FOR THE RECORDING, STORING AND DISSEMINATION OF MEDICAL, ACCIDENT AND EMERGENCY DATA (U.S. CLS. 21, 23, 26, 36 AND 38).

CLASS 41—EDUCATION AND ENTERTAINMENT

FOR EDUCATIONAL SERVICES, NAMELY PROVIDING HEALTH CARE, ACCIDENT AND EMERGENCY SERVICES TRAINING (U.S. CLS. 100, 101 AND 107).

CLASS 42—SCIENTIFIC AND COMPUTER SERVICES

FOR SOFTWARE DEVELOPMENT SERVICES, NAMELY DEVELOPMENT OF SOFTWARE FOR USE IN THE FIELDS OF MEDICAL, ACCIDENT AND EMERGENCY SERVICES DATA (U.S. CLS. 100 AND 101).

THE MARK CONSISTS OF STANDARD CHARACTERS WITHOUT CLAIM TO ANY PARTICULAR FONT, STYLE, SIZE, OR COLOR.
PRIORITY CLAIMED UNDER SEC. 44(D) ON CANADA APPLICATION NO. 1,308,823, FILED 7-12-2006, REG. NO. TMA694,600, DATED 8-22-2007, EXPIRES 8-22-2022.
OWNER OF U.S. REG. NO. 2,657,570.
NO CLAIM IS MADE TO THE EXCLUSIVE RIGHT TO USE "EPCR", APART FROM THE MARK AS SHOWN.

RAMPART EPCR

CLASS 9—ELECTRICAL AND SCIENTIFIC APPARATUS

FOR COMPUTER PROGRAMS AND COMPUTER HARDWARE FOR THE RECORDING, STORING AND DISSEMINATION OF MEDICAL, ACCIDENT AND EMERGENCY DATA (U.S. CLS. 21, 23, 26, 36 AND 38).

CLASS 41—EDUCATION AND ENTERTAINMENT

FOR EDUCATIONAL SERVICES, NAMELY, PROVIDING HEALTH CARE, ACCIDENT AND EMERGENCY SERVICES TRAINING (U.S. CLS. 100, 101 AND 107).

CLASS 42—SCIENTIFIC AND COMPUTER SERVICES

FOR SOFTWARE DEVELOPMENT SERVICES, NAMELY, DEVELOPMENT OF SOFTWARE FOR USE IN THE FIELDS OF MEDICAL, ACCIDENT AND EMERGENCY SERVICES DATA (U.S. CLS. 100 AND 101).

CLASS 44—MEDICAL, BEAUTY AND AGRICULTURAL SERVICES

FOR PROVIDING MEDICAL INFORMATION (U.S. CLS. 100 AND 101).
AISHA CLARKE, EXAMINING ATTORNEY

SN 78-929,937. POSITORK DISTRIBUTING, INC., DUBLIN, CA. FILED 7-14-2006.

SN 78-936,429. STOCKMAN, SHAWN, BEVERLY HILLS, CA. FILED 7-24-2006.

REACTIV

THE MARK CONSISTS OF STANDARD CHARACTERS WITHOUT CLAIM TO ANY PARTICULAR FONT, STYLE, SIZE, OR COLOR.

CLASS 7—MACHINERY

FOR ALTERNATORS FOR LAND VEHICLES AND COMPONENTS THEREOF, NAMELY, BRUSHES, PULL-EYS, ENGINE BEARINGS, DISTRIBUTOR ROTORS AND STATORS (U.S. CLS. 13, 19, 21, 23, 31, 34 AND 35).

CLASS 9—ELECTRICAL AND SCIENTIFIC APPARATUS

FOR VOLTAGE REGULATORS AND DIODES (U.S. CLS. 21, 23, 26, 36 AND 38).
SHANNON TWOHIG, EXAMINING ATTORNEY

Swagga Boyz

THE MARK CONSISTS OF STANDARD CHARACTERS WITHOUT CLAIM TO ANY PARTICULAR FONT, STYLE, SIZE, OR COLOR.

CLASS 9—ELECTRICAL AND SCIENTIFIC APPARATUS

FOR SERIES OF PRERECORDED PHONOGRAPH RECORDS, COMPACT DISCS, AND AUDIO TAPES FEATURING MUSIC; A SERIES OF PRE-RECORDED VIDEO TAPES FEATURING MUSIC VIDEOS (U.S. CLS. 21, 23, 26, 36 AND 38).

CLASS 41—EDUCATION AND ENTERTAINMENT

FOR ENTERTAINMENT IN THE NATURE OF LIVE PERFORMANCES BY A MUSICAL GROUP (U.S. CLS. 100, 101 AND 107).
KEVON CHISOLM, EXAMINING ATTORNEY

SN 78-933,280. BLUESKY MARKETING GROUP, INC., SAN RAMON, CA. FILED 7-19-2006.

SN 78-939,625. PASSPORT MARINE INC, AVENTURA, FL. FILED 7-28-2006.

TRUE MAIL

THE MARK CONSISTS OF STANDARD CHARACTERS WITHOUT CLAIM TO ANY PARTICULAR FONT, STYLE, SIZE, OR COLOR.

NO CLAIM IS MADE TO THE EXCLUSIVE RIGHT TO USE "MAIL", APART FROM THE MARK AS SHOWN.

CLASS 35—ADVERTISING AND BUSINESS

FOR DIRECT MARKETING AND ADVERTISING SERVICES (U.S. CLS. 100, 101 AND 102).

CLASS 36—INSURANCE AND FINANCIAL

FOR BUSINESS FINANCE PROCUREMENT SERVICES; FINANCIAL SERVICES, NAMELY, CREDIT REPORTING SERVICES; PROVIDING FINANCIAL INFORMATION TO LENDERS AND FINANCIAL SERVICE COMPANIES BY ELECTRONIC MEANS (U.S. CLS. 100, 101 AND 102).
JAMES LOVELACE, EXAMINING ATTORNEY



NO CLAIM IS MADE TO THE EXCLUSIVE RIGHT TO USE "MARINE", APART FROM THE MARK AS SHOWN.

CLASS 35—ADVERTISING AND BUSINESS

FOR RETAIL STORE SERVICES FEATURING BOAT AND BOAT PARTS (U.S. CLS. 100, 101 AND 102).

CLASS 37—CONSTRUCTION AND REPAIR

FOR REPAIR OF BOATS (U.S. CLS. 100, 103 AND 106).

CLASS 39—TRANSPORTATION AND STORAGE

FOR LEASING OF MARINA SERVICES; AND BOAT CHARTERING AND LEASING OF BOAT SLIPS (U.S. CLS. 100 AND 105).
KATHERINE STOIDES, EXAMINING ATTORNEY

SN 78-940,942. FUENTE MARKETING LTD., TORTOLA, BR. VIRGIN ISLANDS, FILED 7-31-2006.



CLASS 3—COSMETICS AND CLEANING PREPARATIONS

FOR COLOGNE AND AFTER SHAVE LOTION (U.S. CLS. 1, 4, 6, 50, 51 AND 52).

CLASS 25—CLOTHING

FOR CLOTHING, NAMELY, BASEBALL CAPS, SWEATERS, SWEATSHIRTS, SHIRTS, T-SHIRTS, CLOTHING TIES, SUSPENDERS, BELTS, JACKETS, COATS, BLAZERS, AND HATS (U.S. CLS. 22 AND 39).

CLASS 30—STAPLE FOODS

FOR CHOCOLATES AND COFFEE (U.S. CL. 46).
KELLY BOULTON, EXAMINING ATTORNEY

SN 78-940,983. ILLINOIS TOOL WORKS INC., GLENVIEW, IL. FILED 7-31-2006.



ITW graphics
generating the right image

OWNER OF U.S. REG. NOS. 2,250,846, 2,752,594 AND OTHERS.

NO CLAIM IS MADE TO THE EXCLUSIVE RIGHT TO USE "GRAPHICS", APART FROM THE MARK AS SHOWN.

CLASS 1—CHEMICALS

FOR HEAT TRANSFER FLUIDS FOR INDUSTRIAL USE (U.S. CLS. 1, 5, 6, 10, 26 AND 46).

CLASS 7—MACHINERY

FOR MACHINES FOR THE APPLICATION OF HEAT TRANSFERS AND DECALCOMANIA TRANSFERS (U.S. CLS. 13, 19, 21, 23, 31, 34 AND 35).

CLASS 16—PAPER GOODS AND PRINTED MATTER

FOR DECALCOMANIA TRANSFERS, HEAT TRANSFERS, HEAT TRANSFER LABELS (U.S. CLS. 2, 5, 22, 23, 29, 37, 38 AND 50).

CLASS 17—RUBBER GOODS

FOR PRESSURE SENSITIVE PLASTIC FILM FOR SCREEN PRINTING AND SIGN MAKING (U.S. CLS. 1, 5, 12, 13, 35 AND 50).
KEVIN CORWIN, EXAMINING ATTORNEY

SN 78-943,868. DR. AUGUST WOLFF GMBH & CO. KG, BIELEFELD, FED REP GERMANY, FILED 8-3-2006.

TESTORAPID

THE MARK CONSISTS OF STANDARD CHARACTERS WITHOUT CLAIM TO ANY PARTICULAR FONT, STYLE, SIZE, OR COLOR.

PRIORITY CLAIMED UNDER SEC. 44(D) ON FED REP GERMANY APPLICATION NO. 30624951.0, FILED 4-18-2006, REG. NO. 30624951, DATED 6-23-2006, EXPIRES 4-30-2016.

CLASS 3—COSMETICS AND CLEANING PREPARATIONS

FOR PERFUMERY, ESSENTIAL OILS FOR PERSONAL USE, COSMETICS, HAIR LOTIONS, DENTIFRICES (U.S. CLS. 1, 4, 6, 50, 51 AND 52).

CLASS 5—PHARMACEUTICALS

FOR PHARMACEUTICAL AND VETERINARY PREPARATIONS FOR USE IN DERMATOLOGY, ANDROLOGY, UROLOGY AND GYNECOLOGY; DIETETIC FOODS ADAPTED FOR MEDICAL USE, BABY FOOD; ALL-PURPOSE DISINFECTANTS; SANITARY PREPARATIONS FOR MEDICAL PURPOSES (U.S. CLS. 6, 18, 44, 46, 51 AND 52).

CLASS 10—MEDICAL APPARATUS

FOR SURGICAL, MEDICAL AND DENTAL AND VETERINARY APPARATUS AND INSTRUMENTS, NAMELY SURGICAL AND MEDICAL APPARATUS AND INSTRUMENTS FOR USE IN GENERAL SURGERY, SURGICAL COMPRESSES, AND CASTRATING APPARATUS FOR VETERINARY PURPOSES; SUTURES (U.S. CLS. 26, 39 AND 44).

MICHAEL TANNER, EXAMINING ATTORNEY

SN 78-944,477. KELLY PAPER COMPANY, CITY OF INDUSTRY, CA. FILED 8-3-2006.

PRESSLINE PLUS

THE MARK CONSISTS OF STANDARD CHARACTERS WITHOUT CLAIM TO ANY PARTICULAR FONT, STYLE, SIZE, OR COLOR.

OWNER OF U.S. REG. NO. 2,365,043.

CLASS 1—CHEMICALS

FOR CHEMICALS FOR USE IN DEVELOPING METAL PLATES FOR THE PRINTING INDUSTRY; (BASED ON INTENT TO USE) UNEXPOSED PHOTOGRAPHIC FILM (U.S. CLS. 1, 5, 6, 10, 26 AND 46).

FIRST USE 1-20-2006; IN COMMERCE 1-20-2006.

CLASS 7—MACHINERY

FOR PRINTING PLATES (U.S. CLS. 13, 19, 21, 23, 31, 34 AND 35).

FIRST USE 1-20-2006; IN COMMERCE 1-20-2006.

CLASS 16—PAPER GOODS AND PRINTED MATTER

FOR OFFSET PRINTERS' BLANKETS, NOT OF TEXTILE (U.S. CLS. 2, 5, 22, 23, 29, 37, 38 AND 50).
FIRST USE 3-0-1998; IN COMMERCE 3-0-1998.
KENNETH E. SHARPERSON, EXAMINING ATTORNEY

SN 78-946,512. SWEETS DIMENSION, S.A. DE C.V., AGUASCALIENTES, MEXICO, FILED 8-7-2006.



NO CLAIM IS MADE TO THE EXCLUSIVE RIGHT TO USE "SWEETS", APART FROM THE MARK AS SHOWN.

THE COLOR(S) BLACK, WHITE, PURPLE AND RED IS/ARE CLAIMED AS A FEATURE OF THE MARK.

THE MARK CONSISTS OF THE WORDING "SWEETS DIMENSION" WITHIN A STRIPED OVAL DESIGN. THE WORD "SWEETS" IS DISPLAYED IN THE COLOR PURPLE FRAMED BY WHITE AND BLACK OUTLINING AND HIGHLIGHTS. THE WORD "DIMENSION" IS DISPLAYED IN THE COLOR RED FRAMED BY WHITE AND BLACK OUTLINING AND HIGHLIGHTS. THE OVAL DESIGN IS OUTLINED IN BLACK AND CONTAINS RED AND WHITE STRIPES.

CLASS 29—MEATS AND PROCESSED FOODS

FOR SWEET FRUIT PULPS (U.S. CL. 46).

CLASS 30—STAPLE FOODS

FOR CANDIES; CARAMELS; GUMMY CANDIES; LOLLIPOPS (U.S. CL. 46).

SONYA STEPHENS, EXAMINING ATTORNEY

SN 78-946,578. AGAMATRIX, INC., SALEM, NH. FILED 8-7-2006.

FOR SAFER, MORE ACCURATE
RESULTS

THE MARK CONSISTS OF STANDARD CHARACTERS WITHOUT CLAIM TO ANY PARTICULAR FONT, STYLE, SIZE, OR COLOR.

CLASS 5—PHARMACEUTICALS

FOR DISPOSABLE MEDICAL TEST STRIPS FOR USE IN CONJUNCTION WITH A METER FOR ELECTROCHEMICAL MONITORING OF ANALYTES IN BIOLOGICAL FLUIDS; DISPOSABLE MEDICAL TEST STRIPS FOR USE IN CONJUNCTION WITH A METER FOR ELECTROCHEMICAL MONITORING OF GLUCOSE IN BIOLOGICAL FLUIDS (U.S. CLS. 6, 18, 44, 46, 51 AND 52).

FIRST USE 3-31-2007; IN COMMERCE 3-31-2007.

CLASS 10—MEDICAL APPARATUS

FOR DIGITAL SIGNAL PROCESSING APPARATUS, NAMELY, A PROGRAMMED MICROPROCESSOR FOR INCORPORATION INTO ELECTROCHEMICAL METERS FOR THE MEDICAL PURPOSE OF ELECTROCHEMICAL MONITORING OF ANALYTES IN BIOLOGICAL FLUIDS; DIGITAL SIGNAL PROCESSING APPARATUS, NAMELY, A PROGRAMMED MICROPROCESSOR FOR INCORPORATION INTO ELECTROCHEMICAL METERS FOR THE MEDICAL PURPOSE OF ELECTROCHEMICAL MONITORING OF GLUCOSE IN BIOLOGICAL FLUIDS; DIGITAL SIGNAL PROCESSING APPARATUS, NAMELY, A PROGRAMMED MICROPROCESSOR FOR INCORPORATION INTO INSULIN PUMPS FOR THE MEDICAL PURPOSE OF CONTROLLING THE DELIVERY OF INSULIN TO A USER; DIGITAL SIGNAL PROCESSING APPARATUS, NAMELY, A PROGRAMMED MICROPROCESSOR FOR INCORPORATION INTO A COMBINED ELECTROCHEMICAL METER/INSULIN PUMP FOR THE MEDICAL PURPOSES OF MONITORING GLUCOSE IN BLOOD AND CONTROLLING THE DELIVERY OF INSULIN TO A USER; WIRED OR WIRELESS COMMUNICATION DEVICES FOR COMMUNICATION BETWEEN ANY OF THE DIGITAL SIGNAL PROCESSING APPARATUSES DESCRIBED HEREIN AND DATA TRANSFER OR EXTERNAL OR REMOTE STORAGE DEVICES, FOR EXAMPLE A CABLE FOR CONNECTING A DIGITAL SIGNAL PROCESSING APPARATUS TO A PERSONAL COMPUTER OR WIRELESS COMMUNICATION HARDWARE SUCH AS TRANSMITTERS AND RECEIVERS; SOFTWARE FOR CONTROLLING ELECTROCHEMICAL METERS FOR THE MEDICAL PURPOSE OF ELECTROCHEMICAL MONITORING OF ANALYTES IN BIOLOGICAL FLUIDS; SOFTWARE FOR CONTROLLING ELECTROCHEMICAL METERS FOR THE MEDICAL PURPOSE OF ELECTROCHEMICAL MONITORING OF GLUCOSE IN BIOLOGICAL FLUIDS; SOFTWARE FOR CONTROLLING ELECTROCHEMICAL METERS FOR THE MEDICAL PURPOSE OF ELECTROCHEMICAL MONITORING OF GLUCOSE IN BIOLOGICAL FLUIDS; SOFTWARE FOR CONTROLLING ELECTROCHEMICAL METERS FOR THE MEDICAL PURPOSE OF ELECTROCHEMICAL MONITORING OF GLUCOSE IN BIOLOGICAL FLUIDS; SOFTWARE FOR CONTROLLING INSULIN PUMPS FOR THE MEDICAL PURPOSE OF CONTROLLING THE DELIVERY OF INSULIN TO A USER; SOFTWARE FOR CONTROLLING A COMBINED ELECTROCHEMICAL METER/INSULIN PUMP FOR THE MEDICAL PURPOSES OF MONITORING GLUCOSE IN BLOOD AND CONTROLLING THE DELIVERY OF INSULIN TO A USER; SOFTWARE FOR CONTROLLING WIRED OR WIRELESS COMMUNICATION DEVICES FOR COMMUNICATION BETWEEN ANY OF THE DIGITAL SIGNAL PROCESSING APPARATUSES DESCRIBED HEREIN AND A DATA TRANSFER OR EXTERNAL OR REMOTE STORAGE DEVICE; METERS FOR THE MEDICAL PURPOSE OF ELECTROCHEMICAL MONITORING OF ANALYTES IN BIOLOGICAL FLUIDS; METERS FOR THE MEDICAL PURPOSE OF ELECTROCHEMICAL MONITORING OF GLUCOSE IN BIOLOGICAL FLUIDS; METER FOR THE MEDICAL PURPOSE OF ELECTROCHEMICAL IMMUNOASSAYS OF BIOLOGICAL FLUIDS; INSULIN PUMPS FOR THE MEDICAL PURPOSE OF DELIVERING INSULIN TO A USER; A COMBINATION OF A METER FOR THE MEDICAL PURPOSE OF ELECTROCHEMICAL MONITORING OF GLUCOSE IN BLOOD AND AN INSULIN PUMP FOR THE MEDICAL PURPOSE OF DELIVERING INSULIN TO A USER; MEDICAL CUTTING DEVICES AND LANCETS FOR ACQUISITION OF BLOOD SAMPLES FOR USE IN ELECTROCHEMICAL DETECTION OF ANALYTES IN BLOOD; MEDICAL DIAGNOSTIC TEST KITS HAVING METERS FOR THE MEDICAL PURPOSE OF ELECTROCHEMICAL MONITORING OF ANALYTES IN BIOLOGICAL FLUIDS AND DISPOSABLE MEDICAL TEST STRIPS FOR USE IN CONJUNCTION WITH A METER FOR ELECTROCHEMICAL MONITORING OF ANALYTES IN BIOLOGICAL FLUIDS; MEDICAL DIAGNOSTIC TEST KITS HAVING METERS FOR THE MEDICAL PURPOSE OF ELECTROCHEMICAL MONITORING OF ANALYTES IN BIOLOGICAL FLUIDS AND MEDICAL CUTTING DEVICES AND LANCETS FOR ACQUISITION OF BLOOD SAMPLES FOR USE IN ELECTROCHEMICAL DETECTION OF ANALYTES IN BLOOD; AND MEDICAL DIAGNOSTIC

TEST KITS HAVING METERS FOR THE MEDICAL PURPOSE OF ELECTROCHEMICAL MONITORING OF ANALYTES IN BIOLOGICAL FLUIDS AND MEDICAL CUTTING DEVICES AND LANCETS FOR ACQUISITION OF BLOOD SAMPLES FOR USE IN ELECTROCHEMICAL DETECTION OF ANALYTES IN BLOOD, AND INSULIN PUMPS FOR THE MEDICAL PURPOSE OF DELIVERING INSULIN TO A USER (U.S. CLS. 26, 39 AND 44).

FIRST USE 3-31-2007; IN COMMERCE 3-31-2007.
ARETHA SOMERVILLE, EXAMINING ATTORNEY

SN 78-947,281. ALCOA INC., PITTSBURGH, PA. FILED 8-8-2006.

AA

THE MARK CONSISTS OF STANDARD CHARACTERS WITHOUT CLAIM TO ANY PARTICULAR FONT, STYLE, SIZE, OR COLOR.

OWNER OF ERPN CMNTY TM OFC REG. NO. 002639060, DATED 10-29-2003, EXPIRES 4-2-2012.

CLASS 6—METAL GOODS

FOR METAL BUILDING MATERIALS, NAMELY, CURTAIN WALLS, WINDOWS AND DOORS MADE PRIMARILY OF METAL, WINDOW FRAMES, STOREFRONTS, STOREFRONT FRAMING SYSTEMS COMPOSED OF METAL FRAMES, CONSERVATORIES, RAINSCREEN PANELS, RAILINGS, LOUVERS, WALL PANELS OF METAL FOR BUILDING INTERIORS, AND METAL SIDING AND SOFFIT. (U.S. CLS. 2, 12, 13, 14, 23, 25 AND 50).

CLASS 9—ELECTRICAL AND SCIENTIFIC APPARATUS

FOR PHOTOVOLTAIC PANELS (U.S. CLS. 21, 23, 26, 36 AND 38).

CLASS 19—NON-METALLIC BUILDING MATERIALS

FOR NON-METAL BUILDING MATERIALS, NAMELY, WINDOWS AND DOORS, WINDOW FRAMES, FRAMES FOR SKYLIGHTS, WINDOW SHUTTERS, WALL PANELS NOT OF METAL FOR BUILDING INTERIORS, AND PLASTIC SIDING AND SOFFIT FOR EXTERIOR USE ON BUILDINGS. (U.S. CLS. 1, 12, 33 AND 50).

ARETHA SOMERVILLE, EXAMINING ATTORNEY

SN 78-948,719. SANGI CO., LTD., TOKYO, JAPAN, FILED 8-9-2006.

APACHEM

THE MARK CONSISTS OF STANDARD CHARACTERS WITHOUT CLAIM TO ANY PARTICULAR FONT, STYLE, SIZE, OR COLOR.

CLASS 1—CHEMICALS

FOR CALCIUM PHOSPHATE (U.S. CLS. 1, 5, 6, 10, 26 AND 46).

CLASS 4—LUBRICANTS AND FUELS

FOR LIQUID FUELS; GASEOUS FUELS; NAPHTHA; MOTOR FUELS FORMED BY REFORMING ETHANOL WITH CATALYST; SUBSTITUTE GASOLINE USED AS FUELS FOR MOTORS AND ENGINE, FORMED BY REFORMING ETHANOL WITH CATALYST; ALTERNATIVE GASOLINE USED AS FUELS FOR MOTORS AND ENGINES, FORMED BY REFORMING ETHANOL WITH CATALYST; SUBSTITUTE NAPHTHA FORMED BY REFORMING ETHANOL WITH CATALYST; ALTERNATIVE NAPHTHA FORMED BY REFORMING ETHANOL WITH CATALYST (U.S. CLS. 1, 6 AND 15).

ESTHER A. BORSUK, EXAMINING ATTORNEY

SN 78-949,559. JOSE IGNACIO COS CARUS, MEXICO, D.F., MEXICO, FILED 8-10-2006.

AGROWAX

THE MARK CONSISTS OF STANDARD CHARACTERS WITHOUT CLAIM TO ANY PARTICULAR FONT, STYLE, SIZE, OR COLOR.

PRIORITY CLAIMED UNDER SEC. 44(D) ON MEXICO APPLICATION NO. 790969, FILED 6-27-2006, REG. NO. 944567, DATED 6-27-2006, EXPIRES 6-27-2016.

PRIORITY CLAIMED UNDER SEC. 44(D) ON MEXICO APPLICATION NO. 790968, FILED 6-27-2006, REG. NO. 944566, DATED 6-27-2006, EXPIRES 6-27-2016.

CLASS 1—CHEMICALS

FOR CHEMICALS USED IN INDUSTRY, SCIENCE AND PHOTOGRAPHY; UNPROCESSED ARTIFICIAL RESINS FOR AGRICULTURE, AND FOR THE MANUFACTURE OF AUTOMOBILES; UNPROCESSED PLASTICS IN ALL FORMS; FIRE EXTINGUISHING COMPOSITIONS; METAL TEMPERING PREPARATIONS; SOLDERING PREPARATIONS, NAMELY, SOLDERING CHEMICALS, SOLDERING FLUX; CHEMICAL SUBSTANCE FOR PRESERVING FOODSTUFFS; TANNING SUBSTANCE, NAMELY TANNING AGENTS FOR USE IN THE MANUFACTURE OF LEATHER; ADHESIVES USED IN INDUSTRY, NAMELY, THE CONSTRUCTION INDUSTRY, THE AGRICULTURAL INDUSTRY, EXCLUDING FERTILIZERS (U.S. CLS. 1, 5, 6, 10, 26 AND 46).

CLASS 16—PAPER GOODS AND PRINTED MATTER

FOR PAPER AND CARDBOARD; PHOTOGRAPHS; STATIONERY; ADHESIVES FOR STATIONERY OR HOUSEHOLD PURPOSES; PAINT BRUSHES; PRINTERS TYPE; PRINTING BLOCKS (U.S. CLS. 2, 5, 22, 23, 29, 37, 38 AND 50).

ALLISON SCHRODY, EXAMINING ATTORNEY

SN 78-950,155. OS GROUP, LLC D/B/A COVALENT TECHNOLOGIES, WALNUT CREEK, CA. FILED 8-11-2006.

SN 78-950,285. ADT SERVICES AG, 8200 SCHAFFHAUSEN, SWITZERLAND, FILED 8-11-2006.



COVALENT

THE MARK CONSISTS OF STANDARD CHARACTERS WITHOUT CLAIM TO ANY PARTICULAR FONT, STYLE, SIZE, OR COLOR.

CLASS 9—ELECTRICAL AND SCIENTIFIC APPARATUS

FOR COMPUTER SOFTWARE, NAMELY, WEB INFRASTRUCTURE SOFTWARE, DATA SECURITY SOFTWARE, APPLICATION SERVER SOFTWARE, WEB SERVER SOFTWARE, FTP SERVER SOFTWARE, WEB APPLICATION FRAMEWORK SOFTWARE FOR DEVELOPING WEB BASED APPLICATIONS; COMPILED VERSIONS OF OPEN SOURCE WEB INFRASTRUCTURE SOFTWARE SOLD AS A UNIT; SOFTWARE FOR MONITORING THE OPERATION OF OTHER PROGRAMS; PROGRAMS FOR FACILITATING COMMUNICATION VIA HYPERTEXT TRANSFER PROTOCOL OVER THE GLOBAL COMMUNICATIONS NETWORK; PROVIDING DOWNLOADABLE COMPUTER SOFTWARE, NAMELY APPLICATION SERVER SOFTWARE, WEB SERVER SOFTWARE, FTP SERVER SOFTWARE; PROGRAMS FOR FACILITATING COMMUNICATION VIA HYPERTEXT TRANSFER PROTOCOL OVER THE GLOBAL COMMUNICATIONS NETWORK (U.S. CLS. 21, 23, 26, 36 AND 38).

FIRST USE 3-31-1998; IN COMMERCE 3-31-1998.

CLASS 41—EDUCATION AND ENTERTAINMENT

FOR EDUCATIONAL SERVICES, NAMELY, TRAINING IN THE FIELD OF COMPUTER SOFTWARE (U.S. CLS. 100, 101 AND 107).

FIRST USE 3-31-1998; IN COMMERCE 3-31-1998.

CLASS 42—SCIENTIFIC AND COMPUTER SERVICES

FOR TECHNICAL CONSULTING IN THE FIELD OF COMPUTER SOFTWARE; TECHNICAL SUPPORT SERVICES IN THE FIELD OF COMPUTER SOFTWARE; COMPUTER SOFTWARE DESIGN AND DEVELOPMENT FOR OTHERS; COMPUTER SOFTWARE DIAGNOSTIC SERVICES; INSTALLATION, MAINTENANCE AND UPDATING OF COMPUTER SOFTWARE; COMPUTER CONFIGURATION SERVICES (U.S. CLS. 100 AND 101).

FIRST USE 3-31-1998; IN COMMERCE 3-31-1998.
CAROLINE WOOD, EXAMINING ATTORNEY

NO CLAIM IS MADE TO THE EXCLUSIVE RIGHT TO USE "CUSTOM HOME SERVICES", APART FROM THE MARK AS SHOWN.

CLASS 9—ELECTRICAL AND SCIENTIFIC APPARATUS

FOR CUSTOMIZED RESIDENTIAL SECURITY PRODUCTS, NAMELY, ELECTRIC PROTECTION EQUIPMENT, NAMELY, FIRE DETECTION, MONITORING AND ALARM COMPUTER HARDWARE AND ACCOMPANYING ACCESSORIES, NAMELY, COMPUTER PERIPHERALS; FIRE DETECTION, MONITORING AND ALARM COMPUTER NETWORK HARDWARE, MULTIPLEXERS, AND COMPUTER SOFTWARE USED TO MONITOR AND OPERATE FIRE DETECTION, MONITORING AND ALARM SYSTEMS; FIRE DETECTION, MONITORING AND ALARM VOICE COMMUNICATION SYSTEMS, NAMELY, VOICE COMMUNICATION HUBS, DIGITAL AND RADIO RECEIVERS, DIGITAL AND RADIO TRANSMITTERS, INTERCOMS, AND TELECOMMUNICATIONS AND DATA NETWORKING HARDWARE, NAMELY DEVICES FOR TRANSPORTING AND AGGREGATING VOICE, DATA, AND VIDEO COMMUNICATIONS ACROSS MULTIPLE NETWORK INFRASTRUCTURES AND COMMUNICATIONS PROTOCOLS; FIRE ALARMS; FIRE DETECTING AND ALARM SYSTEMS AND DEVICES, NAMELY, FIRE ALARM EMERGENCY PHONES FOR GRAPHICAL COMMAND CENTERS AND MANUAL STATIONS, SMOKE DETECTORS AND SENSORS, FLAME DETECTORS, AND HEAT DETECTORS AND SENSORS; SPRINKLER SYSTEMS FOR FIRE PROTECTION AND WATER FLOW ALARM SYSTEMS AND DEVICES, NAMELY, WATER FLOW SWITCHES AND SPRINKLER SUPERVISORY SWITCHES; INTRUDER ALARM SYSTEMS AND APPARATUSES, NAMELY, BURGLAR ALARMS, ELECTRONIC WARNING BELLS, PERSONAL SECURITY ALARMS, LASERS NOT FOR MEDICAL USE, MOTION DETECTORS, AND VIDEO AND SURVEILLANCE CAMERAS; VAULT ALARM SYSTEMS AND DEVICES, NAMELY, ELECTRONIC WARNING BELLS, VIDEO AND SURVEILLANCE CAMERAS, ELECTRIC LOCKS, VIDEO MONITORS, SIRENS, AND ELECTRONIC MOTION SENSITIVE SWITCHES; AND SMOKE, FLOOD AND CARBON MONOXIDE DETECTORS (U.S. CLS. 21, 23, 26, 36 AND 38).

FIRST USE 5-31-2005; IN COMMERCE 5-31-2005.

CLASS 37—CONSTRUCTION AND REPAIR

FOR INSTALLATION AND MAINTENANCE SERVICES FOR ELECTRICAL PROTECTION EQUIPMENT AND SYSTEMS NAMELY, FIRE ALARMS, SPRINKLER AND WATER FLOW MONITORING EQUIPMENT AND SYSTEMS, WATER FLOW SWITCHES AND SPRINKLER SUPERVISORY SWITCHES, AND INTRUDER AND BURGLAR ALARMS (U.S. CLS. 100, 103 AND 106).

FIRST USE 5-31-2005; IN COMMERCE 5-31-2005.

CLASS 42—SCIENTIFIC AND COMPUTER SERVICES

FOR TECHNICAL CONSULTATION SERVICES IN THE FIELD OF COMPUTER HARDWARE, COMPUTER PERIPHERALS AND COMPUTER SOFTWARE USED FOR ELECTRICAL PROTECTION EQUIPMENT AND SYSTEMS, NAMELY, FIRE ALARM EQUIPMENT AND SYSTEMS, FIRE ALARM EMERGENCY PHONE SYSTEMS, GRAPHICAL COMMAND CENTERS AND MANUAL STATIONS, SMOKE DETECTORS AND SENSORS, FLAME DETECTORS, HEAT DETECTORS AND SENSORS, SPRINKLER AND WATER FLOW MONITORING EQUIPMENT AND SYSTEMS, NAMELY, WATER FLOW SWITCHES AND SPRINKLER SUPERVISORY SWITCHES (U.S. CLS. 100 AND 101).

FIRST USE 5-31-2005; IN COMMERCE 5-31-2005.

CLASS 44—MEDICAL, BEAUTY AND AGRICULTURAL SERVICES

FOR HOME HEALTH MONITORING SERVICES, NAMELY, REMOTE MONITORING OF DATA INDICATIVE OF THE HEALTH OR CONDITION OF AN INDIVIDUAL, AND INTERACTIVE MEDICAL MONITORING AND ALERT SERVICE FOR REMINDING CLIENTS OF MEDICAL INFORMATION, NAMELY, MEDICINAL DOSAGE, MEDICATION COMPLIANCE, VITAL SIGNS AND HEALTHY BEHAVIOR (U.S. CLS. 100 AND 101).

FIRST USE 5-31-2005; IN COMMERCE 5-31-2005.

CLASS 45—PERSONAL AND LEGAL SERVICES

FOR CENTRAL STATION ELECTRIC PROTECTION SERVICES, NAMELY, FIRE ALARM SPRINKLER AND FIRE ALARM WATER FLOW MONITORING SERVICES, INTRUDER AND BURGLAR ALARM MONITORING SERVICES, FIRE ALARM MONITORING SERVICES; TROUBLE CALL SERVICES FOR ELECTRICAL PROTECTION EQUIPMENT AND SYSTEMS, NAMELY, MONITORING TELEPHONE CALLS FROM SUBSCRIBERS AND NOTIFYING EMERGENCY FACILITIES (U.S. CLS. 100 AND 101).

FIRST USE 5-31-2005; IN COMMERCE 5-31-2005.
DORITT L. CARROLL, EXAMINING ATTORNEY

SN 78-950,428. NORTHEAST FLORIDA MULTIPLE LISTING SERVICE, INC., JACKSONVILLE, FL. FILED 8-11-2006.



NO CLAIM IS MADE TO THE EXCLUSIVE RIGHT TO USE "REALTYWEB.NET", APART FROM THE MARK AS SHOWN.

"THE COLOR(S) RED, BLUE, AND GRAY IS/ARE CLAIMED AS A FEATURE OF THE MARK."

"THE MARK CONSISTS OF THE COLOR RED APPEARS IN REALTY AND NET. THE COLOR BLUE APPEARS IN WEB AND IN THE "PERIOD". THE COLOR GRAY APPEARS IN THE SHADING OF THE ENTIRE MARK."

CLASS 35—ADVERTISING AND BUSINESS

FOR PROVIDING INTERNET ACCESSIBLE TAX DATA TO MEMBERS AND OTHERS, NAMELY, REAL PROPERTY AND TANGIBLE PROPERTY TAX ASSESSMENT AND PAYMENT STATUS INFORMATION RELATED THERETO; LICENSING OF REAL ESTATE DATA TO OTHERS; LICENSING INFORMATION DATABASES TO OTHERS (U.S. CLS. 100, 101 AND 102).

CLASS 36—INSURANCE AND FINANCIAL

FOR PROVIDING INTERNET ACCESSIBLE DATA TO MEMBERS AND OTHERS, NAMELY REAL ESTATE PROPERTY ASSESSMENT AND PAYMENT STATUS INFORMATION RELATED THERETO; REAL ESTATE MULTIPLE LISTING SERVICE ACCESSIBLE OVER THE INTERNET (U.S. CLS. 100, 101 AND 102).

CLASS 38—COMMUNICATION

FOR PROVIDING MULTIPLE USER ACCESS TO THE INTERNET VIA HIGH SPEED BROADBAND CONNECTIONS (U.S. CLS. 100, 101 AND 104).

CLASS 41—EDUCATION AND ENTERTAINMENT

FOR INTERNET-BASED EDUCATION PROGRAMS FOR MEMBERS AND OTHERS IN THE FIELDS OF REAL ESTATE, ACCESSING INFORMATION OVER THE INTERNET, ELECTRONIC HARDWARE TECHNOLOGY, AND SOFTWARE USE (U.S. CLS. 100, 101 AND 107).

CLASS 42—SCIENTIFIC AND COMPUTER SERVICES

FOR INTERNET WEBSITE HOSTING SERVICES; PROVIDING INTERNET ACCESSIBLE REAL ESTATE RESEARCH SERVICES TO OTHERS; PROVIDING WEBSITE DESIGN SERVICES FOR MEMBERS AND OTHERS; REGISTERING WEBSITE DOMAIN NAMES FOR MEMBERS AND OTHERS. (U.S. CLS. 100 AND 101).

JENNIFER VASQUEZ, EXAMINING ATTORNEY

SN 78-952,163. JONES SODA CO. (USA) INC., SEATTLE, WA. FILED 8-15-2006.

JONES 24C

THE MARK CONSISTS OF STANDARD CHARACTERS WITHOUT CLAIM TO ANY PARTICULAR FONT, STYLE, SIZE, OR COLOR.

OWNER OF U.S. REG. NOS. 2,790,050, 3,008,470 AND OTHERS.

CLASS 5—PHARMACEUTICALS

FOR VITAMIN FORTIFIED BEVERAGES AND VITAMIN SUPPLEMENTS (U.S. CLS. 6, 18, 44, 46, 51 AND 52).

CLASS 32—LIGHT BEVERAGES

FOR NON-ALCOHOLIC CARBONATED AND NON-CARBONATED BEVERAGES, NAMELY, FRUIT JUICES, SOFT DRINKS, SPORTS DRINKS AND ENERGY DRINKS; SODA WATER, AND DRINKING WATER (U.S. CLS. 45, 46 AND 48).

MEGAN WHITNEY, EXAMINING ATTORNEY

SN 78-953,729. PILATES, S.A., BUENOS AIRES, ARGENTINA, FILED 8-16-2006.

SN 78-954,931. MENENDEZ, BARBARA J., NORTH BERGEN, NJ, FILED 8-17-2006.

TANGOLATES

THE MARK CONSISTS OF STANDARD CHARACTERS WITHOUT CLAIM TO ANY PARTICULAR FONT, STYLE, SIZE, OR COLOR.

CLASS 9—ELECTRICAL AND SCIENTIFIC APPARATUS

FOR PRE-RECORDED MEDIA CARRIERS, NAMELY, DVDS FEATURING SOUND, IMAGES, TEXT AND DATA ON HEALTH CLUB SERVICES, PHYSICAL FITNESS, EXERCISE AND INSTRUCTION IN THE FIELD OF PHYSICAL FITNESS AND EXERCISE (U.S. CLS. 21, 23, 26, 36 AND 38).

FIRST USE 6-30-2006; IN COMMERCE 6-30-2007.

CLASS 16—PAPER GOODS AND PRINTED MATTER

FOR PRINTED MATTER, NAMELY, MANUALS AND BROCHURES IN THE FIELD OF HEALTH CLUB SERVICES, PHYSICAL FITNESS, AND EXERCISE (U.S. CLS. 2, 5, 22, 23, 29, 37, 38 AND 50).

FIRST USE 6-30-2006; IN COMMERCE 6-30-2007.

LYDIA BELZER, EXAMINING ATTORNEY

SN 78-953,915. EVERGREEN CAPITAL MANAGEMENT, L.L.C., BELLEVUE, WA, FILED 8-16-2006.

RIGHT CYCLE INVESTING

THE MARK CONSISTS OF STANDARD CHARACTERS WITHOUT CLAIM TO ANY PARTICULAR FONT, STYLE, SIZE, OR COLOR.

NO CLAIM IS MADE TO THE EXCLUSIVE RIGHT TO USE "CYCLE INVESTING", APART FROM THE MARK AS SHOWN.

CLASS 36—INSURANCE AND FINANCIAL

FOR FINANCIAL ANALYSIS AND CONSULTATION; INVESTMENT ADVISORY SERVICES; INVESTMENT BY ELECTRONIC MEANS; INVESTMENT CONSULTATION (U.S. CLS. 100, 101 AND 102).

CLASS 41—EDUCATION AND ENTERTAINMENT

FOR EDUCATIONAL SERVICES, NAMELY, CONDUCTING SPEECHES AND LECTURES IN THE FIELD OF FINANCIAL INVESTING AND DISTRIBUTION OF COURSE MATERIAL IN CONNECTION THEREWITH (U.S. CLS. 100, 101 AND 107).

ROBERT LAVACHE, EXAMINING ATTORNEY

Mariposa Home

THE MARK CONSISTS OF STANDARD CHARACTERS WITHOUT CLAIM TO ANY PARTICULAR FONT, STYLE, SIZE, OR COLOR.

NO CLAIM IS MADE TO THE EXCLUSIVE RIGHT TO USE "HOME", APART FROM THE MARK AS SHOWN.

THE FOREIGN WORDING IN THE MARK TRANSLATES INTO ENGLISH AS "BUTTERFLY."

CLASS 24—FABRICS

FOR BATH LINEN, BATH SHEETS, BATH TOWELS, BEACH TOWELS, BED BLANKETS, BED CANOPIES, BED LINEN, BED SHEETS, BED SKIRTS, BED SPREADS, BLANKET THROWS, CLOTH COASTERS, COMFORTERS, CONTOUR SHEETS, CONTOURED MATTRESS COVERS, COVERLETS, COVERS FOR CUSHIONS, CRIB BUMPER PADS, CRIB BUMPERS, CRIB CANOPIES, CURTAIN FABRIC, CURTAINS, DINING LINENS, DISH CLOTHS, DRAPERIES, DUST RUFFLES, DUVET COVERS, DUVETS, FABRIC TABLE RUNNERS, FABRIC VALANCES, FABRIC WINDOW COVERINGS AND TREATMENTS, NAMELY, CURTAINS, DRAPERIES, SHEERS, SWAGS, AND VALANCES, FITTED TOILET LID COVERS, HAND TOWELS, HOUSEHOLD LINEN, KITCHEN LINENS, KITCHEN TOWELS, LARGE BATH TOWELS, OVEN MITTS, PET BLANKETS, PILLOW CASES, PILLOW COVERS, PILLOW SHAMS, PLACE MATS NOT OF PAPER, PLACE MATS OF TEXTILE MATERIAL, PLASTIC HANDKERCHIEFS, PLASTIC PLACE MATS, POT HOLDERS, QUILTS, RECEIVING BLANKETS, SHAMS, SHOWER CURTAINS, SWAGS AND FABRICS FOR THE MANUFACTURE OF HOME FURNISHINGS (U.S. CLS. 42 AND 50).

CLASS 42—SCIENTIFIC AND COMPUTER SERVICES

FOR PRODUCT DEVELOPMENT, PRODUCT DEVELOPMENT FOR OTHERS, PRODUCT DEVELOPMENT CONSULTATION, DESIGN FOR OTHERS IN THE HOME FURNISHING INDUSTRY, PACKAGING DESIGN, RESEARCH AND DEVELOPMENT FOR NEW PRODUCTS FOR OTHERS, RESEARCH AND DEVELOPMENT AND CONSULTATION RELATED THERETO IN THE FIELD OF HOME FURNISHINGS DESIGN, COMMERCIAL ART DESIGN, COMPUTER AIDED DESIGN FOR OTHERS, COMPUTER GRAPHICS SERVICES, GRAPHIC ART DESIGN, GRAPHIC DESIGN SERVICES, INTERIOR DECORATING, INTERIOR DECORATION CONSULTATION (U.S. CLS. 100 AND 101).

PRISCILLA MILTON, EXAMINING ATTORNEY

SN 78-955,381. RESULTANCE, INC., SEATTLE, WA, FILED 8-18-2006.

BRILLIANT ASSOCIATIONS

THE MARK CONSISTS OF STANDARD CHARACTERS WITHOUT CLAIM TO ANY PARTICULAR FONT, STYLE, SIZE, OR COLOR.

CLASS 9—ELECTRICAL AND SCIENTIFIC APPARATUS

FOR ELECTRONIC MEDIA, NAMELY, AUDIO/VIDEO DISCS AND TAPES, PRERECORDED DIGITAL DISCS AND TAPES, SERIES OF PRE-RECORDED COMPACT SOUND RECORDING DISCS, VIDEO DISCS AND VIDEOTAPES, ALL OF WHICH FEATURE INSTRUCTION IN BUSINESS MANAGEMENT AND STRATEGY PRESENTED THROUGH SPEECHES, SOUND EFFECTS AND MUSIC (U.S. CLS. 21, 23, 26, 36 AND 38).

CLASS 16—PAPER GOODS AND PRINTED MATTER

FOR PAPER AND PRINTED MATTER, NAMELY, BOOKLETS, BROCHURES, CATALOGS, DIRECTORIES AND A SERIES OF ARTICLES ALL IN THE FIELD OF BUSINESS NETWORKING, BRAND DEVELOPMENT, CUSTOMER SERVICE INITIATIVES, GOAL SETTING, MARKETING, LEADERSHIP, SALES, SPACE PLANNING AND FENG SHUI, STRATEGIC RELATIONSHIP BUILDING AND TEAM BUILDING; MAGAZINES, MANUALS, NEWSLETTERS, NEWSPAPERS, PAMPHLETS AND PERIODICALS IN THE FIELD OF BUSINESS NETWORKING, BRAND DEVELOPMENT, CUSTOMER SERVICE INITIATIVES, GOAL SETTING, MARKETING, LEADERSHIP, SALES, SPACE PLANNING AND FENG SHUI, STRATEGIC RELATIONSHIP PLANNING AND TEAM BUILDING; AGENDAS, EVENT ALBUMS, BUSINESS CARDS, BOOKMARKS, CALENDARS, DESK DIARIES; PHOTOGRAPHS AND PHOTOGRAPH STANDS; PRINTED GREETING CARDS; PRINTED EDUCATIONAL, INSTRUCTIONAL AND TEACHING MATERIALS IN THE FIELD OF BUSINESS NETWORKING, BRAND DEVELOPMENT, CUSTOMER SERVICE INITIATIVES, GOAL SETTING, MARKETING, LEADERSHIP, SALES, SPACE PLANNING AND FENG SHUI, STRATEGIC RELATIONSHIP BUILDING AND TEAM BUILDING; PROMOTIONAL POSTCARDS AND POSTERS, SERIES OF BOOKS IN THE FIELD OF BUSINESS NETWORKING, BRAND DEVELOPMENT, CUSTOMER SERVICE INITIATIVES, GOAL SETTING AND MARKETING, LEADERSHIP, NETWORKING, SALES, SPACE PLANNING AND FENG SHUI, STRATEGIC RELATIONSHIP PLANNING AND TEAM BUILDING; STATIONERY, NAMELY, LETTERHEAD PAPER AND ENVELOPES, MEMO PADS, PROTECTIVE STATIONARY COVERS, FOLDERS AND STICKERS; PENS AND PENCILS; PRINTED GREETING CARDS WITH ELECTRONIC INFORMATION STORED THEREIN (U.S. CLS. 2, 5, 22, 23, 29, 37, 38 AND 50).

CLASS 35—ADVERTISING AND BUSINESS

FOR BUSINESS CONSULTING AND INFORMATION SERVICES, MARKETING CONSULTING SERVICES AND BUSINESS ORGANIZATION AND MANAGEMENT CONSULTING SERVICES; PROVIDING BUSINESS INFORMATION SERVICES IN THE FIELD OF BUSINESS NETWORKING, BRAND DEVELOPMENT, CUSTOMER SERVICE INITIATIVES, GOAL SETTING AND MARKETING, BUSINESS LEADERSHIP, CAREER NETWORKING, SALES, STRATEGIC CUSTOMER RELATIONSHIP PLANNING AND BUSINESS TEAM BUILDING; CATALOG, MAIL ORDER, ON-LINE, RETAIL AND WHOLESALE STORE SERVICES OF MEDIA RECORDATIONS, BOOKS AND PRINTED PRODUCTS IN THE FIELD OF BUSINESS NETWORKING, BRAND DEVELOPMENT, CUSTOMER SERVICE INITIATIVES, GOAL SETTING AND MARKETING, LEADERSHIP, NETWORKING, SALES, SPACE PLANNING AND FENG SHUI, STRATEGIC RELATIONSHIP PLANNING AND TEAM BUILDING (U.S. CLS. 100, 101 AND 102).

CLASS 38—COMMUNICATION

FOR TELECOMMUNICATIONS SERVICES, NAMELY, BROADCASTING RADIO AND TELEVISION PROGRAMS AND FILMS VIA A GLOBAL COMPUTER NETWORK; COMMUNICATIONS BY TELEPHONE AND FACSIMILE TRANSMISSION; ELECTRONIC, ELECTRIC, AND DIGITAL TRANSMISSION OF VOICE, DATA, IMAGES, SOUND, SIGNAL AND MESSAGES; ELECTRONIC TRANSMISSION OF BOOKS, ELECTRONIC MAGAZINES AND NEWSLETTERS VIA A GLOBAL COMPUTER NETWORK; TRANSMISSION OF DATA, DOCUMENTS AND INFORMATION BY ELECTRONIC MEDIA; DELIVERY OF PERSONALIZED GREETING CARDS AND MAILERS TO OTHERS VIA ELECTRONIC MAIL (U.S. CLS. 100, 101 AND 104).

CLASS 41—EDUCATION AND ENTERTAINMENT

FOR EDUCATIONAL AND INSTRUCTIONAL SERVICES, NAMELY, ARRANGING AND CONDUCTING CONFERENCES, RETREATS, SEMINARS, AND WORKSHOPS IN THE FIELD OF BUSINESS NETWORKING, BRAND DEVELOPMENT, CUSTOMER SERVICE INITIATIVES, GOAL SETTING AND MARKETING, LEADERSHIP, NETWORKING, SALES, SPACE PLANNING AND FENG SHUI, STRATEGIC RELATIONSHIP PLANNING AND TEAM BUILDING; ENTERTAINMENT SERVICES, NAMELY, LIVE SPEAKING PERFORMANCES AND SPEAKING ENGAGEMENTS IN THE FIELD OF BUSINESS NETWORKING, BRAND DEVELOPMENT, CUSTOMER SERVICE INITIATIVES, GOAL SETTING AND MARKETING, LEADERSHIP, NETWORKING, SALES, SPACE PLANNING AND FENG SHUI, STRATEGIC RELATIONSHIP PLANNING AND TEAM BUILDING; PRODUCTION OF RADIO AND TELEVISION AND FILM PROGRAMS FOR TRANSMISSION VIA BROADCAST, CABLE, DIGITAL AND GLOBAL COMPUTER NETWORK AND PUBLICATION OF ACCOMPANYING MATERIALS IN THE FORM OF BOOKS, MAGAZINES AND NEWSLETTERS; ELECTRONIC PUBLISHING, NAMELY PUBLICATION OF TEXT AND GRAPHIC WORKS OF OTHERS ON CDS, DVDS, AND ON-LINE FEATURING FICTION AND NONFICTION; PUBLICATION SERVICES FOR OTHERS, NAMELY, BOOKS, MAGAZINES, NEWSLETTERS, AND SCREENPLAYS (U.S. CLS. 100, 101 AND 107).

MARILYN IZZI, EXAMINING ATTORNEY

SN 78-955,445. RESULTANCE, INC., SEATTLE, WA. FILED 8-18-2006.

THE ASSOCIATION AMBASSADOR

THE MARK CONSISTS OF STANDARD CHARACTERS WITHOUT CLAIM TO ANY PARTICULAR FONT, STYLE, SIZE, OR COLOR.

CLASS 9—ELECTRICAL AND SCIENTIFIC APPARATUS

FOR ELECTRONIC MEDIA, NAMELY, AUDIO/VIDEO DISCS AND TAPES, PRERECORDED DIGITAL DISCS AND TAPES, SERIES OF PRE-RECORDED COMPACT SOUND RECORDING DISCS, VIDEO DISCS AND VIDEOTAPES, ALL OF WHICH FEATURE INSTRUCTION IN BUSINESS MANAGEMENT AND STRATEGY PRESENTED THROUGH SPEECHES, SOUND EFFECTS AND MUSIC (U.S. CLS. 21, 23, 26, 36 AND 38).

CLASS 16—PAPER GOODS AND PRINTED MATTER

FOR PAPER AND PRINTED MATTER, NAMELY, BOOKLETS, BROCHURES, CATALOGS, DIRECTORIES AND A SERIES OF ARTICLES ALL IN THE FIELD OF BUSINESS NETWORKING, BRAND DEVELOPMENT, CUSTOMER SERVICE INITIATIVES, GOAL SETTING, MARKETING, LEADERSHIP, SALES, SPACE PLANNING AND FENG SHUI, STRATEGIC RELATIONSHIP BUILDING AND TEAM BUILDING; MAGAZINES, MANUALS, NEWSLETTERS, NEWSPAPERS, PAMPHLETS AND PERIODICALS IN THE FIELD OF BUSINESS NETWORKING, BRAND DEVELOPMENT, CUSTOMER SERVICE INITIATIVES, GOAL SETTING, MARKETING, LEADERSHIP, SALES, SPACE PLANNING AND FENG SHUI, STRATEGIC RELATIONSHIP PLANNING AND TEAM BUILDING; AGENDAS, EVENT ALBUMS, BUSINESS CARDS, BOOKMARKS, CALENDARS, DESK DIARIES; PHOTOGRAPHS AND PHOTOGRAPH STANDS; PRINTED GREETING CARDS; PRINTED EDUCATIONAL, INSTRUCTIONAL AND TEACHING MATERIALS IN THE FIELD OF BUSINESS NETWORKING, BRAND DEVELOPMENT, CUSTOMER SERVICE INITIATIVES, GOAL SETTING, MARKETING, LEADERSHIP, SALES, SPACE PLANNING AND FENG SHUI, STRATEGIC RELATIONSHIP PLANNING AND TEAM BUILDING; PROMOTIONAL POSTCARDS AND POSTERS, SERIES OF BOOKS IN THE FIELD OF BUSINESS NETWORKING, BRAND DEVELOPMENT, CUSTOMER SERVICE INITIATIVES, GOAL SETTING AND MARKETING, LEADERSHIP, NETWORKING, SALES, SPACE PLANNING AND FENG SHUI, STRATEGIC RELATIONSHIP PLANNING AND TEAM BUILDING; STATIONERY, NAMELY, LETTERHEAD PAPER AND ENVELOPES, MEMO PADS, PROTECTIVE STATIONARY COVERS, FOLDERS AND STICKERS; PENS AND PENCILS; PRINTED GREETING CARDS WITH ELECTRONIC INFORMATION STORED THEREIN (U.S. CLS. 2, 5, 22, 23, 29, 37, 38 AND 50).

CLASS 35—ADVERTISING AND BUSINESS

FOR BUSINESS CONSULTING AND INFORMATION SERVICES, MARKETING CONSULTING SERVICES AND BUSINESS ORGANIZATION AND MANAGEMENT CONSULTING SERVICES; PROVIDING BUSINESS INFORMATION SERVICES IN THE FIELD OF BUSINESS NETWORKING, BRAND DEVELOPMENT, CUSTOMER SERVICE INITIATIVES, GOAL SETTING AND MARKETING, BUSINESS LEADERSHIP, CAREER NETWORKING, SALES, STRATEGIC CUSTOMER RELATIONSHIP PLANNING AND BUSINESS TEAM BUILDING; CATALOG, MAIL ORDER, ON-LINE, RETAIL AND WHOLESALE STORE SERVICES OF MEDIA RECORDATIONS, BOOKS AND PRINTED PRODUCTS IN THE FIELD OF BUSINESS NETWORKING, BRAND DEVELOPMENT, CUSTOMER SERVICE INITIATIVES, GOAL SETTING AND MARKETING, LEADERSHIP, NETWORKING, SALES, SPACE PLANNING AND FENG SHUI, STRATEGIC RELATIONSHIP PLANNING AND TEAM BUILDING (U.S. CLS. 100, 101 AND 102).

CLASS 38—COMMUNICATION

FOR TELECOMMUNICATIONS SERVICES, NAMELY, BROADCASTING RADIO AND TELEVISION PROGRAMS AND FILMS VIA A GLOBAL COMPUTER NETWORK; COMMUNICATIONS BY TELEPHONE AND FACSIMILE TRANSMISSION; ELECTRONIC, ELECTRIC, AND DIGITAL TRANSMISSION OF VOICE, DATA, IMAGES, SOUND, SIGNAL AND MESSAGES; ELECTRONIC TRANSMISSION OF BOOKS, ELECTRONIC MAGAZINES AND NEWSLETTERS VIA A GLOBAL COMPUTER NETWORK; TRANSMISSION OF DATA, DOCUMENTS AND INFORMATION BY ELECTRONIC MEDIA; DELIVERY OF PERSONALIZED GREETING CARDS AND MAILERS TO OTHERS VIA ELECTRONIC MAIL (U.S. CLS. 100, 101 AND 104).

CLASS 41—EDUCATION AND ENTERTAINMENT

FOR EDUCATIONAL AND INSTRUCTIONAL SERVICES, NAMELY, ARRANGING AND CONDUCTING CONFERENCES, RETREATS, SEMINARS, AND WORKSHOPS IN THE FIELD OF BUSINESS NETWORKING, BRAND DEVELOPMENT, CUSTOMER SERVICE INITIATIVES, GOAL SETTING AND MARKETING, LEADERSHIP, NETWORKING, SALES, SPACE PLANNING AND FENG SHUI, STRATEGIC RELATIONSHIP PLANNING AND TEAM BUILDING; ENTERTAINMENT SERVICES, NAMELY, LIVE SPEAKING PERFORMANCES AND SPEAKING ENGAGEMENTS IN THE FIELD OF BUSINESS NETWORKING, BRAND DEVELOPMENT, CUSTOMER SERVICE INITIATIVES, GOAL SETTING AND MARKETING, LEADERSHIP, NETWORKING, SALES, SPACE PLANNING AND FENG SHUI, STRATEGIC RELATIONSHIP PLANNING AND TEAM BUILDING; PRODUCTION OF RADIO AND TELEVISION AND FILM PROGRAMS FOR TRANSMISSION VIA BROADCAST, CABLE, DIGITAL AND GLOBAL COMPUTER NETWORK AND PUBLICATION OF ACCOMPANYING MATERIALS IN THE FORM OF BOOKS, MAGAZINES AND NEWSLETTERS; ELECTRONIC PUBLISHING, NAMELY PUBLICATION OF TEXT AND GRAPHIC WORKS OF OTHERS ON CDS, DVDS, AND ON-LINE FEATURING FICTION AND NONFICTION; PUBLICATION SERVICES FOR OTHERS, NAMELY, BOOKS, MAGAZINES, NEWSLETTERS, AND SCREENPLAYS (U.S. CLS. 100, 101 AND 107).

MARILYN IZZI, EXAMINING ATTORNEY

SN 78-956,237. FRAGRANCE INTERNATIONAL INC., YOUNGSTOWN, OH. FILED 8-21-2006.

KISS & TELL

THE MARK CONSISTS OF STANDARD CHARACTERS WITHOUT CLAIM TO ANY PARTICULAR FONT, STYLE, SIZE, OR COLOR.

OWNER OF U.S. REG. NOS. 2,775,931, 2,775,938 AND 2,942,310.

CLASS 3—COSMETICS AND CLEANING PREPARATIONS

FOR BODY LOTION, EAU DE PARFUM, EAU DE TOILETTE, PERFUME AND PARFUM (U.S. CLS. 1, 4, 6, 50, 51 AND 52).

FIRST USE 10-8-1998; IN COMMERCE 11-15-1998.

CLASS 25—CLOTHING

FOR T-SHIRTS (U.S. CLS. 22 AND 39).
FIRST USE 12-2-2002; IN COMMERCE 12-2-2002.
DAVID I, EXAMINING ATTORNEY

SN 78-957,368. AID FOR AIDS INTERNATIONAL, INC.,
NEW YORK, NY. FILED 8-22-2006.



SEC. 2(F) "AID FOR AIDS".

CLASS 36—INSURANCE AND FINANCIAL

FOR CHARITABLE FUNDRAISING SERVICES AND ORGANIZING, ARRANGING AND CONDUCTING CHARITABLE FUNDRAISING EVENTS DIRECTED TOWARDS SUPPORTING ACCESS TO MEDICATIONS, HEALTH EDUCATION, AND HIV PREVENTION STRATEGIES AND ADVOCACY (U.S. CLS. 100, 101 AND 102).
FIRST USE 12-31-1997; IN COMMERCE 12-31-1997.

CLASS 41—EDUCATION AND ENTERTAINMENT

FOR PROVIDING TRAINING AND EDUCATION PROGRAMS IN THE FIELD OF HEALTH EDUCATION FOR THOSE ALREADY LIVING WITH HIV AND HIV PREVENTION (U.S. CLS. 100, 101 AND 107).
FIRST USE 12-31-1997; IN COMMERCE 12-31-1997.
DAVID TOOLEY, EXAMINING ATTORNEY

SN 78-957,448. ALLPHASE CLINICAL RESEARCH (US),
INC., WILMINGTON, DE. FILED 8-22-2006.

ALLPHASE CLINICAL RESEARCH

THE MARK CONSISTS OF STANDARD CHARACTERS WITHOUT CLAIM TO ANY PARTICULAR FONT, STYLE, SIZE, OR COLOR.

NO CLAIM IS MADE TO THE EXCLUSIVE RIGHT TO USE "CLINICAL RESEARCH", APART FROM THE MARK AS SHOWN.

CLASS 35—ADVERTISING AND BUSINESS

FOR PRE-CLINICAL TO PHASE FOUR CLINICAL TRIAL MANAGEMENT SERVICES, NAMELY, PRE-STUDY DOCUMENT COLLECTION AND REVIEW, SITE SELECTION, VISITS AND AUDITS, SITE COMPLIANCE, PROJECT TRACKING AND MONITORING REPORTS, NEGOTIATION AND ADMINISTRATION OF INVESTIGATOR GRANTS, LABELING, PACKAGING, DISTRIBUTION, COORDINATION AND TRACKING OF CLINICAL TRIAL PRODUCTS AND MATERIALS, REGULATORY DOCUMENT PROCESSING, CENTRAL LABORATORY SELECTION AND COORDINATION; PRE-CLINICAL TO PHASE FOUR CLINICAL TRIAL MANAGEMENT SERVICES, NAMELY, MANAGING SITE AND STUDY-SPECIFIC SUBJECT RECRUITMENT STRATEGIES AND PROGRAMS IN THE NATURE OF CONTINGENCY STRATEGIES AND SOLUTIONS TO ADDRESS SPECIFIC PROJECT CHALLENGES; PRE-CLINICAL TO PHASE FOUR CLINICAL TRIAL MANAGEMENT SERVICES, NAMELY, MANAGING THE DEVELOPMENT OF ALL STUDY RELATED DOCUMENTS AND MATERIALS IN THE NATURE OF STUDY PROTOCOLS, AMENDMENTS, PAPER AND ELECTRONIC CASE REPORT FORMS, INFORMED CONSENT FORMS, DIARY CARDS, SAFETY NARRATIVES, PRESENTATION POSTERS, TECHNICAL BRIEFS AND TRAINING MANUALS; PRE-CLINICAL TO PHASE FOUR CLINICAL TRIAL MANAGEMENT SERVICES, NAMELY, MANAGING ALL ASPECTS OF STUDY, DRUG RECONCILIATION, AND INVENTORY AND DISTRIBUTION REPORTS, MANAGING ALL ASPECTS OF CLINICAL TRIALS, NAMELY, MANAGING INVESTIGATORS, TECHNICIANS, AND PARTICIPANTS, ETHICAL REVIEWS, INVESTIGATOR MEETINGS, DATABASES, STATISTICAL ANALYSES AND REPORTING, RANDOMIZATION LOGISTICS, MEDICAL WRITING SERVICES, RECRUITMENT OF INVESTIGATORS, TECHNICIANS AND PARTICIPANTS; PROVIDING DATA MANAGEMENT SERVICES IN THE MEDICAL, PHARMACEUTICAL AND BIOTECHNOLOGICAL FIELD (U.S. CLS. 100, 101 AND 102).

CLASS 39—TRANSPORTATION AND STORAGE

FOR CLINICAL SUPPLY STORAGE IN THE FIELD OF CLINICAL AND MEDICAL SUPPLIES (U.S. CLS. 100 AND 105).

CLASS 41—EDUCATION AND ENTERTAINMENT

FOR PROVIDING TRAINING IN THE FIELD OF CLINICAL TRIALS AND CLINICAL TRIAL MANAGEMENT FOR THE PHARMACEUTICAL AND BIOTECHNOLOGICAL INDUSTRIES (U.S. CLS. 100, 101 AND 107).

CLASS 42—SCIENTIFIC AND COMPUTER SERVICES

FOR MEDICAL AND SCIENTIFIC RESEARCH CONSULTING REGARDING PRE-CLINICAL TO PHASE FOUR CLINICAL TRIALS; REGULATORY AFFAIRS, NAMELY, REVIEWING STANDARDS AND PRACTICES TO ASSURE COMPLIANCE WITH CLINICAL TRIAL LAWS AND REGULATIONS; PROVIDING QUALITY ASSURANCE SERVICES IN THE PHARMACEUTICAL AND BIOTECHNOLOGICAL INDUSTRIES (U.S. CLS. 100 AND 101).

BRIAN PINO, EXAMINING ATTORNEY

SN 78-957,591. UBISOFT INC., SAN FRANCISCO, CA. FILED 8-22-2006.

ENDWAR

THE MARK CONSISTS OF STANDARD CHARACTERS WITHOUT CLAIM TO ANY PARTICULAR FONT, STYLE, SIZE, OR COLOR.

CLASS 9—ELECTRICAL AND SCIENTIFIC APPARATUS

FOR GAME SOFTWARE AND ELECTRONIC GAME PROGRAMS, NAMELY, SOFTWARE GAMES RECORDED ON CD-ROM AND DIGITAL VIDEO DISCS FOR COMPUTERS; SOFTWARE GAMES RECORDED ON CD-ROMS, DIGITAL VIDEO DISCS, AND CARTRIDGES FOR CONSOLE AND INDIVIDUAL, PORTABLE GAMING SYSTEMS; SOFTWARE GAMES THAT ARE DOWNLOADABLE FROM A REMOTE COMPUTER SITE AND ELECTRONIC GAME SOFTWARE FOR MOBILE PHONES, PERSONAL DIGITAL ASSISTANTS, AND HANDHELD COMPUTERS (U.S. CLS. 21, 23, 26, 36 AND 38).

CLASS 41—EDUCATION AND ENTERTAINMENT

FOR ENTERTAINMENT SERVICES NAMELY, PROVIDING AN ON-LINE COMPUTER GAME FOR OTHERS OVER LOCAL AREA COMPUTER NETWORKS AND PROVIDING TECHNICAL INFORMATION ON-LINE RELATING TO COMPUTER GAMES, VIDEO GAMES AND COMPUTER AND VIDEO GAMES RELATED PRODUCTS, NAMELY, COMPUTER MONITORS, COMPUTER PROCESSORS, COMPUTER CONTROLLERS FOR ELECTRONIC VIDEO GAMES, GRAPHIC CARDS, SPEAKERS, CONSOLE VIDEO GAME MACHINES, CONSOLE VIDEO GAME CONTROLLERS, AND MOBILE PHONES (U.S. CLS. 100, 101 AND 107).

CHRISTINA SOBRAL, EXAMINING ATTORNEY

SN 78-957,945. T-NETIX, INC., DALLAS, TX. FILED 8-22-2006.

T-NETIX

THE MARK CONSISTS OF STANDARD CHARACTERS WITHOUT CLAIM TO ANY PARTICULAR FONT, STYLE, SIZE, OR COLOR.

CLASS 35—ADVERTISING AND BUSINESS

FOR OPERATION OF TELEPHONE COMMUNICATIONS CENTERS FOR OTHERS (U.S. CLS. 100, 101 AND 102).

FIRST USE 9-13-2005; IN COMMERCE 9-13-2005.

CLASS 36—INSURANCE AND FINANCIAL

FOR BILL PAYMENT SERVICES; PROVIDING COLLECTION SERVICES FOR VOICE COMMUNICATIONS APPLICATIONS, NAMELY, THE COLLECTION OF FEES FOR PREPAID CALLING PLANS AND THE COLLECTION OF CHARGES ASSOCIATED WITH VOICE COMMUNICATIONS, ALL OF THE FOREGOING PROVIDED TO PRISON INMATES AND RELATED PARTIES (U.S. CLS. 100, 101 AND 102).

FIRST USE 9-13-2005; IN COMMERCE 9-13-2005.

CLASS 38—COMMUNICATION

FOR TELECOMMUNICATIONS SERVICES, NAMELY, PERSONAL COMMUNICATION SERVICES, CALL VALIDATION SERVICES, TELEPHONE VOICE MESSAGING SERVICES, ALL OF THE FOREGOING PROVIDED TO PRISON INMATES AND RELATED PARTIES (U.S. CLS. 100, 101 AND 104).

FIRST USE 9-13-2005; IN COMMERCE 9-13-2005.

HEATHER BIDDULPH, EXAMINING ATTORNEY

SN 78-958,572. PRIMROSE SCHOOL FRANCHISING COMPANY, ACWORTH, GA. FILED 8-23-2006.

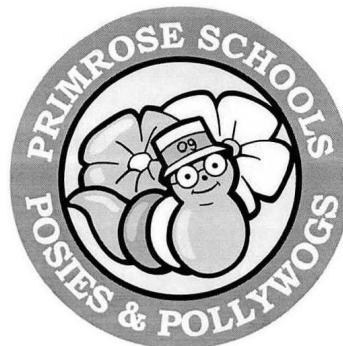

OWNER OF U.S. REG. NO. 2,017,863.
NO CLAIM IS MADE TO THE EXCLUSIVE RIGHT TO USE "SCHOOLS", APART FROM THE MARK AS SHOWN.

CLASS 41—EDUCATION AND ENTERTAINMENT

FOR EDUCATIONAL SERVICES, NAMELY, PRE-SCHOOL AND PRIMARY SCHOOL EDUCATIONAL SERVICES (U.S. CLS. 100, 101 AND 107).

FIRST USE 7-0-1995; IN COMMERCE 7-0-1995.

CLASS 43—HOTEL AND RESTAURANT SERVICES

FOR CHILD CARE SERVICES (U.S. CLS. 100 AND 101).

FIRST USE 7-0-1995; IN COMMERCE 7-0-1995.
DANIEL CAPSHAW, EXAMINING ATTORNEY

SN 78-959,753. CLEMENT, EDMUND, CLAYTON, NJ. AND CLEMENT, JUANNA, CLAYTON, NJ. FILED 8-24-2006.



NO CLAIM IS MADE TO THE EXCLUSIVE RIGHT TO USE "BUSINESS", APART FROM THE MARK AS SHOWN. THE MARK CONSISTS OF A CREST MADE OF LEAVES FRAMING THE TEXT OF THE MARK.

CLASS 9—ELECTRICAL AND SCIENTIFIC APPARATUS

FOR DOWNLOADABLE MUSICAL SOUND RECORDINGS; PRE-RECORDED CD'S, VIDEO TAPES, LASER DISKS AND DVD'S FEATURING MUSIC (U.S. CLS. 21, 23, 26, 36 AND 38).

CLASS 41—EDUCATION AND ENTERTAINMENT

FOR ENTERTAINMENT, NAMELY LIVE PERFORMANCES BY MUSICAL BANDS (U.S. CLS. 100, 101 AND 107).

JOHN DWYER, EXAMINING ATTORNEY

SN 78-960,272. THE WOMEN'S BEAN PROJECT, DENVER, CO. FILED 8-25-2006.

WOMEN'S BEAN PROJECT

THE MARK CONSISTS OF STANDARD CHARACTERS WITHOUT CLAIM TO ANY PARTICULAR FONT, STYLE, SIZE, OR COLOR.

OWNER OF U.S. REG. NO. 1,954,691.

NO CLAIM IS MADE TO THE EXCLUSIVE RIGHT TO USE "WOMEN'S" AND "PROJECT" FOR CLASS 041 AND "BEAN" FOR CLASSES 029 AND 030, APART FROM THE MARK AS SHOWN.

CLASS 29—MEATS AND PROCESSED FOODS

FOR DRIED SOUP MIXES, BEAN SOUP MIXES, CHILI, BEAN DIPS (U.S. CL. 46).

FIRST USE 3-0-1989; IN COMMERCE 6-0-1990.

CLASS 30—STAPLE FOODS

FOR COFFEES, COFFEE BEANS, INSTANT ICED TEA MIXES, BREAD MIXES, COOKIE MIXES, SALSA MIXES, FAJITA MARINADES, SPICES, SPICE RUBS, CANDY, NAMELY, JELLY BEANS (U.S. CL. 46).

FIRST USE 3-0-1989; IN COMMERCE 6-0-1990.

CLASS 41—EDUCATION AND ENTERTAINMENT

FOR TEACHING WORKPLACE COMPETENCIES FOR ENTRY-LEVEL JOBS THROUGH ON THE JOB TRAINING AND BY TEACHING EMPLOYMENT SKILLS IN THE GOURMET FOOD PRODUCTION BUSINESS (U.S. CLS. 100, 101 AND 107).

FIRST USE 3-0-1989; IN COMMERCE 6-0-1990.
DAVID I, EXAMINING ATTORNEY

SN 78-960,284. THE WOMEN'S BEAN PROJECT, DENVER, CO. FILED 8-25-2006.



women's
BEAN PROJECT

OWNER OF U.S. REG. NO. 1,954,691.

NO CLAIM IS MADE TO THE EXCLUSIVE RIGHT TO USE "WOMEN'S" AND "PROJECT" FOR CLASS 041 AND "BEAN" FOR CLASSES 029 AND 030, APART FROM THE MARK AS SHOWN.

CLASS 29—MEATS AND PROCESSED FOODS

FOR DRIED SOUP MIXES, BEAN SOUP MIXES, CHILI, BEAN DIPS (U.S. CL. 46).

FIRST USE 8-21-2003; IN COMMERCE 8-21-2003.

CLASS 30—STAPLE FOODS

FOR COFFEES, COFFEE BEANS, INSTANT ICED TEA MIXES, BREAD MIXES, COOKIE MIXES, SALSA MIXES, FAJITA MARINADES, SPICES, SPICE RUBS, CANDY, NAMELY, JELLY BEANS (U.S. CL. 46).

FIRST USE 8-21-2003; IN COMMERCE 8-21-2003.

CLASS 41—EDUCATION AND ENTERTAINMENT

FOR TEACHING WORKPLACE COMPETENCIES FOR ENTRY-LEVEL JOBS THROUGH ON THE JOB TRAINING AND BY TEACHING EMPLOYMENT SKILLS IN THE GOURMET FOOD PRODUCTION BUSINESS (U.S. CLS. 100, 101 AND 107).

FIRST USE 8-21-2003; IN COMMERCE 8-21-2003.
DAVID I, EXAMINING ATTORNEY

SN 78-960,488. GIANVITO ROSSI SRL UNIPERSONALE, SAN MAURO PASCOLI (FC), ITALY, FILED 8-25-2006.

SN 78-960,646. LUTHERAN FAMILY AND CHILDREN'S SERVICES OF MISSOURI, ST. LOUIS, MO. FILED 8-25-2006.

Gianvito Rossi

OWNER OF U.S. REG. NO. 1,954,967.
THE NAME "GIANVITO ROSSI" IDENTIFIES A LIVING INDIVIDUAL WHOSE CONSENT IS OF RECORD.

CLASS 9—ELECTRICAL AND SCIENTIFIC APPARATUS

FOR EYEGLASSES; EYEGLASSES LENSES; EYEGLASSES FRAMES AND EYEGLASSES CASES (U.S. CLS. 21, 23, 26, 36 AND 38).

CLASS 14—JEWELRY

FOR BRACELETS, BROOCHES, HOROLOGICAL AND CHRONOMETRICAL INSTRUMENTS AND PART THEREOF; CASES FOR WATCHES AND CLOCKS; EARRINGS; JEWEL CHAINS, JEWELRY BOXES AND CASES; KEY CHAINS AND HOLDERS OF PRECIOUS METALS, SEMI-PRECIOUS METALS OR COATED THEREWITH; NECKLACES; PENDANTS; PRECIOUS METAL AND ALLOYS THEREOF; PRECIOUS STONES; RINGS BEING JEWELRY, PRECIOUS AND SEMI-PRECIOUS GEMSTONE; SEMI-WROUGHT PRECIOUS STONES AND THEIR IMITATIONS (U.S. CLS. 2, 27, 28 AND 50).

CLASS 18—LEATHER GOODS

FOR TRUNKS, SUIT-CASES, ALL-PURPOSE CARRYING BAGS, TRAVELING BAGS, SCHOOL BAGS, SHOULDER BAGS, KEY BAGS, UMBRELLAS, WALLET, PURSES (U.S. CLS. 1, 2, 3, 22 AND 41).

CLASS 25—CLOTHING

FOR FOOTWEAR, GLOVES AND BELTS (U.S. CLS. 22 AND 39).
MARY BOAGNI, EXAMINING ATTORNEY



NO CLAIM IS MADE TO THE EXCLUSIVE RIGHT TO USE "LUTHERAN FAMILY AND CHILDREN'S SERVICES OF MISSOURI", APART FROM THE MARK AS SHOWN. THE MARK CONSISTS OF THE LETTERS LfCS WITH THE WORDS "GROWING HOPE" ABOVE, THREE HUMAN BODIES WITH ARMS UPRAISED TO THE RIGHT, AND THE WORDS "LUTHERAN FAMILY AND CHILDREN'S SERVICES OF MISSOURI" BELOW.

CLASS 44—MEDICAL, BEAUTY AND AGRICULTURAL SERVICES

FOR MENTAL HEALTH COUNSELING AND PSYCHOTHERAPY AS IT RELATES TO RELATIONSHIPS; PSYCHOLOGICAL COUNSELING (U.S. CLS. 100 AND 101).

FIRST USE 1-31-2006; IN COMMERCE 1-31-2006.

CLASS 45—PERSONAL AND LEGAL SERVICES

FOR ADOPTION AGENCIES; ADOPTION COUNSELING; ADOPTION PLACEMENT; GRIEF COUNSELING; MARRIAGE COUNSELING (U.S. CLS. 100 AND 101).

FIRST USE 1-31-2006; IN COMMERCE 1-31-2006.
JAMES STEIN, EXAMINING ATTORNEY

SN 78-960,826. WOODSTUFF MANUFACTURING, INC., PHOENIX, AZ. FILED 8-25-2006.

CREATIONS

CLASS 20—FURNITURE AND ARTICLES NOT OTHERWISE CLASSIFIED

FOR HOUSEHOLD FURNISHINGS, NAMELY, BEDROOM FURNITURE (U.S. CLS. 2, 13, 22, 25, 32 AND 50).

CLASS 39—TRANSPORTATION AND STORAGE

FOR DISTRIBUTION SERVICES, NAMELY, DELIVERY OF HOUSEHOLD FURNISHINGS (U.S. CLS. 100 AND 105).

CLASS 42—SCIENTIFIC AND COMPUTER SERVICES

FOR DESIGN FOR OTHERS IN THE FIELD OF HOUSEHOLD FURNISHINGS (U.S. CLS. 100 AND 101).
KATHERINE CHANG, EXAMINING ATTORNEY

SN 78-960,850. WOODSTUFF MANUFACTURING, INC.,
PHOENIX, AZ. FILED 8-25-2006.

CREATIONS
give them the moon and the stars

CLASS 20—FURNITURE AND ARTICLES NOT OTHERWISE CLASSIFIED

FOR HOUSEHOLD FURNISHINGS, NAMELY, BED-ROOM FURNITURE (U.S. CLS. 2, 13, 22, 25, 32 AND 50).

CLASS 39—TRANSPORTATION AND STORAGE

FOR DISTRIBUTION SERVICES, NAMELY, DELIVERY OF HOUSEHOLD FURNISHINGS (U.S. CLS. 100 AND 105).

CLASS 42—SCIENTIFIC AND COMPUTER SERVICES

FOR DESIGN FOR OTHERS IN THE FIELD OF HOUSEHOLD FURNISHINGS (U.S. CLS. 100 AND 101).
KATHERINE CHANG, EXAMINING ATTORNEY

SN 78-961,026. GREAT NORTHWEST MOVING COMPANY,
KIRKLAND, WA. FILED 8-25-2006.

AIR VAN

THE MARK CONSISTS OF STANDARD CHARACTERS WITHOUT CLAIM TO ANY PARTICULAR FONT, STYLE, SIZE, OR COLOR.

OWNER OF U.S. REG. NO. 2,853,729.
NO CLAIM IS MADE TO THE EXCLUSIVE RIGHT TO USE "VAN", APART FROM THE MARK AS SHOWN.

CLASS 35—ADVERTISING AND BUSINESS

FOR INVENTORY CONTROL; TRANSPORTATION LOGISTICS SERVICES, NAMELY, ARRANGING THE TRANSPORTATION OF GOODS FOR OTHERS; MOVING AND RELOCATION SERVICES, NAMELY PLANNING AND IMPLEMENTING MOVES OF HOMES AND OFFICES (U.S. CLS. 100, 101 AND 102).
FIRST USE 0-0-1958; IN COMMERCE 0-0-1958.

CLASS 39—TRANSPORTATION AND STORAGE

FOR PACKAGING ARTICLES FOR TRANSPORTATION; MOVING VAN SERVICES; FREIGHT FORWARDING; WAREHOUSE STORAGE; FURNITURE MOVING; FURNITURE STORAGE; WAREHOUSING SERVICES, NAMELY, STORAGE, DISTRIBUTION, PICK-UP, AND PACKING FOR SHIPMENT OF DOCUMENTS, BUSINESS RECORDS DOCUMENTS, PACKAGES, RAW MATERIALS, AND OTHER FREIGHT FOR OTHERS; PHYSICAL STORAGE OF ELECTRONIC MEDIA, NAMELY, STORAGE OF DATA BACK-UP TAPES (U.S. CLS. 100 AND 105).
FIRST USE 0-0-1958; IN COMMERCE 0-0-1958.

CLASS 40—MATERIAL TREATMENT

FOR ASSEMBLY OF PRODUCTS FOR OTHERS; KITTING, NAMELY, ASSEMBLY OF MANUFACTURED PRODUCTS FOR OTHERS (U.S. CLS. 100, 103 AND 106).
FIRST USE 10-16-1995; IN COMMERCE 10-16-1995.
EDWARD FENNESSY, EXAMINING ATTORNEY

SN 78-961,047. GREAT NORTHWEST MOVING COMPANY,
KIRKLAND, WA. FILED 8-25-2006.

AIR VAN ★

OWNER OF U.S. REG. NO. 2,853,729.
NO CLAIM IS MADE TO THE EXCLUSIVE RIGHT TO USE "VAN", APART FROM THE MARK AS SHOWN.
THE MARK CONSISTS OF THE WORDS "AIR VAN" WITH THE CROSS BAR OF THE "A" EXTENDING OVER THE WORDS IN THE STYLE OF AN ARC AND WITH THE DESIGN OF A STAR POSITIONED AT THE END THEREOF.

CLASS 35—ADVERTISING AND BUSINESS

FOR INVENTORY CONTROL; TRANSPORTATION LOGISTICS SERVICES, NAMELY, ARRANGING THE TRANSPORTATION OF GOODS FOR OTHERS; MOVING AND RELOCATION SERVICES, NAMELY PLANNING AND IMPLEMENTING MOVES OF HOMES AND OFFICES (U.S. CLS. 100, 101 AND 102).
FIRST USE 6-10-2005; IN COMMERCE 6-10-2005.

CLASS 39—TRANSPORTATION AND STORAGE

FOR PACKAGING ARTICLES FOR TRANSPORTATION; MOVING VAN SERVICES; FREIGHT FORWARDING; WAREHOUSE STORAGE; FURNITURE MOVING; FURNITURE STORAGE; WAREHOUSING SERVICES, NAMELY, STORAGE, DISTRIBUTION, PICK-UP, AND PACKING FOR SHIPMENT OF DOCUMENTS, BUSINESS RECORDS DOCUMENTS, PACKAGES, RAW MATERIALS, AND OTHER FREIGHT FOR OTHERS; PHYSICAL STORAGE OF ELECTRONIC MEDIA, NAMELY, STORAGE OF DATA BACK-UP TAPES (U.S. CLS. 100 AND 105).
FIRST USE 6-10-2005; IN COMMERCE 6-10-2005.

CLASS 40—MATERIAL TREATMENT

FOR ASSEMBLY OF PRODUCTS FOR OTHERS; KITTING, NAMELY, ASSEMBLY OF MANUFACTURED PRODUCTS FOR OTHERS (U.S. CLS. 100, 103 AND 106).
FIRST USE 6-10-2005; IN COMMERCE 6-10-2005.
EDWARD FENNESSY, EXAMINING ATTORNEY

SN 78-961,095. ANGEL THERAPY, INC., LAGUNA BEACH, CA. FILED 8-25-2006.

SN 78-961,807. MALJANIAN, ROSEMARIE D., FARMINGTON, CT. FILED 8-28-2006.

ANGEL THERAPY

THE MARK CONSISTS OF STANDARD CHARACTERS WITHOUT CLAIM TO ANY PARTICULAR FONT, STYLE, SIZE, OR COLOR.

OWNER OF U.S. REG. NOS. 2,775,008 AND 2,797,030. SEC. 2(F).

CLASS 9—ELECTRICAL AND SCIENTIFIC APPARATUS

FOR SERIES OF PRE-RECORDED AUDIO BOOKS IN THE FIELD OF SPIRITUALITY (U.S. CLS. 21, 23, 26, 36 AND 38).

FIRST USE 12-1-1997; IN COMMERCE 12-1-1997.

CLASS 16—PAPER GOODS AND PRINTED MATTER

FOR PRINTED PUBLICATIONS, NAMELY, SERIES OF BOOKS IN THE FIELD OF SPIRITUALITY AND PSYCHOLOGY (U.S. CLS. 2, 5, 22, 23, 29, 37, 38 AND 50).

FIRST USE 12-1-1997; IN COMMERCE 12-1-1997. EDWARD FENNESSY, EXAMINING ATTORNEY

SN 78-961,365. AP TECH GROUP, INC., CINCINNATI, OH. FILED 8-27-2006.



NO CLAIM IS MADE TO THE EXCLUSIVE RIGHT TO USE "TECHNOLOGIES", APART FROM THE MARK AS SHOWN.

THE MARK CONSISTS OF THE STYLIZED LETTERS SOLID-SAFE TECHNOLOGIES WITH A SEMI-OVAL ENCOMPASSING THE TOP, BOTTOM AND RIGHT SIDE OF THE STYLIZED WORDS.

CLASS 1—CHEMICALS

FOR SOLID WATER TREATMENT CHEMICALS (U.S. CLS. 1, 5, 6, 10, 26 AND 46).

CLASS 9—ELECTRICAL AND SCIENTIFIC APPARATUS

FOR DISPENSER SOLD EMPTY THAT MEASURES OUTPUT FOR USE IN DISPENSING SOLID WATER TREATMENT CHEMICALS (U.S. CLS. 21, 23, 26, 36 AND 38).

ELLEN B. AWRICH, EXAMINING ATTORNEY

HealthCAWS

CLASS 35—ADVERTISING AND BUSINESS

FOR COST MANAGEMENT FOR HEALTH CARE BENEFIT PLANS OF OTHERS, HEALTHCARE COST CONTAINMENT AND MANAGED CARE SERVICES, NAMELY, CONSULTING AND INFORMATION DISSEMINATION SERVICES RELATED TO THE ADMINISTRATIVE COORDINATION OF HEALTH CARE PROVIDERS, HEALTH CARE EDUCATORS, HEALTH CARE PROFESSIONAL ORGANIZATIONS, INSURANCE COMPANIES, CONSUMERS AND PATIENTS. (U.S. CLS. 100, 101 AND 102).

CLASS 44—MEDICAL, BEAUTY AND AGRICULTURAL SERVICES

FOR PROVIDING HEALTH INFORMATION BY TELEPHONE AND THE INTERNET (U.S. CLS. 100 AND 101). MATTHEW PAPPAS, EXAMINING ATTORNEY

SN 78-961,871. J. & P. COATS, LIMITED, GLASGOW G2 5PA, SCOTLAND, FILED 8-28-2006.

FILZ-IT!

THE MARK CONSISTS OF STANDARD CHARACTERS WITHOUT CLAIM TO ANY PARTICULAR FONT, STYLE, SIZE, OR COLOR.

THE FOREIGN WORDING IN THE MARK TRANSLATES INTO ENGLISH AS FELT.

CLASS 3—COSMETICS AND CLEANING PREPARATIONS

FOR SOAP AND LIQUID SOAP FOR CRAFT AND HOUSEHOLD PURPOSES (U.S. CLS. 1, 4, 6, 50, 51 AND 52).

CLASS 9—ELECTRICAL AND SCIENTIFIC APPARATUS

FOR PRE-RECORDED CDS, CD ROMS, AND DVDS FEATURING TEXTILE CRAFTS (U.S. CLS. 21, 23, 26, 36 AND 38).

CLASS 17—RUBBER GOODS

FOR PLASTICS IN EXTRUDED FORM FOR CRAFT USE (U.S. CLS. 1, 5, 12, 13, 35 AND 50).

CLASS 23—YARNS AND THREADS

FOR YARNS (U.S. CL. 43).

CLASS 24—FABRICS

FOR FELT AND NON-WOVEN TEXTILE FABRICS (U.S. CLS. 42 AND 50).

CLASS 26—FANCY GOODS

FOR NEEDLES AND FELTING NEEDLES (U.S. CLS. 37, 39, 40, 42 AND 50).
INGA ERVIN, EXAMINING ATTORNEY

SN 78-961,881. PARK PLACE PA, LLC, GREENVILLE, SC.
FILED 8-28-2006.

CLASS 25—CLOTHING

FOR MEN'S, WOMEN'S AND CHILDREN'S SOCKS AND HOSIERY FOR THE FEET AND LEGS; SLIPPER SOCKS; SLIPPERS; HEAD WEAR, NAMELY, KNITTED HATS, SKI HATS, AND CAPS; EARMUFFS; HEADBANDS; ATHLETIC MASKS IN THE NATURE OF CLOTHING, NAMELY, KNITTED SKI MASKS, HEAD AND FACE MASKS, AND ANTI-COLD MASKS; NECKWEAR, NAMELY, KNITTED SCARVES, NECK WARMERS, AND DICKIES; GLOVES AND MITTENS FOR CLOTHING, NAMELY, KNITTED ANTI-COLD GLOVES, MITTENS AND GLOVE LINERS FOR USE IN OUTDOOR ACTIVITIES; GLOVES AND MITTENS FOR CLOTHING, NAMELY, KNITTED ANTI-HEAT GLOVES, MITTENS, AND GLOVE LINERS FOR USE IN OUTDOOR ACTIVITIES, AND NOT INTENDED FOR USE TO PROTECT INDIVIDUALS FROM GRAVE INJURY SUCH AS FIRE PROTECTION; SWEATERS (U.S. CLS. 22 AND 39).
NAKIA HENRY, EXAMINING ATTORNEY

NANTEX

THE MARK CONSISTS OF STANDARD CHARACTERS WITHOUT CLAIM TO ANY PARTICULAR FONT, STYLE, SIZE, OR COLOR.

CLASS 20—FURNITURE AND ARTICLES NOT OTHERWISE CLASSIFIED

FOR FUTON MATTRESSES; FUTONS; MATTRESS TOPPERS; MATTRESSES; PILLOWS (U.S. CLS. 2, 13, 22, 25, 32 AND 50).

SN 78-964,841. HIRAIWA, TAKANORI, WAKAYAMA, JAPAN, FILED 8-31-2006.

CLASS 25—CLOTHING

FOR SLIPPERS (U.S. CLS. 22 AND 39).
CHARISMA HAMPTON, EXAMINING ATTORNEY

SN 78-961,996. WIGWAM MILLS, INC., SHEBOYGAN, WI.
FILED 8-28-2006.



LIFE IS MOVEMENT

THE MARK CONSISTS OF STANDARD CHARACTERS WITHOUT CLAIM TO ANY PARTICULAR FONT, STYLE, SIZE, OR COLOR.

CLASS 3—COSMETICS AND CLEANING PREPARATIONS

FOR NON-MEDICATED FOOT CARE LOTIONS, GELS, SOAPS, SOAKS AND SPRAYS; SOAPS AND DETERGENT FOR WASHING KNITTED TEXTILE PRODUCTS (U.S. CLS. 1, 4, 6, 50, 51 AND 52).

"THE MARK CONSISTS OF THE REPRESENTATION OF A SCARY FACE."

CLASS 25—CLOTHING

FOR CLOTHING, NAMELY, SWEATERS, SHIRTS, TROUSERS, RAIN COATS, HEADGEAR IN THE NATURE OF HATS, CAPS AND FISHING WADERS (U.S. CLS. 22 AND 39).

CLASS 28—TOYS AND SPORTING GOODS

FOR FISHING TACKLE (U.S. CLS. 22, 23, 38 AND 50).
PRISCILLA MILTON, EXAMINING ATTORNEY

SN 78-965,039. NDI MEDICAL, INC., CLEVELAND, OH.
FILED 8-31-2006.



CLASS 10—MEDICAL APPARATUS

FOR MEDICAL APPARATUS, NAMELY, IMPLANTABLE SYSTEMS AND NON-IMPLANTABLE SYSTEMS, CONSISTING PRIMARILY OF ELECTRONIC STIMULATORS, FOR APPLYING ELECTRICAL STIMULATION TO TISSUE AND FOR SENSING ELECTRICAL ACTIVITY IN TISSUE (U.S. CLS. 26, 39 AND 44).

FIRST USE 8-16-2006; IN COMMERCE 8-16-2006.

CLASS 35—ADVERTISING AND BUSINESS

FOR BUSINESS MANAGEMENT AND CONSULTING SERVICES IN THE FIELD OF DEVELOPMENT, MANUFACTURING, COMMERCIALIZATION, AND MARKETING OF NEUROSTIMULATION PRODUCTS (U.S. CLS. 100, 101 AND 102).

FIRST USE 2-17-2006; IN COMMERCE 2-17-2006.

CLASS 41—EDUCATION AND ENTERTAINMENT

FOR EDUCATIONAL SERVICES, NAMELY, ORGANIZING AND CONDUCTING PHYSICIAN TRAINING, SEMINARS, WORKSHOPS AND CONFERENCES IN THE FIELD OF MEDICINE (U.S. CLS. 100, 101 AND 107).

FIRST USE 2-21-2006; IN COMMERCE 2-21-2006.
YONG KIM, EXAMINING ATTORNEY

SN 78-965,320. HOTEL CALIFORNIA LLC, KIRKLAND, WA.
FILED 8-31-2006.



THE MARK CONSISTS OF THE STYLIZED WORDING "NICE BUDDHI", HAVING THE DESIGN OF A CARICATURE OF A BUDDHA BETWEEN THE WORDS "NICE" AND "BUDDHI" AND HAVING THE DESIGN OF A RECTANGULAR CARRIER WITH A CIRCULAR PROTRUSION AROUND THE CARICATURE.

CLASS 25—CLOTHING

FOR CLOTHING AND APPAREL, NAMELY, T-SHIRTS AND YOGA PANTS (U.S. CLS. 22 AND 39).

CLASS 40—MATERIAL TREATMENT

FOR SILK SCREEN PRINTING AND EMBROIDERY SERVICES; CUSTOM SILK SCREENING AND EMBROIDERY SERVICES; CUSTOMIZED PRINTING OF COMPANY NAMES AND LOGOS FOR PROMOTIONAL AND ADVERTISING PURPOSES ON THE GOODS OF OTHERS (U.S. CLS. 100, 103 AND 106).

JAY BESCH, EXAMINING ATTORNEY

SN 78-965,651. STRAUMANN HOLDING AG, CH-4002
BASEL, SWITZERLAND, FILED 9-1-2006.

THE SURFACE WITH SUCCESS BUILT IN

THE MARK CONSISTS OF STANDARD CHARACTERS WITHOUT CLAIM TO ANY PARTICULAR FONT, STYLE, SIZE, OR COLOR.

CLASS 10—MEDICAL APPARATUS

FOR SURGICAL, MEDICAL AND DENTAL INSTRUMENTS AND APPARATUS NAMELY DENTAL IMPLANTS, ABUTMENTS, AMPOULES CONTAINING IMPLANTS FOR USE IN DENTAL AREA, INSERTION INSTRUMENTS, RATCHETS, SCREWDRIVERS AND TRANSFER PIECES, CONTAINERS FOR SURGICAL, MEDICAL AND DENTAL INSTRUMENTS AND APPARATUS; DENTAL IMPLANTS, PROSTHESES FOR DENTISTRY AND REPLACEMENT PARTS THEREOF; ENDOPROSTHESES FOR HUMAN, DENTAL AND VETERINARY MEDICINE (U.S. CLS. 26, 39 AND 44).

CLASS 40—MATERIAL TREATMENT

FOR PROCESSING OF MATERIALS, NAMELY REALIZATION OF SURFACE TREATMENT OF IMPLANTS, NAMELY, SANDBLASTING AND ACID ETCHING AND SURFACE TREATMENT OF DENTAL IMPLANTS AND PROSTHETIC COMPONENTS, NAMELY, SANDBLASTING AND ACID ETCHING (U.S. CLS. 100, 103 AND 106).

DEBRA LEE, EXAMINING ATTORNEY

SN 78-965,780. JOHN HARDY LIMITED, CENTRAL, HONG
KONG, FILED 9-1-2006.

JOHN HARDY

THE MARK CONSISTS OF STANDARD CHARACTERS WITHOUT CLAIM TO ANY PARTICULAR FONT, STYLE, SIZE, OR COLOR.

OWNER OF U.S. REG. NOS. 770,861, 2,755,493 AND OTHERS.

"THE NAME(S), PORTRAIT(S), AND/OR SIGNATURE(S) SHOWN IN THE MARK IDENTIFIES JOHN HARDY WHOSE CONSENT(S) TO REGISTER IS SUBMITTED."

CLASS 3—COSMETICS AND CLEANING PREPARATIONS

FOR FRAGRANCES FOR PERSONAL USE (U.S. CLS. 1, 4, 6, 50, 51 AND 52).

FIRST USE 0-0-1997; IN COMMERCE 1-0-2006.

CLASS 14—JEWELRY

FOR JEWELRY, NAMELY, EARRINGS, BRACELETS, CUFF LINKS, TUXEDO STUDS, PENDANTS, NECKLACES, FINGER RINGS, ORNAMENTAL PINS, WATCHES, CLOCKS, AND GOODS MADE OF PRECIOUS METAL, NAMELY, MONEY CLIPS, KEY RINGS, CANDLE HOLDERS, CANDLE SNUFFERS, TIMEPIECE DIALS, BELT BUCKLES AND NAPKIN RINGS (U.S. CLS. 2, 27, 28 AND 50).

FIRST USE 0-0-1997; IN COMMERCE 0-0-1997.
LESLEY LAMOTHE, EXAMINING ATTORNEY

SN 78-967,072. CALIFORNIA TREE FRUIT AGREEMENT, REEDLEY, CA. FILED 9-5-2006.

FRESHIPES

THE MARK CONSISTS OF STANDARD CHARACTERS WITHOUT CLAIM TO ANY PARTICULAR FONT, STYLE, SIZE, OR COLOR.

CLASS 16—PAPER GOODS AND PRINTED MATTER

FOR NEWSLETTERS IN THE FIELD OF FRUIT (U.S. CLS. 2, 5, 22, 23, 29, 37, 38 AND 50).

FIRST USE 9-29-2005; IN COMMERCE 11-4-2005.

CLASS 35—ADVERTISING AND BUSINESS

FOR DISSEMINATION OF ADVERTISING MATERIAL (U.S. CLS. 100, 101 AND 102).

LINDA E. BLOHM, EXAMINING ATTORNEY

SN 78-967,296. HELMICK, BRIAN, ANDRES, SAN FRANCISCO, CA. FILED 9-5-2006.

Algentis

THE MARK CONSISTS OF STANDARD CHARACTERS WITHOUT CLAIM TO ANY PARTICULAR FONT, STYLE, SIZE, OR COLOR.

CLASS 35—ADVERTISING AND BUSINESS

FOR PROVIDING PROFESSIONAL EMPLOYER ORGANIZATION SERVICES, NAMELY, EMPLOYEE ADMINISTRATION CONSULTING SERVICES, BUSINESS PROCESS OUTSOURCING, HUMAN RESOURCE CONSULTING SERVICES, HUMAN RESOURCES MANAGEMENT SERVICES, TAX AND PAYROLL PREPARATION SERVICES; PROVIDING PROFESSIONAL EMPLOYER ORGANIZATION SERVICES DIRECTLY AND VIA THE INTERNET, NAMELY, PROVIDING TO CLIENT COMPANIES DETAILED DEDUCTION REPORTS, TIME-SHEETS, AND INVOICES FOR PAYROLL REPORTS, PROVIDING PERSONNEL POLICIES AND PROCEDURES; BUSINESS CONSULTING SERVICES IN THE FIELD OF EMPLOYER LIABILITY AND WORKER'S COMPENSATION (U.S. CLS. 100, 101 AND 102).

CLASS 36—INSURANCE AND FINANCIAL

FOR PROVIDING PROFESSIONAL EMPLOYER ORGANIZATION SERVICES, NAMELY, ADMINISTRATION OF EMPLOYEE BENEFIT PLANS; PROVIDING ADMINISTRATION OF HEALTH, RETIREMENT AND RELATED EMPLOYMENT BENEFITS (U.S. CLS. 100, 101 AND 102).

CLASS 42—SCIENTIFIC AND COMPUTER SERVICES

FOR PROVIDING PROFESSIONAL EMPLOYER ORGANIZATION SERVICES, NAMELY, PROVIDING INFORMATION REGARDING GOVERNMENT REGULATORY AND REPORTING REQUIREMENTS FOR EMPLOYMENT (U.S. CLS. 100 AND 101).

CARYN GLASSER, EXAMINING ATTORNEY

SN 78-967,874. EMERGING VISION, INC., GARDEN CITY, NY. FILED 9-6-2006.



NO CLAIM IS MADE TO THE EXCLUSIVE RIGHT TO USE "VISION", APART FROM THE MARK AS SHOWN.

CLASS 9—ELECTRICAL AND SCIENTIFIC APPARATUS

FOR EYEWEAR, NAMELY, EYEGLASSES, SUNGLASSES AND CASES THEREFOR; OPTICAL LENSES AND FRAMES THEREFOR; CONTACT LENSES AND MAGNIFYING GLASSES (U.S. CLS. 21, 23, 26, 36 AND 38).

CLASS 35—ADVERTISING AND BUSINESS

FOR RETAIL STORE SERVICES FEATURING OPTICAL PRODUCTS FOR THE EYES (U.S. CLS. 100, 101 AND 102).

TARAH HARDY, EXAMINING ATTORNEY

SN 78-967,880. EMERGING VISION, INC., GARDEN CITY, NY. FILED 9-6-2006.



NO CLAIM IS MADE TO THE EXCLUSIVE RIGHT TO USE EYECARE, APART FROM THE MARK AS SHOWN.

CLASS 9—ELECTRICAL AND SCIENTIFIC APPARATUS

FOR EYEWEAR, NAMELY, EYEGLASSES, SUNGLASSES AND CASES THEREFOR; OPTICAL LENSES AND FRAMES THEREFOR; CONTACT LENSES AND MAGNIFYING GLASSES (U.S. CLS. 21, 23, 26, 36 AND 38).

CLASS 35—ADVERTISING AND BUSINESS

FOR RETAIL STORE SERVICES FEATURING OPTICAL PRODUCTS FOR THE EYES (U.S. CLS. 100, 101 AND 102).

TARAH HARDY, EXAMINING ATTORNEY

SN 78-968,388. CHOI, KYONG, VANCOUVER, WA. FILED 9-6-2006.

CESTUS

THE MARK CONSISTS OF STANDARD CHARACTERS WITHOUT CLAIM TO ANY PARTICULAR FONT, STYLE, SIZE, OR COLOR.

CLASS 9—ELECTRICAL AND SCIENTIFIC APPARATUS

FOR PROTECTIVE WORK GLOVES (U.S. CLS. 21, 23, 26, 36 AND 38).

CLASS 25—CLOTHING

FOR SPORTSWEAR, NAMELY, SHIRTS, TOPS, SHORTS, PANTS, SOCKS, AND HATS (U.S. CLS. 22 AND 39).

JORDAN BAKER, EXAMINING ATTORNEY

SN 78-968,683. RCI TM CORP., LAS VEGAS, NV. FILED 9-7-2006.

NO CLAIM IS MADE TO THE EXCLUSIVE RIGHT TO USE "VACATION RENTALS", APART FROM THE MARK AS SHOWN.

THE COLOR(S) RED, BLUE, YELLOW, GREEN IS/ARE CLAIMED AS A FEATURE OF THE MARK.

"THE MARK CONSISTS OF THE WORDS VACATION RENTALS 4 YOU WITH THE WORD VACATION IN RED, THE WORD RENTALS IN BLUE, THE NUMBER 4 IN YELLOW AND THE WORD YOU IN GREEN."

CLASS 36—INSURANCE AND FINANCIAL

FOR RENTAL OF VACATION PROPERTIES (U.S. CLS. 100, 101 AND 102).

CLASS 43—HOTEL AND RESTAURANT SERVICES

FOR MAKING TEMPORARY LODGING RESERVATIONS FOR OTHERS (U.S. CLS. 100 AND 101).

JIM RINGLE, EXAMINING ATTORNEY

SN 78-969,141. EQUIPMENT SYSTEMS AND DEVICES, INC., FORT WASHINGTON, PA. FILED 9-7-2006.

CARDTOON

THE MARK CONSISTS OF STANDARD CHARACTERS WITHOUT CLAIM TO ANY PARTICULAR FONT, STYLE, SIZE, OR COLOR.

CLASS 9—ELECTRICAL AND SCIENTIFIC APPARATUS

FOR VALUE TRANSFER CARDS, NAMELY, BLANK ELECTRONIC CHIP CARDS, BLANK SMART CARDS, MAGNETIC CARDS, AND ELECTRONIC AND MAGNETIC ID CARDS FOR USE IN CONNECTION WITH PAYMENT FOR SERVICES OF OTHERS; ELECTRONIC TERMINALS, NAMELY, ELECTRONIC VALUE TRANSFER TERMINALS COMPRISED OF CARD THROATS, PROGRAMMED DATA PROCESSORS AND DATA COMMUNICATION MODEMS FOR READING AND WRITING TO CREDIT AND DEBIT CARDS TO MANAGE THE TRANSFER OF FUNDS (U.S. CLS. 21, 23, 26, 36 AND 38).

CLASS 35—ADVERTISING AND BUSINESS

FOR PROMOTIONAL SERVICES, NAMELY, PROMOTING THE SALE OF THE GOODS AND SERVICES OF OTHERS THROUGH DISTRIBUTION OF PRINTED MATERIALS AND VALUE TRANSFER CARDS; ADMINISTRATION OF DISCOUNT PROGRAMS FOR ENABLING PARTICIPANTS TO OBTAIN DISCOUNTS ON GOODS AND SERVICES THROUGH THE USE OF A DISCOUNT MEMBERSHIP CARD; ADMINISTRATION OF CUSTOMER LOYALTY AWARD PROGRAMS FOR ENABLING PARTICIPANTS TO OBTAIN DISCOUNTS ON GOODS AND SERVICES THROUGH USE OF A CUSTOMER LOYALTY AWARD CARD (U.S. CLS. 100, 101 AND 102).

ROBERT LAVACHE, EXAMINING ATTORNEY

SN 78-969,322. THE LICE SQUAD INC., GILFORD, ONTARIO, CANADA, FILED 9-7-2006.

THE LICE SQUAD

THE MARK CONSISTS OF STANDARD CHARACTERS WITHOUT CLAIM TO ANY PARTICULAR FONT, STYLE, SIZE, OR COLOR.

CLASS 5—PHARMACEUTICALS

FOR PESTICIDE-FREE HEAD LICE REMOVAL AND PREVENTION PRODUCTS, NAMELY, SHAMPOOS, CONDITIONERS, DISINFECTANTS, HAIR SPRAYS (U.S. CLS. 6, 18, 44, 46, 51 AND 52).

FIRST USE 7-1-2005; IN COMMERCE 7-1-2005.

CLASS 44—MEDICAL, BEAUTY AND AGRICULTURAL SERVICES

FOR HEAD LICE IDENTIFICATION AND REMOVAL SERVICES (U.S. CLS. 100 AND 101).
FIRST USE 7-1-2005; IN COMMERCE 7-1-2005.
BRENDAN REGAN, EXAMINING ATTORNEY

SN 78-969,777. KABUSHIKI KAISHA LUMIELINA, YOKOHAMA-SHI, KANAGAWA, JAPAN, FILED 9-8-2006.

SN 78-969,716. NU FLOW AMERICA, INC., SAN DIEGO, CA.
FILED 9-8-2006.

Nu Flow

THE MARK CONSISTS OF STANDARD CHARACTERS WITHOUT CLAIM TO ANY PARTICULAR FONT, STYLE, SIZE, OR COLOR.

CLASS 1—CHEMICALS

FOR EPOXY GLUE FOR GENERAL BONDING AND REPAIR, EPOXY RESINS, PHENOLIC RESINS, POLYAMIDE RESINS, POLYESTER RESINS, POLYETHYLENE RESINS, POLYPROPYLENE RESINS, POLYSTYRENE RESINS, SYNTHETIC RESINS FOR USE IN A WIDE VARIETY OF INDUSTRIES AND APPLICATIONS (U.S. CLS. 1, 5, 6, 10, 26 AND 46).
FIRST USE 1-1-1999; IN COMMERCE 1-1-1999.

CLASS 2—PAINTS

FOR RUST PRESERVATIVES IN THE NATURE OF A COATING, PAINTS, COATING COMPOSITIONS IN THE NATURE OF PAINT FOR USE IN A WIDE VARIETY OF INDUSTRIES AND APPLICATIONS, CORROSION INHIBITING PAINT TYPE COATINGS FOR COMMERCIAL MARINE USE, SYNTHETIC RESIN PAINTS (U.S. CLS. 6, 11 AND 16).
FIRST USE 1-1-1999; IN COMMERCE 1-1-1999.

CLASS 11—ENVIRONMENTAL CONTROL APPARATUS

FOR REGULATING ACCESSORIES FOR WATER SUPPLY, NAMELY METERED VALVES; VENTILATING FANS (U.S. CLS. 13, 21, 23, 31 AND 34).
FIRST USE 1-1-1999; IN COMMERCE 1-1-1999.

CLASS 37—CONSTRUCTION AND REPAIR

FOR BUILDING CONSTRUCTION AND REPAIR, BUILDING MAINTENANCE AND REPAIR, HOUSE BUILDING AND REPAIR, INSTALLATION, REPAIR AND MAINTENANCE OF CONDENSING APPARATUS, STEAM CONDENSERS, RADIATORS AND MOTORS, PIPELINE INSTALLATION AND REPAIR (U.S. CLS. 100, 103 AND 106).
FIRST USE 1-1-1999; IN COMMERCE 1-1-1999.
DAVID H. STINE, EXAMINING ATTORNEY

LEPROUST

THE MARK CONSISTS OF STANDARD CHARACTERS WITHOUT CLAIM TO ANY PARTICULAR FONT, STYLE, SIZE, OR COLOR.

CLASS 3—COSMETICS AND CLEANING PREPARATIONS

FOR SOAPS, NAMELY, SOAPS FOR BATHS, SOAPS FOR BEAUTY CARE, LIQUID SOAPS, TOILET SOAPS; HAIR SHAMPOOS; HAIR RINSES; FRAGRANCES, NAMELY, EAU DE COLOGNES, PERFUMES, LAVENDER OILS, AND CLOVE OILS; COSMETICS, NAMELY, HAIR GELS, MASSAGE GELS, MILK LOTION FOR THE SKIN, SKIN LOTIONS, HAIR LOTIONS, BODY LOTIONS, SHAVING LOTIONS, VANISHING CREAMS, CLEANSING CREAMS, HAIR CREAMS, NON-MEDICATED SCURF CREAMS, TOILET OILS, MASSAGE OILS, BATH OILS, SUN TAN OILS, BABY OILS, MASK PACKS FOR THE FACE, SKIN, BODY AND HAIR, LIP CONDITIONERS, HAIR CONDITIONERS, SKIN FRESHENERS, SUN TAN MILKS, SUNTAN CREAMS, SUNTAN LOTIONS, SUN SCREEN LOTIONS, SUN SCREEN CREAMS, HAND CREAMS, TALCUM POWDERS, BATH POWDERS, BABY POWDERS, HAIR SPRAYS, HAIR TONICS, HAIR MOUSSES; BATH EXTRACTS AND BATH ESSENCES, NAMELY, NON-MEDICATED BATH AGENTS THAT ENHANCE RELAXATION AND PROMOTE SKIN AND BODY CARE; BATH SALTS (U.S. CLS. 1, 4, 6, 50, 51 AND 52).

CLASS 41—EDUCATION AND ENTERTAINMENT

FOR TEACHING OF BEAUTY CULTURE AND HAIRDRESSING; TEACHING IN THE FIELD OF HEALTHCARE AND FITNESS; PROVIDING SEMINARS RELATING TO BEAUTY CULTURE AND HAIRDRESSING; ARRANGING OF CONTESTS RELATING TO BEAUTY CULTURE AND HAIRDRESSING (U.S. CLS. 100, 101 AND 107).

CLASS 44—MEDICAL, BEAUTY AND AGRICULTURAL SERVICES

FOR BEAUTY CULTURE, NAMELY, HAIRDRESSING; BEAUTY TREATMENTS; BEAUTY SALON SERVICES AND AESTHETIC SALON SERVICES; CONSULTATION SERVICES RELATING TO BEAUTY CULTURE AND HAIRDRESSING; PROVIDING INFORMATION ON BEAUTY CULTURE AND HAIRDRESSING; PROVIDING PUBLIC BATHING FACILITIES; MASSAGE AND ACUPRESSURE, PHYSICAL THERAPY IN THE NATURE OF MOXA CAUTERY, TREATMENT TO JOINT DISLOCATION, SPRAIN, BONE-FRACTURE OR LIKE (JUDO-SEIHUKU), ACUPUNCTURE; NUTRITION CONSULTATION; RENTAL OR LEASING OF MACHINES AND INSTRUMENTS FOR BEAUTY SHOPS OR BARBER SHOPS (U.S. CLS. 100 AND 101).
JEAN IM, EXAMINING ATTORNEY

SN 78-969,813. GREATER PHILADELPHIA VENTURE GROUP, PHILADELPHIA, PA. FILED 9-8-2006.

SN 78-970,603. BAG O' BURGERS RESTAURANT GROUP, LLC, LOS ANGELES, CA. FILED 9-8-2006.

MAC
ALLIANCE

THE CATALYST FOR COMPANIES AND CAPITAL

NO CLAIM IS MADE TO THE EXCLUSIVE RIGHT TO USE "ALLIANCE", APART FROM THE MARK AS SHOWN.

CLASS 35—ADVERTISING AND BUSINESS

FOR ASSOCIATION SERVICES, NAMELY, PROMOTING THE INTERESTS OF BUSINESS OWNERS AND VENTURE CAPITALISTS (U.S. CLS. 100, 101 AND 102).

CLASS 41—EDUCATION AND ENTERTAINMENT

FOR EDUCATIONAL SERVICES, NAMELY, PROVIDING SEMINARS, CONFERENCES AND CLASSES IN THE FIELDS OF BUSINESS AND CAPITAL DEVELOPMENT; AND ENTERTAINMENT SERVICES, NAMELY, CONDUCTING SOCIAL RECEPTIONS AND SOCIAL NETWORKING MEETINGS (U.S. CLS. 100, 101 AND 107).
RAY THOMAS, EXAMINING ATTORNEY

SN 78-969,927. GREATER PHILADELPHIA VENTURE GROUP, PHILADELPHIA, PA. FILED 9-8-2006.

MAC
MID-ATLANTIC CAPITAL ALLIANCE

THE CATALYST FOR COMPANIES AND CAPITAL

NO CLAIM IS MADE TO THE EXCLUSIVE RIGHT TO USE "MID-ATLANTIC CAPITAL ALLIANCE", APART FROM THE MARK AS SHOWN.

CLASS 35—ADVERTISING AND BUSINESS

FOR ASSOCIATION SERVICES, NAMELY, PROMOTING THE INTERESTS OF BUSINESS OWNERS AND VENTURE CAPITALISTS (U.S. CLS. 100, 101 AND 102).

CLASS 41—EDUCATION AND ENTERTAINMENT

FOR EDUCATIONAL SERVICES, NAMELY, PROVIDING SEMINARS, CONFERENCES AND CLASSES IN THE FIELDS OF BUSINESS AND CAPITAL DEVELOPMENT; AND ENTERTAINMENT SERVICES, NAMELY, CONDUCTING SOCIAL RECEPTIONS AND SOCIAL NETWORKING MEETINGS (U.S. CLS. 100, 101 AND 107).
RAY THOMAS, EXAMINING ATTORNEY



NO CLAIM IS MADE TO THE EXCLUSIVE RIGHT TO USE "BAG O' BURGERS", APART FROM THE MARK AS SHOWN.

THE COLOR(S) RED AND WHITE IS/ARE CLAIMED AS A FEATURE OF THE MARK.

THE MARK CONSISTS OF A RED CIRCLE WITH THE LITERAL ELEMENT "BAG O' BURGERS" IN WHITE LETTERS.

CLASS 30—STAPLE FOODS

FOR HAMBURGER SANDWICHES (U.S. CL. 46).

CLASS 43—HOTEL AND RESTAURANT SERVICES

FOR FAST FOOD AND NON-STOP RESTAURANT SERVICES; FAST-FOOD RESTAURANTS (U.S. CLS. 100 AND 101).

DEZMONA MIZELLE, EXAMINING ATTORNEY

SN 78-970,897. DBI L.L.C., ST. LOUIS, MO. FILED 9-10-2006.

Footcare Pharmacy

THE MARK CONSISTS OF STANDARD CHARACTERS WITHOUT CLAIM TO ANY PARTICULAR FONT, STYLE, SIZE, OR COLOR.

NO CLAIM IS MADE TO THE EXCLUSIVE RIGHT TO USE "FOOTCARE", APART FROM THE MARK AS SHOWN.

CLASS 5—PHARMACEUTICALS

FOR ATHLETES' FOOT POWDERS (U.S. CLS. 6, 18, 44, 46, 51 AND 52).

CLASS 25—CLOTHING

FOR HEEL INSERTS (U.S. CLS. 22 AND 39).
DAVID C. REIHNER, EXAMINING ATTORNEY

SN 78-971,256. ROBBINS RESEARCH INTERNATIONAL, INC., SAN DIEGO, CA. FILED 9-11-2006.

ANTHONY ROBBINS COMPANIES

THE MARK CONSISTS OF STANDARD CHARACTERS WITHOUT CLAIM TO ANY PARTICULAR FONT, STYLE, SIZE, OR COLOR.

THE NAME(S), PORTRAIT(S), AND/OR SIGNATURE(S) SHOWN IN THE MARK IDENTIFIES ANTHONY ROBBINS, WHOSE CONSENT(S) TO REGISTER IS SUBMITTED.

CLASS 9—ELECTRICAL AND SCIENTIFIC APPARATUS

FOR AUDIO AND VIDEO RECORDINGS IN THE FIELD OF PERSONAL IMPROVEMENT (U.S. CLS. 21, 23, 26, 36 AND 38).

CLASS 16—PAPER GOODS AND PRINTED MATTER

FOR PRINTED MATERIALS, NAMELY, WORKBOOKS AND FLASHCARDS FOR USE IN A HOME STUDY COURSE IN THE FIELD OF PERSONAL IMPROVEMENT (U.S. CLS. 2, 5, 22, 23, 29, 37, 38 AND 50).

CLASS 25—CLOTHING

FOR CLOTHING, NAMELY, SHIRTS, TOPS, BOTTOMS, HATS AND VISORS (U.S. CLS. 22 AND 39).

CLASS 35—ADVERTISING AND BUSINESS

FOR ADVERTISING AND BUSINESS MANAGEMENT (U.S. CLS. 100, 101 AND 102).

CLASS 41—EDUCATION AND ENTERTAINMENT

FOR EDUCATIONAL SERVICES, NAMELY, CONDUCTING CLASSES AND SEMINARS IN THE FIELD OF PERSONAL AND FINANCIAL IMPROVEMENT AND SALES TRAINING (U.S. CLS. 100, 101 AND 107).

LA TONIA FISHER, EXAMINING ATTORNEY



SN 78-972,600. HÖRMANN KG ANTRIEBSTECHNIK, STEINHAGEN, FED REP GERMANY, FILED 9-12-2006.

AKROMATIC

THE MARK CONSISTS OF STANDARD CHARACTERS WITHOUT CLAIM TO ANY PARTICULAR FONT, STYLE, SIZE, OR COLOR.

PRIORITY CLAIMED UNDER SEC. 44(D) ON FED REP GERMANY APPLICATION NO. 30626819107, FILED 3-27-2006, REG. NO. 30626819107, DATED 3-27-2006, EXPIRES 3-31-2016.

CLASS 6—METAL GOODS

FOR METAL DOORS; METAL DOOR STRUCTURAL AND REPLACEMENT PARTS, NAMELY, METAL DOOR ROLLERS; METAL DOOR GUIDE RAILS, METAL DOOR GUIDE RAILS INCORPORATING SECURITY LOCKS, METAL DOOR DRIVE CHAINS, DOOR DRIVE BELT TENSIONERS, METAL DOOR CABLES AND METAL DOOR PULLEYS (U.S. CLS. 2, 12, 13, 14, 23, 25 AND 50).

CLASS 7—MACHINERY

FOR DOOR MOTORS; DOOR DRIVES (U.S. CLS. 13, 19, 21, 23, 31, 34 AND 35).

CLASS 9—ELECTRICAL AND SCIENTIFIC APPARATUS

FOR DOOR OPERATORS, NAMELY, ELECTRIC DOOR OPERATORS; DOOR CONTROLS, NAMELY REMOTE CONTROLS FOR DOORS; ELECTRICAL DOOR CONTROLLERS; DOOR TOUCH KEY PADS, DOOR SWITCHES, NAMELY, ELECTRONIC DOOR MOTOR SWITCHES FOR SWITCHING ON DOOR MOTORS; DOOR LIGHT BEAM SAFETY DEVICES, NAMELY, LASER DETECTORS FOR SENSING IF THERE IS AN OBJECT IN THE WAY OF THE CLOSING DOOR; DOOR REMOTE CONTROLLER DIGITAL TRANSMITTERS, AND DOOR RADIO RECEIVERS (U.S. CLS. 21, 23, 26, 36 AND 38).

BONNIE LUKEN, EXAMINING ATTORNEY



SN 78-973,360. FEDERAL RESERVE BANKS COMPOSED OF FEDERAL RESERVE BANK OF ATLANTA, FEDERAL RESERVE BANK OF NEW YORK, FEDERAL RESERVE BANK OF BOSTON, FEDERAL RESERVE BANK OF CHICAGO, FEDERAL RESERVE BANK OF CLEVELAND, FEDERAL RESERVE BANK OF DALLAS, FEDERAL RESERVE BANK OF KANSAS CITY, FEDERAL RESERVE BANK OF MINNEAPOLIS, FEDERAL RESERVE BANK OF PHILADELPHIA, FEDERAL RESERVE BANK OF RICHMOND, FEDERAL RESERVE BANK OF ST. LOUIS, FEDERAL RESERVE BANK OF SAN FRANCISCO, CHICAGO, IL. FILED 9-13-2006.

FEDLINK

THE MARK CONSISTS OF STANDARD CHARACTERS WITHOUT CLAIM TO ANY PARTICULAR FONT, STYLE, SIZE, OR COLOR.

OWNER OF U.S. REG. NO. 1,459,563.

CLASS 36—INSURANCE AND FINANCIAL

FOR BANKING SERVICES (U.S. CLS. 100, 101 AND 102).

CLASS 38—COMMUNICATION

FOR ELECTRONIC TRANSMISSION OF DATA AND DOCUMENTS FOR BANKS VIA COMPUTER TERMINALS (U.S. CLS. 100, 101 AND 104).

TOBY BULLOFF, EXAMINING ATTORNEY

SN 78-973,487. POTI, INC., SAN FRANCISCO, CA. FILED 9-13-2006.

RIP THE WEB

THE MARK CONSISTS OF STANDARD CHARACTERS WITHOUT CLAIM TO ANY PARTICULAR FONT, STYLE, SIZE, OR COLOR.

CLASS 9—ELECTRICAL AND SCIENTIFIC APPARATUS

FOR COMPUTER SOFTWARE FOR USE IN THE DELIVERY, DISTRIBUTION AND TRANSMISSION OF DIGITAL MEDIA AND CONTENT; COMPUTER SOFTWARE THAT ENABLES USERS TO ACCESS, ACQUIRE, PLAY AND PROGRAM DIGITAL MEDIA AND CONTENT (U.S. CLS. 21, 23, 26, 36 AND 38).

CLASS 42—SCIENTIFIC AND COMPUTER SERVICES

FOR APPLICATION SERVICE PROVIDER FEATURING SOFTWARE THAT ENABLES USERS TO PLAY AND PROGRAM THE DELIVERY, DISTRIBUTION AND TRANSMISSION OF DIGITAL MEDIA AND CONTENT; APPLICATION SERVICE PROVIDER FEATURING SOFTWARE FOR USE IN CONNECTION WITH AN ONLINE MEDIA AND CONTENT SUBSCRIPTION SERVICE, PROVIDING SEARCH ENGINES FOR OBTAINING DATA ON A GLOBAL COMPUTER NETWORK; SERVICES FOR DEVELOPING SOFTWARE THAT DELIVERS AND TRANSMITS DIGITAL MEDIA AND CONTENT (U.S. CLS. 100 AND 101).

LINDA E. BLOHM, EXAMINING ATTORNEY

SN 78-973,491. POTI, INC., SAN FRANCISCO, CA. FILED 9-13-2006.

PLAY THE WEB

THE MARK CONSISTS OF STANDARD CHARACTERS WITHOUT CLAIM TO ANY PARTICULAR FONT, STYLE, SIZE, OR COLOR.

CLASS 9—ELECTRICAL AND SCIENTIFIC APPARATUS

FOR COMPUTER SOFTWARE FOR USE IN THE DELIVERY, DISTRIBUTION AND TRANSMISSION OF DIGITAL MEDIA AND CONTENT; COMPUTER SOFTWARE THAT ENABLES USERS TO ACCESS, ACQUIRE, PLAY AND PROGRAM DIGITAL MEDIA AND CONTENT (U.S. CLS. 21, 23, 26, 36 AND 38).

CLASS 42—SCIENTIFIC AND COMPUTER SERVICES

FOR APPLICATION SERVICE PROVIDER FEATURING SOFTWARE THAT ENABLES USERS TO PLAY AND PROGRAM THE DELIVERY, DISTRIBUTION AND TRANSMISSION OF DIGITAL MEDIA AND CONTENT; APPLICATION SERVICE PROVIDER FEATURING SOFTWARE FOR USE IN CONNECTION WITH AN ONLINE MEDIA AND CONTENT SUBSCRIPTION SERVICE, PROVIDING SEARCH ENGINES FOR OBTAINING DATA ON A GLOBAL COMPUTER NETWORK; SERVICES FOR DEVELOPING SOFTWARE THAT DELIVERS AND TRANSMITS DIGITAL MEDIA AND CONTENT (U.S. CLS. 100 AND 101).

LINDA E. BLOHM, EXAMINING ATTORNEY

SN 78-973,541. DESERET LABORATORIES, INC., ST. GEORGE, UT. FILED 9-13-2006.

NATURE'S WISDOM

THE MARK CONSISTS OF STANDARD CHARACTERS WITHOUT CLAIM TO ANY PARTICULAR FONT, STYLE, SIZE, OR COLOR.

OWNER OF U.S. REG. NO. 2,033,717.

CLASS 3—COSMETICS AND CLEANING PREPARATIONS

FOR ORAL CARE PRODUCTS, NAMELY, DENTAL BLEACHING GEL AND TABLETS, MOUTHWASHES (U.S. CLS. 1, 4, 6, 50, 51 AND 52).

CLASS 5—PHARMACEUTICALS

FOR ANALGESICS IN THE FORM OF LIQUIDS, POWDERS, TABLETS, EFFERVESCENT TABLETS, AND CAPSULES; COUGH AND COLD PREPARATIONS IN THE FORM OF LIQUIDS, POWDERS, TABLETS, AND CAPSULES; ANTACID IN THE FORM OF LIQUIDS, POWDERS, EFFERVESCENT POWDERS, TABLETS, AND CAPSULES; LAXATIVES IN THE FORM OF LIQUIDS, POWDERS, TABLETS, AND CAPSULES; GASTRO-INTESTINAL TREATMENT PREPARATIONS IN THE FORM OF LIQUIDS, POWDERS, TABLETS, AND CAPSULES; DECONGESTANT NASAL SPRAYS; FIRST AID PRODUCTS, NAMELY, HYDROGEN PEROXIDE FOR MEDICAL USE, ALCOHOL FOR TOPICAL USE; PHARMACEUTICAL PREPARATIONS AND SUBSTANCES FOR THE TREATMENT OF GASTRO-INTESTINAL DISEASES (U.S. CLS. 6, 18, 44, 46, 51 AND 52).

TOBY BULLOFF, EXAMINING ATTORNEY

SN 78-974,646. KONAMI DIGITAL ENTERTAINMENT CO., LTD., TOKYO, JAPAN, FILED 9-14-2006.

Elebits

THE MARK CONSISTS OF STANDARD CHARACTERS WITHOUT CLAIM TO ANY PARTICULAR FONT, STYLE, SIZE, OR COLOR.

CLASS 9—ELECTRICAL AND SCIENTIFIC APPARATUS

FOR VIDEO GAME SOFTWARE; VIDEO GAME PROGRAMS; COMPUTER GAME PROGRAMS; ELECTRONIC GAME PROGRAMS; DOWNLOADABLE COMPUTER GAME PROGRAMS FOR MOBILE TELEPHONES; CARTRIDGES AND CASSETTES FOR USE WITH HAND-HELD VIDEO GAME MACHINE; CIRCUIT BOARDS CONTAINING GAME PROGRAMS FOR USE WITH HAND-HELD VIDEO GAME MACHINE; VIDEO OUTPUT GAME MACHINES FOR USE WITH TELEVISIONS; DOWNLOADABLE ELECTRONIC GAME SOFTWARE; DOWNLOADABLE COMPUTER GAME SOFTWARE AND DOWNLOADABLE VIDEO GAME SOFTWARE; PLAYER-OPERATED ELECTRONIC CONTROLLERS FOR ELECTRONIC VIDEO GAME MACHINES; DOWNLOADABLE COMPUTER GAME PROGRAMS FOR MOBILE TELEPHONES; DOWNLOADABLE SCREEN IMAGE SOFTWARE, SCREEN SAVER SOFTWARE, MUSIC AND MOTION PICTURES ACCESSED VIA MOBILE TELEPHONES (U.S. CLS. 21, 23, 26, 36 AND 38).

CLASS 41—EDUCATION AND ENTERTAINMENT

FOR ENTERTAINMENT SERVICES, NAMELY PROVIDING ON-LINE COMPUTER GAMES; GAME SERVICES, NAMELY, PROVIDING ON-LINE NON-DOWNLOADABLE COMPUTER GAME PROGRAMS FOR MOBILE TELEPHONES; PROVIDING AN ON-LINE COMPUTER DATABASE IN THE FIELD OF COMPUTER GAMES; PROVIDING INFORMATION TO GAME PLAYERS ABOUT THE RANKING OF THEIR SCORES OF GAMES THROUGH THE WEB SITES; PROVIDING INFORMATION ABOUT COMPUTER GAMES THROUGH THE WEB SITES; ELECTRONIC GAMES SERVICES, NAMELY, PROVIDING ON-LINE COMPUTER GAMES BY MEANS OF THE INTERNET; GAME SERVICES PROVIDED BY MEANS OF COMMUNICATIONS BY COMPUTER TERMINALS OR MOBILE TELEPHONES, NAMELY, PROVIDING ON-LINE COMPUTER GAMES; PROVIDING PRE-RECORDED MUSIC, MOTION PICTURES AND MOVIE FILM CLIPS VIA THE INTERNET OR MOBILE TELEPHONES; PROVIDING INFORMATION ABOUT GAMES, MUSIC AND MOVIES VIA THE INTERNET OR MOBILE TELEPHONES (U.S. CLS. 100, 101 AND 107).

CARRIE GENOVESE, EXAMINING ATTORNEY

SN 78-974,712. LF, LLC, WILMINGTON, DE. FILED 9-14-2006.

**creative
Ideas**
for home and garden

OWNER OF U.S. REG. NO. 2,662,830.
NO CLAIM IS MADE TO THE EXCLUSIVE RIGHT TO USE "HOME AND GARDEN", APART FROM THE MARK AS SHOWN.

CLASS 9—ELECTRICAL AND SCIENTIFIC APPARATUS

FOR DOWNLOADABLE FILMS AND TELEVISION PROGRAMS PROVIDED VIA A VIDEO-ON-DEMAND SERVICE AND PRERECORDED VIDEOTAPES, ALL FEATURING IDEAS FOR HOME IMPROVEMENT, HOME AND GARDEN, AND WOODWORKING PROJECTS (U.S. CLS. 21, 23, 26, 36 AND 38).

CLASS 16—PAPER GOODS AND PRINTED MATTER

FOR PRINTED MATERIALS, NAMELY, BROCHURES, PAMPHLETS, NEWSLETTERS, MAGAZINES, BOOKS, AND POSTERS FEATURING IDEAS FOR HOME IMPROVEMENT, HOME AND GARDEN, AND WOODWORKING PROJECTS (U.S. CLS. 2, 5, 22, 23, 29, 37, 38 AND 50).

CLASS 35—ADVERTISING AND BUSINESS

FOR PROVIDING CONSUMER ADVICE AND INFORMATION VIA A COMPUTER WEB SITE REGARDING CUSTOMER SERVICES, PRODUCT MANAGEMENT, AND PRICES IN CONNECTION WITH PURCHASES MADE OVER THE INTERNET RELATING TO HOME IMPROVEMENT, HOME AND GARDEN, AND WOODWORKING PROJECTS; PREPARATION OF ADVERTISING FOR OTHERS FOR DISSEMINATION VIA A COMPUTER WEB SITE, COMPACT DISC, OR DVD FOR OPTIONAL UPLOAD OR DOWNLOAD TO A COMPUTER (U.S. CLS. 100, 101 AND 102).

CLASS 38—COMMUNICATION

FOR PROVIDING ACCESS TO FILMS AND TELEVISION PROGRAMS VIA A VIDEO-ON-DEMAND SERVICE FEATURING IDEAS FOR HOME IMPROVEMENT, HOME AND GARDEN, AND WOODWORKING PROJECTS; TELEVISION AND RADIO BROADCASTING SERVICES; AND TELEVISION AND RADIO BROADCASTING INFORMATION AND CONSULTATION (U.S. CLS. 100, 101 AND 104).

CLASS 41—EDUCATION AND ENTERTAINMENT

FOR EDUCATIONAL SERVICES, NAMELY, OFFERING WORKSHOPS AND HOW-TO CLINICS FEATURING IDEAS FOR HOME IMPROVEMENT, HOME AND GARDEN, AND WOODWORKING PROJECTS; PROVIDING NON-DOWNLOADABLE FILMS AND TELEVISION PROGRAMS VIA A VIDEO-ON-DEMAND SERVICE; PRODUCTION OF TELEVISION AND RADIO PROGRAMS RELATING TO HOME IMPROVEMENT, HOME AND GARDEN, AND WOODWORKING PROJECTS; AND ELECTRONIC PUBLISHING SERVICES, NAMELY, PUBLICATION OF TEXT AND GRAPHICS WORKS OF OTHERS ON A COMPUTER WEB SITE, COMPACT DISC, OR DVD FEATURING IDEAS FOR HOME IMPROVEMENT, HOME AND GARDEN, AND WOODWORKING PROJECTS (U.S. CLS. 100, 101 AND 107).

DAYNA BROWNE, EXAMINING ATTORNEY

SN 78-977,485. PENNWELL CORPORATION, TULSA, OK. FILED 1-19-2005.

OIL & GAS JOURNAL
online research center

OWNER OF U.S. REG. NOS. 508,769, 2,197,086 AND 2,795,202.

NO CLAIM IS MADE TO THE EXCLUSIVE RIGHT TO USE "ONLINE RESEARCH CENTER", APART FROM THE MARK AS SHOWN.

SEC. 2(F) AS TO "OIL & GAS JOURNAL".

CLASS 35—ADVERTISING AND BUSINESS

FOR PROVIDING BUSINESS INFORMATION VIA THE INTERNET RELATING TO THE OIL, PETROLEUM, NATURAL GAS AND ENERGY FIELDS (U.S. CLS. 100, 101 AND 102).

FIRST USE 10-0-2001; IN COMMERCE 10-0-2001.

CLASS 36—INSURANCE AND FINANCIAL

FOR PROVIDING FINANCIAL INFORMATION VIA THE INTERNET RELATING TO THE OIL, PETROLEUM, NATURAL GAS AND ENERGY FIELDS (U.S. CLS. 100, 101 AND 102).

FIRST USE 10-0-2001; IN COMMERCE 10-0-2001.

CLASS 42—SCIENTIFIC AND COMPUTER SERVICES

FOR PROVIDING INFORMATION VIA THE INTERNET RELATING TO GEOLOGICAL RESEARCH, GEO-PHYSICAL EXPLORATION, ANALYSIS AND TESTING FOR OIL AND GAS WORKINGS AND OIL AND GAS FIELDS, OIL AND GAS FIELD SURVEYING, AND OIL AND GAS PROSPECTING SERVICES (U.S. CLS. 100 AND 101).

FIRST USE 10-0-2001; IN COMMERCE 10-0-2001.
SHANNON TWOHIG, EXAMINING ATTORNEY

CLASS 36—INSURANCE AND FINANCIAL

FOR FINANCIAL SERVICES RELATED TO PAYMENT CARDS AND CREDIT CARDS, NAMELY, CREDIT CARD AND DEBIT CARD SERVICES; BANKING SERVICES; CHARGE CARD AND STORED VALUE PREPAID CARD SERVICES; STORED VALUE ELECTRONIC PURSE SERVICES, PROVIDING ELECTRONIC FUNDS AND CURRENCY TRANSFER SERVICES, ELECTRONIC PAYMENTS SERVICES, PREPAID TELEPHONE CALLING CARD SERVICES, CASH DISBURSEMENT SERVICES, AND TRANSACTION AUTHORIZATION AND SETTLEMENT SERVICES; PAYMENT SERVICES UTILIZING A RADIO FREQUENCY DEVICE TO ALLOW PAYMENT TO BE CHARGED TO A PREVIOUSLY SPECIFIED PAYMENT MECHANISM, SUCH AS A DEBIT CARD OR CREDIT CARD; CHEQUE VERIFICATION SERVICES; ADVISORY SERVICES RELATING TO ALL THE AFORESAID SERVICES (U.S. CLS. 100, 101 AND 102).

JOHN KELLY, EXAMINING ATTORNEY

SN 78-978,796. MASTERCARD INTERNATIONAL INCORPORATED, PURCHASE, NY. FILED 6-27-2002.



OWNER OF U.S. REG. NOS. 1,738,276, 1,814,279 AND 2,212,783.

COLOR IS NOT CLAIMED AS A FEATURE OF THE MARK.

THE MARK CONSISTS OF A RECTANGULAR CARD SHAPE FEATURING A ROUNDED LOWER RIGHT CORNER. THE DESIGNATION MC2 APPEARS IN THE BOTTOM RIGHT HAND CORNER OF THE CARD SHAPE.

CLASS 9—ELECTRICAL AND SCIENTIFIC APPARATUS

FOR COMPUTER HARDWARE, COMPUTER SOFTWARE, AND COMPUTER PROGRAMS RELATED TO FINANCIAL SERVICES, NAMELY, SOFTWARE FOR SECURE DATA STORAGE AND RETRIEVAL AND TRANSMISSION OF CONFIDENTIAL CUSTOMER INFORMATION USED BY INDIVIDUALS, BANKING AND FINANCIAL INSTITUTIONS AND FOR THE PROCESSING OF FINANCIAL TRANSACTIONS VIA CREDIT, DEBIT, AND SMART CARDS; COMPUTER HARDWARE AND ENCRYPTION SOFTWARE, SOFTWARE FOR SECURE DATA STORAGE AND RETRIEVAL AND TRANSMISSION OF CONFIDENTIAL CUSTOMER INFORMATION USED BY INDIVIDUALS, BANKING AND FINANCIAL INSTITUTIONS; MAGNETIC ENCODED AND SMART CARD READERS; COMPUTERS DESIGNED TO ENABLE SMART CARDS TO INTERACT WITH TERMINALS AND READERS; POINT OF SALE TRANSACTION TERMINALS AND COMPUTER SOFTWARE FOR TRANSMITTING, DISPLAYING AND STORING TRANSACTION, IDENTIFICATION AND FINANCIAL INFORMATION FOR USE IN THE FINANCIAL SERVICES, BANKING AND TELECOMMUNICATIONS INDUSTRIES; RADIO FREQUENCY IDENTIFICATION DEVICES, NAMELY, TRANSPONDERS; AND ELECTRONIC VERIFICATION APPARATUS FOR VERIFYING AUTHENTICATION OF CHARGE CARDS, BANK CARDS, CREDIT CARDS, DEBIT CARDS AND PAYMENT CARDS (U.S. CLS. 21, 23, 26, 36 AND 38).

SN 79-006,103. PIEZOSYSTEM JENA GMBH, FED REP GERMANY, FILED 2-11-2004.

NanoX

THE MARK CONSISTS OF STANDARD CHARACTERS WITHOUT CLAIM TO ANY PARTICULAR FONT, STYLE, SIZE, OR COLOR.

PRIORITY DATE OF 8-12-2003 IS CLAIMED.
OWNER OF INTERNATIONAL REGISTRATION 0835312 DATED 2-11-2004, EXPIRES 2-11-2014.

CLASS 7—MACHINERY

FOR DRIVE SYSTEMS COMPRISING MOTORIZED DRIVES THAT ALLOW FOR PRECISE CONTROL OF THE MOVEMENT OF A LINEAR ACTUATOR USING PIEZOELECTRIC PROPERTIES; MECHANICAL GUIDING SYSTEMS COMPRISING LINEAR MOTORS FOR SINGLE-AXIS AND MULTI-AXIS POSITIONING SYSTEMS (U.S. CLS. 13, 19, 21, 23, 31, 34 AND 35).

CLASS 9—ELECTRICAL AND SCIENTIFIC APPARATUS

FOR SCIENTIFIC ELECTRONIC APPARATUS AND INSTRUMENTS, NAMELY, PRECISION MICRO POSITIONING SYSTEMS, THAT ARE, MOTORIZED DRIVE SYSTEMS, NAMELY, POWER SUPPLY UNITS, CONTROL UNITS, POSITION CONTROLS, SPEED CONTROLS, FORCE CONTROLS, AND ANALOG AND DIGITAL INTERFACE MODULES, THAT PRECISELY CONTROL THE LOCATION AND MOVEMENT OF STAGES, NAMELY, WAFER HOLDERS AND TRANSPORTERS, USING PIEZOELECTRIC PROPERTIES; SINGLE-AXIS AND MULTI-AXIS ACTUATING AND POSITIONING SYSTEMS WITH PIEZO-DRIVE SYSTEMS, COMPRISING LINEAR MOTORS FOR MICROSCOPES, STAGES, NAMELY, WAFER HOLDERS AND TRANSPORTERS FOR WAFER HANDLING THAT MAY BE CONTROLLABLY MOTORIZED USING PIEZOELECTRIC PROPERTIES, AND LINEAR STAGES, NAMELY, CAMERA PART HOLDERS AND TRANSPORTERS FOR PRECISION MOVEMENT OF CAMERA PARTS; PIEZO-TILTING PLATFORMS FOR OPTICAL ELEMENTS AND ACTIVE OPTICS, NAMELY, MOTORIZED PLATFORMS USING PIEZOELECTRIC PROPERTIES FOR HOLDING, TRANSPORTING, AND TILTING OPTICAL ELEMENTS AND ACTIVE OPTICS; ELECTRONIC DATA PROCESSING SYSTEMS, COMPRISING A MECHANICAL GUIDING SYSTEM FOR MORE AXIS MOVEMENT, NAMELY, POWER SUPPLY UNITS, CONTROL UNITS, POSITION CONTROLS, SPEED CONTROLS, FORCE CONTROLS, AND ANALOG AND DIGITAL INTERFACE MODULES

FOR MECHANICAL GUIDANCE USING PIEZOELECTRIC PROPERTIES; COMPUTER AND COMPUTER SOFTWARE FOR OPERATING ACTUATING AND POSITIONING SYSTEMS; ELECTRIC CONTROLLABLE MECHANICAL SHIFTING EQUIPMENT, NAMELY, PRECISION POSITIONING SYSTEMS AND ACTUATORS AND CONTROL UNITS FOR SUCH EQUIPMENTS; ELECTRONIC INTEGRATED DISPLACEMENT SENSORS FOR MECHANICAL POSITIONING SYSTEMS USING PIEZOELECTRIC PROPERTIES; ENCAPSULATED AND UNENCAPSULATED PIEZOMULTILAYER-ACTUATORS; PIEZO-ENGINES, NAMELY, POWER SUPPLY UNITS, CONTROL UNITS, POSITION CONTROLS, SPEED CONTROLS, FORCE CONTROLS, AND ANALOG AND DIGITAL INTERFACE MODULES USING PIEZOELECTRIC PROPERTIES FOR PRECISE ADJUSTMENT IN OPTICS, SEMICONDUCTOR HANDLING AND INSPECTION SYSTEMS AND FOR PRECISION ALIGNMENT AND HANDLING SYSTEMS; PIEZO-ULTRASONIC TRANSDUCERS; MICRO POSITIONING STAGES, NAMELY, MOTORIZED WAFER HOLDERS AND TRANSPORTERS USING PIEZOELECTRIC PROPERTIES FOR OPTICAL WAVEGUIDES AND FIBER OPTICS; MULTI MODE SWITCHES FOR OPTICAL WAVEGUIDES; OPTICAL APPARATUS AND INSTRUMENTS, NAMELY, SPECTROMETERS, OPTICAL AND SEMICONDUCTOR INSPECTION SYSTEMS COMPRISING A MECHANICAL GUIDING SYSTEM USING PIEZOELECTRIC PROPERTIES, NAMELY, POWER SUPPLY UNITS, CONTROL UNITS, POSITION CONTROLS, SPEED CONTROLS, FORCE CONTROLS, AND ANALOG AND DIGITAL INTERFACE MODULES; BLANK OPTICAL DATA STORAGE CARRIERS (U.S. CLS. 21, 23, 26, 36 AND 38).

CLASS 42—SCIENTIFIC AND COMPUTER SERVICES

FOR DEVELOPMENT OF COMPUTER SOFTWARE FOR PIEZO-ELECTRONIC DRIVE SYSTEMS FOR SINGLE-AXIS AND MULTI-AXIS POSITIONING SYSTEMS AS WELL AS FOR PRECISION MICRO POSITIONING SYSTEMS INCLUDING FOR CONTROLLING OF MICRO POSITIONING STAGES FOR OPTICAL WAVEGUIDES AND FIBER OPTICS; DEVELOPMENT OF PIEZO-ELECTRIC DRIVE SYSTEMS FOR SINGLE-AXIS AND MULTI-AXIS POSITIONING SYSTEMS, PIEZO-TILTING PLATFORMS FOR OPTICAL ELEMENTS AND ACTIVE OPTICS, ENCAPSULATED AND UNENCAPSULATED PIEZO MULTILAYER ACTUATORS, PIEZO ENGINES, PIEZO ULTRASONIC TRANSDUCERS, MICRO POSITIONING STAGES FOR OPTICAL WAVEGUIDES AND FIBER OPTICS AS WELL AS MULTI MODE SWITCH FOR OPTICAL WAVEGUIDES; RESEARCH IN THE FIELD OF TECHNIQUE, NAMELY, DEVELOPMENT OF PRECISE ACTUATORS AND SENSORS FOR MEASUREMENT OF PRECISE EMOTIONS, INCLUDING DEVELOPMENT OF ELECTRONIC SYSTEMS AND SOFTWARE FOR SUCH COMPONENTS; TECHNICAL MEASUREMENT EVALUATION IN THE OPTICS AND SEMICONDUCTOR INDUSTRY AND IN THE FIELD OF INDUSTRY OF PRECISION ALIGNMENT AND HANDLING SYSTEMS (U.S. CLS. 100 AND 101).

STEVEN JACKSON, EXAMINING ATTORNEY

SN 79-006,976. SONY ERICSSON MOBILE COMMUNICATIONS AB, SWEDEN, FILED 5-20-2004.

MusicDJ

PRIORITY DATE OF 11-24-2003 IS CLAIMED.
OWNER OF INTERNATIONAL REGISTRATION 0837888
DATED 5-20-2004, EXPIRES 5-20-2014.

CLASS 9—ELECTRICAL AND SCIENTIFIC APPARATUS

FOR SOFTWARE, NAMELY, COMPUTER PROGRAMS IN RECORDED FORM AND FIXED IN ELECTRONIC MEMORY CIRCUITS, USED IN MOBILE OR CELLULAR PHONES FOR COMPOSING RING TONES (U.S. CLS. 21, 23, 26, 36 AND 38).

CLASS 38—COMMUNICATION

FOR TELECOMMUNICATIONS AND DATA COMMUNICATIONS SERVICES, NAMELY, DATA TRANSMITTAL IN THE FORM OF WIRELESS ELECTRONIC TRANSMISSION OF DATA, NAMELY, CUSTOMIZED RING TONES FOR MOBILE OR CELLULAR PHONES (U.S. CLS. 100, 101 AND 104).

STEVEN R. FOSTER, EXAMINING ATTORNEY

SN 79-008,160. JOINT-STOCK COMPANY "KRASNYJ OC-TYABR", RUSSIAN FED., FILED 10-8-2004.



OWNER OF INTERNATIONAL REGISTRATION 0841133
DATED 10-8-2004, EXPIRES 10-8-2014.

THE TRANSLITERATION OF THE NON-LATIN CHARACTERS IN THE MARK IS: KARA-KUM.

CLASS 29—MEATS AND PROCESSED FOODS

FOR MARMALADE; JAMS; MILK; CHEESE; SAUSAGES (U.S. CL. 46).

CLASS 30—STAPLE FOODS

FOR CONFECTIONERY; NAMELY, CANDY; CARAMELS; SWEETMEATS; CHOCOLATE; PRALINES; WAFLES; COCOA; PASTRIES; CUSTARD; MARZIPAN; CHOCOLATE-BASED BEVERAGES; COFFEE-BASED BEVERAGES; COFFEE; TEA; CAKES; ICE-CREAM (U.S. CL. 46).

CLASS 31—NATURAL AGRICULTURAL PRODUCTS

FOR FRESH CITRUS FRUITS AND HAZELNUTS (U.S. CLS. 1 AND 46).

CLASS 32—LIGHT BEVERAGES

FOR NON-ALCOHOLIC BEVERAGES, NAMELY FRUIT JUICE, LEMONADES; NON-ALCOHOLIC FRUIT JUICE BEVERAGES; BEER; DRINKING WATER, SPRING WATER, FRUIT FLAVORED WATER (U.S. CLS. 45, 46 AND 48).

CLASS 33—WINES AND SPIRITS

FOR HYDROMEL; WINE WHISKY; VODKA; ALCOHOLIC BITTERS; PREPARED ALCOHOLIC COCKTAILS; LIQUEURS; CIDER (U.S. CLS. 47 AND 49).

PAUL E. FAHRENKOPF, EXAMINING ATTORNEY

SN 79-015,755. ELITIS SA, FRANCE, FILED 5-20-2005.

ELITIS

THE MARK CONSISTS OF STANDARD CHARACTERS WITHOUT CLAIM TO ANY PARTICULAR FONT, STYLE, SIZE, OR COLOR.

OWNER OF INTERNATIONAL REGISTRATION 0863318 DATED 5-20-2005, EXPIRES 5-20-2015.

CLASS 16—PAPER GOODS AND PRINTED MATTER

FOR PRINTED MATTER, NAMELY, BOOKS AND MAGAZINES IN THE FIELD OF FURNITURE AND INTERIOR DECORATING; PHOTOGRAPHS (U.S. CLS. 2, 5, 22, 23, 29, 37, 38 AND 50).

CLASS 20—FURNITURE AND ARTICLES NOT OTHERWISE CLASSIFIED

FOR FURNITURE; MIRRORS; PICTURE FRAMES (U.S. CLS. 2, 13, 22, 25, 32 AND 50).

CLASS 24—FABRICS

FOR TEXTILES, NAMELY, PILLOWCASES, BED SHEETS, TOWELS, TAPESTRIES OF TEXTILE, TEXTILE FABRIC OF ANIMAL SKINS IMITATIONS, WAVY FIBER TEXTILES; TEXTILE PRODUCTS, NAMELY, CURTAINS MADE OF TEXTILE FABRICS; BED AND TABLE COVERS; TEXTILE FABRICS FOR HOME AND COMMERCIAL INTERIORS; FURNITURE TEXTILES, NAMELY, FABRICS FOR THE MANUFACTURE OF FURNITURE (U.S. CLS. 42 AND 50).

CLASS 27—FLOOR COVERINGS

FOR CARPETS; BATH AND FLOOR MATS; RUGS; LINOLEUM; FLOOR COVERINGS; NON-TEXTILE WALL HANGINGS; WALLPAPER (U.S. CLS. 19, 20, 37, 42 AND 50).

CLASS 28—TOYS AND SPORTING GOODS

FOR PLAYING CARDS (U.S. CLS. 22, 23, 38 AND 50).
SHANNON TWOHIG, EXAMINING ATTORNEY

SN 79-018,559. FLEXLINK AB, SWEDEN, FILED 2-9-2005.

FLEXLINK

THE MARK CONSISTS OF STANDARD CHARACTERS WITHOUT CLAIM TO ANY PARTICULAR FONT, STYLE, SIZE, OR COLOR.

OWNER OF INTERNATIONAL REGISTRATION 0758763 DATED 4-9-2001, EXPIRES 4-9-2011.

CLASS 6—METAL GOODS

FOR METAL BUILDING MATERIALS, NAMELY, GIRDERS, FLANGES, RIVETS, TACKS, PLUGS, BOLTS, PIPES, SCREWS, NAILS, NUTS, WIRE FENCES, PEGS, POLES, PROPS, STANCHIONS, WHEEL CLAMPS, AND CHAINS ALL MADE OF METAL; METAL PALLETS AND ANGLE-IRONS AND ANGLE-STANCHIONS MADE OUT OF METAL; GOODS OF COMMON METAL, NAMELY, BEAMS, BRACKETS AND SUPPORT FEET; NON-ELECTRICAL CABLES OF METAL; METAL CLIPS FOR CABLES AND PIPES; CABLE JUNCTION SLEEVES OF METAL; WIRE NETS AND GRATINGS OF METAL; METAL GATES AND POSTS; METAL LOCKS AND PIPE FITTINGS; METAL ENCLOSURES FOR CONVEYORS AND MACHINES AND METAL FENCE PANELS (U.S. CLS. 2, 12, 13, 14, 23, 25 AND 50).

CLASS 7—MACHINERY

FOR CONVEYORS; PACKING AND UNPACKING MACHINES; AUTOMATIC HANDLING MACHINES FOR PICKING AND PLACING OF DIFFERENT PRODUCTS; HANDLING APPARATUS, NAMELY, DIVERTERS, MERGERS, BUFFERS AND AUTOMATIC HANDLING MACHINES FOR LOADING AND UNLOADING PALLETS OF DIFFERENT SIZES AND MATERIALS; DRIVING DEVICES FOR LIFTS, CONVEYORS, ELEVATORS AND AUTOMATIC HANDLING MACHINES; ELEVATORS AND AUTOMATIC HANDLING MACHINES FOR LOADING AND UNLOADING OF GOODS TO AND FROM OTHER MACHINES; MOTORS FOR LIFTS, CONVEYORS, ELEVATORS AND AUTOMATIC HANDLING MACHINES; APPARATUS FOR CLEANING, NAMELY CLEANING OF LIFTS, CONVEYORS, ELEVATORS AND AUTOMATIC HANDLING MACHINES; WASHING MACHINES FOR METAL, GLASS, PLASTIC PARTS AND PACKAGES; PLASTIC CHAINS CONVEYORS; BELTS FOR CONVEYORS, NAMELY PLASTIC, RUBBER, FABRIC AND STEEL BELTS FOR TRANSPORTATION OF GOODS IN CONVEYORS (U.S. CLS. 13, 19, 21, 23, 31, 34 AND 35).

CLASS 9—ELECTRICAL AND SCIENTIFIC APPARATUS

FOR BLANK MAGNETIC DATA CARRIERS AND CD-ROM; DATA PROCESSORS; RECORDED COMPUTER PROGRAMS FOR USE IN DATABASE MANAGEMENT, PRODUCTION CONTROL, PRODUCT DATA MANAGEMENT AND MANUFACTURING EXECUTION; APPARATUS AND INSTRUMENTS FOR SURVEYING, WEIGHING, MEASURING, CONTROLLING AND SIGNALING, NAMELY DETECTORS FOR DETECTING PROBLEMS AND STATUS OF PRODUCT FLOWS IN THE CONVEYOR SYSTEM, SCALES FOR MEASURING WEIGHT; APPARATUS AND INSTRUMENTS FOR SUPERVISION, MEASURING, CONTROL AND SIGNALING, NAMELY VIDEO RECORDERS, CAMERAS AND COMPUTERS, ALL FOR PICKING AND PLACING OF PRODUCTS IN PRODUCTION FLOW AND CONVEYOR SYSTEMS, IDENTIFYING PRODUCTS IN PRODUCTION FLOW AND CONVEYOR SYSTEMS AND CHECKING PRODUCTION PROCESS EVENTS; CAMERAS FOR SUPERVISION OF PRODUCT FLOWS IN THE CONVEYOR SYSTEM; INDICATORS AND SENSORS FOR INDICATING AND SENSING WEIGHT, MOVEMENTS, STATUS AND PROBLEMS IN PRODUCT FLOWS IN CONVEYOR SYSTEMS (U.S. CLS. 21, 23, 26, 36 AND 38).

CLASS 17—RUBBER GOODS

FOR PLASTICS IN EXTRUDED FORM FOR USE IN MANUFACTURE, PACKING, STOPPING AND INSULATING MATERIALS; FLEXIBLE PIPES NOT MADE OUT OF METAL (U.S. CLS. 1, 5, 12, 13, 35 AND 50).

CLASS 36—INSURANCE AND FINANCIAL

FOR FINANCING SERVICES IN THE NATURE OF LEASE-PURCHASE FINANCING OF PRODUCTION EQUIPMENT AND SOFTWARE (U.S. CLS. 100, 101 AND 102).

CLASS 37—CONSTRUCTION AND REPAIR

FOR INSTALLATION SERVICES, MAINTENANCE SERVICES AND REPAIR SERVICES FOR COMPUTER SYSTEMS, ELECTRICAL EQUIPMENT, ELEVATORS, CONVEYORS, CONVEYOR SYSTEMS, AND AUTOMATIC HANDLING MACHINES, AND PARTS THEREOF, CONSTRUCTION OF CONVEYOR EQUIPMENT; PROVIDING INFORMATION CONCERNING CONSTRUCTION, BUILDING AND REPAIRS OF CONVEYORS, CONVEYOR SYSTEMS, ELEVATORS AND AUTOMATIC HANDLING MACHINES (U.S. CLS. 100, 103 AND 106).

CLASS 41—EDUCATION AND ENTERTAINMENT

FOR EDUCATION AND TEACHING SERVICES, NAMELY, CLASSES AND SEMINARS IN THE FIELD OF PRODUCT MANAGEMENT AND SYSTEMS, HOW TO DESIGN, INSTALL, COMMISSION AND MAINTAIN CONVEYORS, CONVEYOR SYSTEMS, ELEVATORS AND AUTOMATIC HANDLING MACHINES (U.S. CLS. 100, 101 AND 107).

CLASS 42—SCIENTIFIC AND COMPUTER SERVICES

FOR COMPUTER PROGRAMMING FOR OTHERS; MAINTENANCE, UPDATING AND DESIGNING OF COMPUTER PROGRAMS FOR OTHERS; COMPUTER SYSTEMS ANALYSING; CONSULTANCY IN THE FIELD OF COMPUTER HARDWARE; RENTAL OF COMPUTERS AND COMPUTER PROGRAMS; INDUSTRIAL DESIGN; SCIENTIFIC AND INDUSTRIAL RESEARCH FOR OTHERS AND SCIENTIFIC DEVELOPMENT; ENGINEERING; QUALITY CONTROL FOR OTHERS; MATERIAL TESTING; TECHNICAL PROJECT STUDIES FOR PRODUCTION SYSTEMS, SOFTWARE AND EQUIPMENT, CONSTRUCTION DRAFTING (U.S. CLS. 100 AND 101).

JILL PRATER, EXAMINING ATTORNEY

SN 79-020,876. SPIRAX-SARCO LIMITED, GLOUCESTERSHIRE, UNITED KINGDOM, FILED 10-12-2005.

SPIRAX SARCO

PRIORITY DATE OF 5-23-2005 IS CLAIMED.
OWNER OF INTERNATIONAL REGISTRATION 0876869 DATED 10-12-2005, EXPIRES 10-12-2015.
OWNER OF U.S. REG. NOS. 1,348,460, 1,348,912 AND 1,471,187.

CLASS 37—CONSTRUCTION AND REPAIR

FOR CUSTOM CONSTRUCTION, REPAIR, INSTALLATION, COMMISSIONING AND MAINTENANCE OF ENGINEERING SYSTEMS, AND FLUID OR STEAM CONTROL SYSTEMS; CONSULTANCY AND ADVISORY SERVICES RELATING TO CUSTOM CONSTRUCTION, REPAIR, INSTALLATION, COMMISSIONING AND MAINTENANCE OF ENGINEERING SYSTEMS, AND FLUID OR STEAM CONTROL SYSTEMS (U.S. CLS. 100, 103 AND 106).

CLASS 42—SCIENTIFIC AND COMPUTER SERVICES

FOR TECHNOLOGICAL CONSULTATION IN THE FIELD OF ENGINEERING, AND FLUID AND STEAM CONTROL TECHNOLOGY; CONDUCTING SURVEYS OF INDUSTRIAL PREMISES IN THE FIELD OF ENGINEERING AND FLUID AND STEAM CONTROL TECHNOLOGY; CONDUCTING OF FEASIBILITY STUDIES RELATING TO ENGINEERING, AND FLUID AND STEAM CONTROL; TECHNOLOGY CONSULTATION AND RESEARCH IN THE FIELD OF ENGINEERING, AND FLUID AND STEAM CONTROL; CONSTRUCTION DRAFTING, ENGINEERING, INDUSTRIAL DESIGN AND MECHANICAL RESEARCH; INSPECTION AND CERTIFICATION OF ENGINEERING SYSTEMS; PREPARATION OF ENGINEERING SURVEY REPORTS RELATING TO FLUID OR STEAM CONTROL SYSTEMS (U.S. CLS. 100 AND 101).

RICHARD WHITE, EXAMINING ATTORNEY

SN 79-021,505. TOYE, KENNING & SPENCER LIMITED, UNITED KINGDOM, FILED 1-19-2006.

KJD

THE MARK CONSISTS OF STANDARD CHARACTERS WITHOUT CLAIM TO ANY PARTICULAR FONT, STYLE, SIZE, OR COLOR.

OWNER OF INTERNATIONAL REGISTRATION 0878596 DATED 1-19-2006, EXPIRES 1-19-2016.

CLASS 14—JEWELRY

FOR PRECIOUS METALS AND THEIR ALLOYS; JEWELRY; IMITATION JEWELRY; PRECIOUS STONES; SEMI-PRECIOUS STONES; CUFF LINKS; DRESS STUD SETS, NAMELY, SHIRT STUDS; ORNAMENTAL COLLAR STIFFENERS, NAMELY, COLLAR STAYS OF PRECIOUS METALS, ALLOYS OF PRECIOUS METALS, OR COATED WITH PRECIOUS METALS OR ALLOYS OF PRECIOUS METALS; TIE BARS; KEY RINGS OF PRECIOUS METALS, OR ALLOYS OF PRECIOUS METALS, OR COATED WITH PRECIOUS METALS OR ALLOYS OF PRECIOUS METALS; MONEY CLIPS OF PRECIOUS METALS, OR ALLOYS OF PRECIOUS METALS, OR COATED WITH PRECIOUS METALS OR ALLOYS OF PRECIOUS METALS; BUSINESS CARD HOLDERS OF PRECIOUS METALS, OR ALLOYS OF PRECIOUS METALS, OR COATED WITH PRECIOUS METALS OR ALLOYS OF PRECIOUS METALS; ORNAMENTAL BUTTONS FOR CLOTHING OF PRECIOUS METALS, OR ALLOYS OF PRECIOUS METALS, OR COATED WITH PRECIOUS METALS OR ALLOYS OF PRECIOUS METALS; BRACELETS (U.S. CLS. 2, 27, 28 AND 50).

CLASS 25—CLOTHING

FOR FOOTWEAR; HEADWEAR; BELTS FOR CLOTHING; BRACES FOR CLOTHING; COLLAR PROTECTORS; FITTINGS OF METAL FOR SHOES AND BOOTS, NAMELY, PROTECTIVE METAL MEMBERS FOR SHOES AND BOOTS (U.S. CLS. 22 AND 39).

KRISTINA MORRIS, EXAMINING ATTORNEY

SN 79-021,513, TOYE, KENNING & SPENCER LIMITED,
UNITED KINGDOM, FILED 1-19-2006.

LBB

THE MARK CONSISTS OF STANDARD CHARACTERS WITHOUT CLAIM TO ANY PARTICULAR FONT, STYLE, SIZE, OR COLOR.

OWNER OF INTERNATIONAL REGISTRATION 0878629 DATED 1-19-2006, EXPIRES 1-19-2016.

CLASS 14—JEWELRY

FOR PRECIOUS METALS AND THEIR ALLOYS; JEWELRY; IMITATION JEWELRY; PRECIOUS STONES; SEMI-PRECIOUS STONES; CUFF LINKS; DRESS STUD SETS, NAMELY SHIRT STUDS; ORNAMENTAL COLLAR STIFFENERS, NAMELY COLLAR STAYS OF PRECIOUS METALS, ALLOYS OF PRECIOUS METALS, OR COATED WITH PRECIOUS METALS OR ALLOYS OF PRECIOUS METALS; TIE BARS; KEY RINGS OF PRECIOUS METALS, OR ALLOYS OF PRECIOUS METALS, OR COATED WITH PRECIOUS METALS OR ALLOYS OF PRECIOUS METALS; MONEY CLIPS OF PRECIOUS METALS, OR ALLOYS OF PRECIOUS METALS, OR COATED WITH PRECIOUS METALS OR ALLOYS OF PRECIOUS METALS; BUSINESS CARD HOLDERS OF PRECIOUS METALS, OR ALLOYS OF PRECIOUS METALS, OR COATED WITH PRECIOUS METALS OR ALLOYS OF PRECIOUS METALS; ORNAMENTAL BUTTONS FOR CLOTHING OF PRECIOUS METALS, OR ALLOYS OF PRECIOUS METALS, OR COATED WITH PRECIOUS METALS OR ALLOYS OF PRECIOUS METALS; BRACELETS (U.S. CLS. 2, 27, 28 AND 50).

CLASS 25—CLOTHING

FOR FOOTWEAR; HEADWEAR, BELTS FOR CLOTHING; BRACES FOR CLOTHING; COLLAR PROTECTORS; FITTINGS OF METAL FOR SHOES AND BOOTS, NAMELY PROTECTIVE METAL MEMBERS FOR SHOES AND BOOTS (U.S. CLS. 22 AND 39).

KRISTINA MORRIS, EXAMINING ATTORNEY

SN 79-021,521, PETRUS J. VAN LIEROP, NETHERLANDS,
FILED 9-23-2005.

i-SuSs

THE MARK CONSISTS OF STANDARD CHARACTERS WITHOUT CLAIM TO ANY PARTICULAR FONT, STYLE, SIZE, OR COLOR.

PRIORITY DATE OF 8-4-2005 IS CLAIMED.

OWNER OF INTERNATIONAL REGISTRATION 0878644 DATED 9-23-2005, EXPIRES 9-23-2015.

CLASS 9—ELECTRICAL AND SCIENTIFIC APPARATUS

FOR OPTICAL AND ELECTRONIC ANALYSIS INSTRUMENTS, NAMELY ENCODED MICRO PARTICULATES, TAGS AND TAGGANTS OF PLASTIC, METAL AND SILICATE FOR USE IN THE FIELD OF DETECTION, LOCALIZATION AND PASSIVE TRACING AND TRACKING OF GOODS, MAIL, BOXED GOODS, FREIGHT CONTAINERS; ELECTRONIC APPARATUS AND INSTRUMENTS, NAMELY GAMMA RADIATION DETECTORS AND CHEMICAL AND HEAT SENSORS, FOR DETECTING CHANGES AND MODIFICATIONS TO, AND TAMPERING WITH, GOODS, MAIL, BOXED GOODS AND FREIGHT CONTAINERS; LOCALIZATION APPARATUS, MACHINES AND INSTRUMENTS, NAMELY ANTENNAS AND RADIO TRANSMITTERS AND GLOBAL POSITIONING SYSTEMS (GPS), FOR SECURING AND CONTROLLING GOODS IN TRANSIT AREAS; SENSORS FOR DETERMINATION OF TEMPERATURE, POSITIONS, DISTANCE AND MOVEMENT; SCANNERS FOR CAPTURING IMAGES FOR ANALYSIS; BARCODE LABELERS, SCANNERS, ENCODED MICRO-PARTICULATES, TAGS AND TAGGANTS OF PLASTIC, METAL AND SILICATE, AND TAG READERS FOR USE IN THE FIELD OF PASSIVE LABELING, TRACING AND TRACKING OF PERSONS, ANIMALS, VEHICLES OR GOODS OF ANY KIND AND FOR REGISTRATION OF PERSONS AND PRODUCTS; RADIO FREQUENCY IDENTIFICATION (RFID) TAGS; PRE-RECORDED MAGNETIC DATA CARRIERS AND SCANNERS FEATURING PERSON AND PRODUCT REGISTRATION INFORMATION; PRE-RECORDED MAGNETIC DATA CARRIERS FOR IDENTIFICATION, CREDIT AND PAYMENT PURPOSES AND THE STORAGE OF MEDICAL INFORMATION; SOFTWARE FOR OPERATING OBSERVATION AND SURVEILLANCE SYSTEMS, ACCESS CONTROL SYSTEMS, TRACKING SYSTEMS; SOFTWARE FOR PROCESSING, ARCHIVING, INTERPRETING, MANIPULATING, REPRODUCING AND TRANSMITTING DATA; SOFTWARE AND HARDWARE FOR TRANSMITTING ALARM SIGNALS AND INFORMATION BY MEANS OF TELEPHONE, TELEGRAPHIC, CABLE, AND SATELLITE TRANSMISSIONS; ELECTRICAL AND OPTICAL MEASURING AND DETECTION EQUIPMENT FOR THE ASSESSMENT OF POSSIBLE TAMPERING WITH STORED GOODS, MAIL, BOXED GOODS AND FREIGHT CONTAINERS (U.S. CLS. 21, 23, 26, 36 AND 38).

CLASS 38—COMMUNICATION

FOR SECURED AND NON-SECURED, AND CODED AND NON-CODED TELECOMMUNICATION SERVICES, NAMELY, TRANSFERRING AND TRANSMITTING, STORING, PROCESSING, AND DELIVERING INFORMATION AND DATA, TRANSFERRING AND TRANSMITTING DIGITAL INFORMATION, SOUND, DATA, INFORMATION AND IMAGE SIGNALS BY MEANS OF TELEPHONE, TELEGRAPHIC, CABLE, AND SATELLITE TRANSMISSION AND TELECOMMUNICATION ACCESS SERVERS; PROVIDING THIRD PARTY USERS WITH ACCESS TO TELECOMMUNICATION AND COMPUTER INFRASTRUCTURES VIA CABLE, RADIO, AND SATELLITE NETWORKS; TELECOMMUNICATION CONSULTATION SERVICES; TELECOMMUNICATION ACCESS SERVICES, NAMELY VIA THE INTERNET AND CABLE AND SATELLITE TRANSMISSION (U.S. CLS. 100, 101 AND 104).

CLASS 42—SCIENTIFIC AND COMPUTER SERVICES

FOR DESIGNING MACHINES, APPARATUS, AND INSTRUMENTS, AND SYSTEMS COMPRISED OF SUCH MACHINES, APPARATUS AND INSTRUMENTS, FOR USE IN SCANNING, ANALYZING, REGISTERING, DETECTING, AND LOCATING PERSONS AND PRODUCTS, AND FOR ANALYZING, TRANSMITTING, ARCHIVING, REPRODUCING AND TRANSMITTING INFORMATION; TECHNICAL RESEARCH IN THE FIELD OF ANALYZING, TRANSMITTING, ARCHIVING, REPRODUCING AND TRANSMITTING INFORMATION, AND DETECTING, LOCATING, AND TRACKING PERSONS AND PRODUCTS; PROVIDING TEMPORARY USE OF NON-DOWNLOADABLE COMPUTER SOFTWARE FOR ACCESSING INFORMATION

IN THE FIELD OF TELECOMMUNICATIONS AND FOR DETECTING, TRACKING, AND LOCATING PERSONS AND PRODUCTS VIA THE GLOBAL COMPUTER NETWORK; PROVIDING ONLINE NON-DOWNLOADABLE SOFTWARE FOR USE IN DATABASE MANAGEMENT IN THE FIELD OF TELECOMMUNICATIONS AND THE DETECTION AND SURVEILLANCE OF PERSONS AND PRODUCTS; COMPUTER SITE DESIGN; CONSULTATION IN THE FIELD OF INFORMATION AND COMMUNICATION TECHNOLOGY (ICT); DESIGNING AND DEVELOPING OF SOFTWARE FOR MANAGING DATABASES IN THE FIELD OF COMMUNICATION AND PERSONAL AND PRODUCT REGISTRATION INFORMATION; CONSULTATION IN THE FIELD OF SELECTION, IMPLEMENTATION AND USE OF COMPUTER HARDWARE AND SOFTWARE SYSTEMS FOR OTHERS; APPLICATION SERVICE PROVIDER FEATURING SOFTWARE FOR PROVIDING AN ONLINE DATABASE IN THE FIELD OF TRANSACTION PROCESSING TO UPLOAD TRANSACTIONAL DATA, PROVIDE STATISTICAL ANALYSIS, AND PRODUCE NOTIFICATIONS AND REPORTS (U.S. CLS. 100 AND 101).

SUZANNE BLANE, EXAMINING ATTORNEY

CLASS 40—MATERIAL TREATMENT

FOR CUSTOM ASSEMBLING OF PLASTIC, GLASS AND METAL COMPONENTS FOR OTHERS; CUSTOM PLASTIC INJECTION MOLDING SERVICES, NAMELY, PARTS MOLDING; MOLDING OF PLASTICS; CONTRACT MOLDING SERVICES; PATTERN PRINTING; SILKSCREEN PRINTING; APPLICATION OF PROTECTIVE COATINGS TO SURFACES USING THE PHYSICAL VAPOR DEPOSITION PROCESS, THE PLASMA PROCESS, THE VACUUM DEPOSITION PROCESS AND THE T-DIE COATING PROCESS; APPLICATION OF PROTECTIVE THIN FILM COATINGS TO OPTICAL COMPONENTS; TREATMENT OF PLASTIC MATERIALS TO PRODUCE PLASTIC MOLDINGS IN THE FIELD OF MOBILE HANDSETS, THE TELECOMMUNICATIONS INDUSTRY, CONSUMER ELECTRONICS, INTERIOR COMPONENTS OF AUTOMOBILES, AND THE MEDICAL INDUSTRY; PRINTING, NAMELY, GRAVURE PRINTING, FLEXOPRINTING AND PAD PRINTING; CUSTOM ASSEMBLING OF MOLDS AND TOOLS IN THE FIELD OF INJECTION MOLDING FOR OTHERS; METAL STAMPING; METAL TEMPERING (U.S. CLS. 100, 103 AND 106).

AMOS T. MATTHEWS, JR., EXAMINING ATTORNEY

SN 79-021,576. UNIPLAS ENTERPRISES PTE LTD, SINGAPORE, FILED 3-8-2005.

SN 79-021,893. DIPL.-ING. THONHAUSER GMBH, AUSTRIA, FILED 1-9-2006.

uniplas 

VIP

PRIORITY DATE OF 2-3-2005 IS CLAIMED.
OWNER OF INTERNATIONAL REGISTRATION 0878850
DATED 3-8-2005, EXPIRES 3-8-2015.

CLASS 6—METAL GOODS

FOR STAMPED METAL FOR USE IN MOLDING; STAMPED METAL MOLDS; METAL FRAMES FOR MOLDING MADE FROM STAMPED METAL SHAPES; METAL FOUNDRY MOLDS; FOUNDRY MOLDS OF METAL; METAL MOLDS FOR CASTING PLASTICS; METALLIC MOLDS FOR CASTING PLASTIC MATERIALS; MOLDS OF METAL FOR FORMING CONCRETE FABRICATIONS; METALLIC COLUMN MOLDS FOR CASTING PLASTICS (U.S. CLS. 2, 12, 13, 14, 23, 25 AND 50).

CLASS 9—ELECTRICAL AND SCIENTIFIC APPARATUS

FOR OPTICAL DISPLAY LENSES ADAPTED FOR USE ON MOBILE PHONE SCREENS; OPTICAL LENSES; STRUCTURAL PARTS, NAMELY, HOUSINGS AND PLASTIC HOUSINGS, ALL FOR ELECTRICAL AND ELECTRONIC APPARATUS, NAMELY, CELL PHONES, PORTABLE MEDIA PLAYERS, COMPUTER PERIPHERALS, COMPUTER HARDWARE AND MEDICAL DIAGNOSTIC COMPUTER HARDWARE; OPTICAL LENSES FOR ELECTRICAL APPARATUS (U.S. CLS. 21, 23, 26, 36 AND 38).

THE MARK CONSISTS OF STANDARD CHARACTERS WITHOUT CLAIM TO ANY PARTICULAR FONT, STYLE, SIZE, OR COLOR.

OWNER OF INTERNATIONAL REGISTRATION 0879723
DATED 1-9-2006, EXPIRES 1-9-2016.

CLASS 3—COSMETICS AND CLEANING PREPARATIONS

FOR CLEANING PREPARATIONS FOR INDUSTRIAL USE, ESPECIALLY FOR PRODUCTION AND FILLING FACILITIES FOR LIQUID AND VISCOUS PRODUCTS, NAMELY, FOODSTUFFS AND PHARMACEUTICAL PREPARATIONS (U.S. CLS. 1, 4, 6, 50, 51 AND 52).

CLASS 37—CONSTRUCTION AND REPAIR

FOR ENVIRONMENTAL REMEDIATION SERVICES IN THE NATURE OF WASTE PURIFICATION OF INDUSTRIAL INSTALLATIONS ESPECIALLY OF PRODUCTION AND FILLING FACILITIES FOR LIQUID AND VISCOUS PRODUCTS, ESPECIALLY FOR LIQUID AND VISCOUS FOODSTUFFS AND PHARMACEUTICAL PREPARATIONS (U.S. CLS. 100, 103 AND 106).

HOWARD B. LEVINE, EXAMINING ATTORNEY

SN 79-022,782. ANDREW ROY HOWARD BACON AND;
RICHARD CHARLES HOWARD BACON, UNITED KING-
DOM, FILED 12-7-2005.

SN 79-022,866. EKA CHEMICALS AB, SWEDEN, FILED 11-
25-2005.

EKA SCOPE

THE MARK CONSISTS OF STANDARD CHARACTERS WITHOUT CLAIM TO ANY PARTICULAR FONT, STYLE, SIZE, OR COLOR.

PRIORITY DATE OF 5-26-2005 IS CLAIMED.

OWNER OF INTERNATIONAL REGISTRATION 0882429 DATED 11-25-2005, EXPIRES 11-25-2015.

THE ENGLISH TRANSLATION OF THE WORD EKA IN THE MARK IS "OAK BOAT".



OWNER OF INTERNATIONAL REGISTRATION 0882133 DATED 12-7-2005, EXPIRES 12-7-2015.

CLASS 16—PAPER GOODS AND PRINTED MATTER

FOR MEMORY BOOKS; ALBUMS FOR PHOTOGRAPHS; BABY BOOKS; CHILDREN'S BOOKS; CALENDARS; PRINTED CHARTS FOR RECORDING HEIGHT MEASUREMENT; CRAYONS; PAINT BRUSHES; PENCILS AND COLOUR PENCILS; AND OFFICE REQUISITES, NAMELY, PENCIL HOLDERS (U.S. CLS. 2, 5, 22, 23, 29, 37, 38 AND 50).

CLASS 28—TOYS AND SPORTING GOODS

FOR GAMES AND PLAYTHINGS, NAMELY, BOARD GAMES; MAGNETIC GAMES AND TOYS, NAMELY, BOARD GAMES, PARLOR GAMES AND PARTY GAMES; DICE GAMES; HAND PUPPETS; MARIONETTE PUPPETS; PUPPETS; OUTDOOR ACTIVITY GAMES IN THE NATURE OF BOWLING GAMES CONSISTING PRIMARILY OF BOWLING PINS AND BOWLING BALLS; TOY BOWLING GAME SETS COMPOSED PRIMARILY OF BOWLING BALLS AND BOWLING PINS; SKITTLES; DOLLS, DOLLS AND PLAY SETS THEREFOR; DOLLS AND ACCESSORIES THEREFOR; HAND BALLS; BALLS FOR GAMES; SPORTS BALLS; CHILDREN'S MULTIPLE ACTIVITY TOYS; SOFT SCULPTURE TOYS; BATH TOYS; BENDABLE TOYS; CHILDREN'S ART ACTIVITY TOYS; CONSTRUCTION TOYS; TOY KITS COMPRISED OF AN ASSORTMENT OF SOFT SCULPTURE SHAPES, FABRICS, AND SCENERY PROPS THAT MAY BE ATTACHED TO EACH OTHER USING FABRIC FASTENERS AND THEN DISMANTLED; TOY MODEL THEATRE SETS FOR CHILDREN COMPRISED OF SOFT SCULPTURE SHAPES, FABRICS, SCENERY PROPS AND PUPPETS; AND DECORATIONS FOR CHRISTMAS TREES (U.S. CLS. 22, 23, 38 AND 50).

SONYA STEPHENS, EXAMINING ATTORNEY

CLASS 9—ELECTRICAL AND SCIENTIFIC APPARATUS

FOR PROCESSING ANALYZERS, EQUIPMENT FOR MONITORING OR CONTROLLING MANUFACTURING PROCESSES, NAMELY COMPUTERS, SPECTROPHOTOMETERS, LASERS, IMAGE PROCESSORS, OPTICAL OR ELECTRONIC SENSORS, FLUORESCENCE, ULTRA SOUND, OR ELECTROCHEMICAL SENSORS; COMPUTERS FOR MONITORING OR CONTROLLING MANUFACTURING PROCESSES CONTAINING SOFTWARE, ALL THE FOREGOING FOR MEASURING AND CONTROL OF PAPER AND TISSUE PAPER MAKING (U.S. CLS. 21, 23, 26, 36 AND 38).

CLASS 42—SCIENTIFIC AND COMPUTER SERVICES

FOR PROVIDING TECHNOLOGICAL SERVICES, NAMELY MONITORING THE PRODUCTION PROCESS OF PAPER AND TISSUE PAPER AND CONTROLLING THE ADDITION OF CHEMICALS IN PAPER AND TISSUE PAPER DURING THE PRODUCTION PROCESS (U.S. CLS. 100 AND 101).

FRED CARL, EXAMINING ATTORNEY

SN 79-025,398. JÖLLENBECK GMBH, FED REP GERMANY, FILED 3-3-2006.



OWNER OF INTERNATIONAL REGISTRATION 0889004 DATED 3-3-2006, EXPIRES 3-3-2016.

THE COLOR(S) WHITE, BLACK AND RED IS/ARE CLAIMED AS A FEATURE OF THE MARK.

THE COLOR RED APPEARS AROUND THE PERIMETER OF THE RECTANGLE, AND WITHIN THE SMALLER RECTANGLE. THE COLOR BLACK APPEARS IN THE WORD LINK. THE COLOR WHITE APPEARS AS A CURVED DESIGN, BETWEEN THE TWO RECTANGLES, AND IN THE WORD "SPEED".

CLASS 9—ELECTRICAL AND SCIENTIFIC APPARATUS

FOR DEVICES FOR THE RECORDING, TRANSMISSION AND PLAYBACK OF SOUND AND IMAGES; DATA PROCESSING EQUIPMENT, NAMELY, COMPUTERS, NOTEBOOK COMPUTERS AND PERSONAL DIGITAL ASSISTANTS (PDA); ANCILLARY EQUIPMENT FOR COMPUTERS, TELEVISION SETS, AND MULTIMEDIA APPARATUS, NAMELY, COMPUTER GAME PROGRAMS, JOYSTICKS, VIDEO GAME INTERACTIVE CONTROL FLOOR PADS OR MATS, VIDEO GAME MACHINES FOR USE WITH TELEVISIONS, AND DIGITAL INPUT AND OUTPUT SCANNERS; VIDEO GAME INTERACTIVE REMOTE CONTROL UNITS, COMPUTER MOUSE AND MOUSE PADS, COMPUTER GRAPHIC BOARDS, KEYBOARDS, COMPUTER KEYPADS, COMPUTER CURSOR CONTROL DEVICES, NAMELY, LIGHT PENS AND COMPUTER STYLUS, AND CONTROL PADS, MULTIFUNCTION KEYBOARDS, PLAYER-OPERATED ELECTRONIC CONTROLLERS FOR ELECTRONIC VIDEO GAME MACHINES; PLAYER-OPERATED ELECTRONIC CONTROLLERS IN THE FORM OF ACCELERATOR PEDALS, BRAKE PEDALS, STEERING WHEELS AND STEERING WHEEL COLUMNS, AND GUNS FOR ELECTRONIC GAMES AND FOR OPERATING ELECTRONIC APPARATUS; VIDEO OUTPUT GAME MACHINES AND APPARATUS FOR USE WITH TELEVISIONS; PROGRAMMABLE DIGITAL TELEVISION RECORDERS; MAGNIFYING GLASSES AND HOLDERS FOR HOLDING AND OPERATING ELECTRONIC APPARATUS WITH DISPLAYS; COMPUTER INTERFACE BOARDS, UPI (UNIVERSAL PERIPHERAL INTERFACE) HARDWARE, PLUG-IN CONNECTORS, COMPUTER MEMORIES, MEMORY CARD READERS, MEMORY CARDS, COMPUTER PARALLEL PORTS AND COMPUTER SERIAL PORTS; EXTERNAL COMPUTER DISC DRIVES, EXTERNAL BACK UP DRIVES FOR COMPUTERS, COMPUTER STORAGE DEVICES, NAMELY, JUMPDRIVES, FLASH DRIVES AND THUMB DRIVES; REMOTE CONTROL FOR CD PLAYERS, DVD PLAYERS, STEREO RECEIVERS, STEREO TUNERS, AMPLIFIERS, VIDEO RECORDERS, SOUND RECORDERS TELEVISIONS, VIDEO GAME MACHINES AND AUDIO EQUIPMENT; HEADPHONES, MICROPHONES, COMPUTER TERMINALS FOR INTERNET CONNECTIONS, COMPUTER TELEPHONY SOFTWARE; TELEPHONES AND TELEPHONE APPARATUS; ACTIVE LOUDSPEAKERS; CONNECTOR CABLES AND ELECTRICAL ADAPTERS; MODEMS, BATTERIES, ACCUMULATORS, ELECTRICAL POWER SUPPLY DISTRIBUTION BOXES, ELECTRICAL POWER SUPPLY CONNECTORS AND ADAPTORS FOR USE WITH PORTABLE ELECTRONIC DEVICES, BATTERY CHARGERS, AC/DC ADAPTERS, COMPUTER NETWORK SWITCHES AND ROUTERS, TELEVISION DECODERS, FLASH CARD ADAPTERS; CHARGING APPLIANCES FOR RECHARGEABLE EQUIPMENT; GOODS OF LEATHER AND PLASTIC, NAMELY, PROTECTIVE BAGS, CARRYING BAGS, PROTECTIVE SLEEVES AND CASES FOR HOLDING AND STORING DATA PROCESSING EQUIPMENT, NAMELY, COMPUTERS, NOTEBOOK COMPUTERS, PERSONAL DIGITAL ASSISTANTS (PDA) VIDEO GAME MACHINES FOR USE WITH TELEVISIONS, AND MULTIMEDIA PROJECTORS; MOUNTINGS DEVICES, NAMELY, STRAPS AND TRAY MOUNTINGS FOR ELECTRONIC GAME; IMPACT PROTECTION SPECIALTY CASES AND PROTECTIVE HOLDERS ADAPTED FOR HOLDING AND STORING ELECTRONIC GAME PROGRAMS, NOTEBOOK COMPUTERS AND PERSONAL DIGITAL ASSISTANTS (PDA'S); ARCHIVING AND STORAGE CONTAINERS ADAPTED FOR HOLDING ELECTRONIC APPARATUS, NAMELY, COMPUTERS, NOTEBOOK COMPUTERS, PERSONAL DIGITAL ASSISTANTS (PDA) VIDEO GAME MACHINES FOR USE WITH TELEVISIONS, EXTERNAL COMPUTER HARD DRIVES, MULTIMEDIA PROJECTORS, AND BLANK FLOPPY COMPUTER DISCS; BAGS SOLD EMPTY SPECIALLY ADAPTED FOR ELECTRONIC MEMORIES AND MEMORY CARDS; BAGS SPECIALLY ADAPTED FOR ELECTRONIC MEMORIES AND MEMORY CARDS WITH HANDHELD ELECTRONIC DEVICES, NAMELY, PERSONAL DIGITAL ASSISTANTS (PDA) (U.S. CLS. 21, 23, 26, 36 AND 38).

CLASS 20—FURNITURE AND ARTICLES NOT OTHERWISE CLASSIFIED

FOR FURNITURE, NAMELY, ARCHIVING AND STORAGE STANDS, CONSOLES, TABLETS AND FRAMES FOR HOLDING ELECTRONIC APPARATUS, ELECTRONIC DATA CARRIERS AND DATA MEMORIES, ELECTRONIC APPARATUS, EQUIPMENT MODULES AND FLOPPY DISCS (U.S. CLS. 2, 13, 22, 25, 32 AND 50).
BERNICE MIDDLETON, EXAMINING ATTORNEY

SN 79-026.029. FERRARI S.P.A., ITALY, FILED 5-5-2006.

FERRARI FIORANO

PRIORITY DATE OF 2-3-2006 IS CLAIMED.
OWNER OF INTERNATIONAL REGISTRATION 0890762 DATED 5-5-2006, EXPIRES 5-5-2016.
OWNER OF U.S. REG. NOS. 862,632, 2,629,713 AND OTHERS.

CLASS 12—VEHICLES

FOR AUTOMOBILES AND STRUCTURAL PARTS THEREOF (U.S. CLS. 19, 21, 23, 31, 35 AND 44).

CLASS 28—TOYS AND SPORTING GOODS

FOR GAMES AND PLAYTHINGS, NAMELY, BOARD GAMES, SCALE TOY LAND MOTOR VEHICLES, HAND HELD UNITS FOR PLAYING VIDEO GAMES, SLEIGHS, STRUCTURES CONSTRUCTION TOYS AND CONNECTING LINKS FOR USE WITH CONSTRUCTION TOYS, TOY CONSTRUCTION SETS COMPRISED OF BLOCKS, DOLLS, REMOTE CONTROLLED TOY CARS, SOFT SCULPTURE PLUSH TOYS, PLAYING CARDS, PUZZLES, BEECH WOOD ROCKING HORSES, CONSTRUCTION SETS MADE UP OF BARS AND SPHERES THAT CAN BE LINKED MAGNETICALLY TO FORM THREE DIMENSIONAL STRUCTURES, TOY PEDAL KARTS FOR KIDS; GYMNASIAC AND SPORTING ARTICLES NOT INCLUDED IN OTHER CLASSES, NAMELY BAGS SPECIALLY ADAPTED FOR SPORTS EQUIPMENT IN THE NATURE OF TENNIS BAGS, GOLF BAGS AND GOLF POUCHES, GOLF CLUBS, TENNIS RACKETS, BOBSLEDS, SKIS, SNOWBOARDS (U.S. CLS. 22, 23, 38 AND 50).
LYDIA BELZER, EXAMINING ATTORNEY

SN 79-026.430. SENZ TECHNOLOGIES B.V., NETHERLANDS, FILED 7-7-2006.

SENZ

THE MARK CONSISTS OF STANDARD CHARACTERS WITHOUT CLAIM TO ANY PARTICULAR FONT, STYLE, SIZE, OR COLOR.

PRIORITY DATE OF 1-30-2006 IS CLAIMED.
OWNER OF INTERNATIONAL REGISTRATION 0891967 DATED 7-7-2006, EXPIRES 7-7-2016.

CLASS 18—LEATHER GOODS

FOR LEATHER AND IMITATIONS OF LEATHER, AND GOODS MADE OF THESE MATERIALS AND NOT INCLUDED IN OTHER CLASSES, NAMELY, LEATHER BRIEFCASES, LEATHER BAGS, LEATHER HANDBAGS, LEATHER BAGS FOR MERCHANDISE PACKAGING, LEATHER CASES, LEATHER SUITCASES, TRAVELLING CASES OF LEATHER, LEATHER PURSES, LEATHER SHOPPING BAGS, POUCHES OF LEATHER, LEATHER WALLETS, LEATHER BOXES FOR STORING GREETING CARDS, LEATHER KEYCASES, LEATHER CASES FOR KEYS, LEATHER KEY CHAINS, LEATHER FOR FURNITURE, LEATHER FOR HARNESSSES, LEATHER FOR SHOES, LEATHER SOLD IN BULK, LEATHER STRAPS, LEATHER THREAD, LEATHER POUCHES FOR HOLDING DISPOSABLE BAGS TO PLACE PET WASTE IN, TANNED LEATHER, LEATHER THONGS; ANIMAL SKINS, HIDES; TRUNKS AND TRAVELLING BAGS; UMBRELLAS, PARASOLS AND WALKING STICKS; WHIPS, HARNESS AND SADDLERY (U.S. CLS. 1, 2, 3, 22 AND 41).

CLASS 22—CORDAGE AND FIBERS

FOR ROPES, STRING, BUTTERFLY NETS, FISHING NETS, TENTS, AWNINGS, TARPAULINS, SAILS, SACKS AND BAGS FOR THE TRANSPORTATION OR STORAGE OF MATERIALS IN BULK; PADDING AND STUFFING MATERIALS NOT OF RUBBER, PAPER OR PLASTICS; RAW FIBROUS TEXTILE MATERIALS (U.S. CLS. 1, 2, 7, 19, 22, 42 AND 50).

LYDIA BELZER, EXAMINING ATTORNEY

SN 79-026,431. SENZ TECHNOLOGIES B.V., NETHERLANDS, FILED 7-7-2006.



PRIORITY DATE OF 1-30-2006 IS CLAIMED.
OWNER OF INTERNATIONAL REGISTRATION 0891968
DATED 7-7-2006, EXPIRES 7-7-2016.

CLASS 18—LEATHER GOODS

FOR LEATHER AND IMITATIONS OF LEATHER, AND GOODS MADE OF THESE MATERIALS AND NOT INCLUDED IN OTHER CLASSES, NAMELY, LEATHER BRIEFCASES, LEATHER BAGS, LEATHER HANDBAGS, LEATHER BAGS FOR MERCHANDISE PACKAGING, LEATHER CASES, LEATHER SUITCASES, TRAVELLING CASES OF LEATHER, LEATHER PURSES, LEATHER SHOPPING BAGS, POUCHES OF LEATHER, LEATHER WALLETS, LEATHER BOXES FOR STORING GREETING CARDS, LEATHER KEYCASES, LEATHER CASES FOR KEYS, LEATHER KEY CHAINS, LEATHER FOR FURNITURE, LEATHER FOR HARNESSSES, LEATHER FOR SHOES, LEATHER SOLD IN BULK, LEATHER STRAPS, LEATHER THREAD, LEATHER POUCHES FOR HOLDING DISPOSABLE BAGS TO PLACE PET WASTE IN, TANNED LEATHER, LEATHER THONGS; ANIMAL SKINS, HIDES; TRUNKS AND TRAVELLING BAGS; UMBRELLAS, PARASOLS AND WALKING STICKS; WHIPS, HARNESS AND SADDLERY (U.S. CLS. 1, 2, 3, 22 AND 41).

CLASS 22—CORDAGE AND FIBERS

FOR ROPES, STRING, BUTTERFLY NETS, FISHING NETS, TENTS, AWNINGS, TARPAULINS, SAILS, SACKS AND BAGS FOR THE TRANSPORTATION OR STORAGE OF MATERIALS IN BULK; PADDING AND STUFFING MATERIALS NOT OF RUBBER, PAPER OR PLASTICS; RAW FIBROUS TEXTILE MATERIALS (U.S. CLS. 1, 2, 7, 19, 22, 42 AND 50).

LYDIA BELZER, EXAMINING ATTORNEY

SN 79-026,692. CONFERENCE ONLINE PTY LTD, VARSITY LAKES, AUSTRALIA, FILED 1-27-2006.



PRIORITY DATE OF 7-28-2005 IS CLAIMED.
OWNER OF INTERNATIONAL REGISTRATION 0892779
DATED 1-27-2006, EXPIRES 1-27-2016.

NO CLAIM IS MADE TO THE EXCLUSIVE RIGHT TO USE "CONFERENCE ONLINE", APART FROM THE MARK AS SHOWN.

CLASS 9—ELECTRICAL AND SCIENTIFIC APPARATUS

FOR PRERECORDED AND DOWNLOADABLE ONLINE COMPUTER SOFTWARE FOR THE ARRANGING, CONDUCTING AND ORGANIZATION OF EVENTS, SEMINARS AND CONFERENCES IN THE FIELD OF EVENT AND PROJECT MANAGEMENT; PRERECORDED AND DOWNLOADABLE ONLINE COMPUTER PROGRAMS FOR ARRANGING, CONDUCTING AND ORGANIZATION OF EVENTS, SEMINARS AND CONFERENCES IN THE FIELD OF EVENT AND PROJECT MANAGEMENT; COMPUTER FIRMWARE FOR ARRANGING, CONDUCTING AND ORGANIZATION OF EVENTS, SEMINARS AND CONFERENCES IN THE FIELD OF EVENT AND PROJECT MANAGEMENT; COMPUTER HARDWARE, HAND HELD COMPUTERS, WEARABLE COMPUTERS; PRE-RECORDED MEDIA NAMELY CDS, DVDS, PRE-RECORDED SMART CARDS, MAGNETIC TAPES, CASSETTE TAPES, VIDEO DISKS, VIDEO TAPES AND FILMS FOR THE REPRODUCTION AND VIEWING OF SOUND, IMAGES, TEXT AND COMPUTER GENERATED SPECIAL EFFECTS FEATURING PRESENTATIONS AND CONFERENCES ON A WIDE VARIETY OF TOPICS; PRERECORDED VIDEO RECORDINGS FEATURING LIVE EVENTS, PRESENTATIONS AND CONFERENCES ON A WIDE VARIETY OF TOPICS; VIDEO DISKS AND VIDEO TAPES WITH RECORDED ANIMATED CARTOONS; ELECTRONIC CAMERAS AND APPARATUS FOR VIEWING ELECTRONIC IMAGES FROM SUCH CAMERAS, NAMELY, OPTICAL DISC PLAYERS; PRE-RECORDED ELECTRONIC AND DIGITAL AMUSEMENTS ON VIDEO TAPES, GAMES CARTRIDGES, CD ROMS, DVDS AND RECORDINGS OF OTHERS FEATURING PRESENTATIONS AND CONFERENCES ON A WIDE VARIETY OF TOPICS; SOUND, TEXT AND VIDEO RECORDINGS OF OTHERS FEATURING LIVE EVENTS, PRESENTATIONS AND CONFERENCES ON A WIDE VARIETY OF TOPICS; CINEMATOGRAPHIC AND EXPOSED PHOTOGRAPHIC FILMS; MOTION PICTURE FILMS AND VIDEOTAPES FEATURING LIVE EVENTS, PRESENTATIONS AND CONFERENCES ON A WIDE VARIETY OF TOPICS PREPARED FOR OTHERS; PRE-

RECORDED COMPUTER SOFTWARE FOR USE IN RELATION TO THE GENERATION OF SPECIAL EFFECTS; DECORATIVE REFRIGERATOR MAGNETS; SUNGLASSES, EYEGLASSES, AND THEIR CASES; AUDIO-VISUAL APPARATUS, NAMELY COMPUTERS, COMPUTING VISUAL DISPLAY UNITS, IMAGE PROJECTORS, FILM PROJECTORS AND TELEVISIONS FOR VIEWING LIVE AND PRE-RECORDED SOUND, IMAGES, TEXT AND COMPUTER GENERATED SPECIAL EFFECTS; DOWNLOADABLE ELECTRONIC PUBLICATIONS IN THE NATURE OF BOOKS AND NEWSLETTERS IN THE FIELD OF EVENTS, SEMINARS, CONFERENCES ON A WIDE VARIETY OF TOPICS, BUSINESS SERVICES AND FINANCIAL SERVICES; AND PRINTED INSTRUCTIONAL MATERIALS SOLD AS A UNIT FOR ALL THE FOREGOING (U.S. CLS. 21, 23, 26, 36 AND 38).

CLASS 35—ADVERTISING AND BUSINESS

FOR COMPILATION, SYSTEMATIZATION, AND PROVISION OF INFORMATION IN A DATABASE, NAMELY SELF REGISTERING SERVICE PROVIDER DIRECTORIES; PROVISION OF BUSINESS ONLINE DATA AND INFORMATION SERVICES WITH ONLINE E-COMMERCE SELF MAINTAINING REGISTRATION MANAGEMENT SYSTEMS; PUBLICITY AND SALES PROMOTION SERVICES; BUSINESS ADMINISTRATION, MANAGEMENT AND OFFICE FUNCTIONS; MARKET RESEARCH; CUSTOMER LOYALTY SERVICES AND CUSTOMER CLUB SERVICES; FOR COMMERCIAL, PROMOTIONAL AND/OR ADVERTISING PURPOSES AND PROMOTIONAL SALES INCENTIVE PROGRAMS; CUSTOMER SUPPORT SERVICES IN THE FIELD OF EVENT AND PROJECT MANAGEMENT; PUBLIC OPINION POLLING; COMPILATION, MAINTENANCE AND RENTAL OF DATABASES CONSISTING OF DIRECTORIES AND MAILING LISTS; GENERAL BUSINESS NETWORKING REFERRAL SERVICES, NAMELY, PROMOTING THE GOODS AND SERVICES OF OTHERS BY PASSING BUSINESS LEADS AND REFERRALS AMONG GROUP MEMBERS; PROMOTING THE GOODS AND SERVICES OF OTHERS THROUGH SEARCH ENGINE REFERRAL TRAFFIC ANALYSIS AND REPORTING; TELEPHONE ORDER-TAKING SERVICES FOR OTHERS; COMPUTERIZED ON-LINE ORDERING FEATURING GENERAL MERCHANDISE AND GENERAL CONSUMER GOODS; DIRECT MAIL ADVERTISING; PLANNING AND CONDUCTING OF COMMERCIAL TRADE FAIRS FOR ECONOMIC OR ADVERTISING PURPOSES IN THE FIELD OF EVENTS, CONFERENCES, SEMINARS, BUSINESS SERVICES, FRANCHISE SERVICES AND FINANCIAL SERVICES; ARRANGING GOODS OR SERVICES PRICE QUOTATIONS FOR OTHERS; EFFICIENCY EXPERT SERVICES; EXCHANGE SERVICES, NAMELY BARTERING OF GOODS FOR OTHERS; BUSINESS ADMINISTRATION; ADMINISTRATION OF BUSINESS PAYROLL OF OTHERS; ADMINISTRATION OF PATIENT REIMBURSEMENT PLANTS; FRANCHISE SERVICES, NAMELY, OFFERING TECHNICAL AND BUSINESS MANAGEMENT ASSISTANCE IN THE ESTABLISHMENT AND OPERATION OF EVENTS, CONFERENCES AND SEMINARS; HUMAN RESOURCES MANAGEMENT; COMPUTERIZED TRACKING AND TRACING OF PEOPLE AND GOODS IN TRANSIT; BUSINESS MANAGEMENT SERVICES, NAMELY, MANAGING LOGISTICS, REVERSE LOGISTICS, SUPPLY CHAIN SERVICES, SUPPLY CHAIN VISIBILITY AND SYNCHRONIZATION, SUPPLY AND DEMAND FORECASTING AND PRODUCT DISTRIBUTION PROCESSES FOR OTHERS; OUTSOURCING IN THE FIELD OF EVENT AND PROJECT MANAGEMENT AND BUSINESS MANAGEMENT OF FACILITIES, RESOURCES AND STAFF, NAMELY CALL CENTRES AND SALES STAFF; PROJECT MANAGEMENT FOR OTHERS IN THE FIELD OF BUSINESS; BUSINESS INTERMEDIARY AND ADVISORY SERVICES IN THE FIELD OF SELLING PRODUCTS AND RENDERING SERVICES; PROVIDING BUSINESS INFORMATION FOR OTHERS BY ELECTRONIC MEANS AND VIA A GLOBAL COMPUTER NETWORK, ABOUT ALL OF THE AFORESAID SERVICES (U.S. CLS. 100, 101 AND 102).

CLASS 42—SCIENTIFIC AND COMPUTER SERVICES

FOR COMPUTER PROGRAMMING; DESIGN, DEVELOPMENT, ANALYSIS, IMPLEMENTATION, REPAIR, INSTALLATION, MODIFICATION, SECURITY, AND UPDATING OF COMPUTER SOFTWARE AND MULTIMEDIA PROGRAMS; CUSTOMER AND TECHNICAL SUPPORT SERVICES, NAMELY TROUBLESHOOTING OF COMPUTER SOFTWARE, MULTIMEDIA PROGRAMS AND SECURE COMPUTER SOFTWARE AND SYSTEMS PROBLEMS; DESIGN, DEVELOPMENT AND SYSTEM ANALYSIS OF COMPUTER SYSTEMS AND COMPUTER NETWORKS; COMPUTER CONSULTATION IN THE FIELD OF COMPUTER SECURITY; CUSTOMER AND TECHNICAL SUPPORT SERVICES, NAMELY TROUBLESHOOTING OF COMPUTER SYSTEMS AND COMPUTER NETWORKS PROBLEMS; PROVIDING INFORMATION ABOUT DESIGN AND DEVELOPMENT OF COMPUTER HARDWARE AND SOFTWARE; MAINTENANCE AND HOSTING OF WEBSITES; DESIGN, CREATION, HOSTING AND MAINTENANCE OF WEB PAGES AND INTRANET AND INTERNET SITES FOR OTHERS; CONVERSION OF DATA OR DOCUMENTS FROM PHYSICAL TO ELECTRONIC MEDIA; COMPUTER SERVICES, NAMELY, DATA RECOVERY SERVICES; ACCREDITATION SERVICES, NAMELY, DEVELOPING, EVALUATING, AND TESTING STANDARDS FOR EVENTS, CONFERENCES, AND SEMINARS FOR THE PURPOSE OF ACCREDITATION; CONVERSION OF DATA OR DOCUMENTS FROM PHYSICAL TO ELECTRONIC MEDIA; TECHNICAL RESEARCH, NAMELY, FEASIBILITY STUDIES; LEGAL SERVICES; ONLINE NON-DOWNLOADABLE SOFTWARE FOR USE IN RELATION TO THE GENERATION OF SPECIAL EFFECTS; CONSULTANCY SERVICES IN CONNECTION WITH THE REFERENCED SERVICES THEREWITH; PROVIDING INFORMATION ON COMPUTER TECHNOLOGY AND PROGRAMMING VIA BY ELECTRONIC MEANS AND VIA A GLOBAL COMPUTER NETWORK ABOUT ALL OF THE AFORESAID SERVICES (U.S. CLS. 100 AND 101).

MARILYN IZZI, EXAMINING ATTORNEY

SN 79-027,194. T & L REICH PTY LTD, AUSTRALIA, FILED 5-22-2006.



MAKING GOOD PRODUCTS GREAT

OWNER OF INTERNATIONAL REGISTRATION 0894121 DATED 5-22-2006, EXPIRES 5-22-2016.

NO CLAIM IS MADE TO THE EXCLUSIVE RIGHT TO USE "LASER", APART FROM THE MARK AS SHOWN.

CLASS 9—ELECTRICAL AND SCIENTIFIC APPARATUS

FOR COMPUTER ACCESSORIES, NAMELY, RECORDABLE COMPACT DISC IN CD-R, CD-RW, DVD-R, DVD-RW, DVD+R, DVD+RW FORMAT, AND 3.5" BLANK FLOPPY DISKETTES; COMPUTER HARDWARE, NAMELY, MULTIMEDIA SPEAKERS, KEYBOARD, MOUSE AND COMPUTER CABLES (U.S. CLS. 21, 23, 26, 36 AND 38).

CLASS 16—PAPER GOODS AND PRINTED MATTER

FOR PAPER AND PAPER LABELS FOR USE WITH INK JET PRINTERS (U.S. CLS. 2, 5, 22, 23, 29, 37, 38 AND 50).

JOHN DALIER, EXAMINING ATTORNEY

SN 79-027,261. PETER JAU, MÜNCHENBUCHSEE, SWITZERLAND, FILED 6-23-2006.

thierragogik

THE MARK CONSISTS OF STANDARD CHARACTERS WITHOUT CLAIM TO ANY PARTICULAR FONT, STYLE, SIZE, OR COLOR.

OWNER OF INTERNATIONAL REGISTRATION 0894344 DATED 6-23-2006, EXPIRES 6-23-2016.

CLASS 41—EDUCATION AND ENTERTAINMENT

FOR EDUCATION SERVICES, NAMELY, PROVIDING CLASSES, SEMINARS, WORKSHOPS TUTORING, AND MENTORING IN THE FIELD OF PERSONAL LIFE COACHING; TRAINING, NAMELY, TRAINING IN THE FIELD OF PERSONAL LIFE COACHING BY MEANS OF PERSONALITY-SHAPING ACTIVITIES AND SOCIALIZATION; ARRANGING AND CONDUCTING OF GUIDED NATURE TOURS (U.S. CLS. 100, 101 AND 107).

CLASS 44—MEDICAL, BEAUTY AND AGRICULTURAL SERVICES

FOR MEDICAL SERVICES; VETERINARY SERVICES; HEALTH CARE SERVICES, NAMELY, SANITARY PROGRAMS FOR HUMAN BEINGS IN THE FIELD OF WELLNESS; PROVIDING INFORMATION ABOUT BEAUTY, NAMELY, BEAUTY CARE PROGRAMS FOR HUMAN BEINGS IN THE FIELD OF WELLNESS; PSYCHOLOGICAL COUNSELING, NAMELY, THERAPY SERVICES IN THE FRAMEWORK OF A NATURAL HABITAT AND OF THE ORGANIZATION OF A THERAPEUTIC ENVIRONMENT; ANIMAL CARE SERVICES, NAMELY, ANIMAL GROOMING; AGRICULTURE, HORTICULTURE AND FORESTRY SERVICES, NAMELY, FORMING OF PARKS (U.S. CLS. 100 AND 101).

KEVIN CORWIN, EXAMINING ATTORNEY

SN 79-027,303. TRL TECHNOLOGY LIMITED, UNITED KINGDOM, FILED 5-25-2006.

BROAD SHIELD

PRIORITY DATE OF 2-2-2006 IS CLAIMED. OWNER OF INTERNATIONAL REGISTRATION 0894480 DATED 5-25-2006, EXPIRES 5-25-2016.

CLASS 9—ELECTRICAL AND SCIENTIFIC APPARATUS

FOR DATA COMMUNICATIONS APPARATUS, NAMELY: RADIO FREQUENCY WAVEFORM GENERATORS; OPTICAL CARRIER WAVEFORM GENERATORS; ELECTRONIC SIGNAL PROCESSORS; RADIOS; RADIO RECEIVERS; RADIO TRANSMITTERS; COMPUTERS; SOFTWARE FOR DATA COMMUNICATIONS; ANTENNAE; ELECTRONIC SIGNALING APPARATUS, NAMELY: RADIO FREQUENCY WAVEFORM GENERATORS; OPTICAL CARRIER WAVEFORM GENERATORS; ELECTRONIC SIGNAL PROCESSORS; RADIOS; RADIO RECEIVERS; RADIO TRANSMITTERS; COMPUTERS; SOFTWARE FOR ELECTRONIC SIGNALING; ANTENNAE; APPARATUS FOR TRANSMISSION VIA SATELLITES, NAMELY: RADIO FREQUENCY WAVEFORM GENERATORS; OPTICAL CARRIER WAVEFORM GENERATORS; ELECTRONIC SIGNAL PROCESSORS; RADIOS; RADIO RECEIVERS; RADIO TRANSMITTERS; COMPUTERS; SOFTWARE FOR SATELLITE TRANSMISSION; ANTENNAE; APPARATUS FOR USE IN DATA SIGNAL TRANSMISSIONS, NAMELY: RADIO FREQUENCY WAVEFORM GENERATORS; OPTICAL CARRIER WAVEFORM GENERATORS; ELECTRONIC SIGNAL PROCESSORS; RADIOS; RADIO RECEIVERS; RADIO TRANSMITTERS; COMPUTERS; SOFTWARE FOR DATA SIGNAL TRANSMISSION; ANTENNAE; DATA SIGNAL BLOCKING APPARATUS, NAMELY: RADIO FREQUENCY WAVEFORM GENERATORS; OPTICAL CARRIER WAVEFORM GENERATORS; ELECTRONIC SIGNAL PROCESSORS; RADIOS; RADIO RECEIVERS; RADIO TRANSMITTERS; COMPUTERS; SOFTWARE FOR DATA SIGNAL BLOCKING; ANTENNAE; AND DATA SCRAMBLING APPARATUS, NAMELY: RADIO FREQUENCY WAVEFORM GENERATORS; OPTICAL CARRIER WAVEFORM GENERATORS; ELECTRONIC SIGNAL PROCESSORS; RADIOS; RADIO RECEIVERS; RADIO TRANSMITTERS; COMPUTERS; SOFTWARE FOR DATA SCRAMBLING; ANTENNAE (U.S. CLS. 21, 23, 26, 36 AND 38).

CLASS 16—PAPER GOODS AND PRINTED MATTER

FOR PRINTED MATTER, NAMELY: PRESS RELEASES; INFORMATION LEAFLETS; BROCHURES; PAMPHLETS; ALL RELATING TO ELECTRONIC WARFARE SYSTEMS; PRINTED INSTRUCTIONAL, EDUCATIONAL AND TEACHING MATERIALS IN THE FIELD OF ELECTRONIC WARFARE (U.S. CLS. 2, 5, 22, 23, 29, 37, 38 AND 50).

DAVID I, EXAMINING ATTORNEY

SN 79-027,972. GJRATH MEDIA GROEP B.V., NETHERLANDS, FILED 3-3-2006.



PRIORITY DATE OF 1-20-2006 IS CLAIMED. OWNER OF INTERNATIONAL REGISTRATION 0896140 DATED 3-3-2006, EXPIRES 3-3-2016. "THE MARK CONSISTS OF A SILHOUETTE OF A FLOWER (LILY)."

CLASS 16—PAPER GOODS AND PRINTED MATTER

FOR PRINTED MATTER, NAMELY, BOOKS, BROCHURES, GUIDES, MANUALS, FLYERS, NEWSPAPERS, PRINTED GUIDES AND MAGAZINES IN THE FIELD OF CARS, BOATS, TRAVEL, JEWELRY, FASHION, ELECTRONICS, HOUSEWARE, FURNITURE, HEALTH, COSMETICS, LITERATURE, ARTS, BIOGRAPHY, REAL ESTATE, SPORTS, ARCHITECTURE, DESIGN, NEWS, CULINARY, BEAUTY AND LUXURY SERVICES; PHOTOGRAPHS (U.S. CLS. 2, 5, 22, 23, 29, 37, 38 AND 50).

CLASS 35—ADVERTISING AND BUSINESS

FOR ORGANIZATION OF FAIRS, EVENTS AND EXHIBITIONS FOR COMMERCIAL OR ADVERTISING PURPOSES (U.S. CLS. 100, 101 AND 102).

CLASS 41—EDUCATION AND ENTERTAINMENT

FOR PUBLICATION OF PRINTED MATTER AND ELECTRONIC PUBLICATIONS, NAMELY, BOOKS, BROCHURES, GUIDES, MANUALS, FLYERS, NEWSPAPERS AND MAGAZINES; PRODUCTION OF EDUCATIONAL AND ENTERTAINMENT RADIO AND TELEVISION PROGRAMS (U.S. CLS. 100, 101 AND 107).

EDWARD FENNESSY, EXAMINING ATTORNEY

SN 79-028,090. N.V. ORGANON, NETHERLANDS, FILED 5-4-2006.

JEMPLANON

THE MARK CONSISTS OF STANDARD CHARACTERS WITHOUT CLAIM TO ANY PARTICULAR FONT, STYLE, SIZE, OR COLOR.

PRIORITY DATE OF 11-29-2005 IS CLAIMED.

OWNER OF INTERNATIONAL REGISTRATION 0896451 DATED 5-4-2006, EXPIRES 5-4-2016.

CLASS 5—PHARMACEUTICALS

FOR MEDICINES AND PHARMACEUTICAL PREPARATIONS FOR HUMAN USE, NAMELY CONTRACEPTIVES; CONTRACEPTIVE PHARMACEUTICAL PREPARATIONS CONTAINED IN AND RELEASED FROM A CONTRACEPTIVE SUB-DERMAL IMPLANT (U.S. CLS. 6, 18, 44, 46, 51 AND 52).

CLASS 10—MEDICAL APPARATUS

FOR NON-DEGRADABLE ARTIFICIAL IMPLANT TO BE INSERTED UNDER THE SKIN FOR RELEASING HORMONES (U.S. CLS. 26, 39 AND 44).

RAMONA ORTIGA, EXAMINING ATTORNEY

SN 79-028,209. N.V. ORGANON, NETHERLANDS, FILED 5-4-2006.

EVIMPRA

THE MARK CONSISTS OF STANDARD CHARACTERS WITHOUT CLAIM TO ANY PARTICULAR FONT, STYLE, SIZE, OR COLOR.

PRIORITY DATE OF 11-29-2005 IS CLAIMED.

OWNER OF INTERNATIONAL REGISTRATION 0896841 DATED 5-4-2006, EXPIRES 5-4-2016.

CLASS 5—PHARMACEUTICALS

FOR MEDICINES AND PHARMACEUTICAL PREPARATIONS FOR HUMAN USE, NAMELY CONTRACEPTIVES; CONTRACEPTIVE PHARMACEUTICAL PREPARATIONS CONTAINED IN AND RELEASED FROM A CONTRACEPTIVE SUB-DERMAL IMPLANT (U.S. CLS. 6, 18, 44, 46, 51 AND 52).

CLASS 10—MEDICAL APPARATUS

FOR NON-DEGRADABLE ARTIFICIAL IMPLANT TO BE INSERTED UNDER THE SKIN FOR RELEASING HORMONES (U.S. CLS. 26, 39 AND 44).

RAMONA ORTIGA, EXAMINING ATTORNEY

SN 79-028,211. N.V. ORGANON, NETHERLANDS, FILED 5-4-2006.

NEXPLANON

THE MARK CONSISTS OF STANDARD CHARACTERS WITHOUT CLAIM TO ANY PARTICULAR FONT, STYLE, SIZE, OR COLOR.

PRIORITY DATE OF 11-29-2005 IS CLAIMED.

OWNER OF INTERNATIONAL REGISTRATION 0896843 DATED 5-4-2006, EXPIRES 5-4-2016.

CLASS 5—PHARMACEUTICALS

FOR MEDICINES AND PHARMACEUTICAL PREPARATIONS FOR HUMAN USE, NAMELY CONTRACEPTIVES; CONTRACEPTIVE PHARMACEUTICAL PREPARATIONS CONTAINED IN AND RELEASED FROM A CONTRACEPTIVE SUB-DERMAL IMPLANT (U.S. CLS. 6, 18, 44, 46, 51 AND 52).

CLASS 10—MEDICAL APPARATUS

FOR NON-DEGRADABLE ARTIFICIAL IMPLANT TO BE INSERTED UNDER THE SKIN FOR RELEASING HORMONES (U.S. CLS. 26, 39 AND 44).

RAMONA ORTIGA, EXAMINING ATTORNEY

SN 79-028,243. N.V. ORGANON, NETHERLANDS, FILED 5-4-2006.

ESIMPLA

THE MARK CONSISTS OF STANDARD CHARACTERS WITHOUT CLAIM TO ANY PARTICULAR FONT, STYLE, SIZE, OR COLOR.

PRIORITY DATE OF 11-29-2005 IS CLAIMED.

OWNER OF INTERNATIONAL REGISTRATION 0896920 DATED 5-4-2006, EXPIRES 5-4-2016.

CLASS 5—PHARMACEUTICALS

FOR MEDICINES AND PHARMACEUTICAL PREPARATIONS FOR HUMAN USE, NAMELY CONTRACEPTIVES; CONTRACEPTIVE PHARMACEUTICAL PREPARATIONS CONTAINED IN AND RELEASED FROM A CONTRACEPTIVE SUB-DERMAL IMPLANT (U.S. CLS. 6, 18, 44, 46, 51 AND 52).

CLASS 10—MEDICAL APPARATUS

FOR NON-DEGRADABLE ARTIFICIAL IMPLANT TO BE INSERTED UNDER THE SKIN FOR RELEASING HORMONES (U.S. CLS. 26, 39 AND 44).

RAMONA ORTIGA, EXAMINING ATTORNEY

SN 79-028,244. N.V. ORGANON, NETHERLANDS, FILED 5-4-2006.

X-PLANON

THE MARK CONSISTS OF STANDARD CHARACTERS WITHOUT CLAIM TO ANY PARTICULAR FONT, STYLE, SIZE, OR COLOR.

PRIORITY DATE OF 11-29-2005 IS CLAIMED.

OWNER OF INTERNATIONAL REGISTRATION 0896921 DATED 5-4-2006, EXPIRES 5-4-2016.

CLASS 5—PHARMACEUTICALS

FOR MEDICINES AND PHARMACEUTICAL PREPARATIONS FOR HUMAN USE, NAMELY CONTRACEPTIVES; CONTRACEPTIVE PHARMACEUTICAL PREPARATIONS CONTAINED IN AND RELEASED FROM A CONTRACEPTIVE SUB-DERMAL IMPLANT (U.S. CLS. 6, 18, 44, 46, 51 AND 52).

CLASS 10—MEDICAL APPARATUS

FOR NON-DEGRADABLE ARTIFICIAL IMPLANT TO BE INSERTED UNDER THE SKIN FOR RELEASING HORMONES (U.S. CLS. 26, 39 AND 44).

RAMONA ORTIGA, EXAMINING ATTORNEY

SN 79-028,322. GITTE O. BRÆNDGAARD, DENMARK, AND PETER ANDERSEN, DENMARK, AND POUL VILLADSEN, DENMARK, FILED 7-10-2006.

BELLA SARA

THE MARK CONSISTS OF STANDARD CHARACTERS WITHOUT CLAIM TO ANY PARTICULAR FONT, STYLE, SIZE, OR COLOR.

PRIORITY DATE OF 5-10-2006 IS CLAIMED.

OWNER OF INTERNATIONAL REGISTRATION 0896999 DATED 7-10-2006, EXPIRES 7-10-2016.

THE ENGLISH TRANSLATION OF THE WORD BELLA IN THE MARK IS BEAUTIFUL

CLASS 9—ELECTRICAL AND SCIENTIFIC APPARATUS

FOR COMPUTER GAME SOFTWARE; DOWNLOADABLE SOFTWARE FOR COMPUTER GAMES (U.S. CLS. 21, 23, 26, 36 AND 38).

CLASS 16—PAPER GOODS AND PRINTED MATTER

FOR PAPER AND GOODS MADE OF PAPER, NAMELY, TRADING CARDS, CARDS FOR COLLECTING, PHOTOGRAPHS, DOCUMENT PORTFOLIOS, AND PRINTED MATTER, NAMELY, PAMPHLETS AND MAGAZINES IN THE FIELD OF CHILDREN'S CONTENT; WRITING INSTRUMENTS (U.S. CLS. 2, 5, 22, 23, 29, 37, 38 AND 50).

CLASS 18—LEATHER GOODS

FOR LEATHER AND IMITATION LEATHER BAGS AND SMALL BACKPACKS; CARRY-ALL BAGS IN THE FORM OF TEDDY BEARS (U.S. CLS. 1, 2, 3, 22 AND 41).

CLASS 24—FABRICS

FOR BATH LINEN, TOWELS OF TEXTILE, BEDSPREADS, BED CLOTHES, NAMELY, BED BLANKETS AND BED LINEN (U.S. CLS. 42 AND 50).

CLASS 25—CLOTHING

FOR ARTICLES OF CLOTHING FOR CHILDREN, NAMELY SWEAT SHIRTS, T-SHIRTS, CAPS, SCARVES AND BANDANAS (U.S. CLS. 22 AND 39).

CLASS 28—TOYS AND SPORTING GOODS

FOR GAMES AND PLAYTHINGS, NAMELY PLAYING CARDS AND TRADING CARD GAMES; TEDDY BEARS; PLUSH TOYS IN THE FORM OF HORSES; JIGSAW PUZZLES (U.S. CLS. 22, 23, 38 AND 50).

CLASS 35—ADVERTISING AND BUSINESS

FOR THE BRINGING TOGETHER, INCLUDING ON A WORLDWIDE NETWORK, FOR THE BENEFIT OF OTHERS, OF A VARIETY OF GOODS IN CONNECTION WITH GAMES AND TOYS, ENABLING CUSTOMERS TO CONVENIENTLY VIEW AND PURCHASE THOSE GOODS (U.S. CLS. 100, 101 AND 102).

CLASS 41—EDUCATION AND ENTERTAINMENT

FOR ENTERTAINMENT SERVICES, NAMELY, PROVIDING ON-LINE COMPUTER GAMES (U.S. CLS. 100, 101 AND 107).

MYRIAH HABEEB, EXAMINING ATTORNEY

SN 79-028,442. LEBLOND MICHÈLE, FRANCE, AND MANDINAUD ERIC, FRANCE, FILED 7-27-2006.

takado

THE MARK CONSISTS OF STANDARD CHARACTERS WITHOUT CLAIM TO ANY PARTICULAR FONT, STYLE, SIZE, OR COLOR.

OWNER OF INTERNATIONAL REGISTRATION 0897346 DATED 7-27-2006, EXPIRES 7-27-2016.

CLASS 28—TOYS AND SPORTING GOODS

FOR BOARD GAMES, CARD GAMES, TRADING CARDS GAMES, DICE GAMES, ROLE PLAYING GAMES, PROMOTIONAL GAME CARDS, PLAYING CARDS; PARLOUR GAMES, CHILDREN'S MULTIPLE ACTIVITY TOYS, MECHANICAL TOYS, DOMINOES, COUNTERS FOR GAMES; AMUSEMENT GAME MACHINES, COIN OPERATED VIDEO GAMES, ARCADE TYPE ELECTRONIC VIDEO GAMES (U.S. CLS. 22, 23, 38 AND 50).

CLASS 41—EDUCATION AND ENTERTAINMENT

FOR ENTERTAINMENT SERVICES NAMELY PRODUCTION AND DISTRIBUTION OF A GAME SHOW; ENTERTAINMENT SERVICES NAMELY PROVIDING ON-LINE COMPUTER GAMES; ORGANIZATION OF GAMES; ORGANIZING COMMUNITY SPORTING AND CULTURAL EVENTS; INFORMATION ON EDUCATION; PROVIDING INFORMATION ON-LINE RELATING TO COMPUTER GAMES AND COMPUTER ENHANCEMENTS FOR GAMES; PROVIDING RECREATION FACILITIES; ORGANIZATION OF CULTURAL AND EDUCATIONAL EXHIBITIONS FEATURING GAMES; PROVIDING COMPUTER GAMES ONLINE ON A COMPUTER NETWORK, PROVIDING ON-LINE CARD GAMES, GAMBLING SERVICES, PRODUCTION OF RADIO AND TELEVISION PROGRAMS, PRODUCTION OF DVD, VIDEOTAPES, TELEVISION PROGRAMS FEATURING GAMES (U.S. CLS. 100, 101 AND 107).

JOANNA DUKOVIC, EXAMINING ATTORNEY

SN 79-028,498. GITTE O. BRÆNDGAARD, DENMARK, AND PETER ANDERSEN, DENMARK, AND POUL VILLADSEN, DENMARK, FILED 7-10-2006.

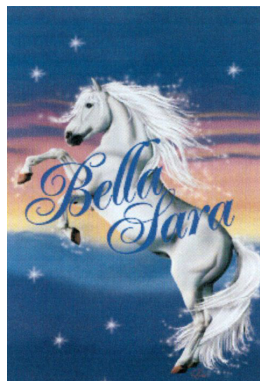

PRIORITY DATE OF 6-16-2006 IS CLAIMED.
OWNER OF INTERNATIONAL REGISTRATION 0897477 DATED 7-10-2006, EXPIRES 7-10-2016.

"THE COLOR(S) BLUE, PINK, ORANGE, YELLOW, BROWN, LIGHT BLUE, GREY, BLACK AND WHITE IS/ ARE CLAIMED AS A FEATURE OF THE MARK."

"THE MARK CONSISTS OF A REPRESENTATION OF A HORSE AGAINST A SKY WITH THE WORDING BELLA SARA. THE COLOR BLUE APPEARS IN THE BACKGROUND OF THE SKY AT THE TOP AND BOTTOM AND IN THE TERMS BELLA SARA; THE COLOR PINK APPEARS IN THE SKY AT THE TOP BENEATH THE BLUE; THE COLOR ORANGE APPEARS IN THE SKY BENEATH THE COLOR PINK; THE COLOR YELLOW APPEARS IN THE SKY BENEATH THE COLOR ORANGE; THE COLOR BROWN APPEARS IN THE HORSE'S HOOVES; THE COLOR LIGHT BLUE APPEARS IN THE SKY BENEATH THE COLOR YELLOW; THE COLOR GREY APPEARS IN THE SHADING ON THE HORSE; THE COLOR BLACK APPEARS IN THE HORSE'S MOUTH, ON THE HORSE'S HOOVES, ON THE HORSE'S EYES, AND IN THE SHADOWING ON THE HORSE; THE COLOR WHITE APPEARS IN THE HORSE AND IN THE STARS IN THE SKY BACKGROUND."

THE ENGLISH TRANSLATION OF THE WORD BELLA IN THE MARK IS BEAUTIFUL

SN 79-028,491. GLUCOSCAR INTERNATIONAL PTE LTD, SINGAPORE, FILED 8-10-2006.



PRIORITY DATE OF 7-14-2006 IS CLAIMED.
OWNER OF INTERNATIONAL REGISTRATION 0897460 DATED 8-10-2006, EXPIRES 8-10-2016.

CLASS 5—PHARMACEUTICALS

FOR HERBAL TEAS FOR MEDICAL PURPOSE AND HEALTH SUPPLEMENT TEAS FOR MEDICAL PURPOSE (U.S. CLS. 6, 18, 44, 46, 51 AND 52).

CLASS 30—STAPLE FOODS

FOR TEA AND TEA BASED BEVERAGES (U.S. CL. 46).
ELI HELLMAN, EXAMINING ATTORNEY

CLASS 9—ELECTRICAL AND SCIENTIFIC APPARATUS

FOR COMPUTER GAME SOFTWARE; DOWNLOADABLE SOFTWARE FOR COMPUTER GAMES (U.S. CLS. 21, 23, 26, 36 AND 38).

CLASS 16—PAPER GOODS AND PRINTED MATTER

FOR PAPER AND GOODS MADE OF PAPER, NAMELY, TRADING CARDS, CARDS FOR COLLECTING, PHOTOGRAPHS, DOCUMENT PORTFOLIOS, AND PRINTED MATTER, NAMELY, PAMPHLETS AND MAGAZINES IN THE FIELD CHILDREN'S CONTENT; WRITING INSTRUMENTS (U.S. CLS. 2, 5, 22, 23, 29, 37, 38 AND 50).

CLASS 18—LEATHER GOODS

FOR LEATHER AND IMITATION LEATHER BAGS AND SMALL BACKPACKS; CARRY-ALL BAGS IN THE FORM OF TEDDY BEARS (U.S. CLS. 1, 2, 3, 22 AND 41).

CLASS 24—FABRICS

FOR BATH LINEN, TOWELS OF TEXTILE, BEDSPREADS, BED CLOTHES, NAMELY, BED BLANKETS AND BED LINEN (U.S. CLS. 42 AND 50).

CLASS 25—CLOTHING

FOR ARTICLES OF CLOTHING FOR CHILDREN, NAMELY SWEAT SHIRTS, T-SHIRTS, CAPS, SCARVES AND BANDANAS (U.S. CLS. 22 AND 39).

CLASS 28—TOYS AND SPORTING GOODS

FOR GAMES AND PLAYTHINGS, NAMELY PLAYING CARDS AND TRADING CARD GAMES; TEDDY BEARS; PLUSH TOYS IN THE FORM OF HORSES; JIGSAW PUZZLES (U.S. CLS. 22, 23, 38 AND 50).

CLASS 35—ADVERTISING AND BUSINESS

FOR THE BRINGING TOGETHER, INCLUDING ON A WORLDWIDE NETWORK, FOR THE BENEFIT OF OTHERS, OF A VARIETY OF GOODS IN CONNECTION WITH GAMES AND TOYS, ENABLING CUSTOMERS TO CONVENIENTLY VIEW AND PURCHASE THOSE GOODS (U.S. CLS. 100, 101 AND 102).

CLASS 41—EDUCATION AND ENTERTAINMENT

FOR ENTERTAINMENT SERVICES, NAMELY, PROVIDING ON-LINE COMPUTER GAMES (U.S. CLS. 100, 101 AND 107).

MYRIAH HABEEB, EXAMINING ATTORNEY

SN 79-028,884. AVERAHAMI, BOAZ, NETHERLANDS, FILED 9-13-2006.

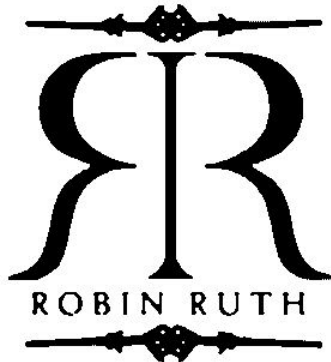

OWNER OF INTERNATIONAL REGISTRATION 0898455 DATED 9-13-2006, EXPIRES 9-13-2016.

THE NAME SHOWN IN THE MARK DOES NOT IDENTIFY A PARTICULAR LIVING INDIVIDUAL.

CLASS 18—LEATHER GOODS

FOR LEATHER AND IMITATIONS OF LEATHER, AND GOODS MADE OF THESE MATERIALS AND NOT INCLUDED IN OTHER CLASSES, NAMELY, PURSES, BOOK BAGS, SHOULDER BAGS, CASUAL BAGS, SHOPPING BAGS, ALL-PURPOSE SPORTS BAGS, ATHLETIC BAGS, BEACH BAGS, TOILET BAGS SOLD EMPTY; BEAUTY CASES SOLD EMPTY; UMBRELLAS (U.S. CLS. 1, 2, 3, 22 AND 41).

CLASS 25—CLOTHING

FOR CLOTHING, NAMELY, PANTS, SHIRTS, SKIRTS, T-SHIRTS, SHORTS, UNDERWEAR, SOCKS, TOPS, JERSEYS, TIES, NECKTIES; FOOTWEAR, HEADGEAR, NAMELY, WOOLLY HATS, BASEBALL CAPS; SHAWLS (U.S. CLS. 22 AND 39).

RON FAIRBANKS, EXAMINING ATTORNEY

SN 79-028,968. G.S. UNLIMITED ENTERPRISES PTY LTD, HASTINGS, AUSTRALIA, FILED 8-10-2006.

THE OTHERS JUST CAN'T

THE MARK CONSISTS OF STANDARD CHARACTERS WITHOUT CLAIM TO ANY PARTICULAR FONT, STYLE, SIZE, OR COLOR.

PRIORITY DATE OF 2-23-2006 IS CLAIMED.

OWNER OF INTERNATIONAL REGISTRATION 0898685 DATED 8-10-2006, EXPIRES 8-10-2016.

CLASS 12—VEHICLES

FOR VEHICLES, NAMELY CARS, TRUCKS, VANS, MOTORCYCLES AND MOTORIZED SCOOTERS; WATERCRAFT, NAMELY, BOATS (U.S. CLS. 19, 21, 23, 31, 35 AND 44).

CLASS 35—ADVERTISING AND BUSINESS

FOR RETAIL STORE SERVICES, MAIL ORDER SERVICES, AND ON-LINE RETAIL STORE SERVICES, THE FOREGOING FEATURING VEHICLES, CARS, TRUCKS, VANS, MOTORCYCLES, MOTORIZED SCOOTERS, BOATS, WATERCRAFT, POWER TOOLS, ELECTRIC DRILLS, ELECTRIC SAWS, OUTDOOR EQUIPMENT, TENTS, BACKPACKS, OUTDOOR COOKING EQUIPMENT, CLOTHING, COATS, TROUSERS, TOPS, SHOES, BOOTS, HEADGEAR, AND SPORTING EQUIPMENT; ADVERTISING AND PROMOTION SERVICES RELATING TO VEHICLES, CARS, TRUCKS, VANS, MOTORCYCLES, MOTORIZED SCOOTERS, BOATS, WATERCRAFT, POWER TOOLS, ELECTRIC DRILLS, ELECTRIC SAWS, OUTDOOR EQUIPMENT, TENTS, BACKPACKS, OUTDOOR COOKING EQUIPMENT, CLOTHING, COATS, TROUSERS, TOPS, SHOES, BOOTS, HEADGEAR, AND SPORTING EQUIPMENT (U.S. CLS. 100, 101 AND 102).

ELI HELLMAN, EXAMINING ATTORNEY

SN 79-028,994. AO ECS - ASSOCIATION OF EUROPEAN COELIAC SOCIETIES; AISBL, BRUSSELS, BELGIUM, FILED 3-23-2006.



PRIORITY DATE OF 9-26-2005 IS CLAIMED.

OWNER OF INTERNATIONAL REGISTRATION 0898759 DATED 3-23-2006, EXPIRES 3-23-2016.

THE MARK CONSISTS OF A GRAIN STALK PLACED DIAGONALLY FROM TOP RIGHT TO BOTTOM LEFT AND A WAVY BAND PLACED DIAGONALLY FROM TOP LEFT TO BOTTOM RIGHT TO CREATE THE IMPRESSION OF THE LETTER "X" ALL INSIDE A CIRCLE.

CLASS 5—PHARMACEUTICALS

FOR PHARMACEUTICAL PRODUCTS, NAMELY, PHARMACEUTICAL ANTI-ALLERGIC PREPARATIONS AND SUBSTANCES, PHARMACEUTICAL PREPARATIONS FOR THE TREATMENT OF PERSONS ALLERGIC TO GLUTEN, VITAMIN AND MINERAL PREPARATIONS FOR USE AS INGREDIENTS IN THE FOOD AND PHARMACEUTICAL INDUSTRY, YEAST OR YEAST EXTRACTS FOR MEDICAL, VETERINARY OR PHARMACEUTICAL PURPOSES, PHARMACEUTICALS FOR THE TREATMENT OF CELIAC DISEASES, PHARMACEUTICALS FOR THE TREATMENT OF DERMATITIS, PHARMACEUTICALS FOR THE TREATMENT OF ALLERGIES, AND MORE PARTICULARLY FOR THE TREATMENT OF ALLERGY TO GLUTEN; PHARMACEUTICAL PREPARATIONS FOR TREATING SKIN DISORDERS, PHARMACEUTICAL PREPARATIONS FOR USE IN DERMATOLOGY; HYGIENIC PRODUCTS, NAMELY, DISINFECTANTS FOR HYGIENIC PURPOSES; DIETETIC SUBSTANCES ADAPTED FOR MEDICAL USE, GLUTEN-FREE FOOD FOR BABIES (U.S. CLS. 6, 18, 44, 46, 51 AND 52).

CLASS 29—MEATS AND PROCESSED FOODS

FOR MEAT, FISH, POULTRY AND GAME; MEAT EXTRACTS; PRESERVED, DRIED AND COOKED FRUITS AND VEGETABLES; JELLIES, JAMS, COMPOTES; EGGS, MILK, AND DAIRY PRODUCTS EXCLUDING ICE CREAM, ICE MILK AND FROZEN YOGURT; EDIBLE OILS AND FATS; GLUTEN-FREE FOOD, NAMELY, BREADED MEAT, BREADED FISH, BREADED POULTRY AND BREADED GAME, MEAT CROQUETTES, FISH CROQUETTES, POULTRY CROQUETTES, HAMBURGERS (U.S. CL. 46).

CLASS 30—STAPLE FOODS

FOR COFFEE, TEA, COCOA, SUGAR, RICE, TAPIOCA, SAGO, COFFEE SUBSTITUTES; FLOURS AND CEREALS BASED SNACK FOODS, BREAD, PASTRIES AND CONFECTIONERY, CHIPS FOR BAKING; FRUIT ICES; HONEY, TREACLE; YEAST, BAKING POWDER; SALT, MUSTARD; VINEGAR, SAUCES, GLUTEN-FREE CONDIMENTS, NAMELY, KETCHUP, MAYONNAISE, PEPPER SAUCE, PICKLED GINGER, PIMIENTO, SOYA BEAN PASTE; SPICES; ICE; GLUTEN-FREE FOOD, NAMELY, PIZZA, PASTA, PASTRIES, COOKIES, BISCUITS, CEREALS, NAMELY BREAKFAST CEREALS AND PROCESSED CEREALS, AND FLOURS BASED SNACK FOOD, BREAD, BREADCRUMBS (U.S. CL. 46).

CLASS 41—EDUCATION AND ENTERTAINMENT

FOR ORGANIZING COMMUNITY SPORTING AND CULTURAL EVENTS; EDUCATIONAL SERVICES, NAMELY, ORGANIZATION AND CONDUCTING OF COLLOQUIUMS, CONFERENCES, CONGRESSES, SEMINARS, SYMPOSIUMS, IN THE FIELDS OF CELIAC ILLNESSES, DERMATITIS HERPETIFORMIS AND GLUTEN INTOLERANCE; ORGANIZATION OF EXHIBITIONS FOR CULTURAL AND EDUCATIONAL PURPOSES, IN PARTICULAR IN CONNECTION WITH CELIAC ILLNESSES, DERMATITIS HERPETIFORMIS AND GLUTEN INTOLERANCE; PUBLICATION OF BOOKS; PUBLICATION OF TEXTS; ELECTRONIC PUBLISHING OF ON-LINE BOOKS AND PERIODICALS; PROVIDING NON-DOWNLOADABLE ON-LINE PUBLICATIONS IN THE NATURE OF BOOKS AND PERIODICALS IN THE FIELDS OF CELIAC ILLNESSES, DERMATITIS HERPETIFORMIS AND GLUTEN INTOLERANCE (U.S. CLS. 100, 101 AND 107).

CLASS 45—PERSONAL AND LEGAL SERVICES

FOR CONCIERGE SERVICES FOR OTHERS COMPRISING MAKING REQUESTED PERSONAL ARRANGEMENTS AND RESERVATIONS AND PROVIDING CUSTOMER-SPECIFIC INFORMATION TO MEET INDIVIDUAL NEEDS DURING JOURNEYS AND TOURS, ON BUSES, TRAINS AND AIRPLANES, IN HOTELS AND RESTAURANTS; PROVIDING PERSONAL SUPPORT SERVICES, PSYCHOLOGICAL COUNSELING, AND CASE MANAGEMENT OF EDUCATIONAL SERVICES FOR PATIENTS AND FAMILIES OF PATIENTS SUFFERING FROM CELIAC ILLNESSES, DERMATITIS HERPETIFORMIS AND GLUTEN INTOLERANCE, NAMELY, COMPANIONSHIP, HELP WITH MEDICAL FORMS, COUNSELING AND EMOTIONAL SUPPORT; PERSONAL CARE ASSISTANCE OF ACTIVITIES OF DAILY LIVING, SUCH AS BATHING AND GROOMING FOR PERSONS SUFFERING FROM DERMATITIS HERPETIFORMIS, COOKING FOR PERSONS WHO SUFFER FROM CELIAC ILLNESSES AND GLUTEN INTOLERANCE; PERSONAL SUPPORT SERVICES AND THE FOLLOW-UP OF PERSONAL SUPPORT SERVICES FOR PERSONS WHO SUFFER FROM CELIAC ILLNESSES, DERMATITIS HERPETIFORMIS OR GLUTEN INTOLERANCE (U.S. CLS. 100 AND 101).

WARREN L. OLANDRIA, EXAMINING ATTORNEY

SN 79-029,110. FIRMENICH SA, SWITZERLAND, FILED 9-1-2006.

AURATOUC

THE MARK CONSISTS OF STANDARD CHARACTERS WITHOUT CLAIM TO ANY PARTICULAR FONT, STYLE, SIZE, OR COLOR.

PRIORITY DATE OF 5-10-2006 IS CLAIMED.

OWNER OF INTERNATIONAL REGISTRATION 0899027 DATED 9-1-2006, EXPIRES 9-1-2016.

CLASS 1—CHEMICALS

FOR CHEMICAL PRODUCTS, NAMELY RAW MATERIALS INTENDED FOR USE IN THE FRAGRANCE INDUSTRY (U.S. CLS. 1, 5, 6, 10, 26 AND 46).

CLASS 3—COSMETICS AND CLEANING PREPARATIONS

FOR PERFUMES AND ESSENTIAL OILS INTENDED TO PERFUME CONSUMER PRODUCTS (U.S. CLS. 1, 4, 6, 50, 51 AND 52).

ALLISON SCHRODY, EXAMINING ATTORNEY

SN 79-029,411. PATRICK LOUBEYRE, FRANCE, FILED 9-6-2006.

VORTEX

THE MARK CONSISTS OF STANDARD CHARACTERS WITHOUT CLAIM TO ANY PARTICULAR FONT, STYLE, SIZE, OR COLOR.

OWNER OF INTERNATIONAL REGISTRATION 0899770 DATED 9-6-2006, EXPIRES 9-6-2016.

CLASS 3—COSMETICS AND CLEANING PREPARATIONS

FOR LAUNDRY BLEACH, LAUNDRY DETERGENT, LAUNDRY SOAP, LAUNDRY STARCH, LAUNDRY PRE-SOAK, GENERAL PURPOSE CLEANING, POLISHING, AND ABRASIVE LIQUIDS AND POWDERS (U.S. CLS. 1, 4, 6, 50, 51 AND 52).

CLASS 7—MACHINERY

FOR MACHINES AND MACHINE TOOLS FOR CLEANING SURFACES USING HIGH PRESSURE WATER, STEAM CLEANING MACHINES, COUPLINGS FOR MACHINES, POWER TRANSMISSION AND GEARING FOR MACHINES (U.S. CLS. 13, 19, 21, 23, 31, 34 AND 35).

CLASS 37—CONSTRUCTION AND REPAIR

FOR CLEANING AND MAINTAINING OF BUILDINGS, OFFICES, AND FLOORS, NAMELY, RESURFACING OF FACADES, DISINFECTING, EXTERMINATION OF RATS; CIVIL ENGINEERING; RENTAL OF HAND AND POWER TOOLS; RENTAL OF BUILDING EQUIPMENT, RENTAL OF BULLDOZERS (U.S. CLS. 100, 103 AND 106).

LINDA M. KING, EXAMINING ATTORNEY

SN 79-029,465. BUREAU VERITAS, REGISTRE; INTERNATIONAL DE CLASSIFICATION; DE NAVIRES ET D'AERONEFS, FRANCE, FILED 8-30-2006.

VERIPERF

THE MARK CONSISTS OF STANDARD CHARACTERS WITHOUT CLAIM TO ANY PARTICULAR FONT, STYLE, SIZE, OR COLOR.

PRIORITY DATE OF 3-20-2006 IS CLAIMED.

OWNER OF INTERNATIONAL REGISTRATION 0899915 DATED 8-30-2006, EXPIRES 8-30-2016.

CLASS 35—ADVERTISING AND BUSINESS

FOR AID IN BUSINESS MANAGEMENT; MANAGEMENT OF COMMERCIAL OR INDUSTRIAL COMPANIES; BUSINESS APPRAISALS; BUSINESS ORGANIZATION AND MANAGEMENT CONSULTING; PROFESSIONAL BUSINESS CONSULTING; BUSINESS MANAGEMENT CONSULTANCY; EFFICIENCY EXPERTS; BUSINESS INFORMATION AND ENQUIRIES; COMMERCIAL INFORMATION AGENCIES; ACCOUNTING; CHECKING ACCOUNTS, PERSONNEL MANAGEMENT CONSULTANCY, DOCUMENT REPRODUCTION, MARKET STUDY, COMPUTER FILE MANAGEMENT, DATA COMPILATION AND SYSTEMATIZATION IN A DATABASE; ECONOMIC FORECASTS (U.S. CLS. 100, 101 AND 102).

CLASS 42—SCIENTIFIC AND COMPUTER SERVICES

FOR TECHNICAL ANALYSIS OF PERFORMANCE OF COMPANIES IN THE FIELDS OF SAFETY IN THE WORKPLACE, ENVIRONMENTAL ASSESSMENT AND QUALITY CONTROL; TESTING, ANALYSIS AND EVALUATION OF THE GOODS AND SERVICES OF OTHERS FOR THE PURPOSE OF CERTIFICATION; ENGINEERING SERVICES (U.S. CLS. 100 AND 101).

DANIEL CAPSHAW, EXAMINING ATTORNEY

SN 79-029,574. IMEAS S.P.A., ITALY, FILED 9-15-2006.



PRIORITY DATE OF 6-6-2006 IS CLAIMED.
OWNER OF INTERNATIONAL REGISTRATION 0900588 DATED 9-15-2006, EXPIRES 9-15-2016.

OWNER OF U.S. REG. NO. 2,447,716.
THE COLOR(S) BLUE IS/ARE CLAIMED AS A FEATURE OF THE MARK.

THE MARK CONSISTS OF THE WORD "IMEAS" IN BLUE CAPITAL LETTERS, PLACED BELOW A BLUE, STYLIZED LETTER "I".

CLASS 7—MACHINERY

FOR MACHINES AND MACHINE-TOOLS, NAMELY METAL GRINDING, POLISHING AND FINISHING MACHINES; SANDING AND FINISHING MACHINES FOR WOOD OR WOOD-BASED PANELS OR PLASTIC PANELS; COATING MACHINES USED FOR COATING METAL AND WOOD OR WOOD-BASED SURFACES (U.S. CLS. 13, 19, 21, 23, 31, 34 AND 35).

CLASS 9—ELECTRICAL AND SCIENTIFIC APPARATUS

FOR COMPUTER PROGRAMS AND SOFTWARE FOR CONTROLLING INDUSTRIAL AUTOMATION MACHINERY (U.S. CLS. 21, 23, 26, 36 AND 38).

ELI HELLMAN, EXAMINING ATTORNEY

SN 79-029,769. HÅKANSSON, MATS, SWEDEN, FILED 9-8-2006.



PRIORITY DATE OF 4-19-2006 IS CLAIMED.
OWNER OF INTERNATIONAL REGISTRATION 0901017 DATED 9-8-2006, EXPIRES 9-8-2016.

CLASS 5—PHARMACEUTICALS

FOR PHARMACEUTICAL PREPARATIONS FOR HUMAN USE, NAMELY PREPARATIONS FOR SUPPRESSING, REDUCING, OR ELIMINATING SMOKING AND THE URGE TO SMOKE; PHARMACEUTICAL PREPARATIONS FOR TREATING DRUG AND ALCOHOL ABUSE AND ADDICTION; PHARMACEUTICAL PREPARATIONS IN TABLET OR LOZENGE FORM FOR SUPPRESSING, REDUCING, OR ELIMINATING SMOKING AND THE URGE TO SMOKE; SANITARY PREPARATIONS FOR MEDICAL PURPOSES; DIETETIC FOODS ADAPTED FOR MEDICAL USE; SMOKING CESSATION PRODUCTS, NAMELY, INHALERS, NEBULISERS, SPRAYS, PATCHES, PILLS, CAPSULES AND GUMS, ALL FOR THE DELIVERY OF SMOKING CESSATION MEDICATION; MEDICATED PREPARATIONS AND SUBSTANCES FOR SUPPRESSING, REDUCING, OR ELIMINATING SMOKING AND THE URGE TO SMOKE; PLASTERS, NAMELY, ADHESIVE TAPE USED IN DRESSING WOUNDS; PATCHES FOR MEDICAL PURPOSES FOR USE IN THE TREATMENT OF NICOTINE ADDICTION, INCLUDING PATCHES IMPREGNATED WITH NICOTINE FOR USE IN THE TREATMENT OF SMOKING CESSATION; NICOTINE PRODUCTS FOR MEDICAL PURPOSES FOR USE IN THE TREATMENT OF SMOKING CESSATION, NAMELY, TRANSDERMAL PATCHES IMPREGNATED WITH ANTI-ANXIETY PREPARATIONS, MOUTH SPRAYS AND LOOSE AND PRE-PACKAGED POWDER TOBACCO AND MOIST ORAL SNUFF, NAMELY SNUS; CHEWING GUM FOR MEDICAL PURPOSES; DIRECT COMPRESSED MEDICATED NICOTINE CHEWING GUM; DENTAL WAX; MATERIAL FOR STOPPING TEETH (U.S. CLS. 6, 18, 44, 46, 51 AND 52).

CLASS 10—MEDICAL APPARATUS

FOR SURGICAL AND MEDICAL APPARATUS AND INSTRUMENTS FOR USE IN THE ALLEVIATION OF LUNG AILMENTS; MEDICAL APPARATUS FOR USE IN THE TREATMENT OF DRUG AND ALCOHOL ABUSE AND ADDICTION; MEDICAL APPARATUS FOR SUPPRESSING, REDUCING, OR ELIMINATING SMOKING AND THE URGE TO SMOKE; MEDICAL APPARATUS FOR USE IN THE TREATMENT OF ASTHMA AND OTHER RESPIRATORY DISEASES; DIAGNOSTIC TEST KITS CONSISTING OF APPARATUS FOR TESTING LUNG CAPACITY AND SPIROMETERS FOR EXAMINING THE FUNCTION OF LUNGS FOR USE IN CONNECTION WITH THE TREATMENT OF NICOTINE ADDICTION AND/OR SMOKING CESSATION, MEDICAL DEVICES FOR USE IN CONNECTION WITH SMOKING CESSATION, INHALERS FOR USE IN TREATING SMOKING CESSATION, SOLD EMPTY; ANTI-SMOKING TREATMENT APPARATUS, NAMELY, NEBULISERS FOR RESPIRATION THERAPY AND RESPIRATORY GAS BLENDING APPARATUS (U.S. CLS. 26, 39 AND 44).

CLASS 44—MEDICAL, BEAUTY AND AGRICULTURAL SERVICES

FOR MEDICAL SERVICES; MEDICAL CLINIC SERVICES, NAMELY THE PROVISION OF BEHAVIOR MODIFICATION PROGRAMS AND TECHNIQUES; HEALTH CLINIC SERVICES; SMOKING CESSATION SUPPORT SERVICES; ANTI-SMOKING THERAPY; ADVICE, COUNSELLING, CONSULTANCY, INFORMATION AND THERAPY (INCLUDING HYPNOTHERAPY) SERVICES RELATING TO OVERCOMING ALCOHOL AND DRUG ADDICTION AND/OR DEPENDENCY, PARTICULARLY WITH RESPECT TO NICOTINE ADDICTION AND/OR DEPENDENCY (U.S. CLS. 100 AND 101).

KATHY DE JONGE, EXAMINING ATTORNEY

SN 79-029,972. HÅKANSSON, MATS, SWEDEN, FILED 9-8-2006.

ZONNIC

PRIORITY DATE OF 3-30-2006 IS CLAIMED.
OWNER OF INTERNATIONAL REGISTRATION 0901181
DATED 9-8-2006, EXPIRES 9-8-2016.

CLASS 5—PHARMACEUTICALS

FOR PHARMACEUTICAL PREPARATIONS FOR HUMAN USE, NAMELY PREPARATIONS FOR SUPPRESSING, REDUCING, OR ELIMINATING SMOKING AND THE URGE TO SMOKE; PHARMACEUTICAL PREPARATIONS FOR TREATING DRUG AND ALCOHOL ABUSE AND ADDICTION; PHARMACEUTICAL PREPARATIONS IN TABLET OR LOZENGE FORM FOR SUPPRESSING, REDUCING, OR ELIMINATING SMOKING AND THE URGE TO SMOKE; SANITARY PREPARATIONS FOR MEDICAL PURPOSES; DIETETIC FOODS ADAPTED FOR MEDICAL USE; SMOKING CESSATION PRODUCTS, NAMELY, INHALERS, NEBULISERS, SPRAYS, PATCHES, PILLS, CAPSULES AND GUMS, ALL FOR THE DELIVERY OF SMOKING CESSATION MEDICATION; MEDICATED PREPARATIONS AND SUBSTANCES FOR SUPPRESSING, REDUCING, OR ELIMINATING SMOKING AND THE URGE TO SMOKE; PLASTERS, NAMELY, ADHESIVE TAPE USED IN DRESSING WOUNDS; PATCHES FOR MEDICAL PURPOSES FOR USE IN THE TREATMENT OF NICOTINE ADDICTION, INCLUDING PATCHES IMPREGNATED WITH NICOTINE FOR USE IN THE TREATMENT OF SMOKING CESSATION; NICOTINE PRODUCTS FOR MEDICAL PURPOSES FOR USE IN THE TREATMENT OF SMOKING CESSATION, NAMELY, TRANSDERMAL PATCHES IMPREGNATED WITH ANTI-ANXIETY PREPARATIONS, MOUTH SPRAYS AND LOOSE AND PRE-PACKAGED POWDER TOBACCO AND MOIST ORAL SNUFF, NAMELY SNUS; CHEWING GUM FOR MEDICAL PURPOSES; DIRECT COMPRESSED MEDICATED NICOTINE CHEWING GUM; DENTAL WAX; MATERIAL FOR STOPPING TEETH (U.S. CLS. 6, 18, 44, 46, 51 AND 52).

CLASS 10—MEDICAL APPARATUS

FOR SURGICAL AND MEDICAL APPARATUS AND INSTRUMENTS FOR USE IN THE ALLEVIATION OF LUNG AILMENTS; MEDICAL APPARATUS FOR USE IN THE TREATMENT OF DRUG AND ALCOHOL ABUSE AND ADDICTION; MEDICAL APPARATUS FOR SUPPRESSING, REDUCING, OR ELIMINATING SMOKING AND THE URGE TO SMOKE; MEDICAL APPARATUS FOR USE IN THE TREATMENT OF ASTHMA AND OTHER RESPIRATORY DISEASES; DIAGNOSTIC TEST KITS CONSISTING OF APPARATUS FOR TESTING LUNG CAPACITY AND SPIROMETERS FOR EXAMINING THE FUNCTION OF LUNGS FOR USE IN CONNECTION WITH THE TREATMENT OF NICOTINE ADDICTION AND/OR SMOKING CESSATION, MEDICAL DEVICES FOR USE IN CONNECTION WITH SMOKING CESSATION, INHALERS FOR USE IN TREATING SMOKING CESSATION, SOLD EMPTY; ANTI-SMOKING TREATMENT APPARATUS, NAMELY, NEBULISERS FOR RESPIRATION THERAPY AND RESPIRATORY GAS BLENDING APPARATUS (U.S. CLS. 26, 39 AND 44).

CLASS 44—MEDICAL, BEAUTY AND AGRICULTURAL SERVICES

FOR MEDICAL SERVICES; MEDICAL CLINIC SERVICES, NAMELY THE PROVISION OF BEHAVIOR MODIFICATION PROGRAMS AND TECHNIQUES; HEALTH CLINIC SERVICES; SMOKING CESSATION SUPPORT SERVICES; ANTI-SMOKING THERAPY; ADVICE, COUNSELLING, CONSULTANCY, INFORMATION AND THERAPY (INCLUDING HYPNOTHERAPY) SERVICES RELATING TO OVERCOMING ALCOHOL AND DRUG ADDICTION AND/OR DEPENDENCY, PARTICULARLY WITH RESPECT TO NICOTINE ADDICTION AND/OR DEPENDENCY (U.S. CLS. 100 AND 101).

KATHY DE JONGE, EXAMINING ATTORNEY

SN 79-030,035. PARAYTEC LIMITED, UNITED KINGDOM, FILED 10-5-2006.

ACTIPIX

THE MARK CONSISTS OF STANDARD CHARACTERS WITHOUT CLAIM TO ANY PARTICULAR FONT, STYLE, SIZE, OR COLOR.

PRIORITY DATE OF 5-16-2006 IS CLAIMED.

OWNER OF INTERNATIONAL REGISTRATION 0901391 DATED 10-5-2006, EXPIRES 10-5-2016.

CLASS 9—ELECTRICAL AND SCIENTIFIC APPARATUS

FOR SCIENTIFIC APPARATUS AND INSTRUMENTS, NAMELY, SCIENTIFIC MEASURING INSTRUMENTS, NAMELY, DETECTORS, NAMELY, ULTRAVIOLET AND VISIBLE LIGHT DETECTORS FOR DETECTING DIFFERENCES IN LIGHT INTENSITY AT PARTICULAR WAVELENGTHS FOR USE WITH SEPARATION METHODS OF LIQUID CHROMATOGRAPHY AND CAPILLARY ELECTROPHORESIS; AND SPECTROPHOTOMETERS USING OPTICAL ULTRAVIOLET RADIATIONS AND VISIBLE RADIATIONS (U.S. CLS. 21, 23, 26, 36 AND 38).

CLASS 10—MEDICAL APPARATUS

FOR MEDICAL APPARATUS AND INSTRUMENTS FOR CLINICAL DIAGNOSTICS, USING ULTRAVIOLET AND VISIBLE DETECTORS IN CONJUNCTION WITH ELECTROPHORESIS OR LIQUID CHROMATOGRAPHY (U.S. CLS. 26, 39 AND 44).

KIM SAITO, EXAMINING ATTORNEY

SN 79-030,105. SERVICE BOX S.R.L., I-00186 ROME, ITALY, FILED 9-5-2006.



OWNER OF INTERNATIONAL REGISTRATION 0901542 DATED 9-5-2006, EXPIRES 9-5-2016.

CLASS 18—LEATHER GOODS

FOR ANIMAL SKINS, TRUNKS AND TRAVELLING BAGS, ALL PURPOSE SPORT BAGS, HANDBAGS, WHIPS, HARNESS AND SADDLERY, WALLETS, PURSES, KEY CASES, COSMETIC CASES SOLD EMPTY, ALL MADE FROM LEATHER OR IMITATION LEATHER; UMBRELLAS, PARASOLS AND WALKING STICKS (U.S. CLS. 1, 2, 3, 22 AND 41).

CLASS 25—CLOTHING

FOR CLOTHING, NAMELY COATS, JACKETS, DRESSES, SUITS, TWIN-SETS, BLOUSES, PULLOVERS, SHIRTS, SWEATSHIRTS, T-SHIRTS, PANTS, JEANS, TROUSERS, BLAZERS, SKIRTS, SHORTS, COSTUMES, SOCKS, SLEEPWEAR, GLOVES, SCARVES, BELTS OF TEXTILE, LEATHER BELTS, TIES; FOOTWEAR; HEADGEAR, NAMELY HATS, CAPS (U.S. CLS. 22 AND 39).

ALYSSA PALADINO, EXAMINING ATTORNEY

SN 79-030,290. PATRICK LOUBEYRE, FRANCE, FILED 9-27-2006.

OWNER OF INTERNATIONAL REGISTRATION 0895321 DATED 6-6-2006, EXPIRES 6-6-2016.

"THE COLOR(S) BLUE AND BLACK IS/ARE CLAIMED AS A FEATURE OF THE MARK."

"THE MARK CONSISTS OF THE WORDING NETT AND THE WORDING WORK. THE COLOR BLUE APPEARS IN THE WORDING NETT. THE COLOR BLACK APPEARS IN THE OUTLINE OF THE WORDING WORK."

CLASS 7—MACHINERY

FOR MACHINES AND MACHINE TOOLS FOR CLEANING SURFACES USING HIGH PRESSURE WATER; STEAM CLEANING MACHINES; ELECTRIC MOTORS FOR MACHINES; ENGINES NOT FOR LAND VEHICLES; COUPLINGS FOR MACHINES, POWER TRANSMISSION AND GEARING FOR MACHINES (U.S. CLS. 13, 19, 21, 23, 31, 34 AND 35).

CLASS 12—VEHICLES

FOR VEHICLES, NAMELY, VANS INCLUDING A PRESSURIZED AIR AND WATER PRODUCTION DEVICE (U.S. CLS. 19, 21, 23, 31, 35 AND 44).

CLASS 37—CONSTRUCTION AND REPAIR

FOR CLEANING AND MAINTAINING OF BUILDINGS, OFFICES, AND FLOORS, NAMELY, RESURFACING OF FACADES, DISINFECTING, EXTERMINATION OF RATS; CIVIL ENGINEERING; RENTAL OF HAND AND POWER TOOLS; RENTAL OF BUILDING EQUIPMENT, RENTAL OF BULLDOZERS (U.S. CLS. 100, 103 AND 106).

LINDA M. KING, EXAMINING ATTORNEY

SN 79-030,796. ZAKRYTOE AKTSIONERNOE OBSHCHESTVO; "AEROPLAN", RUSSIAN FED., FILED 7-20-2006.

Fixies Фиксики

PRIORITY DATE OF 1-26-2006 IS CLAIMED.
OWNER OF INTERNATIONAL REGISTRATION 0903089
DATED 7-20-2006. EXPIRES 7-20-2016.
THE TRANSLITERATION OF THE NON-LATIN CHARACTERS IN THE MARK IS: FIKSIKI.

CLASS 28—TOYS AND SPORTING GOODS

FOR COIN-OPERATED AMUSEMENT MACHINES; TOY VEHICLES; PLAY SWIMMING POOLS; NOVELTIES FOR PARTIES, NAMELY, PORTABLE SUPPORT STRUCTURES FOR DANCE; STARTING BLOCKS FOR SPORTS; IN-LINE SKATES; DOLLS' FEEDING BOTTLES; PAINTBALLS, NAMELY, AMMUNITION FOR PAINTBALL GUNS; BADMINTON SHUTTLECOCKS; SPINNING TOPS; PUZZLES; PUNCHING BAGS; FLYING DISCS; DISCUSSES FOR SPORTS; DOLLS' HOUSES; DOMINOES; SURF BOARDS; SPRING BOARDS; SKATEBOARDS; SAILBOARDS; CHESSBOARDS; CHECKERBOARDS; DARTS; CHRISTMAS TREES OF SYNTHETIC MATERIAL; CUPS FOR ROLLING DICE; KITES; PINATAS; TOYS FOR DOMESTIC PETS; TEDDY BEARS; TOY MOBILES; PRACTICAL JOKE NOVELTIES, NAMELY, INFLATABLE RUBBER BALLOONS THAT MAKE SOUND; APPARATUS FOR ELECTRONIC GAMES OTHER THAN THOSE ADAPTED FOR USE WITH AN EXTERNAL DISPLAY SCREEN OR MONITOR; PARLOR GAMES; BOARD GAMES; RING GAMES; BOARD GAMES; KALEIDOSCOPES; BLADDERS OF BALLS FOR GAMES; EDGES OF SKIS; BINGO CARDS; PLAYING CARDS; AMUSEMENT PARK RIDES; ROCKING HORSES; PLAYGROUND EQUIPMENT, NAMELY, SWINGS; SKITTLES; NINEPINS; BILLIARD CUES; GOLF CLUBS; HOCKEY STICKS; BELLS FOR CHRISTMAS TREES; DOLLS' ROOMS; TOY BUILDING BLOCKS; CHRISTMAS CONFETTI, ICE SKATES; ROLLER SKATES; DICE; PAINTBALL GUNS; SKI BINDINGS; DOLLS' BEDS; ROULETTE WHEELS; DOLLS; FLIPPERS FOR SWIMMING; BOWS FOR ARCHERY; SKIS; WATER SKIS; MAH-JONG; MARIONETTE PUPPETS; TOY MASKS; THEATRICAL MASKS; MASTS FOR SAILBOARDS; TARGETS; SCALE MODEL VEHICLES; BALLS FOR GAMES; BILLIARD CUE TIPS; ELBOW GUARDS FOR ATHLETIC USE; DOLLS' CLOTHES; FENCING WEAPONS, NAMELY, EPEE; PARAGLIDERS; BOXING GLOVES; BASEBALL GLOVES; GOLF GLOVES; TOY DETONATING CAPS; TOY PISTOLS; BABY RATTLES; HORSESHOES FOR RECREATIONAL PURPOSES; CHRISTMAS TREE STANDS; DECOYS FOR HUNTING OR FISHING; ARCHERY IMPLEMENTS; RODS FOR FISHING; FLOATS FOR FISHING; FISHING TACKLE; LINES FOR FISHING; REELS FOR FISHING; GUT FOR FISHING; KITE REELS; PROTECTIVE PADDINGS FOR BALL SPORTS; BATS FOR BASEBALL, SOFTBALL, CRICKET AND TABLE TENNIS; FOILS FOR FENCING; SURFBOARD LEASHES; HARNESS FOR SAILBOARDS; WEIGHT LIFTING BELTS; SLING SHOTS; ROLLERS FOR STATIONARY EXERCISE BICYCLES; SCUBA EQUIPMENT, NAMELY SPEAR FISHING HARPOON GUNS; TOY SCOOTERS; BOBSLEDS; TOY BUTTERFLY NETS; TENNIS NETS; SCRAPERS FOR SKIS; APPARATUS FOR GYMNASTICS; QUOITS; DUMB-BELLS; CLIMBERS' HARNESS; CHRISTMAS TREE DECORATIONS IN THE NATURE OF ARTIFICIAL SNOW; SNOWSHOES; CLAY PIGEON TRAPS; BILLIARD TABLES; COIN-OPERATED BILLIARD TABLES; TABLES FOR TABLE TENNIS; TABLES FOR INDOOR FOOTBALL; GUT FOR RACKETS; CRICKET BAT BAGS; GOLF BAGS, WITH OR WITHOUT WHEELS; PLAYGROUND EQUIPMENT, NAMELY, SLIDES; RADIO-CONTROLLED TOY VEHICLES; STATIONARY EXERCISE BICYCLES; BODY-BUILDING APPARATUS, NAMELY, WEIGHT LIFTING MACHINES; ORNAMENTS FOR CHRISTMAS TREES, EXCEPT ILLUMINATION ARTICLES AND CONFECTIONERY; TENNIS

BALL THROWING APPARATUS; APPARATUS FOR ELECTRONIC GAMES OTHER THAN THOSE ADAPTED FOR USE WITH AN EXTERNAL DISPLAY SCREEN OR MONITOR; BOWLING APPARATUS, NAMELY, PINSETTERS AND PARTS THEREFOR; BAGS ESPECIALLY DESIGNED FOR SKIS AND SURFBOARDS; SMALL SPORT BALLS; BILLIARD BALLS; PLAY BALLOONS; SNOW GLOBES; CHECKERS; SHIN GUARDS FOR ATHLETIC USE; CHEST EXPANDERS (U.S. CLS. 22, 23, 38 AND 50).

CLASS 29—MEATS AND PROCESSED FOODS

FOR MEAT, FISH, POULTRY AND GAME; MEAT EXTRACTS; PRESERVED, DRIED AND COOKED FRUITS AND VEGETABLES; JELLIES, JAMS, COMPOSTES; EGGS, MILK AND MILK PRODUCTS EXCLUDING ICE CREAM, ICE MILK AND FROZEN YOGURT; EDIBLE OILS AND FATS (U.S. CL. 46).

CLASS 30—STAPLE FOODS

FOR COFFEE, TEA, COCOA, SUGAR, RICE, TAPIOCA, SAGO, ARTIFICIAL COFFEE; FLOUR AND PREPARATIONS MADE FROM CEREALS, NAMELY, BREAD, PASTRY AND PASTILLES; FLAVORED ICES; HONEY, TREACLE; YEAST, BAKING-POWDER; SALT; MUSTARD; VINEGAR, SAUCES AS CONDIMENTS; SPICES; ICE (U.S. CL. 46).

CLASS 32—LIGHT BEVERAGES

FOR BEERS; NON-ALCOHOLIC DRINKS, NAMELY, AERATED WATER, MINERAL WATER, LITHIA WATER, SODA WATER, NONALCOHOLIC COCKTAILS, LEMONADE, CARBONATED BEVERAGES, FRUIT BEVERAGES, ISOTONIC DRINKS, WHEY BEVERAGES, NONALCOHOLIC FRUIT JUICE BEVERAGES, MILK OF ALMONDS, NONALCOHOLIC FRUIT NECTARS, ORGEAT, NONALCOHOLIC APERITIFS, SARSAPARILLA SOFT DRINKS, TOMATO JUICE, SWEET CIDER, VEGETABLE JUICE, SORBET BEVERAGES, FRUIT DRINKS AND FRUIT JUICES; SYRUPS FOR MAKING LEMONADE; SYRUPS FOR MAKING BEVERAGES; PREPARATIONS FOR MAKING BEVERAGES, NAMELY, PREPARATIONS FOR MAKING AERATED WATER, PREPARATIONS FOR MAKING LIQUEURS, PREPARATIONS FOR MAKING MINERAL WATER, NONALCOHOLIC FRUIT EXTRACTS, ESSENCES FOR SOFT DRINKS AND ESSENCES FOR MINERAL WATER AND ESSENCES FOR LIQUEURS (U.S. CLS. 45, 46 AND 48).

CLASS 35—ADVERTISING AND BUSINESS

FOR ADVERTISING; BUSINESS MANAGEMENT; BUSINESS ADMINISTRATION; OFFICE FUNCTIONS (U.S. CLS. 100, 101 AND 102).

CLASS 38—COMMUNICATION

FOR NEWS AGENCIES, NAMELY, THE TRANSMISSION OF NEWS ITEMS TO NEWS REPORTING ORGANIZATIONS; TELEVISION BROADCASTING; CABLE TELEVISION BROADCASTING; ELECTRONIC BULLETIN BOARD SERVICES, NAMELY, PROVIDING ONLINE ELECTRONIC BULLETIN BOARDS FOR TRANSMISSION OF MESSAGES AMONG USERS IN THE FIELD OF GENERAL INTEREST; PROVIDING INFORMATION ABOUT TELECOMMUNICATIONS; TELECOMMUNICATIONS ROUTING AND JUNCTION SERVICES; PROVIDING MULTIPLE-USER ACCESS TO A GLOBAL COMPUTER NETWORK; PROVIDING TELECOMMUNICATIONS CONNECTIONS TO A GLOBAL COMPUTER; ELECTRONIC NETWORK MESSAGE SENDING; COMPUTER AIDED TRANSMISSION OF MESSAGES AND IMAGES; TRANSMISSION OF TELEGRAMS; ELECTRONIC MAIL SERVICES; RENTAL OF

MESSAGE SENDING APPARATUS; RENTAL OF MODEMS; RENTAL OF TELECOMMUNICATION EQUIPMENT; RENTAL OF TELEPHONES; RENTAL OF FACSIMILE APPARATUS; RADIO BROADCASTING; COMMUNICATIONS VIA FIBER OPTIC NETWORKS; CELLULAR TELEPHONE COMMUNICATION; COMMUNICATIONS BY COMPUTER TERMINALS; SATELLITE TRANSMISSION SERVICES; COMMUNICATIONS BY TELEGRAMS; COMMUNICATIONS BY TELEPHONE; PAGING SERVICES; AUDIO AND VIDEO TELECONFERENCING SERVICES; TELEGRAPH SERVICES (U.S. CLS. 100, 101 AND 104).

CLASS 41—EDUCATION AND ENTERTAINMENT

FOR MODELING FOR ARTISTS; ACADEMIES, NAMELY BOARDING SCHOOLS; LENDING LIBRARIES; BOOKING OF SEATS FOR SHOWS; VIDEOTAPING; NURSERY SCHOOLS; PHYSICAL EDUCATION SERVICES; DISCOTHEQUES; DUBBING; CASINOS; PUBLICATION OF BOOKS; PROVIDING INFORMATION ABOUT EDUCATION; PROVIDING INFORMATION ABOUT RECREATIONAL ACTIVITIES; PROVIDING INFORMATION IN THE FIELD OF ENTERTAINMENT; MOVIE STUDIOS; HEALTH CLUB SERVICES, NAMELY, NAMELY, PROVIDING INSTRUCTION AND EQUIPMENT IN THE FIELD OF PHYSICAL EXERCISE; FAN CLUBS AND WRESTLING CLUBS; NIGHT CLUBS; MICROFILMING FOR OTHERS; VIDEOTAPE EDITING; PRODUCTION OF RADIO AND TELEVISION PROGRAMMES; PROVIDING FACILITIES FOR MUSIC, NAMELY, MUSIC-HALLS; PROVIDING ONLINE COMPUTER GAMES; PUBLISHING ONLINE NON-DOWNLOADABLE ELECTRONIC PUBLICATIONS; GYMNASIUM INSTRUCTION; EDUCATIONAL SERVICES IN THE NATURE OF CORRESPONDENCE COURSES AT THE UNIVERSITY LEVEL; PRACTICAL TRAINING IN THE FIELD OF WELDING; PARTY PLANNING SERVICES, NAMELY, ORGANIZATION OF BALLS; ORGANIZATION OF EXHIBITIONS FOR CULTURAL OR EDUCATIONAL PURPOSES; PROVIDING RECREATION FACILITIES; ARRANGING AND CONDUCTING EDUCATIONAL COLLOQUIA, CONGRESSES, CONFERENCES, WORKSHOPS, SEMINARS AND SYMPOSIA; ARRANGING OF BEAUTY CONTESTS; ORGANIZATION OF SPORTS COMPETITIONS; ORGANIZATION OF LOTTERIES; HOLIDAY CAMP SERVICES; ORGANIZATION OF FASHION SHOWS; VOCATIONAL GUIDANCE; AMUSEMENT PARKS; SIGN LANGUAGE INTERPRETATION; TELEVISION ENTERTAINMENT, NAMELY, PRODUCTION OF TELEVISION SHOWS; BOOKMOBILE SERVICES; PROVIDING KARAOKE FACILITIES; PROVIDING GOLF FACILITIES; PROVIDING SPORTS FACILITIES; PROVIDING AMUSEMENT ARCADE SERVICES; PROVIDING CINEMA FACILITIES; PRESENTATION OF LIVE SHOW PERFORMANCES; THEATRE PRODUCTIONS; EDUCATIONAL EXAMINATION; TIMING OF SPORTS EVENTS; MOTION PICTURE FILM PRODUCTION; RENTAL OF SOUND RECORDINGS; RENTAL OF AUDIO EQUIPMENT; RENTAL OF VIDEO CAMERAS; RENTAL OF VIDEO CASSETTE RECORDERS; RENTAL OF VIDEOTAPES; RENTAL OF SHOW SCENERY; RENTAL OF MOVIE PROJECTORS AND ACCESSORIES; RENTAL OF MOTION PICTURES; RENTAL OF STADIUM FACILITIES; RENTAL OF LIGHTING APPARATUS FOR THEATRICAL SETS OR TELEVISION STUDIOS; RENTAL OF RADIO AND TELEVISION SETS; RENTAL OF SPORTING GOODS, INCLUDING SKIN-DIVING EQUIPMENT; RENTAL OF STAGE SCENERY; PUBLICATION OF ELECTRONIC BOOKS AND JOURNALS ON-LINE; PUBLICATION OF TEXTS, OTHER THAN PUBLICITY TEXTS; RADIO ENTERTAINMENT, NAMELY, PRODUCTION OF RADIO PROGRAMS; ENTERTAINMENT SERVICES NAMELY LIVE, TELEVISED AND MOVIE APPEARANCES BY A PROFESSIONAL ENTERTAINER; PROVIDING ZOOLOGICAL GARDENS; NEWS REPORTING SERVICES; PARTY PLANNING; MUSIC COMPOSITION SERVICES FOR OTHERS; SPORTS CAMP SERVICES; PREPARING SUBTITLES FOR MOVIES; PROVIDING CASINO FACILITIES; PROVIDING MUSEUM FACILITIES; TEACHING IN THE FIELD OF TELEVISION, RADIO, MEDIA, AND SPORTS; ENTERTAINMENT IN THE NATURE OF ORCHESTRA PERFORMANCES; TRANSLATION SERVICES; SCRIPT WRITING SERVICES; RECORDING STUDIOS; DIGITAL

IMAGING SERVICES; PHOTOGRAPHY; PHOTOGRAPHIC REPORTING; ENTERTAINMENT IN THE NATURE OF CIRCUSES (U.S. CLS. 100, 101 AND 107).

CLASS 42—SCIENTIFIC AND COMPUTER SERVICES

FOR COMPUTER SYSTEMS ANALYSIS; CHEMICAL ANALYSIS; ARBITRATION SERVICES; ARCHITECTURAL CONSULTATION; AUTHENTICATING WORKS OF ART; RECOVERY OF COMPUTER DATA; GRAPHIC ARTS DESIGNING; ENGINEERING; INSTALLATION OF COMPUTER SOFTWARE; PROVIDING METEOROLOGICAL INFORMATION; MATERIAL TESTING; TEXTILE TESTING; BACTERIOLOGICAL RESEARCH; BIOLOGICAL RESEARCH; COSMETIC RESEARCH; CECHANICAL RESEARCH; LEGAL RESEARCH; CHEMICAL RESEARCH; PRODUCT RESEARCH AND DEVELOPMENT FOR OTHERS; UNDERWATER EXPLORATION; TECHNICAL SCIENTIFIC RESEARCH; CALIBRATION SERVICES; CONSULTANCY IN THE FIELD OF COMPUTER HARDWARE; CONSULTATION IN ENVIRONMENT PROTECTION; INTELLECTUAL PROPERTY CONSULTANCY; INTELLECTUAL PROPERTY WATCHING SERVICES; QUALITY CONTROL FOR OTHERS; PRODUCT SAFETY TESTING, NAMELY, TESTING OF VEHICLE ROADWORTHINESS; LICENSING OF INTELLECTUAL PROPERTY; DRESS DESIGNING; UPDATING OF COMPUTER SOFTWARE FOR OTHERS; MAINTENANCE OF COMPUTER SOFTWARE; DESIGN OF INTERIOR DECOR; CONVERSION OF DATA OR DOCUMENTS FROM PHYSICAL TO ELECTRONIC MEDIA; URBAN PLANNING; DATA CONVERSION OF COMPUTER PROGRAM DATA OR INFORMATION; COMPUTER SYSTEM DESIGN; COMPUTER RENTAL; RENTAL OF COMPUTER SOFTWARE; GEOLOGICAL PROSPECTING; HOSTING COMPUTER WEB SITES FOR OTHERS; DUPLICATION OF COMPUTER PROGRAMS; CONSTRUCTION DRAFTING; COMPUTER SOFTWARE DESIGN FOR OTHERS; CREATING AND MAINTAINING WEB SITES FOR OTHERS; COMPUTER PROGRAMMING FOR OTHERS; INDUSTRIAL DESIGN; RESEARCH AND CONSULTATION IN THE FIELD OF CHEMISTRY; PACKAGING DESIGN FOR OTHERS; SURVEYING (U.S. CLS. 100 AND 101).

CLASS 43—HOTEL AND RESTAURANT SERVICES

FOR SERVICES FOR PROVIDING FOOD AND DRINK, NAMELY, BAR AND RESTAURANT SERVICES; TEMPORARY ACCOMMODATION SERVICES, NAMELY, HOTELS (U.S. CLS. 100 AND 101).
NICHOLAS ALTREE, EXAMINING ATTORNEY

SN 79-031,165. SCHMID ELEKTRONIK ENGINEERING AG, SWITZERLAND, FILED 8-23-2006.

Zbrain

THE MARK CONSISTS OF STANDARD CHARACTERS WITHOUT CLAIM TO ANY PARTICULAR FONT, STYLE, SIZE, OR COLOR.

OWNER OF INTERNATIONAL REGISTRATION 0904128 DATED 8-23-2006, EXPIRES 8-23-2016.

CLASS 9—ELECTRICAL AND SCIENTIFIC APPARATUS

FOR COMPUTER HARDWARE; COMPUTER SOFTWARE AND HARDWARE IN MODULE FORM FOR PHYSICAL MEASUREMENTS TECHNOLOGY; COMPUTER HARDWARE AND SOFTWARE IN MODULE FORM DESIGNED TO ENSURE CHARACTERIZATION AND REGULATION OF MACHINES AND PROCESSES; PRINTED CIRCUITS FOR SIGNAL PROCESSORS; MINIATURE COMPUTERS; REAL TIME OPERATING SYSTEMS (U.S. CLS. 21, 23, 26, 36 AND 38).

CLASS 42—SCIENTIFIC AND COMPUTER SERVICES

FOR TECHNICAL PLANNING OF PROJECTS IN THE FIELD OF INDUSTRIAL AND RAILWAY AUTOMATION; DESIGN AND DEVELOPMENT OF INTEGRATED PROCESS CALCULATORS AND THEIR COMPANY SOFTWARE; DESIGN AND DEVELOPMENT OF DIGITAL ALGORITHMS FOR SIGNAL PROCESSING; DESIGN AND CREATION OF SPECIFIC APPLICATION SOFTWARE (U.S. CLS. 100 AND 101).

LEIGH CAROLINE CASE, EXAMINING ATTORNEY

CLASS 5—PHARMACEUTICALS

FOR PHARMACEUTICAL, VETERINARY AND SANITARY PREPARATIONS, NAMELY, ANTI VIRUS MEDICATION; OILED PAPER FOR MEDICAL PURPOSES; GAUZE FOR DRESSINGS; EMPTY CAPSULES MADE OF GELATIN FOR PHARMACEUTICALS; EMPTY CAPSULES FOR UNIT DOSE FOR PHARMACEUTICALS; EYE PATCHES FOR MEDICAL PURPOSES; ADHESIVE BANDAGES FOR USE ON THE EARS; MENSTRUATION BANDAGES; MENSTRUATION TAMPONS; SANITARY NAPKINS; SANITARY PANTIES; ABSORBENT COTTON FOR MEDICAL USE; ADHESIVE MEDICAL PLASTERS; BANDAGES FOR DRESSINGS; PHARMACEUTICAL PREPARATIONS, NAMELY, COLLODION FOR BACTERIAL INFECTION DISEASES; BREAST-NURSING PADS; DENTAL IMPRESSION MATERIALS; MAGNETIC BRACELETS FOR MEDICAL PURPOSES; INCONTINENCE DIAPERS; FLY CATCHING PAPER; MOTH PROOFING PAPER; DIETETIC SUGAR IN THE NATURE OF LACTOSE FOR MEDICAL USE; POWDERED MILK FOR BABIES; SEMEN FOR ARTIFICIAL INSEMINATION (U.S. CLS. 6, 18, 44, 46, 51 AND 52).

CLASS 10—MEDICAL APPARATUS

FOR SANITARY MASKS IN THE NATURE OF RESPIRATORY MASKS FOR MEDICAL PURPOSES, PARTICULARLY FOR PREVENTING COLDS, INHALATION OF DUST, AND BACTERIA (U.S. CLS. 26, 39 AND 44).

CLASS 29—MEATS AND PROCESSED FOODS

FOR EDIBLE OILS AND FATS; MILK PRODUCTS EXCLUDING ICE CREAM, ICE MILK AND FROZEN YOGURT; FRESH, CHILLED OR FROZEN MEAT FOR HUMAN CONSUMPTION; EGGS; FRESH, CHILLED OR FROZEN EDIBLE AQUATIC ANIMALS, NAMELY, SEAFOOD, NOT LIVE; FROZEN VEGETABLES; FROZEN FRUITS; PROCESSED MEAT PRODUCTS; BLOCKS OF BOILED, SMOKED AND THEN DRIED BONITOS; DRIED PIECES OF AGAR JELLY (KANTEN); FLAKES OF DRIED FISH MEAT (KEZURI-BUSHI); FISHMEAL FOR HUMAN CONSUMPTION; EDIBLE SHAVINGS OF DRIED KELP (TORORO-KOMBU); SHEETS OF DRIED LAYER (HOSHI-NORI); DRIED BROWN EDIBLE ALGAE (HOSHI-HIJIKI); DRIED EDIBLE SEAWEED (HOSHI-WAKAME); TOASTED SHEETS OF LAYER (YAKI-NORI) AND OTHER PROCESSED FISH PRODUCTS, NAMELY, SALTED OR SMOKED FISH; PROCESSED FOOD IN THE FORM OF TABLETS, POWDER OR LIQUID, MAINLY MADE OF VEGETABLES OR FRUITS, NAMELY, CANNED PICKLES AND JAMS; PROCESSED VEGETABLES AND FRUITS; FRIED TOFU PIECES (ABURAGE); FREEZE-DRIED TOFU PIECES (KOHRI-DOFU); JELLY MADE FROM DEVILS' TONGUE ROOT (KONNYAKU); SOYBEAN MILK AS A MILK SUBSTITUTE; TOFU; FERMENTED SOYBEANS (NATTO); PROCESSED EGGS; SOUP MIXES; DRIED FLAKES OF LAYER FOR SPRINKLING ON RICE IN HOT WATER (OCHAZUKE-NORI); FERMENTED SOYBEAN FOODS, NAMELY, SOY CHIPS, SOY BURGER PATTIES; RAW PULSES; PROTEIN BEING FOODSTUFFS FOR HUMAN CONSUMPTION; CHILLED VEGETABLES, NAMELY, SPINACH AND CARROTS; CHILLED FRUITS, NAMELY, BLUE BERRIES (U.S. CL. 46).

CLASS 30—STAPLE FOODS

FOR STARCH BASED BINDING AGENTS FOR ICE CREAM; MEAT TENDERIZERS FOR HOUSEHOLD PURPOSES, STARCH-BASED PREPARATIONS FOR STIFFENING WHIPPED CREAM; FOOD FLAVORINGS FOR FOOD AND VEGETABLES; OOLONG TEA; BLACK TEA; TEA OF SALTY KELP POWDER (KOMBU-CHA), TEA OF PARCHED POWDER OF BARLEY WITH HUSK (MUGI-CHA), JAPANESE GREEN TEA; COFFEE; COCOA; ICE; CONFECTIONERY, NAMELY, PASTILLES, CANDY, CHEWING GUM; BREAD AND BUNS; MISO BEAN PASTE; WORCESTERSHIRE SAUCE; KETCHUP; MEAT GRAVIES; SOY SAUCE; VINEGAR; SALAD DRESSINGS; SAUCES, NAMELY, WHITE SAUCE FOR COOKED FISH, COOKED MEAT, AND PASTA; MAYONNAISE; SAUCES FOR BARBECUED MEAT; CUBE SUGAR; SUGAR, NAMELY, FRUCTOSE; CRYSTAL SUGAR, NOT CONFECTIONERY; SUGAR; SUGAR, NAMELY, MALTOSE; HONEY (FOR FOOD); SUGAR,

SN 79-031,220. MITSUI NORIN CO., LTD., JAPAN, FILED 6-16-2005.

POLYPHENON

THE MARK CONSISTS OF STANDARD CHARACTERS WITHOUT CLAIM TO ANY PARTICULAR FONT, STYLE, SIZE, OR COLOR.

PRIORITY DATE OF 5-30-2005 IS CLAIMED.

OWNER OF INTERNATIONAL REGISTRATION 0904270 DATED 6-16-2005, EXPIRES 6-16-2015.

OWNER OF U.S. REG. NOS. 1,819,112, 2,741,131 AND 3,121,041.

CLASS 3—COSMETICS AND CLEANING PREPARATIONS

FOR ANTI-STATIC PREPARATIONS FOR HOUSEHOLD PURPOSES, NAMELY, ANTI-STATIC SPRAY FOR CLOTHING AND ANTI-STATIC DRYER SHEETS; DEGREASING PREPARATIONS FOR HOUSEHOLD PURPOSES; RUST REMOVING PREPARATIONS; STAIN REMOVERS CONTAINING BENZINE; FABRIC SOFTENERS FOR LAUNDRY USE; LAUNDRY BLEACH; ADHESIVES FOR AFFIXING FALSE HAIR; ADHESIVES FOR AFFIXING FALSE EYELASHES; LAUNDRY STARCH; SEAWEED GELATIN FOR LAUNDRY USE (FUNORI); PAINT STRIPPING PREPARATIONS; SHOE AND BOOT CREAM; SHOE BLACK; POLISHING PREPARATIONS; SOAPS AND DETERGENTS; DENTIFRICES; COSMETICS AND NON-MEDICATED TOILETRIES; NATURAL PERFUMERY PREPARED FROM VEGETABLES; NATURAL PERFUMERY PREPARED FROM ANIMALS; SYNTHETIC PERFUMERY; COMPOUND PERFUMERY; FOOD FLAVORINGS PREPARED FROM ESSENTIAL OILS; INCENSES; ROOM FRAGRANCES; FRAGRANCES FOR PERSONAL USE; ABRASIVE PAPER, NAMELY, SANDPAPER; ABRASIVE CLOTH; ABRASIVE SAND; ARTIFICIAL PUMICE STONES FOR PERSONAL USE; POLISHING PAPER; FALSE NAILS; FALSE EYELASHES (U.S. CLS. 1, 4, 6, 50, 51 AND 52).

NAMELY, GLUCOSE; STARCH PRODUCTS FOR FOOD, NAMELY, POWDERED STARCH SYRUP; STARCH SYRUP; TABLE SALT MIXED WITH SESAME SEEDS; COOKING SALT; ROASTED AND GROUND SESAME SEEDS; CELERY SALT; SEASONINGS; SPICES; ICE CREAM MIXES; SHERBET MIXES; UNROASTED COFFEE; CEREAL PREPARATIONS, NAMELY, BREAKFAST CEREAL, PROCESSED CEREALS; ALMOND PASTE; CHINESE STUFFED DUMPLINGS (GYOZA, COOKED); SANDWICH; CHINESE STEAMED DUMPLINGS (SHUMAI, COOKED); SUSHI; FRIED BALLS OF BATTER MIX WITH SMALL PIECES OF OCTOPUS (TAKOYAKI); STEAMED BUNS STUFFED WITH MINCED MEAT (NIKU-MANJU); HAMBURGER SANDWICHES; PREPARED PIZZA; HOT DOG SANDWICHES; PREPARED MEAT PIES; PREPARED RAVIOLI; YEAST POWDER; RICE, NAMELY, FERMENTING MALTED RICE (KOFI); YEAST; BAKING POWDER; HUSKED RICE; PROCESSED OATS, NAMELY, HUSKED OATS; HUSKED BARLEY; FLOUR FOR FOOD; GLUTEN FOR FOOD; CURRY SPICE MIXTURES; SEASONINGS, NAMELY, SEASONED POWDER FOR SPRINKLING ON RICE (FURI-KAKE); DIPPING SAUCE FOR SOBA NOODLE (SOBA-TSUJU) (U.S. CL. 46).

CLASS 31—NATURAL AGRICULTURAL PRODUCTS

FOR WREATHS OF NATURAL FLOWERS; LIVE FISHING BAITS; UNPROCESSED HOPS; LIVE, EDIBLE AQUATIC ANIMALS; UNPROCESSED EDIBLE SEAWEEDS; FRESH VEGETABLES; UNPROCESSED TEA LEAVES; SUGARCANE; FRESH FRUITS; COPRA; MALT FOR BREWING AND DISTILLING; UNPROCESSED GRAIN, NAMELY, FOXTAIL MILLET; UNPROCESSED GRAIN, NAMELY, PROSO MILLET; UNPROCESSED PLANT SEEDS, NAMELY, SESAME SEEDS; UNPROCESSED WHEAT, NAMELY, BUCKWHEAT; UNPROCESSED CORN; UNPROCESSED GRAIN, NAMELY, JAPANESE BARNYARD MILLET; RAW WHEAT; UNPROCESSED GRAINS, NAMELY, BARLEY; UNPROCESSED OATS; UNPROCESSED RICE; UNPROCESSED GRAIN, NAMELY, SORGHUM; PROTEIN BASED FOOD FOR ANIMALS; ANIMAL FOODSTUFFS; SEEDS AND BULBS; LIVE TREES; LIVE GRASSES NOT INCLUDING ESPARTO GRASS; TURF; DRIED FLOWERS; SEEDLINGS; SAPLINGS; FLOWERS; HAY; POTTED DWARFED TREES (BONSAI); LIVE MAMMALS, FISH, BIRDS AND INSECTS NONE OF WHICH ARE FOR FOOD; SILKWORM EGGS; EGGS FOR HATCHING; URUSHI TREE SEEDS; ROUGH CORK; PALM TREE LEAVES (U.S. CLS. 1 AND 46).

CLASS 32—LIGHT BEVERAGES

FOR BEER; NON-ALCOHOLIC BEVERAGES, NAMELY, CARBONATED DRINKS; NON-ALCOHOLIC FRUIT JUICE BEVERAGES; EXTRACTS OF HOPS FOR MAKING BEER; WHEY BEVERAGES; VEGETABLE JUICES (U.S. CLS. 45, 46 AND 48).

SHAILA SETTLES, EXAMINING ATTORNEY

SN 79-031,246. FR-ONE, NAAMLOZE VENNOOTSCHAP, BELGIUM, FILED 10-24-2006.

FR-One

THE MARK CONSISTS OF STANDARD CHARACTERS WITHOUT CLAIM TO ANY PARTICULAR FONT, STYLE, SIZE, OR COLOR.

PRIORITY DATE OF 4-28-2006 IS CLAIMED.
OWNER OF INTERNATIONAL REGISTRATION 0904328 DATED 10-24-2006, EXPIRES 10-24-2016.

CLASS 23—YARNS AND THREADS

FOR YARNS AND THREADS, FOR TEXTILE USE (U.S. CL. 43).

CLASS 24—FABRICS

FOR CURTAINS OF TEXTILE, DOOR CURTAINS OF TEXTILE, UNFITTED FURNITURE COVERINGS OF TEXTILE, PLACEMATS OF TEXTILE, WALL HANGINGS OF TEXTILE, FABRICS, CUSHION COVERS OF TEXTILE, BED SPREADS OF TEXTILE (U.S. CLS. 42 AND 50).

PRISCILLA MILTON, EXAMINING ATTORNEY

SN 79-031,405. FR-ONE, NAAMLOZE VENNOOTSCHAP, BELGIUM, FILED 10-24-2006.



PRIORITY DATE OF 4-28-2006 IS CLAIMED.
OWNER OF INTERNATIONAL REGISTRATION 0904748 DATED 10-24-2006, EXPIRES 10-24-2016.

NO CLAIM IS MADE TO THE EXCLUSIVE RIGHT TO USE "FR", APART FROM THE MARK AS SHOWN.

THE COLOR(S) ORANGE, WHITE AND BLACK IS/ARE CLAIMED AS A FEATURE OF THE MARK.

THE COLORS ORANGE, WHITE AND BLACK APPEAR IN THE WORDING AND IN THE DESIGN; THE COLOR ORANGE APPEARS IN A RIGHT TRIANGLE ON WHICH IS IMPOSED A SQUARE IN WHICH THE LETTERS "F" AND "R" AND THE WORD "ONE" ARE WRITTEN IN WHITE AGAINST A BLACK BACKGROUND AND A BLACK FLAME DESIGN APPEARS ON A WHITE BACKGROUND.

CLASS 23—YARNS AND THREADS

FOR YARNS AND THREADS, FOR TEXTILE USE (U.S. CL. 43).

CLASS 24—FABRICS

FOR CURTAINS OF TEXTILE, DOOR CURTAINS OF TEXTILE, UNFITTED FURNITURE COVERINGS OF TEXTILE, PLACEMATS OF TEXTILE, WALL HANGINGS OF TEXTILE, FABRICS, CUSHION COVERS OF TEXTILE, BED SPREADS OF TEXTILE (U.S. CLS. 42 AND 50).

PRISCILLA MILTON, EXAMINING ATTORNEY

SN 79-031,417. JOS. SCHNEIDER OPTISCHE WERKE GMBH,
FED REP GERMANY, FILED 9-20-2006.

D-XENON

THE MARK CONSISTS OF STANDARD CHARACTERS WITHOUT CLAIM TO ANY PARTICULAR FONT, STYLE, SIZE, OR COLOR.

PRIORITY DATE OF 8-10-2006 IS CLAIMED.
OWNER OF INTERNATIONAL REGISTRATION 0904778
DATED 9-20-2006. EXPIRES 9-20-2016.
OWNER OF U.S. REG. NO. 328,527.

CLASS 9—ELECTRICAL AND SCIENTIFIC APPARATUS

FOR SCIENTIFIC, NAUTICAL, SURVEYING, ELECTRIC, ELECTRONIC, OPTO-ELECTRONIC, PHOTOGRAPHIC, CINEMATOGRAPHIC, OPTICAL, WEIGHING, MEASURING, SIGNALING, CHECKING AND SUPERVISION APPARATUS AND INSTRUMENTS, NAMELY, OPTICAL DETECTORS IN THE NATURE OF OPTICAL CHARACTER READERS AND OPTICAL SCANNERS, OPTICAL LENSES FOR SCANNING OR READING CHARACTERS IN A TELEFAXING OR COPYING APPARATUS; PHOTOGRAPHIC, CINEMATOGRAPHIC AND PROJECTION OBJECTIVES, NAMELY, COMBINATIONS OF PHOTOGRAPHIC LENSES FOR USE WITH CAMERAS, ENLARGERS AND PROJECTORS; LIGHT METERS, OPTICAL REFLECTORS, CONDENSERS, DIAPHRAGMS FOR CAMERAS, OPTICAL POWER SPLITTERS, DIGITAL SIGNAL PROCESSORS; PROJECTOR LAMPS AND FLASH LAMPS FOR CAMERAS; APPARATUS FOR RECORDING, TRANSMISSION OR REPRODUCTION OF SOUND AND IMAGES, NAMELY, FILM CAMERAS, VIDEO CAMERAS, PHOTOGRAPHIC PROJECTORS, OPTICAL/ELECTRICAL TRANSDUCERS, ELECTRICAL/OPTICAL TRANSDUCERS, FLAT PANEL DISPLAY SCREENS, ELECTRIC LUMINESCENT DISPLAY PANELS; BLANK MAGNETIC DATA CARRIERS; DATA-PROCESSING EQUIPMENT, NAMELY, COMPUTERS, COMPUTER INTERFACE BOARDS, OPTICAL COMPUTER INPUTS, NAMELY, INTERFACES; PRINTED CIRCUIT CARDS FOR INTERFACING COMPUTERS AND OPTICAL CHARACTER RECOGNITION DEVICES, NAMELY, INTERFACES; LENSES FOR USE WITH PHOTOGRAPHIC AND CINEMATOGRAPHIC CAMERAS; LENSES FOR USE IN AND FOR USE WITH PHOTOGRAPHIC AND CINEMATOGRAPHIC PROJECTORS; OPTICAL GLASSES, OPTICAL FIBERS SOLD AS A COMPONENT OF FIBER OPTICAL CABLES, FILTERS, NAMELY, OPTICAL FILTERS, CAMERA FILTERS (U.S. CLS. 21, 23, 26, 36 AND 38).

CLASS 42—SCIENTIFIC AND COMPUTER SERVICES

FOR DESIGN OF OBJECTIVES AND OPTICAL RECORDING, TRANSMISSION AND REPRODUCTION SYSTEMS FOR OTHERS (U.S. CLS. 100 AND 101).
MICHELLE DUBOIS, EXAMINING ATTORNEY

SN 79-031,551. MIROGLIO S.P.A., ITALY, FILED 9-27-2006.

C'EST COMME ÇA

OWNER OF INTERNATIONAL REGISTRATION 0886068
DATED 3-23-2006, EXPIRES 3-23-2016.
THE ENGLISH TRANSLATION OF THE WORD "C'EST COMME ÇA" IN THE MARK IS "THIS IS LIKE THAT".

CLASS 18—LEATHER GOODS

FOR LEATHER AND IMITATION LEATHER, GOODS MADE OF THESE MATERIALS NOT INCLUDED IN OTHER CLASSES, NAMELY, BRIEFCASES, SUITCASES, ATTACHE CASES, OVERNIGHT CASES, SHIRT CASES, SPORT BAGS, HAND-BAGS, PURSES, CHAIN PURSES, WALLETS, HAT BOXES AND CREDIT CARD HOLDERS; ANIMAL SKINS AND HIDES; TRUNKS AND SUITCASES; UMBRELLAS, PARASOLS AND WALKING STICKS; WHIPS AND SADDLERY (U.S. CLS. 1, 2, 3, 22 AND 41).

CLASS 24—FABRICS

FOR COTTON, WOOL AND SILK FABRICS AND TEXTILE GOODS NOT INCLUDED IN OTHER CLASSES, NAMELY, WALL HANGINGS, HANDKERCHIEFS, TOWELS, TAPESTRIES OF TEXTILE; UNFITTED BED AND TABLE COVERS (U.S. CLS. 42 AND 50).

CLASS 25—CLOTHING

FOR CLOTHING, NAMELY, JACKETS, VESTS, BELTS, NECKWEAR, SWEATERS, SUITS, SHIRTS, BLOUSES, SKIRTS, DRESSES, SCARVES, SHAWLS, BLAZERS, COATS, JEANS, TROUSERS, SLACKS, LOUNGEWEAR, T-SHIRTS, PANTSUITS, RAIN COATS, SHORTS, PLUSH SWEATERS, SPORT COATS, GLOVES, TIES, SWEATSHIRTS; FOOTWEAR, HEADWEAR (U.S. CLS. 22 AND 39).

TARAH HARDY, EXAMINING ATTORNEY

SN 79-031,557. TROCELLEN GMBH, D-53840 TROISDORF,
FED REP GERMANY, FILED 8-1-2006.



PRIORITY DATE OF 2-2-2006 IS CLAIMED.
OWNER OF INTERNATIONAL REGISTRATION 0905021
DATED 8-1-2006, EXPIRES 8-1-2016.

OWNER OF U.S. REG. NO. 1,846,734.
THE COLOR(S) BLUE AND GREEN IS/ARE CLAIMED AS A FEATURE OF THE MARK.

THE COLOR BLUE APPEARS ON THE MARK ABOVE THE TERM "TRO" AS A LINE OR A CURVE AND IN THE GLOBE ON THE MAP STANDING FOR THE WATER. THE COLOR GREEN APPEARS IN THE MARK IN THE WORDING "TROCELLEN" AND IN THE GLOBE ON THE MAP STANDING FOR THE LAND.

CLASS 17—RUBBER GOODS

FOR FOAMED PLASTIC, NAMELY, FOAM INSULATION FOR USE IN BUILDING AND CONSTRUCTION, FOAM SHEETING FOR USE AS A BUILDING INSULATION, PACKING FOAM IN SHEET FORM, POLYOLEFIN FOAM SHEETING FOR USE AS BUILDING INSULATION, FOAM IN ROLLS FOR SEALING, PACKING, THERMAL, ACOUSTIC, INSULATING USES; PLUMBING PIPES OF PLASTIC; SYNTHETIC PLASTIC, ESPECIALLY CONTAINING OR CONSISTING OF FOAMED PLASTIC, AS SEMI-FINISHED PRODUCTS IN FORM OF TUBES (U.S. CLS. 1, 5, 12, 13, 35 AND 50).

CLASS 19—NON-METALLIC BUILDING MATERIALS

FOR BUILDING MATERIALS MADE OF PLASTICS, ESPECIALLY MADE OF FOAMED PLASTICS, NAMELY, PLASTIC CONDUIT FOR DRAINAGE AND IRRIGATION, BUILDING MATERIALS, NAMELY, PLASTIC PIPE SUPPORTS, PLASTIC FLOORBOARDS, NON-METAL PIPES FOR BUILDING PURPOSES, ESPECIALLY CONTAINING OR CONSISTING OF FOAMED PLASTICS; PARQUETS WITH AN UNDERLAYER CONTAINING OR CONSISTING OF FOAMED PLASTICS (U.S. CLS. 1, 12, 33 AND 50).

CLASS 25—CLOTHING

FOR CLOTHING, NAMELY, JACKETS WITH ELBOW PADDING, TROUSERS WITH KNEE PADDING; FOOTWEAR; SHOE INSOLES (U.S. CLS. 22 AND 39).

CLASS 27—FLOOR COVERINGS

FOR FLOOR COVERINGS, NAMELY, MULTIPLY FLOOR COVERINGS; FOAMED PLASTIC MATS, NAMELY, FLOOR MATS, FLOOR SHEETS, PARQUET UNDERLAYER IN SHORT ROLLS (U.S. CLS. 19, 20, 37, 42 AND 50).

CLASS 28—TOYS AND SPORTING GOODS

FOR GAMES AND PLAYTHINGS, NAMELY, PUZZLE MATS, BABY MATS, SWIMMING BOARDS, WATER RINGS; GYMNAS TIC AND SPORTING ARTICLES, CONTAINING OR CONSISTING OF FOAMED PLASTICS, NAMELY, GYMNAS TIC MATS AND TATAMI MATS FOR USE IN THE PRACTICE OF MARTIAL ARTS (U.S. CLS. 22, 23, 38 AND 50).

JOHN DALIER, EXAMINING ATTORNEY

SN 79-031,679, WOLFFKRAN GMBH, FED REP GERMANY, FILED 5-31-2006.

WOLFFKRAN

THE MARK CONSISTS OF STANDARD CHARACTERS WITHOUT CLAIM TO ANY PARTICULAR FONT, STYLE, SIZE, OR COLOR.

PRIORITY DATE OF 12-5-2005 IS CLAIMED.

OWNER OF INTERNATIONAL REGISTRATION 0905395 DATED 5-31-2006, EXPIRES 5-31-2016.

CLASS 7—MACHINERY

FOR MACHINES FOR THE VERTICAL AND HORIZONTAL TRANSPORT OF GOODS, NAMELY, CRANES, IN PARTICULAR BUILDING CRANES, SLEWING CRANES, OVERHEAD CRANES, CONTAINER CRANES, LEVEL LUFFING CRANES, PORTAL CRANES; DETACHABLE CRANE COMPONENTS, NAMELY, TOWER SECTIONS, MAST SECTIONS, CROSS FRAMES, FOUNDATION ANCHORS, CLIMBING GEAR, JIBS, COUNTER JIBS, JIB EXTENSIONS, JIB SECTIONS, JIB WEIGHTS, TOWER TIES, TIE FRAMES, TIE RODS, UNDERCARRIAGES, PORTALS; SPARE PARTS FOR CRANES (U.S. CLS. 13, 19, 21, 23, 31, 34 AND 35).

CLASS 36—INSURANCE AND FINANCIAL

FOR LEASING OF CRANES (U.S. CLS. 100, 101 AND 102).

CLASS 37—CONSTRUCTION AND REPAIR

FOR RENTING OF CONSTRUCTION EQUIPMENT, NAMELY, CRANES; MAINTENANCE AND REPAIR OF MACHINES FOR THE VERTICAL AND HORIZONTAL TRANSPORT OF GOODS, NAMELY, CRANES (U.S. CLS. 100, 103 AND 106).

CLASS 38—COMMUNICATION

FOR TRANSMISSION OF NEWS VIA TELECOMMUNICATION AND TRANSMISSION AND RECEPTION OF DATABASE INFORMATION VIA TELECOMMUNICATION NETWORKS FOR THE PURPOSE OF SURVEILLANCE, MAINTENANCE, DIAGNOSIS, PROCUREMENT OF SPARE PARTS AND SERVICING OF CRANES; PROVISION OF MULTIPLE-USER ACCESS TO A GLOBAL COMPUTER INFORMATION NETWORK FOR THE SALE, RENTING AND LEASING OF CRANES (U.S. CLS. 100, 101 AND 104).

MICHAEL LEWIS, EXAMINING ATTORNEY

SN 79-031,714, AGROMILLORA CATALANA S.A., SPAIN, FILED 9-26-2006.



Olint
Growing for you.

OWNER OF INTERNATIONAL REGISTRATION 0905485 DATED 9-26-2006, EXPIRES 9-26-2016.

THE COLOR(S) GREEN, OCHRE IS/ARE CLAIMED AS A FEATURE OF THE MARK.

THE COLOR GREEN APPEARS IN THE WORDING "OLINT" AND THE COLOR OCHRE APPEARS IN THE WORDING "GROWING FOR YOU."

CLASS 16—PAPER GOODS AND PRINTED MATTER

FOR PUBLICATIONS ON PLANTS AND AGRICULTURE, NAMELY, PRINTED INSTRUCTIONAL AND TEACHING MATERIALS CONCERNING PLANTS AND AGRICULTURE (U.S. CLS. 2, 5, 22, 23, 29, 37, 38 AND 50).

CLASS 31—NATURAL AGRICULTURAL PRODUCTS

FOR AGRICULTURAL, HORTICULTURAL, AND FORESTRY PRODUCTS, SPECIFICALLY AGRICULTURAL, CROP, AND PLANT SEEDS; SEEDS FOR FRUITS AND VEGETABLES; NATURAL LIVE PLANTS AND FLOWERS (U.S. CLS. 1 AND 46).

CLASS 41—EDUCATION AND ENTERTAINMENT

FOR SERVICES OF TRAINING IN AGRICULTURAL TECHNIQUES; PRACTICAL TRAINING FEATURING DEMONSTRATIONS IN AGRICULTURAL TECHNIQUES; BOOK AND REVIEW PUBLISHING ON PLANTS AND AGRICULTURE; ELECTRONIC PUBLICATION ONLINE OF BOOKS AND MAGAZINES ON PLANTS AND AGRICULTURE; PROVIDING ONLINE NON-DOWNLOADABLE ELECTRONIC PUBLICATIONS IN THE NATURE OF MAGAZINES ON PLANTS AND AGRICULTURE (U.S. CLS. 100, 101 AND 107).

CLASS 44—MEDICAL, BEAUTY AND AGRICULTURAL SERVICES

FOR AGRICULTURAL, HORTICULTURAL, AND FORESTRY SERVICES, NAMELY, PLANT NURSERIES; RENTAL OF FARMING EQUIPMENT; TREE SURGERY (U.S. CLS. 100 AND 101).

CORY BOONE, EXAMINING ATTORNEY

SN 79-031,718. MIROGLIO S.P.A., ITALY, FILED 10-19-2006.



OWNER OF INTERNATIONAL REGISTRATION 0905504
DATED 10-19-2006, EXPIRES 10-19-2016.

SN 79-031,715. DEUTSCHE BANK AKTIENGESELLSCHAFT,
FED REP GERMANY, FILED 8-21-2006.

db express

THE MARK CONSISTS OF STANDARD CHARACTERS WITHOUT CLAIM TO ANY PARTICULAR FONT, STYLE, SIZE, OR COLOR.

PRIORITY DATE OF 2-24-2006 IS CLAIMED.
OWNER OF INTERNATIONAL REGISTRATION 0905486
DATED 8-21-2006, EXPIRES 8-21-2016.
OWNER OF U.S. REG. NO. 1,761,673.

CLASS 35—ADVERTISING AND BUSINESS

FOR BUSINESS SERVICES CONCERNING THE MANAGEMENT AND OPERATION OF INDUSTRIAL, TRADING AND SERVICES COMPANIES, NAMELY, ADVISORY SERVICES ON QUESTIONS REGARDING BUSINESS MANAGEMENT PLANNING, ORGANIZATION AND MANAGEMENT OF SUCH COMPANIES AS WELL AS WITH REGARD TO QUESTIONS REGARDING BUSINESS MANAGEMENT; ADVISORY SERVICES ON PERSONNEL MANAGEMENT AND RECRUITING; BUSINESS MANAGEMENT CONSULTING (U.S. CLS. 100, 101 AND 102).

CLASS 36—INSURANCE AND FINANCIAL

FOR FINANCIAL SERVICES, NAMELY, PROVIDING THE EXCHANGE OF FOREIGN CURRENCY VIA THE INTERNET; FINANCIAL SERVICES, NAMELY, PROVIDING INFORMATION REGARDING FOREIGN CURRENCY VIA THE INTERNET (U.S. CLS. 100, 101 AND 102).

CLASS 38—COMMUNICATION

FOR TELECOMMUNICATION SERVICES, NAMELY, TRANSMISSION OF VOICE, DATA AND DOCUMENTS, IN THE FIELD OF FOREIGN CURRENCIES; TELECOMMUNICATION SERVICES, NAMELY, TRANSMISSION OF PROGRAMS AND INFORMATION RELATING TO TRADE AND HANDLING OF FOREIGN CURRENCY, INTEREST RATES AND MONEY TRANSACTIONS, SECURITIES, AND FINANCIAL INVESTMENTS; ELECTRONIC TRANSMISSION OF DATA AND DOCUMENTS VIA THE INTERNET IN THE FIELD OF SECURITIES; PROVIDING ACCESS TO DATA IN TELECOMMUNICATION NETWORKS (U.S. CLS. 100, 101 AND 104).

CLASS 42—SCIENTIFIC AND COMPUTER SERVICES

FOR DEVELOPMENT OF COMPUTER PROGRAMS BY ORDER OF THIRD PARTIES WITH REGARD TO TRADE WITH FOREIGN CURRENCIES (U.S. CLS. 100 AND 101).

KENNETH E. SHARPERSON, EXAMINING ATTORNEY

CLASS 18—LEATHER GOODS

FOR LEATHER AND IMITATION LEATHER, GOODS MADE OF THESE MATERIALS NOT INCLUDED IN OTHER CLASSES, NAMELY, BRIEFCASES, SUITCASES, ATTACHE CASES, OVERNIGHT CASES, SHIRT CASES, SPORT BAGS, HAND-BAGS, PURSES, CHAIN PURSES, WALLETS, HAT BOXES AND CREDIT CARD HOLDERS; ANIMAL SKINS AND HIDES; TRUNKS AND SUITCASES; UMBRELLAS, PARASOLS AND WALKING STICKS; WHIPS AND SADDLERY (U.S. CLS. 1, 2, 3, 22 AND 41).

CLASS 24—FABRICS

FOR COTTON, WOOL AND SILK FABRICS AND TEXTILE GOODS NOT INCLUDED IN OTHER CLASSES, NAMELY, WALL HANGINGS, HANDKERCHIEFS, TOWELS, TAPESTRIES OF TEXTILE; UNFITTED BED AND TABLE COVERS (U.S. CLS. 42 AND 50).

CLASS 25—CLOTHING

FOR CLOTHING, NAMELY, JACKETS, VESTS, BELTS, NECKWEAR, SWEATERS, SUITS, SHIRTS, BLOUSES, SKIRTS, DRESSES, SCARVES, SHAWLS, BLAZERS, COATS, JEANS, TROUSERS, SLACKS, LOUNGEWEAR, T-SHIRTS, PANTSUITS, RAIN COATS, SHORTS, PLUSH SWEATERS, SPORT COATS, GLOVES, TIES, SWEATSHIRTS; FOOTWEAR, HEADWEAR (U.S. CLS. 22 AND 39).

TARAH HARDY, EXAMINING ATTORNEY

SN 79-031,875. ARISTOCRAT TECHNOLOGIES AUSTRALIA
PTY LTD, AUSTRALIA, FILED 3-29-2006.



OWNER OF INTERNATIONAL REGISTRATION 0905995
DATED 3-29-2006, EXPIRES 3-29-2016.

CLASS 9—ELECTRICAL AND SCIENTIFIC APPARATUS

FOR COMPUTER HARDWARE AND COMPUTER SOFTWARE BEING COMPUTER HARDWARE AND COMPUTER SOFTWARE FOR GAMING PURPOSES; GAMING MACHINES ADAPTED FOR USE WITH AN EXTERNAL DISPLAY SCREEN AND PARTS AND ACCESSORIES FOR GAMING MACHINES IN THIS CLASS, NAMELY, SOFTWARE MODULES, STORAGE MEDIA AND COMPONENTS AND ERASABLE PROGRAMMABLE READ-ONLY MEMORY (EPROM) CHIPS; BLANK MAGNETIC DATA CARRIERS, BLANK RECORDING DISCS; APPARATUS FOR RECORDING, TRANSMISSION, REPRODUCTION OR DISPLAY OF SOUND OR IMAGES; STORAGE MEDIA, NAMELY, BLANK COMPACT DISCS, DIGITAL VIDEO DISCS; DATA PROCESSORS; ELECTRONIC SYSTEMS FOR LINKING GAMING AND POKER MACHINES, NAMELY, CONTROLLERS, DISPLAYS, MACHINE INTERFACE CARDS, COMPUTER BOARDS, METRES, COMPUTER SOFTWARE AND FIRMWARE AND ELECTRICAL WIRES AND CABLE; COMPUTER PERIPHERALS (U.S. CLS. 21, 23, 26, 36 AND 38).

CLASS 28—TOYS AND SPORTING GOODS

FOR GAMING MACHINES OTHER THAN THOSE ADAPTED FOR USE WITH AN EXTERNAL DISPLAY SCREEN INCLUDING POKER MACHINES FEATURING GAMES OF CHANCE OR GAMES OF MIXED CHANCE AND SKILL OR PSEUDO SKILL; GAMING MACHINES OTHER THAN THOSE ADAPTED FOR USE WITH AN EXTERNAL DISPLAY SCREEN INCLUDING POKER MACHINES COMPRISED OF SOFTWARE MODULES AND COMPONENTS INCLUDING GAME SYMBOLS, MATHEMATICS, SOUND EFFECTS AND OTHER CONFIGURABLE ITEMS EMBEDDED IN ERASABLE PROGRAMMABLE READ-ONLY MEMORY (U.S. CLS. 22, 23, 38 AND 50).

WILLIAM ROSSMAN, EXAMINING ATTORNEY

SN 79-031,909. SCAVOLINI S.P.A., ITALY, FILED 8-23-2006.

SCAVOLINI

OWNER OF INTERNATIONAL REGISTRATION 0601444 DATED 12-22-1992, EXPIRES 12-22-2012.
OWNER OF U.S. REG. NO. 2,395,406.

CLASS 7—MACHINERY

FOR ELECTRIC HOUSEHOLD APPLIANCES, NAMELY, WASHING MACHINES AND DISHWASHERS (U.S. CLS. 13, 19, 21, 23, 31, 34 AND 35).

CLASS 11—ENVIRONMENTAL CONTROL APPARATUS

FOR KITCHEN SINKS AND TAP WATER FAUCETS; ELECTRICAL HOUSEHOLD APPLIANCES, NAMELY, REFRIGERATORS, FREEZERS, DEEP FREEZERS, OVENS, COOKTOPS, EXTRACTOR HOODS (U.S. CLS. 13, 21, 23, 31 AND 34).

DARRYL SPRUILL, EXAMINING ATTORNEY

SN 79-031,994. ALLARD GILLES, FRANCE, FILED 7-18-2006.

MK 30

THE MARK CONSISTS OF STANDARD CHARACTERS WITHOUT CLAIM TO ANY PARTICULAR FONT, STYLE, SIZE, OR COLOR.

PRIORITY DATE OF 1-19-2006 IS CLAIMED.

OWNER OF INTERNATIONAL REGISTRATION 0906190 DATED 7-18-2006, EXPIRES 7-18-2016.

CLASS 3—COSMETICS AND CLEANING PREPARATIONS

FOR TOILET CLEANING PREPARATIONS, CLEANING PREPARATIONS FOR HOUSEHOLD PURPOSES, SOAPS (U.S. CLS. 1, 4, 6, 50, 51 AND 52).

CLASS 5—PHARMACEUTICALS

FOR DISINFECTANTS FOR HYGIENE PURPOSES; ALL PURPOSE DISINFECTANTS; DISINFECTANT TOILET BOWL CLEANERS; AIR FRESHENERS (U.S. CLS. 6, 18, 44, 46, 51 AND 52).

SANJEEV VOHRA, EXAMINING ATTORNEY

SN 79-031,995. MOISES COSTA PRIMO JALECO, PORTUGAL, FILED 7-18-2006.



PRIORITY DATE OF 1-19-2006 IS CLAIMED.
OWNER OF INTERNATIONAL REGISTRATION 0906191 DATED 7-18-2006, EXPIRES 7-18-2016.

THE COLOR(S) RED, BLUE, YELLOW, WHITE AND GRAY IS/ARE CLAIMED AS A FEATURE OF THE MARK.

THE MARK CONSISTS OF A BORDERED BOX WITH THE WORD BOULEVARD IN THE CENTER OF THE BOX, ENCLOSED IN A RECTANGLE WHICH HAS TWO HALF-CIRCLES ON THE TOP AND BOTTOM OF SUCH RECTANGLE. THE TOP HALF-CIRCLE INCLUDES THE WORDING CHILL OUT AND THE BOTTOM HALF-CIRCLE INCLUDES THE WORDING CONCEPT. THE COLOR RED IS IN THE CENTER OF THE MARK IN A CIRCLE, AND ALSO IN THE WORDING BOULEVARD, THE COLOR BLUE IN AN OUTER RING, THE COLLOR YELLOW IS IN A RECTAGNULAR BOX AROUND BOULEVARD, AND IN THE WORDS CHILL OUT AND CONCEPT ARE IN WHITE, ALL OF WHICH IS SURROUNDED BY A GRAY BORDERED BOX.

CLASS 25—CLOTHING

FOR CLOTHING, NAMELY, SHIRTS, JUMPERS, PULLOVERS, SKIRTS, TROUSERS, BERMUDA SHORTS, SHORTS, COATS, DRESSES, T-SHIRTS, HATS, WOOLLEN HATS, APRONS, POLO-SHIRTS, UNIFORMS, SWEATSHIRTS, NECKERCHIEFS, GLOVES, SPORTS SHOES, SHOES, SLIPPERS, SANDALS, ESPADRILLES AND BOOTS (U.S. CLS. 22 AND 39).

CLASS 29—MEATS AND PROCESSED FOODS

FOR JELLIES (U.S. CL. 46).

CLASS 30—STAPLE FOODS

FOR COFFEE (U.S. CL. 46).

CLASS 35—ADVERTISING AND BUSINESS

FOR BUSINESS MANAGEMENT (U.S. CLS. 100, 101 AND 102).

CLASS 43—HOTEL AND RESTAURANT SERVICES

FOR SERVING FOOD AND DRINKS (U.S. CLS. 100 AND 101).

SANJEEV VOHRA, EXAMINING ATTORNEY

SN 79-032,053. EUROFEEDBACK, F-91017 EVRY CEDEX, FRANCE, FILED 9-22-2006.

ANTHELIA

PRIORITY DATE OF 3-22-2006 IS CLAIMED.
OWNER OF INTERNATIONAL REGISTRATION 0906375
DATED 9-22-2006, EXPIRES 9-22-2016.

CLASS 8—HAND TOOLS

FOR ELECTRIC APPARATUS FOR CAUSING BODY HAIR TO FALL OUT AND PREVENTING IT FROM GROWING BACK BY WAY OF A THERMAL EFFECT CREATED BY LIGHT FLASH EMISSION (U.S. CLS. 23, 28 AND 44).

CLASS 10—MEDICAL APPARATUS

FOR ELECTRIC APPARATUS FOR PHOTOTHERAPY BY EMISSION OF LIGHT FLASHES, ESPECIALLY FOR THE TREATMENT OF SKIN OR VASCULAR DEFECTS OR LESIONS FOR MEDICAL PURPOSES; ELECTRIC APPARATUS FOR COSMETIC OR MEDICAL PURPOSES FOR BIOSTIMULATION ESPECIALLY OF THE SKIN BY THE EMISSION OF LIGHT FLASHES (U.S. CLS. 26, 39 AND 44).

MICHELLE DUBOIS, EXAMINING ATTORNEY

SN 79-032,364. PHENEX PHARMACEUTICALS AG, FED REP GERMANY, FILED 9-7-2006.

SNuRM

THE MARK CONSISTS OF STANDARD CHARACTERS WITHOUT CLAIM TO ANY PARTICULAR FONT, STYLE, SIZE, OR COLOR.

PRIORITY DATE OF 3-24-2006 IS CLAIMED.
OWNER OF INTERNATIONAL REGISTRATION 0907121
DATED 9-7-2006, EXPIRES 9-7-2016.

CLASS 5—PHARMACEUTICALS

FOR PHARMACEUTICAL AND VETERINARY MEDICAL GOODS, NAMELY, PHARMACEUTICAL AND VETERINARY PREPARATIONS FOR VARIOUS CARDIOVASCULAR, METABOLIC, CANCER, ENDOCRINE AND RELATED DISORDERS; BIOLOGICAL AND CHEMICAL COMPOUNDS FOR MEDICAL AND VETERINARY MEDICAL PURPOSES FOR TREATMENT OF VARIOUS DISEASES WITH REDUCED ADVERSE EFFECTS; DIAGNOSTIC AGENTS AS WELL AS ENZYMES FOR MEDICAL PURPOSES (U.S. CLS. 6, 18, 44, 46, 51 AND 52).

CLASS 42—SCIENTIFIC AND COMPUTER SERVICES

FOR MEDICAL AND SCIENTIFIC, DIAGNOSTIC, SCIENTIFIC AND INDUSTRIAL RESEARCH; REALIZATION, NAMELY, RESEARCH AND DEVELOPMENT OF CHEMICAL AND BIOLOGICAL, PARTICULARLY BIOCHEMICAL, AND CELL CULTURE OR YEAST BASED ASSAYS; SCIENTIFIC RESEARCH FOR MEDICAL PURPOSES; ALL OF THE ABOVE NAMED SERVICES NOT FOR END USERS (U.S. CLS. 100 AND 101).

CLASS 44—MEDICAL, BEAUTY AND AGRICULTURAL SERVICES

FOR MEDICAL SERVICES (U.S. CLS. 100 AND 101).
KEVIN DINALLO, EXAMINING ATTORNEY

SN 79-032,408. INDUSTRIA EHF., IS-105 REYKJAVÍK, ICELAND, FILED 11-30-2005.

POWERING DIGITAL LIVING

THE MARK CONSISTS OF STANDARD CHARACTERS WITHOUT CLAIM TO ANY PARTICULAR FONT, STYLE, SIZE, OR COLOR.

PRIORITY DATE OF 5-31-2005 IS CLAIMED.
OWNER OF INTERNATIONAL REGISTRATION 0907213
DATED 11-30-2005, EXPIRES 11-30-2015.

NO CLAIM IS MADE TO THE EXCLUSIVE RIGHT TO USE "DIGITAL", APART FROM THE MARK AS SHOWN.

CLASS 9—ELECTRICAL AND SCIENTIFIC APPARATUS

FOR COMPUTER SOFTWARE FOR DELIVERY AND MANAGEMENT OF AUDIO AND VISUAL DIGITAL CONTENT; COMPUTER HARDWARE; SOFTWARE FOR BROADBAND TELECOMMUNICATIONS TO BE USED IN TELEVISION PROGRAMMING CONTROL UNITS, TELEVISIONS, MOBILE PHONES, PERSONAL DIGITAL ASSISTANTS, PERSONAL COMPUTERS, SERVERS; COMPUTER NETWORKING HARDWARE FOR USE WITH BROADBAND NETWORKS; FIBRE OPTIC CABLES; FIBRE OPTIC CABLES AND COPPER WIRING AND CABLES FOR USE IN CONNECTION WITH BROADBAND AND WIRELESS NETWORK COMMUNICATIONS; DEVICES FOR DIGITAL PRESENTATION AND TRANSMISSION OF MESSAGES AND COMMANDS, NAMELY, TELEVISION PROGRAMMING CONTROL UNITS, ROUTERS, DSL MODEMS, CABLE MODEMS AND TELEPHONES; ELECTRICAL DUCTS; SPLICES FOR OPTICAL FIBERS; TRANSMITTING AND RECEIVING HARDWARE FOR BROADCASTING DIGITAL TELEVISION SIGNALS; AND MODEMS (U.S. CLS. 21, 23, 26, 36 AND 38).

CLASS 38—COMMUNICATION

FOR TELECOMMUNICATIONS, NAMELY, DIGITAL TRANSMISSION SERVICES OF VOICE, AUDIO AND VISUAL CONTENT (U.S. CLS. 100, 101 AND 104).

CLASS 42—SCIENTIFIC AND COMPUTER SERVICES

FOR DESIGN AND DEVELOPMENT OF COMPUTER HARDWARE AND SOFTWARE; DEVELOPMENT OF BROADBAND SYSTEMS COMPRISED OF TELECOMMUNICATIONS HARDWARE AND SOFTWARE; DEVELOPMENT OF FIBER OPTIC COMMUNICATIONS SYSTEMS COMPRISED OF TELECOMMUNICATIONS HARDWARE AND SOFTWARE; TECHNICAL ENGINEERING (U.S. CLS. 100 AND 101).

DEBRA LEE, EXAMINING ATTORNEY

CLASS 9—ELECTRICAL AND SCIENTIFIC APPARATUS

FOR FINANCIAL SERVICES SOFTWARE NAMELY, SOFTWARE THAT ALLOWS USERS TO MONITOR, ANALYZE, AND GRAPH FINANCIAL TRANSACTIONS THAT MAY BE DOWNLOADED FROM A GLOBAL COMPUTER NETWORK; WEALTH MANAGEMENT SOFTWARE; SOFTWARE APPLICATIONS FOR CALCULATION AND GRAPHICAL PRESENTATION OF FINANCIAL DATA ASSOCIATED WITH FUNDS MANAGEMENT DATA; INVESTMENT PORTFOLIO MONITORING AND MEASUREMENT SOFTWARE; COMPUTER SOFTWARE FOR INVESTMENT MANAGEMENT, NAMELY INVESTMENT PERFORMANCE ANALYSIS SOFTWARE; SOFTWARE FOR CONSOLIDATION OF INVESTMENT DATA FOR MULTIPLE SOURCES; SOFTWARE ANALYTICAL TOOLS FOR INVESTMENT PORTFOLIOS FOR USE IN CALCULATING THE INVESTMENT PERFORMANCE AND FINANCIAL RETURNS OF A SET OF TRANSACTIONS (U.S. CLS. 21, 23, 26, 36 AND 38).

CLASS 36—INSURANCE AND FINANCIAL

FOR FINANCIAL CONSULTING, NAMELY ANALYTICAL SERVICES FOR INVESTMENT PORTFOLIOS (U.S. CLS. 100, 101 AND 102).

DEBRA LEE, EXAMINING ATTORNEY

SN 79-032,517. DONGWON F&B CO., LTD., SEOUL 137-717, REPUBLIC OF KOREA, FILED 12-7-2005.

SN 79-032,504. RICHARD CHARLES LEIGHTON DAVIS, SURRY HILLS NSW 2010, AUSTRALIA, FILED 12-2-2005.



PRIORITY DATE OF 6-30-2005 IS CLAIMED. OWNER OF INTERNATIONAL REGISTRATION 0907525 DATED 12-2-2005, EXPIRES 12-2-2015.



OWNER OF INTERNATIONAL REGISTRATION 0907555 DATED 12-7-2005, EXPIRES 12-7-2015. OWNER OF U.S. REG. NO. 1,504,139. THE COLOR(S) RED, ORANGE, PURPLE, AND WHITE IS/ARE CLAIMED AS A FEATURE OF THE MARK. THE MARK CONSISTS OF THE COLORS RED, ORANGE, PURPLE, AND WHITE. THE COLOR WHITE APPEARS ON THE FOREIGN CHARACTERS, THE COLOR RED APPEARS ON THE RECTANGULAR CARRIER WITH THE COLORS ORANGE AND PURPLE APPEARING ON THE BOTTOM LEFT AND RIGHT CORNERS OF THE CARRIER. THE TRANSLITERATION OF THE NON-LATIN CHARACTERS IN THE MARK IS: YANGBAN. AN SOCIETY IN ENGLISH."

CLASS 29—MEATS AND PROCESSED FOODS

FOR PRESERVED BEANS; PRESERVED GINSENG FOR USE AS A VEGETABLE; KIMCHI, NAMELY, PICKLED VEGETABLES IN THE NATURE OF RADISH, CABBAGE OR CUCUMBER SPICED WITH PEPPER, GARLIC, ONION, GINGER; CANNED FRUITS; TOFU; PRESERVED CHESTNUTS; PRESERVED WALNUTS; POTATO CHIPS; CHICKEN; BEEF JERKY; HAM; MILK; CHEESE; OLIVE OIL FOR FOOD; SHRIMPS NOT BEING LIVE; TUNA FISH, NOT BEING LIVE; DRIED AND PRESERVED SWEET LAVER; DRIED AND PRESERVED SEA TANGLE IN THE NATURE OF SEAWEED; DRIED AND PRESERVED BROWN SEAWEED; DRIED FISH AND SHELLFISH, NAMELY, DRIED TUNA FISH, DRIED SALMON, DRIED MACKEREL, DRIED MACKEREL PIKE, DRIED SARDINES, DRIED SEA MUSSELS, AND DRIED OYSTERS; STEAMED OR TOASTED CAKES OF FISH PASTE; CANNED FISH, NAMELY, CANNED TUNA FISH, CANNED SALMON, CANNED MACKEREL, CANNED MACKEREL PIKE, AND CANNED SARDINES; SMOKED FISH, NAMELY, SMOKED TUNA FISH, SMOKED SALMON, SMOKED MACKEREL, SMOKED MACKEREL PIKE, AND SMOKED SARDINES; DOYN-JAN, BEING FERMENTED SOYBEAN PASTE (U.S. CL. 46).

CLASS 30—STAPLE FOODS

FOR RICE; WHEAT FLOUR FOR FOOD; ALMOND PASTE; PACKED BOILED RICE; RA-MYUN, BEING INSTANT NOODLES; SANDWICHES; BAKING POWDER; COOKIES; DUMPLINGS; HONEY; RICE CAKES; GOCHU-JANG, BEING FERMENTED HOT PEPPER PASTE FOR USE AS A CONDIMENT; DRESSINGS FOR SALAD; HOT PEPPER POWDER FOR USE AS A SPICE; SPICED SALT; GRAVIES; MEAT TENDERIZERS FOR HOUSEHOLD PURPOSES (U.S. CL. 46).
DEBRA LEE, EXAMINING ATTORNEY

SN 79-032,588. ETHER DIGITAL LIMITED, UNITED KINGDOM, FILED 5-26-2006.

MIOMNI

PRIORITY DATE OF 4-12-2006 IS CLAIMED.
OWNER OF INTERNATIONAL REGISTRATION 0907761
DATED 5-26-2006, EXPIRES 5-26-2016.

CLASS 9—ELECTRICAL AND SCIENTIFIC APPARATUS

FOR COMPUTER SOFTWARE FOR USE IN TRANSMISSION AND REPRODUCTION OF TEXT, SOUNDS AND IMAGES; BLANK COMPACT DISCS; COMPUTER GAME SOFTWARE; DOWNLOADABLE SOFTWARE FOR USE IN VIEWING AND MANAGING IPTV DIGITAL CONTENT; COMPUTER SOFTWARE FOR THE CREATION OF USER INTERFACES; DOWNLOADABLE TELEPHONE RING TONES; TELEPHONE SCREEN SAVER SOFTWARE; MUSICAL SOUND RECORDINGS; MOTION PICTURE FILMS FEATURING COMEDY, DRAMA, ACTION, ADVENTURE AND/OR ANIMATION, AND MOTION PICTURE FILMS FOR BROADCAST ON TELEVISION AND OVER THE INTERNET FEATURING COMEDY, DRAMA, ACTION, ADVENTURE AND/OR ANIMATION; COMPUTER SOFTWARE FOR PROCESSING DIGITAL MUSIC FILES (U.S. CLS. 21, 23, 26, 36 AND 38).

CLASS 16—PAPER GOODS AND PRINTED MATTER

FOR PRINTED MATTER, NAMELY PRINTED CALENDARS; INFORMATIONAL FLYERS FEATURING IPTV; BROCHURES ABOUT IPTV DIGITAL CONTENT DOWNLOADABLE SOFTWARE; MANUALS IN THE FIELD OF IPTV SOFTWARE TECHNOLOGY; USER GUIDES IN THE FIELD OF IPTV SOFTWARE TECHNOLOGY (U.S. CLS. 2, 5, 22, 23, 29, 37, 38 AND 50).

CLASS 38—COMMUNICATION

FOR TELECOMMUNICATIONS ACCESS SERVICES; ELECTRONIC MAIL SERVICES; ELECTRONIC TRANSMISSION OF MESSAGES AND DATA; ELECTRONIC TRANSMISSION OF DATA AND DOCUMENTS VIA COMPUTER TERMINALS (U.S. CLS. 100, 101 AND 104).

CLASS 42—SCIENTIFIC AND COMPUTER SERVICES

FOR DESIGN, DEVELOPMENT AND IMPLEMENTATION OF SOFTWARE THAT ENABLES THE TRANSMISSION AND DELIVERY OF DIGITAL MUSIC, ELECTRONIC GAMES SERVICES, INTERNET GAMES, SOUND RECORDINGS, MOTION PICTURES AND NON-DOWNLOADABLE TEXT PROVIDED FROM THE INTERNET; COMPUTER SOFTWARE DEVELOPMENT SERVICES FOR SERVICES TO BE DELIVERED ONLINE VIA A COMPUTER DATABASE OR THE INTERNET (U.S. CLS. 100 AND 101).

SANJEEV VOHRA, EXAMINING ATTORNEY

SN 79-032,605. EDUN APPAREL LIMITED, IRELAND, FILED 6-6-2006.



PRIORITY DATE OF 12-20-2005 IS CLAIMED.
OWNER OF INTERNATIONAL REGISTRATION 0907800
DATED 6-6-2006, EXPIRES 6-6-2016.

CLASS 3—COSMETICS AND CLEANING PREPARATIONS

FOR BLEACHING PREPARATIONS AND SUBSTANCES FOR LAUNDRY USE, NAMELY, LAUNDRY DETERGENT, LAUNDRY SOAP, FABRIC SOFTENERS, ESSENTIAL OILS AS PERFUME FOR LAUNDRY PURPOSES; GENERAL PURPOSE CLEANING, POLISHING AND ABRASIVE LIQUIDS AND POWDERS; SOAPS; PERFUMERY, ESSENTIAL OILS, COSMETICS; HAIR LOTIONS; DENTRIFICES; MAKE-UP, LIPSTICK, LIP BALM, LIP GLOSS, MASCARA, EYEBROW PENCILS, FACE CREAMS, HAND CREAMS, NAIL POLISH, PERFUMES AND FRAGRANT BODY SPRAYS (U.S. CLS. 1, 4, 6, 50, 51 AND 52).

CLASS 4—LUBRICANTS AND FUELS

FOR CANDLES AND WICKS FOR LIGHTING (U.S. CLS. 1, 6 AND 15).

CLASS 8—HAND TOOLS

FOR HAND TOOLS, NAMELY, KNIFE SHARPENERS; CUTLERY; KNIVES, NAMELY, CARVING KNIVES, KITCHEN KNIVES, TABLE KNIVES AND STEAK KNIVES; RAZORS (U.S. CLS. 23, 28 AND 44).

CLASS 9—ELECTRICAL AND SCIENTIFIC APPARATUS

FOR APPARATUS FOR RECORDING, TRANSMISSION OR REPRODUCTION OF SOUND OR IMAGES; BLANK MAGNETIC DATA CARRIERS; PRE-RECORDED MAGNETIC DATA CARRIERS FEATURING MUSIC OR MOVIES; BLANK RECORDABLE OPTICAL DISC; CALCULATORS; DATA PROCESSORS; COMPUTERS; CELLULAR TELEPHONES; OPTICAL LENSES, EYEGLASS FRAMES, SUNGLASSES; EYE GLASS CASES (U.S. CLS. 21, 23, 26, 36 AND 38).

CLASS 11—ENVIRONMENTAL CONTROL APPARATUS

FOR LIGHTING FIXTURES, DESK LAMPS, FLOOR LAMPS, TABLE LAMPS, WALL LAMPS, CANDLE LANTERNS, ELECTRIC LIGHTS FOR CHRISTMAS TREES, ELECTRIC NIGHTLIGHTS, FLASH LIGHTS, LAMP SHADES (U.S. CLS. 13, 21, 23, 31 AND 34).

CLASS 14—JEWELRY

FOR PRECIOUS METALS AND THEIR ALLOYS; JEWELRY MADE OF PRECIOUS AND NON-PRECIOUS STONES; JEWELRY MADE OF PRECIOUS AND NON-PRECIOUS METALS (U.S. CLS. 2, 27, 28 AND 50).

CLASS 16—PAPER GOODS AND PRINTED MATTER

FOR PAPER, CARDBOARD AND GOODS MADE FROM THESE MATERIALS, NAMELY TAGS AND LABELS MADE OF PAPER OR CARDBOARD, CARDBOARD PACKAGING, PACKING PAPER, GIFT BOXES MADE OF CARDBOARD, GIFT WRAPPING PAPER, SHOPPING BAGS MADE OF PAPER; PRINTED MATTER, NAMELY, CATALOGUES, NEWSLETTERS AND MAGAZINES RELATING TO HOME FURNISHINGS, CLOTHING, CLOTHING AND FASHION ACCESSORIES, FASHION AND LIFESTYLE SUBJECTS; PHOTOGRAPHS; STATIONERY; ADHESIVES FOR STATIONERY OR HOUSEHOLD PURPOSES; ARTISTS' MATERIALS, NAMELY, ARTISTS' PENS, ARTISTS' BRUSHES, ARTISTS' PASTELS; PAINT BRUSHES; OFFICE REQUISITES NAMELY, PENCILS AND PENS, PENCIL SHARPENERS, ERASERS, STENCILS, NOTEBOOKS, ADDRESS BOOKS, CALENDARS, STICKERS, MARKERS, PERSONAL ORGANIZERS AND DAILY PLANNERS, AGENDA BOOKS, RUBBER BANDS, STAPLERS; PLASTIC MATERIALS FOR PACKAGING, NAMELY, PLASTIC BAGS FOR PACKAGING, PLASTIC BUBBLE PACKS FOR WRAPPING OR PACKAGING (U.S. CLS. 2, 5, 22, 23, 29, 37, 38 AND 50).

CLASS 18—LEATHER GOODS

FOR TRUNKS AND TRAVELLING BAGS; SHOPPING BAGS MADE OF LEATHER; HANDBAGS; WALLETS, KEY CASES, PURSES, COSMETIC BAGS SOLD EMPTY; BRIEF CASE TYPE PORTFOLIOS; SUIT BAGS; TRUNKS; SUITCASES; DUFFLE BAGS; TOTE BAGS, BRIEF CASES AND ATTACHE CASES; CREDIT CARD CASES; BUSINESS CARD CASES; UMBRELLAS; PARASOLS AND WALKING STICKS (U.S. CLS. 1, 2, 3, 22 AND 41).

CLASS 20—FURNITURE AND ARTICLES NOT OTHERWISE CLASSIFIED

FOR FURNITURE, MIRRORS, PICTURE FRAMES (U.S. CLS. 2, 13, 22, 25, 32 AND 50).

CLASS 21—HOUSEWARES AND GLASS

FOR HOUSEHOLD AND KITCHEN UTENSILS NOT OF PRECIOUS METALS OR COATED THEREWITH, NAMELY, GRATERS, SIEVES, SPATULAS, STRAINERS, TURNERS, WHISKS, SALAD SERVING SPOONS AND FORKS; CONTAINERS FOR HOUSEHOLD OR KITCHEN USE NOT OF PRECIOUS METALS OR COATED THEREWITH, NAMELY, TOWEL HOLDERS, TOILET TISSUE HOLDERS, SOAP HOLDERS, SOAP DISHES, SOAP DISPENSERS, TRASH CANS; HAIR COMBS, HAIR BRUSHES, TOOTHBRUSHES, DUSTING BRUSHES, TOILET BRUSHES; UNWORKED OR SEMI-WORKED GLASS EXCEPT GLASS USED IN BUILDING; CRYSTAL AND GLASS BEVERAGES GLASSWARE; PORCELAIN AND CHINA, NAMELY, DISHES, BOWLS, PLATES, SERVING PLATTERS, CUPS, SAUCERS, CANDLESTICK HOLDERS, SALT AND PEPPER SHAKERS, JUGS, VASES; CERAMIC ACCESSORIES, NAMELY, SOAP DISHES, SOAP HOLDERS, TOOTHBRUSH HOLDERS, TOWEL RINGS; PORCELAIN AND EARTHENWARE FIGURINES (U.S. CLS. 2, 13, 23, 29, 30, 33, 40 AND 50).

CLASS 24—FABRICS

FOR TEXTILE GOODS, NAMELY, CLOTH TEXTILES FOR USE IN MANUFACTURE OF CLOTHING, TEXTILE WALL HANGINGS, TEXTILE USED AS LINING FOR CLOTHING, TEXTILE LABELS, TAPESTRIES OF TEXTILE, FELT AND NON-WOVEN TEXTILE FABRICS, CURTAINS AND DRAPERIES ALL MADE OUT OF TEXTILE MATERIALS; BED COVERS, NAMELY, EIDERDOWNS, DUVETS, DUVET COVERS; BED BLANKETS, BED SHEETS, BED QUILTS, BED SKIRTS, BEDSPREADS, PILLOWCASES, MATTRESS COVERS; TABLE COVERS, NAMELY, TABLE LINEN, TABLECLOTHS NOT OF PAPER, TABLE NAPKINS NOT OF PAPER, TABLE MATS NOT OF PAPER (U.S. CLS. 42 AND 50).

CLASS 25—CLOTHING

FOR CLOTHING, NAMELY, COATS, JACKETS, PANTS, JEANS, SUITS, SHIRTS, T-SHIRTS, BLOUSES, TOPS, TANK TOPS, SWEATERS, PONCHOS, VESTS, SHORTS, SKIRTS, DRESSES, UNDERWEAR, SWIMWEAR, SWIMWEAR COVER-UPS, PYJAMAS, BATHROBES, SOCKS, SCARVES, BANDANAS, BELTS, HATS, CAPS, FOOTWEAR (U.S. CLS. 22 AND 39).

CLASS 26—FANCY GOODS

FOR LACE AND EMBROIDERY, RIBBONS AND BRAID; BUTTONS FOR CLOTHING, NAMELY, SHIRT BUTTONS, RIVET BUTTONS, CLOTHING BUTTONS ATTACHED BY CLIPS, NOVELTY BUTTONS, ORNAMENTAL NOVELTY BUTTONS; HOOKS AND EYES, HAIR PINS, ORIENTAL HAIR PINS; ARTIFICIAL FLOWERS (U.S. CLS. 37, 39, 40, 42 AND 50).

CLASS 27—FLOOR COVERINGS

FOR CARPETS, RUGS, MATS AND MATTING, LINOLEUM FOR COVERING EXISTING FLOORS; NON-TEXTILE WALL HANGINGS (U.S. CLS. 19, 20, 37, 42 AND 50).

CLASS 35—ADVERTISING AND BUSINESS

FOR ADVERTISING, PROMOTION AND MARKETING SERVICES; BUSINESS MANAGEMENT; BUSINESS ADMINISTRATION AND MANAGEMENT; THE BRINGING TOGETHER, FOR THE BENEFIT OF OTHERS, OF A VARIETY OF GOODS, ENABLING CUSTOMERS TO CONVENIENTLY VIEW AND PURCHASE THOSE GOODS IN A RETAIL CLOTHES AND HOME FURNISHINGS STORE, AND FROM A CLOTHING, HOME FURNISHINGS CATALOGUE BY MAIL ORDER OR BY MEANS OF TELECOMMUNICATIONS, OR BY MEANS OF THE INTERNET; RETAIL STORE SERVICES AND MAIL ORDER SERVICES FEATURING CLOTHING, FOOTWEAR, HEADGEAR, PERFUMERY, TOILETRIES, COSMETICS, CUTLERY, JEWELRY, WATCHES, CLOCKS, GLASSES, SUNGLASSES, STATIONERY, LEATHER GOODS, FURNITURE, HOME FURNISH-

INGS, HOUSEWARES, GLASSWARE, PORCELAIN, FLOOR, WINDOW AND WALL COVERINGS; ONLINE RETAIL STORE SERVICES, FEATURING CLOTHING, FOOTWEAR, HEADGEAR, PERFUMERY, TOILETRIES, COSMETICS, CUTLERY, JEWELRY, WATCHES, CLOCKS, GLASSES, SUNGLASSES, STATIONERY, LEATHER GOODS, FURNITURE, HOME FURNISHINGS, HOUSEWARES, GLASSWARE, PORCELAIN, FLOOR, WINDOW AND WALL COVERINGS; ADVERTISING SERVICES, NAMELY, COMPILATION OF ADVERTISEMENTS FOR USE AS WEB PAGES ON THE INTERNET; PROVISION OF ADVERTISING SPACE ON WEB SITES; OPERATING ON-LINE MARKETPLACES FOR SELLERS OF GOODS; ADVISORY AND INFORMATION SERVICES RELATING TO THE AFORESAID (U.S. CLS. 100, 101 AND 102).

GILBERT SWIFT, EXAMINING ATTORNEY

SN 79-032,654. MICRONAS GMBH, FED REP GERMANY, FILED 2-22-2006.

MICROMAP

THE MARK CONSISTS OF STANDARD CHARACTERS WITHOUT CLAIM TO ANY PARTICULAR FONT, STYLE, SIZE, OR COLOR.

PRIORITY DATE OF 8-26-2005 IS CLAIMED.

OWNER OF INTERNATIONAL REGISTRATION 0907915 DATED 2-22-2006, EXPIRES 2-22-2016.

CLASS 9—ELECTRICAL AND SCIENTIFIC APPARATUS

FOR ELECTRICAL AND ELECTRONIC COMPONENTS AND DEVICES INCLUDED IN THIS CLASS, NAMELY, HYBRID CIRCUITS AND SYSTEMS COMPOSED THEREOF, NAMELY, ELECTRICAL CIRCUIT BOARDS AND COMPUTER PLUG-IN CARDS HAVING ELECTRIC AND ELECTRONIC CIRCUITRY AND COMPONENTS MOUNTED THEREON; SEMICONDUCTORS; SEMICONDUCTOR DEVICES, NAMELY, TRANSISTORS, DIODES, ELECTRONIC MEMORIES, ELECTRONIC SENSORS, INTEGRATED CIRCUITS, SILICON WAFERS; HIGHLY INTEGRATED CIRCUITS, PARTICULARLY FOR AUTOMOBILE INSTRUMENTATION AND CAR DASHBOARD ELECTRONICS; DEVICES FOR ENTERTAINMENT ELECTRONICS, NAMELY, CD PLAYERS, MP3 PLAYERS, DVD PLAYERS, DIGITAL VIDEO AND AUDIO PLAYERS; DEVICES FOR CAR DASHBOARDS AND INSTRUMENTS INCLUDED IN THIS CLASS, NAMELY, RADAR DETECTORS, RADIOS FOR VEHICLES AND AUDIO AND VIDEO PLAYBACK DEVICES; SEMICONDUCTORS AND ANALOG AND DIGITAL MOBILE PHONES; SIGNAL PROCESSORS, NAMELY, DIGITAL SIGNAL PROCESSORS; DECODERS FOR TV SETS AND VIDEO UNITS; APPARATUS FOR ENTERTAINMENT ELECTRONICS, NAMELY, CABLE TELEVISION RECEIVERS, BROADCAST RECEIVERS AND SATELLITE RECEIVERS; TAPE RECORDING APPARATUS AND SOUND REPRODUCTION APPARATUS AS WELL AS RECORDING APPARATUS AND REPLAY APPARATUS FOR OTHER SOUND AND IMAGE CARRIERS, NAMELY, SOUND RECORDING APPARATUS, APPARATUS FOR SPEECH RECORDING AND REPLAYING; AMPLIFIERS; LOUDSPEAKERS; APPARATUS FOR RECORDING, TRANSMISSION OR REPRODUCTION OF IMAGE AND SOUND, NAMELY, FLAT PANEL DISPLAY SCREENS, MOVIE PROJECTORS, DIGITAL VIDEO RECORDERS, VIDEO PROJECTORS; PRESSURE SENSORS, PARTICULARLY FOR AIR PRESSURE MEASUREMENT; MAGNETIC FIELD SENSORS, PARTICULARLY FOR MOTOR CONTROL; FREQUENCY FILTERS PARTICULARLY FOR HIGH FREQUENCIES AND TELECOMMUNICATION, NAMELY, FILTERS FOR RADIO INTERFERENCE SUPPRESSION; DATA PROCESSORS AND DATA PROCESSING SYSTEMS COMPOSED OF COMPUTERS; COMPUTERS; COMPUTER HARDWARE; COMPUTER SOFTWARE TO CONTROL AND IMPROVE DIGITAL AUDIO AND VIDEO QUALITY; COMPUTER PRO-

GRAMS TO CONTROL AND IMPROVE DIGITAL AUDIO AND VIDEO QUALITY; DOWNLOADABLE SOFTWARE TO CONTROL AND IMPROVE DIGITAL AUDIO AND VIDEO QUALITY (U.S. CLS. 21, 23, 26, 36 AND 38).

CLASS 38—COMMUNICATION

FOR PROVIDING MULTIPLE USER ACCESS TO GLOBAL COMPUTER NETWORKS; PROVIDING ACCESS TO DATABASES VIA THE INTERNET AND VIA OTHER COMMUNICATIONS NETWORKS; TRANSMISSION OF INFORMATION VIA THE INTERNET AND OTHER ELECTRONIC COMMUNICATIONS NETWORKS INCLUDED IN THIS CLASS; FORWARDING OF DATA ON THE INTERNET AND OTHER COMMUNICATION NETWORKS, NAMELY, E-MAIL FORWARDING SERVICES; NEWS TRANSMISSION AND PICTURE TRANSMISSION VIA COMPUTER; TRANSMISSION OF NEWS; TELECOMMUNICATION BY FIBER OPTIC NETWORKS; CONSULTANCY RELATING TO TELECOMMUNICATION TECHNIQUES (U.S. CLS. 100, 101 AND 104).

CLASS 42—SCIENTIFIC AND COMPUTER SERVICES

FOR DESIGN AND DEVELOPMENT OF SOFTWARE, OF SEMICONDUCTOR DEVICES, OF MICROPROCESSORS, OF ELECTRICAL AND ELECTRONIC CIRCUITS AND APPARATUS FOR RECORDING, TRANSMISSION AND REPRODUCTION OF IMAGE AND SOUND; TECHNOLOGICAL CONSULTATION IN THE FIELD OF TELECOMMUNICATIONS TECHNOLOGY, COMPUTER HARDWARE AND SOFTWARE, SEMICONDUCTOR DEVICES, MICROPROCESSORS, ELECTRICAL AND ELECTRONIC CIRCUITS AND APPARATUS FOR RECORDING, TRANSMISSION AND REPRODUCTION OF IMAGE AND SOUND; ENGINEERING CONSULTANCY; HARDWARE AND SOFTWARE CONSULTANCY; SERVICES OF PHYSICISTS AND ENGINEERS; PHYSICAL AND TECHNICAL RESEARCH IN THE FIELD OF SEMICONDUCTORS; INFORMATION TECHNOLOGY CONSULTATION, NAMELY, DEVELOPMENT OF TECHNICAL USER CONCEPTS; PROVIDING INFORMATION TECHNOLOGY INFORMATION VIA THE INTERNET AND OTHER COMMUNICATIONS MEDIA; ONLINE PROVISION OF NON-DOWNLOADABLE SOFTWARE TO CONTROL AND IMPROVE DIGITAL AUDIO AND VIDEO QUALITY (U.S. CLS. 100 AND 101).

CARRIE GENOVESE, EXAMINING ATTORNEY

SN 79-032,814. KORKMAZ MUTFAK ESYALARI; SANAYI VE TICARET; ANONIM SIRKETI, TURKEY, FILED 9-1-2006.

KORKMAZ



OWNER OF INTERNATIONAL REGISTRATION 0908301 DATED 9-1-2006, EXPIRES 9-1-2016.

CLASS 8—HAND TOOLS

FOR TABLE CUTLERY, NAMELY, KNIVES, SPOONS, FORKS, TABLE CUTLERY MADE OF PRECIOUS METALS OR COATED THEREWITH, NAMELY, KNIVES, SPOONS AND FORKS (U.S. CLS. 23, 28 AND 44).

CLASS 11—ENVIRONMENTAL CONTROL APPARATUS

FOR ELECTRIC OR GAS COOKING APPARATUS, NAMELY, OVENS, BAKERS' OVENS, ELECTRIC TOASTERS, GAS WATER HEATERS, GRILLS, DEEP FAT FRYER, HOT PLATES, ELECTRIC PRESSURE COOKERS, STOVES AND ELECTRIC HEATING FANS (U.S. CLS. 13, 21, 23, 31 AND 34).

CLASS 21—HOUSEWARES AND GLASS

FOR HOUSEHOLD OR KITCHEN UTENSILS AND CONTAINERS INCLUDED IN THIS CLASS, NOT OF PRECIOUS METAL OR COATED THEREWITH, NAMELY, COOKING POTS, PANS, TEAPOTS, NON-ELECTRIC PRESSURE COOKERS, COOKING POT SETS, STEW-PANS, FRYING PANS, GLASS DISHES, GLASS BOWLS, GLASS BEVERAGeware, NON-ELECTRIC COOKING UTENSILS, NAMELY, WIRE BASKETS AND GRILL COVERS, BAKING TRAYS, ICE CUBE MOLDS, CAKE MOLDS, COOKERY MOLDS, THERMAL INSULATED CONTAINERS FOR FOOD OR BEVERAGE, INSULATED FLASKS, COOKING STRAINERS, BOWLS, BUCKETS, GARBAGE CANS, EGG CUPS, FLOWER POTS, SOAP DISPENSERS, FITTED PICNIC BASKETS (U.S. CLS. 2, 13, 23, 29, 30, 33, 40 AND 50).

JAMES LOVELACE, EXAMINING ATTORNEY

CLASS 43—HOTEL AND RESTAURANT SERVICES

FOR SERVICES FOR PROVIDING FOOD AND DRINK, NAMELY, SERVING FOOD AND DRINKS, PROVIDING OF FOOD AND DRINKS FOR GUESTS, CATERING OF FOOD AND DRINKS (U.S. CLS. 100 AND 101).

JAY BESCH, EXAMINING ATTORNEY

SN 79-033,124. NICE SPA, ODERZO (TREVISO), ITALY, FILED 9-7-2006.

NICEFORYOU

THE MARK CONSISTS OF STANDARD CHARACTERS WITHOUT CLAIM TO ANY PARTICULAR FONT, STYLE, SIZE, OR COLOR.

PRIORITY DATE OF 3-9-2006 IS CLAIMED.

OWNER OF INTERNATIONAL REGISTRATION 0909090

DATED 9-7-2006, EXPIRES 9-7-2016.

OWNER OF U.S. REG. NO. 2,671,087.

SN 79-032,926. HARRY MARK ZINSSER-KRYS, FED REP GERMANY, AND KURT RUHFAB, FED REP GERMANY, FILED 10-27-2006.

Sportspig

THE MARK CONSISTS OF STANDARD CHARACTERS WITHOUT CLAIM TO ANY PARTICULAR FONT, STYLE, SIZE, OR COLOR.

OWNER OF INTERNATIONAL REGISTRATION 0908576 DATED 10-27-2006, EXPIRES 10-27-2016.

CLASS 25—CLOTHING

FOR CLOTHING, NAMELY, SWEATSHIRTS, T-SHIRTS AND SPORTS JERSEYS; FOOTWEAR, NAMELY, BOOTS FOR SPORTS; HEADGEAR, NAMELY, SPORTS CAPS (U.S. CLS. 22 AND 39).

CLASS 41—EDUCATION AND ENTERTAINMENT

FOR ENTERTAINMENT, NAMELY, PRESENTATION OF LIVE SPORT EVENTS AND A CONTINUING SPORTS SHOW BROADCAST OVER TELEVISION FEATURING FOOTBALL, SOCCER, HOCKEY, RUGBY, DARTS, BASKETBALL AND BASEBALL MATCHES, AND AUTOMOTIVE RACES; ENTERTAINMENT VIA THE INTERNET, NAMELY, PROVIDING AN ON-LINE COMPUTER GAME, PROVIDING ON-LINE REVIEWS OF SPORTS AND SPORTING EVENTS, PROVIDING A WEBSITE FEATURING SPORTS INFORMATION, FANTASY SPORTS LEAGUES; ORGANIZING SPORTING AND CULTURAL ACTIVITIES, NAMELY, ARRANGING AND CONDUCTING OF COMPETITIONS IN THE NATURE OF TABLE FOOTBALL, BILLIARDS AND DARTS (U.S. CLS. 100, 101 AND 107).

CLASS 7—MACHINERY

FOR MOTORS EXCEPT THOSE FOR LAND VEHICLES; PLANETARY GEAR MOTORS, MECHANICAL APPARATUSES AND OIL PRESSURE APPARATUSES FOR OPENING AND CLOSING MOSQUITO NETS, DOORS, GATES, BARRIERS, SHUTTERS, SHIELDS, CURTAINS, WINDOWS, INDUSTRIAL ROOF LIGHTS AND WINDOWS; MOTORS AND ENGINES EXCEPT THOSE FOR LAND VEHICLES; MACHINE COUPLING AND TRANSMISSION COMPONENTS AS ACTUATORS FOR OPENING AND CLOSING MOSQUITO NETS, DOORS, GATES, BARRIERS, SHUTTERS, SHIELDS, CURTAINS, WINDOWS, INDUSTRIAL ROOF LIGHTS AND WINDOWS EXCEPT THOSE FOR LAND VEHICLES (U.S. CLS. 13, 19, 21, 23, 31, 34 AND 35).

CLASS 9—ELECTRICAL AND SCIENTIFIC APPARATUS

FOR ELECTRICAL AND ELECTRONIC CONTROLS FOR TURNING ON, TURNING OFF AND REGULATION OF LIGHT EMISSIONS; ELECTRICAL AND ELECTRONIC CONTROLS FOR MANAGING AND CONTROLLING IRRIGATION SPRINKLERS; ELECTRICAL AND ELECTRONIC CONTROLS FOR CLOSING AND OPENING MOSQUITO NETS, DOORS, GATES, BARRIERS, SHUTTERS, SHIELDS, CURTAINS, WINDOWS, INDUSTRIAL ROOF LIGHTS AND WINDOWS; PROXIMITY READERS FOR CARDS AND TRANSPONDERS; HANDHELD PROGRAMMERS AND TIME PROGRAMMERS FOR CLOSING AND OPENING MOSQUITO NETS, DOORS, GATES, BARRIERS, SHUTTERS, SHIELDS, CURTAINS, WINDOWS, INDUSTRIAL ROOF LIGHTS AND WINDOWS; FLASHING SAFETY LIGHTS, IMPACT FORCE MEASUREMENT SOFTWARE FOR CLOSING AND OPENING MOSQUITO NETS, DOORS, GATES, BARRIERS, SHUTTERS, SHIELDS, CURTAINS, WINDOWS, INDUSTRIAL ROOF LIGHTS AND WINDOWS; DEVICES FOR ELECTRICALLY CONNECTING SAFETY EDGE SENSORS, NAMELY, PHOTO-TRANSMITTERS AND WIRING FOR ELECTRICALLY CONNECTING SAFETY EDGE SENSORS; DIGITAL KEYBOARDS; ELECTRONIC AND ELECTROMECHANICAL EDGE SENSORS FOR CLOSING AND OPENING MOSQUITO NETS, DOORS, GATES, BARRIERS, SHUTTERS, SHIELDS, CURTAINS, WINDOWS, INDUSTRIAL ROOF LIGHTS AND WINDOWS; RADIO TRANSCIEVERS FOR REMOTE CONTROLS; RADIO CONTROLS; RECEIVING ANTENNAS FOR RADIO RECEIVERS; PHOTOELECTRIC SENSORS FOR DETECTING PASSING VEHICLES AND PERSONS; POWER SUPPLY TRANSFORMERS FOR REMOTE CONTROL UNITS; DIGITAL CONTROLS FOR CLOSING AND OPENING MOSQUITO NETS, DOORS, GATES, BARRIERS, SHUTTERS, SHIELDS, CURTAINS, WINDOWS, INDUSTRIAL

ROOF LIGHTS AND WINDOWS; APPARATUSES FOR PROGRAMMING AND CONTROLLING CODES, NAMELY ELECTRONIC AND ELECTRICAL CONTROL PANELS AND KEYBOARDS FOR CLOSING AND OPENING MOSQUITO NETS, DOORS, GATES, BARRIERS, SHUTTERS, SHIELDS, CURTAINS, WINDOWS, INDUSTRIAL ROOF LIGHTS AND WINDOWS; ELECTRONIC CIRCUIT BOARDS ABLE TO LEARN THE SAME CODES; CODE MANAGEMENT SOFTWARE FOR CONTROL AND AUTOMATIC SYSTEMS; ELECTRONIC CONTROL COMMAND CENTRAL UNITS; ELECTRICAL CONSOLES FOR RECEIVERS AND CONTROL CENTERS; ELECTRONIC CONTROLS FOR ACTIVATING; MANAGING AND REMOTELY CONTROLLING APPARATUSES AND PLANTS FOR HOME, INDUSTRIAL AND COMMERCIAL APPLIANCES; DEVICES AND APPARATUSES FOR CONDUCTING, SWITCHING, TRANSFORMING, ACCUMULATING, ADJUSTING AND CONTROLLING ELECTRICAL CURRENT, NAMELY, ENERGY ACCUMULATORS, BATTERIES, RELAYS, ELECTRIC CONDENSERS, TRANSFORMERS (U.S. CLS. 21, 23, 26, 36 AND 38).

PETER B. BROMAGHIM, EXAMINING ATTORNEY

CLASS 9—ELECTRICAL AND SCIENTIFIC APPARATUS

FOR ELECTRICAL AND ELECTRONIC CONTROLS FOR TURNING ON, TURNING OFF AND REGULATION OF LIGHT EMISSION; ELECTRICAL AND ELECTRONIC CONTROLS FOR MANAGING AND CONTROLLING IRRIGATION SPRINKLERS; ELECTRICAL AND ELECTRONIC CONTROLS FOR CLOSING AND OPENING MOSQUITO NETS, DOORS, GATES, BARRIERS, SHUTTERS, SHIELDS, CURTAINS, WINDOWS, INDUSTRIAL ROOF LIGHTS AND WINDOWS; PROXIMITY READERS FOR CARDS AND TRANSPONDERS; HAND-HELD PROGRAMMERS AND TIME PROGRAMMERS FOR CLOSING AND OPENING MOSQUITO NETS, DOORS, GATES, BARRIERS, SHUTTERS, SHIELDS, CURTAINS, WINDOWS, INDUSTRIAL ROOF LIGHTS AND WINDOWS; FLASHING SAFETY LIGHTS, IMPACT FORCE MEASUREMENT SOFTWARE FOR CLOSING AND OPENING MOSQUITO NETS, DOORS, GATES, BARRIERS, SHUTTERS, SHIELDS, CURTAINS, WINDOWS, INDUSTRIAL ROOF LIGHTS AND WINDOWS; PHOTOTRANSMITTERS AND WIRING FOR ELECTRICALLY CONNECTING SAFETY EDGE SENSORS; DIGITAL KEYBOARDS; ELECTRONIC AND ELECTROMECHANICAL EDGE SENSORS FOR CLOSING AND OPENING MOSQUITO NETS, DOORS, GATES, BARRIERS, SHUTTERS, SHIELDS, CURTAINS, WINDOWS, INDUSTRIAL ROOF LIGHTS AND WINDOWS; RADIO TRANSCEIVERS FOR REMOTE CONTROLS, RADIO CONTROLS; RECEIVING ANTENNAS FOR RADIO RECEIVERS; PHOTOELECTRIC SENSORS FOR DETECTING PASSING VEHICLES AND PERSONS; POWER SUPPLY TRANSFORMERS FOR REMOTE CONTROL UNITS; DIGITAL CONTROLS FOR CLOSING AND OPENING MOSQUITO NETS, DOORS, GATES, BARRIERS, SHUTTERS, SHIELDS, CURTAINS, WINDOWS, INDUSTRIAL ROOF LIGHTS AND WINDOWS; APPARATUSES FOR PROGRAMMING AND CONTROLLING CODES, NAMELY, ELECTRONIC AND ELECTRICAL CONTROL PANELS AND KEYBOARDS FOR CLOSING AND OPENING MOSQUITO NETS, DOORS, GATES, BARRIERS, SHUTTERS, SHIELDS, CURTAINS, WINDOWS, INDUSTRIAL ROOF LIGHTS AND WINDOWS; ELECTRONIC CIRCUIT BOARDS ABLE TO LEARN THE SAME CODES; CODE MANAGEMENT SOFTWARE FOR CONTROL AND AUTOMATION SYSTEMS; ELECTRONIC CONTROL COMMAND CENTRAL UNITS; ELECTRICAL CONSOLES FOR RECEIVERS AND CONTROL CENTERS; ELECTRONIC CONTROLS FOR ACTIVATING, MANAGING AND REMOTELY CONTROLLING APPARATUSES AND PLANTS FOR HOME, INDUSTRIAL AND COMMERCIAL APPLIANCES; DEVICES AND APPARATUSES FOR CONDUCTING, SWITCHING, TRANSFORMING, ACCUMULATING, ADJUSTING AND CONTROLLING ELECTRICAL CURRENT, NAMELY, ENERGY ACCUMULATORS, BATTERIES, RELAYS, ELECTRIC CONDENSERS, TRANSFORMERS (U.S. CLS. 21, 23, 26, 36 AND 38).

SN 79-033,205. NICE SPA, ODERZO (TREVISO), ITALY, FILED 10-4-2006.

MOOVO

THE MARK CONSISTS OF STANDARD CHARACTERS WITHOUT CLAIM TO ANY PARTICULAR FONT, STYLE, SIZE, OR COLOR.

PRIORITY DATE OF 5-10-2006 IS CLAIMED.

OWNER OF INTERNATIONAL REGISTRATION 0909233 DATED 10-4-2006, EXPIRES 10-4-2016.

CLASS 7—MACHINERY

FOR MOTORS, EXCEPT THOSE FOR LAND VEHICLES; PLANETARY GEAR MOTORS, MECHANICAL APPARATUSES FOR OPENING AND CLOSING MOSQUITO NETS, DOORS, GATES, BARRIERS, SHUTTERS, SHIELDS, CURTAINS, WINDOWS, INDUSTRIAL ROOF LIGHTS AND WINDOWS; MOTORS AND ENGINES EXCEPT THOSE FOR LAND VEHICLES; MACHINE COUPLING AND TRANSMISSION COMPONENTS AS ACTUATORS FOR OPENING AND CLOSING MOSQUITO NETS, DOORS, GATES, BARRIERS, SHUTTERS, SHIELDS, CURTAINS, WINDOWS, INDUSTRIAL ROOF LIGHTS AND WINDOWS, EXCEPT THOSE FOR LAND VEHICLES (U.S. CLS. 13, 19, 21, 23, 31, 34 AND 35).

CLASS 11—ENVIRONMENTAL CONTROL APPARATUS

FOR APPARATUS FOR ELECTRICAL LIGHTING, NAMELY, ELECTRICAL LIGHTING INSTALLATIONS FOR COMMERCIAL, INDUSTRIAL, OFFICE, HOME AND GARDEN; LANDSCAPE LIGHTING INSTALLATIONS (U.S. CLS. 13, 21, 23, 31 AND 34).

PETER B. BROMAGHIM, EXAMINING ATTORNEY

SN 79-033,234. GROUPE SILICOMP, FRANCE, FILED 6-21-2006.

SN 79-033,406. AREA S.R.L., ITALY, FILED 9-18-2006.

FIME

THE MARK CONSISTS OF STANDARD CHARACTERS WITHOUT CLAIM TO ANY PARTICULAR FONT, STYLE, SIZE, OR COLOR.

PRIORITY DATE OF 12-26-2005 IS CLAIMED.
OWNER OF INTERNATIONAL REGISTRATION 0909220 DATED 6-21-2006, EXPIRES 6-21-2016.

CLASS 9—ELECTRICAL AND SCIENTIFIC APPARATUS

FOR ELECTRONIC TEST AND MEASUREMENT DEVICES FOR USE IN THE FIELDS OF NETWORKS AND TELECOMMUNICATIONS, NAMELY, INSTRUMENTATION USED TO TEST AND CERTIFY NEW AND EXISTING DATA AND VOICE COMMUNICATION CABLE AND COAXIAL CABLE; ELECTRONIC APPARATUS AND INSTRUMENTS FOR ANALYZING TRANSACTIONS BETWEEN A READER, A TERMINAL AND A SMARTCARD WITH OR WITHOUT CONTACT, A TRANSPONDER, ELECTRONIC TAGS FOR GOODS, NAMELY, INSTRUMENTATION PROVIDED WITH AN ELECTRONIC CHIP; ELECTRONIC APPARATUS AND INSTRUMENTS FOR TESTING AND CHECKING SOFTWARE, SMART CARDS WITH OR WITHOUT CONTACT, TERMINALS, READERS, ELECTRONIC TAGS FOR GOODS, NAMELY, INSTRUMENTATION PROVIDED WITH AN ELECTRONIC CHIP; APPARATUS AND INSTRUMENTS FOR MEASURING RADIO FREQUENCIES, NAMELY, RADIO FREQUENCY READERS AND RADIO FREQUENCY IDENTIFICATION TAGS (U.S. CLS. 21, 23, 26, 36 AND 38).

CLASS 42—SCIENTIFIC AND COMPUTER SERVICES

FOR COMPUTER SYSTEMS DESIGN; TECHNOLOGICAL CONSULTANCY IN THE FIELD OF CONSUMER ELECTRONICS, NAMELY, SMART CARDS WITH OR WITHOUT ELECTRONIC CONTACTS OR ANY OTHER OBJECT PROVIDED WITH AN ELECTRONIC CHIP; TESTING, QUALITY AND CERTIFICATION CONTROL OF THE PRODUCTS OF OTHERS, NAMELY, OF SMART CARDS WITH OR WITHOUT ELECTRONIC CONTACTS, TERMINALS, READERS, TRANSPONDERS OR ELECTRONIC TAGS FOR GOODS; SOFTWARE DESIGN, INSTALLATION AND UPDATING FOR OTHERS; RESEARCH AND DESIGN FOR OTHERS IN THE CONSUMER ELECTRONIC FIELD, IN PARTICULAR, DESIGN OF APPARATUS AND INSTRUMENTS FOR TESTING AND CHECKING SOFTWARE, SMART CARDS WITH OR WITHOUT CONTACT, TERMINALS, READERS, ELECTRONIC TAGS FOR GOODS OR ALL OTHER OBJECTS PROVIDED WITH AN ELECTRONIC CHIP; ENGINEERING SERVICES IN THE FIELD OF ELECTRONIC CHIPS AND TECHNOLOGIES OF WIRELESS TRACEABILITY OF ELECTRONIC TAGS FOR GOODS OR ALL OTHER OBJECTS PROVIDED WITH AN ELECTRONIC CHIP; DATA CONVERSION OF COMPUTER PROGRAMS AND DATA, NOT PHYSICAL CONVERSION (U.S. CLS. 100 AND 101).

ANTHONY RINKER, EXAMINING ATTORNEY



PRIORITY DATE OF 9-5-2006 IS CLAIMED.
OWNER OF INTERNATIONAL REGISTRATION 0909799 DATED 9-18-2006, EXPIRES 9-18-2016.

THE TRADEMARK IS A FIGURATIVE MARK WITH THE FANCY NAME "COCO SONG" DEPICTED IN BOLD UPPERCASE TYPE, WITH A PENTAGONAL STAR BEING USED AS A DIVIDER AND SUPERIMPOSED OVER AN ELLIPTICAL PRINT CONTAINING A FIGURE OF A HORSE RIDER WITH A PATTERN RADIATING FROM THE STAR, AND BELOW IT, THREE CHINESE IDEOGRAMS.

THE CHINESE LETTERING IN THE MARK TRANSLITERATES INTO THE WORDING COOCO SOONG.

CLASS 9—ELECTRICAL AND SCIENTIFIC APPARATUS

FOR SPECTACLES; SPECTACLE FRAMES; SPECTACLE LENSES; SPECTACLE CASES (U.S. CLS. 21, 23, 26, 36 AND 38).

CLASS 14—JEWELRY

FOR JEWELRY ARTICLES; PRECIOUS STONES; PEARLS; NECKLACES; BRACELETS; MEDALS; RINGS; CLOCKS; CHRONOMETERS (U.S. CLS. 2, 27, 28 AND 50).
JORDAN BAKER, EXAMINING ATTORNEY

SN 79-033,789. MIROGLIO S.P.A., ITALY, FILED 11-24-2006.

mötivi

OWNER OF INTERNATIONAL REGISTRATION 0717307 DATED 7-13-1999, EXPIRES 7-13-2009.

OWNER OF U.S. REG. NOS. 2,062,936 AND 2,607,840.

THE TRADEMARK CONSISTS OF THE DESIGNATION MOTIVI IN ORIGINAL LOWERCASE PRINTING TYPE IN THICK SOLID LINES; OVER THE LETTER O AND PARTLY OVER THE LETTER M THERE IS A SERIES OF 5 DARK DOTS; THE DESIGN IS DEPICTED ON A CLEAR BACKGROUND.

THE ENGLISH TRANSLATION OF MOTIVI IS "REASONS" OR "GROUNDS".

CLASS 24—FABRICS

FOR COTTON, WOOL AND SILK FABRICS AND TEXTILE GOODS NOT INCLUDED IN OTHER CLASSES, NAMELY WALL HANGINGS, HANDKERCHIEFS, TOWELS, TAPESTRIES OF TEXTILE; UNFITTED BED AND TABLE COVERS (U.S. CLS. 42 AND 50).

CLASS 25—CLOTHING

FOR CLOTHING, NAMELY JACKETS, VESTS, BELTS, NECKWEAR, SWEATERS, SUITS, SHIRTS, BLOUSES, SKIRTS, DRESSES, SCARVES, SHAWLS, BLAZERS, COATS, JEANS, TROUSERS, SLACKS, LOUNGEWEAR, T-SHIRTS, PANTSUITS, RAIN COATS, SHORTS, PLUSH SWEATERS, SPORT COATS, GLOVES, TIES, SWEAT-SHIRTS; FOOTWEAR, HEADWEAR (U.S. CLS. 22 AND 39).

TARAH HARDY, EXAMINING ATTORNEY

SN 79-034,019. ELSTER GROUP GMBH, FED REP GER-MANY, FILED 7-11-2006.



PRIORITY DATE OF 1-13-2006 IS CLAIMED.
OWNER OF INTERNATIONAL REGISTRATION 0911736 DATED 7-11-2006, EXPIRES 7-11-2016.
OWNER OF U.S. REG. NOS. 2,402,986 AND 3,202,396.
NO CLAIM IS MADE TO THE EXCLUSIVE RIGHT TO USE "GROUP", APART FROM THE MARK AS SHOWN.
"THE FOREIGN WORDING IN THE MARK TRANS-LATES INTO ENGLISH AS MAGPIE."

CLASS 9—ELECTRICAL AND SCIENTIFIC APPARATUS

FOR ELECTRONIC, MECHANICAL AND ELECTRO-MECHANICAL METERS FOR ELECTRICAL AND THERMAL ENERGY, GAS AND WATER (U.S. CLS. 21, 23, 26, 36 AND 38).

CLASS 42—SCIENTIFIC AND COMPUTER SERVICES

FOR ENGINEERING SERVICES IN THE ENERGY SECTOR, IN PARTICULAR IN THE FIELD OF CON-SUMPTION METERING (U.S. CLS. 100 AND 101).
CHRISTOPHER OTT, EXAMINING ATTORNEY

SN 79-034,089. SPINELLI S.R.L., ITALY, FILED 11-27-2006.



PRIORITY DATE OF 10-19-2006 IS CLAIMED.
OWNER OF INTERNATIONAL REGISTRATION 0912003 DATED 11-27-2006, EXPIRES 11-27-2016.
THE MARK IS COMPOSED OF THE WORDING "TERRA D'ALIGI" WITHIN A STYLIZED FRAME, ABOVE WHICH THERE IS A STYLIZED PICTURE OF AN OLD FARM-HOUSE.

CLASS 29—MEATS AND PROCESSED FOODS

FOR EDIBLE OILS (U.S. CL. 46).

CLASS 33—WINES AND SPIRITS

FOR ALCOHOLIC BEVERAGES NAMELY WINES, SPARKLING WINES, DISTILLED SPIRITS (U.S. CLS. 47 AND 49).

MICHAEL TANNER, EXAMINING ATTORNEY

SN 79-034,124. ABENSUR LARRY, F-67000 STRASBOURG, FRANCE, FILED 9-7-2006.

OWNER OF INTERNATIONAL REGISTRATION 0912101 DATED 9-7-2006, EXPIRES 9-7-2016.

THE COLOR(S) PURPLE IS/ARE CLAIMED AS A FEAT-URE OF THE MARK.

THE MARK CONSISTS OF OF THE COLOR PURPLE AND THE COLOR PURPLE APPEARS THROUGHOUT THE MARK.

CLASS 5—PHARMACEUTICALS

FOR PHARMACEUTICAL PRODUCTS, NAMELY, PREGNANCY AND OVULATION TEST KITS FOR HOME USE, REAGENTS FOR MEDICAL USE FOR PREGNANCY TESTS, PHARMACEUTICAL PRODUCTS FOR THE DIAGNOSIS OF INFECTIONS OR VIRAL DISEASES; HYGIENIC PRODUCTS, NAMELY, DIS-IN-FECTANTS FOR HYGIENIC PURPOSES; AND PRE-PARATIONS FOR DISINFECTING SKIN (U.S. CLS. 6, 18, 44, 46, 51 AND 52).

CLASS 10—MEDICAL APPARATUS

FOR MEDICAL APPARATUS AND MEDICAL IN-STRUMENTS, NAMELY, MEDICAL APPARATUS AND INSTRUMENTS FOR DIAGNOSING PREGNANCY, OVULATION, INFECTIOUS OR VIRAL DISEASES, BLOOD-COMPONENT SEPARATION APPARATUS FOR MEDICAL PURPOSES; BLOOD ANALYSIS APPARATUS; BLOOD-PRESSURE MEASURING APPARATUS, THER-MOMETERS FOR MEDICAL USE; SPHYGMOMAN-OMETERS (U.S. CLS. 26, 39 AND 44).

ESTHER BELENKER, EXAMINING ATTORNEY

SN 79-034,231. MONAL SYSTEM SOCIÉTÉ À RESPONSABIL-ITÉ LIMITÉE, FRANCE, FILED 7-10-2006.

PRIORITY DATE OF 1-12-2006 IS CLAIMED.
OWNER OF INTERNATIONAL REGISTRATION 0912407 DATED 7-10-2006, EXPIRES 7-10-2016.

CLASS 9—ELECTRICAL AND SCIENTIFIC APPARATUS

FOR COMPUTER DATABASE MANAGEMENT PRO-GRAMS AND SOFTWARE FOR CONSULTING A VIDEO CATALOGUE, DATA PROCESSORS FOR CONSULTING A VIDEO CATALOGUE; COMPUTER SERVERS FOR STORING AND DISTRIBUTING A VIDEO CATALOGUE (U.S. CLS. 21, 23, 26, 36 AND 38).

CLASS 38—COMMUNICATION

FOR PROVIDING ACCESS TO VIDEO DATABASES; DISPLAYING INFORMATION FROM A VIDEO DATABASE STORED ON COMPUTERS, NAMELY, TRANSMISSION AND RECEPTION OF DATABASE INFORMATION VIA TELECOMMUNICATION NETWORKS (U.S. CLS. 100, 101 AND 104).

SN 79-036,057. UNION DES ASSOCIATIONS EUROPEENNES; DE FOOTBALL (UEFA), SWITZERLAND, FILED 11-9-2006.

CLASS 41—EDUCATION AND ENTERTAINMENT

FOR CONSULTING FOR THIRD PARTIES FOR INFORMATION PURPOSES IN A CATALOGUE OF VIDEO PROGRAMMES AND CINEMATOGRAPHIC FILMS BY MEANS OF COMPUTER TERMINALS, NAMELY, CONSULTATION IN THE FIELD OF MOTION PICTURE FILM PRODUCTION, RENTAL AND DISTRIBUTION (U.S. CLS. 100, 101 AND 107).

ROBERT STRUCK, EXAMINING ATTORNEY



SN 79-034,389. LUDOWICI MINERAL PROCESSING EQUIPMENT PTY LTD; ACN 010 340 566, AUSTRALIA, FILED 11-24-2006.

PRIORITY DATE OF 9-12-2006 IS CLAIMED. OWNER OF INTERNATIONAL REGISTRATION 0917595 DATED 11-9-2006, EXPIRES 11-9-2016.

WEAR MAX

CLASS 12—VEHICLES

FOR BICYCLES, MOTORCYCLES, MOTOR CARS FOR TRANSPORT ON LAND, TRUCKS, PICKUP TRUCKS, BUSES, REFRIGERATED TRAILERS; AIRPLANES AND BOATS; VEHICULAR BALLOONS; LIGHTER-THAN-AIR VEHICULAR BALLOONS; MOTOR CAR ACCESSORIES, NAMELY GLARE SHIELDS, NAMELY SUN SHIELDS AND VISORS FOR MOTOR VEHICLES, TIRE COVERS, NAMELY, WHEEL COVERS, LUGGAGE RACKS FOR MOTOR CARS, SKI RACKS FOR MOTOR CARS, WHEEL RIMS AND HUBCAPS; PNEUMATIC TIRES, VEHICLE SEAT COVERS, FITTED VEHICLE COVERS, BABY CARRIAGES, BABY STROLLERS, MOTOR CAR SEATS FOR BABIES OR CHILDREN; MOTORS AND ENGINES FOR LAND VEHICLES (U.S. CLS. 19, 21, 23, 31, 35 AND 44).

CLASS 24—FABRICS

FOR SLEEPING BAGS THAT ARE PADDED; SHEETS NAMELY BED SHEETS, CONTOUR SHEETS; EIDER-DOWNS; BEDSPREADS; PILLOW CASES; CURTAINS, SHOWER CURTAINS; CURTAIN FABRICS; LINEN; BATH LINEN, DISH TOWELS, BLANKETS OF TEXTILE NAMELY BED BLANKETS; HANDKERCHIEFS OF TEXTILE, WALL HANGINGS OF TEXTILE, FLAGS NAMELY FABRIC FLAGS; PENNANTS NAMELY FABRIC PENNANT; TABLE LINEN NOT OF PAPER; TEXTILE LABELS (U.S. CLS. 42 AND 50).

THE MARK CONSISTS OF STANDARD CHARACTERS WITHOUT CLAIM TO ANY PARTICULAR FONT, STYLE, SIZE, OR COLOR.

OWNER OF INTERNATIONAL REGISTRATION 0912891 DATED 11-24-2006, EXPIRES 11-24-2016.

CLASS 1—CHEMICALS

FOR ABRASION-RESISTANT EPOXY RESIN, AND EPOXY RESIN WITH CERAMIC BEADS SUSPENDED IN THE RESIN USED AS AN INDUSTRIAL MATERIALS HANDLING LINING (U.S. CLS. 1, 5, 6, 10, 26 AND 46).

CLASS 32—LIGHT BEVERAGES

FOR NON-ALCOHOLIC BEVERAGES NAMELY NON-ALCOHOLIC BEER; SYRUPS AND POWDERS FOR PREPARING NON-ALCOHOLIC BEVERAGES, NAMELY, SOFT DRINKS; MINERAL AND CARBONATED WATERS; OTHER NON-ALCOHOLIC BEVERAGES NAMELY NON-ALCOHOLIC COCKTAIL MIXES, NON-ALCOHOLIC WINES; FRUIT AND VEGETABLE BEVERAGES NAMELY VEGETABLE JUICE AND FRUIT AND VEGETABLE JUICES; FROZEN FRUIT BEVERAGES; BEERS, STRONG DARK BEERS, PALE ALES AND ALES; NON-ALCOHOLIC BEERS (U.S. CLS. 45, 46 AND 48).

CLASS 2—PAINTS

FOR ABRASION, WEAR AND/OR CORROSION RESISTANT COATINGS; ALUMINA BEADS AND EPOXY RESINS FORMING AN ABRASION, WEAR AND/OR CORROSION RESISTANT COATING (U.S. CLS. 6, 11 AND 16).

BRIAN NEVILLE, EXAMINING ATTORNEY

CLASS 36—INSURANCE AND FINANCIAL

FOR ISSUANCE OF CREDIT CARDS AND TRAVELERS' CHECKS; FINANCIAL SERVICES, NAMELY, LOAN FINANCING; BANKING SERVICES NAMELY, INVESTMENT BANKING SERVICES, CREDIT AND FUND INVESTMENT, NAMELY, CREDIT CARD SERVICES; INSURANCE UNDERWRITING IN THE FIELD OF LIFE, HEALTH, ACCIDENT, FIRE; LEASING OF OFFICE SPACE; FINANCIAL SPONSORSHIP OF SPORTS MEETINGS; INFORMATION SERVICES CONCERNING FINANCE AND INSURANCE, PROVIDED FROM A COMPUTER DATABASE OR VIA THE INTERNET OR ON ANY WIRELESS ELECTRONIC COMMUNICATION NETWORK; HOME BANKING SERVICES NAMELY, INVESTMENT BANKING SERVICES; BANKING SERVICES NAMELY, INVESTMENT BANKING SERVICES ON THE INTERNET OR ON ANY WIRELESS ELECTRONIC COMMUNICATION NETWORK (U.S. CLS. 100, 101 AND 102).

CLASS 38—COMMUNICATION

FOR TELECOMMUNICATION SERVICES, NAMELY, COMMUNICATIONS BY MOBILE TELEPHONES; COMMUNICATIONS BY TELEGRAM; COMMUNICATION VIA COMPUTER TERMINALS, PROVIDING ACCESS TO DATABASES AND TELECOMMUNICATION NETWORKS SIMILAR TO THE INTERNET, AND ANY WIRELESS ELECTRONIC COMMUNICATION NETWORK; TELEGRAPH COMMUNICATION; COMMUNICATION BY TELEPHONE; TELECOMMUNICATION SERVICES FOR ELECTRONIC PAYMENTS, NAMELY, PROVIDING ELECTRONIC TRANSMISSION OF CREDIT CARD TRANSACTION DATA AND ELECTRONIC PAYMENT DATA VIA A GLOBAL COMPUTER NETWORK; COMMUNICATION BY TELEGRAM; RADIO CALL SERVICES, NAMELY, RADIO COMMUNICATION; TELEPHONE AND VIDEO CONFERENCE SERVICES; TELEVISION PROGRAM BROADCASTING; TRANSMISSION OF CABLE TELEVISION PROGRAMS; RADIO PROGRAM BROADCASTING; NEWS AGENCY SERVICES, NAMELY, THE TRANSMISSION OF NEWS ITEMS TO NEWS REPORTING ORGANIZATIONS; OTHER MESSAGE TRANSMISSION SERVICES NAMELY, TRANSMISSION OF MESSAGES OVER ELECTRONIC MEDIA; RENTAL OF TELECOMMUNICATION EQUIPMENT NAMELY TELEPHONES, FAX MACHINES AND OTHER COMMUNICATION APPARATUS; PROVIDING MULTIPLE USE ACCESS TO GLOBAL COMPUTER INFORMATION NETWORKS FOR THE TRANSFER AND DISSEMINATION OF A WIDE RANGE OF INFORMATION VIA TELEMATIC MEANS AND ON ANY WIRELESS ELECTRONIC COMMUNICATION NETWORK IN THE COMMERCIAL SECTOR; TRANSMISSION AND BROADCASTING OF RADIO AND TELEVISION PROGRAMS VIA THE INTERNET AND VIA ANY WIRELESS ELECTRONIC COMMUNICATION NETWORK; ELECTRONIC MESSAGING NAMELY, TRANSMISSION OF MESSAGES OVER ELECTRONIC MEDIA; ELECTRONIC STORE-AND-FORWARD MESSAGING; PROVISION OF ACCESS TO ELECTRONIC SITES, NAMELY, TELEMATIC SERVERS AND CONVERSATION GROUPS IN REAL TIME; COMPUTER-AIDED INFORMATION AND IMAGE TRANSMISSION; PROVISION OF ACCESS TO ELECTRONIC SITES FOR HOME PURCHASING AND ORDERING SERVICES VIA COMPUTER AND INTERACTIVE COMMUNICATION TECHNOLOGIES; TRANSMISSION OF INFORMATION BY TELEMATIC CODES AND BY OPTICAL TELECOMMUNICATIONS NETWORKS OF COMPUTER PROGRAMS AND OTHER DATA; ELECTRONIC MAIL SERVICES; PROVIDING REMOTE ACCESS TO THE INTERNET AND TO ANY WIRELESS ELECTRONIC COMMUNICATION NETWORK, NAMELY, TELECOMMUNICATION ACCESS SERVICES; PROVISION OF CONNECTIONS FOR TELECOMMUNICATIONS TO A GLOBAL COMPUTER NETWORK; PROVISION OF ACCESS TO DIGITAL MUSIC SITES ON THE INTERNET AND ON ANY WIRELESS ELECTRONIC COMMUNICATION NETWORK; PROVISION OF ACCESS TO MP3 SITES ON THE INTERNET; TRANSMISSION OF DIGITAL MUSIC BY SATELLITE, CABLE, INTERACTIVE MULTIMEDIA NETWORKS; TRANSMISSION OF ELECTRONIC PUBLICATIONS ON LINE, NAMELY, ON-LINE DOCUMENT DELIVERY VIA A GLOBAL COMPUTER NETWORK; TRANSMISSION OF DIGITAL MUSIC BY SATELLITE, CABLE, INTERACTIVE MULTIMEDIA

NETWORKS VIA THE INTERNET AND VIA ANY WIRELESS ELECTRONIC COMMUNICATION NETWORK; TRANSMISSION OF DIGITAL MUSIC BY SATELLITE, CABLE, INTERACTIVE MULTIMEDIA NETWORKS VIA INTERNET MP3 SITES; PROVISION OF ACCESS TO ELECTRONIC SITES, NAMELY, "BLACKBOARDS," NAMELY, DISPLAY AND NOTICE BOARDS, AND PROVIDING INTERNET CHAT ROOMS IN REAL TIME VIA A GLOBAL COMPUTER NETWORK (U.S. CLS. 100, 101 AND 104).

CLASS 39—TRANSPORTATION AND STORAGE

FOR OPERATION OF A TRAVEL AGENCY, NAMELY COORDINATING TRAVEL ARRANGEMENT FOR INDIVIDUALS AND FOR GROUPS AND TRANSPORTATION RESERVATION; TRAVEL TICKET RESERVATION SERVICES, PROVIDING INFORMATION ABOUT TRAVEL DOCUMENTATION; TRANSPORTATION BY AIRPLANE, RAILWAY, BUS AND TRUCK; BOAT TRANSPORT; BOAT TRAVEL SERVICES, NAMELY, ORGANIZATION OF TRAVEL AND BOAT TRIPS; TOURIST TRAVEL SERVICES, NAMELY, ARRANGING EXCURSIONS FOR TOURISTS; VEHICLE RENTAL; RENTAL OF PARKING SPACES; TAXI SERVICES, NAMELY, TAXI TRANSPORT; TRANSPORT OF GOODS BY BOAT; PUBLIC UTILITY SERVICES, NAMELY, DISTRIBUTION OF WATER, HEAT, GAS OR ELECTRICITY; DELIVERY OF NEWSPAPERS, MAGAZINES AND BOOKS BY TRUCK; POSTAL SERVICES NAMELY, PARCEL DELIVERY, PACKAGING ARTICLES FOR TRANSPORTATION, RENTAL OF MAIL BOXES AND COURIER SERVICES; DISTRIBUTION, NAMELY, DELIVERY OF SOLVENTS, PARAFFINS, WAXES, BITUMENS AND PETROLEUM PRODUCTS, WITH THE EXCEPTION OF LIQUID GAS; DISTRIBUTION SERVICES, NAMELY, DELIVERY OF FILMS AND OF SOUND AND IMAGE RECORDINGS; DISTRIBUTION SERVICES, NAMELY, DELIVERY OF INTERACTIVE EDUCATIONAL AND ENTERTAINMENT PRODUCTS, OF INTERACTIVE COMPACT DISKS, OF CD-ROMS, OF COMPUTER PROGRAMS AND OF COMPUTER GAMES (U.S. CLS. 100 AND 105).

TASNEEM HUSSAIN, EXAMINING ATTORNEY

SN 79-036,355. X-AITMENT GMBH, FED REP GERMANY, FILED 7-31-2006.

Xaitment

THE MARK CONSISTS OF STANDARD CHARACTERS WITHOUT CLAIM TO ANY PARTICULAR FONT, STYLE, SIZE, OR COLOR.

OWNER OF INTERNATIONAL REGISTRATION 0918410 DATED 7-31-2006, EXPIRES 7-31-2016.

CLASS 9—ELECTRICAL AND SCIENTIFIC APPARATUS

FOR COMPUTER HARDWARE; COMPUTER SOFTWARE FOR USE IN PRODUCT DEVELOPMENT OF ENTERTAINMENT SOFTWARE NAMELY, VIDEO GAME SOFTWARE; DOWNLOADABLE COMPUTER GAME SOFTWARE (U.S. CLS. 21, 23, 26, 36 AND 38).

CLASS 41—EDUCATION AND ENTERTAINMENT

FOR FILM AND MULTIMEDIA PRODUCTION, NAMELY, PRODUCTION OF COMPUTER-ANIMATED FILMS (U.S. CLS. 100, 101 AND 107).

CLASS 42—SCIENTIFIC AND COMPUTER SERVICES

FOR DESIGN AND DEVELOPMENT OF COMPUTER HARDWARE AND SOFTWARE; SCIENTIFIC RESEARCH AND DESIGN AND TECHNOLOGICAL SERVICES RESEARCH AND DESIGN IN THE FIELD OF ARTIFICIAL INTELLIGENCE AS APPLIED TO COMPUTER GAMES AND COMPUTER GAME SIMULATIONS; DESIGN AND DEVELOPMENT OF COMPUTER GAME SOFTWARE; DEVELOPMENT OF MULTIMEDIA COMPUTER SOFTWARE PROGRAMS (U.S. CLS. 100 AND 101).

WILLIAM ROSSMAN, EXAMINING ATTORNEY

CLASS 42—SCIENTIFIC AND COMPUTER SERVICES

FOR DEVELOPMENT, MAINTENANCE AND UPDATING OF SOFTWARE, IN PARTICULAR FOR MONITORING, CONTROL AND/OR DOCUMENTATION OF PACKAGING PROCESSES AND FOR CAMERA AND IMAGE PROCESSING SYSTEMS (U.S. CLS. 100 AND 101).

ANDREA SAUNDERS, EXAMINING ATTORNEY

SN 79-039,065. LAETUS GMBH, FED REP GERMANY, FILED 3-23-2007.



OWNER OF INTERNATIONAL REGISTRATION 0925626 DATED 3-23-2007, EXPIRES 3-23-2017.

CLASS 9—ELECTRICAL AND SCIENTIFIC APPARATUS

FOR OPTICAL, ELECTRIC AND ELECTRONIC MONITORING EQUIPMENT, IN PARTICULAR FOR PHARMACEUTICAL PRODUCTS, NAMELY, VIDEO MONITORS, OPTICAL CHARACTER RECOGNITION APPARATUS (OCR), OPTICAL INSPECTION APPARATUS FOR INDUSTRIAL USE; SOFTWARE FOR MONITORING, CONTROL AND/OR DOCUMENTATION OF PACKAGING PROCESSES; WRITING AND READING APPARATUS FOR BAR AND MATRIX CODES AND FOR RFID CHIPS, NAMELY, BAR CODE READERS, BAR CODE SCANNERS, MATRIX CODE READERS, BAR CODE PRINTERS, MATRIX CODE PRINTERS, RFID READERS AND PRINTERS; CAMERA AND IMAGE PROCESSING SYSTEMS, COMPRISED OF CAMERAS, INCLUDING SOFTWARE THEREFORE (U.S. CLS. 21, 23, 26, 36 AND 38).

SN 79-975,022. EUROPEAN NETWORK EXCHANGE ASSOCIATION, FRANCE, FILED 8-14-2006.



OWNER OF INTERNATIONAL REGISTRATION 0908963 DATED 8-14-2006, EXPIRES 8-14-2016.

CLASS 12—VEHICLES

FOR VEHICLES, NAMELY, AUTOMOBILES, VANS, TRUCKS, MOTORCYCLES AND STRUCTURAL PARTS THEREFOR (U.S. CLS. 19, 21, 23, 31, 35 AND 44).

CLASS 42—SCIENTIFIC AND COMPUTER SERVICES

FOR CONSTRUCTION DRAFTING; ENGINEERING; SURVEYING; TECHNICAL PROJECT STUDIES, NAMELY, CONDUCTING OF FEASIBILITY STUDIES, RESEARCH AND DEVELOPMENT OF NEW PRODUCTS FOR OTHERS, AND MECHANICAL RESEARCH; SCIENTIFIC RESEARCH; INDUSTRIAL PRODUCT RESEARCH (U.S. CLS. 100 AND 101).

JAY BESCH, EXAMINING ATTORNEY

* * * * *

SECTION 2.— INTERNATIONAL CLASSIFICATION

The short titles associated below with the international class numbers are terms designed merely for quick identification and are not an official part of the international classification. The full names of international classes are given in section 6.1 of the trademark rules of practice.

The designation "U.S. Cl." appearing in this section refers to the U.S. class in effect prior to Sep. 1, 1973 rather than the international class which applies to applications filed on or after that date. For adoption of international classification see notice in the OFFICIAL GAZETTE of Jun. 26, 1973 (911 O.G. TM 210).

Application in one class

CLASS 1—CHEMICALS

SN 76-666,543. ATOTECH DEUTSCHLAND GMBH, BERLIN, FED REP GERMANY, FILED 9-25-2006.

CLASS 1—(Continued).

SN 77-028,797. TYGAR MANUFACTURING, LLC, BALL GROUND, GA. FILED 10-25-2006.

TRICHROME

TYGAR Efflor-Guard

THE MARK CONSISTS OF STANDARD CHARACTERS WITHOUT CLAIM TO ANY PARTICULAR FONT, STYLE, SIZE, OR COLOR.

OWNER OF FED REP GERMANY REG. NO. 30624557, DATED 6-23-2006, EXPIRES 4-30-2016.

OWNER OF U.S. REG. NO. 1,088,444.

FOR CHEMICALS USED FOR ELECTROPLATING TRIVALENT CHROMIUM, NAMELY STABILIZERS, CHROME ADJUSTORS, REGULATORS, CORRECTORS, ADDITIVES, COMPOUNDS, PURIFIERS, POST-DIPS, ELECTROCHROMATES AND RESINS (U.S. CLS. 1, 5, 6, 10, 26 AND 46).

DOMINIC FATHY, EXAMINING ATTORNEY

THE MARK CONSISTS OF STANDARD CHARACTERS WITHOUT CLAIM TO ANY PARTICULAR FONT, STYLE, SIZE, OR COLOR.

FOR CONCRETE ADDITIVES (U.S. CLS. 1, 5, 6, 10, 26 AND 46).

SANDRA MANIOS, EXAMINING ATTORNEY

SN 77-028,785. TYGAR MANUFACTURING, LLC, BALL GROUND, GA. FILED 10-25-2006.

SN 77-038,618. ARCHER-DANIELS-MIDLAND COMPANY, DECATUR, IL. FILED 11-7-2006.

TYGAR CurbColors

MEDIAPRO

THE MARK CONSISTS OF STANDARD CHARACTERS WITHOUT CLAIM TO ANY PARTICULAR FONT, STYLE, SIZE, OR COLOR.

NO CLAIM IS MADE TO THE EXCLUSIVE RIGHT TO USE "CURB COLORS", APART FROM THE MARK AS SHOWN.

FOR CONCRETE ADDITIVES (U.S. CLS. 1, 5, 6, 10, 26 AND 46).

FIRST USE 9-27-2006; IN COMMERCE 9-28-2006.

SANDRA MANIOS, EXAMINING ATTORNEY

THE MARK CONSISTS OF STANDARD CHARACTERS WITHOUT CLAIM TO ANY PARTICULAR FONT, STYLE, SIZE, OR COLOR.

FOR A FERMENTATION MEDIUM, NAMELY, THE CULTURE OF MICROORGANISMS TO FEED MICROBES FOR THE PRODUCTION OF ANTIBIOTICS, ENZYMES, AND SOY SAUCES (U.S. CLS. 1, 5, 6, 10, 26 AND 46).

MICHAEL LEWIS, EXAMINING ATTORNEY

CLASS 1—(Continued).

SN 77-089,794. GREEN POWER CHEMICAL, LLC, STANHOPE, NJ. FILED 1-24-2007.



THE COLOR(S) YELLOW AND BLUE IS/ARE CLAIMED AS A FEATURE OF THE MARK.

THE COLOR YELLOW APPEARS IN THE WORDING PLANISOL-M; THE COLOR BLUE APPEARS IN THE OUTLINE BORDER OF THE WORDING PLANISOL-M.

FOR CLEANER IN THE NATURE OF A DEGREASING PREPARATION USED IN MANUFACTURING FOR REMOVING OIL AND CUTTING FLUIDS FROM SILICONE MOLDS (U.S. CLS. 1, 5, 6, 10, 26 AND 46).

FIRST USE 4-5-1991; IN COMMERCE 4-5-1991.
MICHAEL TANNER, EXAMINING ATTORNEY

SN 77-105,207. SIGMA-ALDRICH BIOTECHNOLOGY L.P., ST. LOUIS, MO. FILED 2-12-2007.

IMPRINT

THE MARK CONSISTS OF STANDARD CHARACTERS WITHOUT CLAIM TO ANY PARTICULAR FONT, STYLE, SIZE, OR COLOR.

FOR CHEMICALS, BIOCHEMICALS AND ORGANIC PREPARATIONS FOR RESEARCH USE, SCIENTIFIC DIAGNOSTIC USE, DIAGNOSTIC RESEARCH USE, DIAGNOSTIC MEDICAL RESEARCH USE, INDUSTRIAL SCIENTIFIC USE, INDUSTRIAL RESEARCH USE, LABORATORY RESEARCH USE AND SCIENTIFIC USE; ENZYMES, REAGENTS, DNA POLYMERASE, RNA POLYMERASE, NUCLEOTIDES AND OLIGONUCLEOTIDES AND DERIVATIVES, ALL FOR RESEARCH USE, SCIENTIFIC DIAGNOSTIC USE, DIAGNOSTIC RESEARCH USE, DIAGNOSTIC MEDICAL RESEARCH USE, INDUSTRIAL SCIENTIFIC USE, INDUSTRIAL RESEARCH USE, LABORATORY RESEARCH USE AND SCIENTIFIC USE; KITS COMPRISING ENZYMES, REAGENTS, DNA POLYMERASE, RNA POLYMERASE, NUCLEOTIDES AND OLIGONUCLEOTIDES AND DERIVATIVES ALL FOR RESEARCH USE, SCIENTIFIC DIAGNOSTIC USE, DIAGNOSTIC RESEARCH USE, DIAGNOSTIC MEDICAL RESEARCH USE, INDUSTRIAL SCIENTIFIC USE, INDUSTRIAL RESEARCH USE, LABORATORY RESEARCH USE AND SCIENTIFIC USE (U.S. CLS. 1, 5, 6, 10, 26 AND 46).

Laurie Kaufman, Examining Attorney

CLASS 1—(Continued).

SN 77-118,450. CARBOZYME, INC., MONMOUTH JCT., NJ. FILED 2-28-2007.



Solutions for Affordable Clean Energy

NO CLAIM IS MADE TO THE EXCLUSIVE RIGHT TO USE "INC.", APART FROM THE MARK AS SHOWN.

THE COLOR(S) RED, BLUE, ORANGE, YELLOW, PINK, PURPLE, TEAL, AND GRAY IS/ARE CLAIMED AS A FEATURE OF THE MARK.

THE MARK CONSISTS OF THE COMPANY NAME WITH A CONFIGURATION OF CARBON DIOXIDE REPRESENTED BY JOINING TWO "O" MOLECULES TO THE "C" IN CARBOZYME THUS CREATING CO₂. THE CARBONIC ANHYDRASE ENZYME (CONSISTING OF STRINGS AND RIBBONS IN RED, BLUE, ORANGE, YELLOW, PINK, PURPLE, TEAL, AND A CARBON MOLECULE IN GRAY) IS DISPLAYED IN THE BACKGROUND.

FOR CARBON DIOXIDE SEPARATION MEMBRANE (U.S. CLS. 1, 5, 6, 10, 26 AND 46).

SALLY SHIH, EXAMINING ATTORNEY

SN 77-123,500. AFTON CHEMICAL INTANGIBLES LLC, RICHMOND, VA. FILED 3-6-2007.



OWNER OF U.S. REG. NO. 2,451,700.
THE COLOR(S) BLUE AND ORANGE IS/ARE CLAIMED AS A FEATURE OF THE MARK.

THE MARK CONSISTS OF THE LOWER CASE LETTER "M" IN BLUE, THE SECOND LOWER CASE LETTER "M" IN ORANGE AND THE LOWER CASE LETTER "T" IN BLUE.

FOR CHEMICAL ADDITIVES FOR LIQUID FUELS FOR INTERNAL COMBUSTION ENGINES, JET ENGINES AND GAS TURBINE ENGINES AND CHEMICAL ADDITIVES FOR BURNER FUELS (U.S. CLS. 1, 5, 6, 10, 26 AND 46).

Toni Hickey, Examining Attorney

CLASS 1—(Continued).

SN 77-125,019. VITASHOWER CORPORATION, HENDERSON, NV. FILED 3-7-2007.

VITA-C-BATH

THE MARK CONSISTS OF STANDARD CHARACTERS WITHOUT CLAIM TO ANY PARTICULAR FONT, STYLE, SIZE, OR COLOR.

FOR VITAMIN C WATER DECHLORINATION TABLETS NOT FOR MEDICAL PURPOSES (U.S. CLS. 1, 5, 6, 10, 26 AND 46).

ALEX KEAM, EXAMINING ATTORNEY

SN 77-128,496. JETZEN INVESTMENT LIMITED, HONG KONG, CHINA, FILED 3-12-2007.



THE COLOR(S) BLUE AND RED IS/ARE CLAIMED AS A FEATURE OF THE MARK.

THE MARK CONSISTS OF A POLYGON, MORE SPECIFICALLY, AN INCOMPLETE HEXAGON DESIGN PRESENTED IN THE COLOR BLUE AND PARTIALLY DIVIDED BY THE LETTERS JSP IN THE COLOR RED. SIX BLUE LINES AT THE LEFT OF THE LETTERING FORM THE LEFT PORTION OF THE INCOMPLETE HEXAGON DESIGN.

FOR CHEMICALS USED IN INDUSTRY; UNPROCESSED ARTIFICIAL RESINS, UNPROCESSED PLASTICS (U.S. CLS. 1, 5, 6, 10, 26 AND 46).

KEVIN CORWIN, EXAMINING ATTORNEY

SN 77-137,750. GLOBALSHIELD, INC., ACWORTH, GA. FILED 3-22-2007.

RapidShield

THE MARK CONSISTS OF STANDARD CHARACTERS WITHOUT CLAIM TO ANY PARTICULAR FONT, STYLE, SIZE, OR COLOR.

FOR WATERPROOFING CHEMICAL COMPOSITIONS FOR ARTICLES OF MASONRY, WOOD AND OTHER BUILDING AND/OR CONSTRUCTION SURFACES (U.S. CLS. 1, 5, 6, 10, 26 AND 46).

FIRST USE 6-16-2006; IN COMMERCE 6-16-2006.

DAVID TAYLOR, EXAMINING ATTORNEY

CLASS 1—(Continued).

SN 77-145,080. JRP INTERNATIONAL, INC., FOND DU LAC, WI. FILED 3-30-2007.

NUTRI-PAK

THE MARK CONSISTS OF STANDARD CHARACTERS WITHOUT CLAIM TO ANY PARTICULAR FONT, STYLE, SIZE, OR COLOR.

OWNER OF U.S. REG. NO. 3,221,054. FOR CONTROLLED RELEASE PLANT FOOD (U.S. CLS. 1, 5, 6, 10, 26 AND 46).

FIRST USE 1-1-1978; IN COMMERCE 5-17-1978.

LESLEY LAMOTHE, EXAMINING ATTORNEY

SN 77-149,248. MORTON INTERNATIONAL, INC., CHICAGO, IL. FILED 4-5-2007.

RAPID FIRE

THE MARK CONSISTS OF STANDARD CHARACTERS WITHOUT CLAIM TO ANY PARTICULAR FONT, STYLE, SIZE, OR COLOR.

FOR SALT, SALT-BASED COMPOSITIONS, POTASSIUM CHLORIDE AND CALCIUM CHLORIDE COMPOSITIONS FOR MELTING ICE AND SNOW (U.S. CLS. 1, 5, 6, 10, 26 AND 46).

JACLYN KIDWELL, EXAMINING ATTORNEY

SN 77-154,069. OSSIAN, INC., DAVENPORT, IA. FILED 4-11-2007.

TITAN XTRA

THE MARK CONSISTS OF STANDARD CHARACTERS WITHOUT CLAIM TO ANY PARTICULAR FONT, STYLE, SIZE, OR COLOR.

FOR ICE MELTING COMPOSITION (U.S. CLS. 1, 5, 6, 10, 26 AND 46).

FIRST USE 3-16-2007; IN COMMERCE 3-16-2007.

ALICE BENMAMAN, EXAMINING ATTORNEY

CLASS 1—(Continued).

SN 77-154,752. JEA, JACKSONVILLE, FL. FILED 4-12-2007.

EZFILL

THE MARK CONSISTS OF STANDARD CHARACTERS WITHOUT CLAIM TO ANY PARTICULAR FONT, STYLE, SIZE, OR COLOR.
OWNER OF U.S. REG. NO. 3,187,909.
FOR COMPOSITION CONTAINING FLY ASH USED AS LAYERING MATTER IN LANDFILLS (U.S. CLS. 1, 5, 6, 10, 26 AND 46).
REGINA DRUMMOND, EXAMINING ATTORNEY

SN 77-154,756. JEA, JACKSONVILLE, FL. FILED 4-12-2007.

EZCOVER

THE MARK CONSISTS OF STANDARD CHARACTERS WITHOUT CLAIM TO ANY PARTICULAR FONT, STYLE, SIZE, OR COLOR.
OWNER OF U.S. REG. NO. 3,187,909.
FOR COMPOSITION CONTAINING FLY ASH USED IN LANDFILLS (U.S. CLS. 1, 5, 6, 10, 26 AND 46).
REGINA DRUMMOND, EXAMINING ATTORNEY

SN 77-156,198. BEL-ART PRODUCTS, PEQUANNOCK, NJ. FILED 4-13-2007.

BLOW-HARD

THE MARK CONSISTS OF STANDARD CHARACTERS WITHOUT CLAIM TO ANY PARTICULAR FONT, STYLE, SIZE, OR COLOR.
FOR AEROSOL CHEMICAL GAS PROPELLANT USED TO REMOVE DUST PARTICLES FROM LABORATORY APPARATUS AND OTHER EQUIPMENT (U.S. CLS. 1, 5, 6, 10, 26 AND 46).
FIRST USE 5-13-1980; IN COMMERCE 5-13-1980.
DAYNA BROWNE, EXAMINING ATTORNEY

CLASS 1—(Continued).

SN 77-157,005. THOMSON FAMILY PARTNERSHIP, DBA VITAMIN INSTITUTE, NORTH HOLLYWOOD, CA. FILED 4-15-2007.

SUPERTHRIVE

THE MARK CONSISTS OF STANDARD CHARACTERS WITHOUT CLAIM TO ANY PARTICULAR FONT, STYLE, SIZE, OR COLOR.
FOR PLANT HORMONES (PHYTOHORMONES); PREPARATIONS FOR FORTIFYING PLANTS (U.S. CLS. 1, 5, 6, 10, 26 AND 46).
FIRST USE 1-28-1941; IN COMMERCE 2-26-1946.
EVELYN BRADLEY, EXAMINING ATTORNEY

SN 77-158,692. INTERNATIONAL AG LABS, INC., FAIRMONT, MN. FILED 4-17-2007.

BLOOMIT

THE MARK CONSISTS OF STANDARD CHARACTERS WITHOUT CLAIM TO ANY PARTICULAR FONT, STYLE, SIZE, OR COLOR.
FOR FERTILIZER, NAMELY, FLOWER AND SEED SET PROMOTER (U.S. CLS. 1, 5, 6, 10, 26 AND 46).
FIRST USE 3-16-2007; IN COMMERCE 3-16-2007.
STACY WAHLBERG, EXAMINING ATTORNEY

SN 77-159,155. ANATRACE, INC., MAUMEE, OH. FILED 4-18-2007.

LYSOFOS

THE MARK CONSISTS OF STANDARD CHARACTERS WITHOUT CLAIM TO ANY PARTICULAR FONT, STYLE, SIZE, OR COLOR.
FOR CHEMICAL REAGENTS FOR NON-MEDICAL PURPOSES; REAGENTS FOR RESEARCH PURPOSES (U.S. CLS. 1, 5, 6, 10, 26 AND 46).
SIMON TENG, EXAMINING ATTORNEY

CLASS 1—(Continued).

SN 77-159,424. A.L.E.G., INC., PARKER, TX. FILED 4-18-2007.

BIO1ONE

THE MARK CONSISTS OF STANDARD CHARACTERS WITHOUT CLAIM TO ANY PARTICULAR FONT, STYLE, SIZE, OR COLOR.

FOR FERTILIZERS AND SOIL AMENDMENTS FOR AGRICULTURAL USE (U.S. CLS. 1, 5, 6, 10, 26 AND 46).
FIRST USE 1-0-1988; IN COMMERCE 1-0-1988.
IRA J. GOODSAY, EXAMINING ATTORNEY

SN 77-160,193. EISNER, DOUGLAS A, DURHAM, NC. FILED 4-18-2007.

GrassRoots Biotechnology

THE MARK CONSISTS OF STANDARD CHARACTERS WITHOUT CLAIM TO ANY PARTICULAR FONT, STYLE, SIZE, OR COLOR.

NO CLAIM IS MADE TO THE EXCLUSIVE RIGHT TO USE "BIOTECHNOLOGY", APART FROM THE MARK AS SHOWN.

FOR BIOTECHNOLOGY FORMED GENES, MICROBES AND ENZYMES FOR USE IN THE PRODUCTION OF AGRICULTURAL SEEDS TO ENHANCE PLANTS' GROWTH THEREFROM (U.S. CLS. 1, 5, 6, 10, 26 AND 46).

REBECCA SMITH, EXAMINING ATTORNEY

SN 77-160,272. GOLDSCHMIDT GMBH, ESSEN, FED REP GERMANY, FILED 4-19-2007.

SKINMIMICS

THE MARK CONSISTS OF STANDARD CHARACTERS WITHOUT CLAIM TO ANY PARTICULAR FONT, STYLE, SIZE, OR COLOR.

OWNER OF FED REP GERMANY REG. NO. 306 43 974, DATED 9-26-2006, EXPIRES 9-26-2016.

FOR CHEMICALS USED IN INDUSTRY, NAMELY ACTIVE INGREDIENTS AND AUXILIARY AGENTS FOR THE PRODUCTION OF COSMETIC PRODUCTS (U.S. CLS. 1, 5, 6, 10, 26 AND 46).

PAUL F. GAST, EXAMINING ATTORNEY

CLASS 1—(Continued).

SN 77-161,179. LOVELAND PRODUCTS, INC., GREELEY, CO. FILED 4-19-2007.

COMPADRE

THE MARK CONSISTS OF STANDARD CHARACTERS WITHOUT CLAIM TO ANY PARTICULAR FONT, STYLE, SIZE, OR COLOR.

FOR ADJUVANTS FOR USE WITH AGRICULTURAL CHEMICALS (U.S. CLS. 1, 5, 6, 10, 26 AND 46).
FIRST USE 3-1-2007; IN COMMERCE 3-1-2007.
JENNIFER MARTIN, EXAMINING ATTORNEY

SN 77-161,662. ARKEMA INC., PHILADELPHIA, PA. FILED 4-20-2007.

PALADIN

THE MARK CONSISTS OF STANDARD CHARACTERS WITHOUT CLAIM TO ANY PARTICULAR FONT, STYLE, SIZE, OR COLOR.

FOR CHEMICALS FOR USE IN INDUSTRY NAMELY FUMIGATION AGENT USED IN AGRICULTURE (U.S. CLS. 1, 5, 6, 10, 26 AND 46).

PRISCILLA MILTON, EXAMINING ATTORNEY

SN 77-167,364. SELAH TECHNOLOGIES, LLC, PENDLETON, SC. FILED 4-27-2007.



NO CLAIM IS MADE TO THE EXCLUSIVE RIGHT TO USE "TECHNOLOGIES", APART FROM THE MARK AS SHOWN.

THE COLOR(S) RED, SILVER AND WHITE IS/ARE CLAIMED AS A FEATURE OF THE MARK.

THE MARK CONSISTS OF SIX RED SPHERES HAVING WHITE CIRCLES, BESIDE "SELAH" IN SILVER OVER "TECHNOLOGIES" IN SILVER, THOSE WORDS SEPARATED BY A SILVER LINE.

FOR CHEMICALS FOR USE IN INDUSTRY AND SCIENCE (U.S. CLS. 1, 5, 6, 10, 26 AND 46).

TERESA M. RUPP, EXAMINING ATTORNEY

CLASS 1—(Continued).

SN 77-169,217. MORTON INTERNATIONAL, INC., CHICAGO, IL. FILED 4-30-2007.

CLASS 1—(Continued).

SN 77-193,736. LIFELINE CELL TECHNOLOGY, WALKERSVILLE, MD. FILED 5-30-2007.

ACTION MELT

THE MARK CONSISTS OF STANDARD CHARACTERS WITHOUT CLAIM TO ANY PARTICULAR FONT, STYLE, SIZE, OR COLOR.

NO CLAIM IS MADE TO THE EXCLUSIVE RIGHT TO USE "MELT", APART FROM THE MARK AS SHOWN.

FOR SALT, SALT-BASED COMPOSITIONS, POTASSIUM CHLORIDE AND CALCIUM CHLORIDE COMPOSITIONS FOR MELTING ICE AND SNOW (U.S. CLS. 1, 5, 6, 10, 26 AND 46).

JACLYN KIDWELL, EXAMINING ATTORNEY

DermaLife

THE MARK CONSISTS OF STANDARD CHARACTERS WITHOUT CLAIM TO ANY PARTICULAR FONT, STYLE, SIZE, OR COLOR.

FOR REAGENTS FOR RESEARCH PURPOSES, NAMELY, FOR RESEARCH FOR THE CULTURE OF SKIN CELLS (U.S. CLS. 1, 5, 6, 10, 26 AND 46).

ADA HAN, EXAMINING ATTORNEY

SN 77-170,810. INTERNATIONAL AG LABS, INC., FAIRMONT, MN. FILED 5-2-2007.

SN 78-486,375. MIRAGENE, INC., ANAHEIM, CA. FILED 9-20-2004.

BUXOM

THE MARK CONSISTS OF STANDARD CHARACTERS WITHOUT CLAIM TO ANY PARTICULAR FONT, STYLE, SIZE, OR COLOR.

FOR GRASS AND TURF FERTILIZERS (U.S. CLS. 1, 5, 6, 10, 26 AND 46).

STACY WAHLBERG, EXAMINING ATTORNEY

Z-GRIP

SN 77-189,217. ARKEMA INC., PHILADELPHIA, PA. FILED 5-24-2007.

BIOSTRENGTH

THE MARK CONSISTS OF STANDARD CHARACTERS WITHOUT CLAIM TO ANY PARTICULAR FONT, STYLE, SIZE, OR COLOR.

FOR CHEMICAL PRODUCTS FOR USE IN INDUSTRY, NAMELY ADDITIVES FOR POLYMERS USED FOR FABRICATION OF PLASTICS, NAMELY BIOPLASTICS (U.S. CLS. 1, 5, 6, 10, 26 AND 46).

PRISCILLA MILTON, EXAMINING ATTORNEY

THE MARK CONSISTS OF STANDARD CHARACTERS WITHOUT CLAIM TO ANY PARTICULAR FONT, STYLE, SIZE, OR COLOR.

FOR BIOCHEMICALS IN THE NATURE OF SLIDES FOR ANALYSIS OF BIOMOLECULAR INTERACTIONS FOR SCIENTIFIC AND MEDICAL RESEARCH USE (U.S. CLS. 1, 5, 6, 10, 26 AND 46).

FIRST USE 2-0-2002; IN COMMERCE 8-0-2003.
STEVEN JACKSON, EXAMINING ATTORNEY

CLASS 1—(Continued).

SN 78-632,161. ECOGNITIVE, INC., BOZEMAN, MT. FILED 5-18-2005.

MetaRocks

FOR LIGHTWEIGHT MEDIA FOR GROWING MICRO-ORGANISMS FOR USE IN A VARIETY OF BIOLOGICAL AND/OR BIOCHEMICAL PROCESSES OR FOR CHEMICALLY TREATING WASTES WITHOUT MICROORGANISMS, THE MEDIA BEING COMPRISED OF A MASS OF POLYMERIC FOAM, SUCH AS POLYURETHANE FOAM, HAVING AN OUTER REGION ENCLOSED AN INNER REGION, WITH A PLURALITY OF FRAGMENTS OF AN INORGANIC MATERIAL, SUCH AS SAND, AT LEAST PARTIALLY EMBEDDED IN THE OUTER REGION (U.S. CLS. 1, 5, 6, 10, 26 AND 46).

TEJBIR SINGH, EXAMINING ATTORNEY

SN 78-776,421. VIACHEM LLC, FARMINGDALE, NY. FILED 12-19-2005.

SUCRALOW

THE MARK CONSISTS OF STANDARD CHARACTERS WITHOUT CLAIM TO ANY PARTICULAR FONT, STYLE, SIZE, OR COLOR.

FOR ARTIFICIAL SWEETENERS, NAMELY, SUCRALOSE (U.S. CLS. 1, 5, 6, 10, 26 AND 46).

FIRST USE 3-17-2006; IN COMMERCE 3-17-2006.
 ALICE BENMAMAN, EXAMINING ATTORNEY

SN 78-821,558. CHEVRON INTELLECTUAL PROPERTY INC., SAN RAMON, CA. FILED 2-23-2006.

PRECISION FUELS

THE MARK CONSISTS OF STANDARD CHARACTERS WITHOUT CLAIM TO ANY PARTICULAR FONT, STYLE, SIZE, OR COLOR.

NO CLAIM IS MADE TO THE EXCLUSIVE RIGHT TO USE "FUELS", APART FROM THE MARK AS SHOWN.

FOR CHEMICAL ADDITIVES FOR FUEL TREATMENT (U.S. CLS. 1, 5, 6, 10, 26 AND 46).

BRENDAN MCCAULEY, EXAMINING ATTORNEY

CLASS 1—(Continued).

SN 78-833,616. STRIKE INVESTMENTS, LLC, LOVELAND, OH. FILED 3-9-2006.

FIBRIQ

THE MARK CONSISTS OF STANDARD CHARACTERS WITHOUT CLAIM TO ANY PARTICULAR FONT, STYLE, SIZE, OR COLOR.

FOR CHEMICALS USED AS PERFORMANCE ENHANCERS IN THE TEXTILE INDUSTRY; UNPROCESSED ARTIFICIAL RESINS USED IN THE TEXTILE INDUSTRY; UNPROCESSED PLASTICS USED IN THE TEXTILE INDUSTRY (U.S. CLS. 1, 5, 6, 10, 26 AND 46).

AMY MCMENAMIN, EXAMINING ATTORNEY

SN 78-913,362. ASINEX LTD., MOSCOW, RUSSIAN FED., FILED 6-21-2006.

ASINEX Synergy Libraries

THE MARK CONSISTS OF STANDARD CHARACTERS WITHOUT CLAIM TO ANY PARTICULAR FONT, STYLE, SIZE, OR COLOR.

OWNER OF U.S. REG. NO. 2,412,076.

FOR SMALL SYNTHETIC-ORGANIC CHEMICAL COMPOUNDS FOR USE IN THE MANUFACTURING OF PHARMACEUTICALS (U.S. CLS. 1, 5, 6, 10, 26 AND 46).

ALLISON SCHRODY, EXAMINING ATTORNEY

CLASS 1—(Continued).

SN 78-944,425. EM RESEARCH ORGANIZATION, INC., TUCSON, AZ. FILED 8-3-2006.

Effective Microorganisms

THE MARK CONSISTS OF STANDARD CHARACTERS WITHOUT CLAIM TO ANY PARTICULAR FONT, STYLE, SIZE, OR COLOR.

OWNER OF U.S. REG. NOS. 2,276,378, 3,151,313 AND OTHERS.

NO CLAIM IS MADE TO THE EXCLUSIVE RIGHT TO USE "MICROORGANISMS", APART FROM THE MARK AS SHOWN.

SEC. 2(F).

FOR CHEMICAL PRESERVATIVE COMPOSITIONS, NAMELY, ANTIOXIDANTS AND ANTIOXIDANT AGENTS FOR USE IN THE MANUFACTURE OF SOAP AND VEGETABLE OILS, AND FOR USE IN THE PRODUCTION OF A WIDE VARIETY OF CHEMICALS; AND ANTIOXIDANT FOOD PRESERVATIVE COMPOSITIONS; RUST INHIBITORS FOR INDUSTRIAL USE; PLANT GROWTH REGULATING AND PLANT GROWTH STIMULATING AND ENHANCING PREPARATIONS; SOIL CONDITIONERS; ORGANIC FERTILIZERS; FERTILIZERS AND COMPOST (U.S. CLS. 1, 5, 6, 10, 26 AND 46).

FIRST USE 12-0-1986; IN COMMERCE 12-0-1986. ROSELLE HERRERA, EXAMINING ATTORNEY

CLASS 1—(Continued).

SN 78-971,516. ADEKA CORPORATION, TOKYO, JAPAN, FILED 9-11-2006.

ADEKA ORCERA

THE MARK CONSISTS OF STANDARD CHARACTERS WITHOUT CLAIM TO ANY PARTICULAR FONT, STYLE, SIZE, OR COLOR.

OWNER OF U.S. REG. NOS. 1,745,395, 1,806,101 AND 1,930,365.

FOR CHEMICALS TO BE USED AS RAW MATERIALS FOR MANUFACTURING SEMI-CONDUCTORS AND ELECTRONIC PARTS; CERAMIC COMPOUNDS TO BE USED AS RAW MATERIALS FOR MANUFACTURING SEMI-CONDUCTORS AND ELECTRONIC PARTS (U.S. CLS. 1, 5, 6, 10, 26 AND 46).

DAVID HOFFMAN, EXAMINING ATTORNEY

SN 78-972,777. CLONTECH LABORATORIES, INC., MOUNTAIN VIEW, CA. FILED 9-12-2006.

TET-ON

CITRITEST

THE MARK CONSISTS OF STANDARD CHARACTERS WITHOUT CLAIM TO ANY PARTICULAR FONT, STYLE, SIZE, OR COLOR.

FOR ASSAY KIT COMPRISING AN AFFINITY COLUMN AND CHEMICAL REAGENTS FOR TESTING FOR MYCOTOXIN CONTAMINATION IN FOOD PRODUCTS (U.S. CLS. 1, 5, 6, 10, 26 AND 46).

FIRST USE 8-23-2006; IN COMMERCE 8-23-2006. ODESSA BIBBINS, EXAMINING ATTORNEY

THE MARK CONSISTS OF STANDARD CHARACTERS WITHOUT CLAIM TO ANY PARTICULAR FONT, STYLE, SIZE, OR COLOR.

OWNER OF U.S. REG. NO. 2,317,563.

FOR REAGENTS FOR SCIENTIFIC OR MEDICAL RESEARCH USE, NAMELY, BUFFER SOLUTIONS, BIOLOGICAL REAGENTS OR BIOCHEMICALS, AND CONJUGATES USED IN MOLECULAR BIOLOGICAL LABORATORIES; AND KITS COMPRISED OF REAGENTS FOR SCIENTIFIC AND MEDICAL RESEARCH USE, NAMELY, BUFFER SOLUTIONS, BIOLOGICAL REAGENTS OR BIOCHEMICALS, AND CONJUGATES USED IN MOLECULAR BIOLOGICAL LABORATORIES (U.S. CLS. 1, 5, 6, 10, 26 AND 46).

FIRST USE 7-15-1996; IN COMMERCE 7-15-1996. JAMES LOVELACE, EXAMINING ATTORNEY

CLASS 2—PAINTS

SN 76-673,178. YOUNGSTOWN TUBE COMPANY, YOUNGSTOWN, OH. FILED 2-26-2007.

YTC GUARD

THE MARK CONSISTS OF STANDARD CHARACTERS WITHOUT CLAIM TO ANY PARTICULAR FONT, STYLE, SIZE, OR COLOR.

FOR CORROSION INHIBITANTS IN THE NATURE OF A COATING (U.S. CLS. 6, 11 AND 16).

FIRST USE 9-18-2006; IN COMMERCE 9-18-2006.
RICHARD WHITE, EXAMINING ATTORNEY

CLASS 2—(Continued).

SN 77-143,753. TIOXIDE EUROPE LIMITED, BILLINGHAM, UNITED KINGDOM, FILED 3-29-2007.

DELTIO

THE MARK CONSISTS OF STANDARD CHARACTERS WITHOUT CLAIM TO ANY PARTICULAR FONT, STYLE, SIZE, OR COLOR.

FOR PIGMENTS, NAMELY FREE-FLOWING TITANIUM DIOXIDE PIGMENTS (U.S. CLS. 6, 11 AND 16).
GEORGIA CARTY, EXAMINING ATTORNEY

SN 77-065,874. OPALSTONE AUSTRALASIA PTY. LTD., ASHMORE, AUSTRALIA, FILED 12-16-2006.

OPALSTONE OT7

THE MARK CONSISTS OF STANDARD CHARACTERS WITHOUT CLAIM TO ANY PARTICULAR FONT, STYLE, SIZE, OR COLOR.

OWNER OF U.S. REG. NOS. 2,446,657 AND 2,750,358.
FOR PRINTING INKS, COATINGS, PIGMENTS AND DISPERSIONS FOR USE IN THE GRAPHIC ARTS INDUSTRY (U.S. CLS. 6, 11 AND 16).

FIRST USE 8-1-2004; IN COMMERCE 8-1-2004.
CHARLOTTE CORWIN, EXAMINING ATTORNEY

SN 77-149,530. YORKTOWN TECHNOLOGIES, L.P., AUSTIN, TX. FILED 4-5-2007.

GLOFISH

THE MARK CONSISTS OF STANDARD CHARACTERS WITHOUT CLAIM TO ANY PARTICULAR FONT, STYLE, SIZE, OR COLOR.

OWNER OF U.S. REG. NOS. 3,042,917 AND 3,056,697.
FOR PAINTS (U.S. CLS. 6, 11 AND 16).
SIMON TENG, EXAMINING ATTORNEY

SN 77-136,887. TEXTURED COATINGS OF AMERICA, INC., LOS ANGELES, CA. FILED 3-21-2007.

COOL-TEX

THE MARK CONSISTS OF STANDARD CHARACTERS WITHOUT CLAIM TO ANY PARTICULAR FONT, STYLE, SIZE, OR COLOR.

FOR SILICATE IMPREGNATED INDOOR AND OUTDOOR SURFACE NON-SLIP SURFACE COATINGS; PROTECTIVE AND DECORATIVE COATINGS IN THE NATURE OF PAINTS, FINISHINGS, WATER REPELLENT PAINTS, AND STAINS FOR INTERIOR AND EXTERIOR APPLICATION ON RESIDENTIAL, COMMERCIAL, NEW CONSTRUCTION AND INDUSTRIAL STRUCTURES (U.S. CLS. 6, 11 AND 16).
SETH A. RAPPAPORT, EXAMINING ATTORNEY

SN 77-155,370. HARLAND MEDICAL SYSTEMS, INC., EDEN PRAIRIE, MN. FILED 4-12-2007.

LUBRICENT

THE MARK CONSISTS OF STANDARD CHARACTERS WITHOUT CLAIM TO ANY PARTICULAR FONT, STYLE, SIZE, OR COLOR.

FOR COATINGS FOR MEDICAL DEVICES AND VETERINARY DEVICES FOR PROVIDING A LUBRICIOUS AND BIOCOMPATIBLE SURFACE, SOLD SEPARATELY FROM THE MEDICAL DEVICES AND VETERINARY DEVICES (U.S. CLS. 6, 11 AND 16).
STEVEN R. FINE, EXAMINING ATTORNEY

CLASS 2—(Continued).

SN 77-156,606. AMERICAN COATINGS CORP., PHOENIX, AZ. FILED 4-13-2007.

SMARTSHIELD AUTO

THE MARK CONSISTS OF STANDARD CHARACTERS WITHOUT CLAIM TO ANY PARTICULAR FONT, STYLE, SIZE, OR COLOR.

NO CLAIM IS MADE TO THE EXCLUSIVE RIGHT TO USE "AUTO", APART FROM THE MARK AS SHOWN.

FOR POLYURETHANE FILM COATINGS USED FOR PAINT PROTECTION ON VEHICLE ROCKER PANELS, TAILGATE PROTECTORS, CARGO LINERS AND DOOR SILLS (U.S. CLS. 6, 11 AND 16).

AMEETA JORDAN, EXAMINING ATTORNEY

SN 77-158,361. C.A.I., INC., GEORGETOWN, MA. FILED 4-17-2007.

MELACOAT

THE MARK CONSISTS OF STANDARD CHARACTERS WITHOUT CLAIM TO ANY PARTICULAR FONT, STYLE, SIZE, OR COLOR.

FOR PRINTERS' INK (U.S. CLS. 6, 11 AND 16).

FIRST USE 4-17-2007; IN COMMERCE 4-17-2007.

AISHA SALEM, EXAMINING ATTORNEY

SN 77-160,806. AMTECO, INC., PACIFIC, MO. FILED 4-19-2007.

AMTECO

THE MARK CONSISTS OF STANDARD CHARACTERS WITHOUT CLAIM TO ANY PARTICULAR FONT, STYLE, SIZE, OR COLOR.

FOR BACTERICIDAL PAINTS; CAMOUFLAGE PAINTS FOR MILITARY EQUIPMENT; CHEMICAL-PROOF PAINTS; CLEAR AND PIGMENTED COATINGS USED IN THE NATURE OF PAINT; COATING COMPOSITION IN THE NATURE OF PAINT FOR INDUSTRIAL APPLICATIONS; COATING COMPOSITIONS IN THE NATURE OF PAINT FOR INDUSTRIAL APPLICATIONS; COLORANTS FOR USE IN THE MANUFACTURE OF PAINT; COLORANTS, PAINTS AND DYES FOR GENERAL INDUSTRIAL USE; CORROSION INHIBITING PAINT TYPE COATINGS FOR COMMERCIAL MARINE USE; CORROSION INHIBITING PAINT TYPE COATINGS FOR USE IN THE OIL AND/OR GAS DRILLING INDUSTRY; DISTEMPERS; ENAMEL PAINTS; ENAMELS IN THE NATURE OF HOUSE PAINT; EXTERIOR PAINT; HOUSE PAINT; INTERIOR PAINT; MIXED PAINTS; OIL PAINTS; PAINT FOR CONCRETE FLOORS; PAINT FOR INDUSTRIAL EQUIPMENT AND MACHINERY; PAINT PRIMERS; PAINT SEALERS; PAINT THINNER; PAINT THINNERS;

CLASS 2—(Continued).

PAINTS; PAVEMENT MARKING PAINT; PAVEMENT STRIPING PAINT; SYNTHETIC RESIN PAINTS; THERMOPLASTIC PAINT MATERIALS FOR USE IN MARKING ROAD SURFACES; TINTS FOR ARCHITECTURAL PAINTS AND PIGMENTED COATINGS FOR INTERIOR AND EXTERIOR USE; WATER REPELLENT PAINTS; WATERPROOF PAINTS; FLOOR PROTECTION VARNISHES; VARNISH; VARNISHES; PRIMERS FOR PREPARING SURFACES TO BE PAINTED; SEALER COATINGS FOR USE IN CONCRETE; STONE SEALERS; PRESERVATIVE COATINGS FOR PAPER AND WOOD SURFACES; RUST PRESERVATIVES IN THE NATURE OF A COATING; WOOD PRESERVATIVES; WOOD PRESERVATIVES FOR FENCES AND OTHER CONSTRUCTION PURPOSES; COATINGS, NAMELY, STAINS AND CLEAR FINISHES FOR EXTERIOR AND INTERIOR USE ON A VARIETY OF SUBSTRATES; WOOD STAINS; CLEAR COATING PROTECTANT FOR ALUMINUM SURFACES; COATINGS IN THE NATURE OF AUTOMOBILE REFINISHING; COLORANT DISPERSIONS FOR USE IN SURFACE COATING COMPOSITIONS; CONCRETE MOISTURE BARRIER COATING; CORROSION INHIBITANTS IN THE NATURE OF A COATING; RESIN-BASED COATINGS FOR USE ON ROOFS, WALLS AND PAVEMENTS; RUST PREVENTATIVES IN THE NATURE OF A COATING (U.S. CLS. 6, 11 AND 16).

FIRST USE 3-31-1980; IN COMMERCE 3-31-1980.

TASHIA BUNCH, EXAMINING ATTORNEY

SN 77-165,851. LAXMI C. GUPTA, LOS ALAMITOS, CA. FILED 4-25-2007.

THEMECOAT

THE MARK CONSISTS OF STANDARD CHARACTERS WITHOUT CLAIM TO ANY PARTICULAR FONT, STYLE, SIZE, OR COLOR.

FOR CLEAR AND PIGMENTED COATINGS USED IN THE NATURE OF PAINT (U.S. CLS. 6, 11 AND 16).

FIRST USE 4-1-2007; IN COMMERCE 4-1-2007.

TRACY WHITTAKER-BROWN, EXAMINING ATTORNEY

SN 77-202,371. C.A.I., INC., GEORGETOWN, MA. FILED 6-11-2007.

AQUA-MC

THE MARK CONSISTS OF STANDARD CHARACTERS WITHOUT CLAIM TO ANY PARTICULAR FONT, STYLE, SIZE, OR COLOR.

OWNER OF U.S. REG. NOS. 2,728,245, 2,751,435 AND OTHERS.

FOR PRINTERS' INK (U.S. CLS. 6, 11 AND 16).

FIRST USE 6-7-2007; IN COMMERCE 6-7-2007.

AISHA SALEM, EXAMINING ATTORNEY

CLASS 3—COSMETICS AND CLEANING PREPARATIONS

SN 76-362,114. CHURCH & DWIGHT VIRGINIA CO., INC., COLONIAL HEIGHTS, VA. FILED 1-23-2002.

TROJAN

OWNER OF U.S. REG. NOS. 544,931, 2,882,051 AND OTHERS.

FOR DEODORANTS AND ANTIPERSPIRANTS (U.S. CLS. 1, 4, 6, 50, 51 AND 52).

MICHAEL SOUDERS, EXAMINING ATTORNEY

SN 76-550,643. FINANZ ST. HONORE, B.V., 1017 CG AMSTERDAM, NETHERLANDS, FILED 10-9-2003.

DANA

OWNER OF U.S. REG. NOS. 580,767 AND 1,626,590.

FOR AFTER SHAVE LOTIONS, BODY LOTION, BODY SOUFFLE IN THE NATURE OF SKIN LOTIONS, COLOGNE, DUSTING POWDER, PERSONAL DEODORANT, DRY BODY OIL, EAU DE COLOGNE, EAU DE PERFUME, EAU DE PERFUME SPRAY MIST, EAU DE TOILETTE, FOAMING BATH SHOWER GEL, HAND AND BODY LOTION, HAND AND BODY MOISTURIZER, MOISTURIZING GEL, PERFUME BODY SOUFFLE IN THE NATURE OF SKIN LOTIONS, PUMICE SHOWER GEL, SHOWER GEL, SOAP (U.S. CLS. 1, 4, 6, 50, 51 AND 52).

FIRST USE 0-0-1933; IN COMMERCE 0-0-1933.

ALEX KEAM, EXAMINING ATTORNEY

SN 76-672,516. ZESTRON GMBH, D-85053 INGOLSTADT, FED REP GERMANY, FILED 2-9-2007.

FAST

THE MARK CONSISTS OF STANDARD CHARACTERS WITHOUT CLAIM TO ANY PARTICULAR FONT, STYLE, SIZE, OR COLOR.

FOR ALL PURPOSE INDUSTRIAL CLEANERS FOR HARD SURFACES (U.S. CLS. 1, 4, 6, 50, 51 AND 52).

TONI HICKEY, EXAMINING ATTORNEY

CLASS 3—(Continued).

SN 76-672,862. DAILY NATURALS, LLC., NEW HOPE, MN. FILED 2-20-2007.

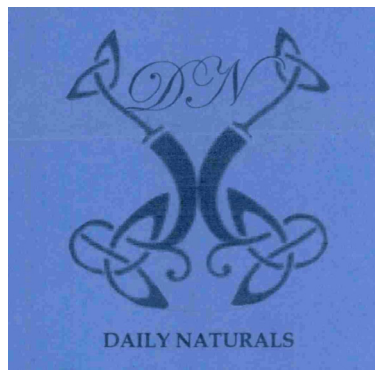

NO CLAIM IS MADE TO THE EXCLUSIVE RIGHT TO USE "NATURALS", APART FROM THE MARK AS SHOWN. THE COLOR(S) BLACK AND CORNFLOWER BLUE IS/ARE CLAIMED AS A FEATURE OF THE MARK.

THE COLOR BLACK APPEARS AS THE COLOR OF THE WORDING DAILY NATURALS, DN AND THE DESIGN ELEMENT. THE COLOR CORNFLOWER BLUE APPEARS AS THE COLOR OF THE BACKGROUND.

FOR NATURAL FACE AND BODY CARE SOAP, BAR SOAP, SHAMPOO, HAIR CONDITIONER, LIP BALM, HAND LOTION, FACE LOTION, BODY LOTION, TOOTHPASTE, SUNSCREEN LOTION (U.S. CLS. 1, 4, 6, 50, 51 AND 52).

JANICE KIM, EXAMINING ATTORNEY

SN 76-674,160. LYNCH, CHRISTOPHER, DEBARY, FL. FILED 3-16-2007.

CORTEZ

THE MARK CONSISTS OF THE TERM "CORTEZ" WITH THREE HORIZONTAL LINES ABOVE THE WORDING AND THREE HORIZONTAL LINES BELOW. THE LINES ARE PROGRESSIVELY SMALLER FROM TOP TO BOTTOM SO AS TO FORM AN UPSIDE-DOWN PYRAMID WITH THE WORDING IN BETWEEN

FOR PERFUMERY, COSMETICS (U.S. CLS. 1, 4, 6, 50, 51 AND 52).

GIANCARLO CASTRO, EXAMINING ATTORNEY

CLASS 3—(Continued).

SN 77-002,123. VEGANWORLD CORPORATION, MARCO ISLAND, FL. FILED 9-19-2006.

VEGANU

THE MARK CONSISTS OF STANDARD CHARACTERS WITHOUT CLAIM TO ANY PARTICULAR FONT, STYLE, SIZE, OR COLOR.

FOR SOAP, NAMELY, SKIN SOAP, HAND SOAP, ANTIBACTERIAL SOAP, BAR SOAP, BATH SOAPS IN LIQUID, SOLID OR GEL FORM, DEODORANT SOAP, DETERGENT SOAP, DISINFECTING PERFUMED SOAPS, GRANULATED SOAPS, INDUSTRIAL SOAPS, LAUNDRY SOAPS, LIQUID SOAPS, MEDICATED SOAPS, PERFUMED SOAP, SADDLE SOAP, SOAP POWDER, SOAPS FOR BODY CARE, SOAPS FOR HOUSEHOLD USE, SOAPS FOR PERSONAL USE, TOILET SOAPS, AND WATERLESS SOAPS; SHAMPOOS; CONDITIONERS, NAMELY, SKIN CONDITIONERS, HAIR CONDITIONERS, CUTICLE CONDITIONERS, AND SHAMPOO-CONDITIONERS; LOTIONS, NAMELY, AFTER SHAVE LOTIONS, AROMATHERAPY LOTIONS, AFTER-SUN LOTIONS, AGE RETARDANT LOTIONS, BABY LOTIONS, BATH LOTIONS, BEAUTY LOTIONS, BODY LOTIONS, EYE LOTIONS, COSMETIC SUNTAN LOTIONS, FACE AND BODY LOTIONS, FACE MILK AND LOTIONS, FACIAL LOTION, HAIR CARE LOTIONS, HAIR LOTIONS, HAIR WAVING LOTION, HAND LOTIONS, LOTIONS FOR BEARDS, LOTIONS FOR CELLULITE REDUCTION, LOTIONS FOR FACE AND BODY CARE, LOTIONS FOR STRENGTHENING THE NAILS, MAKE-UP REMOVING LOTIONS, MAKE-UP REMOVING MILK, GEL, LOTIONS AND CREAMS, NON-MEDICATED DIAPER RASH OINTMENTS AND LOTIONS, NON-MEDICATED STIMULATING LOTIONS FOR THE SKIN, SHAVING LOTIONS, SKIN CLEANSING LOTION, SKIN LOTIONS, STYLING LOTIONS, SUN CARE LOTIONS, SUN TAN LOTIONS, SUN-BLOCK LOTIONS, TEETH CLEANING LOTIONS, AND TONING LOTION FOR THE FACE, BODY AND HANDS; CREAMS, NAMELY, AFTER SUN CREAMS, AFTER-SHAVE CREAMS, AGE SPOT REDUCING CREAMS, ANTI-AGING CREAM, ANTI-FRECKLE CREAMS, ANTI-WRINKLE CREAMS, AROMATHERAPY CREAMS, BEAUTY CREAMS, BEAUTY CREAMS FOR BODY CARE, BODY CREAMS, BODY CREAM SOAP, BODY MASK CREAM, BOOT CREAM, COSMETIC CLEANSING CREAMS, COLD CREAMS, COSMETIC CREAMS, COSMETIC CREAMS FOR SKIN CARE, CREAM SOAPS, CREAMS FOR CELLULITE REDUCTION, CUTICLE CREAM, DEPILATORY CREAMS, EXFOLIANT CREAMS, EYE CREAM, FACE AND BODY BEAUTY CREAMS, FACE AND BODY CREAMS, FACE CREAMS FOR COSMETIC USE, FACIAL CREAMS, FAIR COMPLEXION CREAM, HAIR CARE CREAMS, HAIR CREAMS, HAIR REMOVING CREAM, HAND CREAMS, LIP CREAM, MAKE-UP REMOVING MILK, GEL, LOTIONS AND CREAMS, NAIL CREAM, NIGHT CREAM, NON-MEDICATED FOOT CREAM, NON-MEDICATED SCALP TREATMENT CREAM, NON-MEDICATED SKIN CREAMS, PERFUMED CREAMS, PRE-SHAVE CREAMS, SHAVING CREAMS, SHOE AND BOOT CREAM, SHOWER CREAMS, SKIN CLEANSING CREAM, SKIN CREAM, SKIN CREAMS IN LIQUID AND IN SOLID FORM, SKIN LIGHTENING CREAMS, SKIN WHITENING CREAMS, SUN CREAMS, SUNSCREEN CREAMS, SELF-TANNING CREAMS, TANNING CREAMS, TOPICAL HERBAL CREAM FOR FIRING AND ENHANCING BREASTS, VANISHING CREAM, AND WRINKLE RESISTANT CREAM; CLEANSERS, NAMELY, FACIAL CLEANSERS AND SKIN CLEANSERS; AND COSMETICS (U.S. CLS. 1, 4, 6, 50, 51 AND 52).

CHARLOTTE CORWIN, EXAMINING ATTORNEY

CLASS 3—(Continued).

SN 77-009,333. U.S. NONWOVENS CORP., BRENTWOOD, NY. FILED 9-28-2006.

BREEZE

THE MARK CONSISTS OF STANDARD CHARACTERS WITHOUT CLAIM TO ANY PARTICULAR FONT, STYLE, SIZE, OR COLOR.

FOR SCENTED FABRIC REFRESHER SHEETS (U.S. CLS. 1, 4, 6, 50, 51 AND 52).

WON TEAK OH, EXAMINING ATTORNEY

SN 77-020,404. MOOR, JUDITH, ATLANTA, GA. FILED 10-13-2006.



NO CLAIM IS MADE TO THE EXCLUSIVE RIGHT TO USE "PERFUME ASSISTS RELIEF FROM AIDS", APART FROM THE MARK AS SHOWN.

THE MARK CONSISTS OF THE WORD "PARAIDS" WITH THE DESIGN OF A CHILD HOLDING A FLAG WHICH FORMS THE "R" IN "PARAIDS".

FOR PERFUME (U.S. CLS. 1, 4, 6, 50, 51 AND 52).

FRED MANDIR, EXAMINING ATTORNEY

SN 77-023,491. SUPRE, INC., DALLAS, TX. FILED 10-18-2006.

Algomax

THE MARK CONSISTS OF STANDARD CHARACTERS WITHOUT CLAIM TO ANY PARTICULAR FONT, STYLE, SIZE, OR COLOR.

FOR SKIN CARE PREPARATION, NAMELY, INGREDIENT FOR SKIN SOFTENING AND TAN DARKENING ENHANCEMENT, IN NON-MEDICATED INDOOR AND OUTDOOR TANNING LOTIONS AND MOISTURIZERS (U.S. CLS. 1, 4, 6, 50, 51 AND 52).

FIRST USE 12-1-2006; IN COMMERCE 12-1-2006.

JOHN DALIER, EXAMINING ATTORNEY

CLASS 3—(Continued).

SN 77-039,992. THE MADDEN CORPORATION, WAIPAHU, HI. FILED 11-8-2006.

COCONUT WILLIE

THE MARK CONSISTS OF STANDARD CHARACTERS WITHOUT CLAIM TO ANY PARTICULAR FONT, STYLE, SIZE, OR COLOR.

NO CLAIM IS MADE TO THE EXCLUSIVE RIGHT TO USE "COCONUT", APART FROM THE MARK AS SHOWN. FOR SUN TAN OIL (U.S. CLS. 1, 4, 6, 50, 51 AND 52). FIRST USE 9-30-2005; IN COMMERCE 9-30-2005. MONIQUE MILLER, EXAMINING ATTORNEY

SN 77-046,140. THE MADDEN CORPORATION, WAIPAHU, HI. FILED 11-16-2006.

COCONUT WILLIE

THE MARK CONSISTS OF STANDARD CHARACTERS WITHOUT CLAIM TO ANY PARTICULAR FONT, STYLE, SIZE, OR COLOR.

NO CLAIM IS MADE TO THE EXCLUSIVE RIGHT TO USE "COCONUT", APART FROM THE MARK AS SHOWN. FOR ALOE VERA GEL FOR COSMETIC PURPOSES; SUN TAN LOTION (U.S. CLS. 1, 4, 6, 50, 51 AND 52). MONIQUE MILLER, EXAMINING ATTORNEY

SN 77-046,175. THE MADDEN CORPORATION, WAIPAHU, HI. FILED 11-16-2006.

ROYAL HAWAIIAN

THE MARK CONSISTS OF STANDARD CHARACTERS WITHOUT CLAIM TO ANY PARTICULAR FONT, STYLE, SIZE, OR COLOR.

OWNER OF U.S. REG. NO. 235,803. NO CLAIM IS MADE TO THE EXCLUSIVE RIGHT TO USE "HAWAIIAN", APART FROM THE MARK AS SHOWN. FOR SUN TAN LOTION (U.S. CLS. 1, 4, 6, 50, 51 AND 52). FIRST USE 9-30-2005; IN COMMERCE 9-30-2005. MONIQUE MILLER, EXAMINING ATTORNEY

CLASS 3—(Continued).

SN 77-050,689. METHOD PRODUCTS, INC, SAN FRANCISCO, CA. FILED 11-26-2006.

GO NAKED

THE MARK CONSISTS OF STANDARD CHARACTERS WITHOUT CLAIM TO ANY PARTICULAR FONT, STYLE, SIZE, OR COLOR.

FOR HOUSEHOLD CLEANING PRODUCTS, NAMELY, CLEANING PREPARATIONS, DISH SOAPS, LAUNDRY DETERGENTS, FABRIC SOFTENERS, ALL PURPOSE AND SPECIALTY SURFACE CLEANING SPRAYS, BIODEGRADABLE DISPOSABLE CLOTHS IMPREGNATED WITH NON-TOXIC CHEMICALS OR COMPOUNDS FOR PERSONAL HYGIENE AND HOUSEHOLD USE AND BIODEGRADABLE DISPOSABLE WIPES IMPREGNATED WITH NON-TOXIC CHEMICALS OR COMPOUNDS FOR PERSONAL HYGIENE AND HOUSEHOLD USE, PERSONAL CARE PRODUCTS, NAMELY, BODY SOAPS, NON-MEDICATED HAND WASHES AND BODY WASHES, SANITIZERS FOR HOUSEHOLD USE, SKIN CLEANSERS AND HAND AND BODY LOTIONS; (U.S. CLS. 1, 4, 6, 50, 51 AND 52). STEPHANIE ALI, EXAMINING ATTORNEY

SN 77-063,019. VICTORIA'S SECRET STORES BRAND MANAGEMENT, INC., REYNOLDSBURG, OH. FILED 12-13-2006.

DRENCHED IN PINK

THE MARK CONSISTS OF STANDARD CHARACTERS WITHOUT CLAIM TO ANY PARTICULAR FONT, STYLE, SIZE, OR COLOR.

FOR PERSONAL CARE PRODUCTS NAMELY, BODY LOTIONS, EAU DE PARFUM, BODY WASH, BODY SPLASH, SOAPS (U.S. CLS. 1, 4, 6, 50, 51 AND 52). MARK PILARO, EXAMINING ATTORNEY

CLASS 3—(Continued).

SN 77-087,576. BUOY, ROGER, SOMERSET BS40 8RA, UNITED KINGDOM, FILED 1-22-2007.

THREE LIONS

THE MARK CONSISTS OF STANDARD CHARACTERS WITHOUT CLAIM TO ANY PARTICULAR FONT, STYLE, SIZE, OR COLOR.

FOR PERFUMES; NON-MEDICATED TOILETRIES; OILS FOR TOILETRY PURPOSES; COSMETICS; HAIR CARE PREPARATIONS; NON-MEDICATED SKIN CARE PREPARATIONS; BATH BEADS; BATH CRYSTALS; BATH FOAMS; BATH GELS; BATH LOTION; BATH MILKS; BATH OILS; BATH PEARLS; BATH POWDER; BATH SALTS; BATH SOAPS IN LIQUID, SOLID OR GEL FORM; BUBBLE BATH; BODY AND BEAUTY CARE COSMETICS; AROMATHERAPY OILS; AROMATHERAPY CREAMS; AROMATHERAPY LOTIONS (U.S. CLS. 1, 4, 6, 50, 51 AND 52).
MONIQUE MILLER, EXAMINING ATTORNEY

CLASS 3—(Continued).

SN 77-138,196. JAFER LIMITED, HAMILTON, BERMUDA, FILED 3-22-2007.

MUSK BY YANBAL

THE MARK CONSISTS OF STANDARD CHARACTERS WITHOUT CLAIM TO ANY PARTICULAR FONT, STYLE, SIZE, OR COLOR.

OWNER OF U.S. REG. NOS. 1,241,758, 2,983,379 AND 3,131,255.

NO CLAIM IS MADE TO THE EXCLUSIVE RIGHT TO USE "MUSK", APART FROM THE MARK AS SHOWN.

FOR PERFUMES, EAU DE PERFUME, FRAGRANCES FOR PERSONAL USE, TOILET WATER, COLOGNE, AFTER-SHAVE LOTIONS, TOILET SOAP, DEODORANT FOR PERSONAL USE, ANTIPERSPIRANTS, TALCUM POWDER, BODY LOTIONS, HAIR SHAMPOO, HAIR CONDITIONERS, HAIR CARE CREAMS, HAIR GELS, HAIR RINSES, HAIR STYLING PREPARATIONS, HAIR SHAMPOO-CONDITIONERS, HAIR CARE PREPARATIONS, FACIAL LOTIONS, HAND LOTIONS, HAND CREAMS, FACIAL CREAMS AND BODY CREAMS (U.S. CLS. 1, 4, 6, 50, 51 AND 52).

CURTIS FRENCH, EXAMINING ATTORNEY

SN 77-139,101. JOHNSON DIVERSEY, INC., STURTEVANT, WI. FILED 3-23-2007.

GALLERIA

THE MARK CONSISTS OF STANDARD CHARACTERS WITHOUT CLAIM TO ANY PARTICULAR FONT, STYLE, SIZE, OR COLOR.

FOR FLOOR CLEANING PREPARATIONS, NAMELY SPECIALTY FLOOR CLEANER AND FLOOR FINISHING PREPARATION (U.S. CLS. 1, 4, 6, 50, 51 AND 52).

BENJAMIN OKEKE, EXAMINING ATTORNEY

SN 77-112,810. TECH CHEM LLC, HILTON HEAD, SC. FILED 2-21-2007.

TECH KLEEN

THE MARK CONSISTS OF STANDARD CHARACTERS WITHOUT CLAIM TO ANY PARTICULAR FONT, STYLE, SIZE, OR COLOR.

NO CLAIM IS MADE TO THE EXCLUSIVE RIGHT TO USE "CLEAN", APART FROM THE MARK AS SHOWN.

FOR DEGREASING PREPARATIONS FOR INDUSTRIAL METAL CLEANING AND ENGINEERING MAINTENANCE (U.S. CLS. 1, 4, 6, 50, 51 AND 52).

FIRST USE 10-1-2004; IN COMMERCE 10-1-2004.
ROBERT LAVACHE, EXAMINING ATTORNEY

SN 77-141,607. TBH MARKS, INC., WILMINGTON, DE. FILED 3-27-2007.

CACTINE

THE MARK CONSISTS OF STANDARD CHARACTERS WITHOUT CLAIM TO ANY PARTICULAR FONT, STYLE, SIZE, OR COLOR.

OWNER OF U.S. REG. NOS. 1,200,086, 2,059,947 AND 2,438,622.

FOR SKIN CLEANSERS; SKIN CONDITIONERS; SUNSCREEN CREAMS; HAIR RINSES; HAIR SHAMPOO; SHAMPOO-CONDITIONERS; SHAMPOOS; HAIR CARE PREPARATIONS; HAIR CONDITIONERS; HAIR GELS; HAIR LACQUERS; HAIR SPRAY; HAIR STYLING GEL (U.S. CLS. 1, 4, 6, 50, 51 AND 52).

KAPIL BHANOT, EXAMINING ATTORNEY

CLASS 3—(Continued).

SN 77-147,303. ELMIAN PRODUCTS, INC., ATLANTA, GA. FILED 4-3-2007.

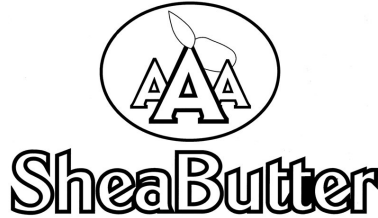

NO CLAIM IS MADE TO THE EXCLUSIVE RIGHT TO USE "SHEABUTTER", APART FROM THE MARK AS SHOWN.

THE DESIGN INSIDE THE OVAL CONSISTS OF A SHEA NUT WITH AN ATTACHED LEAF.

FOR COSMETIC CREAMS FOR SKIN CARE; NON-MEDICATED SKIN CREAMS; SKIN MOISTURIZER; BODY OILS (U.S. CLS. 1, 4, 6, 50, 51 AND 52).

FIRST USE 3-1-2004; IN COMMERCE 3-1-2004.

ALICE SUE CARRUTHERS, EXAMINING ATTORNEY

SN 77-151,687. PIGTAILS & CREWCUTS FRANCHISE, LLC, ROSWELL, GA. FILED 4-9-2007.

GOOFY GRAPE

THE MARK CONSISTS OF STANDARD CHARACTERS WITHOUT CLAIM TO ANY PARTICULAR FONT, STYLE, SIZE, OR COLOR.

NO CLAIM IS MADE TO THE EXCLUSIVE RIGHT TO USE "GRAPE", APART FROM THE MARK AS SHOWN.

FOR SHAMPOOS (U.S. CLS. 1, 4, 6, 50, 51 AND 52).

JUDITH HELFMAN, EXAMINING ATTORNEY

SN 77-151,713. KIM, HAE WON, MARIETTA, GA. FILED 4-9-2007.

Dema Block

THE MARK CONSISTS OF STANDARD CHARACTERS WITHOUT CLAIM TO ANY PARTICULAR FONT, STYLE, SIZE, OR COLOR.

FOR HAND CREAM (U.S. CLS. 1, 4, 6, 50, 51 AND 52).

B. PARADEWELAI, EXAMINING ATTORNEY

CLASS 3—(Continued).

SN 77-152,046. MEME DELRAY BEACH, LLC, DELRAY BEACH, FL. FILED 4-9-2007.

ELEVEN

THE MARK CONSISTS OF STANDARD CHARACTERS WITHOUT CLAIM TO ANY PARTICULAR FONT, STYLE, SIZE, OR COLOR.

OWNER OF U.S. REG. NOS. 3,176,169 AND 3,213,170.

FOR BODY AND BEAUTY CARE COSMETICS, NAMELY, SKIN MOISTURIZERS, TONERS, CHEMICAL PEELS FOR SKIN, SUN BLOCKS, BEAUTY MASKS, SKIN CREAMS, SKIN AND BODY TOPICAL LOTIONS, FACIAL CLEANSERS, MAKE-UP REMOVERS, SKIN MOISTURIZERS, LIP BALMS, COSMETIC OILS, LIP GLOSSES, SUGAR BODY SCRUBS, BODY COCOA BUTTERS, BODY WASHES, BUBBLE BATH, RELIEF GELS, NAMELY, EYE GELS, EYE SHADOWS, LIQUID EYE LINERS, NATURAL MINERAL MAKE-UP FACE POWDERS, BLUSHES, CONCEALERS, FOUNDATIONS, LIP GLOSSES, LIPSTICKS, PRESSED FACE POWDERS, MAKE-UP KITS CONTAINING COSMETICS, SKIN BRONZERS, MAKEUP PENCILS, NAMELY, LIP PENCILS, EYEBROW PENCILS, EYELINER PENCILS, AND MASCARAS (U.S. CLS. 1, 4, 6, 50, 51 AND 52).

FIRST USE 8-31-2005; IN COMMERCE 1-10-2006.

LEE-ANNE BERNS, EXAMINING ATTORNEY

SN 77-155,007. SMITHKLINE BEECHAM CONSUMER HEALTHCARE GMBH, BUEHL, FED REP GERMANY, FILED 4-12-2007.

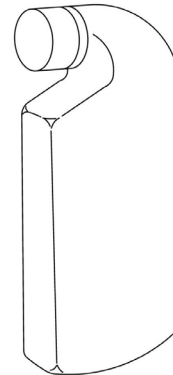

OWNER OF U.S. REG. NO. 822,530. THE MARK CONSISTS OF DESIGN OF GOOSENECK BOTTLE.

SEC. 2(F).

FOR MOUTHWASH (U.S. CLS. 1, 4, 6, 50, 51 AND 52).

FIRST USE 2-2-1893; IN COMMERCE 2-2-1893.

MARLENE BELL, EXAMINING ATTORNEY

CLASS 3—(Continued).

SN 77-156,141. CAL TAN, LLC, LOS ANGELES, CA. FILED 4-13-2007.

Razzle Dazzle

THE MARK CONSISTS OF STANDARD CHARACTERS WITHOUT CLAIM TO ANY PARTICULAR FONT, STYLE, SIZE, OR COLOR.

FOR COSMETIC SUN-TANNING PREPARATIONS; SKIN GELS FOR ACCELERATING, ENHANCING OR EXTENDING TANS; SUN TAN LOTION; SUNTAN CREAMS; TANNING CREAMS (U.S. CLS. 1, 4, 6, 50, 51 AND 52).

JEFF DEFORD, EXAMINING ATTORNEY

SN 77-156,177. BEL-ART PRODUCTS, PEQUANNOCK, NJ. FILED 4-13-2007.

CHROMERGE

THE MARK CONSISTS OF STANDARD CHARACTERS WITHOUT CLAIM TO ANY PARTICULAR FONT, STYLE, SIZE, OR COLOR.

FOR CHEMICAL COMPOSITION FOR CLEANING LABORATORY WARE (U.S. CLS. 1, 4, 6, 50, 51 AND 52). FIRST USE 3-20-1960; IN COMMERCE 3-25-1960.

DAYNA BROWNE, EXAMINING ATTORNEY

SN 77-156,182. GUEST SUPPLY, INC., MONMOUTH JUNCTION, NJ. FILED 4-13-2007.

CITROS ESSENTIALS

THE MARK CONSISTS OF STANDARD CHARACTERS WITHOUT CLAIM TO ANY PARTICULAR FONT, STYLE, SIZE, OR COLOR.

NO CLAIM IS MADE TO THE EXCLUSIVE RIGHT TO USE "CITRUS", APART FROM THE MARK AS SHOWN.

FOR HAIR CARE PREPARATIONS; SKIN SOAP (U.S. CLS. 1, 4, 6, 50, 51 AND 52).

ADA HAN, EXAMINING ATTORNEY

CLASS 3—(Continued).

SN 77-156,651. FRIEDBERG, CHRISTOPHER, PHILADELPHIA, PA. FILED 4-13-2007.

Celluvation

THE MARK CONSISTS OF STANDARD CHARACTERS WITHOUT CLAIM TO ANY PARTICULAR FONT, STYLE, SIZE, OR COLOR.

FOR BEAUTY MASKS (U.S. CLS. 1, 4, 6, 50, 51 AND 52).

KATHERINE M. DUBRAY, EXAMINING ATTORNEY

SN 77-157,012. YOLI ENTERPRISES, JAMESBURG, NJ. FILED 4-15-2007.



THE COLOR(S) GREEN AND PURPLE IS/ARE CLAIMED AS A FEATURE OF THE MARK.

THE MARK CONSISTS OF THE WORD SUVONNE' IN PURPLE WITH A GREEN RIBBON ATTACHED TO THE LETTER "V" IN SUVONNE'.

FOR DEODORANTS FOR BODY CARE; BATH OIL; BATH SALTS; BODY LOTIONS; HAND LOTIONS; SHOWER AND BATH GEL; BODY SCRUB; FACIAL SCRUBS; NON-MEDICATED FOOT CREAM; BEAUTY CREAMS FOR BODY CARE; CUTICLE CREAM; HAIR CREAMS; HAND CREAMS; NAIL CREAM; SKIN CREAMS IN LIQUID AND IN SOLID FORM; BODY SPRAYS; BEAUTY LOTIONS; LIP BALM; FOOT DEODORANT SPRAY (U.S. CLS. 1, 4, 6, 50, 51 AND 52).

JAMES LOVELACE, EXAMINING ATTORNEY

SN 77-157,411. REGIS, INC., MINNEAPOLIS, MN. FILED 4-16-2007.

VIVID SATIN

THE MARK CONSISTS OF STANDARD CHARACTERS WITHOUT CLAIM TO ANY PARTICULAR FONT, STYLE, SIZE, OR COLOR.

FOR HAIR SHAMPOO, HAIR CONDITIONERS, HAIR CARE LOTIONS (U.S. CLS. 1, 4, 6, 50, 51 AND 52).

CAROLINE WOOD, EXAMINING ATTORNEY

CLASS 3—(Continued).

SN 77-157,461. FLYING SWINE DEVELOPMENT, INC., AUSTIN, TX. FILED 4-16-2007.

FLYING SWINE

THE MARK CONSISTS OF STANDARD CHARACTERS WITHOUT CLAIM TO ANY PARTICULAR FONT, STYLE, SIZE, OR COLOR.

FOR DEODORANTS AND ANTIPERSPIRANTS; DEODORANTS FOR PERSONAL USE; COLOGNES (U.S. CLS. 1, 4, 6, 50, 51 AND 52).

DAVID MURRAY, EXAMINING ATTORNEY

SN 77-157,580. ALFALFA NAIL SUPPLY, INC., BATON ROUGE, LA. FILED 4-16-2007.

BOTANICAL ESCAPES

THE MARK CONSISTS OF STANDARD CHARACTERS WITHOUT CLAIM TO ANY PARTICULAR FONT, STYLE, SIZE, OR COLOR.

NO CLAIM IS MADE TO THE EXCLUSIVE RIGHT TO USE "BOTANICAL", APART FROM THE MARK AS SHOWN.

FOR AROMATIC PRODUCTS, NAMELY, SKIN CREAMS AND LOTIONS, BATH AND SHOWER SALTS, NON-MEDICATED FOOT GEL, NAIL STRENGTHENER, CUTICLE OIL AND FOOT AND HAND MASKS (U.S. CLS. 1, 4, 6, 50, 51 AND 52).

CAROLINE WOOD, EXAMINING ATTORNEY

SN 77-157,595. E.O.H. BEAUTY BRANDS, INC., OMAHA, NE. FILED 4-16-2007.

EARTHESS SPA

THE MARK CONSISTS OF STANDARD CHARACTERS WITHOUT CLAIM TO ANY PARTICULAR FONT, STYLE, SIZE, OR COLOR.

NO CLAIM IS MADE TO THE EXCLUSIVE RIGHT TO USE "SPA", APART FROM THE MARK AS SHOWN.

FOR BODY SALT SCRUBS; BATH SALTS; NON-MEDICATED HERBAL EYE PADS FOR COSMETIC PURPOSES; SKIN MASSAGE LOTIONS; SKIN MASSAGE CREAMS (U.S. CLS. 1, 4, 6, 50, 51 AND 52).

ALEX KEAM, EXAMINING ATTORNEY

CLASS 3—(Continued).

SN 77-158,013. NERO, ANDREA, LAS VEGAS, NV. FILED 4-16-2007.



THE MARK CONSISTS OF AN DESIGN IN THE FORM OF LIPS WITH STYLIZED TEXT.

FOR COSMETICS (U.S. CLS. 1, 4, 6, 50, 51 AND 52).
HEATHER THOMPSON, EXAMINING ATTORNEY

SN 77-158,033. UNDENIABLY YOU, SICKLERVILLE, NJ. FILED 4-16-2007.

Come Back Weave

THE MARK CONSISTS OF STANDARD CHARACTERS WITHOUT CLAIM TO ANY PARTICULAR FONT, STYLE, SIZE, OR COLOR.

NO CLAIM IS MADE TO THE EXCLUSIVE RIGHT TO USE "WEAVE", APART FROM THE MARK AS SHOWN.

FOR OILS FOR HAIR CONDITIONING (U.S. CLS. 1, 4, 6, 50, 51 AND 52).

FIRST USE 4-16-2007; IN COMMERCE 4-16-2007.

KAREN K. BUSH, EXAMINING ATTORNEY

SN 77-159,052. MOMENTS BY MARIE, INC., ORANGE PARK, FL. FILED 4-17-2007.

SUGAR SCRUB SCENTRAL

THE MARK CONSISTS OF STANDARD CHARACTERS WITHOUT CLAIM TO ANY PARTICULAR FONT, STYLE, SIZE, OR COLOR.

NO CLAIM IS MADE TO THE EXCLUSIVE RIGHT TO USE "SUGAR SCRUB", APART FROM THE MARK AS SHOWN.

FOR BATH CRYSTALS (U.S. CLS. 1, 4, 6, 50, 51 AND 52).

JAY FLOWERS, EXAMINING ATTORNEY

CLASS 3—(Continued).

SN 77-159,085. GAHLOU WELLNESS,LLC, FLUSHING, NY. AND MAGALY COLIMON, FLUSHING, NY. FILED 4-17-2007.



THE COLOR(S) ORANGE AND WHITE IS/ARE CLAIMED AS A FEATURE OF THE MARK.

THE COLORS ORANGE AND WHITE ARE CLAIMED AS A FEATURE OF THE MARK. THE COLOR ORANGE APPEARS IN THE WORDING AROMATIC SOOTHERS AND IN THE CIRCULAR/LOTUS FLOWER DESIGN ELEMENT. THE COLOR WHITE APPEARS IN THE WORDING AH! AND AS THE SCALLOPED DETAIL WITHIN THE CIRCULAR/LOTUS FLOWER DESIGN ELEMENT.

FOR AROMATHERAPY CREAMS; HAND CREAM; HAND CREAMS; MOUSSE FOR SKIN; NON-MEDICATED SKIN CARE PREPARATIONS; NON-MEDICATED SKIN CREAMS; PERFUMED CREAMS; SKIN CARE PRODUCTS, NAMELY, NON-MEDICATED SKIN SERUM; SKIN CREAMS; SKIN CREAMS IN LIQUID AND SOLID FORM; SKIN EMOLLIENTS; SKIN MOISTURIZER; BODY CREAMS (U.S. CLS. 1, 4, 6, 50, 51 AND 52).

JENNIFER HETU, EXAMINING ATTORNEY

SN 77-159,323. BC INTERNATIONAL COSMETIC & IMAGE SERVICES, INC., ORLANDO, FL. FILED 4-18-2007.

VICTORIAN HOLIDAY

THE MARK CONSISTS OF STANDARD CHARACTERS WITHOUT CLAIM TO ANY PARTICULAR FONT, STYLE, SIZE, OR COLOR.

FOR BATH AND BODY PRODUCTS, NAMELY, BODY WASH, BODY CREAM, BODY SHIMMER SPRAY; SCENTED LINEN SPRAY (U.S. CLS. 1, 4, 6, 50, 51 AND 52).

VIVIAN MICZNIK FIRST, EXAMINING ATTORNEY

CLASS 3—(Continued).

SN 77-160,195. SWAT.FAME, INC., CITY OF INDUSTRY, CA. FILED 4-18-2007.

SPEECHLESS

THE MARK CONSISTS OF STANDARD CHARACTERS WITHOUT CLAIM TO ANY PARTICULAR FONT, STYLE, SIZE, OR COLOR.

OWNER OF U.S. REG. NO. 1,923,815.

FOR PERFUME; TOILET WATER; COLOGNE; FRAGRANCES FOR PERSONAL USE; SCENTED BODY SPRAYS; BATH PREPARATIONS, NAMELY, BEADS, CRYSTALS, GELS, OILS AND POWDERS; BUBBLE BATHS; LIP BALM; COSMETICS, NAMELY, LIPSTICK, LIP GLOSS, FACE POWDER, FACIAL BASE, BLUSH, EYE MAKE-UP, EYE SHADOW, AND MASCARA; NAIL POLISH (U.S. CLS. 1, 4, 6, 50, 51 AND 52).

DAVID H. STINE, EXAMINING ATTORNEY

SN 77-160,214. WINEKING HOLDINGS, LLC, SHAWNEE, KS. FILED 4-18-2007.

ULTRACARE TEETH WHITENING

THE MARK CONSISTS OF STANDARD CHARACTERS WITHOUT CLAIM TO ANY PARTICULAR FONT, STYLE, SIZE, OR COLOR.

NO CLAIM IS MADE TO THE EXCLUSIVE RIGHT TO USE "TEETH WHITENING", APART FROM THE MARK AS SHOWN.

FOR TEETH WHITENING GEL, TOOTHPASTE, AND NON-MEDICATED MOUTHWASH (U.S. CLS. 1, 4, 6, 50, 51 AND 52).

INGRID C. EULIN, EXAMINING ATTORNEY

SN 77-160,478. WANG, CHU WUEN KEVIN, MISSISSAUGA, ONTARIO, CANADA, FILED 4-19-2007.

DOLABEY

THE MARK CONSISTS OF STANDARD CHARACTERS WITHOUT CLAIM TO ANY PARTICULAR FONT, STYLE, SIZE, OR COLOR.

FOR PERFUMES, COLOGNE, COSMETICS, NAMELY, LIPSTICKS, LIP LINERS, EYE-MAKEUP, BLUSHERS, MAKE-UP POWDERS, HAIR POMADE, HAIR PASTE, SKIN CARE AND BODY CARE PRODUCTS, NAMELY, SKIN CREAM, SKIN CONDITIONER, BODY OILS, NAIL POLISH AND VARNISH, POLISH AND VARNISH REMOVER, AND FALSE NAILS (U.S. CLS. 1, 4, 6, 50, 51 AND 52).

VERNA BETH RIRIE, EXAMINING ATTORNEY

CLASS 3—(Continued).

SN 77-160,847. SALON COLOURA, INC., NEW KENSINGTON, PA. FILED 4-19-2007.

ECO-PELO

THE MARK CONSISTS OF STANDARD CHARACTERS WITHOUT CLAIM TO ANY PARTICULAR FONT, STYLE, SIZE, OR COLOR.

THE FOREIGN WORDING IN THE MARK TRANSLATES INTO ENGLISH AS PELO (HAIR).

FOR NON-MEDICATED HAIR CARE PREPARATIONS, NAMELY, HAIR SHAMPOO AND CLEANSERS, HAIR SPRAY, HAIR CONDITIONER, HAIR GEL, HAIR MOUSSE, HAIR RINSES, AND HAIR STYLING PREPARATIONS (U.S. CLS. 1, 4, 6, 50, 51 AND 52).

JOHN DWYER, EXAMINING ATTORNEY

CLASS 3—(Continued).

SN 77-161,486. L'OREAL, PARIS, FRANCE, FILED 4-20-2007.

INDESTRUCTIBLE

THE MARK CONSISTS OF STANDARD CHARACTERS WITHOUT CLAIM TO ANY PARTICULAR FONT, STYLE, SIZE, OR COLOR.

FOR HAIR STYLING PREPARATION (U.S. CLS. 1, 4, 6, 50, 51 AND 52).

FIRST USE 1-0-2007; IN COMMERCE 1-0-2007.

BARBARA A. LOUGHRAN, EXAMINING ATTORNEY

SN 77-160,862. L'OREAL USA CREATIVE, INC., NEW YORK, NY. FILED 4-19-2007.

XXL

THE MARK CONSISTS OF STANDARD CHARACTERS WITHOUT CLAIM TO ANY PARTICULAR FONT, STYLE, SIZE, OR COLOR.

FOR COSMETICS (U.S. CLS. 1, 4, 6, 50, 51 AND 52).

MICHAEL ENGEL, EXAMINING ATTORNEY

SN 77-161,490. L'OREAL, PARIS, FRANCE, FILED 4-20-2007.

INFALLIBLE

THE MARK CONSISTS OF STANDARD CHARACTERS WITHOUT CLAIM TO ANY PARTICULAR FONT, STYLE, SIZE, OR COLOR.

FOR COSMETICS (U.S. CLS. 1, 4, 6, 50, 51 AND 52).

BARBARA A. LOUGHRAN, EXAMINING ATTORNEY

SN 77-161,217. ONE WORLD NETWORKS INTEGRATED TECHNOLOGIES, INC, LOS ANGELES, CA. FILED 4-19-2007.

firm n' light

THE MARK CONSISTS OF STANDARD CHARACTERS WITHOUT CLAIM TO ANY PARTICULAR FONT, STYLE, SIZE, OR COLOR.

OWNER OF U.S. REG. NO. 3,135,760.

FOR BLEACHING PREPARATIONS FOR COSMETIC PURPOSES; BODY AND BEAUTY CARE COSMETICS (U.S. CLS. 1, 4, 6, 50, 51 AND 52).

FIRST USE 1-6-2005; IN COMMERCE 1-6-2005.

AMY BROZENIC, EXAMINING ATTORNEY

SN 77-161,970. J. CANNON, INC., FORT WORTH, TX. FILED 4-20-2007.

ACV

THE MARK CONSISTS OF STANDARD CHARACTERS WITHOUT CLAIM TO ANY PARTICULAR FONT, STYLE, SIZE, OR COLOR.

FOR HAIR LOTIONS, AND HAIR CARE PRODUCTS, NAMELY, SHAMPOOS, CONDITIONERS AND MOUSSE (U.S. CLS. 1, 4, 6, 50, 51 AND 52).

FIRST USE 4-26-1997; IN COMMERCE 4-26-1997.

ANDREA K. NADELMAN, EXAMINING ATTORNEY

CLASS 3—(Continued).

SN 77-162,266. QUIKSILVER, INC., HUNTINGTON BEACH, CA. FILED 4-20-2007.

ROXY LOVE

THE MARK CONSISTS OF STANDARD CHARACTERS WITHOUT CLAIM TO ANY PARTICULAR FONT, STYLE, SIZE, OR COLOR.

FOR PERFUMES; FRAGRANCES FOR PERSONAL USE; COSMETICS; ESSENTIAL OILS FOR PERSONAL USE; SOAPS FOR PERSONAL USE, BODY CARE AND HOUSEHOLD USE; HAIR LOTIONS; SUN SCREEN PREPARATIONS; SUN TANNING PREPARATIONS; BATH GELS; BATH OILS; BATH POWDERS; DEODORANTS FOR PERSONAL USE; SHOWER GELS; SHAMPOOS; FACIAL SCRUBS; FACE POWDERS; SKIN SOAPS; SKIN MOISTURIZERS; BODY LOTIONS; NAIL POLISH; LIP BALMS; LIP GLOSS; LIPSTICK; FACIAL MAKEUP AND EYE MAKEUP (U.S. CLS. 1, 4, 6, 50, 51 AND 52).
RENEE SERVANCE, EXAMINING ATTORNEY

SN 77-162,270. QUIKSILVER, INC., HUNTINGTON BEACH, CA. FILED 4-20-2007.

ROXY HEART

THE MARK CONSISTS OF STANDARD CHARACTERS WITHOUT CLAIM TO ANY PARTICULAR FONT, STYLE, SIZE, OR COLOR.

FOR PERFUMES; FRAGRANCES FOR PERSONAL USE; COSMETICS; ESSENTIAL OILS FOR PERSONAL USE; SOAPS FOR PERSONAL USE, BODY CARE AND HOUSEHOLD USE; HAIR LOTIONS; SUN SCREEN PREPARATIONS; SUN TANNING PREPARATIONS; BATH GELS; BATH OILS; BATH POWDERS; DEODORANTS FOR PERSONAL USE; SHOWER GELS; SHAMPOOS; FACIAL SCRUBS; FACE POWDERS; SKIN SOAPS; SKIN MOISTURIZERS; BODY LOTIONS; NAIL POLISH; LIP BALMS; LIP GLOSS; LIPSTICK; FACIAL MAKEUP AND EYE MAKEUP (U.S. CLS. 1, 4, 6, 50, 51 AND 52).
RENEE SERVANCE, EXAMINING ATTORNEY

SN 77-162,392. PARK, CHARLES, ONTARIO, CA. FILED 4-20-2007.

FOREVER GREEN

THE MARK CONSISTS OF STANDARD CHARACTERS WITHOUT CLAIM TO ANY PARTICULAR FONT, STYLE, SIZE, OR COLOR.

NO CLAIM IS MADE TO THE EXCLUSIVE RIGHT TO USE "GREEN", APART FROM THE MARK AS SHOWN.
FOR IMPREGNATED CLEANING, DUSTING OR POLISHING CLOTHS (U.S. CLS. 1, 4, 6, 50, 51 AND 52).
FIRST USE 2-13-2007; IN COMMERCE 2-13-2007.
MARTHA FROMM, EXAMINING ATTORNEY

CLASS 3—(Continued).

SN 77-163,198. L'OREAL USA CREATIVE, INC., NEW YORK, NY. FILED 4-23-2007.

OVERNIGHT TREAT

THE MARK CONSISTS OF STANDARD CHARACTERS WITHOUT CLAIM TO ANY PARTICULAR FONT, STYLE, SIZE, OR COLOR.

NO CLAIM IS MADE TO THE EXCLUSIVE RIGHT TO USE "OVERNIGHT", APART FROM THE MARK AS SHOWN.

FOR HAIR TREATMENT PREPARATION (U.S. CLS. 1, 4, 6, 50, 51 AND 52).

MICHAEL ENGEL, EXAMINING ATTORNEY

SN 77-164,177. QUICK-MED TECHNOLOGIES, INC., GAINESVILLE, FL. FILED 4-24-2007.

NimbuDerm

THE MARK CONSISTS OF STANDARD CHARACTERS WITHOUT CLAIM TO ANY PARTICULAR FONT, STYLE, SIZE, OR COLOR.

FOR SKIN CLEANSERS; BODY SPRAYS; BODY WASHES; COSMETIC PREPARATIONS FOR BODY CARE; COSMETIC PREPARATIONS FOR SKIN RENEWAL; COSMETIC SOAPS; HAND SOAPS; IMPREGNATED CLEANING CLOTHS; MEDICATED SOAP; PERSONAL DEODORANTS; SHAMPOOS; SHAVING PREPARATIONS; SKIN CLEANSING CREAM; SKIN CLEANSING LOTION; WRINKLE REMOVING SKIN CARE PREPARATIONS (U.S. CLS. 1, 4, 6, 50, 51 AND 52).

LAURIE MAYES, EXAMINING ATTORNEY

SN 77-164,250. ALFORD, ERIN NICOLE, YAMHIL, OR. FILED 4-24-2007.

BATHGAL

THE MARK CONSISTS OF STANDARD CHARACTERS WITHOUT CLAIM TO ANY PARTICULAR FONT, STYLE, SIZE, OR COLOR.

FOR BODY AND BEAUTY CARE COSMETICS; BODY MILKS; BODY OIL; BODY SCRUB; BODY SPRAYS; BODY WASHES; FACE AND BODY BEAUTY CREAMS; FACE AND BODY LOTIONS; LIQUID SOAPS FOR HANDS, FACE AND BODY; NON-MEDICATED BODY SOAKS; SOAPS FOR BODY CARE; FACIAL MASKS (U.S. CLS. 1, 4, 6, 50, 51 AND 52).

KATHY DE JONGE, EXAMINING ATTORNEY

CLASS 3—(Continued).

SN 77-164,904. L'OREAL, PARIS, FRANCE, FILED 4-25-2007.

PURE RESOURCE

THE MARK CONSISTS OF STANDARD CHARACTERS WITHOUT CLAIM TO ANY PARTICULAR FONT, STYLE, SIZE, OR COLOR.

FOR SHAMPOOS; GELS, SPRAYS, MOUSSES AND BALMS FOR HAIR STYLING AND HAIR CARE; HAIR LACQUERS; HAIR COLOURING AND HAIR DECOLORANT PREPARATIONS; PERMANENT WAVING AND CURLING PREPARATIONS; HAIR STRAIGHTENERS; ESSENTIAL OILS FOR PERSONAL USE (U.S. CLS. 1, 4, 6, 50, 51 AND 52).

BARBARA A. LOUGHRAN, EXAMINING ATTORNEY

SN 77-169,642. ZINO DAVIDOFF SA, 1700 FRIBOURG, SWITZERLAND, FILED 5-1-2007.

THE THRILL OF THE UNKNOWN

THE MARK CONSISTS OF STANDARD CHARACTERS WITHOUT CLAIM TO ANY PARTICULAR FONT, STYLE, SIZE, OR COLOR.

FOR TOILET SOAPS; PERFUMERY; COSMETICS; NON-MEDICATED SUN CARE PREPARATIONS; BATH AND SHOWER GELS AND FOAMS; NON-MEDICATED SKIN CARE PREPARATIONS; PRE-SHAVE OILS, CREAMS, GELS AND LOTIONS; AFTER-SHAVE OILS, CREAMS, POWDERS AND LOTIONS; PERSONAL DEODORANTS AND ANTI-PERSPIRANTS (U.S. CLS. 1, 4, 6, 50, 51 AND 52).

JANICE KIM, EXAMINING ATTORNEY

SN 77-173,319. L'OREAL USA CREATIVE, INC., NEW YORK, NY. FILED 5-4-2007.

REJUVATONE

THE MARK CONSISTS OF STANDARD CHARACTERS WITHOUT CLAIM TO ANY PARTICULAR FONT, STYLE, SIZE, OR COLOR.

OWNER OF U.S. REG. NO. 733,923.

FOR HAIR COLOR (U.S. CLS. 1, 4, 6, 50, 51 AND 52).

MICHAEL ENGEL, EXAMINING ATTORNEY

CLASS 3—(Continued).

SN 77-173,969. IREDALE MINERAL COSMETICS, LTD., GREAT BARRINGTON, MA. FILED 5-7-2007.

IN TOUCH

THE MARK CONSISTS OF STANDARD CHARACTERS WITHOUT CLAIM TO ANY PARTICULAR FONT, STYLE, SIZE, OR COLOR.

FOR COSMETICS, NAMELY, CREAM COLOR FOR LIPS AND CHEEKS (U.S. CLS. 1, 4, 6, 50, 51 AND 52).

ERIN FALK, EXAMINING ATTORNEY

SN 77-177,482. L'OREAL USA CREATIVE, INC., NEW YORK, NY. FILED 5-10-2007.

SUPERSTAY POWERGLOSS

THE MARK CONSISTS OF STANDARD CHARACTERS WITHOUT CLAIM TO ANY PARTICULAR FONT, STYLE, SIZE, OR COLOR.

OWNER OF U.S. REG. NO. 3,131,107.

FOR LIP COLOR (U.S. CLS. 1, 4, 6, 50, 51 AND 52).

MICHAEL ENGEL, EXAMINING ATTORNEY

SN 77-177,590. ZEN SPA ENTERPRISES, INC., SAN JUAN, PUERTO RICO, FILED 5-10-2007.

Spa Souffle

THE MARK CONSISTS OF STANDARD CHARACTERS WITHOUT CLAIM TO ANY PARTICULAR FONT, STYLE, SIZE, OR COLOR.

NO CLAIM IS MADE TO THE EXCLUSIVE RIGHT TO USE "SPA", APART FROM THE MARK AS SHOWN.

FOR SKIN CARE PRODUCTS, NAMELY, LOTIONS AND CREAMS FOR THE BODY, FACE, HANDS AND FEET (U.S. CLS. 1, 4, 6, 50, 51 AND 52).

IRA J. GOODSaid, EXAMINING ATTORNEY

CLASS 3—(Continued).

SN 77-177,620. ZEN SPA ENTERPRISES, INC., SAN JUAN, PUERTO RICO, FILED 5-10-2007.

Spa Bubbles

THE MARK CONSISTS OF STANDARD CHARACTERS WITHOUT CLAIM TO ANY PARTICULAR FONT, STYLE, SIZE, OR COLOR.

NO CLAIM IS MADE TO THE EXCLUSIVE RIGHT TO USE "SPA", APART FROM THE MARK AS SHOWN.

FOR SKIN AND BODY CARE PRODUCTS, NAMELY, BATH SALTS (U.S. CLS. 1, 4, 6, 50, 51 AND 52).

IRA J. GOODSAD, EXAMINING ATTORNEY

SN 77-179,782. L'OREAL USA CREATIVE, INC., NEW YORK, NY. FILED 5-14-2007.

SUPERSTAY CREAMWEAR

THE MARK CONSISTS OF STANDARD CHARACTERS WITHOUT CLAIM TO ANY PARTICULAR FONT, STYLE, SIZE, OR COLOR.

OWNER OF U.S. REG. NO. 3,131,107.

FOR LIP COLOR (U.S. CLS. 1, 4, 6, 50, 51 AND 52).

MICHAEL ENGEL, EXAMINING ATTORNEY

SN 77-180,798. COHEN, MARK, SANTA MONICA, CA. FILED 5-14-2007.

Color Breeze

THE MARK CONSISTS OF STANDARD CHARACTERS WITHOUT CLAIM TO ANY PARTICULAR FONT, STYLE, SIZE, OR COLOR.

NO CLAIM IS MADE TO THE EXCLUSIVE RIGHT TO USE "COLOR", APART FROM THE MARK AS SHOWN.

FOR HAIR CARE PRODUCTS, NAMELY SHAMPOOS, CONDITIONERS, HAIR GELS, HAIR POMADES, HAIR OILS, MOISTURIZERS, AND HAIR CREAMS; HAIR COLOR PRODUCTS NAMELY, PERMANENT HAIR COLOR, DEMI-PERMANENT HAIR COLOR, SEMI-PERMANENT HAIR COLOR, TEMPORARY HAIR COLOR; HAIR BLEACH; HAIR BLEACHING PREPARATION; HAIR TECHNICAL PRODUCTS, NAMELY, HAIR CARE PREPARATIONS, HAIR CLEANING PREPARATIONS, HAIR RELAXING PREPARATIONS, HAIR STRAIGHTENING PREPARATIONS AND HAIR STYLING PREPARATIONS (U.S. CLS. 1, 4, 6, 50, 51 AND 52).

SOPHIA S. KIM, EXAMINING ATTORNEY

CLASS 3—(Continued).

SN 77-180,994. CHOPRA ENTERPRISES, LLC, CARLSBAD, CA. FILED 5-15-2007.

CHOPRA CENTER

THE MARK CONSISTS OF STANDARD CHARACTERS WITHOUT CLAIM TO ANY PARTICULAR FONT, STYLE, SIZE, OR COLOR.

OWNER OF U.S. REG. NOS. 2,202,591, 2,215,788 AND 3,173,576.

FOR AROMATHERAPY CREAMS; AROMATHERAPY LOTIONS; AROMATHERAPY OILS; BATH LOTION; BATHING LOTIONS; BEAUTY LOTIONS; BODY AND BEAUTY CARE COSMETICS; FACE AND BODY BEAUTY CREAMS; BODY LOTIONS; BODY OILS; BODY SCRUB; BODY WASHES; COSMETIC CREAMS; COSMETIC CREAMS FOR SKIN CARE; COSMETIC OILS; COSMETIC PREPARATIONS FOR BODY CARE; COSMETIC PREPARATIONS FOR SKIN RENEWAL; COSMETIC SOAPS; COSMETICS; FACE CREAMS FOR COSMETIC USE; NUTRITIONAL OILS FOR COSMETIC PURPOSES; SKIN AND BODY TOPICAL LOTIONS, CREAMS AND OILS FOR COSMETIC USE; FACE CREAMS; FACIAL CREAMS; FACIAL LOTION; FACIAL SCRUBS; FACIAL WASHES; FRAGRANCES FOR PERSONAL USE; HAIR CARE CREAMS; HAIR CARE LOTIONS; HAIR CARE PREPARATIONS; HAIR CONDITIONERS; HAIR CREAMS; HAIR LOTIONS; HAIR SHAMPOO; HAIR RINSES; INCENSE; INCENSE STICKS; MASSAGE OILS; PERFUME; SHAMPOOS; SKIN CLEANSERS; SKIN CONDITIONERS; SKIN CREAMS; SKIN LOTIONS (U.S. CLS. 1, 4, 6, 50, 51 AND 52).

LANA PHAM, EXAMINING ATTORNEY

SN 77-181,347. CAL TAN, LLC, LOS ANGELES, CA. FILED 5-15-2007.

BEACHES 'N CREAM

THE MARK CONSISTS OF STANDARD CHARACTERS WITHOUT CLAIM TO ANY PARTICULAR FONT, STYLE, SIZE, OR COLOR.

FOR BODY LOTION; COSMETIC SUN-TANNING PREPARATIONS; SELF-TANNING PREPARATIONS; SKIN LOTION; SUNTAN CREAMS (U.S. CLS. 1, 4, 6, 50, 51 AND 52).

JEFF DEFORD, EXAMINING ATTORNEY

CLASS 3—(Continued).

SN 77-187,438. TOO FACED COSMETICS, INC., IRVINE, CA. FILED 5-22-2007.

BARE DOWN THERE

THE MARK CONSISTS OF STANDARD CHARACTERS WITHOUT CLAIM TO ANY PARTICULAR FONT, STYLE, SIZE, OR COLOR.

FOR HAIR REMOVING CREAM; LOTIONS FOR INHIBITING GROWTH OF BODY HAIR (U.S. CLS. 1, 4, 6, 50, 51 AND 52).

JENNIFER KRISP, EXAMINING ATTORNEY

CLASS 3—(Continued).

SN 77-194,507. PETLAND, INC., CHILLICOTHE, OH. FILED 5-31-2007.

HERE KITTY

THE MARK CONSISTS OF STANDARD CHARACTERS WITHOUT CLAIM TO ANY PARTICULAR FONT, STYLE, SIZE, OR COLOR.

OWNER OF U.S. REG. NO. 1,929,262.

FOR DEODORIZERS FOR PETS; SHAMPOOS; COSMETICS FOR ANIMALS; NON-MEDICATED GROOMING PREPARATIONS FOR CATS, NAMELY, BATH; PET ODOR REMOVERS; STAIN REMOVERS; DEODORANTS FOR ANIMALS (U.S. CLS. 1, 4, 6, 50, 51 AND 52).

ERIN FALK, EXAMINING ATTORNEY

SN 77-188,732. BC INTERNATIONAL COSMETIC & IMAGE SERVICES, INC., ORLANDO, FL. FILED 5-23-2007.

CITY GARDEN

THE MARK CONSISTS OF STANDARD CHARACTERS WITHOUT CLAIM TO ANY PARTICULAR FONT, STYLE, SIZE, OR COLOR.

FOR BODY WASH, BODY LOTION, BODY SPRAY, FRAGRANCE EMITTING STICKS FOR ROOM FRAGRANCE (U.S. CLS. 1, 4, 6, 50, 51 AND 52).

VIVIAN MICZNIK FIRST, EXAMINING ATTORNEY

SN 77-195,436. AUSTRALIAN GOLD, INC., INDIANAPOLIS, IN. FILED 6-1-2007.

TAN TODAY FOR A HEALTHY TOMORROW

THE MARK CONSISTS OF STANDARD CHARACTERS WITHOUT CLAIM TO ANY PARTICULAR FONT, STYLE, SIZE, OR COLOR.

FOR SKIN CARE PREPARATIONS, NAMELY, NON-MEDICATED INDOOR AND OUTDOOR TANNING PREPARATIONS (U.S. CLS. 1, 4, 6, 50, 51 AND 52).

DAVID YONTEF, EXAMINING ATTORNEY

SN 77-189,507. MASINI ALESSANDRO, FIRENZE, ITALY, FILED 5-24-2007.

ALESSANDRO MASINI

THE MARK CONSISTS OF STANDARD CHARACTERS WITHOUT CLAIM TO ANY PARTICULAR FONT, STYLE, SIZE, OR COLOR.

FOR PERFUME (U.S. CLS. 1, 4, 6, 50, 51 AND 52).

KENNETH E. SHARPERSON, EXAMINING ATTORNEY

SN 77-202,852. AUSTRALIAN GOLD, INC., INDIANAPOLIS, IN. FILED 6-11-2007.

CELLUDARK

THE MARK CONSISTS OF STANDARD CHARACTERS WITHOUT CLAIM TO ANY PARTICULAR FONT, STYLE, SIZE, OR COLOR.

FOR SKIN CARE PREPARATIONS, NAMELY, NON-MEDICATED INDOOR AND OUTDOOR TANNING PREPARATIONS; SKIN MOISTURIZERS; BODY OILS; ANTI-WRINKLE CREAM; FACIAL POWDERS; FACIAL MAKEUP; BATH SOAPS AND GELS (U.S. CLS. 1, 4, 6, 50, 51 AND 52).

DAVID YONTEF, EXAMINING ATTORNEY

CLASS 3—(Continued).

SN 77-202,864. AUSTRALIAN GOLD, INC., INDIANAPOLIS, IN. FILED 6-11-2007.

DERMATAN

THE MARK CONSISTS OF STANDARD CHARACTERS WITHOUT CLAIM TO ANY PARTICULAR FONT, STYLE, SIZE, OR COLOR.

FOR SKIN CARE PREPARATIONS, NAMELY, NON-MEDICATED INDOOR AND OUTDOOR TANNING PREPARATIONS; SKIN MOISTURIZERS; BODY OILS; ANTI-WRINKLE CREAM; FACIAL POWDERS; FACIAL MAKEUP; BATH SOAPS AND GELS (U.S. CLS. 1, 4, 6, 50, 51 AND 52).

DAVID YONTEF, EXAMINING ATTORNEY

CLASS 3—(Continued).

SN 77-211,772. SHISEIDO COMPANY, LTD., TOKYO, JAPAN, FILED 6-21-2007.

CREAM SCIENCE AA EX

THE MARK CONSISTS OF STANDARD CHARACTERS WITHOUT CLAIM TO ANY PARTICULAR FONT, STYLE, SIZE, OR COLOR.

NO CLAIM IS MADE TO THE EXCLUSIVE RIGHT TO USE "CREAM", APART FROM THE MARK AS SHOWN.

FOR NON-MEDICATED SKIN CARE PREPARATIONS; HAIR CARE PREPARATIONS; BODY CARE PRODUCTS, NAMELY, BODY SOAPS, BODY CREAMS, BODY LOTIONS, BODY POWDERS, NON-MEDICATED DEODORANTS AND ANTI-PERSPIRANTS; NON-MEDICATED SUNCARE PRODUCTS, NAMELY, SUNSCREEN, SUN BLOCK AND SUN TANNING PREPARATIONS; PREPARATIONS TO PROTECT THE SKIN FROM THE SUN, NAMELY, NON-MEDICATED SUN CREAMS AND NON-MEDICATED AFTER-SUN LOTIONS; BATH PRODUCTS, NAMELY, BATH BEADS, BATH FOAM, BATH GELS, BATH LOTION, BATH OIL, BATH POWDER, AND NON-MEDICATED BATH SALTS; PERFUME, COLOGNE, COSMETICS AND MAKEUP (U.S. CLS. 1, 4, 6, 50, 51 AND 52).

TAMARA FRAZIER, EXAMINING ATTORNEY

SN 77-207,790. HATCHER, TERI, LOS ANGELES, CA. FILED 6-15-2007.

LIBATION

THE MARK CONSISTS OF STANDARD CHARACTERS WITHOUT CLAIM TO ANY PARTICULAR FONT, STYLE, SIZE, OR COLOR.

FOR COSMETICS, NAMELY, BLUSHERS FOR THE FACE, BRONZING CREAMS AND POWDERS FOR THE FACE AND BODY, CONCEALERS FOR THE EYES AND FACE, COSMETIC COMPACTS CONTAINING PRESSED FACE POWDER AND CREAM FOUNDATION, FOUNDATION MAKEUP, LOOSE FACE POWDER, LIP GLOSS, LIPSTICK, MASCARA, NAIL POLISH, EYE MAKEUP, NAMELY, EYE SHADOWS, EYE PENCILS AND EYELINERS ALL SOLD INDIVIDUALLY OR IN SELF-CONTAINED CARRYING CASE; AND ROOM FRAGRANCES; BATH BEADS, BATH CRYSTALS, BATH FOAM, BATH GEL, BATH OIL, BATH SALTS NON-MEDICATED, AND BUBBLE BATH (U.S. CLS. 1, 4, 6, 50, 51 AND 52).

KATHERINE CHANG, EXAMINING ATTORNEY

SN 77-216,521. SHISEIDO COMPANY, LTD., TOKYO, JAPAN, FILED 6-27-2007.

FAUX-SEMBLANT

THE MARK CONSISTS OF STANDARD CHARACTERS WITHOUT CLAIM TO ANY PARTICULAR FONT, STYLE, SIZE, OR COLOR.

THE FOREIGN WORDING IN THE MARK TRANSLATES INTO ENGLISH AS FALSE PRETENSE.

FOR NON-MEDICATED SKIN CARE PREPARATIONS; HAIR CARE PREPARATIONS; BODY CARE PRODUCTS, NAMELY, BODY SOAPS, BODY CREAMS, BODY LOTIONS, BODY POWDERS, NON-MEDICATED DEODORANTS AND ANTI-PERSPIRANTS; NON-MEDICATED SUNCARE PRODUCTS, NAMELY, SUNSCREEN, SUN BLOCK AND SUN TANNING PREPARATIONS; PREPARATIONS TO PROTECT THE SKIN FROM THE SUN, NAMELY, NON-MEDICATED SUN CREAMS AND NON-MEDICATED AFTER-SUN LOTIONS; BATH PRODUCTS, NAMELY, BATH BEADS, BATH FOAM, BATH GELS, BATH LOTION, BATH OIL, BATH POWDER, AND NON-MEDICATED BATH SALTS; PERFUME, COLOGNE, COSMETICS AND MAKEUP (U.S. CLS. 1, 4, 6, 50, 51 AND 52).

TAMARA FRAZIER, EXAMINING ATTORNEY

CLASS 3—(Continued).

SN 77-225,580. SHISEIDO COMPANY, LTD., TOKYO, JAPAN, FILED 7-10-2007.

REVITAL
LOTION EX

SHISEIDO

OWNER OF U.S. REG. NOS. 686,446, 3,216,053 AND OTHERS.

NO CLAIM IS MADE TO THE EXCLUSIVE RIGHT TO USE "LOTION", APART FROM THE MARK AS SHOWN.

THE FOREIGN WORDING IN THE MARK TRANSLATES INTO ENGLISH AS HEAVENLY.

FOR NON-MEDICATED SKIN CARE PREPARATIONS FOR THE FACE (U.S. CLS. 1, 4, 6, 50, 51 AND 52).

TAMARA FRAZIER, EXAMINING ATTORNEY

CLASS 3—(Continued).

SN 78-097,170. LABORATOIRES DE BIOLOGIE MARINE DANIEL JOUVANCE, CARNAC, FRANCE, FILED 12-7-2001.

VITALITE MARINE

OWNER OF FRANCE REG. NO. 1385912, DATED 12-24-1996, EXPIRES 12-24-2016.

NO CLAIM IS MADE TO THE EXCLUSIVE RIGHT TO USE "MARINE", APART FROM THE MARK AS SHOWN.

FOR MAKE-UP REMOVAL PRODUCTS, NAMELY CLEANSING MILK, LOTION, NON-GREASING LOTION; PRODUCTS FOR CLEANING AND REFRESHING THE EYES AND FACE, NAMELY AQUEOUS LOTION CONTAINING A POWDERED PHASE, CLEANSING LOTION CONTAINING WATER, TWO-PHASE LOTION COMPRISING OIL AND WATER, AND THREE-PHASE LOTION COMPRISING OIL, WATER AND A POWDERED COMPONENT; NON-MEDICATED SKIN CARE PREPARATIONS, NAMELY, CLEANSING FOAMING GEL, CLEANSING FOAM, MAKE-UP REMOVAL CREAM, EXFOLIATION TREATMENTS, EXFOLIATION MASKS, MAKE-UP REMOVING DISPOSABLE CLOTH, EYE MAKE-UP REMOVING LOTION; BEAUTY CARE PRODUCTS, NAMELY DAY CREAM, NIGHT CREAM, WATER-BASED LOTION, COMPLEXION CREAM, FACIAL OILS; CREAM, MILK, LOTION, MASKS, GEL, FLUID AND OIL FOR MOISTURIZING THE FACE, LIP BALM, SUNSCREEN CREAM, SKIN CREAM, SKIN SERUM, SPRAY LOTIONS, SKIN MOISTURIZING MASKS, ANTI-WRINKLE MASKS, NON-GREASING MASKS, SERUM FOR MOISTURIZING THE BODY, FACE AND EYES, LOTION SATURATED LINEN MASKS; BODY CARE PRODUCTS, NAMELY BODY MILK, BODY CREAM, BODY LOTION, ALL CONTAINING MARINE PRODUCTS (U.S. CLS. 1, 4, 6, 50, 51 AND 52).

REBECCA SMITH, EXAMINING ATTORNEY

SN 77-225,597. SHISEIDO COMPANY, LTD., TOKYO, JAPAN, FILED 7-10-2007.

REVITAL
MOISTURIZER EX

SHISEIDO

OWNER OF U.S. REG. NOS. 686,446, 3,216,053 AND OTHERS.

NO CLAIM IS MADE TO THE EXCLUSIVE RIGHT TO USE "MOISTURIZER", APART FROM THE MARK AS SHOWN.

THE FOREIGN WORDING IN THE MARK TRANSLATES INTO ENGLISH AS HEAVENLY.

FOR NON-MEDICATED SKIN CARE PREPARATIONS FOR THE FACE (U.S. CLS. 1, 4, 6, 50, 51 AND 52).

TAMARA FRAZIER, EXAMINING ATTORNEY

SN 78-606,619. POPPI'S PLACE PTY LTD., QUEENSLAND, AUSTRALIA, FILED 4-12-2005.

PLAY NOW

THE MARK CONSISTS OF STANDARD CHARACTERS WITHOUT CLAIM TO ANY PARTICULAR FONT, STYLE, SIZE, OR COLOR.

PRIORITY CLAIMED UNDER SEC. 44(D) ON AUSTRALIA APPLICATION NO. 1024918, FILED 10-14-2004, REG. NO. 1024918, DATED 8-20-2007, EXPIRES 10-14-2014.

FOR HAIR CARE PREPARATIONS FOR CLEANSING, CONDITIONING, STRENGTHENING, SHAPING, STRAIGHTENING, WAVING, CURLING, STYLING, SETTING, HOLDING, MOISTURIZING, TEXTURIZING, THICKENING, THINNING, RECONSTRUCTING, PERFUMING, COLORING, TINTING, BLEACHING AND REMOVING HAIR; NON-MEDICATED HAIR TREATMENT CREAM; FASHION AND EMBELLISHING PREPARATIONS AND PRODUCTS, NAMELY, COSMETICS; FACE AND SKIN CARE PRODUCTS AND PREPARATIONS, NAMELY, LOTIONS, CLEANSERS, TONERS, MOISTURIZERS AND EXFOLIATES; HAIR CARE PREPARATIONS FOR SHAPING, NAMELY, SHAPING BALMS FOR HOLDING, SCULPTING, MOLDING, TEXTURIZING, CHUNKING AND SPIKING HAIR; SUN PROTECTION, SUN TANNING AND SUNLESS TANNING PRODUCTS AND PREPARATIONS, NAMELY, SUN BLOCK, SUN BLOCK PREPARATIONS, SUN CARE LOTION (U.S. CLS. 1, 4, 6, 50, 51 AND 52).

KEVIN DINALLO, EXAMINING ATTORNEY

CLASS 3—(Continued).

SN 78-667,257. ENCHANTÉ ACCESSORIES INC., NEW YORK, NY. FILED 7-11-2005.

ALL ABOUT ME

THE MARK CONSISTS OF STANDARD CHARACTERS WITHOUT CLAIM TO ANY PARTICULAR FONT, STYLE, SIZE, OR COLOR.

FOR BODY LOTION, BUBBLE BATH, BAR SOAP, FACE AND HAND LOTION, BODY SPLASH AND BODY BUTTER (U.S. CLS. 1, 4, 6, 50, 51 AND 52).

FIRST USE 2-0-2003; IN COMMERCE 2-0-2003.
ELI HELLMAN, EXAMINING ATTORNEY

SN 78-716,756. STARMONY UNLIMITED, PLLC, HARMONY, FL. FILED 9-20-2005.

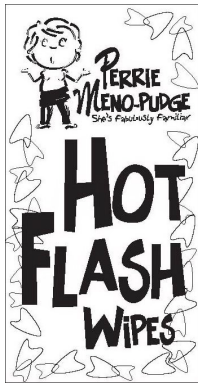

NO CLAIM IS MADE TO THE EXCLUSIVE RIGHT TO USE "WIPES", APART FROM THE MARK AS SHOWN. PERRIE MENO-PUDGE DOES NOT IDENTIFY A LIVING INDIVIDUAL.

FOR PRE-MOISTENED COSMETIC TOWELETTES (U.S. CLS. 1, 4, 6, 50, 51 AND 52).

ARETHA SOMERVILLE, EXAMINING ATTORNEY

SN 78-729,312. TISH & SNOOKY'S N.Y.C. INC., LONG ISLAND CITY, NY. FILED 10-7-2005.

HIGH VOLTAGE

THE MARK CONSISTS OF STANDARD CHARACTERS WITHOUT CLAIM TO ANY PARTICULAR FONT, STYLE, SIZE, OR COLOR.

FOR COSMETICS, BEAUTY PREPARATIONS AND HAIR CARE PREPARATIONS (U.S. CLS. 1, 4, 6, 50, 51 AND 52).

FIRST USE 9-1-2001; IN COMMERCE 9-1-2001.
MONIQUE MILLER, EXAMINING ATTORNEY

CLASS 3—(Continued).

SN 78-831,762. STYLE AND IMAGING, INC., SMYRNA, GA. FILED 3-7-2006.



NO CLAIM IS MADE TO THE EXCLUSIVE RIGHT TO USE "BEAUTY", APART FROM THE MARK AS SHOWN.

THE COLOR(S) FOREST GREEN IS/ARE CLAIMED AS A FEATURE OF THE MARK.

THE MARK CONSISTS OF A STYLIZED LEAF-LIKE "S" IN A CIRCLE WITH THE WORDS SOLENTY THE BALANCE OF BEAUTY UNDERNEATH AND THE MARK IS ENTIRELY A MARBELIZED FOREST GREEN IN COLOR.

FOR SKIN CARE AND HOLISTIC SKIN CARE PRODUCTS, NAMELY, FACIAL CLEANSER, FACIAL MOISTURIZER, UNDER EYE ENHANCER CREAM, FACIAL MASKS, FACIAL SCRUBS, BODY LOTION, LIP BALM, TONER FOR THE FACE, SHAMPOO, CONDITIONERS, SHOWER GELS, SKIN CREAM, TOOTH-PASTE, ANTI-PERSPIRANTS, ESSENTIAL OILS FOR PERSONAL USE, BODY SCRUBS, BODY SCRUBS, EYE MAKE-UP, EYE PENCILS, EYEBROW PENCILS, EYE LINER, FACE POWDER, FACIAL MAKE-UP, MASCARA, LIP CREAM, MAKE-UP, MAKE-UP REMOVER, SCENTED BODY SPRAY, SUN SCREEN, FRAGRANCE FOR AUTOMOBILES, BATH MILK, BATH SALT, BREATH FRESHENER, ANTI-AGING CREAM, PERFUME, NAIL POLISH, SOAPS FOR PERSONAL USE, BEAUTY SERUMS, BEAUTY LOTIONS (U.S. CLS. 1, 4, 6, 51 AND 52).

CURTIS FRENCH, EXAMINING ATTORNEY

SN 78-905,204. WOODIN, MARGERY M, MCALLEN, TX. FILED 6-9-2006.

Handies

THE MARK CONSISTS OF STANDARD CHARACTERS WITHOUT CLAIM TO ANY PARTICULAR FONT, STYLE, SIZE, OR COLOR.

FOR HAND CLEANERS (U.S. CLS. 1, 4, 6, 50, 51 AND 52).

PAMELA HIRSCHMAN, EXAMINING ATTORNEY

CLASS 3—(Continued).

SN 78-934,235. BEAUTY COSMEDICS, INC., HOUSTON, TX.
FILED 7-20-2006.

CLASS 3—(Continued).

SN 78-944,155. LANCOME PARFUMS ET BEAUTE & CIE,
PARIS, FRANCE, FILED 8-3-2006.

BRUSH2GO

THE MARK CONSISTS OF STANDARD CHARACTERS WITHOUT CLAIM TO ANY PARTICULAR FONT, STYLE, SIZE, OR COLOR.

FOR COSMETICS, NAMELY, MINERAL POWDER WHICH CAN BE USED AS A FOUNDATION, SUNSCREEN, CONCEALER, BRONZER, BLUSH AND POWDER (U.S. CLS. 1, 4, 6, 50, 51 AND 52).

FIRST USE 6-1-2006; IN COMMERCE 6-5-2006.

CHARLOTTE CORWIN, EXAMINING ATTORNEY

CUIR DE LANCOME

SN 78-939,437. NATURAL THOUGHTS, INC., SAN DIEGO,
CA. FILED 7-27-2006.

BIOSPA

THE MARK CONSISTS OF STANDARD CHARACTERS WITHOUT CLAIM TO ANY PARTICULAR FONT, STYLE, SIZE, OR COLOR.

OWNER OF U.S. REG. NO. 3,028,251.

FOR SKIN PREPARATIONS, NAMELY BODY OILS, BODY LOTIONS, AND BODY CREAMS; MASSAGE PREPARATIONS, NAMELY, BODY OILS, BODY LOTIONS, AND BODY CREAMS; ESSENTIAL OILS FOR PERSONAL USE; AND FRAGRANCES FOR PERSONAL USE (U.S. CLS. 1, 4, 6, 50, 51 AND 52).

TAMARA FRAZIER, EXAMINING ATTORNEY

THE MARK CONSISTS OF STANDARD CHARACTERS WITHOUT CLAIM TO ANY PARTICULAR FONT, STYLE, SIZE, OR COLOR.

OWNER OF FRANCE REG. NO. 5232798, DATED 8-1-2006, EXPIRES 8-1-2016.

OWNER OF ERPN CMNTY TM OFC REG. NO. 5232798, DATED 7-20-2007, EXPIRES 8-1-2016.

OWNER OF U.S. REG. NOS. 425,129, 1,608,742 AND OTHERS.

"THE FOREIGN WORDING IN THE MARK TRANSLATES INTO ENGLISH AS LEATHER OF."

FOR PERFUMERY PRODUCTS, NAMELY, PERFUMES, EAU DE COLOGNE, PERFUMED WATER, TOILET WATER, SKIN LOTIONS, SOAPS, BATH AND SHOWER FOAMING COMPOSITIONS AND GELS, DEODORANT FOR PERSONAL USE (U.S. CLS. 1, 4, 6, 50, 51 AND 52).

MATTHEW MCDOWELL, EXAMINING ATTORNEY

CLASS 3—(Continued).

SN 78-947,150. NATURA COSMÉTICOS S/A, ITAPECERICA DA SERRA, BRAZIL, FILED 8-8-2006.



OWNER OF U.S. REG. NO. 2,164,917.
NO CLAIM IS MADE TO THE EXCLUSIVE RIGHT TO USE "PLANT", APART FROM THE MARK AS SHOWN.

FOR COSMETICS; MAKEUP; FOUNDATION MAKE-UP; BODY AND FACE POWDER; EYEBROW SHADOW; EYEBROW COSMETICS; EYEBROW PENCILS; LIPSTICKS; LIP LINER; EYE LINER; SKIN LOTIONS; MASCARA; COSMETIC PENCILS; ADHESIVES FOR COSMETIC PURPOSES; LOTION FOR TONING AND FIRING THE SKIN; SKIN WHITENING CREAM; SUNSCREEN AND SUN-TANNING PREPARATIONS; HAIR POMADES FOR COSMETIC PURPOSES; PERMANENT WAVE PREPARATIONS; NAIL POLISH AND VARNISH; NAIL CARE PREPARATIONS; HAIR SPRAY AND HAIR STYLING PREPARATIONS; HAIR WAVING LOTIONS; TISSUES IMPREGNATED WITH COSMETIC LOTIONS; MAKE-UP REMOVING PREPARATIONS; BEAUTY MASKS; HAIR DYES; HAIR COLORANTS; COTTON STICKS, PUFFS AND SWABS FOR COSMETIC PURPOSES; CREAM FOR THE FACE; BODY MILKS; MOISTURIZING MILKS AND CREAMS; MILKS FOR COSMETIC PURPOSES; BATH SALTS, NOT FOR MEDICAL PURPOSES; HAIR BLEACH; HAIR COLOR REMOVER; CAKES OF TOILET SOAPS; FACIAL CLEANSERS AND TONERS; SKIN CLEANSERS AND TONERS; PERFUME; TOILET WATER; POTPOURRI; SCENTED WOOD FOR USE AS INCENSE; EAU DE COLOGNE; ANTIPERSPIRANTS; PERSONAL DEODORANTS; FRAGRANCES AND ESSENTIAL OILS FOR PERSONAL USE; SCENTED OILS TO PRODUCE AROMAS WHEN HEATED; BATH OIL; SOAP; SHAVING PREPARATIONS AND SHAVING SOAP; AFTER-SHAVE LOTIONS; SHAMPOOS; CONDITIONERS; MOUTH WASHES, NOT FOR MEDICAL PURPOSES; DENTIFRICES; DEPILATORIES AND DEPILATORY PREPARATIONS (U.S. CLS. 1, 4, 6, 50, 51 AND 52).
THOMAS MANOR, EXAMINING ATTORNEY

SN 78-947,397. L'OREAL, PARIS, FRANCE, FILED 8-8-2006.

DAILY FIT

THE MARK CONSISTS OF STANDARD CHARACTERS WITHOUT CLAIM TO ANY PARTICULAR FONT, STYLE, SIZE, OR COLOR.

PRIORITY CLAIMED UNDER SEC. 44(D) ON FRANCE APPLICATION NO. 063412985, FILED 2-28-2006, REG. NO. 063412985, DATED 2-28-2006, EXPIRES 2-28-2016.

FOR SHAMPOOS; GELS, SPRAYS, MOUSSES AND BALMS FOR HAIR STYLING AND HAIR CARE; HAIR LACQUERS; HAIR COLOURING AND HAIR DECOLORANT PREPARATIONS; PERMANENT WAVING AND CURLING PREPARATIONS (U.S. CLS. 1, 4, 6, 50, 51 AND 52).

SHAUNIA CARLYLE, EXAMINING ATTORNEY

CLASS 3—(Continued).

SN 78-954,706. GENEVA LABORATORIES LIMITED, AMSTERDAM, NETHERLANDS, FILED 8-17-2006.

PURCELLIN OIL

THE MARK CONSISTS OF STANDARD CHARACTERS WITHOUT CLAIM TO ANY PARTICULAR FONT, STYLE, SIZE, OR COLOR.

NO CLAIM IS MADE TO THE EXCLUSIVE RIGHT TO USE "OIL", APART FROM THE MARK AS SHOWN.

FOR CHEMICAL EMOLLIENT SOLD AS A COMPONENT INGREDIENT OF SKIN CARE PRODUCTS, NAMELY SKIN CREAMS, LOTIONS AND OILS (U.S. CLS. 1, 4, 6, 50, 51 AND 52).

FIRST USE 9-0-2003; IN COMMERCE 9-0-2003.
CHRISTINA SOBRAL, EXAMINING ATTORNEY

SN 78-955,724. SANRIO COMPANY, LTD., TOKYO, JAPAN, FILED 8-18-2006.

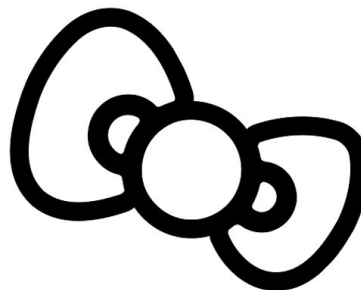

OWNER OF U.S. REG. NOS. 1,200,083, 1,370,105 AND OTHERS.

THE MARK CONSISTS OF A BOW.
FOR LIP GLOSS, LIP BALM, LIPSTICK, NAIL POLISH, NAIL TIPS, DECALS AND ORNAMENTS FOR NAILS; EMERY BOARDS; LIQUID SOAPS FOR FACE, HANDS AND BODY; BUBBLE BATH, SKIN LOTIONS, FACE AND BODY LOTIONS; BODY GLITTER; LIPSTICK CASES (U.S. CLS. 1, 4, 6, 50, 51 AND 52).

FIRST USE 11-1-2004; IN COMMERCE 11-1-2004.
REGINA DRUMMOND, EXAMINING ATTORNEY

SN 78-958,153. BROWNLEY FOX GROUP INC., NEW YORK, NY, FILED 8-22-2006.

JUBILEE

THE MARK CONSISTS OF STANDARD CHARACTERS WITHOUT CLAIM TO ANY PARTICULAR FONT, STYLE, SIZE, OR COLOR.

FOR PERFUME (U.S. CLS. 1, 4, 6, 50, 51 AND 52).
FIRST USE 8-15-2006; IN COMMERCE 8-15-2006.
KATHLEEN LORENZO, EXAMINING ATTORNEY

CLASS 3—(Continued).

SN 78-961,243. HARDAWAY, JENNIFER, NORTH HOLLYWOOD, CA. FILED 8-26-2006.



NO CLAIM IS MADE TO THE EXCLUSIVE RIGHT TO USE "CLEAN", APART FROM THE MARK AS SHOWN.

THE COLOR(S) GREEN IS/ARE CLAIMED AS A FEATURE OF THE MARK.

THE MARK CONSISTS OF THE COLOR GREEN APPEARS IN THE TERM "KLEAN" AND IN ITS REFLECTION.

FOR BODY AND BEAUTY CARE COSMETICS; BODY OILS; BODY SCRUB; BODY SPRAYS; FACE AND BODY CREAMS; FACE AND BODY GLITTER; FACE AND BODY LOTIONS; LIQUID SOAPS FOR HANDS, FACE AND BODY; LOTIONS FOR FACE AND BODY CARE; SCENTED BODY SPRAY (U.S. CLS. 1, 4, 6, 50, 51 AND 52).

LAURIE MAYES, EXAMINING ATTORNEY

SN 78-961,406. VICTORIA'S SECRET STORES BRAND MANAGEMENT, INC., REYNOLDSBURG, OH. FILED 8-28-2006.

BACIAMI

THE MARK CONSISTS OF STANDARD CHARACTERS WITHOUT CLAIM TO ANY PARTICULAR FONT, STYLE, SIZE, OR COLOR.

THE ENGLISH TRANSLATION OF THE WORD "BACIAMMI" IN THE MARK IS "KISS ME".

FOR PERSONAL CARE PRODUCTS, NAMELY, BODY WASH, SMOOTHING BODY SCRUB, WHIPPED BODY CREAM, BODY BUTTER, BODY LOTIONS, HAND CREAM, ASTRINGENT FOR THE FACE, ASTRINGENT FOR THE SKIN, BATH BEADS, BATH OIL, BATH SALTS, BLUSH, BODY GLITTER, BODY MIST, BODY OIL, BODY SCRUB, BODY WASH, BUBBLE BATH, COLOGNE, CREAM FOR THE BODY, CREAM FOR THE CUTICLES, CREAM FOR THE EYES, CREAM FOR THE FACE, CREAM FOR THE FEET, CREAM FOR THE HANDS, ESSENTIAL OILS FOR PERSONAL USE, EXFOLIATING PREPARATIONS FOR THE SKIN, EYE GELS, EYE MAKEUP PENCILS, EYE MASKS, EYE SHADOW, FACE HIGHLIGHTER, FACE MASKS, FACE MIST, FACE SCRUB, NON-MEDICATED FOOT SOAKS, FACE TONERS, FOUNDATION, FRAGRANT BODY SPLASH, FRAGRANT BODY MIST, HAIR CONDITIONER, HAIR HIGHLIGHTER, HAIR RINSES, HAIR SHAMPOO, HAIR SPRAY, HAIR STRAIGHTENING PREPARATIONS, HAIR STYLING GEL, HAIR STYLING MOUSSE, LOTION FOR THE BODY, LOTION FOR THE FACE, LOTION FOR THE FEET, LOTION FOR THE HANDS, LIP BALM, LIP GLOSS, LIP LINER, LIP MAKEUP PENCILS, LIPSTICK, MAKEUP FOR THE BODY, MAKEUP FOR THE FACE, MAKEUP REMOVER, MASCARA, MASSAGE CREAM, MASSAGE LOTION, MASSAGE OIL, NAIL POLISH, NAIL POLISH REMOVER, NAIL STENCILS, NON-MEDICATED BLEMISH STICK, NON-MEDICATED CLEANSER FOR THE FACE, NON-MEDICATED FOOT SPRAY, NON-MEDICATED MASSAGE OINTMENT, OIL BLOTting SHEETS FOR

CLASS 3—(Continued).

THE SKIN, PERFUME, POWDER FOR THE BODY, POWDER FOR THE FACE, POWDER FOR THE FEET, PUMICE STONES FOR PERSONAL USE, SALT SCRUBS FOR THE SKIN, SHAVING CREAM, SHAVING GELS, SHOWER CREAM, SHOWER GEL, SKIN BRONZING CREAM, SOAP FOR THE BODY, SOAP FOR THE FACE, SOAP FOR THE HANDS, SUN BLOCK FOR THE BODY, SUN BLOCK FOR THE FACE, SUNTAN LOTION FOR THE BODY, SUNTAN LOTION FOR THE FACE, SUNLESS TANNING LOTION FOR THE BODY, SUNLESS TANNING LOTION FOR THE FACE, PRE-SUNTANNING LOTION FOR THE BODY, PRE-SUNTANNING LOTION FOR THE FACE, POST-SUNTANNING LOTION FOR THE BODY, POST-SUNTANNING LOTION FOR THE FACE, TOILET SOAPS, HAIR SHAMPOOS, SCENTED DRAWER SACHETS; PERSONAL FRAGRANCES, NAMELY COLOGNE, PERFUME, TOILET WATER, AND ESSENTIAL OILS FOR PERSONAL USE; BATH POWDER, NON-MEDICATED FOOT POWDER, BODY POWDER; BATH, HAND AND BODY LOTIONS, HOME FRAGRANCES (U.S. CLS. 1, 4, 6, 50, 51 AND 52).

ALLISON SCHRODY, EXAMINING ATTORNEY

SN 78-961,414. VICTORIA'S SECRET STORES BRAND MANAGEMENT, INC., REYNOLDSBURG, OH. FILED 8-28-2006.

INCANTAMI

THE MARK CONSISTS OF STANDARD CHARACTERS WITHOUT CLAIM TO ANY PARTICULAR FONT, STYLE, SIZE, OR COLOR.

THE FOREIGN WORDING IN THE MARK TRANSLATES INTO ENGLISH AS "ENCHANT ME."

FOR PERSONAL CARE PRODUCTS NAMELY BODY WASH, SMOOTHING BODY SCRUB, WHIPPED BODY CREAM, BODY BUTTER, BODY LOTIONS, HAND CREAM, ASTRINGENT FOR THE FACE, ASTRINGENT FOR THE SKIN, BATH BEADS, BATH OIL, BATH SALTS, BLUSH, BODY GLITTER, BODY MIST, BODY OIL, BODY SCRUB, BODY WASH, BUBBLE BATH, COLOGNE, CREAM FOR THE BODY, CREAM FOR THE CUTICLES, CREAM FOR THE EYES, CREAM FOR THE FACE, CREAM FOR THE FEET, CREAM FOR THE HANDS, ESSENTIAL OILS FOR PERSONAL USE, EXFOLIATING PREPARATIONS FOR THE SKIN, EYE GELS, EYE MAKEUP PENCILS, EYE MASKS, EYE SHADOW, FACE HIGHLIGHTER, FACE MASKS, FACE MIST, FACE SCRUB, NON-MEDICATED FOOT SOAKS, FACE TONERS, FOUNDATION, FRAGRANT BODY SPLASH, FRAGRANT BODY MIST, HAIR CONDITIONER, HAIR HIGHLIGHTER, HAIR RINSES, HAIR SHAMPOO, HAIR SPRAY, HAIR STRAIGHTENING PREPARATIONS, HAIR STYLING GEL, HAIR STYLING MOUSSE, LOTION FOR THE BODY, LOTION FOR THE FACE, LOTION FOR THE FEET, LOTION FOR THE HANDS, LIP BALM, LIP GLOSS, LIP LINER, LIP MAKEUP PENCILS, LIPSTICK, MAKEUP FOR THE BODY, MAKEUP FOR THE FACE, MAKEUP REMOVER, MASCARA, MASSAGE CREAM, MASSAGE LOTION, MASSAGE OIL, NAIL POLISH, NAIL POLISH REMOVER, NAIL STENCILS, NON-MEDICATED BLEMISH STICK, NON-MEDICATED CLEANSER FOR THE FACE, NON-MEDICATED FOOT SPRAY, NON-MEDICATED MASSAGE OINTMENT, OIL BLOTting SHEETS FOR

CLASS 3—(Continued).

THE SKIN, PERFUME, POWDER FOR THE BODY, POWDER FOR THE FACE, POWDER FOR THE FEET, PUMICE STONES FOR PERSONAL USE, SALT SCRUBS FOR THE SKIN, SHAVING CREAM, SHAVING GELS, SHOWER CREAM, SHOWER GEL, SKIN BRONZING CREAM, SOAP FOR THE BODY, SOAP FOR THE FACE, SOAP FOR THE HANDS, SUN BLOCK FOR THE BODY, SUN BLOCK FOR THE FACE, SUNTAN LOTION FOR THE BODY, SUNTAN LOTION FOR THE FACE, SUNLESS TANNING LOTION FOR THE BODY, SUNLESS TANNING LOTION FOR THE FACE, PRE-SUNTANNING LOTION FOR THE BODY, PRE-SUNTANNING LOTION FOR THE FACE, POST-SUNTANNING LOTION FOR THE BODY, POST-SUNTANNING LOTION FOR THE FACE, TOILET SOAPS, HAIR SHAMPOOS, SCENTED DRAWER SACHETS; PERSONAL FRAGRANCES, NAMELY COLOGNE, PERFUME, TOILET WATER, AND ESSENTIAL OILS FOR PERSONAL USE; BATH POWDER, NON-MEDICATED FOOT POWDER, BODY POWDER; BATH, HAND AND BODY LOTIONS, HOME FRAGRANCES (U.S. CLS. 1, 4, 6, 50, 51 AND 52).
JOHN SCHUYLER YARD, EXAMINING ATTORNEY

CLASS 3—(Continued).

THE SKIN, PERFUME, POWDER FOR THE BODY, POWDER FOR THE FACE, POWDER FOR THE FEET, PUMICE STONES FOR PERSONAL USE, SALT SCRUBS FOR THE SKIN, SHAVING CREAM, SHAVING GELS, SHOWER CREAM, SHOWER GEL, SKIN BRONZING CREAM, SOAP FOR THE BODY, SOAP FOR THE FACE, SOAP FOR THE HANDS, SUN BLOCK FOR THE BODY, SUN BLOCK FOR THE FACE, SUNTAN LOTION FOR THE BODY, SUNTAN LOTION FOR THE FACE, SUNLESS TANNING LOTION FOR THE BODY, SUNLESS TANNING LOTION FOR THE FACE, PRE-SUNTANNING LOTION FOR THE BODY, PRE-SUNTANNING LOTION FOR THE FACE, POST-SUNTANNING LOTION FOR THE BODY, POST-SUNTANNING LOTION FOR THE FACE, TOILET SOAPS, HAIR SHAMPOOS, SCENTED DRAWER SACHETS; PERSONAL FRAGRANCES, NAMELY COLOGNE, PERFUME, TOILET WATER, AND ESSENTIAL OILS FOR PERSONAL USE; BATH POWDER, NON-MEDICATED FOOT POWDER, BODY POWDER; BATH, HAND AND BODY LOTIONS, HOME FRAGRANCES (U.S. CLS. 1, 4, 6, 50, 51 AND 52).
KATHERINE CHANG, EXAMINING ATTORNEY

SN 78-961,415. VICTORIA'S SECRET STORES BRAND MANAGEMENT, INC., REYNOLDSBURG, OH. FILED 8-28-2006.

SN 78-969,639. DO-BEST, INC., TOKYO 113-0024, JAPAN, FILED 9-7-2006.

SEDUCIMI

THE MARK CONSISTS OF STANDARD CHARACTERS WITHOUT CLAIM TO ANY PARTICULAR FONT, STYLE, SIZE, OR COLOR.

THE FOREIGN WORDING IN THE MARK TRANSLATES INTO ENGLISH AS "SEDUCE ME."

FOR PERSONAL CARE PRODUCTS NAMELY BODY WASH, SMOOTHING BODY SCRUB, WHIPPED BODY CREAM, BODY BUTTER, BODY LOTIONS, HAND CREAM, ASTRINGENT FOR THE FACE, ASTRINGENT FOR THE SKIN, BATH BEADS, BATH OIL, BATH SALTS, BLUSH, BODY GLITTER, BODY MIST, BODY OIL, BODY SCRUB, BODY WASH, BUBBLE BATH, COLOGNE, CREAM FOR THE BODY, CREAM FOR THE CUTICLES, CREAM FOR THE EYES, CREAM FOR THE FACE, CREAM FOR THE FEET, CREAM FOR THE HANDS, ESSENTIAL OILS FOR PERSONAL USE, EXFOLIATING PREPARATIONS FOR THE SKIN, EYE GELS, EYE MAKEUP PENCILS, EYE MASKS, EYE SHADOW, FACE HIGHLIGHTER, FACE MASKS, FACE MIST, FACE SCRUB, NON-MEDICATED FOOT SOAKS, FACE TONERS, FOUNDATION, FRAGRANT BODY SPLASH, FRAGRANT BODY MIST, HAIR CONDITIONER, HAIR HIGHLIGHTER, HAIR RINSES, HAIR SHAMPOO, HAIR SPRAY, HAIR STRAIGHTENING PREPARATIONS, HAIR STYLING GEL, HAIR STYLING MOUSSE, LOTION FOR THE BODY, LOTION FOR THE FACE, LOTION FOR THE FEET, LOTION FOR THE HANDS, LIP BALM, LIP GLOSS, LIP LINER, LIP MAKEUP PENCILS, LIPSTICK, MAKEUP FOR THE BODY, MAKEUP FOR THE FACE, MAKEUP REMOVER, MASCARA, MASSAGE CREAM, MASSAGE LOTION, MASSAGE OIL, NAIL POLISH, NAIL POLISH REMOVER, NAIL STENCILS, NON-MEDICATED BLEMISH STICK, NON-MEDICATED CLEANSER FOR THE FACE, NON-MEDICATED FOOT SPRAY, NON-MEDICATED MASSAGE OINTMENT, OIL BLOTTING SHEETS FOR

LOUJENE

THE MARK CONSISTS OF STANDARD CHARACTERS WITHOUT CLAIM TO ANY PARTICULAR FONT, STYLE, SIZE, OR COLOR.

OWNER OF JAPAN REG. NO. 2,262,552, DATED 9-21-1990, EXPIRES 9-21-2010.

FOR COSMETICS (U.S. CLS. 1, 4, 6, 50, 51 AND 52).
JEFF DEFORD, EXAMINING ATTORNEY

SN 78-969,642. DO-BEST, INC., TOKYO 113-0024, JAPAN, FILED 9-8-2006.

FIORI

THE MARK CONSISTS OF STANDARD CHARACTERS WITHOUT CLAIM TO ANY PARTICULAR FONT, STYLE, SIZE, OR COLOR.

OWNER OF JAPAN REG. NO. 2,357,463, DATED 11-29-1991, EXPIRES 11-29-2011.

"THE FOREIGN WORDING IN THE MARK TRANSLATES INTO ENGLISH AS FLOWERS."

FOR COSMETICS (U.S. CLS. 1, 4, 6, 50, 51 AND 52).
JEFF DEFORD, EXAMINING ATTORNEY

CLASS 3—(Continued).

SN 78-972,848. MARIN DERMATOLOGY ASSOCIATES, SAN RAFAEL, CA. FILED 9-12-2006.

Berry-Defense

THE MARK CONSISTS OF STANDARD CHARACTERS WITHOUT CLAIM TO ANY PARTICULAR FONT, STYLE, SIZE, OR COLOR.

FOR COSMETICS AND SKIN CARE PREPARATIONS, NAMELY, FACE, HAND AND BODY SOAPS, CLEANSERS AND MOISTURIZERS; HAIR SHAMPOOS AND CONDITIONERS (U.S. CLS. 1, 4, 6, 50, 51 AND 52).
KATHY DE JONGE, EXAMINING ATTORNEY

SN 78-973,535. LABORATOIRE GARNIER & CIE, PARIS, FRANCE, FILED 9-13-2006.

BOLD IT

THE MARK CONSISTS OF STANDARD CHARACTERS WITHOUT CLAIM TO ANY PARTICULAR FONT, STYLE, SIZE, OR COLOR.

FOR SHAMPOOS; GELS, SPRAYS, MOUSSES AND BALMS FOR HAIR STYLING AND HAIR CARE; HAIR LACQUERS; HAIR COLOURING AND HAIR DECOLORANT PREPARATION; PERMANENT WAVING AND CURLING PREPARATIONS; ESSENTIAL OILS FOR PERSONAL USE (U.S. CLS. 1, 4, 6, 50, 51 AND 52).
NANCY CLARKE, EXAMINING ATTORNEY

SN 78-978,778. ANGELA TADLOCK, WASHINGTON, WV. FILED 1-10-2006.

HUNTRESS

THE MARK CONSISTS OF STANDARD CHARACTERS WITHOUT CLAIM TO ANY PARTICULAR FONT, STYLE, SIZE, OR COLOR.

FOR COSMETICS AND COSMETIC PREPARATIONS FOR SKIN AND BODY CARE (U.S. CLS. 1, 4, 6, 50, 51 AND 52).
JANICE KIM, EXAMINING ATTORNEY

CLASS 3—(Continued).

SN 79-031,310. RECKITT BENCKISER N.V., NETHERLANDS, FILED 5-16-2006.

MINITABLETINOS

OWNER OF INTERNATIONAL REGISTRATION 0904510 DATED 5-16-2006, EXPIRES 5-16-2016.

FOR BLEACHING PREPARATIONS FOR LAUNDRY USE AND OTHER SUBSTANCES FOR LAUNDRY USE, NAMELY, LAUNDRY DETERGENT, LAUNDRY SOAPS, FABRIC SOFTENERS, AND STAIN REMOVERS; SUBSTANCES FOR DISHWASHING, NAMELY, DISHWASHING DETERGENTS; RINSE AGENTS FOR AUTOMATIC DISHWASHERS; CLEANERS, FRESHENERS AND DEODORIZERS FOR MACHINE DISHWASHERS; LAUNDRY PREPARATIONS FOR DRY CLEANERS, NAMELY, DRY CLEANING FLUIDS, DRY CLEANING SOLVENTS AND SPOT REMOVERS; DISHWASHER CLEANER, NAMELY, DISHWASHING DETERGENTS AND DETERGENTS FOR MACHINE DISHWASHING; POLISHING PREPARATIONS FOR KITCHEN AND GLASSWARE; GENERAL PURPOSE CLEANING, POLISHING, SCOURING AND ABRASIVE PREPARATIONS, NAMELY, LIQUIDS, POWDERS, CREAMS AND GELS; CLEANERS AND SHAMPOOS FOR CARPETS; SOAPS, NAMELY, DETERGENT SOAPS; DECALCIFYING AND DESCALING PREPARATIONS FOR DOMESTIC USE, NAMELY, FOR HOUSEHOLD CLEANING PURPOSES; FABRIC SOFTENERS; ALL AFOREMENTIONED GOODS WITH AND WITHOUT A DISINFECTIVE COMPONENT (U.S. CLS. 1, 4, 6, 50, 51 AND 52).

MEGAN WHITNEY, EXAMINING ATTORNEY

SN 79-034,125. PARFUMS CHRISTIAN DIOR, FRANCE, FILED 10-31-2006.

LA COLLECTION PARTICULIERE

PRIORITY DATE OF 5-3-2006 IS CLAIMED.

OWNER OF INTERNATIONAL REGISTRATION 0912115 DATED 10-31-2006, EXPIRES 10-31-2016.

NO CLAIM IS MADE TO THE EXCLUSIVE RIGHT TO USE "COLLECTION", APART FROM THE MARK AS SHOWN.

THE ENGLISH TRANSLATION OF THE WORD "LA" AND "PARTICULIERE" IN THE MARK IS "THE" AND "PARTICULAR".

FOR PERFUMERY PRODUCTS, NAMELY PERFUMERY; PERFUMES, EAUX DE TOILETTE, EAU DE COLOGNE (U.S. CLS. 1, 4, 6, 50, 51 AND 52).

RUDY R. SINGLETON, EXAMINING ATTORNEY

CLASS 4—LUBRICANTS AND FUELS

SN 77-066,468. SYNTROLEUM CORPORATION, TULSA, OK.
FILED 12-18-2006.

BIOFINING

THE MARK CONSISTS OF STANDARD CHARACTERS WITHOUT CLAIM TO ANY PARTICULAR FONT, STYLE, SIZE, OR COLOR.

FOR FUELS AND AROMATICS PRODUCED FROM BIOMASS AND/OR RENEWABLE FEEDSTOCKS, NAMELY, ISO-PARAFFINIC KEROSENE, NAPHTHA, AVIATION FUELS, DIESEL FUELS, FUEL CELL FUELS, HEATING FUELS, MOTOR VEHICLE FUELS, AND LIQUID PROPANE GASES; PARAFFINS, NAMELY, ISO-PARAFFINS, NORMAL PARAFFINS, MIXED PARAFFINS (U.S. CLS. 1, 6 AND 15).

MATTHEW EINSTEIN, EXAMINING ATTORNEY

SN 77-154,978. AMERICAN WAY MARKETING LLC, ELKHART, IN. FILED 4-12-2007.

SUPERSLICK

THE MARK CONSISTS OF STANDARD CHARACTERS WITHOUT CLAIM TO ANY PARTICULAR FONT, STYLE, SIZE, OR COLOR.

FOR LUBRICATING GREASES (U.S. CLS. 1, 6 AND 15).

FIRST USE 2-1-2004; IN COMMERCE 2-1-2004.
MARLENE BELL, EXAMINING ATTORNEY

SN 77-158,948. TUNA PROCESSORS, INC., TEMECULA, CA.
FILED 4-17-2007.

CLEANSMOKE

THE MARK CONSISTS OF STANDARD CHARACTERS WITHOUT CLAIM TO ANY PARTICULAR FONT, STYLE, SIZE, OR COLOR.

FOR GAS WITH A PRIMARY ACTIVE INGREDIENT OF CARBON MONOXIDE FOR USE IN TREATING MEAT FOR COLOR RETENTION (U.S. CLS. 1, 6 AND 15).

ELLEN B. AWRICH, EXAMINING ATTORNEY

CLASS 4—(Continued).

SN 77-160,642. CANDLES WITH A TWIST, LLC, NITRO, WV.
FILED 4-19-2007.



THE COLOR(S) BLUE-GRAY (PMS 279), ORANGE (PMS 144), YELLOW (PMS 102), GOLD (PMS 123), BLACK, WHITE, AND GRAY IS/ARE CLAIMED AS A FEATURE OF THE MARK.

THE MARK CONSISTS OF A BACKGROUND DESIGN OF AN ORANGE QUADRILATERAL AND BLUE-GRAY QUADRILATERAL PARTIALLY OVERLAPPING TO PRODUCE A GOLD REGION, UPON WHICH IS IMPOSED A DESIGN OF A BLACK AND GRAY CANDLEHOLDER CONTAINING A BURNING WHITE CANDLE PRODUCING AN ORANGE FLAME, YELLOW CIRCLE OF ILLUMINATION, AND 5 GOLD TRIANGLES UPON THE BLUE-GRAY QUADRILATERAL SUGGESTING THAT THE LIGHT IS MOVING FORWARD.

FOR CANDLES (U.S. CLS. 1, 6 AND 15).
FIRST USE 7-1-1994; IN COMMERCE 7-1-1994.
ELI HELLMAN, EXAMINING ATTORNEY

SN 77-168,579. LE BRETON, CRAIG, BRISBANE, AUSTRALIA, FILED 4-29-2007.

C-CUT LUBE

THE MARK CONSISTS OF STANDARD CHARACTERS WITHOUT CLAIM TO ANY PARTICULAR FONT, STYLE, SIZE, OR COLOR.

PRIORITY CLAIMED UNDER SEC. 44(D) ON AUSTRALIA APPLICATION NO. 1143795, FILED 10-31-2006, REG. NO. 1143795, DATED 10-31-2006, EXPIRES 10-31-2016.

NO CLAIM IS MADE TO THE EXCLUSIVE RIGHT TO USE "LUBE", APART FROM THE MARK AS SHOWN.

FOR ALL PURPOSE LUBRICANTS; INDUSTRIAL LUBRICANTS; LUBRICANTS FOR INDUSTRIAL MACHINERY (U.S. CLS. 1, 6 AND 15).

ADA HAN, EXAMINING ATTORNEY

CLASS 4—(Continued).

SN 77-181,006. CHOPRA ENTERPRISES, LLC, CARLSBAD, CA. FILED 5-15-2007.

CHOPRA CENTER

THE MARK CONSISTS OF STANDARD CHARACTERS WITHOUT CLAIM TO ANY PARTICULAR FONT, STYLE, SIZE, OR COLOR.

OWNER OF U.S. REG. NOS. 2,202,591, 2,215,788 AND 3,173,576.

FOR CANDLES; SCENTED CANDLES (U.S. CLS. 1, 6 AND 15).

LANA PHAM, EXAMINING ATTORNEY

SN 78-821,552. CHEVRON INTELLECTUAL PROPERTY INC., SAN RAMON, CA. FILED 2-23-2006.

PRECISION FUELS

THE MARK CONSISTS OF STANDARD CHARACTERS WITHOUT CLAIM TO ANY PARTICULAR FONT, STYLE, SIZE, OR COLOR.

NO CLAIM IS MADE TO THE EXCLUSIVE RIGHT TO USE "FUELS", APART FROM THE MARK AS SHOWN.

FOR FUEL FOR MOTOR VEHICLES, NAMELY, GASOLINE (U.S. CLS. 1, 6 AND 15).

BRENDAN MCCAULEY, EXAMINING ATTORNEY

CLASS 5—PHARMACEUTICALS

SN 76-577,739. INNOVATICS LABORATORIES, INC., NEW YORK, NY. FILED 2-24-2004.

VALERIANX

THE MARK CONSISTS OF STANDARD CHARACTERS WITHOUT CLAIM TO ANY PARTICULAR FONT, STYLE, SIZE, OR COLOR.

FOR VITAMINS, DIETARY AND NUTRITIONAL SUPPLEMENTS (U.S. CLS. 6, 18, 44, 46, 51 AND 52).

BILL DAWE, EXAMINING ATTORNEY

CLASS 5—(Continued).

SN 76-664,492. MCNEIL NUTRITIONALS, LLC, FORT WASHINGTON, PA. FILED 8-11-2006.

BERRY BREEZE

THE MARK CONSISTS OF STANDARD CHARACTERS WITHOUT CLAIM TO ANY PARTICULAR FONT, STYLE, SIZE, OR COLOR.

NO CLAIM IS MADE TO THE EXCLUSIVE RIGHT TO USE "BERRY", APART FROM THE MARK AS SHOWN.

FOR VITAMINS AND DIETARY SUPPLEMENTS (U.S. CLS. 6, 18, 44, 46, 51 AND 52).

ELISSA GARBER KON, EXAMINING ATTORNEY

SN 76-675,518. ALTAWOOD, UPLAND, CA. FILED 4-16-2007.

TIME-OUT TERMITES, ROACHES & ANTS

NO CLAIM IS MADE TO THE EXCLUSIVE RIGHT TO USE TERMITES, ROACHES & ANTS, APART FROM THE MARK AS SHOWN.

FOR TERMITICIDES AND INSECTICIDES FOR DOMESTIC AND COMMERCIAL USE (U.S. CLS. 6, 18, 44, 46, 51 AND 52).

ELLEN B. AWRICH, EXAMINING ATTORNEY

SN 76-675,533. NEWTON-EVERETT, LLC, SCOTTSDALE, AZ. FILED 4-16-2007.

CREADRENE

THE MARK CONSISTS OF STANDARD CHARACTERS WITHOUT CLAIM TO ANY PARTICULAR FONT, STYLE, SIZE, OR COLOR.

FOR DIETARY SUPPLEMENTS, NAMELY A TRI-PHASE CREATINE SUPPLEMENT (U.S. CLS. 6, 18, 44, 46, 51 AND 52).

FIRST USE 1-1-2007; IN COMMERCE 1-1-2007.

DAVID H. STINE, EXAMINING ATTORNEY

SN 76-675,590. SANTAL SOLUTIONS LLC, APPLETON, WI. FILED 4-17-2007.

AYURVEDIC SOLUTIONS FOR MODERN WORLD

THE MARK CONSISTS OF STANDARD CHARACTERS WITHOUT CLAIM TO ANY PARTICULAR FONT, STYLE, SIZE, OR COLOR.

NO CLAIM IS MADE TO THE EXCLUSIVE RIGHT TO USE "AYURVEDIC SOLUTIONS", APART FROM THE MARK AS SHOWN.

FOR DIETARY SUPPLEMENTS (U.S. CLS. 6, 18, 44, 46, 51 AND 52).

SANI KHOURI, EXAMINING ATTORNEY

CLASS 5—(Continued).

SN 76-675,764. REACTIVE SURFACES, LTD., AUSTIN, TX.
FILED 4-20-2007.

PROTECOAT

THE MARK CONSISTS OF STANDARD CHARACTERS WITHOUT CLAIM TO ANY PARTICULAR FONT, STYLE, SIZE, OR COLOR.

FOR ANTI-MICROBIAL ADDITIVE FOR USE IN COATINGS (U.S. CLS. 6, 18, 44, 46, 51 AND 52).

FIRST USE 12-15-2005; IN COMMERCE 12-15-2005.

NORA BUCHANAN WILL, EXAMINING ATTORNEY

SN 77-000,535. BRISBOIS, STEVEN, GOTHA, FL. FILED 9-15-2006.

18 AGAIN

THE MARK CONSISTS OF STANDARD CHARACTERS WITHOUT CLAIM TO ANY PARTICULAR FONT, STYLE, SIZE, OR COLOR.

FOR DIETARY AND NUTRITIONAL SUPPLEMENTS; DIETARY FOOD SUPPLEMENTS; DIETARY SUPPLEMENTS; HERBAL SUPPLEMENTS; MINERAL NUTRITIONAL SUPPLEMENTS; MINERAL SUPPLEMENTS; NUTRITIONAL ADDITIVES FOR USE IN FOODS AND DIETARY SUPPLEMENTS FOR HUMAN CONSUMPTION; NUTRITIONAL SUPPLEMENTS; VITAMIN AND MINERAL SUPPLEMENTS; VITAMIN SUPPLEMENTS (U.S. CLS. 6, 18, 44, 46, 51 AND 52).

WENDY GOODMAN, EXAMINING ATTORNEY

SN 77-002,477. REMARKABLE DENTAL PRODUCTS INC., RICHMOND HILL, CANADA, FILED 9-19-2006.

REMARKABLE DENTAL PRODUCTS

THE MARK CONSISTS OF STANDARD CHARACTERS WITHOUT CLAIM TO ANY PARTICULAR FONT, STYLE, SIZE, OR COLOR.

NO CLAIM IS MADE TO THE EXCLUSIVE RIGHT TO USE "DENTAL PRODUCTS", APART FROM THE MARK AS SHOWN.

FOR DENTAL PRODUCTS, NAMELY ADHESIVES, IMPRESSION MATERIALS, DESENSITIZING AGENTS FOR USE ON TEETH AND GUMS, COMPOSITE MATERIALS, BONDING AGENTS, SILICONE-BASED REGISTRATION BITE MATERIALS AND RESTORATIVE COMPOUNDS (U.S. CLS. 6, 18, 44, 46, 51 AND 52).

DAVID HOFFMAN, EXAMINING ATTORNEY

CLASS 5—(Continued).

SN 77-002,541. REMARKABLE DENTAL PRODUCTS INC., RICHMOND HILL, CANADA, FILED 9-19-2006.

MAX DESENSITIZER

THE MARK CONSISTS OF STANDARD CHARACTERS WITHOUT CLAIM TO ANY PARTICULAR FONT, STYLE, SIZE, OR COLOR.

NO CLAIM IS MADE TO THE EXCLUSIVE RIGHT TO USE "DESENSITIZER", APART FROM THE MARK AS SHOWN.

FOR DENTAL PRODUCTS, NAMELY, DESENSITIZING AGENTS (U.S. CLS. 6, 18, 44, 46, 51 AND 52).

DAVID HOFFMAN, EXAMINING ATTORNEY

SN 77-007,196. TAITONG AH CO. PTE. LTD., SINGAPORE, SINGAPORE, FILED 9-26-2006.



NO CLAIM IS MADE TO THE EXCLUSIVE RIGHT TO USE THE NON-LATIN CHARACTER TRANSLITERATING TO "YO" WHICH MEANS "LINIMENT", APART FROM THE MARK AS SHOWN.

THE COLOR(S) RED AND WHITE IS/ARE CLAIMED AS A FEATURE OF THE MARK.

THE MARK CONSISTS OF THE COLOR RED APPEARS AS THE BACKGROUND, AND COLOR WHITE APPEARS AS THE CHINESE CHARACTERS.

THE FOREIGN WORDING IN THE MARK TRANSLATES INTO ENGLISH AS DOUBLE-PRAWN RUMAGON LINIMENT.

THE NON-LATIN CHARACTER(S) IN THE MARK TRANSLITERATES INTO "TSOUN SHAY FONG SHI YOU", AND THIS MEANS DOUBLE-PRAWN RUMAGON LINIMENT IN ENGLISH.

FOR PAIN RELIEF MEDICATION (U.S. CLS. 6, 18, 44, 46, 51 AND 52).

FIRST USE 2-23-2004; IN COMMERCE 2-23-2004.

MARY MUNSON, EXAMINING ATTORNEY

CLASS 5—(Continued).

SN 77-014,364. KENT FEEDS, INC., MUSCATINE, IA. FILED 10-5-2006.

Easy Cover 100

THE MARK CONSISTS OF STANDARD CHARACTERS WITHOUT CLAIM TO ANY PARTICULAR FONT, STYLE, SIZE, OR COLOR.

NO CLAIM IS MADE TO THE EXCLUSIVE RIGHT TO USE "COVER", APART FROM THE MARK AS SHOWN.

FOR LIVESTOCK FEED SUPPLEMENTS (U.S. CLS. 6, 18, 44, 46, 51 AND 52).

EVELYN BRADLEY, EXAMINING ATTORNEY

SN 77-029,457. FARON PHARMACEUTICALS OY, FI-20520 TURKÚ, FINLAND, FILED 10-25-2006.

FARBETIC

THE MARK CONSISTS OF STANDARD CHARACTERS WITHOUT CLAIM TO ANY PARTICULAR FONT, STYLE, SIZE, OR COLOR.

PRIORITY CLAIMED UNDER SEC. 44(D) ON ERP CMNTY TM OFC APPLICATION NO. 005097043, FILED 5-5-2006, REG. NO. 005097043, DATED 5-21-2007, EXPIRES 5-5-2016.

FOR PHARMACEUTICAL PREPARATIONS, NAMELY, PRESCRIPTION DRUGS FOR THE TREATMENT OR PREVENTION OF METABOLIC DISORDERS OR THEIR COMPLICATIONS (U.S. CLS. 6, 18, 44, 46, 51 AND 52).

LAURIE MAYES, EXAMINING ATTORNEY

SN 77-031,533. SKIN HEALZ HERBAL INC., RICHMOND BC, CANADA, FILED 10-27-2006.

FPQ

THE MARK CONSISTS OF STANDARD CHARACTERS WITHOUT CLAIM TO ANY PARTICULAR FONT, STYLE, SIZE, OR COLOR.

FOR DIETARY SUPPLEMENTS; HERBAL SUPPLEMENTS; MEDICINAL CREAMS, LIQUIDS AND OILS FOR SKIN CARE (U.S. CLS. 6, 18, 44, 46, 51 AND 52).

FIRST USE 2-1-2006; IN COMMERCE 8-13-2006.

WILLIAM BRECKENFELD, EXAMINING ATTORNEY

CLASS 5—(Continued).

SN 77-036,572. ALIGN TECHNOLOGY, INC., SANTA CLARA, CA. FILED 11-3-2006.

IMPRESTO

THE MARK CONSISTS OF STANDARD CHARACTERS WITHOUT CLAIM TO ANY PARTICULAR FONT, STYLE, SIZE, OR COLOR.

FOR MATERIALS FOR MAKING DENTAL IMPRESSIONS; KITS CONTAINING ALGINATE FOR USE IN MAKING DENTAL IMPRESSIONS (U.S. CLS. 6, 18, 44, 46, 51 AND 52).

DANIEL RUSSELL, EXAMINING ATTORNEY

SN 77-070,094. BRISTOL-MYERS SQUIBB COMPANY, NEW YORK, NY. FILED 12-22-2006.

NEXTUBIN

THE MARK CONSISTS OF STANDARD CHARACTERS WITHOUT CLAIM TO ANY PARTICULAR FONT, STYLE, SIZE, OR COLOR.

FOR PHARMACEUTICAL PREPARATIONS FOR HUMAN USE FOR THE TREATMENT AND PREVENTION OF OBESITY, DIABETES, INCONTINENCE, CARDIOVASCULAR DISEASES, CENTRAL NERVOUS SYSTEM DISEASES AND DISORDERS, METABOLIC DISORDERS, STROKE, CANCER, INFLAMMATION AND INFLAMMATORY DISEASES, RESPIRATORY AND INFECTIOUS DISEASES, AUTO-IMMUNE DISEASES, SOLID ORGAN TRANSPLANT REJECTION; PHARMACEUTICAL PREPARATIONS FOR HUMAN USE, NAMELY, ANTIBIOTICS, ANTI-FUNGALS, ANTI-VIRALS, IMMUNOSUPPRESSANTS AND PHARMACEUTICAL ANTIBODIES (U.S. CLS. 6, 18, 44, 46, 51 AND 52).

ELLEN PERKINS, EXAMINING ATTORNEY

SN 77-072,512. TAKEDA PHARMACEUTICAL COMPANY LIMITED, CHUO-KU, OSAKA, JAPAN, FILED 12-28-2006.

ENECLAT

THE MARK CONSISTS OF STANDARD CHARACTERS WITHOUT CLAIM TO ANY PARTICULAR FONT, STYLE, SIZE, OR COLOR.

PRIORITY CLAIMED UNDER SEC. 44(D) ON JAPAN APPLICATION NO. 2006-080186, FILED 8-29-2006, REG. NO. 5030455, DATED 3-2-2007, EXPIRES 3-2-2017.

FOR PHARMACEUTICAL PREPARATIONS FOR HUMAN USE FOR THE TREATMENT OF CARDIOVASCULAR CONDITIONS AND DISEASES (U.S. CLS. 6, 18, 44, 46, 51 AND 52).

LESLIE RICHARDS, EXAMINING ATTORNEY

CLASS 5—(Continued).

SN 77-074,348. HELENA HOLDING COMPANY, WILMINGTON, DE. FILED 1-2-2007.

FIRST DEFENSE

THE MARK CONSISTS OF STANDARD CHARACTERS WITHOUT CLAIM TO ANY PARTICULAR FONT, STYLE, SIZE, OR COLOR.

FOR SEED TREATMENT PESTICIDES FOR USE IN THE AGRICULTURAL INDUSTRY (U.S. CLS. 6, 18, 44, 46, 51 AND 52).

DAWN FELDMAN, EXAMINING ATTORNEY

SN 77-092,078. FICKLE, MARK E., BUENA VISTA, CO. FILED 1-26-2007.

FIELD DRESSER'S ODOR-EEZE

THE MARK CONSISTS OF STANDARD CHARACTERS WITHOUT CLAIM TO ANY PARTICULAR FONT, STYLE, SIZE, OR COLOR.

FOR TOPICALLY APPLIED ODOR NEUTRALIZING PREPARATION APPLIED UNDER THE NOSE FOR ODOR RELIEF (U.S. CLS. 6, 18, 44, 46, 51 AND 52).

KIMBERLY PERRY, EXAMINING ATTORNEY

SN 77-102,795. ENTURIA, INC., LEAWOOD, KS. FILED 2-8-2007.

HI-LITE ORANGE

THE MARK CONSISTS OF STANDARD CHARACTERS WITHOUT CLAIM TO ANY PARTICULAR FONT, STYLE, SIZE, OR COLOR.

NO CLAIM IS MADE TO THE EXCLUSIVE RIGHT TO USE "ORANGE", APART FROM THE MARK AS SHOWN.

FOR MEDICAL LIQUID APPLICATORS CONTAINING ANTIMICROBIAL SOLUTION AND USED FOR APPLYING ANTIMICROBIAL SOLUTION (U.S. CLS. 6, 18, 44, 46, 51 AND 52).

FIRST USE 8-17-2006; IN COMMERCE 8-17-2006.

DAVID MILLER, EXAMINING ATTORNEY

CLASS 5—(Continued).

SN 77-113,245. PREMIER LABS, INC., TEMECULA, CA. FILED 2-22-2007.

PREMIER LABS

THE MARK CONSISTS OF STANDARD CHARACTERS WITHOUT CLAIM TO ANY PARTICULAR FONT, STYLE, SIZE, OR COLOR.

NO CLAIM IS MADE TO THE EXCLUSIVE RIGHT TO USE "LABS", APART FROM THE MARK AS SHOWN.

FOR NUTRITIONAL SUPPLEMENTS (U.S. CLS. 6, 18, 44, 46, 51 AND 52).

FIRST USE 12-31-1991; IN COMMERCE 12-31-1991.

NORA BUCHANAN WILL, EXAMINING ATTORNEY

SN 77-121,777. VILLARREAL, CESAR A, GARLAND, TX. FILED 3-4-2007.



NO CLAIM IS MADE TO THE EXCLUSIVE RIGHT TO USE "HERBOLARIA EN MICRODOSIS", APART FROM THE MARK AS SHOWN.

THE COLOR(S) GREEN AND YELLOW IS/ARE CLAIMED AS A FEATURE OF THE MARK.

THE COLOR GREEN APPEARS IN ALL OF THE WORDING IN THE MARK AND IN THE UPPER PORTION OF THE DROP, WHICH CHANGES AS A GRADIENT FROM GREEN AT THE TOP TO YELLOW AT THE BOTTOM OF THE DROP.

THE ENGLISH TRANSLATION OF HERBOLARIA EN MICRODOSIS IS HERBARIUM BY MICRODOSE.

FOR MEDICINAL HERB EXTRACTS (U.S. CLS. 6, 18, 44, 46, 51 AND 52).

FIRST USE 9-1-2006; IN COMMERCE 1-1-2007.

CHARLOTTE CORWIN, EXAMINING ATTORNEY

SN 77-125,706. BODY DYNAMICS, INC., CARMEL, IN. FILED 3-8-2007.

MINI THIN RUSH

THE MARK CONSISTS OF STANDARD CHARACTERS WITHOUT CLAIM TO ANY PARTICULAR FONT, STYLE, SIZE, OR COLOR.

OWNER OF U.S. REG. NOS. 1,529,295, 2,738,788 AND OTHERS.

FOR DIETARY SUPPLEMENTS; DIETARY SUPPLEMENTS FOR HUMAN CONSUMPTION (U.S. CLS. 6, 18, 44, 46, 51 AND 52).

PAUL CROWLEY, EXAMINING ATTORNEY

CLASS 5—(Continued).

SN 77-130,535. CHERRYDALE MANUFACTURING, L.L.C., ALLENTOWN, PA. FILED 3-14-2007.

BARTONS GOLD

THE MARK CONSISTS OF STANDARD CHARACTERS WITHOUT CLAIM TO ANY PARTICULAR FONT, STYLE, SIZE, OR COLOR.

OWNER OF U.S. REG. NOS. 669,032, 2,971,944 AND OTHERS.

FOR MEAL REPLACEMENT BARS; VITAMINS AND MINERALS FORMED AND PACKAGED AS BARS (U.S. CLS. 6, 18, 44, 46, 51 AND 52).

KEVON CHISOLM, EXAMINING ATTORNEY

SN 77-151,212. BEON HOLDINGS, INC., LOS ANGELES, CA. FILED 4-7-2007.



NO CLAIM IS MADE TO THE EXCLUSIVE RIGHT TO USE "SOURCE VERIFIED INTEGRITY", APART FROM THE MARK AS SHOWN.

"THE COLOR(S) GREEN, BROWN, WHITE, AND PINK IS/ ARE CLAIMED AS A FEATURE OF THE MARK."

"THE MARK CONSISTS OF THE TERM "SOURCE" IN BROWN LETTERING AND THE TERMS "VERIFIED INTEGRITY" IN GREEN LETTERING. THE WORDING IS IN THE CENTER OF THE DESIGN ELEMENT, WHICH CONSISTS OF A PINK AND WHITE SUNRISE ABOVE A GREEN AND WHITE FIELD, WITH A BROWN BRANCH IN A SEMI-CIRCLE AROUND WORDING AND ENCLOSING THE SUN DESIGN'S RAYS, AND TWO GREEN LEAVES IN THE UPPER LEFT CORNER."

FOR NUTRITIONAL AND DIETARY SUPPLEMENTS (U.S. CLS. 6, 18, 44, 46, 51 AND 52).

MATTHEW MCDOWELL, EXAMINING ATTORNEY

SN 77-151,575. VITA PROSPERA ENTERPRISES, LLC, AVON, CO. FILED 4-9-2007.

VITA PROSPERA

THE MARK CONSISTS OF STANDARD CHARACTERS WITHOUT CLAIM TO ANY PARTICULAR FONT, STYLE, SIZE, OR COLOR.

THE ENGLISH TRANSLATION OF VITA PROSPERA IS "THRIVING LIFE."

FOR VITAMINS; DIETARY AND NUTRITIONAL SUPPLEMENTS (U.S. CLS. 6, 18, 44, 46, 51 AND 52).

MELVIN AXILBUND, EXAMINING ATTORNEY

CLASS 5—(Continued).

SN 77-152,560. AMGEN INC., THOUSAND OAKS, CA. FILED 4-10-2007.

STUVIA

THE MARK CONSISTS OF STANDARD CHARACTERS WITHOUT CLAIM TO ANY PARTICULAR FONT, STYLE, SIZE, OR COLOR.

FOR PHARMACEUTICAL PREPARATIONS FOR THE TREATMENT OF BONE DISEASE (U.S. CLS. 6, 18, 44, 46, 51 AND 52).

BRIDGETT SMITH, EXAMINING ATTORNEY

SN 77-152,575. AMGEN INC., THOUSAND OAKS, CA. FILED 4-10-2007.

STRONOS

THE MARK CONSISTS OF STANDARD CHARACTERS WITHOUT CLAIM TO ANY PARTICULAR FONT, STYLE, SIZE, OR COLOR.

FOR PHARMACEUTICAL PREPARATIONS FOR THE TREATMENT OF BONE DISEASE (U.S. CLS. 6, 18, 44, 46, 51 AND 52).

BRIDGETT SMITH, EXAMINING ATTORNEY

SN 77-152,585. AMGEN INC., THOUSAND OAKS, CA. FILED 4-10-2007.

OSTUVIO

THE MARK CONSISTS OF STANDARD CHARACTERS WITHOUT CLAIM TO ANY PARTICULAR FONT, STYLE, SIZE, OR COLOR.

FOR PHARMACEUTICAL PREPARATIONS FOR THE TREATMENT OF BONE DISEASE (U.S. CLS. 6, 18, 44, 46, 51 AND 52).

BRIDGETT SMITH, EXAMINING ATTORNEY

CLASS 5—(Continued).

SN 77-152,595. AMGEN INC., THOUSAND OAKS, CA. FILED 4-10-2007.

OSPIMA

THE MARK CONSISTS OF STANDARD CHARACTERS WITHOUT CLAIM TO ANY PARTICULAR FONT, STYLE, SIZE, OR COLOR.
FOR PHARMACEUTICAL PREPARATIONS FOR THE TREATMENT OF BONE DISEASE (U.S. CLS. 6, 18, 44, 46, 51 AND 52).
BRIDGETT SMITH, EXAMINING ATTORNEY

CLASS 5—(Continued).

SN 77-152,634. AMGEN INC., THOUSAND OAKS, CA. FILED 4-10-2007.

ONOSTRA

THE MARK CONSISTS OF STANDARD CHARACTERS WITHOUT CLAIM TO ANY PARTICULAR FONT, STYLE, SIZE, OR COLOR.
FOR PHARMACEUTICAL PREPARATIONS FOR THE TREATMENT OF BONE DISEASE (U.S. CLS. 6, 18, 44, 46, 51 AND 52).
BRIDGETT SMITH, EXAMINING ATTORNEY

SN 77-152,608. AMGEN INC., THOUSAND OAKS, CA. FILED 4-10-2007.

ONVEOS

THE MARK CONSISTS OF STANDARD CHARACTERS WITHOUT CLAIM TO ANY PARTICULAR FONT, STYLE, SIZE, OR COLOR.
FOR PHARMACEUTICAL PREPARATIONS FOR THE TREATMENT OF BONE DISEASE (U.S. CLS. 6, 18, 44, 46, 51 AND 52).
BRIDGETT SMITH, EXAMINING ATTORNEY

SN 77-152,646. AMGEN INC., THOUSAND OAKS, CA. FILED 4-10-2007.

ENCHANA

THE MARK CONSISTS OF STANDARD CHARACTERS WITHOUT CLAIM TO ANY PARTICULAR FONT, STYLE, SIZE, OR COLOR.
FOR PHARMACEUTICAL PREPARATIONS FOR THE TREATMENT OF BONE DISEASE (U.S. CLS. 6, 18, 44, 46, 51 AND 52).
BRIDGETT SMITH, EXAMINING ATTORNEY

SN 77-152,628. AMGEN INC., THOUSAND OAKS, CA. FILED 4-10-2007.

ONVATOL

THE MARK CONSISTS OF STANDARD CHARACTERS WITHOUT CLAIM TO ANY PARTICULAR FONT, STYLE, SIZE, OR COLOR.
FOR PHARMACEUTICAL PREPARATIONS FOR THE TREATMENT OF BONE DISEASE (U.S. CLS. 6, 18, 44, 46, 51 AND 52).
BRIDGETT SMITH, EXAMINING ATTORNEY

SN 77-152,660. AMGEN INC., THOUSAND OAKS, CA. FILED 4-10-2007.

DENOBA

THE MARK CONSISTS OF STANDARD CHARACTERS WITHOUT CLAIM TO ANY PARTICULAR FONT, STYLE, SIZE, OR COLOR.
FOR PHARMACEUTICAL PREPARATIONS FOR THE TREATMENT OF BONE DISEASE (U.S. CLS. 6, 18, 44, 46, 51 AND 52).
BRIDGETT SMITH, EXAMINING ATTORNEY

CLASS 5—(Continued).

SN 77-152,917. INTELLIGENDER, LLC, DALLAS, TX. FILED 4-10-2007.

INTELLIGENDER G.P.T.

THE MARK CONSISTS OF STANDARD CHARACTERS WITHOUT CLAIM TO ANY PARTICULAR FONT, STYLE, SIZE, OR COLOR.

FOR IN VITRO GENDER PREDICTION TEST KIT (U.S. CLS. 6, 18, 44, 46, 51 AND 52).
DANIEL RUSSELL, EXAMINING ATTORNEY

SN 77-153,478. MAGNUM NUTRACEUTICALS, INC., RICHMOND, CANADA, FILED 4-10-2007.



THE COLOR(S) BLACK, WHITE AND GREY IS/ARE CLAIMED AS A FEATURE OF THE MARK.

THE MARK CONSISTS OF THREE DIMENSIONAL LETTERS FORMING THE WORD "MAGNUM" WITH THE LETTERS BEING SHADED WITH BLACK, WHITE AND GREY FOR THE THREE DIMENSIONAL EFFECT, ON A BLACK BACKGROUND.

FOR DIETARY AND NUTRITIONAL SUPPLEMENTS; DIETARY FOOD SUPPLEMENTS; DIETARY SUPPLEMENTAL DRINKS; DIETARY SUPPLEMENTS; DIETARY SUPPLEMENTS FOR HUMAN CONSUMPTION; FOOD SUPPLEMENTS; FOOD SUPPLEMENTS, NAMELY, ANTI-OXIDANTS; MEAL REPLACEMENT AND DIETARY SUPPLEMENT DRINK MIXES; MINERAL NUTRITIONAL SUPPLEMENTS; MINERAL SUPPLEMENTS; NUTRACEUTICALS FOR USE AS A DIETARY SUPPLEMENT; NUTRITIONAL ADDITIVES FOR USE IN FOODS AND DIETARY SUPPLEMENTS FOR HUMAN CONSUMPTION; NUTRITIONAL SUPPLEMENTS; VITAMIN AND MINERAL SUPPLEMENTS; VITAMIN SUPPLEMENTS (U.S. CLS. 6, 18, 44, 46, 51 AND 52).
FIRST USE 1-1-2003; IN COMMERCE 1-1-2003.

KARANENDRA S. CHHINA, EXAMINING ATTORNEY

SN 77-154,738. SDT WASTE & DEBRIS SERVICES, L.L.C., NEW ORLEANS, LA. FILED 4-12-2007.

SUPER FRESH

THE MARK CONSISTS OF STANDARD CHARACTERS WITHOUT CLAIM TO ANY PARTICULAR FONT, STYLE, SIZE, OR COLOR.

FOR DEODORIZING PRODUCT, NAMELY, BIODEGRADABLE DISINFECTANT FOR ERADICATING ODORS AND CLEANING STREETS (U.S. CLS. 6, 18, 44, 46, 51 AND 52).

RONALD MCMORROW, EXAMINING ATTORNEY

CLASS 5—(Continued).

SN 77-154,839. CHERRYDALE MANUFACTURING, L.L.C., ALLENTOWN, PA. FILED 4-12-2007.

SINCE 1898



OWNER OF U.S. REG. NOS. 669,032, 2,971,944 AND OTHERS.

NO CLAIM IS MADE TO THE EXCLUSIVE RIGHT TO USE "SINCE 1898", APART FROM THE MARK AS SHOWN. THE MARK CONSISTS OF THE WORDS "SINCE 1898" APPEARING ABOVE AN OVAL CONTAINING THE WORDS "BARTONS GOLD".

FOR MEAL REPLACEMENT BARS; VITAMINS AND MINERALS FORMED AND PACKAGED AS BARS (U.S. CLS. 6, 18, 44, 46, 51 AND 52).

KEVON CHISOLM, EXAMINING ATTORNEY

SN 77-154,859. OSMEGEN, INC., ALLENTOWN, PA. FILED 4-12-2007.

Adios Amigos

THE MARK CONSISTS OF STANDARD CHARACTERS WITHOUT CLAIM TO ANY PARTICULAR FONT, STYLE, SIZE, OR COLOR.

FOR DEODORIZING PRODUCTS, NAMELY, ALL PURPOSE DEODORIZER PREPARATIONS FOR HOUSEHOLD, COMMERCIAL AND INDUSTRIAL USE; INSECTICIDES (U.S. CLS. 6, 18, 44, 46, 51 AND 52).

SHAILA SETTLES, EXAMINING ATTORNEY

SN 77-155,100. ROCKWELL MEDICAL TECHNOLOGIES, INC., WIXOM, MI. FILED 4-12-2007.

DRI-SATE

THE MARK CONSISTS OF STANDARD CHARACTERS WITHOUT CLAIM TO ANY PARTICULAR FONT, STYLE, SIZE, OR COLOR.

FOR PHARMACEUTICAL COMPOSITION USED FOR HEMODIALYSIS (U.S. CLS. 6, 18, 44, 46, 51 AND 52).

FIRST USE 10-0-1996; IN COMMERCE 10-0-1996.

ELLEN PERKINS, EXAMINING ATTORNEY

CLASS 5—(Continued).

SN 77-155,517. CP MEDICAL, PORTLAND, OR. FILED 4-12-2007.

OSCERA7

THE MARK CONSISTS OF STANDARD CHARACTERS WITHOUT CLAIM TO ANY PARTICULAR FONT, STYLE, SIZE, OR COLOR.

FOR BONE WAX FOR USE IN SURGICAL PROCEDURES (U.S. CLS. 6, 18, 44, 46, 51 AND 52).

FIRST USE 6-30-2006; IN COMMERCE 6-30-2006.

MICHAEL KAZAZIAN, EXAMINING ATTORNEY

SN 77-155,962. VITALREMEDYMD, INC., BOCA RATON, FL. FILED 4-13-2007.

VITALKIDNEY

THE MARK CONSISTS OF STANDARD CHARACTERS WITHOUT CLAIM TO ANY PARTICULAR FONT, STYLE, SIZE, OR COLOR.

OWNER OF U.S. REG. NO. 2,788,806.

FOR VITAMINS, NUTRITIONAL SUPPLEMENTS; MEAL REPLACEMENT BARS; AND VITAMIN AND MINERAL FORMED AND PACKAGED AS BARS (U.S. CLS. 6, 18, 44, 46, 51 AND 52).

STEVEN PEREZ, EXAMINING ATTORNEY

SN 77-156,005. IC-MEDTECH, INC., EL CAJON, CA. FILED 4-13-2007.

Tolecine

THE MARK CONSISTS OF STANDARD CHARACTERS WITHOUT CLAIM TO ANY PARTICULAR FONT, STYLE, SIZE, OR COLOR.

FOR ANTIBACTERIAL PHARMACEUTICALS; DERMATOLOGICAL PHARMACEUTICAL PRODUCTS; DRUG DELIVERY AGENTS CONSISTING OF COMPOUNDS THAT FACILITATE DELIVERY OF A WIDE RANGE OF PHARMACEUTICALS; PHARMACEUTICAL PREPARATIONS FOR THE TREATMENT OF EYE DISEASES AND CONDITIONS; PHARMACEUTICAL PREPARATIONS FOR THE TREATMENT OF INFECTIOUS DISEASES; PHARMACEUTICAL PREPARATIONS FOR USE IN CHEMOTHERAPY; PHARMACEUTICAL PREPARATIONS FOR USE IN DERMATOLOGY; PHARMACEUTICAL PREPARATIONS FOR USE IN UROLOGY; PHARMACEUTICAL PRODUCTS FOR THE TREATMENT OF VIRAL AND INFECTIOUS DISEASES. FOR THE TREATMENT OF CANCER; PHARMACEUTICALS, NAMELY, ANTI-INFECTIVES (U.S. CLS. 6, 18, 44, 46, 51 AND 52).

STEVEN R. FINE, EXAMINING ATTORNEY

CLASS 5—(Continued).

SN 77-156,042. HERBAL GROUPS, CHATSWORTH, CA. FILED 4-13-2007.

RESTALEX pm

THE MARK CONSISTS OF STANDARD CHARACTERS WITHOUT CLAIM TO ANY PARTICULAR FONT, STYLE, SIZE, OR COLOR.

NO CLAIM IS MADE TO THE EXCLUSIVE RIGHT TO USE "PM", APART FROM THE MARK AS SHOWN.

FOR HERBAL SUPPLEMENTS (U.S. CLS. 6, 18, 44, 46, 51 AND 52).

JANET LEE, EXAMINING ATTORNEY

SN 77-156,415. BIND BIOSCIENCES, INC., CAMBRIDGE, MA. FILED 4-13-2007.

BIND BIOSCIENCES

THE MARK CONSISTS OF STANDARD CHARACTERS WITHOUT CLAIM TO ANY PARTICULAR FONT, STYLE, SIZE, OR COLOR.

NO CLAIM IS MADE TO THE EXCLUSIVE RIGHT TO USE "BIOSCIENCES", APART FROM THE MARK AS SHOWN.

FOR PHARMACEUTICAL PREPARATIONS FOR THE TREATMENT OF CANCER, CARDIOVASCULAR DISEASES, INFLAMMATORY DISEASES AND INFECTIOUS DISEASES (U.S. CLS. 6, 18, 44, 46, 51 AND 52).

KATHERINE E. HALMEN, EXAMINING ATTORNEY

SN 77-156,722. DSX THERAPEUTICS, LLC, LAS VEGAS, NV. FILED 4-13-2007.

ASEPTIMAB

THE MARK CONSISTS OF STANDARD CHARACTERS WITHOUT CLAIM TO ANY PARTICULAR FONT, STYLE, SIZE, OR COLOR.

FOR PHARMACEUTICAL PREPARATIONS FOR THE TREATMENT OF CARDIO-VASCULAR DISEASES, CENTRAL NERVOUS SYSTEM DISEASES AND DISORDERS, STROKE, CANCER, INFLAMMATION AND INFLAMMATORY DISEASES, RESPIRATORY AND INFECTIOUS DISEASE (U.S. CLS. 6, 18, 44, 46, 51 AND 52).

GENE MACIOL, EXAMINING ATTORNEY

CLASS 5—(Continued).

SN 77-156,903. NICKELL, ROBERT P., TORRANCE, CA.
FILED 4-14-2007.

CLASS 5—(Continued).

SN 77-156,908. NICKELL, ROBERT P., TORRANCE, CA.
FILED 4-14-2007.

CARDONE

CYCLOMAG

THE MARK CONSISTS OF STANDARD CHARACTERS WITHOUT CLAIM TO ANY PARTICULAR FONT, STYLE, SIZE, OR COLOR.
FOR PAIN RELIEF MEDICATION; ORAL ANALGESICS (U.S. CLS. 6, 18, 44, 46, 51 AND 52).
FIRST USE 3-1-2007; IN COMMERCE 3-1-2007.
ANGELA M. MICHELI, EXAMINING ATTORNEY

THE MARK CONSISTS OF STANDARD CHARACTERS WITHOUT CLAIM TO ANY PARTICULAR FONT, STYLE, SIZE, OR COLOR.
FOR ORAL ANALGESICS; PAIN RELIEF MEDICATION (U.S. CLS. 6, 18, 44, 46, 51 AND 52).
FIRST USE 1-1-2006; IN COMMERCE 1-1-2006.
ANGELA M. MICHELI, EXAMINING ATTORNEY

SN 77-156,904. NICKELL, ROBERT P., TORRANCE, CA.
FILED 4-14-2007.

SN 77-156,911. NICKELL, ROBERT P., TORRANCE, CA.
FILED 4-14-2007.

CAR-TAC

DEXTRODONE

THE MARK CONSISTS OF STANDARD CHARACTERS WITHOUT CLAIM TO ANY PARTICULAR FONT, STYLE, SIZE, OR COLOR.
FOR ORAL ANALGESICS; PAIN RELIEF MEDICATION (U.S. CLS. 6, 18, 44, 46, 51 AND 52).
FIRST USE 3-1-2007; IN COMMERCE 3-1-2007.
ANGELA M. MICHELI, EXAMINING ATTORNEY

THE MARK CONSISTS OF STANDARD CHARACTERS WITHOUT CLAIM TO ANY PARTICULAR FONT, STYLE, SIZE, OR COLOR.
FOR PAIN RELIEF MEDICATION; ORAL ANALGESICS (U.S. CLS. 6, 18, 44, 46, 51 AND 52).
FIRST USE 3-1-2007; IN COMMERCE 3-1-2007.
ANGELA M. MICHELI, EXAMINING ATTORNEY

SN 77-156,906. NICKELL, ROBERT P., TORRANCE, CA.
FILED 4-14-2007.

SN 77-156,913. NICKELL, ROBERT P., TORRANCE, CA.
FILED 4-14-2007.

CO-FO

INDOCODONE

THE MARK CONSISTS OF STANDARD CHARACTERS WITHOUT CLAIM TO ANY PARTICULAR FONT, STYLE, SIZE, OR COLOR.
FOR PAIN RELIEF MEDICATION; ORAL ANALGESICS (U.S. CLS. 6, 18, 44, 46, 51 AND 52).
FIRST USE 3-1-2007; IN COMMERCE 3-1-2007.
ANGELA M. MICHELI, EXAMINING ATTORNEY

THE MARK CONSISTS OF STANDARD CHARACTERS WITHOUT CLAIM TO ANY PARTICULAR FONT, STYLE, SIZE, OR COLOR.
FOR ORAL ANALGESICS; PAIN RELIEF MEDICATION (U.S. CLS. 6, 18, 44, 46, 51 AND 52).
FIRST USE 6-1-2006; IN COMMERCE 6-1-2006.
ANGELA M. MICHELI, EXAMINING ATTORNEY

CLASS 5—(Continued).

SN 77-156,914. NICKELL, ROBERT P., TORRANCE, CA.
FILED 4-14-2007.

LOPAPADONE

THE MARK CONSISTS OF STANDARD CHARACTERS
WITHOUT CLAIM TO ANY PARTICULAR FONT, STYLE,
SIZE, OR COLOR.

FOR PAIN RELIEF MEDICATION; ORAL ANALGE-
SICS (U.S. CLS. 6, 18, 44, 46, 51 AND 52).
FIRST USE 1-1-2005; IN COMMERCE 1-1-2005.
ANGELA M. MICHELI, EXAMINING ATTORNEY

CLASS 5—(Continued).

SN 77-156,926. ROBERT P. NICKELL, TORRANCE, CA.
FILED 4-14-2007.

KETORUB-L

THE MARK CONSISTS OF STANDARD CHARACTERS
WITHOUT CLAIM TO ANY PARTICULAR FONT, STYLE,
SIZE, OR COLOR.

OWNER OF U.S. REG. NO. 3,210,824.
FOR TOPICAL GEL FOR MEDICAL AND THERA-
PEUTIC TREATMENT OF INFLAMMATION AND PAIN;
PAIN RELIEF MEDICATION; MEDICINAL CREAMS
FOR SKIN CARE (U.S. CLS. 6, 18, 44, 46, 51 AND 52).
FIRST USE 1-1-2006; IN COMMERCE 1-1-2006.
ANGELA M. MICHELI, EXAMINING ATTORNEY

SN 77-156,919. NICKELL, ROBERT P., TORRANCE, CA.
FILED 4-14-2007.

MELADRYL

THE MARK CONSISTS OF STANDARD CHARACTERS
WITHOUT CLAIM TO ANY PARTICULAR FONT, STYLE,
SIZE, OR COLOR.

FOR ORAL ANALGESICS; PAIN RELIEF MEDICA-
TION (U.S. CLS. 6, 18, 44, 46, 51 AND 52).
FIRST USE 3-1-2007; IN COMMERCE 3-1-2007.
ANGELA M. MICHELI, EXAMINING ATTORNEY

SN 77-156,928. ROBERT P. NICKELL, TORRANCE, CA.
FILED 4-14-2007.

KETOSABI

THE MARK CONSISTS OF STANDARD CHARACTERS
WITHOUT CLAIM TO ANY PARTICULAR FONT, STYLE,
SIZE, OR COLOR.

FOR TOPICAL GEL FOR MEDICAL AND THERA-
PEUTIC TREATMENT OF INFLAMMATION AND PAIN;
PAIN RELIEF MEDICATION; MEDICINAL CREAMS
FOR SKIN CARE (U.S. CLS. 6, 18, 44, 46, 51 AND 52).
FIRST USE 1-1-2006; IN COMMERCE 1-1-2006.
ANGELA M. MICHELI, EXAMINING ATTORNEY

SN 77-156,923. ROBERT P. NICKELL, TORRANCE, CA.
FILED 4-14-2007.

NAPROXIPAM

THE MARK CONSISTS OF STANDARD CHARACTERS
WITHOUT CLAIM TO ANY PARTICULAR FONT, STYLE,
SIZE, OR COLOR.

FOR ORAL ANALGESICS; PAIN RELIEF MEDICA-
TION (U.S. CLS. 6, 18, 44, 46, 51 AND 52).
FIRST USE 3-1-2007; IN COMMERCE 3-1-2007.
ANGELA M. MICHELI, EXAMINING ATTORNEY

SN 77-157,236. VITALREMEDYMD, INC., BOCA RATON, FL.
FILED 4-16-2007.

KIDNEYASSIST

THE MARK CONSISTS OF STANDARD CHARACTERS
WITHOUT CLAIM TO ANY PARTICULAR FONT, STYLE,
SIZE, OR COLOR.

FOR VITAMINS, NUTRITIONAL SUPPLEMENTS;
MEAL REPLACEMENT BARS; AND VITAMINS AND
MINERALS FORMED AND PACKAGED AS BARS (U.S.
CLS. 6, 18, 44, 46, 51 AND 52).
STEVEN PEREZ, EXAMINING ATTORNEY

CLASS 5—(Continued).

SN 77-157,246. VITALREMEDYMD, INC., BOCA RATON, FL. FILED 4-16-2007.

KIDNEYSHIELD

THE MARK CONSISTS OF STANDARD CHARACTERS WITHOUT CLAIM TO ANY PARTICULAR FONT, STYLE, SIZE, OR COLOR.

FOR VITAMINS, NUTRITIONAL SUPPLEMENTS; MEAL REPLACEMENT BARS; AND VITAMINS AND MINERALS FORMED AND PACKAGED AS BARS (U.S. CLS. 6, 18, 44, 46, 51 AND 52).

STEVEN PEREZ, EXAMINING ATTORNEY

CLASS 5—(Continued).

SN 77-158,303. CASTILLO DISTRIBUTORS, CORP, LITTLE FERRY, FL. FILED 4-17-2007.

LIMPIA PECHO

THE MARK CONSISTS OF STANDARD CHARACTERS WITHOUT CLAIM TO ANY PARTICULAR FONT, STYLE, SIZE, OR COLOR.

THE FOREIGN WORDING IN THE MARK TRANSLATES INTO ENGLISH AS CLEAN CHEST.

FOR COUGH SYRUP (U.S. CLS. 6, 18, 44, 46, 51 AND 52).

FIRST USE 3-31-2000; IN COMMERCE 3-31-2006.
CHERYL CLAYTON, EXAMINING ATTORNEY

SN 77-157,636. FRASER, SCOTT S., DEL MAR, CA. FILED 4-16-2007.

FROLIC

THE MARK CONSISTS OF STANDARD CHARACTERS WITHOUT CLAIM TO ANY PARTICULAR FONT, STYLE, SIZE, OR COLOR.

FOR PERSONAL LUBRICANTS (U.S. CLS. 6, 18, 44, 46, 51 AND 52).

ALEX KEAM, EXAMINING ATTORNEY

SN 77-158,360. BIOGENESIS ENTERPRISES, INC., DES PLAINES, IL. FILED 4-17-2007.

Clear

THE MARK CONSISTS OF STANDARD CHARACTERS WITHOUT CLAIM TO ANY PARTICULAR FONT, STYLE, SIZE, OR COLOR.

FOR AIR FRESHENERS; DEODORIZING PRODUCTS, NAMELY, ALL PURPOSE DEODORIZER PREPARATIONS FOR HOUSEHOLD, COMMERCIAL AND INDUSTRIAL USE (U.S. CLS. 6, 18, 44, 46, 51 AND 52).

LYDIA BELZER, EXAMINING ATTORNEY

SN 77-157,831. COMPLETE H2O MINERALS, INC., WEST COLUMBIA, SC. FILED 4-16-2007.

SPORTS BLEND ELECTROLITE

THE MARK CONSISTS OF STANDARD CHARACTERS WITHOUT CLAIM TO ANY PARTICULAR FONT, STYLE, SIZE, OR COLOR.

NO CLAIM IS MADE TO THE EXCLUSIVE RIGHT TO USE "BLEND ELECTROLITE", APART FROM THE MARK AS SHOWN.

FOR NUTRITIONAL SUPPLEMENT (U.S. CLS. 6, 18, 44, 46, 51 AND 52).

FIRST USE 1-5-2006; IN COMMERCE 1-5-2006.
IRA J. GOODSAD, EXAMINING ATTORNEY

SN 77-158,652. PBI/GORDON CORPORATION, KANSAS CITY, MO. FILED 4-17-2007.

GRUB-NO-MORE

THE MARK CONSISTS OF STANDARD CHARACTERS WITHOUT CLAIM TO ANY PARTICULAR FONT, STYLE, SIZE, OR COLOR.

OWNER OF U.S. REG. NOS. 504,532, 2,169,613 AND OTHERS.

FOR INSECTICIDES FOR AGRICULTURAL, COMMERCIAL AND DOMESTIC USE (U.S. CLS. 6, 18, 44, 46, 51 AND 52).

KATHRYN COWARD, EXAMINING ATTORNEY

CLASS 5—(Continued).

SN 77-158,694. TEVA PHARMACEUTICAL INDUSTRIES LTD., JERUSALEM, ISRAEL, FILED 4-17-2007.



OWNER OF ISRAEL REG. NO. 179309, DATED 8-3-2006, EXPIRES 8-3-2016.

OWNER OF U.S. REG. NOS. 1,567,918, 2,937,656 AND OTHERS.

THE ENGLISH TRANSLATION OF THE TERM "TEVA" IS "NATURE."

FOR HOUSE MARK FOR A FULL LINE OF PHARMACEUTICAL PREPARATIONS; VETERINARY PREPARATIONS AND PHARMACEUTICAL ACTIVE INGREDIENTS (U.S. CLS. 6, 18, 44, 46, 51 AND 52).

GEOFFREY FOSDICK, EXAMINING ATTORNEY



SN 77-158,736. GARDEN OF LIFE, INC., WEST PALM BEACH, FL. FILED 4-17-2007.

PROBIO-WELLNESS

THE MARK CONSISTS OF STANDARD CHARACTERS WITHOUT CLAIM TO ANY PARTICULAR FONT, STYLE, SIZE, OR COLOR.

FOR DIETARY AND NUTRITIONAL SUPPLEMENTS (U.S. CLS. 6, 18, 44, 46, 51 AND 52).

TAMARA FRAZIER, EXAMINING ATTORNEY



SN 77-158,746. GARDEN OF LIFE, INC., WEST PALM BEACH, FL. FILED 4-17-2007.

PROBIOWELLNESS

THE MARK CONSISTS OF STANDARD CHARACTERS WITHOUT CLAIM TO ANY PARTICULAR FONT, STYLE, SIZE, OR COLOR.

FOR DIETARY AND NUTRITIONAL SUPPLEMENTS (U.S. CLS. 6, 18, 44, 46, 51 AND 52).

TAMARA FRAZIER, EXAMINING ATTORNEY

CLASS 5—(Continued).

SN 77-158,777. TRIVITA, INC., SCOTTSDALE, AZ. FILED 4-17-2007.

CONVERTA

THE MARK CONSISTS OF STANDARD CHARACTERS WITHOUT CLAIM TO ANY PARTICULAR FONT, STYLE, SIZE, OR COLOR.

FOR NUTRITIONAL SUPPLEMENTS (U.S. CLS. 6, 18, 44, 46, 51 AND 52).

JOHN HWANG, EXAMINING ATTORNEY



SN 77-158,862. TRIVITA, INC., SCOTTSDALE, AZ. FILED 4-17-2007.

SUSTAINIA

THE MARK CONSISTS OF STANDARD CHARACTERS WITHOUT CLAIM TO ANY PARTICULAR FONT, STYLE, SIZE, OR COLOR.

FOR NUTRITIONAL SUPPLEMENTS (U.S. CLS. 6, 18, 44, 46, 51 AND 52).

JOHN HWANG, EXAMINING ATTORNEY



SN 77-158,882. TRIVITA, INC., SCOTTSDALE, AZ. FILED 4-17-2007.

LEANOLOGY

THE MARK CONSISTS OF STANDARD CHARACTERS WITHOUT CLAIM TO ANY PARTICULAR FONT, STYLE, SIZE, OR COLOR.

FOR NUTRITIONAL SUPPLEMENTS (U.S. CLS. 6, 18, 44, 46, 51 AND 52).

JOHN HWANG, EXAMINING ATTORNEY

CLASS 5—(Continued).

SN 77-158,981. VIPROTEK, TORRANCE, CA. FILED 4-17-2007.

Viprocel

THE MARK CONSISTS OF STANDARD CHARACTERS WITHOUT CLAIM TO ANY PARTICULAR FONT, STYLE, SIZE, OR COLOR.

FOR NUTRITIONAL SUPPLEMENTS (U.S. CLS. 6, 18, 44, 46, 51 AND 52).

JANET LEE, EXAMINING ATTORNEY

SN 77-159,354. OSMOPHARM, USA, POMPANO BEACH, FL. FILED 4-18-2007.

EarX

THE MARK CONSISTS OF STANDARD CHARACTERS WITHOUT CLAIM TO ANY PARTICULAR FONT, STYLE, SIZE, OR COLOR.

FOR NUTRITIONAL SUPPLEMENTS (U.S. CLS. 6, 18, 44, 46, 51 AND 52).

PAUL E. FAHRENKOPF, EXAMINING ATTORNEY

SN 77-159,358. OSMOPHARM, USA, POMPANO BEACH, FL. FILED 4-18-2007.

SoundFree

THE MARK CONSISTS OF STANDARD CHARACTERS WITHOUT CLAIM TO ANY PARTICULAR FONT, STYLE, SIZE, OR COLOR.

FOR NUTRITIONAL SUPPLEMENTS (U.S. CLS. 6, 18, 44, 46, 51 AND 52).

PAUL E. FAHRENKOPF, EXAMINING ATTORNEY

CLASS 5—(Continued).

SN 77-160,149. NUTRISCIENCE CORPORATION, SANTA BARBARA, CA. FILED 4-18-2007.

ENERZYME

THE MARK CONSISTS OF STANDARD CHARACTERS WITHOUT CLAIM TO ANY PARTICULAR FONT, STYLE, SIZE, OR COLOR.

FOR NUTRITIONAL SUPPLEMENTS; DIETARY SUPPLEMENTS; HERBAL SUPPLEMENTS; MINERAL SUPPLEMENTS; FOOD SUPPLEMENTS, NAMELY, VITAMINS, MINERAL SUPPLEMENTS, HERBAL SUPPLEMENTS, AMINO ACID SUPPLEMENTS, DIGESTIVE ENZYME NUTRITIONAL SUPPLEMENTS, AND DIETARY SUPPLEMENTS (U.S. CLS. 6, 18, 44, 46, 51 AND 52).
MICHAEL LEWIS, EXAMINING ATTORNEY

SN 77-160,508. BABY PRUDENCE LTD., NEW PALTZ, NY. FILED 4-19-2007.

Baby Prudence

THE MARK CONSISTS OF STANDARD CHARACTERS WITHOUT CLAIM TO ANY PARTICULAR FONT, STYLE, SIZE, OR COLOR.

NO CLAIM IS MADE TO THE EXCLUSIVE RIGHT TO USE "BABY", APART FROM THE MARK AS SHOWN.

FOR DIETARY AND NUTRITIONAL SUPPLEMENTS; HERBAL SUPPLEMENTS; HOMEOPATHIC PHARMACEUTICALS FOR USE IN THE TREATMENT OF COLIC (U.S. CLS. 6, 18, 44, 46, 51 AND 52).

GIANCARLO CASTRO, EXAMINING ATTORNEY

SN 77-160,807. VICURON PHARMACEUTICALS INC., KING OF PRUSSIA, PA. FILED 4-19-2007.



THE MARK CONSISTS OF A SPIRAL DESIGN. FOR PHARMACEUTICAL PREPARATIONS FOR THE TREATMENT OF FUNGAL INFECTIONS (U.S. CLS. 6, 18, 44, 46, 51 AND 52).

INGA ERVIN, EXAMINING ATTORNEY

CLASS 5—(Continued).

SN 77-160,832. O'BRIEN, CHRIS, LOS ANGELES, CA. FILED 4-19-2007.

UltraGuard

THE MARK CONSISTS OF STANDARD CHARACTERS WITHOUT CLAIM TO ANY PARTICULAR FONT, STYLE, SIZE, OR COLOR.

FOR ANTISEPTIC PREPARATIONS; ANTISEPTICS (U.S. CLS. 6, 18, 44, 46, 51 AND 52).

CHARLES L. JENKINS, EXAMINING ATTORNEY

SN 77-160,833. EDWARD GEISTLICH SOHNE AG FUR CHEMISCHE INDUSTRIE, CH-6110 WOLHUSEN, SWITZERLAND, FILED 4-19-2007.

VETSTERILE

THE MARK CONSISTS OF STANDARD CHARACTERS WITHOUT CLAIM TO ANY PARTICULAR FONT, STYLE, SIZE, OR COLOR.

FOR CATHETER LOCK SOLUTION FOR INSTILLATION IN INTRA-CORPORAL CATHETERS BETWEEN TREATMENTS FOR PREVENTION OF CATHETER SEPSIS IN LABORATORY ANIMALS (U.S. CLS. 6, 18, 44, 46, 51 AND 52).

JENNIFER DIXON, EXAMINING ATTORNEY

CLASS 5—(Continued).

SN 77-161,011. ELI LILLY AND COMPANY, INDIANAPOLIS, IN. FILED 4-19-2007.

EFFIENTE

THE MARK CONSISTS OF STANDARD CHARACTERS WITHOUT CLAIM TO ANY PARTICULAR FONT, STYLE, SIZE, OR COLOR.

FOR PHARMACEUTICAL PREPARATIONS, NAMELY, PHARMACEUTICAL PREPARATIONS FOR THE TREATMENT OF ALCOHOL USE DISORDERS, ANXIETY, BONE AND SKELETAL DISEASES AND DISORDERS, BLOOD DISEASES AND DISORDERS, CANCER, CARDIOVASCULAR DISEASES, CENTRAL NERVOUS SYSTEM DISEASES AND DISORDERS, DIABETES, DIABETIC NEUROPATHY, ENDOCRINE DISEASES AND DISORDERS, GASTROINTESTINAL DISEASES AND DISORDERS, HORMONAL DISEASES AND DISORDERS, INFLAMMATION AND INFLAMMATORY DISEASES AND DISORDERS, LIVER DISEASES AND DISORDERS, KIDNEY DISEASES AND DISORDERS, NEURODEGENERATIVE DISEASES AND DISORDERS, NEUROLOGICAL DISORDERS, OBESITY, OPHTHALMOLOGIC CONDITIONS AND DISEASES, PAIN, PERIPHERAL NERVOUS SYSTEM DISEASES AND DISORDERS, REPRODUCTIVE SYSTEM DISEASES AND DISORDERS, SEXUAL DYSFUNCTION, UROLOGICAL DISORDERS, DYSLIPIDEMIA, SLEEP DISORDERS, MIGRAINES, METABOLIC DISEASES AND DISORDERS; PHARMACEUTICAL PREPARATIONS FOR THE PREVENTION OF DIABETES; ANTI-PSYCHOTIC AGENTS; AND ANTIDEPRESSANTS (U.S. CLS. 6, 18, 44, 46, 51 AND 52).

MICHAEL GAAFAR, EXAMINING ATTORNEY

SN 77-161,511. DWG INTERNATIONAL, INC., LAS VEGAS, NV. FILED 4-20-2007.

VitaChicken Soup

THE MARK CONSISTS OF STANDARD CHARACTERS WITHOUT CLAIM TO ANY PARTICULAR FONT, STYLE, SIZE, OR COLOR.

FOR DIETARY AND NUTRITIONAL SUPPLEMENTS (U.S. CLS. 6, 18, 44, 46, 51 AND 52).

BARBARA A. LOUGHRAN, EXAMINING ATTORNEY

CLASS 5—(Continued).

SN 77-161,596. COLONBLOW, INC., ORMOND BEACH, FL.
FILED 4-20-2007.

POOPIN' IS COOL.

THE MARK CONSISTS OF STANDARD CHARACTERS
WITHOUT CLAIM TO ANY PARTICULAR FONT, STYLE,
SIZE, OR COLOR.

FOR DIETARY SUPPLEMENTS (U.S. CLS. 6, 18, 44, 46,
51 AND 52).

FIRST USE 6-8-2000; IN COMMERCE 8-15-2000.

GIANCARLO CASTRO, EXAMINING ATTORNEY

CLASS 5—(Continued).

SN 77-162,350. TATUYOU, HASTINGS, MN. FILED 4-20-2007.

tattooderm

THE MARK CONSISTS OF STANDARD CHARACTERS
WITHOUT CLAIM TO ANY PARTICULAR FONT, STYLE,
SIZE, OR COLOR.

FOR BREATHABLE MEDICAL POLYURETHANE AD-
HESIVE TAPE (U.S. CLS. 6, 18, 44, 46, 51 AND 52).

DAVID TOOLEY, EXAMINING ATTORNEY

SN 77-161,722. VITALREMEDYMD, INC., BOCA RATON, FL.
FILED 4-20-2007.

VITALRENEW

THE MARK CONSISTS OF STANDARD CHARACTERS
WITHOUT CLAIM TO ANY PARTICULAR FONT, STYLE,
SIZE, OR COLOR.

OWNER OF U.S. REG. NO. 2,788,806.

FOR VITAMINS, NUTRITIONAL SUPPLEMENTS;
MEAL REPLACEMENT BARS; AND VITAMINS AND
MINERALS FORMED AND PACKAGED AS BARS (U.S.
CLS. 6, 18, 44, 46, 51 AND 52).

STEVEN PEREZ, EXAMINING ATTORNEY

SN 77-162,416. BODYONICS, LTD., FARMINGDALE, NY.
FILED 4-21-2007.

SN 77-162,104. KARSAR, LLC, HUNTINGTON BEACH, CA.
FILED 4-20-2007.

ACU-ICE

THE MARK CONSISTS OF STANDARD CHARACTERS
WITHOUT CLAIM TO ANY PARTICULAR FONT, STYLE,
SIZE, OR COLOR.

FOR ANALGESIC BALM (U.S. CLS. 6, 18, 44, 46, 51
AND 52).

JOHN DWYER, EXAMINING ATTORNEY

NANOXIDE DELIVERY

THE MARK CONSISTS OF STANDARD CHARACTERS
WITHOUT CLAIM TO ANY PARTICULAR FONT, STYLE,
SIZE, OR COLOR.

FOR DIETARY SUPPLEMENTS (U.S. CLS. 6, 18, 44, 46,
51 AND 52).

JOHN HWANG, EXAMINING ATTORNEY

CLASS 5—(Continued).

SN 77-164,173. QUICK-MED TECHNOLOGIES, INC., GAINESVILLE, FL. FILED 4-24-2007.

NimbuDerm

THE MARK CONSISTS OF STANDARD CHARACTERS WITHOUT CLAIM TO ANY PARTICULAR FONT, STYLE, SIZE, OR COLOR.

FOR ANTI-MICROBIAL HANDWASH; MEDICAL CLEANSERS FOR SKIN AND WOUNDS; ACNE MEDICATIONS; ANTIBACTERIAL ALCOHOL SKIN SANITIZER GEL; ANTIBACTERIAL CLEANERS; ANTIBACTERIAL HAND LOTIONS; ANTIBACTERIAL HANDWASH; ANTIBACTERIAL SPRAY; ANTIBACTERIAL SUBSTANCES FOR MEDICAL PURPOSES; ANTI-MICROBIALS FOR DERMATOLOGIC USE; ANTISEPTIC PREPARATIONS; ANTI-ADHESION GELS FOR USE WITH WOUND DRAINAGE DEVICES; ANTI-INFECTIVES; BACTERICIDES; BACTERIOSTATS FOR MEDICINAL, DENTAL AND VETERINARY USE; BANDAGES FOR SKIN WOUNDS; CLEANSING SOLUTIONS FOR MEDICAL USE; CONTACT LENS CLEANING SOLUTIONS; CONTACT LENS DISINFECTANTS; CONTACT LENS SOLUTIONS; DERMATOLOGICALS; DISINFECTANTS FOR HYGIENIC PURPOSES; DISINFECTING HANDWASH; DRESSINGS FOR WOUNDS, BURNS, AND SURGERY; HAND-SANITIZING PREPARATIONS; MEDICATED HAND WASH; MEDICATED LIP BALM; MEDICATED PRE-MOISTENED WIPES; MEDICATED SHAMPOO; MEDICATED SHAVING PREPARATIONS; MEDICATED SKIN CARE PREPARATIONS; PARAPHARMACEUTICAL PRODUCTS FOR USE IN DERMATOLOGY; PHARMACEUTICAL SKIN LOTIONS; PREPARATIONS FOR CLEANSING THE SKIN FOR MEDICAL USE; TOPICAL FIRST AID GEL (U.S. CLS. 6, 18, 44, 46, 51 AND 52).

LAURIE MAYES, EXAMINING ATTORNEY

SN 77-164,198. HEALTH TECHNOLOGY RESOURCES, INC., SCOTTSDALE, AZ. FILED 4-24-2007.

HELPME!

THE MARK CONSISTS OF STANDARD CHARACTERS WITHOUT CLAIM TO ANY PARTICULAR FONT, STYLE, SIZE, OR COLOR.

FOR A FULL LINE OF DIETARY SUPPLEMENTS (U.S. CLS. 6, 18, 44, 46, 51 AND 52).

TOBY BULLOFF, EXAMINING ATTORNEY

CLASS 5—(Continued).

SN 77-164,255. KINGPIN CONCEPTS, INC., LAS VEGAS, NV. FILED 4-24-2007.

BLOW

THE MARK CONSISTS OF STANDARD CHARACTERS WITHOUT CLAIM TO ANY PARTICULAR FONT, STYLE, SIZE, OR COLOR.

FOR FOOD SUPPLEMENT SOLD IN POWDER FORM (U.S. CLS. 6, 18, 44, 46, 51 AND 52).

JORDAN BAKER, EXAMINING ATTORNEY

SN 77-166,166. VITAL PHARMACEUTICALS, INC., DAVIE, FL. FILED 4-26-2007.

MUSCLE POWER

THE MARK CONSISTS OF STANDARD CHARACTERS WITHOUT CLAIM TO ANY PARTICULAR FONT, STYLE, SIZE, OR COLOR.

NO CLAIM IS MADE TO THE EXCLUSIVE RIGHT TO USE "MUSCLE", APART FROM THE MARK AS SHOWN.

FOR DIETARY AND NUTRITIONAL SUPPLEMENTS; NUTRITIONAL SUPPLEMENTS; NUTRITIONALLY FORTIFIED BEVERAGES (U.S. CLS. 6, 18, 44, 46, 51 AND 52).

ALICE SUE CARRUTHERS, EXAMINING ATTORNEY

SN 77-166,575. STIEFEL LABORATORIES, INC., CORAL GABLES, FL. FILED 4-26-2007.

SIMKET

THE MARK CONSISTS OF STANDARD CHARACTERS WITHOUT CLAIM TO ANY PARTICULAR FONT, STYLE, SIZE, OR COLOR.

FOR PHARMACEUTICAL PREPARATIONS FOR THE TREATMENT OF DERMATOLOGICAL DISEASES, CONDITIONS AND DISORDERS (U.S. CLS. 6, 18, 44, 46, 51 AND 52).

JESSICA A. POWERS, EXAMINING ATTORNEY

CLASS 5—(Continued).

SN 77-166,648. STIEFEL LABORATORIES, INC., CORAL GABLES, FL. FILED 4-26-2007.

IKETAZ

THE MARK CONSISTS OF STANDARD CHARACTERS WITHOUT CLAIM TO ANY PARTICULAR FONT, STYLE, SIZE, OR COLOR.

FOR PHARMACEUTICAL PREPARATIONS FOR THE TREATMENT OF DERMATOLOGICAL DISEASES, CONDITIONS AND DISORDERS (U.S. CLS. 6, 18, 44, 46, 51 AND 52).

JESSICA A. POWERS, EXAMINING ATTORNEY

SN 77-166,681. STIEFEL LABORATORIES, INC., CORAL GABLES, FL. FILED 4-26-2007.

CONAKET

THE MARK CONSISTS OF STANDARD CHARACTERS WITHOUT CLAIM TO ANY PARTICULAR FONT, STYLE, SIZE, OR COLOR.

FOR PHARMACEUTICAL PREPARATIONS FOR THE TREATMENT OF DERMATOLOGICAL DISEASES, CONDITIONS AND DISORDERS (U.S. CLS. 6, 18, 44, 46, 51 AND 52).

JESSICA A. POWERS, EXAMINING ATTORNEY

SN 77-171,118. BHM CORPORATION, PORT RICHEY, FL. FILED 5-2-2007.

MEDACTIVE

THE MARK CONSISTS OF STANDARD CHARACTERS WITHOUT CLAIM TO ANY PARTICULAR FONT, STYLE, SIZE, OR COLOR.

FOR MEDICATED MOUTH CARE AND TREATMENT PREPARATIONS IN THE NATURE OF CAVITY PREVENTION VARNISH, DRY MOUTH TREATMENT, ANTI-MICROBIAL FLUORIDE RINSE AND PRESCRIPTION DENTIFRICE (U.S. CLS. 6, 18, 44, 46, 51 AND 52). FIRST USE 6-12-2007; IN COMMERCE 6-12-2007.

DAWN HAN, EXAMINING ATTORNEY

CLASS 5—(Continued).

SN 77-172,915. DICKEY INVESTMENTS, LLC, NOBLESVILLE, IN. FILED 5-4-2007.

KICKS THE CAN OUT OF ENERGY DRINKS

THE MARK CONSISTS OF STANDARD CHARACTERS WITHOUT CLAIM TO ANY PARTICULAR FONT, STYLE, SIZE, OR COLOR.

FOR DIETARY SUPPLEMENTS AND PHARMACEUTICAL STIMULANTS FOR THE CENTRAL NERVOUS SYSTEM (U.S. CLS. 6, 18, 44, 46, 51 AND 52).

PAM WILLIS, EXAMINING ATTORNEY

SN 77-173,375. NEXT PROTEINS, INC., CARLSBAD, CA. FILED 5-4-2007.

LeukiTor

THE MARK CONSISTS OF STANDARD CHARACTERS WITHOUT CLAIM TO ANY PARTICULAR FONT, STYLE, SIZE, OR COLOR.

FOR DIETARY AND NUTRITIONAL SUPPLEMENTS, NAMELY, PROTEIN POWDER DRINK MIXES (U.S. CLS. 6, 18, 44, 46, 51 AND 52).

STEVEN R. FOSTER, EXAMINING ATTORNEY

SN 77-181,020. CHOPRA ENTERPRISES, LLC, CARLSBAD, CA. FILED 5-15-2007.

CHOPRA CENTER

THE MARK CONSISTS OF STANDARD CHARACTERS WITHOUT CLAIM TO ANY PARTICULAR FONT, STYLE, SIZE, OR COLOR.

OWNER OF U.S. REG. NOS. 2,202,591, 2,215,788 AND 3,173,576.

FOR DIETARY AND NUTRITIONAL SUPPLEMENTS; DIETARY FOOD SUPPLEMENTS; DIETARY SUPPLEMENTS; HERBAL PRODUCTS, NAMELY, AROMATHERAPY PACKS CONTAINING HERBS USED FOR RELIEF FROM HEADACHES, INSOMNIA AND SINUS DISCOMFORT; HERBAL SUPPLEMENTS; MIXED VITAMIN PREPARATIONS; MULTI-VITAMIN PREPARATIONS; VITAMIN PREPARATIONS; VITAMIN SUPPLEMENTS; VITAMINS; NUTRITIONAL SUPPLEMENTS (U.S. CLS. 6, 18, 44, 46, 51 AND 52).

LANA PHAM, EXAMINING ATTORNEY

CLASS 5—(Continued).

SN 77-181,872. WEIDER GLOBAL NUTRITION, LLC, SALT LAKE CITY, UT. FILED 5-15-2007.

SWEETE

THE MARK CONSISTS OF STANDARD CHARACTERS WITHOUT CLAIM TO ANY PARTICULAR FONT, STYLE, SIZE, OR COLOR.

NO CLAIM IS MADE TO THE EXCLUSIVE RIGHT TO USE "SWEET", APART FROM THE MARK AS SHOWN.

FOR DIETARY AND NUTRITIONAL SUPPLEMENTS; DIETARY FOOD SUPPLEMENTS; DIETARY SUPPLEMENTAL DRINKS; DIETARY SUPPLEMENTS; DIETARY SUPPLEMENTS FOR HUMAN CONSUMPTION; NUTRITIONAL SUPPLEMENTS; POWDERED NUTRITIONAL SUPPLEMENT DRINK MIX (U.S. CLS. 6, 18, 44, 46, 51 AND 52).

TRICIA SONNEBORN, EXAMINING ATTORNEY

SN 77-186,341. LOVELAND PRODUCTS, INC., GREELEY, CO. FILED 5-21-2007.

PIRANHA

THE MARK CONSISTS OF STANDARD CHARACTERS WITHOUT CLAIM TO ANY PARTICULAR FONT, STYLE, SIZE, OR COLOR.

FOR FUNGICIDES; HERBICIDES; PESTICIDES; INSECTICIDAL SEED PROTECTANT FOR AGRICULTURAL USE (U.S. CLS. 6, 18, 44, 46, 51 AND 52).

JENNIFER MARTIN, EXAMINING ATTORNEY

SN 77-188,814. REGENERATION TECHNOLOGIES, INC., ALACHUA, FL. FILED 5-23-2007.

BTB SELECT

THE MARK CONSISTS OF STANDARD CHARACTERS WITHOUT CLAIM TO ANY PARTICULAR FONT, STYLE, SIZE, OR COLOR.

NO CLAIM IS MADE TO THE EXCLUSIVE RIGHT TO USE "BTB", APART FROM THE MARK AS SHOWN.

FOR ALLOGRAFT SURGICAL IMPLANTS (U.S. CLS. 6, 18, 44, 46, 51 AND 52).

MELVIN AXILBUND, EXAMINING ATTORNEY

CLASS 5—(Continued).

SN 77-190,567. NEWCOM DESIGNS, LLC, DALLAS, TX. FILED 5-25-2007.

ECOMOSQUITO

THE MARK CONSISTS OF STANDARD CHARACTERS WITHOUT CLAIM TO ANY PARTICULAR FONT, STYLE, SIZE, OR COLOR.

FOR INSECT REPELLENT IN THE FORM OF NON-TOXIC AND/OR ORGANIC MATERIALS (U.S. CLS. 6, 18, 44, 46, 51 AND 52).

CHRISTINA SOBRAL, EXAMINING ATTORNEY

SN 77-197,828. BASF AKTIENGESELLSCHAFT, LUDWIGSHAFEN AM RHEIN, FED REP GERMANY, FILED 6-5-2007.

ALTREVIN

THE MARK CONSISTS OF STANDARD CHARACTERS WITHOUT CLAIM TO ANY PARTICULAR FONT, STYLE, SIZE, OR COLOR.

FOR PESTICIDES, NAMELY PREPARATIONS FOR DESTROYING VERMIN, FUNGICIDES, HERBICIDES, INSECTICIDES (U.S. CLS. 6, 18, 44, 46, 51 AND 52).

PAUL E. FAHRENKOPF, EXAMINING ATTORNEY

SN 77-198,065. BASF AKTIENGESELLSCHAFT, LUDWIGSHAFEN AM RHEIN, FED REP GERMANY, FILED 6-5-2007.

HYPNOS

THE MARK CONSISTS OF STANDARD CHARACTERS WITHOUT CLAIM TO ANY PARTICULAR FONT, STYLE, SIZE, OR COLOR.

FOR PESTICIDES, NAMELY PREPARATIONS FOR DESTROYING VERMIN, FUNGICIDES, HERBICIDES, INSECTICIDES (U.S. CLS. 6, 18, 44, 46, 51 AND 52).

PAUL E. FAHRENKOPF, EXAMINING ATTORNEY

CLASS 5—(Continued).

SN 77-198,875. MAXIMUM HUMAN PERFORMANCE, INC., FAIRFIELD, NJ. FILED 6-6-2007.

DREN

THE MARK CONSISTS OF STANDARD CHARACTERS WITHOUT CLAIM TO ANY PARTICULAR FONT, STYLE, SIZE, OR COLOR.

FOR DIETARY SUPPLEMENTS (U.S. CLS. 6, 18, 44, 46, 51 AND 52).

YAT SYE, LEE, EXAMINING ATTORNEY

SN 77-204,280. JARROW FORMULAS, INC., LOS ANGELES, CA. FILED 6-12-2007.

ADRENAL OPTIMIZER

THE MARK CONSISTS OF STANDARD CHARACTERS WITHOUT CLAIM TO ANY PARTICULAR FONT, STYLE, SIZE, OR COLOR.

NO CLAIM IS MADE TO THE EXCLUSIVE RIGHT TO USE "ADRENAL", APART FROM THE MARK AS SHOWN. FOR DIETARY AND NUTRITIONAL SUPPLEMENTS (U.S. CLS. 6, 18, 44, 46, 51 AND 52).

FIRST USE 1-22-2007; IN COMMERCE 1-22-2007.
MORENO, PAUL, EXAMINING ATTORNEY

SN 77-209,714. NUTRITION 21, INC., PURCHASE, NY. FILED 6-19-2007.

Diachrome

OWNER OF U.S. REG. NOS. 2,854,190 AND 2,948,444. THE MARK CONSISTS OF THE STYLIZED WORD DIACHROME WITH A UNIQUELY STYLIZED LETTER O. FOR DIETARY SUPPLEMENTS (U.S. CLS. 6, 18, 44, 46, 51 AND 52).

FIRST USE 8-0-2006; IN COMMERCE 8-0-2006.
KATHLEEN LORENZO, EXAMINING ATTORNEY

CLASS 5—(Continued).

SN 77-228,268. VITACOST.COM INC., DEERFIELD BEACH, FL. FILED 7-12-2007.



NO CLAIM IS MADE TO THE EXCLUSIVE RIGHT TO USE "NUTRACEUTICAL LIFE SCIENCES", APART FROM THE MARK AS SHOWN.

THE COLOR(S) LIGHT GREEN, DARK GREEN, AND WHITE IS/ARE CLAIMED AS A FEATURE OF THE MARK.

THE MARK CONSISTS OF A WHITE SUN AND RAY DESIGN IN A LIGHT GREEN SKY OVER A DARK GREEN PLANET WITH THE WORD "NUTRACEUTICAL" IN DARK GREEN AND THE WORDS "LIFE SCIENCES" IN LIGHT GREEN. THE MARK APPEARS ON A TRANSPARENT BACKGROUND AND NO OTHER COLORS ARE CLAIMED.

FOR DIETARY AND NUTRITIONAL SUPPLEMENTS (U.S. CLS. 6, 18, 44, 46, 51 AND 52).
JASON LOTT, EXAMINING ATTORNEY

SN 77-229,262. TRIVITA, INC., SCOTTSDALE, AZ. FILED 7-13-2007.

LEANOLOGY THE SMART WEIGHT LOSS SYSTEM

THE MARK CONSISTS OF STANDARD CHARACTERS WITHOUT CLAIM TO ANY PARTICULAR FONT, STYLE, SIZE, OR COLOR.

NO CLAIM IS MADE TO THE EXCLUSIVE RIGHT TO USE "WEIGHT LOSS SYSTEM", APART FROM THE MARK AS SHOWN.

FOR NUTRITIONAL SUPPLEMENTS (U.S. CLS. 6, 18, 44, 46, 51 AND 52).

JOHN HWANG, EXAMINING ATTORNEY

SN 77-229,271. TRIVITA, INC., SCOTTSDALE, AZ. FILED 7-13-2007.

THE SMART WEIGHT LOSS SYSTEM

THE MARK CONSISTS OF STANDARD CHARACTERS WITHOUT CLAIM TO ANY PARTICULAR FONT, STYLE, SIZE, OR COLOR.

NO CLAIM IS MADE TO THE EXCLUSIVE RIGHT TO USE "WEIGHT LOSS SYSTEM", APART FROM THE MARK AS SHOWN.

FOR NUTRITIONAL SUPPLEMENTS (U.S. CLS. 6, 18, 44, 46, 51 AND 52).

JOHN HWANG, EXAMINING ATTORNEY

CLASS 5—(Continued).

SN 77-238,426. GARDEN OF LIFE, INC., WEST PALM BEACH, FL. FILED 7-25-2007.

CLASS 5—(Continued).

SN 78-440,949. WINDOW ROCK ENTERPRISES, INC., BREA, CA. FILED 6-24-2004.

GREENTEIN

THE MARK CONSISTS OF STANDARD CHARACTERS WITHOUT CLAIM TO ANY PARTICULAR FONT, STYLE, SIZE, OR COLOR.
FOR POWDERED NUTRITIONAL SUPPLEMENT DRINK MIX (U.S. CLS. 6, 18, 44, 46, 51 AND 52).
TAMARA FRAZIER, EXAMINING ATTORNEY

CORTI SPORT

THE MARK CONSISTS OF STANDARD CHARACTERS WITHOUT CLAIM TO ANY PARTICULAR FONT, STYLE, SIZE, OR COLOR.
NO CLAIM IS MADE TO THE EXCLUSIVE RIGHT TO USE "SPORT", APART FROM THE MARK AS SHOWN.
FOR DIETARY SUPPLEMENTS (U.S. CLS. 6, 18, 44, 46, 51 AND 52).
NELSON SNYDER, EXAMINING ATTORNEY

SN 78-440,445. SMITHKLINE BEECHAM P.L.C., BRENTFORD, MIDDLESEX, UNITED KINGDOM, FILED 6-24-2004.

BRE-A-COL

THE MARK CONSISTS OF STANDARD CHARACTERS WITHOUT CLAIM TO ANY PARTICULAR FONT, STYLE, SIZE, OR COLOR.
FOR PHARMACEUTICAL PREPARATIONS, NAMELY, COLD AND COUGH MEDICATION (U.S. CLS. 6, 18, 44, 46, 51 AND 52).
TRACY WHITTAKER-BROWN, EXAMINING ATTORNEY

SN 78-508,322. AAIPHARMA, INC., WILMINGTON, NC. FILED 10-29-2004.

SN 78-440,943. WINDOW ROCK ENTERPRISES, INC., BREA, CA. FILED 6-24-2004.

LYNXORB

CORTISPORTS

THE MARK CONSISTS OF STANDARD CHARACTERS WITHOUT CLAIM TO ANY PARTICULAR FONT, STYLE, SIZE, OR COLOR.
FOR DIETARY SUPPLEMENTS (U.S. CLS. 6, 18, 44, 46, 51 AND 52).
NELSON SNYDER, EXAMINING ATTORNEY

THE MARK CONSISTS OF STANDARD CHARACTERS WITHOUT CLAIM TO ANY PARTICULAR FONT, STYLE, SIZE, OR COLOR.
FOR PHARMACEUTICAL PREPARATIONS FOR THE TREATMENT OF PAIN (U.S. CLS. 6, 18, 44, 46, 51 AND 52).
DORITT L. CARROLL, EXAMINING ATTORNEY

CLASS 5—(Continued).

SN 78-514,633. PICK INTERNATIONAL, INC., WICHITA FALLS, TX. FILED 11-10-2004.



NO CLAIM IS MADE TO THE EXCLUSIVE RIGHT TO USE "CPR PACK", APART FROM THE MARK AS SHOWN. THE MARK CONSISTS OF THE WORDING CPR PAK IN A RECTANGLE, WITH A HEART WITH A PULSE LINE THROUGH THE RIGHT SIDE OF THE HEART AND THREE SEPARATE ARROWS AROUND THE HEART.

FOR SANITARY PREPARATIONS FOR ADMINISTERING CPR (U.S. CLS. 6, 18, 44, 46, 51 AND 52).
ADA HAN, EXAMINING ATTORNEY

SN 78-715,050. MANNA OMNI INTERNATIONAL INC., FULLERTON, CA. FILED S.R. 9-16-2005; AM. P.R. 8-11-2007.

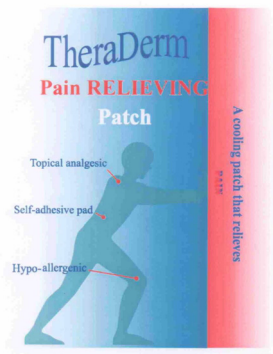

NO CLAIM IS MADE TO THE EXCLUSIVE RIGHT TO USE "PAIN RELIEVING PATCH", "TOPICAL ANALGESIC", "SELF-ADHESIVE PAD", "HYPO ALLERGENIC", "A COOLING PATCH THAT RELIEVES PAIN", APART FROM THE MARK AS SHOWN.

THE COLOR(S) RED, WHITE, AND BLUE IS/ARE CLAIMED AS A FEATURE OF THE MARK.

THE MARK CONSISTS OF THE COLOR RED IN THE WORDS "PAIN RELIEVING", THE TERM "PAIN", AND IN THREE STRAIGHT LINES THAT EACH HAVE A SMALL CIRCLE AT THE END; THE COLOR WHITE APPEARS IN THE WORD "PATCH"; THE COLOR BLUE APPEARS IN THE WORD "THERADERM", "TOPICAL ANALGESIC", "SELF-ADHESIVE PAD", "HYPO-ALLERGENIC", AND "PAIN RELIEF MEDICATION IN THE FORM OF A PATCH", AND IN THE HUMAN FIGURE; THE LITERAL AND HUMAN DESIGN ELEMENTS ARE SET AGAINST A RECTANGLE THAT IS BLUE WITH A RED BAND ON THE RIGHT HAND SIDE.

FOR PAIN RELIEF MEDICATION IN THE FORM OF A PATCH (U.S. CLS. 6, 18, 44, 46, 51 AND 52).
FIRST USE 12-1-2005; IN COMMERCE 12-1-2005.
TONI HICKEY, EXAMINING ATTORNEY

CLASS 5—(Continued).

SN 78-748,371. UNIVERSITY OF OTTAWA HEART INSTITUTE, OTTAWA, ONTARIO, CANADA, FILED 11-7-2005.

FlowTrace-Rb

THE MARK CONSISTS OF STANDARD CHARACTERS WITHOUT CLAIM TO ANY PARTICULAR FONT, STYLE, SIZE, OR COLOR.

PRIORITY CLAIMED UNDER SEC. 44(D) ON CANADA APPLICATION NO. 1,276,828, FILED 10-24-2005.

FOR DIAGNOSTIC RADIOPHARMACEUTICAL PREPARATION FOR POSITRON EMISSION TOMOGRAPHY (PET) TO IMAGE REGIONAL BLOOD FLOW DISTRIBUTION AND TO MEASURE BLOOD FLOW QUANTITATIVELY IN HUMANS (U.S. CLS. 6, 18, 44, 46, 51 AND 52).
JOHN HWANG, EXAMINING ATTORNEY

SN 78-778,499. PROTAFFIN BIOTECHNOLOGIE AG, 8020 GRAZ, AUSTRIA, FILED 12-21-2005.

CellJammer

PRIORITY CLAIMED UNDER SEC. 44(D) ON ERPNCMNTY TM OFC APPLICATION NO. 4505954, FILED 6-23-2005, REG. NO. 4505954, DATED 8-7-2006, EXPIRES 6-23-2015.

FOR PHARMACEUTICAL AND VETERINARY PREPARATIONS FOR THE TREATMENT OF INFLAMMATORY ILLNESSES, CHEMICAL PREPARATIONS FOR MEDICAL PURPOSES, SANITARY PREPARATIONS FOR MEDICAL PURPOSES, BIOPHARMACEUTICAL PREPARATIONS FOR USE IN HUMAN AND VETERINARY MEDICINE FOR THE TREATMENT OF INFLAMMATORY ILLNESSES, DIAGNOSTIC PREPARATIONS FOR MEDICAL PURPOSES, CHEMICAL REAGENTS FOR MEDICAL AND VETERINARY PURPOSES, CHEMICALS AND BIOLOGICAL SUBSTANCES FOR MEDICAL USE (U.S. CLS. 6, 18, 44, 46, 51 AND 52).

TINA L. SNAPP, EXAMINING ATTORNEY

CLASS 5—(Continued).

SN 78-824,375. ADVANCED MEDICAL OPTICS, INC., SANTA ANA, CA. FILED 2-27-2006.

BLINK GELTEARS

THE MARK CONSISTS OF STANDARD CHARACTERS WITHOUT CLAIM TO ANY PARTICULAR FONT, STYLE, SIZE, OR COLOR.

OWNER OF U.S. REG. NOS. 1,613,501 AND 3,272,572.

NO CLAIM IS MADE TO THE EXCLUSIVE RIGHT TO USE "GELTEARS", APART FROM THE MARK AS SHOWN.

FOR OPHTHALMIC FORMULATIONS, EYE CARE TREATMENTS AND PREPARATIONS, NAMELY, EYE DROPS; OPHTHALMIC LUBRICANT EYEDROPS; CONTACT LENS CARE PREPARATIONS, NAMELY, SOLUTIONS AND TABLETS FOR DISINFECTING, CLEANING, WETTING, CUSHIONING, SOAKING, STORING AND/OR RINSING CONTACT LENSES AND EYEDROPS AND FOR THE TREATMENT OF DRY EYE AND OCULAR IRRITATION (U.S. CLS. 6, 18, 44, 46, 51 AND 52).

ESTHER BELENKER, EXAMINING ATTORNEY

SN 78-826,133. IMPROVITA HEALTH PRODUCTS, INC., CLEVELAND, OH. FILED 3-1-2006.

GERM DEFENSE PM

THE MARK CONSISTS OF STANDARD CHARACTERS WITHOUT CLAIM TO ANY PARTICULAR FONT, STYLE, SIZE, OR COLOR.

OWNER OF U.S. REG. NO. 3,126,115.

NO CLAIM IS MADE TO THE EXCLUSIVE RIGHT TO USE "GERM" AND "PM", APART FROM THE MARK AS SHOWN.

FOR DIETARY SUPPLEMENTS (U.S. CLS. 6, 18, 44, 46, 51 AND 52).

SCOTT BALDWIN, EXAMINING ATTORNEY

SN 78-830,634. HEALTH STREAM, L.L.C., SANDY, UT. FILED 3-7-2006.

OXYGEN NUTRITION

THE MARK CONSISTS OF STANDARD CHARACTERS WITHOUT CLAIM TO ANY PARTICULAR FONT, STYLE, SIZE, OR COLOR.

OWNER OF U.S. REG. NOS. 2,693,288 AND 2,794,216.

NO CLAIM IS MADE TO THE EXCLUSIVE RIGHT TO USE "NUTRITION", APART FROM THE MARK AS SHOWN.

FOR NUTRITIONAL SUPPLEMENTS (U.S. CLS. 6, 18, 44, 46, 51 AND 52).

FIRST USE 3-1-2004; IN COMMERCE 3-1-2004.
BERYL GARDNER, EXAMINING ATTORNEY

CLASS 5—(Continued).

SN 78-845,052. ISS RESEARCH, LLC, CHARLOTTE, NC. FILED 3-24-2006.

SATUR8 RUSH

THE MARK CONSISTS OF STANDARD CHARACTERS WITHOUT CLAIM TO ANY PARTICULAR FONT, STYLE, SIZE, OR COLOR.

NO CLAIM IS MADE TO THE EXCLUSIVE RIGHT TO USE "SATURATE", APART FROM THE MARK AS SHOWN.

FOR NUTRITIONAL SUPPLEMENT FOR WEIGHT TRAINING (U.S. CLS. 6, 18, 44, 46, 51 AND 52).

RONALD MCMORROW, EXAMINING ATTORNEY

SN 78-893,375. COHEN, JEFFREY A., MARINA DEL REY, CA. FILED 5-25-2006.

SPORTS NUT

THE MARK CONSISTS OF STANDARD CHARACTERS WITHOUT CLAIM TO ANY PARTICULAR FONT, STYLE, SIZE, OR COLOR.

FOR NUTRITIONAL SUPPLEMENTS, DIETARY SUPPLEMENTS, VITAMIN SUPPLEMENTS, MINERAL SUPPLEMENTS, ANTIOXIDANT DIETARY SUPPLEMENTS, HERBAL SUPPLEMENTS, BOTANICAL SUPPLEMENTS, HOMEOPATHIC SUPPLEMENTS, NUTRACEUTICAL SUPPLEMENTS, FOOD SUPPLEMENTS, NUTRITIONAL ADDITIVES FOR USE AS DIETARY SUPPLEMENTS, DIETARY DRINK MIX FOR USE AS A MEAL REPLACEMENT; NUTRITIONAL SUPPLEMENTS AS AN INGREDIENT IN BEVERAGES; POWDERED NUTRITIONAL SUPPLEMENT DRINK MIX; VITAMIN SUPPLEMENT IN TABLET FORM FOR USE IN MAKING AN EFFERVESCENT BEVERAGE WHEN ADDED TO WATER; MEDICATED CHEWING GUM AND MINTS AS CARRIERS FOR NUTRITIONAL SUPPLEMENTS TO PROMOTE ENERGY AND ATHLETIC RECOVERY; NUTRITIONALLY FORTIFIED AND VITAMIN FORTIFIED BEVERAGES AND NUTRITIONALLY FORTIFIED AND VITAMIN ENRICHED WATER AS CARRIERS FOR NUTRITIONAL SUPPLEMENTS; NUTRITIONAL ENERGY BARS FOR USE AS A MEAL SUBSTITUTE AND FORTIFIED MEAL REPLACEMENT BARS, MEAL REPLACEMENT BARS CONTAINING NUTRITIONAL SUPPLEMENTS, BREATH FRESHENING CONFECTIONERY FOR MEDICAL PURPOSES, NAMELY, DISSOLVABLE BREATH STRIPS, BREATH MINTS, CANDY AND GUM USED FOR MEDICAL PURPOSES; MEDICINAL CREAMS FOR SKIN CARE, ANALGESIC BALM, MEDICATED AND VITAMIN FORTIFIED LOTIONS AS SUNSCREEN AND SUN PROTECTION, AND MEDICATED AND VITAMIN FORTIFIED LOTIONS AND BALM FOR SUNBURN, AND NUTRITIONAL SUPPLEMENTS AS A COMPONENT OF SKIN CREAM, LOTION, GEL, AND OIL; TRANSDERMAL PATCHES FOR USE IN THE TREATMENT OF MUSCULAR ACHE; NUTRITIONAL SUPPLEMENTS AS INGREDIENTS FOR COSMETICS (U.S. CLS. 6, 18, 44, 46, 51 AND 52).

FIRST USE 3-13-1996; IN COMMERCE 3-13-1996.
TIMOTHY FINNEGAN, EXAMINING ATTORNEY

CLASS 5—(Continued).

SN 78-923,151. SIVERD, MARK G., MADISONVILLE, LA.
FILED 7-5-2006.

Gluco Ret

THE MARK CONSISTS OF STANDARD CHARACTERS WITHOUT CLAIM TO ANY PARTICULAR FONT, STYLE, SIZE, OR COLOR.

NO CLAIM IS MADE TO THE EXCLUSIVE RIGHT TO USE "GLUCO", APART FROM THE MARK AS SHOWN.

FOR DIETARY AND NUTRITIONAL SUPPLEMENTS (U.S. CLS. 6, 18, 44, 46, 51 AND 52).

REBECCA GAN, EXAMINING ATTORNEY

SN 78-931,960. STRENGTH SYSTEMS USA, LLC, LARGO, FL. FILED 7-18-2006.

MUSCLE PRO

THE MARK CONSISTS OF STANDARD CHARACTERS WITHOUT CLAIM TO ANY PARTICULAR FONT, STYLE, SIZE, OR COLOR.

NO CLAIM IS MADE TO THE EXCLUSIVE RIGHT TO USE "MUSCLE", APART FROM THE MARK AS SHOWN.

FOR NUTRITIONAL SUPPLEMENTS, NAMELY, READY TO DRINK NUTRITIONALLY FORTIFIED PROTEIN BEVERAGES (U.S. CLS. 6, 18, 44, 46, 51 AND 52).

MICHAEL LEWIS, EXAMINING ATTORNEY

SN 78-957,689. ADVANTIS TECHNOLOGIES, INC., ALPHARETTA, GA. FILED 8-22-2006.

Harpoon

THE MARK CONSISTS OF STANDARD CHARACTERS WITHOUT CLAIM TO ANY PARTICULAR FONT, STYLE, SIZE, OR COLOR.

FOR AQUATIC HERBICIDES (U.S. CLS. 6, 18, 44, 46, 51 AND 52).

YAT SYE, LEE, EXAMINING ATTORNEY

CLASS 5—(Continued).

SN 78-961,752. MORENO/JOSE, TLAQUEPAQUE, MEXICO,
FILED 8-28-2006.

TUKARI

THE MARK CONSISTS OF STANDARD CHARACTERS WITHOUT CLAIM TO ANY PARTICULAR FONT, STYLE, SIZE, OR COLOR.

THE FOREIGN WORDING IN THE MARK TRANSLATES INTO ENGLISH AS HEALTH OR HEALTHY.

FOR COUGH SYRUPS; HERB TEAS FOR MEDICINAL PURPOSES; HERBAL PRODUCTS, NAMELY, AROMA THERAPY PACKS CONTAINING HERBS USED FOR AROMA THERAPY; MEDICINAL HERB EXTRACTS (U.S. CLS. 6, 18, 44, 46, 51 AND 52).

YAT SYE, LEE, EXAMINING ATTORNEY

SN 78-961,926. DRAGON HERBS CORPORATION, SANTA MONICA, CA. FILED 8-28-2006.



FOR HERB TEAS FOR MEDICINAL PURPOSES; HERBAL PRODUCTS, NAMELY HERBAL DROPS, EXTRACTS, PILLS, ESSENCES, CAPSULES, AND ELIXIERS FOR MEDICINAL USE; MEDICINAL HERB EXTRACTS; MEDICINAL HERBS IN DRIED OR PRESERVED FORM; GINSENG FOR MEDICINAL USE (U.S. CLS. 6, 18, 44, 46, 51 AND 52).

RAUL CORDOVA, EXAMINING ATTORNEY

SN 78-962,680. WARNER LAMBERT COMPANY LLC, MORRIS PLAINS, NJ. FILED 8-29-2006.

LICAPS

THE MARK CONSISTS OF STANDARD CHARACTERS WITHOUT CLAIM TO ANY PARTICULAR FONT, STYLE, SIZE, OR COLOR.

OWNER OF U.S. REG. NO. 1,408,173.

FOR EMPTY AND FILLED CAPSULES FOR PHARMACEUTICAL PRODUCTS, DIETARY AND NUTRITIONAL SUPPLEMENTS, HERBAL SUPPLEMENTS, VITAMINS AND MINERAL SUPPLEMENTS (U.S. CLS. 6, 18, 44, 46, 51 AND 52).

FIRST USE 12-26-2001; IN COMMERCE 12-26-2001.

PRISCILLA MILTON, EXAMINING ATTORNEY

CLASS 5—(Continued).

SN 78-962,685. WARNER LAMBERT COMPANY LLC, MORRIS PLAINS, NJ. FILED 8-29-2006.



OWNER OF U.S. REG. NO. 1,408,173.
FOR EMPTY AND FILLED CAPSULES FOR PHARMACEUTICAL PRODUCTS, DIETARY AND NUTRITIONAL SUPPLEMENTS, HERBAL SUPPLEMENTS, VITAMINS AND MINERAL SUPPLEMENTS (U.S. CLS. 6, 18, 44, 46, 51 AND 52).
FIRST USE 12-26-2001; IN COMMERCE 12-26-2001.
PRISCILLA MILTON, EXAMINING ATTORNEY

SN 78-969,124. BROOKSIDE AGRA, L.C., HIGHLAND, IL. FILED 9-7-2006.

AGFLU

THE MARK CONSISTS OF STANDARD CHARACTERS WITHOUT CLAIM TO ANY PARTICULAR FONT, STYLE, SIZE, OR COLOR.
FOR VETERINARY SANITIZER FOR THE PREVENTION OF AVIAN FLU IN ANIMALS (U.S. CLS. 6, 18, 44, 46, 51 AND 52).
FIRST USE 2-10-2006; IN COMMERCE 2-10-2006.
PAUL E. FAHRENKOPF, EXAMINING ATTORNEY

SN 78-969,676. DOW AGROSCIENCES LLC, INDIANAPOLIS, IN. FILED 9-8-2006.

SEQUOIA

THE MARK CONSISTS OF STANDARD CHARACTERS WITHOUT CLAIM TO ANY PARTICULAR FONT, STYLE, SIZE, OR COLOR.
FOR HERBICIDE FOR AGRICULTURAL USE ON GRASSLAND, PASTURE AND TURF (U.S. CLS. 6, 18, 44, 46, 51 AND 52).
AISHA CLARKE, EXAMINING ATTORNEY

CLASS 5—(Continued).

SN 78-970,289. BRENLIN, INC., LAGUNA HILLS, CA. FILED 9-8-2006.

FIRE & ICE

THE MARK CONSISTS OF STANDARD CHARACTERS WITHOUT CLAIM TO ANY PARTICULAR FONT, STYLE, SIZE, OR COLOR.
FOR LIQUID DIETARY SUPPLEMENT USED FOR THE ENHANCEMENT OF WEIGHT LOSS AND INCREASED ENERGY (U.S. CLS. 6, 18, 44, 46, 51 AND 52).
ALICE SUE CARRUTHERS, EXAMINING ATTORNEY

SN 78-971,113. VIRGINIA BIONUTRIENTS, LLC, GLEN ALLEN, VA. FILED 9-11-2006.

FUSER ENERGY MICRO-BAR

THE MARK CONSISTS OF STANDARD CHARACTERS WITHOUT CLAIM TO ANY PARTICULAR FONT, STYLE, SIZE, OR COLOR.
NO CLAIM IS MADE TO THE EXCLUSIVE RIGHT TO USE "ENERGY MICRO-BAR", APART FROM THE MARK AS SHOWN.
FOR NUTRITIONAL SUPPLEMENTS, HERBAL SUPPLEMENTS, VITAMIN SUPPLEMENTS, MINERAL SUPPLEMENTS, VITAMIN AND MINERAL SUPPLEMENTS, DIETARY SUPPLEMENTS, DIETARY FOOD SUPPLEMENTS, AND FOOD SUPPLEMENTS, ALL IN BAR FORM (U.S. CLS. 6, 18, 44, 46, 51 AND 52).
FIRST USE 7-11-2006; IN COMMERCE 7-11-2006.
JOHN DALIER, EXAMINING ATTORNEY

SN 78-971,335. DUSA PHARMACEUTICALS, INC., WILMINGTON, MA. FILED 9-11-2006.

ClindaReach

THE MARK CONSISTS OF STANDARD CHARACTERS WITHOUT CLAIM TO ANY PARTICULAR FONT, STYLE, SIZE, OR COLOR.
FOR PHARMACEUTICAL PREPARATION FOR TREATMENT OF SKIN AND ALLERGIC DISORDERS (U.S. CLS. 6, 18, 44, 46, 51 AND 52).
GEORGE LORENZO, EXAMINING ATTORNEY

CLASS 5—(Continued).

SN 78-971,387. WARNER-LAMBERT COMPANY LLC, MORRIS PLAINS, NJ. FILED 9-11-2006.

MEGAPRAX

THE MARK CONSISTS OF STANDARD CHARACTERS WITHOUT CLAIM TO ANY PARTICULAR FONT, STYLE, SIZE, OR COLOR.

FOR PHARMACEUTICAL PREPARATIONS FOR THE TREATMENT OF CARDIOVASCULAR DISEASE, CENTRAL NERVOUS SYSTEM DISEASES AND DISORDERS, NEUROLOGICAL AND NEUROPSYCHIATRIC DISORDERS, UROLOGICAL DISORDERS, UROGENITAL DISORDERS, GASTROINTESTINAL DISORDERS, MUSCULOSKELETAL DISORDERS, ALLERGIES, DIABETES, HYPERTENSION, ERECTILE DYSFUNCTION, SEXUAL DYSFUNCTION, STROKE, CANCER, MIGRAINES, PAIN, OBESITY, INFLAMMATION AND INFLAMMATORY DISEASES, RESPIRATORY DISEASES, INFECTIOUS DISEASES, IMMUNOLOGICAL DISORDERS, VIRAL DISORDERS, FUNGAL DISORDERS; PHARMACEUTICAL PREPARATIONS, NAMELY CHOLESTEROL REDUCTION PREPARATIONS, SMOKING CESSATION PREPARATIONS, DERMATOLOGICAL PREPARATIONS, OSTEOPOROSIS PREPARATIONS, OPHTHALMOLOGICAL PREPARATIONS, PREPARATIONS FOR THE TREATMENT OF HIV AND AIDS (U.S. CLS. 6, 18, 44, 46, 51 AND 52).

HOWARD B. LEVINE, EXAMINING ATTORNEY

CLASS 5—(Continued).

SN 78-972,483. VERTEX PHARMACEUTICALS INCORPORATED, CAMBRIDGE, MA. FILED 9-12-2006.

CESSARA

THE MARK CONSISTS OF STANDARD CHARACTERS WITHOUT CLAIM TO ANY PARTICULAR FONT, STYLE, SIZE, OR COLOR.

FOR PHARMACEUTICAL PREPARATIONS FOR THE TREATMENT OF VIRAL DISEASES, CANCER, CYSTIC FIBROSIS, AND INFLAMMATION (U.S. CLS. 6, 18, 44, 46, 51 AND 52).

ANTHONY RINKER, EXAMINING ATTORNEY

SN 78-972,487. VERTEX PHARMACEUTICALS INCORPORATED, CAMBRIDGE, MA. FILED 9-12-2006.

RAPCERO

THE MARK CONSISTS OF STANDARD CHARACTERS WITHOUT CLAIM TO ANY PARTICULAR FONT, STYLE, SIZE, OR COLOR.

FOR PHARMACEUTICAL PREPARATIONS FOR THE TREATMENT OF VIRAL DISEASES, CANCER, CYSTIC FIBROSIS, AND INFLAMMATION (U.S. CLS. 6, 18, 44, 46, 51 AND 52).

ANTHONY RINKER, EXAMINING ATTORNEY

SN 78-972,475. VERTEX PHARMACEUTICALS INCORPORATED, CAMBRIDGE, MA. FILED 9-12-2006.

HEPRADEL

THE MARK CONSISTS OF STANDARD CHARACTERS WITHOUT CLAIM TO ANY PARTICULAR FONT, STYLE, SIZE, OR COLOR.

FOR PHARMACEUTICAL PREPARATIONS FOR THE TREATMENT OF VIRAL DISEASES, CANCER, CYSTIC FIBROSIS, AND INFLAMMATION (U.S. CLS. 6, 18, 44, 46, 51 AND 52).

ANTHONY RINKER, EXAMINING ATTORNEY

SN 78-972,491. VERTEX PHARMACEUTICALS INCORPORATED, CAMBRIDGE, MA. FILED 9-12-2006.

VIRITAC

THE MARK CONSISTS OF STANDARD CHARACTERS WITHOUT CLAIM TO ANY PARTICULAR FONT, STYLE, SIZE, OR COLOR.

FOR PHARMACEUTICAL PREPARATIONS FOR THE TREATMENT OF VIRAL DISEASES, CANCER, CYSTIC FIBROSIS, AND INFLAMMATION (U.S. CLS. 6, 18, 44, 46, 51 AND 52).

ANTHONY RINKER, EXAMINING ATTORNEY

CLASS 5—(Continued).

SN 78-972,495. VERTEX PHARMACEUTICALS INCORPORATED, CAMBRIDGE, MA. FILED 9-12-2006.

VIREP

THE MARK CONSISTS OF STANDARD CHARACTERS WITHOUT CLAIM TO ANY PARTICULAR FONT, STYLE, SIZE, OR COLOR.

FOR PHARMACEUTICAL PREPARATIONS FOR THE TREATMENT OF VIRAL DISEASES, CANCER, CYSTIC FIBROSIS, AND INFLAMMATION (U.S. CLS. 6, 18, 44, 46, 51 AND 52).

ANTHONY RINKER, EXAMINING ATTORNEY

SN 78-972,505. VERTEX PHARMACEUTICALS INCORPORATED, CAMBRIDGE, MA. FILED 9-12-2006.

TEBRIVAN

THE MARK CONSISTS OF STANDARD CHARACTERS WITHOUT CLAIM TO ANY PARTICULAR FONT, STYLE, SIZE, OR COLOR.

FOR PHARMACEUTICAL PREPARATIONS FOR THE TREATMENT OF VIRAL DISEASES, CANCER, CYSTIC FIBROSIS, AND INFLAMMATION (U.S. CLS. 6, 18, 44, 46, 51 AND 52).

ANTHONY RINKER, EXAMINING ATTORNEY

SN 78-972,526. VERTEX PHARMACEUTICALS INCORPORATED, CAMBRIDGE, MA. FILED 9-12-2006.

CIVO

THE MARK CONSISTS OF STANDARD CHARACTERS WITHOUT CLAIM TO ANY PARTICULAR FONT, STYLE, SIZE, OR COLOR.

FOR PHARMACEUTICAL PREPARATIONS FOR THE TREATMENT OF VIRAL DISEASES, CANCER, CYSTIC FIBROSIS, AND INFLAMMATION (U.S. CLS. 6, 18, 44, 46, 51 AND 52).

ANTHONY RINKER, EXAMINING ATTORNEY

CLASS 5—(Continued).

SN 78-973,304. MT US TRADEMARK LTD., MISSISSAUGA, ONTARIO, CANADA, FILED 9-13-2006.

OWNER OF U.S. REG. NOS. 2,180,130, 2,917,257 AND 3,048,655.

FOR NUTRITIONAL SUPPLEMENTS; NUTRITIONAL SUPPLEMENTS INCLUSIVE OF VITAMINS AND FOODS WHICH ENHANCE STRENGTH, BODY AND MUSCLE MASS AND PHYSICAL ENDURANCE (U.S. CLS. 6, 18, 44, 46, 51 AND 52).

DOMINIC FATHY, EXAMINING ATTORNEY

SN 79-015,678. AXICORP GMBH, FED REP GERMANY, FILED 8-4-2005.

THE MARK CONSISTS OF STANDARD CHARACTERS WITHOUT CLAIM TO ANY PARTICULAR FONT, STYLE, SIZE, OR COLOR.

PRIORITY DATE OF 2-16-2005 IS CLAIMED.

OWNER OF INTERNATIONAL REGISTRATION 0863178 DATED 8-4-2005. EXPIRES 8-4-2015.

FOR PHARMACEUTICAL PREPARATIONS FOR THE TREATMENT OF CARDIOVASCULAR AND GASTRO-INTESTINAL DISEASES AS WELL AS METABOLIC DISEASES; ANALGESICS; ANTIBIOTICS; SANITARY PREPARATIONS FOR MEDICAL PURPOSES; DIETETIC FOODS ADAPTED FOR MEDICAL USE, FOOD FOR BABIES (U.S. CLS. 6, 18, 44, 46, 51 AND 52).

ERNEST SHOSHO, EXAMINING ATTORNEY

CLASS 5—(Continued).

SN 79-030,150. RAYMOND PERCY ARCHER, AUSTRALIA, AND JULIAN WAYNE ARCHER, AUSTRALIA, FILED 6-13-2006.

MEDI  LIVE

PRIORITY DATE OF 1-20-2006 IS CLAIMED.
OWNER OF INTERNATIONAL REGISTRATION 0901701 DATED 6-13-2006, EXPIRES 6-13-2016.

"THE PORTION OF THE MARK COMPRISED OF A CROSS DESIGN IS NOT DISPLAYED IN THE COLOR RED OR A COLORABLE LIMITATION THEREOF.

FOR DIETARY FOOD SUPPLEMENTS, WHICH USE SOLELY, OR AS AN INGREDIENT, OLIVE LEAF EXTRACTS AND BY-PRODUCTS AND COMPOUNDS FOUND WITHIN OLIVE LEAVES, OLIVE FRUIT AND OLIVE OIL; DIETARY SUPPLEMENTAL DRINKS, WHICH USE SOLELY, OR AS AN INGREDIENT, OLIVE LEAF EXTRACTS AND BY-PRODUCTS AND COMPOUNDS FOUND WITHIN OLIVE LEAVES, OLIVE FRUIT AND OLIVE OIL; MEDICATED SKIN CARE PREPARATIONS WHICH USE SOLELY, OR AS AN INGREDIENT, OLIVE LEAF EXTRACTS AND BY-PRODUCTS AND COMPOUNDS FOUND WITHIN OLIVE LEAVES, OLIVE FRUIT AND OLIVE OIL (U.S. CLS. 6, 18, 44, 46, 51 AND 52).

GILBERT SWIFT, EXAMINING ATTORNEY

SN 79-034,336. NYCOMED DANMARK APS, DENMARK, FILED 11-7-2006.

INSTANYL

THE MARK CONSISTS OF STANDARD CHARACTERS WITHOUT CLAIM TO ANY PARTICULAR FONT, STYLE, SIZE, OR COLOR.

PRIORITY DATE OF 5-9-2006 IS CLAIMED.
OWNER OF INTERNATIONAL REGISTRATION 0912755 DATED 11-7-2006, EXPIRES 11-7-2016.

FOR ANALGESIC PREPARATIONS (U.S. CLS. 6, 18, 44, 46, 51 AND 52).

SKYE YOUNG, EXAMINING ATTORNEY

SN 79-037,340. SMITHKLINE BEECHAM CORPORATION, PHILADELPHIA, PA. FILED 4-17-2007.

PREPSTEP

PRIORITY DATE OF 11-22-2006 IS CLAIMED.
OWNER OF INTERNATIONAL REGISTRATION 0911596 DATED 12-21-2006, EXPIRES 12-21-2016.

FOR PHARMACEUTICAL AND MEDICINAL PREPARATIONS AND SUBSTANCES FOR SMOKING CESSATION (U.S. CLS. 6, 18, 44, 46, 51 AND 52).

DAYNA BROWNE, EXAMINING ATTORNEY

CLASS 6—METAL GOODS

SN 76-667,604. BACJAC, INC., CHICAGO, IL. FILED 10-13-2006.

BikeDockeR

THE MARK CONSISTS OF STANDARD CHARACTERS WITHOUT CLAIM TO ANY PARTICULAR FONT, STYLE, SIZE, OR COLOR.

FOR METAL BRACKETS FOR MOUNTING RACKS, NAMELY, BICYCLE RACKS, GUN RACKS, EQUIPMENT RACKS AND SKI RACKS (U.S. CLS. 2, 12, 13, 14, 23, 25 AND 50).

SHARON MEIER, EXAMINING ATTORNEY

SN 77-095,210. AVIBANK MFG., INC., NORTH HOLLYWOOD, CA. FILED 1-30-2007.

E-NUT

THE MARK CONSISTS OF STANDARD CHARACTERS WITHOUT CLAIM TO ANY PARTICULAR FONT, STYLE, SIZE, OR COLOR.

FOR EXPANDABLE METAL FASTENERS, NAMELY, THREADED INSERTS (U.S. CLS. 2, 12, 13, 14, 23, 25 AND 50).

FIRST USE 10-11-2002; IN COMMERCE 10-11-2002.

ANDREW RHIM, EXAMINING ATTORNEY

SN 77-108,085. CREATIVE CONCEPTS INTERNATIONAL, LLC, LARKSPUR, CO. FILED 2-15-2007.

READY SET MOUNT

THE MARK CONSISTS OF STANDARD CHARACTERS WITHOUT CLAIM TO ANY PARTICULAR FONT, STYLE, SIZE, OR COLOR.

NO CLAIM IS MADE TO THE EXCLUSIVE RIGHT TO USE "MOUNT", APART FROM THE MARK AS SHOWN.

FOR METAL WALL MOUNTS FOR VISUAL MONITORS IN THE NATURE OF LCD AND PLASMA SCREEN TELEVISIONS (U.S. CLS. 2, 12, 13, 14, 23, 25 AND 50).

TONI HICKEY, EXAMINING ATTORNEY

CLASS 6—(Continued).

SN 77-149,430. MILWAUKEE VALVE COMPANY, INC., MILWAUKEE, WI. FILED 4-5-2007.

ULTRAPRESS

THE MARK CONSISTS OF STANDARD CHARACTERS WITHOUT CLAIM TO ANY PARTICULAR FONT, STYLE, SIZE, OR COLOR.

FOR MANUALLY OPERATED METAL VALVES, NAMELY, BALL VALVES, GATE VALVES, GLOBE VALVES, AND CHECK VALVES (U.S. CLS. 2, 12, 13, 14, 23, 25 AND 50).

BRIAN NEVILLE, EXAMINING ATTORNEY

CLASS 6—(Continued).

SN 77-161,233. FAST MASTER, INC., HOUSTON, TX. FILED 4-19-2007.

CCD

THE MARK CONSISTS OF STANDARD CHARACTERS WITHOUT CLAIM TO ANY PARTICULAR FONT, STYLE, SIZE, OR COLOR.

FOR METAL FASTENERS, NAMELY, STUDS, AND THREADED RODS (U.S. CLS. 2, 12, 13, 14, 23, 25 AND 50).

CURTIS FRENCH, EXAMINING ATTORNEY

SN 77-161,263. O'KEEFE'S, INC., SAN FRANCISCO, CA. FILED 4-19-2007.

SAFTIFIRE

THE MARK CONSISTS OF STANDARD CHARACTERS WITHOUT CLAIM TO ANY PARTICULAR FONT, STYLE, SIZE, OR COLOR.

OWNER OF U.S. REG. NOS. 2,089,494, 3,159,420 AND OTHERS.

FOR FIRE AND SAFETY RATED PANEL SYSTEMS COMPRISED PRIMARILY OF METAL GOODS AND CONSISTING OF WALL PANELS, WINDOWS, AND DOORS, ALL SOLD AS A UNIT (U.S. CLS. 2, 12, 13, 14, 23, 25 AND 50).

MICHAEL WEBSTER, EXAMINING ATTORNEY

SN 77-163,244. ILLINOIS TOOL WORKS INC., GLENVIEW, IL. FILED 4-23-2007.

SN 77-156,396. TOWNSTEEL, INC., COVINA, CA. FILED 4-13-2007.

Rejuvenator

THE MARK CONSISTS OF STANDARD CHARACTERS WITHOUT CLAIM TO ANY PARTICULAR FONT, STYLE, SIZE, OR COLOR.

FOR METAL DOOR LOCKS, METAL DOOR LEVER HANDLES, METAL DOOR KNOBS, AND PARTS THEREOF MADE PRIMARILY OF METAL PARTS (U.S. CLS. 2, 12, 13, 14, 23, 25 AND 50).

KRISTINA MORRIS, EXAMINING ATTORNEY

SN 77-158,568. WILSON WALTON INTERNATIONAL, INC., WALL, NJ. FILED 4-17-2007.

ALOLINE

THE MARK CONSISTS OF STANDARD CHARACTERS WITHOUT CLAIM TO ANY PARTICULAR FONT, STYLE, SIZE, OR COLOR.

FOR METAL ALLOY FOR USE IN CATHODIC PROTECTION SYSTEMS (U.S. CLS. 2, 12, 13, 14, 23, 25 AND 50).

FIRST USE 2-28-1962; IN COMMERCE 2-28-1962. MIDGE BUTLER, EXAMINING ATTORNEY



THE MARK CONSISTS OF A UNIQUE STYLIZED DEPICTION OF THE LETTER P.

FOR METAL FASTENERS, NAMELY, SCREWS AND BOLTS (U.S. CLS. 2, 12, 13, 14, 23, 25 AND 50).

FIRST USE 1-1-1958; IN COMMERCE 1-1-1958. MICHAEL SOUDERS, EXAMINING ATTORNEY

CLASS 6—(Continued).

SN 77-165,493. TELEBRANDS CORPORATION, FAIRFIELD, NJ. FILED 4-25-2007.

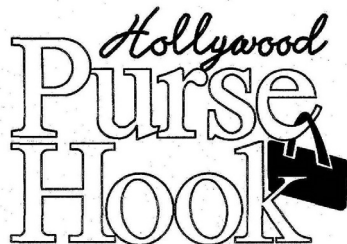

NO CLAIM IS MADE TO THE EXCLUSIVE RIGHT TO USE "PURSE HOOK", APART FROM THE MARK AS SHOWN.

"THE MARK CONSISTS OF THE WORDING "HOLLYWOOD PURSE HOOK" AND A DESIGN OF A PURSE HANGING FROM THE "E" IN "PURSE."

FOR HANGING DEVICE, NAMELY, METAL HOOK, FOR HAND BAGS, PURSES, LAPTOP BAGS, SHOPPING BAGS, THAT ALLOWS THE USER TO HANG THE BAG ON THE EDGE OF A TABLE OR THE BACK OF A CHAIR (U.S. CLS. 2, 12, 13, 14, 23, 25 AND 50).

CORY BOONE, EXAMINING ATTORNEY

CLASS 6—(Continued).

SN 78-476,775. ZIGONG CEMENTED CARBIDE CORP., LTD., ZIGONG CITY, CHINA, FILED 8-31-2004.



THE FOREIGN WORDING IN THE MARK TRANSLATES INTO ENGLISH AS LONG CITY.

THE NON-LATIN CHARACTER(S) IN THE MARK TRANSLITERATES INTO ZHANG CHENG, AND THIS MEANS LONG CITY IN ENGLISH.

FOR MOLYBDENUM BONDED WITH OTHER METALS IN THE FORM OF SHEETS, PLATES AND FOILS FOR FURTHER MANUFACTURE; TUNGSTEN BONDED WITH OTHER METALS IN THE FORM OF SHEETS, PLATES AND FOILS FOR FURTHER MANUFACTURE (U.S. CLS. 2, 12, 13, 14, 23, 25 AND 50).

FIRST USE 10-10-1972; IN COMMERCE 5-6-1978.

NORA BUCHANAN WILL, EXAMINING ATTORNEY

SN 77-184,390. STEP 'N WASH, INC., DUNWOODY, GA. FILED 5-18-2007.



THE COLOR(S) GREEN, ORANGE, AND BLUE IS/ARE CLAIMED AS A FEATURE OF THE MARK.

THE WORD STEP IS GREEN. THE SMALL GIRL IS OUTLINED IN ORANGE AND FILLED IN WHITE. THE APOSTROPHE AND LETTER "N" APPEAR IN WHITE. THE RECTANGLE IS ORANGE. THE WORD WASH IS BLUE. THE MARK APPEARS ON A TRANSPARENT BACKGROUND, AND NO OTHER COLOR IS CLAIMED AS A FEATURE OF THE MARK.

FOR METAL STEP STOOLS (U.S. CLS. 2, 12, 13, 14, 23, 25 AND 50).

FIRST USE 6-20-2005; IN COMMERCE 12-15-2005.

DAVID MILLER, EXAMINING ATTORNEY

SN 78-827,226. LARSEN & SHAW LIMITED, WALKERTON, CANADA, FILED 3-2-2006.

THE HINGE PEOPLE

THE MARK CONSISTS OF STANDARD CHARACTERS WITHOUT CLAIM TO ANY PARTICULAR FONT, STYLE, SIZE, OR COLOR.

PRIORITY CLAIMED UNDER SEC. 44(D) ON CANADA APPLICATION NO. 1291578, FILED 2-27-2006, REG. NO. TMA682536, DATED 2-27-2007, EXPIRES 2-27-2022.

NO CLAIM IS MADE TO THE EXCLUSIVE RIGHT TO USE "HINGE", APART FROM THE MARK AS SHOWN.

FOR HARDWARE, NAMELY, METAL HINGES (U.S. CLS. 2, 12, 13, 14, 23, 25 AND 50).

WILLIAM VERHOSEK, EXAMINING ATTORNEY

CLASS 6—(Continued).

SN 78-870,241. NICHIIHA CORPORATION, NAGOYA-SHI, JAPAN, FILED 4-26-2006.



OWNER OF U.S. REG. NOS. 2,307,765 AND 2,503,376.
THE MARK CONSISTS OF IN PART OF THE LETTER "N" IN STYLIZED FORM.

FOR METAL BUILDING MATERIALS, NAMELY, J-CHANNELS, FLASHINGS, MOLDINGS FOR WINDOWS AND MODESTY PANELS FOR USED WITH RESIDENTIAL/COMMERCIAL BUILDINGS; AND METAL HARDWARE, NAMELY, FASTENING MEMBERS FOR USE WITH RESIDENTIAL/COMMERCIAL BUILDINGS (U.S. CLS. 2, 12, 13, 14, 23, 25 AND 50).

MONIQUE MILLER, EXAMINING ATTORNEY

SN 78-903,031. TOTAL MACHINING TECHNOLOGY, L.L.C., TUCSON, AZ. FILED 6-7-2006.

CONVERT-A-TIE

FOR METAL VEHICLE TIE-DOWN DEVICE FOR USE WITH TIE-DOWN STRAPS (U.S. CLS. 2, 12, 13, 14, 23, 25 AND 50).

DOMINIC FATHY, EXAMINING ATTORNEY

SN 78-952,454. FRANKLIN INDUSTRIES, LLC, BROOKLYN, NY. FILED 8-15-2006.

MAGIC HOLD

THE MARK CONSISTS OF STANDARD CHARACTERS WITHOUT CLAIM TO ANY PARTICULAR FONT, STYLE, SIZE, OR COLOR.

NO CLAIM IS MADE TO THE EXCLUSIVE RIGHT TO USE "HOLD", APART FROM THE MARK AS SHOWN.

FOR METAL MAGNETIC CATCHES FOR ICE BINS (U.S. CLS. 2, 12, 13, 14, 23, 25 AND 50).

MICHELLE DUBOIS, EXAMINING ATTORNEY

CLASS 6—(Continued).

SN 79-036,081. NORTHEAST LIGHT ALLOY CO., LTD., HARBIN, HEILONGJIANG, CHINA, FILED 2-13-2007.



OWNER OF INTERNATIONAL REGISTRATION 0917651 DATED 2-13-2007, EXPIRES 2-13-2017.

THE MARK CONSISTS OF TWO CHINESE CHARACTERS AND A LOGO.

THE TWO CHINESE CHARACTERS APPEARING IN THE MARK MEAN "EAST" AND "LIGHT" RESPECTIVELY.

THE TRANSLITERATION OF THE NON-LATIN CHARACTERS IN THE MARK IS: DONG QING.

FOR ALUMINIUM ALLOY PLATE; ALUMINIUM ALLOY WIRE; DOORS AND WINDOWS OF ALUMINIUM ALLOY; ALUMINIUM ALLOY BAR; MATERIAL OF ALUMINIUM ALLOY FOR RAILWAY CONSTRUCTION (U.S. CLS. 2, 12, 13, 14, 23, 25 AND 50).

CURTIS FRENCH, EXAMINING ATTORNEY

CLASS 7—MACHINERY

SN 76-665,159. RON TAI IRON FACTORY, TAICHUNG CITY, TAIWAN, FILED 8-24-2006.

Bacca

THE ENGLISH TRANSLATION OF THE WORD BACCA IN THE MARK IS BERRY.

FOR MOTORS, NAMELY, ELECTRIC STARTER MOTORS, ELEVATOR MOTORS, LINEAR MOTORS, STARTER MOTORS; MACHINE PARTS, NAMELY, CONTROLLED DECELERATORS FOR STOPPING MOVING PARTS OF INDUSTRIAL MACHINERY AND ABSORBING THE KINETIC ENERGY OF THE PARTS; POWER-OPERATED BLOWERS (U.S. CLS. 13, 19, 21, 23, 31, 34 AND 35).

DARRYL SPRUILL, EXAMINING ATTORNEY

SN 76-676,997. HOLLEY PERFORMANCE PRODUCTS, INC., BOWLING GREEN, KY. FILED 5-17-2007.

STREET WARRIOR

THE MARK CONSISTS OF STANDARD CHARACTERS WITHOUT CLAIM TO ANY PARTICULAR FONT, STYLE, SIZE, OR COLOR.

FOR INTAKE MANIFOLDS FOR LAND VEHICLE INTERNAL COMBUSTION ENGINES (U.S. CLS. 13, 19, 21, 23, 31, 34 AND 35).

LINDA M. KING, EXAMINING ATTORNEY

CLASS 7—(Continued).

SN 76-677,011. HOLLEY PERFORMANCE PRODUCTS, INC., BOWLING GREEN, KY. FILED 5-17-2007.

TRACK WARRIOR

THE MARK CONSISTS OF STANDARD CHARACTERS WITHOUT CLAIM TO ANY PARTICULAR FONT, STYLE, SIZE, OR COLOR.

FOR INTAKE MANIFOLDS FOR LAND VEHICLE INTERNAL COMBUSTION ENGINES (U.S. CLS. 13, 19, 21, 23, 31, 34 AND 35).

LINDA M. KING, EXAMINING ATTORNEY

SN 77-042,024. RIDGID, INC., NEWARK, DE. FILED 11-11-2006.

RIDGID

THE MARK CONSISTS OF STANDARD CHARACTERS WITHOUT CLAIM TO ANY PARTICULAR FONT, STYLE, SIZE, OR COLOR.

OWNER OF U.S. REG. NOS. 2,420,485, 2,681,242 AND OTHERS.

FOR POWER TOOLS, NAMELY, POWER-OPERATED SAWS; ELECTRIC CORE DRILLS; ELECTRIC MOTORS FOR MACHINES AND REPLACEMENTS PARTS THEREFOR; POWER TOOLS, NAMELY, DRILL PRESSES AND DRILLS, AND DRILL BITS THEREFOR; ELECTRIC DRILLS AND CORDLESS ELECTRIC DRILLS; ELECTRIC GENERATORS; POWER TOOLS, NAMELY, JOINTERS, REAMERS, PLANERS, LATHES, GRINDERS, SANDERS, ROUTERS, AND REPLACEMENTS THEREFOR; GAS-OPERATED SOLDERING IRONS; POWER OPERATED SEWER AND DRAIN CLEANING MACHINES AND REPLACEMENT PARTS THEREFOR; MACHINES, NAMELY, AUTOMATIC CABLE FEEDERS; PIPE BENDING MACHINES; PIPE THREADING MACHINES; POWER TOOLS, NAMELY, AUTOMATIC PIPE CUTTERS; CORE DRILLING MACHINES AND REPLACEMENT PARTS THEREFOR; POWER OPERATED COPPER CUTTING PREP MACHINES; ELECTRIC PUMPS FOR USE IN TESTING PRESSURE; POWER OPERATED TAPPING MACHINES; PIPE ROLL GROOVING MACHINES AND SUPPORT STANDS THEREFOR; GROOVING MACHINES; CIRCULAR SAWS; PIPE AND BOLT THREADING MACHINES; PIPE AND ROD ROTATING MACHINES; TORCH KITS FOR SOLDERING AND BRAZING COMPRISED OF GAS-OPERATED SOLDERING IRONS AND REPLACEMENTS PARTS THEREFOR; POWER OPERATED INDUSTRIAL MACHINE PRESSES; HYDRAULIC ROLL GROOVING MACHINES; AIR FILTERS FOR MECHANICAL PURPOSES; HYDRAULIC PRESSES; VACUUM CLEANERS AND VACUUM CLEANER ACCESSORIES, NAMELY, VACUUM CLEANER FILTERS, BAGS, HOSES AND REPLACEMENT PARTS FOR VACUUM CLEANERS; POWER-OPERATED PRESSING AND CRIMPING TOOLS USED FOR SECURING CONNECTIONS ON PIPES AND TUBING, AND PARTS THEREFOR; CLEANING AND CLEARING WATER JETTERS, NAMELY, WATER JETS FOR REMOVING MATERIALS FROM ALL TYPES OF DRAINS AND PARTS THEREFOR (U.S. CLS. 13, 19, 21, 23, 31, 34 AND 35).

FIRST USE 6-13-1945; IN COMMERCE 6-13-1945.

GEORGE LORENZO, EXAMINING ATTORNEY

CLASS 7—(Continued).

SN 77-046,824. OPEX CORPORATION, MOORESTOWN, NJ. FILED 11-17-2006.

OPEX

THE MARK CONSISTS OF STANDARD CHARACTERS WITHOUT CLAIM TO ANY PARTICULAR FONT, STYLE, SIZE, OR COLOR.

OWNER OF U.S. REG. NO. 1,010,123.

FOR DOCUMENT PROCESSING MACHINES, NAMELY, MAIL OPENING MACHINES AND MACHINES FOR EXTRACTING DOCUMENTS FROM MAIL, EACH HAVING OPTICAL IMAGING APPARATUS FOR SCANNING DOCUMENTS TO OBTAIN IMAGES AND ELECTRONICALLY TRANSMIT THE IMAGES TO COMPUTER TERMINALS OR DATA STORAGE DEVICES (U.S. CLS. 13, 19, 21, 23, 31, 34 AND 35).

FIRST USE 8-31-1997; IN COMMERCE 8-31-1997.

JOHN KELLY, EXAMINING ATTORNEY

SN 77-058,675. CIXI HUILI MACHINERY & ELECTRIC CO., LTD., ZHEJIANG PROVINCE, CHINA, FILED 12-7-2006.

WAYLEAD

FOR AGRICULTURAL MACHINES, NAMELY, CULTIVATORS, HARVESTORS, DISK HARROWS, SEEDERS; SANDING MACHINES FOR WOODWORKING; PAPER MAKING MACHINES; LABEL PRINTING MACHINE; PLANOGRAPHIC PRINTING MACHINES; FOOD PREPARATION MACHINES, NAMELY, ELECTRIC FOOD CHOPPERS, BLENDERS, AND SLICERS; ELECTRIC FOOD PREPARATION APPARATUS, NAMELY, TUMBLERS FOR MARINATING FOOD; PACKING MACHINES; ELECTRIC FOOD PROCESSORS; CLOTHES WASHING MACHINES; EMBOSSING MACHINES; RAILROAD CONSTRUCTING MACHINES, NAMELY, COMBINATION WINCH AND BUMPERS, FAIRLEADS, AND HIGHWAY GUARDRAIL POST DRIVERS; ELEVATING WORK PLATFORM; FOUNDRY MACHINES, NAMELY, CASTING MACHINES; FOUNDRY MACHINES, NAMELY MOLDING MACHINES; SPARK PLUGS; HYDRAULIC ENGINES AND MOTORS FOR MACHINES; ENGINE PARTS, NAMELY, IGNITING MAGNETOS FOR INTERNAL COMBUSTION ENGINES; ELECTRIC GENERATORS; STATORS BEING PARTS OF MACHINES FOR MOTORS; PISTONS FOR MACHINES OR GENERATORS; ELECTRIC MOTORS FOR MACHINES; MACHINES, NAMELY, VACUUM PUMPS; VALVES FOR PUMPS; COMPRESSORS FOR MACHINES; SHAFT COUPLINGS FOR MACHINES; AXLES FOR MACHINES; MACHINE PARTS NAMELY, BEARINGS; VACUUM CLEANERS; POWER-OPERATED TOOLS, NAMELY, GRINDERS (U.S. CLS. 13, 19, 21, 23, 31, 34 AND 35).

STANLEY I. OSBORNE, EXAMINING ATTORNEY

CLASS 7—(Continued).

SN 77-078,815. KEYSTONE INDUSTRIES, INC., WINDER, GA. FILED 1-9-2007.

MELT MATE

THE MARK CONSISTS OF STANDARD CHARACTERS WITHOUT CLAIM TO ANY PARTICULAR FONT, STYLE, SIZE, OR COLOR.

NO CLAIM IS MADE TO THE EXCLUSIVE RIGHT TO USE "MELT", APART FROM THE MARK AS SHOWN.

FOR HOT MELT ADHESIVE DISPENSER (U.S. CLS. 13, 19, 21, 23, 31, 34 AND 35).

FLORENTINA BLANDU, EXAMINING ATTORNEY

CLASS 7—(Continued).

SN 77-149,148. COBCO MANUFACTURING, INC., NEBRASKA CITY, NE. FILED 4-5-2007.

TOPTANK

THE MARK CONSISTS OF STANDARD CHARACTERS WITHOUT CLAIM TO ANY PARTICULAR FONT, STYLE, SIZE, OR COLOR.

FOR AGRICULTURAL MACHINERY AND PARTS THEREFOR, NAMELY HARVESTERS, THRESHERS, COMBINES AND CORN PICKERS (U.S. CLS. 13, 19, 21, 23, 31, 34 AND 35).

WILLIAM ROSSMAN, EXAMINING ATTORNEY

SN 77-113,556. SAFETY-KLEEN SYSTEMS, INC., PLANO, TX. FILED 2-22-2007.

INSTANT KLEEN

THE MARK CONSISTS OF STANDARD CHARACTERS WITHOUT CLAIM TO ANY PARTICULAR FONT, STYLE, SIZE, OR COLOR.

NO CLAIM IS MADE TO THE EXCLUSIVE RIGHT TO USE "CLEAN", APART FROM THE MARK AS SHOWN.

FOR PAINT SPRAY GUN CLEANING MACHINE (U.S. CLS. 13, 19, 21, 23, 31, 34 AND 35).

APRIL ROACH, EXAMINING ATTORNEY

SN 77-150,323. USA SOLAR & WIND INC, TALLAHASSEE FLORIDA, FL. FILED 4-6-2007.

USA Solar

THE MARK CONSISTS OF STANDARD CHARACTERS WITHOUT CLAIM TO ANY PARTICULAR FONT, STYLE, SIZE, OR COLOR.

NO CLAIM IS MADE TO THE EXCLUSIVE RIGHT TO USE "SOLAR", APART FROM THE MARK AS SHOWN.

SEC. 2(F).
FOR SOLAR-POWERED ELECTRICITY GENERATORS (U.S. CLS. 13, 19, 21, 23, 31, 34 AND 35).

FIRST USE 12-1-2001; IN COMMERCE 12-2-2001.

TINA BROWN, EXAMINING ATTORNEY

SN 77-129,292. SOUTHCO, INC., CONCORDVILLE, PA. FILED 3-13-2007.

WISE ACTION

THE MARK CONSISTS OF STANDARD CHARACTERS WITHOUT CLAIM TO ANY PARTICULAR FONT, STYLE, SIZE, OR COLOR.

NO CLAIM IS MADE TO THE EXCLUSIVE RIGHT TO USE "WISE", APART FROM THE MARK AS SHOWN.

FOR METAL LATCHES (U.S. CLS. 13, 19, 21, 23, 31, 34 AND 35).

FIRST USE 11-15-1984; IN COMMERCE 11-15-1984.

WILLIAM P. SHANAHAN, EXAMINING ATTORNEY

SN 77-151,712. SHIN, JAE OK, HOUSTON, TX. FILED 4-9-2007.

JMC

THE MARK CONSISTS OF STANDARD CHARACTERS WITHOUT CLAIM TO ANY PARTICULAR FONT, STYLE, SIZE, OR COLOR.

FOR BALL VALVES BEING PARTS OF MACHINES (U.S. CLS. 13, 19, 21, 23, 31, 34 AND 35).

B. PARADEWELAI, EXAMINING ATTORNEY

CLASS 7—(Continued).

SN 77-153,916. SY KESSLER SALES, INC., DALLAS, TX. FILED 4-11-2007.

GEMORO ULTRA STEAM

THE MARK CONSISTS OF STANDARD CHARACTERS WITHOUT CLAIM TO ANY PARTICULAR FONT, STYLE, SIZE, OR COLOR.

OWNER OF U.S. REG. NO. 2,856,502.

NO CLAIM IS MADE TO THE EXCLUSIVE RIGHT TO USE "STEAM", APART FROM THE MARK AS SHOWN.

FOR MACHINES THAT USE STEAM AND ULTRASONIC WAVES FOR CLEANING JEWELRY (U.S. CLS. 13, 19, 21, 23, 31, 34 AND 35).

MORENO, PAUL, EXAMINING ATTORNEY

CLASS 7—(Continued).

SN 77-157,633. ILLINOIS TOOL WORKS INC., GLENVIEW, IL. FILED 4-16-2007.

SMARTSTREAM

THE MARK CONSISTS OF STANDARD CHARACTERS WITHOUT CLAIM TO ANY PARTICULAR FONT, STYLE, SIZE, OR COLOR.

FOR NON-CONTACT POSITIVE DISPLACEMENT PUMP FOR DISPENSING A VARIETY OF MATERIALS INCLUDING SOLDER PASTE, ADHESIVES, FLUXES, UNDERFILLS, ENCAPSULANTS AND CONDUCTIVE EPOXIES TO CIRCUIT BOARDS AND OTHER ELECTRONIC SUBSTRATES FOR SURFACE MOUNT ASSEMBLY AND SEMICONDUCTOR PACKAGING APPLICATIONS (U.S. CLS. 13, 19, 21, 23, 31, 34 AND 35).

MICHAEL SOUDERS, EXAMINING ATTORNEY

SN 77-158,197. KENNAMETAL INC., LATROBE, PA. FILED 4-17-2007.

ROAD RAZOR

THE MARK CONSISTS OF STANDARD CHARACTERS WITHOUT CLAIM TO ANY PARTICULAR FONT, STYLE, SIZE, OR COLOR.

FOR MACHINE PARTS, NAMELY, BITS AND BIT HOLDERS FOR USE IN POWER OPERATED CONSTRUCTION MACHINES (U.S. CLS. 13, 19, 21, 23, 31, 34 AND 35).

FIRST USE 3-20-2007; IN COMMERCE 3-20-2007.

NAKWAMA ANKRAH, EXAMINING ATTORNEY

SN 77-159,762. ORBITFORM GROUP, JACKSON, MI. FILED 4-18-2007.



TransVision

FOR CHAINS, SPROCKETS, PLATEWHEELS, COUPLINGS, PULLEYS, BELTS, SHAFTS, GEARS, ALL FOR MECHANICAL TRANSMISSION PARTS USED IN INDUSTRIAL MACHINES (U.S. CLS. 13, 19, 21, 23, 31, 34 AND 35).

FIRST USE 0-0-2005; IN COMMERCE 0-0-2007.

SOPHIA S. KIM, EXAMINING ATTORNEY

THE MARK CONSISTS OF STANDARD CHARACTERS WITHOUT CLAIM TO ANY PARTICULAR FONT, STYLE, SIZE, OR COLOR.

FOR MACHINES AND MACHINE TOOLS FOR THE CUTTING AND FORMING OF MATERIALS (U.S. CLS. 13, 19, 21, 23, 31, 34 AND 35).

TASHIA BUNCH, EXAMINING ATTORNEY

Rollerform

CLASS 7—(Continued).

SN 77-159,783. KEENCO INDUSTRIAL CO., LTD, TAI-CHUNG COUNTY, TAIWAN, FILED 4-18-2007.



FOR ELECTRIC HAMMERS; PNEUMATIC HAMMERS; POWER-OPERATED SCREWDRIVERS; AIR-OPERATED POWER TOOLS, NAMELY, WRENCHES; ELECTRIC CHAIN SAWS; ELECTRIC HAND-HELD DRILLS; ELECTRIC SHEARING MACHINES; PNEUMATIC SHEARS; PNEUMATIC DRILLS; ELECTRIC SCISSORS; ELECTRIC GLUE GUNS; POWER-OPERATED NAILING GUNS; POWER-OPERATED RIVET GUNS; POWER-OPERATED SPRAY GUNS; POWER-OPERATED STAPLE GUNS (U.S. CLS. 13, 19, 21, 23, 31, 34 AND 35).

LINDSEY RUBIN, EXAMINING ATTORNEY

SN 77-159,820. THE DARIEN GROUP, INC., DARIEN CENTER, NY. FILED 4-18-2007.

HEDGIVORE

THE MARK CONSISTS OF STANDARD CHARACTERS WITHOUT CLAIM TO ANY PARTICULAR FONT, STYLE, SIZE, OR COLOR.

FOR POWER-OPERATED ROTARY HEDGE TRIMMERS (U.S. CLS. 13, 19, 21, 23, 31, 34 AND 35).

KAREN BRACEY, EXAMINING ATTORNEY

SN 77-159,856. THE DARIEN GROUP, INC., DARIEN CENTER, NY. FILED 4-18-2007.



NO CLAIM IS MADE TO THE EXCLUSIVE RIGHT TO USE "YARD TRIMMER", APART FROM THE MARK AS SHOWN.

THE MARK CONSISTS OF A SWIRLING CARNIVOROUS-LOOKING HEDGE HOG ADJACENT THE LITERAL ELEMENT OF THE MARK.

FOR POWER-OPERATED ROTARY HEDGE TRIMMERS (U.S. CLS. 13, 19, 21, 23, 31, 34 AND 35).

KAREN BRACEY, EXAMINING ATTORNEY

CLASS 7—(Continued).

SN 77-160,030. NAP TOOLS LLC, JASPER, IN. FILED 4-18-2007.



OWNER OF U.S. REG. NO. 3,023,357.
FOR POWER MACHINE TOOLS FOR THE CUTTING OF MATERIALS (U.S. CLS. 13, 19, 21, 23, 31, 34 AND 35).
FIRST USE 3-22-2007; IN COMMERCE 3-22-2007.
ELLEN B. AWRICH, EXAMINING ATTORNEY

SN 77-160,050. NAP TOOLS LLC, JASPER, IN. FILED 4-18-2007.

NAP GLADU

THE MARK CONSISTS OF STANDARD CHARACTERS WITHOUT CLAIM TO ANY PARTICULAR FONT, STYLE, SIZE, OR COLOR.

OWNER OF U.S. REG. NO. 3,023,357.
FOR POWER MACHINE TOOLS FOR THE CUTTING OF MATERIALS (U.S. CLS. 13, 19, 21, 23, 31, 34 AND 35).
FIRST USE 3-22-2007; IN COMMERCE 3-22-2007.
ELLEN B. AWRICH, EXAMINING ATTORNEY

SN 77-161,477. ENVIRONMENT ONE CORPORATION, NISKAYUNA, NY. FILED 4-20-2007.

EXTREME

THE MARK CONSISTS OF STANDARD CHARACTERS WITHOUT CLAIM TO ANY PARTICULAR FONT, STYLE, SIZE, OR COLOR.

FOR MACHINES AND EQUIPMENT FOR SEWAGE AND WASTE DISPOSAL SYSTEMS, NAMELY GRINDER PUMPS AND GRINDER PUMP STATIONS COMPRISED OF GRINDER PUMPS, SENSORS AND CONTROLS WITHIN A TANK FOR USE IN A LOW-PRESSURE SEWAGE SYSTEM (U.S. CLS. 13, 19, 21, 23, 31, 34 AND 35).

SONYA STEPHENS, EXAMINING ATTORNEY

CLASS 7—(Continued).

SN 77-161,862. ACI SERVICES, INC., CAMBRIDGE, OH.
FILED 4-20-2007.

ENVIRONLINE

THE MARK CONSISTS OF STANDARD CHARACTERS
WITHOUT CLAIM TO ANY PARTICULAR FONT, STYLE,
SIZE, OR COLOR.

FOR COMPRESSORS FOR MACHINES (U.S. CLS. 13,
19, 21, 23, 31, 34 AND 35).
ROBIN CHOSID, EXAMINING ATTORNEY

SN 77-164,207. DUO AUTOMOTIVE PRODUCTS, INC.,
TEMPE, AZ. FILED 4-24-2007.

DUOENGINESTAND

THE MARK CONSISTS OF STANDARD CHARACTERS
WITHOUT CLAIM TO ANY PARTICULAR FONT, STYLE,
SIZE, OR COLOR.

FOR A DUAL PURPOSE MACHINE THAT ALLOWS
THE USER TO BUILD AN ENGINE SHORT BLOCK,
THEN ROTATE THE SHORT BLOCK TO AN UPRIGHT
POSITION TO COMPLETE THE ENGINE ASSEMBLY,
AND THEN START THE ENGINE FOR TESTING AND
BREAK-IN (U.S. CLS. 13, 19, 21, 23, 31, 34 AND 35).
WILLIAM VERHOSEK, EXAMINING ATTORNEY

SN 77-188,664. ILLINOIS TOOL WORKS INC., GLENVIEW,
IL. FILED 5-23-2007.



OWNER OF U.S. REG. NO. 3,091,048.
THE MARK CONSISTS OF AN INCOMPLETE CIRCLE.
FOR MACHINES TO APPLY AND MODIFY ELEC-
TRONIC MATERIALS IN THE FIELD OF PRINTED
CIRCUIT BOARDS (U.S. CLS. 13, 19, 21, 23, 31, 34 AND
35).
FIRST USE 1-0-2004; IN COMMERCE 1-0-2004.
MICHAEL SOUDERS, EXAMINING ATTORNEY

CLASS 7—(Continued).

SN 77-190,708. PREGIS INNOVATIVE PACKAGING INC.,
DEERFIELD, IL. FILED 5-25-2007.

GEOSPEED

THE MARK CONSISTS OF STANDARD CHARACTERS
WITHOUT CLAIM TO ANY PARTICULAR FONT, STYLE,
SIZE, OR COLOR.

FOR MACHINES FOR PRODUCING PAPER PACKA-
GING FOR INTERIOR USE; MACHINES FOR THE
PRODUCTION OF PACKAGING MATERIALS (U.S.
CLS. 13, 19, 21, 23, 31, 34 AND 35).

FIRST USE 3-21-2007; IN COMMERCE 3-21-2007.
TASHIA BUNCH, EXAMINING ATTORNEY

SN 77-214,940. DELAWARE CAPITAL FORMATION, INC.,
WILMINGTON, DE. FILED 6-25-2007.

OWNER OF U.S. REG. NOS. 2,015,109, 2,895,652 AND
OTHERS.

THE MARK CONSISTS OF THREE BARS WITH TRIAN-
GLES APPEARING INSIDE THE BARS ON THE LEFT SIDE
OF THE WORD "CHIEF".

FOR MACHINES USED IN REPAIRING COLLISION
OR STRUCTURAL DAMAGE TO VEHICLES AND RE-
PLACEMENT PARTS FOR SUCH MACHINES; VEHICLE
BODY AND FRAME ALIGNMENT MACHINES AND
REPLACEMENT PARTS FOR SUCH MACHINES (U.S.
CLS. 13, 19, 21, 23, 31, 34 AND 35).

FIRST USE 8-0-2005; IN COMMERCE 8-0-2005.

SUSAN LESLIE DUBOIS, EXAMINING ATTORNEY

CLASS 7—(Continued).

SN 78-435,038. RICK PETERSON MOTOR SPORTS, INC., MADISON, WI. FILED 6-14-2004.

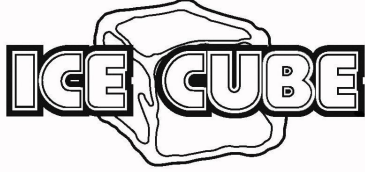

THE MARK CONSISTS OF THE WORDS ICE CUBE IN STYLIZED LETTERING AND AN IMAGE OF AN ICE CUBE.

FOR MOTORCYCLE PARTS, NAMELY, CYLINDERS (U.S. CLS. 13, 19, 21, 23, 31, 34 AND 35).
FIRST USE 2-28-2004; IN COMMERCE 2-28-2004.
JOHN DALIER, EXAMINING ATTORNEY

SN 78-673,678. KS KOLBENSCHMIDT GMBH, NECKAR-SULM, FED REP GERMANY, FILED 7-19-2005.

DYNAMIKS

THE MARK CONSISTS OF STANDARD CHARACTERS WITHOUT CLAIM TO ANY PARTICULAR FONT, STYLE, SIZE, OR COLOR.

PRIORITY CLAIMED UNDER SEC. 44(D) ON ERP CMNTY TM OFC APPLICATION NO. 004543542, FILED 7-15-2005, REG. NO. 004543542, DATED 3-28-2007, EXPIRES 7-15-2015.

FOR PISTONS FOR COMBUSTION ENGINES, PISTON PINS, PISTON RINGS, AND SECURING ELEMENTS FOR PISTON PINS, NAMELY, PISTON CLIPS, ALL THE AFOREMENTIONED GOODS NOT FOR USE IN CONNECTION WITH MOTORCYCLES (U.S. CLS. 13, 19, 21, 23, 31, 34 AND 35).

CHRIS WELLS, EXAMINING ATTORNEY

SN 78-771,927. OMTEC, CORP., MARLBOROUGH, MA. FILED 12-13-2005.

OMTEC

THE MARK CONSISTS OF STANDARD CHARACTERS WITHOUT CLAIM TO ANY PARTICULAR FONT, STYLE, SIZE, OR COLOR.

FOR MATERIAL HANDLING EQUIPMENT, NAMELY, CONVEYORS, BALL TRANSFERS, AND SCISSOR LIFTS (U.S. CLS. 13, 19, 21, 23, 31, 34 AND 35).

FIRST USE 0-0-1989; IN COMMERCE 0-0-1989.
LESLEY LAMOTHE, EXAMINING ATTORNEY

CLASS 7—(Continued).

SN 78-937,396. ACCUTEK PACKAGING EQUIPMENT COMPANY, INC., VISTA, CA. FILED 7-25-2006.

MINI-PINCH

THE MARK CONSISTS OF STANDARD CHARACTERS WITHOUT CLAIM TO ANY PARTICULAR FONT, STYLE, SIZE, OR COLOR.

SEC. 2(F).
FOR FILLING MACHINES (U.S. CLS. 13, 19, 21, 23, 31, 34 AND 35).

FIRST USE 0-0-1990; IN COMMERCE 0-0-1990.
MICHELLE DUBOIS, EXAMINING ATTORNEY

SN 78-945,156. SUMITOMO OSAKA CEMENT CO., LTD., CHIYODA-KU, TOKYO, JAPAN, FILED 8-4-2006.

EXPUR

THE MARK CONSISTS OF STANDARD CHARACTERS WITHOUT CLAIM TO ANY PARTICULAR FONT, STYLE, SIZE, OR COLOR.

PRIORITY CLAIMED UNDER SEC. 44(D) ON JAPAN APPLICATION NO. 2006-065590, FILED 7-13-2006, REG. NO. 5049686, DATED 5-25-2007, EXPIRES 5-25-2017.

FOR ELECTROSTATIC CHUCK FOR SEMICONDUCTOR MANUFACTURING MACHINES AND SYSTEMS (U.S. CLS. 13, 19, 21, 23, 31, 34 AND 35).

NAPOLÉON SHARMA, EXAMINING ATTORNEY

SN 78-958,075. NOZZTEQ, INC., CLEARWATER, FL. FILED 8-22-2006.

JAWS

THE MARK CONSISTS OF STANDARD CHARACTERS WITHOUT CLAIM TO ANY PARTICULAR FONT, STYLE, SIZE, OR COLOR.

FOR MACHINE TOOLS, NAMELY, WATER POWERED NOZZLES FOR THE CLEANING OF SEWERS AND PIPES (U.S. CLS. 13, 19, 21, 23, 31, 34 AND 35).

FIRST USE 7-1-1999; IN COMMERCE 7-1-1999.
FRED CARL, EXAMINING ATTORNEY

CLASS 7—(Continued).

SN 78-972,459. LF, LLC, WILMINGTON, DE. FILED 9-12-2006.

KOBALT

THE MARK CONSISTS OF STANDARD CHARACTERS WITHOUT CLAIM TO ANY PARTICULAR FONT, STYLE, SIZE, OR COLOR.

OWNER OF U.S. REG. NOS. 2,695,941, 3,141,234 AND OTHERS.

FOR CEMENT MIXING MACHINES (U.S. CLS. 13, 19, 21, 23, 31, 34 AND 35).

WARREN L. OLANDRIA, EXAMINING ATTORNEY

SN 79-016,598. OTTO SUHNER AKTIENGESELLSCHAFT, SWITZERLAND, FILED 8-11-2005.

SUHNER

OWNER OF INTERNATIONAL REGISTRATION 0415082 DATED 4-10-1975, EXPIRES 4-10-2015.

OWNER OF U.S. REG. NOS. 1,042,704 AND 2,112,732.

FOR SINGLE OR MULTI-SPEED ELECTRIC MOTORS FOR MACHINES; SINGLE OR MULTI-SPEED AND INTERNAL-COMBUSTION ENGINES, FLEXIBLE SHAFTS FOR MACHINES, PARTICULARLY FOR DRIVE TRANSMISSION, FOR CONTROLLING AND DRIVING TACHOMETERS, MECHANICAL SURFACING PARTS FOR MACHINING TOOLS; PORTABLE PNEUMATIC TOOLS FOR MECHANICAL SURFACING APPLICATIONS, AND PORTABLE ELECTRIC TOOLS FOR MECHANICAL SURFACING APPLICATIONS, STATIONARY ELECTRIC MACHINES FOR MECHANICAL SURFACE MACHINING, STATIONARY PNEUMATIC MACHINES FOR MECHANICAL SURFACE MACHINING, BORING UNITS, INTERIOR AND EXTERIOR CONCRETE VIBRATORS WITH DRIVES, PARTICULARLY WITH COMPRESSED-AIR MOTORS OR ELECTRIC MOTORS; AND STATIONARY MACHINES FOR MECHANICAL SURFACE MACHINING (U.S. CLS. 13, 19, 21, 23, 31, 34 AND 35).

RICHARD A. STRASER, EXAMINING ATTORNEY

CLASS 7—(Continued).

SN 79-027,756. DAVTEK PTY LTD, AUSTRALIA, FILED 8-14-2006.

APEXS

THE MARK CONSISTS OF STANDARD CHARACTERS WITHOUT CLAIM TO ANY PARTICULAR FONT, STYLE, SIZE, OR COLOR.

OWNER OF INTERNATIONAL REGISTRATION 0895634 DATED 8-14-2006, EXPIRES 8-14-2016.

FOR HIGH PRESSURE PUMPS FOR PUMPING FLUIDS, NAMELY, SLURRIES, OR CORROSIVE FLUIDS, FOR USE IN THE FIELDS OF MINING OPERATIONS AND MINING EQUIPMENT (U.S. CLS. 13, 19, 21, 23, 31, 34 AND 35).

DANIEL RUSSELL, EXAMINING ATTORNEY

SN 79-030,634. ZHENGZHOU ANHUA ABRASIVES CO., LTD, CHINA, FILED 10-25-2006.

ANHUA

OWNER OF INTERNATIONAL REGISTRATION 0902802 DATED 10-25-2006, EXPIRES 10-25-2016.

THE FOREIGN WORDING IN THE MARK TRANSLATES INTO ENGLISH AS TRANQUIL PROSPEROUS.

FOR MACHINES PARTS, NAMELY, COWLINGS; ELECTRIC KNIVES BEING PARTS OF MACHINES; CUTTING MACHINES; METALWORKING MACHINE PARTS, NAMELY, MILLSTONES; ELECTRIC POLISHING MACHINES FOR USE IN GRINDING AND POLISHING METAL, WOOD, CERAMICS AND PLASTICS; MACHINES PARTS, NAMELY, GRINDSTONES; MACHINE PARTS, NAMELY, SHARPENING GRINDERS (U.S. CLS. 13, 19, 21, 23, 31, 34 AND 35).

DOMINIC FATHY, EXAMINING ATTORNEY

SN 79-031,978. JOAN JOFRESA BARBANY, C/ EMPORDA, 3; E-08140 CALDES DE MONTBUI, SPAIN, FILED 9-14-2006.

BOYSER

THE MARK CONSISTS OF STANDARD CHARACTERS WITHOUT CLAIM TO ANY PARTICULAR FONT, STYLE, SIZE, OR COLOR.

OWNER OF INTERNATIONAL REGISTRATION 0906142 DATED 9-14-2006, EXPIRES 9-14-2016.

FOR ELECTRIC MACHINE PUMPS, DIAPHRAGM PUMPS; CENTRIFUGAL PUMPS; COMPRESSED AIR PUMPS FOR GARAGE INSTALLATIONS; COMPRESSED AIR PUMPS, AERATING PUMPS FOR AQUARIA; PNEUMATIC GREASE PUMPS; VACUUM PUMPS; ELECTRIC PUMPS FOR HEATING INSTALLATIONS; MACHINE TOOLS, NAMELY, GEAR CUTTERS; ELECTRIC MOTORS FOR MACHINES AND STRUCTURAL PARTS THEREFOR, ALL OF THE AFOREMENTIONED GOODS NOT FOR MOTOR VEHICLES AND NOT FOR INTERNAL COMBUSTION ENGINES OF ALL KINDS (U.S. CLS. 13, 19, 21, 23, 31, 34 AND 35).

WILLIAM VERHOSEK, EXAMINING ATTORNEY

CLASS 8—HAND TOOLS

SN 76-421,605. STILETTO TOOLS, INC., ATWATER, CA.
FILED 6-17-2002.

TITAN

THE MARK CONSISTS OF STANDARD CHARACTERS WITHOUT CLAIM TO ANY PARTICULAR FONT, STYLE, SIZE, OR COLOR.

OWNER OF U.S. REG. NOS. 1,984,702 AND 2,361,797.
FOR HAND TOOLS, SPECIFICALLY, HAMMERS (U.S. CLS. 23, 28 AND 44).
FIRST USE 10-15-1996; IN COMMERCE 10-15-1996.
JANICE L. MCMORROW, EXAMINING ATTORNEY

SN 76-675,586. CORONA CLIPPER, INC., CORONA, CA.
FILED 4-17-2007.

HomePro

by CORONA

OWNER OF U.S. REG. NO. 1,608,855.
FOR HAND TOOLS, NAMELY PRUNING SHEARS FOR GRASS, TREES, SHRUBS AND FLOWERS (U.S. CLS. 23, 28 AND 44).
JOHN GARTNER, EXAMINING ATTORNEY

SN 77-038,023. ARNOLD G. LOWENSTEIN, HAYWARD, CA.
FILED 11-6-2006.



GUTTERDECLUTTER

THE MARK CONSISTS OF A FANCIFUL DESIGN COMPRISING THE WORD "GUTTERDECLUTTER" IN WHICH THE LETTER "G" REPRESENTS A GUTTER CLEANING DEVICE WHICH IS POISED ABOVE A GUTTERING WHICH APPEARS OVER THE LETTERING IN THE MARK.

FOR HAND OPERATED, SHAPED, SUCTION-SPRAYERS USED TO CLEAN GUTTERS AND OTHER OVERHEAD ITEMS ON THE EXTERIOR OF BUILDINGS AND OTHER STRUCTURES (U.S. CLS. 23, 28 AND 44).

ANGELA M. MICHELI, EXAMINING ATTORNEY

CLASS 8—(Continued).

SN 77-152,174. SANRIO COMPANY, LTD., TOKYO, JAPAN,
FILED 4-9-2007.

KUROMI

THE MARK CONSISTS OF STANDARD CHARACTERS WITHOUT CLAIM TO ANY PARTICULAR FONT, STYLE, SIZE, OR COLOR.

FOR TABLE KNIVES, FORKS, SPOONS, EATING UTENSIL KITS PRIMARILY COMPRISED OF KNIVES, FORKS, AND SPOONS IN A CASE, SCISSORS, NAIL CLIPPERS, NAIL FILES, EYELASH CURLERS, NON-ELECTRIC CAN OPENERS, NON-ELECTRIC VEGETABLE PEELERS, NON-ELECTRIC VEGETABLE SCRAPERS, NON-ELECTRIC EGG SLICERS, CUTICLE PUSHERS, TWEEZERS, NAIL SCISSORS, CUTICLE SCISSORS, SHOVELS, RAKES (U.S. CLS. 23, 28 AND 44).
NAAKWAMA ANKRAH, EXAMINING ATTORNEY

SN 77-155,796. SNAP-ON INCORPORATED, KENOSHA, WI.
FILED 4-13-2007.

DUAL 80

THE MARK CONSISTS OF STANDARD CHARACTERS WITHOUT CLAIM TO ANY PARTICULAR FONT, STYLE, SIZE, OR COLOR.

FOR HAND TOOLS NAMELY, RATCHETS (U.S. CLS. 23, 28 AND 44).
KIMBERLY PERRY, EXAMINING ATTORNEY

SN 77-158,498. WARRENSVILLE FILE & KNIFE, INC.,
NORCROSS, GA. FILED 4-17-2007.

SILVER BULLET

THE MARK CONSISTS OF STANDARD CHARACTERS WITHOUT CLAIM TO ANY PARTICULAR FONT, STYLE, SIZE, OR COLOR.

FOR FILES (U.S. CLS. 23, 28 AND 44).
MARY MUNSON, EXAMINING ATTORNEY

CLASS 8—(Continued).

SN 77-158,541. AMES TRUE TEMPER PROPERTIES, INC., WILMINGTON, DE. FILED 4-17-2007.

7 in 1 VersaPlanter

THE MARK CONSISTS OF STANDARD CHARACTERS WITHOUT CLAIM TO ANY PARTICULAR FONT, STYLE, SIZE, OR COLOR.

NO CLAIM IS MADE TO THE EXCLUSIVE RIGHT TO USE "7 IN 1", APART FROM THE MARK AS SHOWN.

FOR MANUALLY OPERATED HAND TOOLS, NAMELY, A COMBINATION KNIFE, TROWEL, SOD CUTTER AND WEEDER (U.S. CLS. 23, 28 AND 44).

FIRST USE 4-0-2006; IN COMMERCE 4-0-2006.

JORDAN BAKER, EXAMINING ATTORNEY

SN 77-158,942. MENTOR GROUP, LLC, OREGON CITY, OR. FILED 4-17-2007.

HOUDINI

THE MARK CONSISTS OF STANDARD CHARACTERS WITHOUT CLAIM TO ANY PARTICULAR FONT, STYLE, SIZE, OR COLOR.

FOR MULTI-FUNCTION HAND TOOLS COMPRISED OF A SEAT BELT CUTTING TOOL AND A SPRING-LOADED GLASS BREAKING TOOL (U.S. CLS. 23, 28 AND 44).

SCOTT SISUN, EXAMINING ATTORNEY

SN 77-158,956. ELLISON EDUCATIONAL EQUIPMENT, LAKE FOREST, CA. FILED 4-17-2007.



OWNER OF U.S. REG. NOS. 2,615,160, 2,638,914 AND OTHERS.

THE MARK CONSISTS OF THE LETTERS S, I, Z, Z, I, X IN BOUNCING TYPE CONFIGURATION.

FOR HAND-OPERATED DIE CUTTING, EMBOSsing, CREASING, AND PRESSING MACHINES; DIES TO BE USED WITH SAID HAND-OPERATED MACHINES (U.S. CLS. 23, 28 AND 44).

FIRST USE 10-1-2006; IN COMMERCE 10-1-2006.

GISELLE AGOSTO, EXAMINING ATTORNEY

CLASS 8—(Continued).

SN 77-160,204. KEENCO INDUSTRIAL CO., LTD, TAI-CHUNG COUNTY, TAIWAN, FILED 4-18-2007.



FOR SCREWDRIVERS; SCISSORS; PLIERS; WRENCHES; HAMMERS; HAND TOOLS NAMELY, TAPS; HAND-POWERED STAPLE GUNS; HAND TOOLS NAMELY, HAMMERS; SAWS; HAND-OPERATED CHOPPERS; HAND-OPERATED SHEARS; TOOL BELTS; DRILL BITS FOR HAND DRILLS; HAND TOOLS NAMELY, DRILLS; HAND TOOLS NAMELY, RASPS; HAND TOOLS NAMELY, MANUALLY-OPERATED GRINDING WHEELS; HAND TOOLS NAMELY, RATCHET WRENCHES (U.S. CLS. 23, 28 AND 44).

LINDSEY RUBIN, EXAMINING ATTORNEY

SN 77-174,306. AMES TRUE TEMPER PROPERTIES, INC., WILMINGTON, DE. FILED 5-7-2007.

EAGLE

THE MARK CONSISTS OF STANDARD CHARACTERS WITHOUT CLAIM TO ANY PARTICULAR FONT, STYLE, SIZE, OR COLOR.

FOR MANUALLY OPERATED HAND TOOLS, NAMELY, SHOVELS, RAKES, HOES, FORKS, AND POST HOLE DIGGERS (U.S. CLS. 23, 28 AND 44).

FIRST USE 4-0-1994; IN COMMERCE 4-0-1994.

JORDAN BAKER, EXAMINING ATTORNEY

SN 77-180,180. AMES TRUE TEMPER PROPERTIES, INC., WILMINGTON, DE. FILED 5-14-2007.

SUPER SOCKET

THE MARK CONSISTS OF STANDARD CHARACTERS WITHOUT CLAIM TO ANY PARTICULAR FONT, STYLE, SIZE, OR COLOR.

NO CLAIM IS MADE TO THE EXCLUSIVE RIGHT TO USE "SOCKET", APART FROM THE MARK AS SHOWN.

FOR MANUALLY OPERATED HAND TOOLS, NAMELY, SHOVELS (U.S. CLS. 23, 28 AND 44).

JORDAN BAKER, EXAMINING ATTORNEY

CLASS 8—(Continued).

SN 78-951,746. BATTENFELD TECHNOLOGIES, INC., COLUMBIA, MO. FILED 8-14-2006.

F.A.T. WRENCH

THE MARK CONSISTS OF STANDARD CHARACTERS WITHOUT CLAIM TO ANY PARTICULAR FONT, STYLE, SIZE, OR COLOR.

NO CLAIM IS MADE TO THE EXCLUSIVE RIGHT TO USE "WRENCH", APART FROM THE MARK AS SHOWN, FOR MANUALLY OPERATED HAND TOOLS, NAMELY, WRENCHES USED EXCLUSIVELY WITH FIREARMS (U.S. CLS. 23, 28 AND 44).

MARK PILARO, EXAMINING ATTORNEY

CLASS 9—ELECTRICAL AND SCIENTIFIC APPARATUS

SN 76-104,377. NYKO TECHNOLOGIES, INC., LOS ANGELES, CA. FILED 8-7-2000.

VIPER2

FOR HAND-HELD CONTROLLER FOR USE IN CONNECTION WITH VIDEO GAME DEVICES (U.S. CLS. 21, 23, 26, 36 AND 38).

FIRST USE 4-7-2000; IN COMMERCE 4-7-2000.
ALICE BENMAMAN, EXAMINING ATTORNEY

SN 76-585,727. REALCOMP II LTD., FARMINGTON HILLS, MI. FILED 4-8-2004.

LANDSHARK

THE MARK CONSISTS OF STANDARD CHARACTERS WITHOUT CLAIM TO ANY PARTICULAR FONT, STYLE, SIZE, OR COLOR.

FOR COMPUTER SOFTWARE TO ENABLE USERS OF A REAL ESTATE MULTI-LIST SERVICE TO DOWNLOAD DATA FROM THE MULTI-LIST DATABASE (U.S. CLS. 21, 23, 26, 36 AND 38).

FIRST USE 4-1-1995; IN COMMERCE 4-1-1995.
ALICIA COLLINS, EXAMINING ATTORNEY

CLASS 9—(Continued).

SN 76-609,799. CASIO KEISANKI KABUSHIKI KAISHA, DBA CASIO COMPUTER CO., LTD., TOKYO, JAPAN, FILED 5-20-2004.

EX-word

THE MARK CONSISTS OF STANDARD CHARACTERS WITHOUT CLAIM TO ANY PARTICULAR FONT, STYLE, SIZE, OR COLOR.

OWNER OF JAPAN REG. NO. 4967462, DATED 7-7-2006, EXPIRES 7-7-2016.

FOR HAND-HELD COMPUTERS; ELECTRONIC CALCULATORS HAVING THE FUNCTIONS OF TELEPHONE BOOKS, ADDRESS BOOKS, CALENDARS, SCHEDULE BOOKS AND MEMO BOOKS; COMPUTER SOFTWARE PRERECORDED ON MAGNETIC TAPES, CARDS, DISCS AND OPTICAL DISCS FOR ELECTRONIC DICTIONARIES; COMPUTERS; COMPUTER KEYBOARDS; PRINTERS; MONITORS; MICE; SCANNERS; LIGHT PENS; OPTICAL DISC DRIVES; MODEMS; PDA (PERSONAL DIGITAL ASSISTANTS); ELECTRONIC PERSONAL ORGANIZERS; DIGITAL CAMERAS; PRINTERS FOR DIGITAL CAMERAS; PRINTERS FOR COMPUTERS; COMPUTER SOFTWARE FOR PERSONAL COMPUTERS FOR USE IN ACHIEVING DATA EXCHANGE BETWEEN A PERSONAL COMPUTER AND A WRISTWATCH OR A DIGITAL CAMERA; ELECTRONIC CALCULATORS; ELECTRONIC LABEL PRINTERS; CELLULAR TELEPHONES; RADIO PAGES; LCD TELEVISION SETS; NAVIGATION APPARATUS AND INSTRUMENTS; CAR NAVIGATION APPARATUS AND INSTRUMENTS; RADIOS; COMPACT DISC PLAYERS; AUDIO TAPE RECORDERS; VIDEO TAPE RECORDERS; MOVIE, VIDEO, SLIDE AND PICTURE PROJECTORS, AND PARTS AND FITTINGS THEREOF; VISUAL PRESENTERS, AND PARTS AND FITTINGS THEREOF; APPARATUS FOR RECORDING, TRANSMISSION OR REPRODUCTION OF SOUND OR IMAGES, AND PARTS AND FITTINGS THEREOF; APPARATUS FOR SCANNING, PROCESSING, TRANSMITTING AND PROJECTING IMAGES AND PICTURES (U.S. CLS. 21, 23, 26, 36 AND 38).

ALICE SUE CARRUTHERS, EXAMINING ATTORNEY

SN 76-625,362. AUSTIN TELE-SERVICES, LLC, AUSTIN, TX. FILED 12-21-2004.

GLOBAL TECHNOLOGY EXCHANGE

THE MARK CONSISTS OF STANDARD CHARACTERS WITHOUT CLAIM TO ANY PARTICULAR FONT, STYLE, SIZE, OR COLOR.

NO CLAIM IS MADE TO THE EXCLUSIVE RIGHT TO USE TECHNOLOGY, APART FROM THE MARK AS SHOWN.

FOR COMMUNICATIONS EQUIPMENT, NAMELY, OPTICAL TRANSPORT HARDWARE, DIGITAL CROSS-CONNECT SWITCHES FOR IP ROUTING, AND TRANSMITTERS, RECEIVERS, ROUTERS, SWITCHERS, MODEMS, CONVERTERS, AND INTERFACE DEVICES FOR DSL (DIGITAL SUBSCRIBER LINE), CDMA (CODE DIVISION MULTIPLE ACCESS), AND GSM (GLOBAL SYSTEM FOR MOBILE TELECOMMUNICATIONS) (U.S. CLS. 21, 23, 26, 36 AND 38).

DORITT L. CARROLL, EXAMINING ATTORNEY

CLASS 9—(Continued).

SN 76-664,880. YOKETAN CORPORATION, TAICHUNG COUNTY 427, TAIWAN, FILED 8-21-2006.

YOKE

THE MARK CONSISTS OF STANDARD CHARACTERS WITHOUT CLAIM TO ANY PARTICULAR FONT, STYLE, SIZE, OR COLOR.

FOR ELECTRONIC COMPONENTS, NAMELY, QUARTZ FILTERS AND CRYSTAL OSCILLATORS; HIGH FREQUENCY ELECTRONIC COMPONENTS IN THE NATURE OF SWITCHES, AND CRYSTAL FILTERS, SURFACE ACOUSTIC WAVE FILTERS AND SURFACE ACOUSTIC WAVE RESONATORS (U.S. CLS. 21, 23, 26, 36 AND 38).

FIRST USE 9-16-2003; IN COMMERCE 9-16-2003.
BRIDGETT SMITH, EXAMINING ATTORNEY

CLASS 9—(Continued).

SN 76-667,891. SCIENTIFIC COMPONENTS CORPORATION, BROOKLYN, NY. FILED 10-23-2006.

MCL

THE MARK CONSISTS OF STANDARD CHARACTERS WITHOUT CLAIM TO ANY PARTICULAR FONT, STYLE, SIZE, OR COLOR.

FOR ELECTRONIC PROCESSING EQUIPMENT, NAMELY, RADIO FREQUENCY (RF) AND INTERMEDIATE FREQUENCY (IF) MICROWAVE COMPONENTS; AND, RF/IF SIGNAL PROCESSING PRODUCTS, NAMELY, FREQUENCY MIXERS, POWER SPLITTERS/COMBINERS, AMPLIFIERS, BI-PHASE ATTENUATORS, DIGITAL STEP ATTENUATORS, FIXED ATTENUATORS, COAXIAL MATCHING PADS AND TERMINATIONS, DIRECTIONAL COUPLERS, FILTERS, FREQUENCY DOUBLERS, BIAS-TEES AND LIMITERS, MODULATORS AND DEMODULATORS, PHASE DETECTORS AND PHASE SHIFTERS, SWITCHES AND DRIVERS, RF TRANSFORMERS, AND OSCILLATORS (U.S. CLS. 21, 23, 26, 36 AND 38).

FIRST USE 9-0-1968; IN COMMERCE 9-0-1968.
DANIEL CAPSHAW, EXAMINING ATTORNEY

SN 76-675,047. ISECURETRAC INC., OMAHA, NE. FILED 4-4-2007.

ist system 5000

THE MARK CONSISTS OF STANDARD CHARACTERS WITHOUT CLAIM TO ANY PARTICULAR FONT, STYLE, SIZE, OR COLOR.

NO CLAIM IS MADE TO THE EXCLUSIVE RIGHT TO USE "SYSTEM", APART FROM THE MARK AS SHOWN.

FOR PERSONNEL TRACKING, AND MONITORING SYSTEM COMPRISED OF ELECTRONIC TRANSMITTERS, RECEIVERS, AND CUFFS WHICH ARE WORN BY TRACKED SUBJECTS (U.S. CLS. 21, 23, 26, 36 AND 38).

JESSICA A. POWERS, EXAMINING ATTORNEY

SN 76-666,312. INTERNATIONAL DIGITAL ENTERPRISE ALLIANCE, INC., ALEXANDRIA, VA. FILED 9-18-2006.

DISC CHECKER

THE MARK CONSISTS OF STANDARD CHARACTERS WITHOUT CLAIM TO ANY PARTICULAR FONT, STYLE, SIZE, OR COLOR.

FOR PROVIDING DOWNLOADABLE SOFTWARE TO IMPLEMENT SPECIFICATIONS FOR THE SUBMISSION OF DIGITAL IMAGES BY PHOTOGRAPHERS, ILLUSTRATORS AND OTHER CREATIVE PROFESSIONALS FOR PRINT PRODUCTION (U.S. CLS. 21, 23, 26, 36 AND 38).

FIRST USE 11-30-2004; IN COMMERCE 11-30-2004.
ELISSA GARBER KON, EXAMINING ATTORNEY

SN 76-675,597. SOFT COMPUTER CONSULTANTS, INC., CLEARWATER, FL. FILED 4-17-2007.

SOFTCOMPLIANCE

THE MARK CONSISTS OF STANDARD CHARACTERS WITHOUT CLAIM TO ANY PARTICULAR FONT, STYLE, SIZE, OR COLOR.

FOR COMPUTER SOFTWARE PROGRAM FOR USE IN ORDER ENTRY OF THE LABORATORY INFORMATION SYSTEM AND FOR USE IN PERFORMING MEDICAL NECESSITY PREORDERED TEST AND MULTIPLE DIAGNOSIS (U.S. CLS. 21, 23, 26, 36 AND 38).

FIRST USE 5-1-2002; IN COMMERCE 5-1-2002.
ELISSA GARBER KON, EXAMINING ATTORNEY

CLASS 9—(Continued).

SN 76-675,598. SOFT COMPUTER CONSULTANTS, INC., CLEARWATER, FL. FILED 4-17-2007.

SOFTCYTOGENETICS

THE MARK CONSISTS OF STANDARD CHARACTERS WITHOUT CLAIM TO ANY PARTICULAR FONT, STYLE, SIZE, OR COLOR.

FOR COMPUTER SOFTWARE PROGRAM WHICH STREAMLINES CASE PROCESSING AND WORKFLOW INCLUDING CULTURE SETUP, SLIDE PROCESSING, ANALYSIS AND REPORTING (U.S. CLS. 21, 23, 26, 36 AND 38).

FIRST USE 1-1-2002; IN COMMERCE 11-18-2005.
ELISSA GARBER KON, EXAMINING ATTORNEY

SN 76-675,609. SOFT COMPUTER CONSULTANTS, INC., CLEARWATER, FL. FILED 4-17-2007.

SOFTHLA

THE MARK CONSISTS OF STANDARD CHARACTERS WITHOUT CLAIM TO ANY PARTICULAR FONT, STYLE, SIZE, OR COLOR.

FOR COMPUTER SOFTWARE PROGRAM TRACKS PATIENT GROUPS FOR FAMILY WORKUPS AND RESEARCH STUDIES (U.S. CLS. 21, 23, 26, 36 AND 38).
ELISSA GARBER KON, EXAMINING ATTORNEY

SN 76-675,610. SOFT COMPUTER CONSULTANTS, INC., CLEARWATER, FL. FILED 4-17-2007.

SOFTMOLECULAR

THE MARK CONSISTS OF STANDARD CHARACTERS WITHOUT CLAIM TO ANY PARTICULAR FONT, STYLE, SIZE, OR COLOR.

FOR COMPUTER SOFTWARE PROGRAM WHICH DIRECTS WORKFLOW FOR GENETIC CODE DETERMINATION AND NUCLEIC ACID TESTING ALLOWING FOR ACCESS TO PREVIOUS SAMPLE DATA FOR FUTURE TESTING (U.S. CLS. 21, 23, 26, 36 AND 38).

FIRST USE 9-15-2003; IN COMMERCE 11-18-2005.
ELISSA GARBER KON, EXAMINING ATTORNEY

CLASS 9—(Continued).

SN 76-675,613. SOFT COMPUTER CONSULTANTS, INC., CLEARWATER, FL. FILED 4-17-2007.

SOFTFLOWCYTOMETRY

THE MARK CONSISTS OF STANDARD CHARACTERS WITHOUT CLAIM TO ANY PARTICULAR FONT, STYLE, SIZE, OR COLOR.

FOR COMPUTER SOFTWARE PROGRAM THAT ASSISTS IN CELL IDENTIFICATION IN THE GENETICS-RELATED PROCESS (U.S. CLS. 21, 23, 26, 36 AND 38).

FIRST USE 9-1-2004; IN COMMERCE 11-18-2005.
ELISSA GARBER KON, EXAMINING ATTORNEY

SN 76-675,615. ABNP PRODUCTIONS LLC, WILLOUGHBY, OH. FILED 4-17-2007.

WAGON WHEEL

THE MARK CONSISTS OF STANDARD CHARACTERS WITHOUT CLAIM TO ANY PARTICULAR FONT, STYLE, SIZE, OR COLOR.

FOR VIDEO RECORDINGS FEATURING HISTORICAL AND SPECIAL INTEREST DOCUMENTARIES (U.S. CLS. 21, 23, 26, 36 AND 38).

ELISSA GARBER KON, EXAMINING ATTORNEY

SN 76-675,644. PARICON TECHNOLOGIES CORPORATION, FALL RIVER, MA. FILED 4-18-2007.

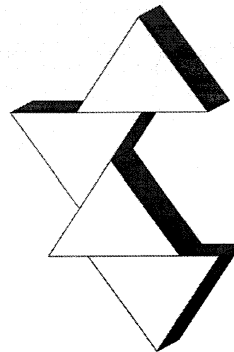

OWNER OF U.S. REG. NOS. 2,443,992 AND 2,530,457.
FOUR TRIANGLES DESIGN
FOR CONFORMABLE INTERCONNECTION DEVICES FOR USE BETWEEN ONE OR MORE ELECTRICAL COMPONENTS, NAMELY, CIRCUIT BOARDS, COMPUTER CHIPS, LAND GRID ARRAYS, BALL GRID ARRAYS, FLEX CIRCUITS AND HEAT SINKS (U.S. CLS. 21, 23, 26, 36 AND 38).
ERNEST SHOSHO, EXAMINING ATTORNEY

CLASS 9—(Continued).

SN 76-675,653. PARICON TECHNOLOGIES CORPORATION, FALL RIVER, MA. FILED 4-18-2007.

PARIPROBE

THE MARK CONSISTS OF STANDARD CHARACTERS WITHOUT CLAIM TO ANY PARTICULAR FONT, STYLE, SIZE, OR COLOR.

OWNER OF U.S. REG. NOS. 2,443,992, 2,528,224 AND 2,530,457.

FOR CONFORMABLE INTERCONNECTION DEVICES FOR USE BETWEEN ONE OR MORE ELECTRICAL COMPONENTS, NAMELY, CIRCUIT BOARDS, COMPUTER CHIPS, LAND GRID ARRAYS, BALL GRID ARRAYS, FLEX CIRCUITS AND HEAT SINKS (U.S. CLS. 21, 23, 26, 36 AND 38).

ERNEST SHOSHO, EXAMINING ATTORNEY

SN 76-675,721. INNOVATION ASSOCIATES, INC., JOHNSON CITY, NY. FILED 4-19-2007.

RDS - I

THE MARK CONSISTS OF STANDARD CHARACTERS WITHOUT CLAIM TO ANY PARTICULAR FONT, STYLE, SIZE, OR COLOR.

FOR SOFTWARE FOR CONTROLLING PILL, CAPSULE, AND TABLET DISPENSING APPARATUS AND CONTROLLERS AND WORKSTATIONS THEREFOR (U.S. CLS. 21, 23, 26, 36 AND 38).

FIRST USE 1-0-2004; IN COMMERCE 1-0-2004.
DAVID H. STINE, EXAMINING ATTORNEY

SN 76-675,723. INNOVATION ASSOCIATES, INC., JOHNSON CITY, NY. FILED 4-19-2007.

RDS - II

THE MARK CONSISTS OF STANDARD CHARACTERS WITHOUT CLAIM TO ANY PARTICULAR FONT, STYLE, SIZE, OR COLOR.

FOR SOFTWARE FOR CONTROLLING PILL, CAPSULE, AND TABLET DISPENSING APPARATUS AND CONTROLLERS AND WORKSTATIONS THEREFOR (U.S. CLS. 21, 23, 26, 36 AND 38).

FIRST USE 1-0-2004; IN COMMERCE 1-0-2004.
DAVID H. STINE, EXAMINING ATTORNEY

CLASS 9—(Continued).

SN 76-675,762. UNIVERSAL ELECTRONICS INC., CYPRESS, CA. FILED 4-20-2007.



THE MARK CONSISTS OF THE DESIGN OF A CRICKET. FOR REMOTE CONTROL UNITS FOR TELEVISIONS, VIDEO CASSETTE RECORDERS, CABLE BOXES, STEREO EQUIPMENT, SATELLITE DISHES, COMPUTERS, LIGHTING AND FANS; WIRELESS KEYBOARDS; PERSONAL DIGITAL ASSISTANTS; AND HAND HELD WIRELESS COMPUTERS (U.S. CLS. 21, 23, 26, 36 AND 38).

BILL DAWE, EXAMINING ATTORNEY

SN 76-676,560. SOFT COMPUTER CONSULTANTS, INC., CLEARWATER, FL. FILED 5-8-2007.

SOFTCELL

THE MARK CONSISTS OF STANDARD CHARACTERS WITHOUT CLAIM TO ANY PARTICULAR FONT, STYLE, SIZE, OR COLOR.

FOR COMPUTER SOFTWARE PROGRAM THAT ASSISTS DOCUMENTING STEPS IN THE PROCUREMENT, MANIPULATION, STORAGE, DISTRIBUTION, AND ADMINISTRATION OF CELLULAR THERAPY PRODUCTS (U.S. CLS. 21, 23, 26, 36 AND 38).

ELISSA GARBER KON, EXAMINING ATTORNEY

SN 76-678,716. SOFT COMPUTER CONSULTANTS, INC., CLEARWATER, FL. FILED 6-26-2007.

SOFTROE

THE MARK CONSISTS OF STANDARD CHARACTERS WITHOUT CLAIM TO ANY PARTICULAR FONT, STYLE, SIZE, OR COLOR.

FOR COMPUTER SOFTWARE PROGRAM FOR RECURRING ORDER ENTRY SYSTEM THAT ALLOWS USERS AT INDIVIDUAL WORKSTATIONS TO ENTER ORDERS ON PATIENTS AND TO REPEAT OR CYCLE ORDERS AS NEEDED (U.S. CLS. 21, 23, 26, 36 AND 38).

FIRST USE 2-2-2004; IN COMMERCE 2-2-2004.
ELISSA GARBER KON, EXAMINING ATTORNEY

CLASS 9—(Continued).

SN 76-678,717. SOFT COMPUTER CONSULTANTS, INC., CLEARWATER, FL. FILED 6-26-2007.

SOFTMPI

THE MARK CONSISTS OF STANDARD CHARACTERS WITHOUT CLAIM TO ANY PARTICULAR FONT, STYLE, SIZE, OR COLOR.

FOR COMPUTER SOFTWARE PROGRAM FOR USE AS A MASTER PATIENT INDEX TOOL REFERENCING MULTIPLE MEDICAL RECORD NUMBERS TO ACCESS AND SHARE PATIENT INFORMATION BETWEEN DEPARTMENTS (U.S. CLS. 21, 23, 26, 36 AND 38).

FIRST USE 1-1-1996; IN COMMERCE 1-1-1996.

ELISSA GARBER KON, EXAMINING ATTORNEY

CLASS 9—(Continued).

SN 77-008,091. QUALCOMM MEMS TECHNOLOGIES, INC., SAN DIEGO, CA. FILED 9-26-2006.

INSPIRED BY NATURE

THE MARK CONSISTS OF STANDARD CHARACTERS WITHOUT CLAIM TO ANY PARTICULAR FONT, STYLE, SIZE, OR COLOR.

FOR MICROELECTROMECHANICAL SYSTEMS DISPLAY DEVICES, NAMELY, FLAT PANEL DISPLAY SCREENS FOR USE IN MOBILE TELEPHONES, COMPUTERS, MP3 PLAYERS, AND PORTABLE HAND HELD COMPUTER COMMUNICATION EQUIPMENT (U.S. CLS. 21, 23, 26, 36 AND 38).

MEGAN WHITNEY, EXAMINING ATTORNEY

SN 77-000,366. MARPORT CANADA INC., CONCEPTION BAY SOUTH, NEW FOUNDLAND, CANADA, FILED 9-15-2006.

MARPORT

THE MARK CONSISTS OF STANDARD CHARACTERS WITHOUT CLAIM TO ANY PARTICULAR FONT, STYLE, SIZE, OR COLOR.

FOR ELECTRONIC SENSORS FOR MEASURING MECHANICAL, THERMAL, BIOLOGICAL, CHEMICAL, OPTICAL, AND MAGNETIC PHENOMENA; ECHO SOUNDERS; SONARS, VISUALIZATION SOFTWARE, NAMELY, COMPUTER SOFTWARE FOR USE IN ANALYZING SONAR IMAGES; BRIDGE COMPUTING AND DISPLAY INSTRUMENTS, NAMELY, GAUGES TO MEASURE PITCH, ROLL, HEADING, SPEED, DISTANCE, DEPTH AND ECHOSOUNDER IMAGES (U.S. CLS. 21, 23, 26, 36 AND 38).

FIRST USE 7-15-2003; IN COMMERCE 7-15-2003.

ROBERT LAVACHE, EXAMINING ATTORNEY

SN 77-008,541. CABCO GROUP LIMITED, AUCKLAND, NEW ZEALAND, FILED 9-27-2006.

SMRT KART

SN 77-000,808. RADTECH, LLC, EARTH CITY, MO. FILED 9-15-2006.

ACCLARO

THE MARK CONSISTS OF STANDARD CHARACTERS WITHOUT CLAIM TO ANY PARTICULAR FONT, STYLE, SIZE, OR COLOR.

THE ENGLISH TRANSLATION OF ACCLARO IS TO MAKE CLEAR OR REVEAL.

FOR PROTECTIVE CARRYING CASES ADAPTED FOR USE WITH PORTABLE AND HAND-HELD ELECTRONIC DEVICES FOR RECORDING, ORGANIZING, TRANSMITTING, MANIPULATING, AND REVIEWING TEXT, DATA, AUDIO AND VIDEO FILES, NAMELY, MP3 PLAYERS AND DIGITAL AUDIO AND VIDEO PLAYERS (U.S. CLS. 21, 23, 26, 36 AND 38).

FIRST USE 12-8-2005; IN COMMERCE 12-14-2005.

ELISSA GARBER KON, EXAMINING ATTORNEY

THE MARK CONSISTS OF STANDARD CHARACTERS WITHOUT CLAIM TO ANY PARTICULAR FONT, STYLE, SIZE, OR COLOR.

NO CLAIM IS MADE TO THE EXCLUSIVE RIGHT TO USE "KART", APART FROM THE MARK AS SHOWN.

FOR FLAT PANEL DISPLAY SCREENS AND VIDEO DISPLAY SCREENS ATTACHABLE TO A STANDARD OR CUSTOM SHOPPING CART (U.S. CLS. 21, 23, 26, 36 AND 38).

MIDGE BUTLER, EXAMINING ATTORNEY

CLASS 9—(Continued).

SN 77-011,732. VAL-MATIC VALVE AND MANUFACTURING CORPORATION, ELMHURST, IL. FILED 10-2-2006.

VAL-MATIC

THE MARK CONSISTS OF STANDARD CHARACTERS WITHOUT CLAIM TO ANY PARTICULAR FONT, STYLE, SIZE, OR COLOR.

OWNER OF U.S. REG. NO. 1,506,874.

FOR AUTOMATIC VALVES, NAMELY, SILENT CHECK VALVES BOTH WAFER AND GLOBE STYLE, DISC CHECK VALVES, BOTH SINGLE DISC AND DUAL DISC, TILTED DISC CHECK VALVES, AIR VALVES, AIR/VACUUM VALVES, AIR RELEASE VALVES BOTH SIMPLE AND COMPOUND LEVER, WELL SERVICE AIR VALVES FOR VERTICAL TURBINE PUMPS, SEWAGE AIR VALVES FOR MUNICIPAL AND INDUSTRIAL WASTE, BUTTERFLY VALVES, PLUG VALVES, AUTOMATIC INFLOW CONTROL VALVES FOR AIR VALVES AND VENT OUTLETS IN WATER TREATMENT AND SUPPLY SYSTEMS, VALVES FOR USE IN POTABLE WATER DELIVERY PIPELINES AND ACCESS VAULTS (U.S. CLS. 21, 23, 26, 36 AND 38).

FIRST USE 0-0-1966; IN COMMERCE 0-0-1966.

BRENDAN MCCAULEY, EXAMINING ATTORNEY

SN 77-011,981. AMKOR TECHNOLOGY, INC., CHANDLER, AZ. FILED 10-2-2006.

FLIPSTACK

THE MARK CONSISTS OF STANDARD CHARACTERS WITHOUT CLAIM TO ANY PARTICULAR FONT, STYLE, SIZE, OR COLOR.

FOR SEMICONDUCTOR PACKAGES, NAMELY, SEMICONDUCTOR PACKAGES COMPRISED OF SEMICONDUCTOR DIES AND INTERCONNECTS (U.S. CLS. 21, 23, 26, 36 AND 38).

ROBERT LAVACHE, EXAMINING ATTORNEY

CLASS 9—(Continued).

SN 77-013,025. SPARK UNLIMITED, INC., SHERMAN OAKS, CA. FILED 10-3-2006.

SPARK

THE MARK CONSISTS OF STANDARD CHARACTERS WITHOUT CLAIM TO ANY PARTICULAR FONT, STYLE, SIZE, OR COLOR.

OWNER OF U.S. REG. NO. 3,163,380.

FOR COMPUTER GAME DISCS; COMPUTER GAME EQUIPMENT CONTAINING MEMORY DEVICES, NAMELY, DISCS; COMPUTER GAME PROGRAMS; COMPUTER GAME SOFTWARE; COMPUTER PROGRAMS FOR PRE-RECORDED GAMES; ELECTRONIC GAME PROGRAMS; GAME SOFTWARE; INTERACTIVE MULTIMEDIA COMPUTER GAME PROGRAM; INTERACTIVE VIDEO GAME PROGRAMS; VIDEO GAME DISCS; VIDEO GAME SOFTWARE (U.S. CLS. 21, 23, 26, 36 AND 38).

FIRST USE 11-1-2004; IN COMMERCE 11-1-2004.

KYLE PEETE, EXAMINING ATTORNEY

SN 77-014,248. E.T.I. SOUND SYSTEMS, INC., HUNTINGTON PARK, CA. FILED 10-5-2006.



OWNER OF U.S. REG. NO. 1,769,887.

THE MARK CONSISTS OF B-52 IN A CIRCLE AND STYLIZED PRODIGY FX.

FOR AUDIO EQUIPMENT, NAMELY, MIXERS, AMPLIFIERS, MP3 PLAYERS, CD PLAYERS, DIGITAL SIGNAL PROCESSORS, EQUALIZERS, LOUDSPEAKERS (U.S. CLS. 21, 23, 26, 36 AND 38).

FIRST USE 7-12-2005; IN COMMERCE 11-4-2005.

PAUL E. FAHRENKOPF, EXAMINING ATTORNEY

SN 77-014,250. E.T.I. SOUND SYSTEMS, INC., HUNTINGTON PARK, CA. FILED 10-5-2006.



OWNER OF U.S. REG. NO. 1,769,887.

THE MARK CONSISTS OF B-52 IN A CIRCLE AND STYLIZED PRODIGY.

FOR AUDIO EQUIPMENT, NAMELY, MIXERS, AMPLIFIERS, MP3 PLAYERS, CD PLAYERS, DIGITAL SIGNAL PROCESSORS, EQUALIZERS, LOUDSPEAKERS (U.S. CLS. 21, 23, 26, 36 AND 38).

FIRST USE 7-12-2005; IN COMMERCE 11-4-2005.

PAUL E. FAHRENKOPF, EXAMINING ATTORNEY

CLASS 9—(Continued).

SN 77-016,265. VERTICAL COMMUNICATIONS, INC., CAMBRIDGE, MA. FILED 10-6-2006.

RANGER SS CORDLESS TELEPHONE

THE MARK CONSISTS OF STANDARD CHARACTERS WITHOUT CLAIM TO ANY PARTICULAR FONT, STYLE, SIZE, OR COLOR.

NO CLAIM IS MADE TO THE EXCLUSIVE RIGHT TO USE "SS CORDLESS TELEPHONE", APART FROM THE MARK AS SHOWN.

FOR CORDLESS TELEPHONES (U.S. CLS. 21, 23, 26, 36 AND 38).

GRETTA YAO, EXAMINING ATTORNEY

SN 77-016,661. SENFTER, FLORIAN, 80469 MUNICH, FED REP GERMANY, FILED 10-9-2006.

Zombie Nation

THE MARK CONSISTS OF STANDARD CHARACTERS WITHOUT CLAIM TO ANY PARTICULAR FONT, STYLE, SIZE, OR COLOR.

PRIORITY CLAIMED UNDER SEC. 44(D) ON FED REP GERMANY APPLICATION NO. 30623594.3, FILED 4-10-2006, REG. NO. 30623594, DATED 11-27-2006, EXPIRES 4-30-2016.

FOR AUDIO RECORDINGS FEATURING MUSIC; DOWNLOADABLE MUSICAL SOUND RECORDINGS; DOWNLOADABLE RING TONES, GRAPHICS AND MUSIC VIA A GLOBAL COMPUTER NETWORK AND WIRELESS DEVICES; MOTION PICTURE AND DOCUMENTARY FILMS ABOUT MUSIC AND MUSIC ENTERTAINMENT PERFORMANCES; PHONOGRAPH RECORDS FEATURING MUSIC; PRE-RECORDED CD'S, VIDEO TAPES, LASER DISKS AND DVD'S FEATURING MUSIC AND VIDEO (U.S. CLS. 21, 23, 26, 36 AND 38).

JOHN E. MICHOS, EXAMINING ATTORNEY

SN 77-024,923. TECHGUARD SECURITY L.L.C., CHESTERFIELD, MO. FILED 10-19-2006.

TURN ON A HIPPIE

THE MARK CONSISTS OF STANDARD CHARACTERS WITHOUT CLAIM TO ANY PARTICULAR FONT, STYLE, SIZE, OR COLOR.

FOR COMPUTER SECURITY PRODUCTS, NAMELY, COMPUTER SOFTWARE FOR THE CREATION OF FIREWALL FILTERS (U.S. CLS. 21, 23, 26, 36 AND 38).

VERNA BETH RIRIE, EXAMINING ATTORNEY

CLASS 9—(Continued).

SN 77-028,837. CERTAINTeed CORPORATION, VALLEY FORGE, PA. FILED 10-25-2006.

CERTASPEC

THE MARK CONSISTS OF STANDARD CHARACTERS WITHOUT CLAIM TO ANY PARTICULAR FONT, STYLE, SIZE, OR COLOR.

FOR COMPUTER SOFTWARE TO CREATE CUSTOMIZED RESIDENTIAL AND COMMERCIAL BUILDING SPECIFICATIONS (U.S. CLS. 21, 23, 26, 36 AND 38).

CARYN GLASSER, EXAMINING ATTORNEY

SN 77-029,465. AMKOR TECHNOLOGY, INC., CHANDLER, AZ. FILED 10-25-2006.

FUSIONQUAD

THE MARK CONSISTS OF STANDARD CHARACTERS WITHOUT CLAIM TO ANY PARTICULAR FONT, STYLE, SIZE, OR COLOR.

FOR SEMICONDUCTOR PACKAGES, NAMELY, SEMICONDUCTOR PACKAGES COMPRISED OF SEMICONDUCTOR DIES AND INTERCONNECTS (U.S. CLS. 21, 23, 26, 36 AND 38).

ROBERT LAVACHE, EXAMINING ATTORNEY

SN 77-033,123. NOVA GAMING, LLC, GREENVILLE, SC. FILED 10-31-2006.

ULTIMATE GAMING PLATFORM

THE MARK CONSISTS OF STANDARD CHARACTERS WITHOUT CLAIM TO ANY PARTICULAR FONT, STYLE, SIZE, OR COLOR.

NO CLAIM IS MADE TO THE EXCLUSIVE RIGHT TO USE "GAMING PLATFORM", APART FROM THE MARK AS SHOWN.

FOR COMPUTER PROGRAMS FOR USE WITH GAMING MACHINES (U.S. CLS. 21, 23, 26, 36 AND 38).

ROSELLE HERRERA, EXAMINING ATTORNEY

CLASS 9—(Continued).

SN 77-033,914. TRANSOMA MEDICAL, INC., ARDEN HILLS, MN. FILED 11-1-2006.

JET

THE MARK CONSISTS OF STANDARD CHARACTERS WITHOUT CLAIM TO ANY PARTICULAR FONT, STYLE, SIZE, OR COLOR.

FOR TRANSMITTERS, RECEIVERS AND ELECTRONIC RELAY STATIONS FOR COLLECTING, TRANSMITTING, AND ANALYZING PHYSIOLOGICAL DATA COLLECTED FROM ANIMALS, AND INSTRUCTIONAL/USER MANUALS SOLD THEREWITH AS A UNIT (U.S. CLS. 21, 23, 26, 36 AND 38).

DAVID MILLER, EXAMINING ATTORNEY

SN 77-042,300. RESERCOM, L.P., IRVING, TX. FILED 11-13-2006.

RAZ POINT

THE MARK CONSISTS OF STANDARD CHARACTERS WITHOUT CLAIM TO ANY PARTICULAR FONT, STYLE, SIZE, OR COLOR.

FOR COMPUTERS INCORPORATING A TOUCH-SCREEN COMPUTER DISPLAY FOR USE IN THE OPERATIONS OF RESTAURANTS (U.S. CLS. 21, 23, 26, 36 AND 38).

EDWARD FENNESSY, EXAMINING ATTORNEY

SN 77-045,644. THE KEY USA, LLC, SARATOGA SPRINGS, NY. FILED 11-16-2006.

Auto Idiot

THE MARK CONSISTS OF STANDARD CHARACTERS WITHOUT CLAIM TO ANY PARTICULAR FONT, STYLE, SIZE, OR COLOR.

NO CLAIM IS MADE TO THE EXCLUSIVE RIGHT TO USE "AUTO", APART FROM THE MARK AS SHOWN.

FOR DVDS FEATURING INFORMATION ON THE SECRETS OF THE AUTOMOBILE INDUSTRY AND A SIX-STEP SYSTEM TO BUYING, SELLING AND LEASING A CAR (U.S. CLS. 21, 23, 26, 36 AND 38).

TOBY BULLOFF, EXAMINING ATTORNEY

CLASS 9—(Continued).

SN 77-051,909. PNI CORPORATION, SANTA ROSA, CA. FILED 11-28-2006.

ZOOMPOINT

THE MARK CONSISTS OF STANDARD CHARACTERS WITHOUT CLAIM TO ANY PARTICULAR FONT, STYLE, SIZE, OR COLOR.

FOR COMPUTER SOFTWARE FOR USE WITH ELECTRONIC SENSORS FOR POSITION AND MOTION DETECTION (U.S. CLS. 21, 23, 26, 36 AND 38).

JOHN GARTNER, EXAMINING ATTORNEY

SN 77-052,219. APOLLO GATE OPERATORS, INC., SAN ANTONIO, TX. FILED 11-28-2006.



The logo for APOLLO GATE OPERATORS features the word "APOLLO" in a bold, italicized, sans-serif font with horizontal lines through the letters. Below it, the words "GATE OPERATORS" are written in a smaller, all-caps, sans-serif font.

NO CLAIM IS MADE TO THE EXCLUSIVE RIGHT TO USE "GATE OPERATORS", APART FROM THE MARK AS SHOWN.

THE MARK CONSISTS OF SLANTED BOLD LETTERS WITH HORIZONTAL BANDS; HORIZONTAL LINES AND/OR BARS FROM THE TOP TO THE BOTTOM OF EACH LETTER AND EXTENDING Laterally TO THE LEFT OF EACH LETTER.

FOR ELECTRIC GATE OPERATORS (U.S. CLS. 21, 23, 26, 36 AND 38).

FIRST USE 4-25-1988; IN COMMERCE 9-10-1988.

TINA L. SNAPP, EXAMINING ATTORNEY

SN 77-056,905. HONEYWELL INTERNATIONAL INC., MORRISTOWN, NJ. FILED 12-5-2006.

PRIMUS APEX

THE MARK CONSISTS OF STANDARD CHARACTERS WITHOUT CLAIM TO ANY PARTICULAR FONT, STYLE, SIZE, OR COLOR.

FOR AIRBORNE AVIONICS SYSTEM COMPRISED OF COMPUTER HARDWARE, COMPUTER SOFTWARE AND INTERFACE DEVICES, NAMELY, DISPLAY CONTROLLERS, MULTIFUNCTION KEYBOARD, GUIDANCE PANEL, TOUCHSCREEN, TOUCHPAD, TRACKBALL, AND JOYSTICK, WHICH AS A SYSTEM PROVIDES FLIGHT, NAVIGATION AND WEATHER INFORMATION TO PILOTS DURING FLIGHTS (U.S. CLS. 21, 23, 26, 36 AND 38).

MATTHEW MCDOWELL, EXAMINING ATTORNEY

CLASS 9—(Continued).

SN 77-057,525. SAMSUNG ELECTRO-MECHANICS CO., LTD., SUWON-SI, KYUNGKI-DO, REPUBLIC OF KOREA, FILED 12-5-2006.

BAM

THE MARK CONSISTS OF STANDARD CHARACTERS WITHOUT CLAIM TO ANY PARTICULAR FONT, STYLE, SIZE, OR COLOR.

PRIORITY CLAIMED UNDER SEC. 44(D) ON REPUBLIC OF KOREA APPLICATION NO. 2006-0038215, FILED 7-25-2006, REG. NO. 0704206, DATED 3-28-2007, EXPIRES 3-28-2017.

FOR PIEZOELECTRIC ACTUATOR FOR CELLULAR PHONES; CAMERA MODULES FOR CELLULAR PHONES (U.S. CLS. 21, 23, 26, 36 AND 38).

BARBARA GAYNOR, EXAMINING ATTORNEY

SN 77-062,375. VXI CORPORATION, ROLLINSFORD, NH. FILED 12-12-2006.

VXI ROADWARRIOR

THE MARK CONSISTS OF STANDARD CHARACTERS WITHOUT CLAIM TO ANY PARTICULAR FONT, STYLE, SIZE, OR COLOR.

OWNER OF U.S. REG. NOS. 2,398,354, 2,411,090 AND 2,448,108.

NO CLAIM IS MADE TO THE EXCLUSIVE RIGHT TO USE "VXI", APART FROM THE MARK AS SHOWN.

FOR WIRED AND WIRELESS COMMUNICATIONS, CELLULAR, TELEPHONE, AND COMPUTER TELEPHONY EQUIPMENT, NAMELY, HEADSETS, CONNECTORS, CHARGERS, AND RELATED ACCESSORIES (U.S. CLS. 21, 23, 26, 36 AND 38).

FIRST USE 5-10-2005; IN COMMERCE 5-10-2005.
JOANNA DUKOVIC, EXAMINING ATTORNEY

SN 77-063,852. IMMIGRATION HOUSE CALL, INC., STUDIO CITY, CA. FILED 12-13-2006.

Immigration House Call

THE MARK CONSISTS OF STANDARD CHARACTERS WITHOUT CLAIM TO ANY PARTICULAR FONT, STYLE, SIZE, OR COLOR.

NO CLAIM IS MADE TO THE EXCLUSIVE RIGHT TO USE "IMMIGRATION", APART FROM THE MARK AS SHOWN.

FOR PRE-RECORDED CDS, VIDEO TAPES, LASER DISKS AND DVDS FEATURING INFORMATION ABOUT IMMIGRATING TO THE UNITED STATES (U.S. CLS. 21, 23, 26, 36 AND 38).

FIRST USE 4-22-2006; IN COMMERCE 4-22-2006.
MICHAEL ENGEL, EXAMINING ATTORNEY

CLASS 9—(Continued).

SN 77-068,248. ASAHI KASEI CHEMICALS CORPORATION, TOKYO, JAPAN, FILED 12-20-2006.

HIPORE

THE MARK CONSISTS OF STANDARD CHARACTERS WITHOUT CLAIM TO ANY PARTICULAR FONT, STYLE, SIZE, OR COLOR.

FOR MICROPOROUS MEMBRANE MADE OF POLY-OLEFIN RESIN FOR USE AS LITHIUM ION BATTERY SEPARATORS (U.S. CLS. 21, 23, 26, 36 AND 38).

FIRST USE 5-1-1999; IN COMMERCE 5-1-1999.
ROBERT LAVACHE, EXAMINING ATTORNEY

SN 77-068,352. UNIVERSAL EDI CORPORATION, PORTLAND, OR. FILED 12-20-2006.

UEDI

THE MARK CONSISTS OF STANDARD CHARACTERS WITHOUT CLAIM TO ANY PARTICULAR FONT, STYLE, SIZE, OR COLOR.

FOR COMPUTER E-COMMERCE SOFTWARE TO ALLOW USERS TO PERFORM ELECTRONIC BUSINESS TRANSACTIONS VIA A GLOBAL COMPUTER NETWORK (U.S. CLS. 21, 23, 26, 36 AND 38).

LINDA ESTRADA, EXAMINING ATTORNEY

SN 77-069,058. O2MICRO, INC., SANTA CLARA, CA. FILED 12-21-2006.

KARADJ

THE MARK CONSISTS OF STANDARD CHARACTERS WITHOUT CLAIM TO ANY PARTICULAR FONT, STYLE, SIZE, OR COLOR.

FOR INTEGRATED CIRCUITS, MOTION SENSORS AND ELECTRICAL OR ELECTRONIC DEVICES, NAMELY, SENSORS WHICH RECOGNIZE MOVEMENT AND GESTURE, AND ENABLE CORRESPONDING APPLICATION BASED ON MOVEMENT AND GESTURE, FOR INTERFACING WITH A COMPUTER, VIDEO AND/OR AUDIO SYSTEM, SUCH AS DIGITAL CAMERA OR PORTABLE MUSIC PLAYER (U.S. CLS. 21, 23, 26, 36 AND 38).

LINDA ORNDORFF, EXAMINING ATTORNEY

CLASS 9—(Continued).

SN 77-070,488. KARSTEN MANUFACTURING CORPORATION, PHOENIX, AZ. FILED 12-22-2006.

PING

THE MARK CONSISTS OF STANDARD CHARACTERS WITHOUT CLAIM TO ANY PARTICULAR FONT, STYLE, SIZE, OR COLOR.

OWNER OF U.S. REG. NOS. 1,637,647, 3,171,974 AND OTHERS.

FOR COMPUTER SOFTWARE, NAMELY, FILE SHARING SOFTWARE; COMMUNICATIONS SOFTWARE FOR ELECTRONICALLY EXCHANGING DATA, AND GRAPHICS ACCESSIBLE VIA A COMPUTER NETWORK; COMPUTER SOFTWARE AND HARDWARE FOR PROCESSING IMAGES, GRAPHICS, AUDIO, VIDEO, AND TEXT; ALL OF THE FOREGOING MARKETED TO CONSUMERS AND GOLF RETAILERS (U.S. CLS. 21, 23, 26, 36 AND 38).

RAY THOMAS, EXAMINING ATTORNEY

SN 77-072,725. CLEARWELL SYSTEMS, INC., SANTA CLARA, CA. FILED 12-28-2006.

CLEARWELL INTELLIGENCE PLATFORM

THE MARK CONSISTS OF STANDARD CHARACTERS WITHOUT CLAIM TO ANY PARTICULAR FONT, STYLE, SIZE, OR COLOR.

OWNER OF U.S. REG. NO. 3,168,372.

NO CLAIM IS MADE TO THE EXCLUSIVE RIGHT TO USE "INTELLIGENCE PLATFORM", APART FROM THE MARK AS SHOWN.

FOR COMPUTER HARDWARE, COMPUTER SOFTWARE USED TO MANAGE, ORGANIZE, AND ANALYZE DOCUMENTS, PDF FILES, SPREADSHEETS, EMAILS, ATTACHMENTS, INSTANT MESSAGES AND OTHER ELECTRONIC COMMUNICATIONS, AND OTHER ELECTRONICALLY STORED INFORMATION (U.S. CLS. 21, 23, 26, 36 AND 38).

LESLEY LAMOTHE, EXAMINING ATTORNEY

CLASS 9—(Continued).

SN 77-080,304. DATAKEY ELECTRONICS, INC., SAVAGE, MN. FILED 1-10-2007.

DATAKEY

THE MARK CONSISTS OF STANDARD CHARACTERS WITHOUT CLAIM TO ANY PARTICULAR FONT, STYLE, SIZE, OR COLOR.

OWNER OF U.S. REG. NOS. 1,455,104 AND 1,457,273.

FOR BLANK PROGRAMMABLE ELECTRONIC DATA CARRIERS; ELECTRONIC MATING RECEPTACLES USED TO INTERFACE ELECTRONIC DATA CARRIERS WITH MICROPROCESSERS, MICROCONTROLLERS AND PERSONAL COMPUTERS; DATA CARRIER READERS AND WRITERS USED TO INTERFACE WITH MICROPROCESSORS, MICROCONTROLLERS, AND PERSONAL COMPUTERS (U.S. CLS. 21, 23, 26, 36 AND 38).

FIRST USE 2-1-1980; IN COMMERCE 2-1-1980.

WENDY GOODMAN, EXAMINING ATTORNEY

SN 77-082,695. ASTERLITE LIMITED, FLEET, HANTS GU51 4NN, UNITED KINGDOM, FILED 1-14-2007.

Asterlite

THE MARK CONSISTS OF STANDARD CHARACTERS WITHOUT CLAIM TO ANY PARTICULAR FONT, STYLE, SIZE, OR COLOR.

FOR COMMUNICATIONS SOFTWARE FOR CONNECTING VOICE THROUGH A COMPUTER NETWORK; COMPUTER SOFTWARE FOR TELECOMMUNICATIONS TO ENABLE VOICE TELEPHONE ACTIVITIES THROUGH A NETWORK OF COMPUTERS; COMPUTER SOFTWARE FOR TELECOMMUNICATIONS THAT MAY BE DOWNLOADED FROM A GLOBAL COMPUTER NETWORK TO ENABLE VOICE TELEPHONE ACTIVITIES THROUGH A NETWORK OF COMPUTERS; DOWNLOADABLE SOFTWARE FOR TELECOMMUNICATIONS TO ENABLE VOICE TELEPHONE ACTIVITIES THROUGH A NETWORK OF COMPUTERS (U.S. CLS. 21, 23, 26, 36 AND 38).

FIRST USE 1-1-2006; IN COMMERCE 1-3-2006.

AMY HELLA, EXAMINING ATTORNEY

SN 77-084,210. KINTIS, MARK, MANHATTAN BEACH, CA. FILED 1-16-2007.

Stone Rain

THE MARK CONSISTS OF STANDARD CHARACTERS WITHOUT CLAIM TO ANY PARTICULAR FONT, STYLE, SIZE, OR COLOR.

FOR ORIGINAL MUSICAL SOUND RECORDINGS (U.S. CLS. 21, 23, 26, 36 AND 38).

JANET LEE, EXAMINING ATTORNEY

CLASS 9—(Continued).

SN 77-092,775. SECURITY COMPLIANCE CORPORATION, ORINDA, CA. FILED 1-27-2007.

CLASS 9—(Continued).

SN 77-092,776. SECURITY COMPLIANCE CORPORATION, ORINDA, CA. FILED 1-27-2007.



ACCESS AUDITOR

NO CLAIM IS MADE TO THE EXCLUSIVE RIGHT TO USE "SECURITY COMPLIANCE CORPORATION", APART FROM THE MARK AS SHOWN.

FOR COMPUTER SOFTWARE FOR ADMINISTRATION OF COMPUTER LOCAL AREA NETWORKS; COMPUTER SOFTWARE FOR APPLICATION AND DATABASE INTEGRATION; COMPUTER SOFTWARE FOR COMPUTER SYSTEM AND APPLICATION DEVELOPMENT, DEPLOYMENT AND MANAGEMENT; COMPUTER SOFTWARE FOR CONTROLLING AND MANAGING ACCESS SERVER APPLICATIONS; COMPUTER SOFTWARE FOR CREATING SEARCHABLE DATABASES OF INFORMATION AND DATA; COMPUTER SOFTWARE FOR PROVIDING AN ON-LINE DATABASE IN THE FIELD OF TRANSACTION PROCESSING TO UPLOAD TRANSACTIONAL DATA, PROVIDE STATISTICAL ANALYSIS, AND PRODUCE NOTIFICATIONS AND REPORTS; COMPUTER SOFTWARE FOR THE COLLECTION, EDITING, ORGANIZING, MODIFYING, BOOK MARKING, TRANSMISSION, STORAGE AND SHARING OF DATA AND INFORMATION; COMPUTER SOFTWARE FOR USE IN THE SAFEGUARDING OF DIGITAL FILES, INCLUDING AUDIO, VIDEO, TEXT, BINARY, STILL IMAGES, GRAPHICS AND MULTIMEDIA FILES (U.S. CLS. 21, 23, 26, 36 AND 38).

FIRST USE 1-10-2005; IN COMMERCE 1-10-2005.
WENDY GOODMAN, EXAMINING ATTORNEY

THE MARK CONSISTS OF STANDARD CHARACTERS WITHOUT CLAIM TO ANY PARTICULAR FONT, STYLE, SIZE, OR COLOR.

NO CLAIM IS MADE TO THE EXCLUSIVE RIGHT TO USE "ACCESS", APART FROM THE MARK AS SHOWN.

FOR COMPUTER SOFTWARE FOR ADMINISTRATION OF COMPUTER LOCAL AREA NETWORKS; COMPUTER SOFTWARE FOR APPLICATION AND DATABASE INTEGRATION; COMPUTER SOFTWARE FOR COMPUTER SYSTEM AND APPLICATION DEVELOPMENT, DEPLOYMENT AND MANAGEMENT; COMPUTER SOFTWARE FOR CONTROLLING AND MANAGING ACCESS SERVER APPLICATIONS; COMPUTER SOFTWARE FOR CREATING SEARCHABLE DATABASES OF INFORMATION AND DATA; COMPUTER SOFTWARE FOR PROVIDING AN ON-LINE DATABASE IN THE FIELD OF TRANSACTION PROCESSING TO UPLOAD TRANSACTIONAL DATA, PROVIDE STATISTICAL ANALYSIS, AND PRODUCE NOTIFICATIONS AND REPORTS; COMPUTER SOFTWARE FOR THE COLLECTION, EDITING, ORGANIZING, MODIFYING, BOOK MARKING, TRANSMISSION, STORAGE AND SHARING OF DATA AND INFORMATION; COMPUTER SOFTWARE FOR USE IN THE SAFEGUARDING OF DIGITAL FILES, INCLUDING AUDIO, VIDEO, TEXT, BINARY, STILL IMAGES, GRAPHICS AND MULTIMEDIA FILES (U.S. CLS. 21, 23, 26, 36 AND 38).

FIRST USE 1-10-2005; IN COMMERCE 1-10-2005.
WENDY GOODMAN, EXAMINING ATTORNEY

SN 77-095,550. BIOMETRIC ASSOCIATES, L.P., TIMONIUM, MD. FILED 1-31-2007.



FOR COMPUTER HARDWARE FOR MOBILE ELECTRONICS APPLICATIONS FOR IDENTIFICATION AND AUTHENTICATION PURPOSES; WIRELESS SMARTCARD READER FOR IDENTIFICATION AND AUTHENTICATION PURPOSES FOR USE WITH SMARTCARDS, BIOMETRIC DEVICES AND OTHER IDENTIFICATION AND AUTHENTICATION DEVICES; COMPUTER SOFTWARE, NAMELY, CRYPTOGRAPHIC SERVICE PROVIDER (CSP) ENABLING SOFTWARE FOR SMARTCARDS FOR USE IN THE FIELDS OF COMPUTER, NETWORK OR PHYSICAL SECURITY (U.S. CLS. 21, 23, 26, 36 AND 38).

JENNY PARK, EXAMINING ATTORNEY

CLASS 9—(Continued).

SN 77-100,417. IRM CORPORATION, DALLAS, TX. FILED 2-6-2007.

DISCOVERY SYSTEM

THE MARK CONSISTS OF STANDARD CHARACTERS WITHOUT CLAIM TO ANY PARTICULAR FONT, STYLE, SIZE, OR COLOR.

OWNER OF U.S. REG. NO. 2,656,439.

NO CLAIM IS MADE TO THE EXCLUSIVE RIGHT TO USE "SYSTEM", APART FROM THE MARK AS SHOWN.

FOR COMPUTER SOFTWARE THAT PROVIDES REAL-TIME, INTEGRATED BUSINESS MANAGEMENT INTELLIGENCE BY COMBINING INFORMATION FROM VARIOUS DATABASES AND PRESENTING IT IN AN EASY-TO-UNDERSTAND USER INTERFACE (U.S. CLS. 21, 23, 26, 36 AND 38).

FIRST USE 11-1-2006; IN COMMERCE 11-1-2006.

ELIZABETH KAJUBI, EXAMINING ATTORNEY

SN 77-102,738. TREVIGEN, INC., GAITHERSBURG, MD. FILED 2-8-2007.

CULTRECOAT

THE MARK CONSISTS OF STANDARD CHARACTERS WITHOUT CLAIM TO ANY PARTICULAR FONT, STYLE, SIZE, OR COLOR.

FOR LABORATORY EQUIPMENT, NAMELY PLASTIC DISPOSABLE SINGLE AND MULTIPLE WELL, CELL CULTURE PLATES, SLIDES AND CHAMBERS WITH EITHER POROUS OR NON-POROUS CELL SUPPORT AREAS, AND DISPOSABLE PLASTIC OR GLASS CELL CULTURE FLASKS, TUBES AND BOTTLES, HAVING AN ACTIVE SURFACE COATING, FOR USE IN THE LIFE SCIENCE, PHARMACEUTICAL, BIOTECHNOLOGY AND MEDICAL INDUSTRIES (U.S. CLS. 21, 23, 26, 36 AND 38).

SHANNON TWOHIG, EXAMINING ATTORNEY

SN 77-105,330. MONSTER CABLE PRODUCTS, INC, BRISBANE, CA. FILED 2-12-2007.

IEZCLICK

THE MARK CONSISTS OF STANDARD CHARACTERS WITHOUT CLAIM TO ANY PARTICULAR FONT, STYLE, SIZE, OR COLOR.

FOR ELECTRONIC CONTROLLERS FOR USE WITH PORTABLE MEDIA PLAYERS (U.S. CLS. 21, 23, 26, 36 AND 38).

FIRST USE 1-8-2007; IN COMMERCE 1-8-2007.

KAREN BRACEY, EXAMINING ATTORNEY

CLASS 9—(Continued).

SN 77-106,578. CONTROLPATH, INC., DENVER, CO. FILED 2-13-2007.

TRANSFORMING COMPLIANCE THROUGH AUTOMATION

THE MARK CONSISTS OF STANDARD CHARACTERS WITHOUT CLAIM TO ANY PARTICULAR FONT, STYLE, SIZE, OR COLOR.

FOR COMPUTER SOFTWARE FOR AUTOMATION OF GOVERNMENTAL AND REGULATORY COMPLIANCE AND RISK MANAGEMENT FOR GENERAL COMMERCIAL USE (U.S. CLS. 21, 23, 26, 36 AND 38).

FIRST USE 2-1-2006; IN COMMERCE 2-1-2006.

PAUL CROWLEY, EXAMINING ATTORNEY

SN 77-108,395. CUNNINGHAM, EDWARD G., SEAFORD, NY. FILED 2-15-2007.

i am jackk

THE MARK CONSISTS OF STANDARD CHARACTERS WITHOUT CLAIM TO ANY PARTICULAR FONT, STYLE, SIZE, OR COLOR.

FOR AUDIO RECORDINGS FEATURING MUSIC (U.S. CLS. 21, 23, 26, 36 AND 38).

FIRST USE 2-4-1997; IN COMMERCE 9-29-1997.

MARLENE BELL, EXAMINING ATTORNEY

SN 77-108,779. GAY/NERD, BROOKLYN, NY. FILED 2-15-2007.

GAY/NERD MUSIC

THE MARK CONSISTS OF STANDARD CHARACTERS WITHOUT CLAIM TO ANY PARTICULAR FONT, STYLE, SIZE, OR COLOR.

NO CLAIM IS MADE TO THE EXCLUSIVE RIGHT TO USE "MUSIC", APART FROM THE MARK AS SHOWN.

FOR DOWNLOADABLE MUSICAL SOUND RECORDINGS; DOWNLOADABLE RING TONES, GRAPHICS AND MUSIC VIA A GLOBAL COMPUTER NETWORK AND WIRELESS DEVICES; PRE-RECORDED CDS, VIDEO TAPES, LASER DISKS AND DVDS FEATURING MUSIC (U.S. CLS. 21, 23, 26, 36 AND 38).

FIRST USE 2-8-2006; IN COMMERCE 8-15-2006.

AMY BROZENIC, EXAMINING ATTORNEY

CLASS 9—(Continued).

SN 77-109,295. LG ELECTRONICS INC., SEOUL, REPUBLIC OF KOREA, FILED 2-16-2007.

Super Blue

FOR COMPACT DISC PLAYERS (CDP); DIGITAL VERSATILE DISC (DVD) PLAYERS; PRE-RECORDED COMPACT DISCS READ-ONLY MEMORY (CD-ROM) FEATURING CINEMATIC SOUND AND/OR VIDEO RECORDING; PRE-RECORDED DIGITAL VIDEO DISC-READ ONLY MEMORY (DVD-ROM) FEATURING CINEMATIC SOUND AND/OR VIDEO RECORDING; COMPUTERS; COMPUTER MONITORS; TELEVISION RECEIVERS; RECORDED COMPUTER PROGRAMS FOR USE IN DATABASE MANAGEMENT, USE AS A SPREAD SHEET, AND WORD PROCESSING; BLANK CD FOR SOUND AND/OR VIDEO RECORDING; AUDIO COMPONENT AND SOUND RECORDING AND REPRODUCING APPARATUS COMPRISING OF COMPACT DISC (CD) PLAYERS, DIGITAL VERSATILE DISC (DVD) PLAYERS, MPEG AUDIO LAYER-3 (MP3) PLAYERS, VIDEO PLAYERS, DIGITAL AUDIO PLAYERS; VIDEO CASSETTE RECORDER (VCR) PLAYER; HOME THEATER EQUIPMENT, NAMELY, PROJECTORS, STEREOS, SPEAKERS, MODULATORS; SPEAKERS (U.S. CLS. 21, 23, 26, 36 AND 38).

JENNY PARK, EXAMINING ATTORNEY

SN 77-111,662. DESIGN CENTER SOLUTIONS, SAUSALITO, CA. FILED 2-20-2007.

DCS Partnership Group

THE MARK CONSISTS OF STANDARD CHARACTERS WITHOUT CLAIM TO ANY PARTICULAR FONT, STYLE, SIZE, OR COLOR.

NO CLAIM IS MADE TO THE EXCLUSIVE RIGHT TO USE "PARTNERSHIP GROUP", APART FROM THE MARK AS SHOWN.

FOR COMPUTER HARDWARE AND COMPUTER SOFTWARE PROGRAMS FOR THE INTEGRATION OF TEXT, AUDIO, GRAPHICS, STILL IMAGE AND MOVING PICTURES INTO AN INTERACTIVE DELIVERY FOR MULTIMEDIA APPLICATIONS (U.S. CLS. 21, 23, 26, 36 AND 38).

FIRST USE 11-15-2006; IN COMMERCE 12-1-2006.

JIM RINGLE, EXAMINING ATTORNEY

CLASS 9—(Continued).

SN 77-114,307. GROUNDREZ LLC, NEW YORK, NY. FILED 2-23-2007.



FOR DOWNLOADABLE COMPUTER SOFTWARE WHICH ENABLES USERS IN THE TRAVEL INDUSTRY TO MAKE GROUND TRANSPORTATION RESERVATIONS OVER THE INTERNET (U.S. CLS. 21, 23, 26, 36 AND 38).

TASNEEM HUSSAIN, EXAMINING ATTORNEY

SN 77-116,532. AFL TELECOMMUNICATIONS LLC, DUNCAN, SC. FILED 2-26-2007.

BENDLITE

THE MARK CONSISTS OF STANDARD CHARACTERS WITHOUT CLAIM TO ANY PARTICULAR FONT, STYLE, SIZE, OR COLOR.

FOR CABLE ASSEMBLIES COMPRISED OF A PROTECTIVE SHEATH AND SPECIAL OPTICAL FIBER WITH LOW ATTENUATION WITH BENDING CHARACTERISTICS (U.S. CLS. 21, 23, 26, 36 AND 38).

FIRST USE 8-1-2006; IN COMMERCE 8-1-2006.

BILL DAWE, EXAMINING ATTORNEY

SN 77-117,292. SMITHS HEIMANN SAS, VITRY-SUR-SEINE, FRANCE, FILED 2-27-2007.

ARD

THE MARK CONSISTS OF STANDARD CHARACTERS WITHOUT CLAIM TO ANY PARTICULAR FONT, STYLE, SIZE, OR COLOR.

FOR SCANNING APPARATUS, NAMELY, CONTAINER AND VEHICLE SCANNERS; APPARATUS FOR CHECKING CONTAINERS AND VEHICLES USING X-RAYS; MONITORING APPARATUS USING X-RAYS FOR VIEWING THE INTERIOR OF CONTAINERS AND VEHICLES; APPARATUS FOR SCANNING CARGO; INSTALLATIONS CONSISTING OF COMBINATIONS OF THE AFORESAID GOODS; AND PARTS AND FITTINGS FOR ALL THE AFORESAID GOODS (U.S. CLS. 21, 23, 26, 36 AND 38).

ELI HELLMAN, EXAMINING ATTORNEY

CLASS 9—(Continued).

SN 77-119,629. HUCKESTEIN, WILLIAM, WESTLAKE VIL-
LAGE, CA. FILED 3-1-2007.

LUXENTIA

THE MARK CONSISTS OF STANDARD CHARACTERS WITHOUT CLAIM TO ANY PARTICULAR FONT, STYLE, SIZE, OR COLOR.

FOR ELECTRONIC PICTURE-FRAMES FOR THE RECEPTION, STORAGE AND TRANSMISSION OF DATA, NAMELY, PHOTOGRAPHS, PICTURES, MESSAGES, IMAGES, CHARACTERS AND SYMBOLS FOR DISPLAY PURPOSES; DEVICES TO FACILITATE THE PLAYBACK, STORAGE, DUPLICATION, DELETION, TRANSFER, RECEIVING AND EDITING OF DIGITAL STILL IMAGES, VIDEO, AND AUDIO, NAMELY PORTABLE EXTERNAL HARD DRIVES WITH BUILT-IN MEMORY CARD READER WITH OR WITHOUT DISPLAYS; REMOVABLE SOLID STATE STORAGE DEVICES, NAMELY, FLASH MEMORY UNITS; DEVICES TO INTERFACE WITH AND PROCESS INFORMATION FROM REMOVABLE SOLID STATE STORAGE DEVICES, NAMELY, MEMORY CARD READER/WRITERS; DEVICES TO FACILITATE PLAYBACK OF DIGITAL DATA THROUGH EXTERNAL DISPLAY DEVICES, NAMELY, PORTABLE EXTERNAL HARD DISK DRIVES WITH AN INTERNAL VIDEO AND AUDIO MICROPROCESSOR AND VIDEO AND AUDIO OUTPUT JACKS; DEVICES TO FACILITATE PLAYBACK OF DIGITAL DATA THROUGH AN ONBOARD DISPLAY DEVICE, NAMELY, HANDHELD MULTIMEDIA PLAYERS, HANDHELD VIDEO PLAYERS, DIGITAL PHOTO FRAMES; COMPUTER SOFTWARE TO ASSIST PLAYBACK, STORAGE, DUPLICATION, DELETION, TRANSFER, RECEIVING AND EDITING OF DIGITAL DATA, NAMELY, IMAGE MANAGEMENT SOFTWARE; DEVICES USED TO FACILITATE THE CONNECTION AND OPERATION OF MULTIPLE PERIPHERAL DEVICES WITH A PERSONAL COMPUTER, NAMELY, USB HUBS; DEVICES USED TO FACILITATE THE TRANSFER OF DATA BETWEEN PERIPHERAL DEVICES AND BETWEEN PERIPHERAL DEVICES AND A PERSONAL COMPUTER, NAMELY, DATA BRIDGES; ALTERNATING CURRENT ADAPTERS FOR DIGITAL PRODUCTS; HEADPHONES (U.S. CLS. 21, 23, 26, 36 AND 38).

ANDREA BUTLER, EXAMINING ATTORNEY

CLASS 9—(Continued).

SN 77-123,872. HOLLA DOLLA ENTERTAINMENT, LLC,
WOODSTOCK, GA. FILED 3-6-2007.



NO CLAIM IS MADE TO THE EXCLUSIVE RIGHT TO USE "ENTERTAINMENT" AND "ENT. LLC", APART FROM THE MARK AS SHOWN.

THE COLOR(S) YELLOW, PURPLE, ORANGE AND WHITE IS/ARE CLAIMED AS A FEATURE OF THE MARK.

THE COLOR YELLOW APPEARS IN THE SPHERE. THE COLOR PURPLE APPEARS IN THE LETTER "H". THE COLORS ORANGE AND PURPLE APPEAR IN THE "D" NEXT TO THE LETTER "H". THE COLOR PURPLE APPEARS IN THE WORDS HOLLA DOLLA ENT. LLC. THE COLOR PURPLE ALSO APPEARS IN THE WORD ENTERTAINMENT AND THE OUTLINE OF THE RECTANGLE SURROUNDING IT. THE COLOR WHITE APPEARS IN THE RECTANGLE AROUND THE WORD ENTERTAINMENT AND IN THE WORDS OUTTA GIT DAT CASH.

FOR AUDIO RECORDINGS FEATURING MUSIC (U.S. CLS. 21, 23, 26, 36 AND 38).

SANI KHOURI, EXAMINING ATTORNEY

SN 77-126,465. MASTER LOCK COMPANY LLC, OAK
CREEK, WI. FILED 3-9-2007.

STARTER SENTRY

NO CLAIM IS MADE TO THE EXCLUSIVE RIGHT TO USE "STARTER", APART FROM THE MARK AS SHOWN.

THE MARK CONSISTS OF THE WORD STARTER IN A RECTANGLE SHAPE AND THE WORD SENTRY APPEARING AFTER THAT.

FOR ANTI-THEFT DEVICES FOR VEHICLES IN THE NATURE OF ELECTRONIC VEHICLE IMMOBILIZERS (U.S. CLS. 21, 23, 26, 36 AND 38).

JILL PRATER, EXAMINING ATTORNEY

CLASS 9—(Continued).

SN 77-126,473. MASTER LOCK COMPANY LLC, OAK CREEK, WI. FILED 3-9-2007.

MASTER LOCK STARTER SENTRY

THE MARK CONSISTS OF STANDARD CHARACTERS WITHOUT CLAIM TO ANY PARTICULAR FONT, STYLE, SIZE, OR COLOR.

NO CLAIM IS MADE TO THE EXCLUSIVE RIGHT TO USE "STARTER", APART FROM THE MARK AS SHOWN.

FOR ANTI-THEFT DEVICES FOR VEHICLES IN THE NATURE OF ELECTRONIC VEHICLE IMMOBILIZERS (U.S. CLS. 21, 23, 26, 36 AND 38).

JILL PRATER, EXAMINING ATTORNEY

SN 77-128,778. MAB PROFESSIONAL SERVICES, INC., DBA BROOKLYN INDEPENDENT STUDIOS, BROOKLYN, NY. FILED 3-12-2007.

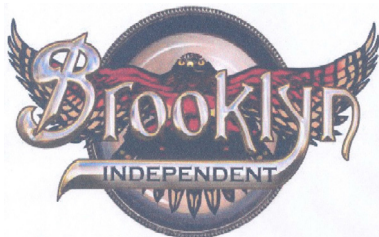

NO CLAIM IS MADE TO THE EXCLUSIVE RIGHT TO USE "BROOKLYN INDEPENDENT", APART FROM THE MARK AS SHOWN.

THE COLOR(S) SILVER, BLACK, RED, ORANGE, BROWN, LIGHT SILVER, GREY AND YELLOW IS/ARE CLAIMED AS A FEATURE OF THE MARK.

THE MARK CONSISTS OF THE WORD BROOKLYN AND THE WORD INDEPENDENT IN THE LEG OF THE LETTER Y WITH BOTH SUPER-IMPOSED ON A REPRESENTATION OF AN EAGLE, ALL ON A CIRCULAR BACKGROUND. THE LETTERING OF THE WORD BROOKLYN IS SILVER, THE LETTERING OF THE WORD INDEPENDENT IS BLACK, THE WINGS AND BODY OF THE EAGLE ARE BLACK, RED, ORANGE, AND BROWN, THE EAGLE'S EYES ARE YELLOW AND BLACK, THE BEAK IS YELLOW, AND THE TAIL IS BLACK AND BROWN. THE CENTRAL PART OF THE CIRCULAR BACKGROUND IS LIGHT SILVER AND THE INNER CIRCULAR PERIPHERY IS BLACK ON THE TOP HALF AND GREY AND BLACK ON THE BOTTOM HALF AND THE OTHER PERIPHERY IS BLACK AND CONTAINS A YELLOW SCROLL.

FOR PRERECORDED FILMS, PRERECORDED VIDEO TAPES AND DOWNLOADABLE VIDEO RECORDINGS VIA A GLOBAL COMPUTER NETWORK AND WIRELESS DEVICES, ALL FEATURING MOTION PICTURES AND DOCUMENTARIES (U.S. CLS. 21, 23, 26, 36 AND 38).

SHANNON TWOHIG, EXAMINING ATTORNEY

CLASS 9—(Continued).

SN 77-129,067. CHEYENNE MOUNTAIN ENTERTAINMENT, INC., MESA, AZ. FILED 3-12-2007.

DEADLANDS

THE MARK CONSISTS OF STANDARD CHARACTERS WITHOUT CLAIM TO ANY PARTICULAR FONT, STYLE, SIZE, OR COLOR.

FOR SOFTWARE AND ELECTRONIC GAMES, NAMELY, SOFTWARE GAMES RECORDED ON CD-ROM AND DIGITAL VIDEO DISCS FOR COMPUTERS, SOFTWARE GAMES RECORDED ON CD-ROMS, DIGITAL VIDEO DISCS, AND CARTRIDGES FOR CONSOLE AND INDIVIDUAL PORTABLE GAMING SYSTEMS, SOFTWARE GAMES THAT ARE DOWNLOADABLE FROM A REMOTE COMPUTER SITE, AND SOFTWARE GAMES FOR MOBILE PHONES, PERSONAL DIGITAL ASSISTANTS, AND HANDHELD COMPUTERS; DOWNLOADABLE RING TONES VIA THE INTERNET AND WIRELESS DEVICES; DOWNLOADABLE VOICE RING TONES VIA THE INTERNET AND WIRELESS DEVICES; DOWNLOADABLE WALL PAPERS, NAMELY STILL IMAGES FOR BACKGROUNDS ON PHONE SCREENS VIA THE INTERNET AND WIRELESS DEVICES; DOWNLOADABLE SCREEN SAVERS VIA THE INTERNET AND WIRELESS DEVICES; DOWNLOADABLE ANIMATED IMAGES FOR USE ON PHONE SCREENS VIA THE INTERNET AND WIRELESS DEVICES; AND COMPUTER SOFTWARE FOR DOWNLOADING IMAGES FOR MOBILE TELECOMMUNICATION DEVICES, NAMELY, MOBILE AND CELLULAR TELEPHONES, HANDHELD COMPUTERS, PERSONAL COMPUTERS AND PERSONAL DIGITAL ASSISTANTS VIA THE GLOBAL COMPUTER NETWORK AND WIRELESS DEVICES (U.S. CLS. 21, 23, 26, 36 AND 38).

JAMES A. RAUEN, EXAMINING ATTORNEY

SN 77-129,434. CPFD SOFTWARE, LLC, ALBUQUERQUE, NM. FILED 3-13-2007.

SEEFOAM

THE MARK CONSISTS OF STANDARD CHARACTERS WITHOUT CLAIM TO ANY PARTICULAR FONT, STYLE, SIZE, OR COLOR.

FOR COMPUTER SOFTWARE AND COMPUTER PROGRAMS FOR USE IN ENGINEERING AND INDUSTRIAL PROCESS EQUIPMENT DESIGN, ANALYSIS AND RESEARCH (U.S. CLS. 21, 23, 26, 36 AND 38).

FIRST USE 11-7-2005; IN COMMERCE 11-7-2005.

ALLISON HOLTZ, EXAMINING ATTORNEY

CLASS 9—(Continued).

SN 77-129,816. DIETZ, DAN L., HOUSTON, TX. FILED 3-13-2007.

Cyclops

THE MARK CONSISTS OF STANDARD CHARACTERS WITHOUT CLAIM TO ANY PARTICULAR FONT, STYLE, SIZE, OR COLOR.

FOR VEHICLE VIEWING DEVICES COMPRISED OF A VIDEO CAMERA AND EITHER A PLASMA DISPLAY, A LIGHT EMITTING DIODE DISPLAY, A LIQUID CRYSTAL DISPLAY OR A CATHODE RAY TUBE DISPLAY WHICH ARE INSTALLED ON VEHICLES FOR VIEWING INSIDE OR OUTSIDE OF A VEHICLE AND PARTS AND FITTINGS THEREFORE, NAMELY, A MAGNETIC BASE, A LIGHT, A LIGHT SWITCH, AND AN ADJUSTABLE SUPPORT; AND VEHICLE HITCH AIDS COMPRISED OF A VIDEO CAMERA AND EITHER A PLASMA DISPLAY, A LIGHT EMITTING DIODE DISPLAY, A LIQUID CRYSTAL DISPLAY OR A CATHODE RAY TUBE DISPLAY WHICH ARE INSTALLED ON THE REAR OF VEHICLES TO AID IN THE ALIGNMENT OF VEHICLE HITCH WITH A TRAILER, AND PARTS AND FITTINGS THEREFORE, NAMELY, A MAGNETIC BASE, A LIGHT, A LIGHT SWITCH, AND AN ADJUSTABLE SUPPORT (U.S. CLS. 21, 23, 26, 36 AND 38).

BILL DAWE, EXAMINING ATTORNEY

SN 77-132,940. XPRESSYSTEMS, INC., NEW PRAGUE, MN. FILED 3-16-2007.



NO CLAIM IS MADE TO THE EXCLUSIVE RIGHT TO USE "EXPRESS WASH", APART FROM THE MARK AS SHOWN.

THE COLOR(S) BLACK AND BLUE IS/ARE CLAIMED AS A FEATURE OF THE MARK.

THE MARK CONSISTS OF XPRESWASH IN BLACK WITH A BLUE WATER DROP AND BLUE RADIO WAVES.

FOR RFID READERS; RADIO FREQUENCY IDENTIFICATION (RFID) CREDENTIALS, NAMELY, CARDS AND TAGS, AND READERS FOR RADIO FREQUENCY IDENTIFICATION CREDENTIALS; RADIO FREQUENCY IDENTIFICATION (RFID) TAGS (U.S. CLS. 21, 23, 26, 36 AND 38).

DAVID ELTON, EXAMINING ATTORNEY

CLASS 9—(Continued).

SN 77-137,009. WOVEN SYSTEMS, INC., SANTA CLARA, CA. FILED 3-21-2007.

Woven Dashboard

THE MARK CONSISTS OF STANDARD CHARACTERS WITHOUT CLAIM TO ANY PARTICULAR FONT, STYLE, SIZE, OR COLOR.

NO CLAIM IS MADE TO THE EXCLUSIVE RIGHT TO USE "DASHBOARD", APART FROM THE MARK AS SHOWN.

FOR APPLICATION AND GRAPHICAL USER INTERFACE SOFTWARE FOR CONFIGURATION, OPERATION, PERFORMANCE MONITORING, AND SECURITY CONTROL OF COMPUTER NETWORKS (U.S. CLS. 21, 23, 26, 36 AND 38).

JULIE THOMAS, EXAMINING ATTORNEY

SN 77-137,019. WOVEN SYSTEMS, INC., SANTA CLARA, CA. FILED 3-21-2007.

Wovenscope

THE MARK CONSISTS OF STANDARD CHARACTERS WITHOUT CLAIM TO ANY PARTICULAR FONT, STYLE, SIZE, OR COLOR.

FOR APPLICATION AND GRAPHICAL USER INTERFACE SOFTWARE FOR COMPUTER NETWORKS, NAMELY, COMPUTER PROGRAMS FOR MONITORING AND CONTROLLING THE PERFORMANCE, EFFICIENCY, AND SECURITY OF THE COMPUTER NETWORK (U.S. CLS. 21, 23, 26, 36 AND 38).

JULIE THOMAS, EXAMINING ATTORNEY

SN 77-137,239. DAYMEN PHOTO MARKETING LP, MARKHAM, ONTARIO, CANADA, FILED 3-21-2007.



OWNER OF U.S. REG. NOS. 1,207,957, 3,093,751 AND OTHERS.

THE COLOR(S) BLUE, ORANGE, BLACK AND WHITE IS/ARE CLAIMED AS A FEATURE OF THE MARK.

THE MARK CONSISTS OF A WHITE POLAR BEAR

CLASS 9—(Continued).

OUTLINED IN BLACK WITH LIGHT BLUE SHADING AND A BLUE BACKGROUND ENCLOSED BY A THIN WHITE CIRCULAR INNER BORDER AND A THICKER BLACK CIRCULAR OUTER BORDER. BELOW THE POLAR BEAR IS THE WORD "LOWEPRO" IN WHITE LETTERS WITH A BLACK MOUNTAIN WITHIN AN ORANGE SEMICIRCLE ON TOP OF THE WORD "LOWEPRO". THE WORDS "PROTECTING THE POLAR BEAR" APPEAR IN WHITE LETTERS LOCATED WITHIN THE OUTER BLACK CIRCLE.

FOR BAGS, HARD AND SOFT COVERED CASES, RUCKSACKS, HOLDALLS, BACKPACKS WITH ROLLING WHEELS, BACKPACKS WITHOUT ROLLING WHEELS, BELT PACKS, POCKETS, TOTE BAG, SHOULDER BAGS, MESSENGER BAGS AND POUCHES, ALL DESIGNED FOR CARRYING PHOTOGRAPHIC, CINEMATOGRAPHIC, VIDEOGRAPHIC, OPTICAL, AUDIO, ELECTRONIC AND COMPUTER EQUIPMENT; FILM ORGANIZERS, NAMELY CASES FOR CARRYING EXPOSED AND UNEXPOSED CAMERA FILM; CELL PHONE POUCHES; WAIST HARNESSSES AND SHOULDER HARNESSSES DESIGNED FOR USE WITH THE FOREGOING GOODS (U.S. CLS. 21, 23, 26, 36 AND 38).

APRIL ROACH, EXAMINING ATTORNEY

SN 77-137,958. BRK BRANDS, INC., AURORA, IL. FILED 3-22-2007.

BRK

THE MARK CONSISTS OF STANDARD CHARACTERS WITHOUT CLAIM TO ANY PARTICULAR FONT, STYLE, SIZE, OR COLOR.

OWNER OF U.S. REG. NOS. 1,921,636 AND 2,782,480.

FOR FIRE, SMOKE, AND GAS DETECTORS (U.S. CLS. 21, 23, 26, 36 AND 38).

FIRST USE 1-8-1965; IN COMMERCE 1-8-1965.

JESSICA FATHY, EXAMINING ATTORNEY

SN 77-138,975. LITEPOINT CORPORATION, SUNNYVALE, CA. FILED 3-23-2007.

 LITEPOINT

THE COLOR(S) ORANGE AND BLACK IS/ARE CLAIMED AS A FEATURE OF THE MARK.

THE MARK CONSISTS OF A STYLED COMBINATION OF THE LETTERS "L" AND "P" ALONG WITH THE WORD LITEPOINT. THE LETTER "P" IS ORANGE. THE REST OF THE MARK IS BLACK.

FOR CIRCUIT TESTERS; WIRELESS ELECTRONIC TESTING EQUIPMENT, NAMELY, TESTERS FOR WIRELESS SYSTEMS (U.S. CLS. 21, 23, 26, 36 AND 38).

FIRST USE 1-1-2001; IN COMMERCE 1-1-2001.

PAUL F. GAST, EXAMINING ATTORNEY

CLASS 9—(Continued).

SN 77-139,305. EO SYSTEM CO., LTD., INCHEON, REPUBLIC OF KOREA, FILED 3-23-2007.

EGEO

THE COLOR(S) RED AND WHITE IS/ARE CLAIMED AS A FEATURE OF THE MARK.

THE MARK CONSISTS OF A RED "EGEO" CHARACTERS ON THE WHITE BACKGROUND.

FOR SURVEYING MACHINES AND INSTRUMENTS; GLOBAL POSITIONING SYSTEM; GLOBAL POSITIONING SYSTEM (GPS) CONSISTING OF COMPUTERS, COMPUTER SOFTWARE, TRANSMITTERS, RECEIVERS, AND NETWORK INTERFACE DEVICES; COMPUTER SOFTWARE FOR WIRELESS CONTENT DELIVERY; DEVICES FOR WIRELESS RADIO TRANSMISSION; LASER SCANNERS FOR INDUSTRIAL INSPECTION; ENCODERS; TELESCOPES; SENSORS FOR THE DETERMINATION OF TEMPERATURES, POSITIONS AND DISTANCES, AND TILTING HEADS THEREFOR; LEVEL MEASURING MACHINES (U.S. CLS. 21, 23, 26, 36 AND 38).

MICHAEL ENGEL, EXAMINING ATTORNEY

SN 77-140,475. DISNEY ENTERPRISES, INC., BURBANK, CA. FILED 3-26-2007.

IRIDESSA

THE MARK CONSISTS OF STANDARD CHARACTERS WITHOUT CLAIM TO ANY PARTICULAR FONT, STYLE, SIZE, OR COLOR.

FOR AUDIO CASSETTE RECORDERS; AUDIO CASSETTE PLAYERS; PRE-RECORDED AUDIO CASSETTES, AUDIO DISCS, COMPACT DISCS FEATURING MUSIC, STORIES AND GAMES FOR CHILDREN; AUDIO SPEAKERS; BINOCULARS; CALCULATORS; CAMCORDERS; CAMERAS; PRE-RECORDED CD-ROMS FEATURING COMPUTER GAMES AND ACTIVITIES FOR CHILDREN; COMPUTER HARDWARE, NAMELY CD-ROM DRIVES; COMPUTER HARDWARE, NAMELY, CD-ROM WRITERS; COMPUTER HARDWARE, NAMELY, MODEMS; CELLULAR TELEPHONES; CELLULAR TELEPHONE ACCESSORIES, NAMELY, HEADPHONES, HEAD SETS, ADAPTERS AND BATTERIES FOR CELLULAR TELEPHONES; CELLULAR TELEPHONE CASES; FACE PLATES FOR CELLULAR TELEPHONES; COMPACT DISC PLAYERS; COMPACT DISC RECORDERS; COMPUTER GAME PROGRAMS; COMPUTER GAME CARTRIDGES AND DISCS; COMPUTERS; COMPUTER HARDWARE; COMPUTER KEYBOARDS; COMPUTER MONITORS; COMPUTER MOUSE; COMPUTER DISC DRIVES; COMPUTER SOFTWARE, NAMELY, COMPUTER GAMES AND LEARN-

CLASS 9—(Continued).

ING ACTIVITIES FOR CHILDREN; CORDLESS TELEPHONES; DECORATIVE MAGNETS; DIGITAL CAMERAS; PRE-RECORDED DVDS, DIGITAL VERSATILE DISCS, DIGITAL VIDEO DISCS AND VIDEO CASSETTES, ALL FEATURING LIVE ACTION AND ANIMATED ENTERTAINMENT FOR CHILDREN, MOTION PICTURE FILMS FEATURING LIVE ACTION AND ANIMATED ENTERTAINMENT FOR CHILDREN AND TELEVISION SHOWS; DVD PLAYERS; DVD RECORDERS; ELECTRONIC PERSONAL ORGANIZERS; EYEGLASS CASES; EYEGLASSES; HEADPHONES; KARAOKE MACHINES; MICROPHONES; MP3 PLAYERS; MOUSE PADS; MOTION PICTURE FILMS; PAGERS; PERSONAL STEREOs; PERSONAL DIGITAL ASSISTANTS; PRINTERS; RADIOS; SUNGLASSES; TELEPHONES; TELEVISION SETS; VIDEO CAMERAS; VIDEO CASSETTE RECORDERS; VIDEO CASSETTE PLAYERS; VIDEO GAME CARTRIDGES; VIDEO GAME DISCS; VIDEOPHONES; WALKIE-TALKIES; WRIST AND ARM RESTS FOR USE WITH COMPUTERS (U.S. CLS. 21, 23, 26, 36 AND 38).

AMY BROZENIC, EXAMINING ATTORNEY

SN 77-140,509. MICROSOFT CORPORATION, REDMOND, WA. FILED 3-26-2007.



OWNER OF U.S. REG. NOS. 2,738,877 AND 2,744,843.
THE MARK CONSISTS OF AN IMAGE OF THREE SUPERIMPOSED DVD DISCS WITH A FLOWER DESIGN ON THE DISCS WHICH ARE LOCATED IN THE CENTER OF THREE TRANSPARENT DVD CASES WITH STYLIZED FLAGS BELOW THE DISCS.

FOR OPERATING SYSTEM SOFTWARE; COMPUTER SOFTWARE FOR CREATING AND EDITING DVDS (U.S. CLS. 21, 23, 26, 36 AND 38).

THOMAS MANOR, EXAMINING ATTORNEY

CLASS 9—(Continued).

SN 77-141,144. AUTOMOTIVE RENTALS, INC., MOUNT LAUREL, NJ. FILED 3-27-2007.

ENVIROFLEET

THE MARK CONSISTS OF STANDARD CHARACTERS WITHOUT CLAIM TO ANY PARTICULAR FONT, STYLE, SIZE, OR COLOR.

FOR DOWNLOADABLE AUDIO FILES, MULTIMEDIA FILES, TEXT FILES, WRITTEN DOCUMENTS, AUDIO MATERIAL AND VIDEO MATERIAL FEATURING INFORMATION IN THE FIELD OF DRIVER EDUCATION; DOWNLOADABLE ELECTRONIC PUBLICATIONS IN THE NATURE OF NEWSLETTERS IN THE FIELD OF ALTERNATIVE FUEL VEHICLES (U.S. CLS. 21, 23, 26, 36 AND 38).

FIRST USE 5-4-2001; IN COMMERCE 5-4-2001.
ANDREW RHIM, EXAMINING ATTORNEY

SN 77-142,499. HOUSE OF MSH, INC, EAST MEADOW, NY. FILED 3-28-2007.

City Chick Magazine

THE MARK CONSISTS OF STANDARD CHARACTERS WITHOUT CLAIM TO ANY PARTICULAR FONT, STYLE, SIZE, OR COLOR.

NO CLAIM IS MADE TO THE EXCLUSIVE RIGHT TO USE MAGAZINE, APART FROM THE MARK AS SHOWN. FOR ELECTRONIC PUBLICATIONS, NAMELY, MAGAZINE FEATURING THE WONDERFUL THINGS ABOUT NEW YORK CITY RECORDED ON COMPUTER MEDIA (U.S. CLS. 21, 23, 26, 36 AND 38).

DOMINICK J. SALEMI, EXAMINING ATTORNEY

CLASS 9—(Continued).

SN 77-144,751. IRUBIN CONSULTING, INC., LOS ANGELES, CA. FILED 3-30-2007.



THE COLOR(S) PINK, MAGENTA, BLACK, AND WHITE IS/ARE CLAIMED AS A FEATURE OF THE MARK.

THE MARK CONSISTS OF A WHITE, STYLIZED LETTER "M" ON TOP OF A CUBE TO THE LEFT OF THE WORDING "MAGENTO" IN BLACK. THE TOP FACE OF THE CUBE IS IN PINK, AND THE SIDE FACES OF CUBE ARE IN MAGENTA.

FOR COMPUTER E-COMMERCE SOFTWARE TO ALLOW USERS TO PERFORM ELECTRONIC BUSINESS TRANSACTIONS VIA A GLOBAL COMPUTER NETWORK (U.S. CLS. 21, 23, 26, 36 AND 38).

TINA KUAN, EXAMINING ATTORNEY

CLASS 9—(Continued).

SN 77-147,065. FUHR SOFTWARE, INC., COLUMBUS, OH. FILED 4-3-2007.

LobbyCentral

Can you see me now?

THE MARK CONSISTS OF STANDARD CHARACTERS WITHOUT CLAIM TO ANY PARTICULAR FONT, STYLE, SIZE, OR COLOR.

FOR COMPUTER SOFTWARE THAT PLACES CUSTOMERS INTO ELECTRONIC WAITING QUEUES TO BE HANDLED BY SERVICE EMPLOYEE USERS (U.S. CLS. 21, 23, 26, 36 AND 38).

MARY MUNSON, EXAMINING ATTORNEY

SN 77-148,891. DOUGLAS E GELLER, DAVIE, FL. FILED 4-4-2007.

SynchSite

THE MARK CONSISTS OF STANDARD CHARACTERS WITHOUT CLAIM TO ANY PARTICULAR FONT, STYLE, SIZE, OR COLOR.

FOR COMPUTER PROGRAM, NAMELY, SYNCHRONIZATION SOFTWARE PROGRAM DESIGNED TO MIGRATE DATA FROM A USER'S ACCOUNTING SYSTEM TO A DOCUMENT MANAGEMENT SYSTEM (U.S. CLS. 21, 23, 26, 36 AND 38).

DAVID COLLIER, EXAMINING ATTORNEY

SN 77-146,786. EMERGENCY TRAFFIC SYSTEMS INC., MIAMI, FL. FILED 4-2-2007.

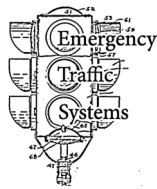

SN 77-148,894. DOUGLAS E GELLER, DAVIE, FL. FILED 4-4-2007.

SendSite

NO CLAIM IS MADE TO THE EXCLUSIVE RIGHT TO USE "EMERGENCY TRAFFIC SYSTEMS", APART FROM THE MARK AS SHOWN.

THE STIPPLING IS FOR SHADING PURPOSES ONLY.

THE MARK CONSISTS OF THE BACKGROUND CONTAINS A BLUEPRINT TYPE DRAWING OF A TRAFFIC LIGHT, DESIGN WITH THE WORDS "EMERGENCY TRAFFIC SYSTEMS" IN THE FOREGROUND PROCEEDING FROM EACH OF THE TRAFFIC LIGHTS.

FOR TRAFFIC LIGHTS; TRAFFIC-LIGHT APPARATUS (U.S. CLS. 21, 23, 26, 36 AND 38).

BILL DAWE, EXAMINING ATTORNEY

THE MARK CONSISTS OF STANDARD CHARACTERS WITHOUT CLAIM TO ANY PARTICULAR FONT, STYLE, SIZE, OR COLOR.

FOR COMPUTER PROGRAM, NAMELY, SOFTWARE PROGRAM DESIGNED TO STORE EMAILS IN DOCUMENT MANAGEMENT SYSTEM (U.S. CLS. 21, 23, 26, 36 AND 38).

DAVID COLLIER, EXAMINING ATTORNEY

CLASS 9—(Continued).

SN 77-149,124. HEAT-TIMER CORP., FAIRFIELD, NJ. FILED 4-5-2007.

DIGI-SPAN

THE MARK CONSISTS OF STANDARD CHARACTERS WITHOUT CLAIM TO ANY PARTICULAR FONT, STYLE, SIZE, OR COLOR.

FOR ELECTRICAL TEMPERATURE SET-POINT CONTROLLER (U.S. CLS. 21, 23, 26, 36 AND 38).
FIRST USE 7-13-1984; IN COMMERCE 7-13-1984.
ALYSSA PALADINO, EXAMINING ATTORNEY

SN 77-150,196. MAUCERI, FRANK, CHICAGO, IL. FILED 4-5-2007.

SMOG VEIL RECORDS

THE MARK CONSISTS OF STANDARD CHARACTERS WITHOUT CLAIM TO ANY PARTICULAR FONT, STYLE, SIZE, OR COLOR.

NO CLAIM IS MADE TO THE EXCLUSIVE RIGHT TO USE "RECORDS", APART FROM THE MARK AS SHOWN.
FOR COMPACT DISCS FEATURING MUSIC; DVDS FEATURING MUSIC; PHONOGRAPH RECORDS FEATURING MUSIC (U.S. CLS. 21, 23, 26, 36 AND 38).
FIRST USE 11-3-1991; IN COMMERCE 11-3-1991.
ANDREA SAUNDERS, EXAMINING ATTORNEY

SN 77-150,352. TELEBRANDS CORPORATION, FAIRFIELD, NJ. FILED 4-6-2007.

DISC JUKEBOX

THE MARK CONSISTS OF STANDARD CHARACTERS WITHOUT CLAIM TO ANY PARTICULAR FONT, STYLE, SIZE, OR COLOR.

NO CLAIM IS MADE TO THE EXCLUSIVE RIGHT TO USE "DISC", APART FROM THE MARK AS SHOWN.
FOR PORTABLE CONTAINER FOR HOLDING COMPACT DISCS (U.S. CLS. 21, 23, 26, 36 AND 38).
CORY BOONE, EXAMINING ATTORNEY

CLASS 9—(Continued).

SN 77-150,419. CITADEL COMPUTER CORPORATION, MANCHESTER, NH. FILED 4-6-2007.

CITADEL NETFORCE

THE MARK CONSISTS OF STANDARD CHARACTERS WITHOUT CLAIM TO ANY PARTICULAR FONT, STYLE, SIZE, OR COLOR.

FOR DISPLAY DEVICES, NAMELY, TOUCH SCREEN DISPLAYS IN THE NATURE OF COMPUTER MONITORS FOR DISPLAYING INFORMATION IN AN INDUSTRIAL ENVIRONMENT (U.S. CLS. 21, 23, 26, 36 AND 38).

HEATHER SAPP, EXAMINING ATTORNEY

SN 77-150,702. SPX CORPORATION, CHARLOTTE, NC. FILED 4-6-2007.

ScanPro

THE MARK CONSISTS OF STANDARD CHARACTERS WITHOUT CLAIM TO ANY PARTICULAR FONT, STYLE, SIZE, OR COLOR.

FOR ELECTRONIC AUTOMOTIVE DIAGNOSTIC EQUIPMENT, NAMELY, APPARATUS FOR DIAGNOSTIC TESTING AND LIVE DATA RETRIEVAL FOR COMPUTERIZED AUTOMOBILE SYSTEMS, NAMELY, HAND HELD DIAGNOSTIC TOOL FOR INTERFACING WITH AN AUTOMOBILE'S ELECTRONIC CONTROL UNIT'S ON BOARD DIAGNOSTICS READER; CODE READERS FOR USE IN RETRIEVING AND CLEARING DIAGNOSTIC TROUBLE CODES FOR COMPUTERIZED AUTOMOBILE SYSTEMS (U.S. CLS. 21, 23, 26, 36 AND 38).

FIRST USE 3-0-2005; IN COMMERCE 3-0-2005.
WANDA KAY PRICE, EXAMINING ATTORNEY

CLASS 9—(Continued).

SN 77-151,523. SEGMA, LLC, SILVER SPRING, MD. FILED 4-9-2007.



NO CLAIM IS MADE TO THE EXCLUSIVE RIGHT TO USE "TECHNOLOGIES INC.", APART FROM THE MARK AS SHOWN.

THE COLOR(S) WHITE, BLUE, AND GREY IS/ARE CLAIMED AS A FEATURE OF THE MARK.

THE MARK CONSISTS OF THE LOGO CONSISTS OF A BLUE BOX, WHERE PARTS OF THE OUTLINE OF THE BOX IS MISSING FORMING A CAPITAL LETTER S, WHICH IS VISIBLE ON THE WHITE BACKGROUND, THE LETTERS SEGMA ARE IN BLUE, THE TERM TECHNOLOGIES INC. IS IN GREY, THE LINES BELOW AND ABOVE THE TERM TECHNOLOGIES INC. ARE IN BLUE.

FOR COMPUTER E-COMMERCE SOFTWARE TO ALLOW USERS TO PERFORM ELECTRONIC BUSINESS TRANSACTIONS VIA A GLOBAL COMPUTER NETWORK; COMPUTER SOFTWARE FOR ACCESSING INFORMATION DIRECTORIES THAT MAY BE DOWNLOADED FROM THE GLOBAL COMPUTER NETWORK; COMPUTER SOFTWARE THAT PROVIDES REAL-TIME, INTEGRATED BUSINESS MANAGEMENT INTELLIGENCE BY COMBINING INFORMATION FROM VARIOUS DATABASES AND PRESENTING IT IN AN EASY-TO-UNDERSTAND USER INTERFACE (U.S. CLS. 21, 23, 26, 36 AND 38).

KATHLEEN M. VANSTON, EXAMINING ATTORNEY

SN 77-151,528. PANNAWAY TECHNOLOGIES, INC., PORTSMOUTH, NH. FILED 4-9-2007.

REDEFINING BROADBAND CONVERGENCE

THE MARK CONSISTS OF STANDARD CHARACTERS WITHOUT CLAIM TO ANY PARTICULAR FONT, STYLE, SIZE, OR COLOR.

FOR TELECOMMUNICATIONS AND DATA NETWORKING HARDWARE, NAMELY, DEVICES FOR TRANSPORTING AND AGGREGATING VOICE, DATA, AND VIDEO COMMUNICATIONS ACROSS MULTIPLE NETWORK INFRASTRUCTURES AND COMMUNICATIONS PROTOCOLS (U.S. CLS. 21, 23, 26, 36 AND 38).

JAY BESCH, EXAMINING ATTORNEY

CLASS 9—(Continued).

SN 77-151,683. NEXTONE COMMUNICATIONS, INC., GAITHERSBURG, MD. FILED 4-9-2007.

INTELLIGENT EDGE

THE MARK CONSISTS OF STANDARD CHARACTERS WITHOUT CLAIM TO ANY PARTICULAR FONT, STYLE, SIZE, OR COLOR.

FOR COMPUTER HARDWARE AND SOFTWARE FOR ENABLING VOICE, VIDEO, DATA, COMPUTER MEDIA, ELECTRONIC MEDIA, TELECOMMUNICATION MEDIA AND FACSIMILE TRAFFIC TO BE INTEGRATED INTO WORLD WIDE WEB PROTOCOL AND FOR PROVIDING VALUE-ADDED SERVICES, NAMELY PUBLIC NETWORK-BASED PBX SERVICES, ROAMING SERVICES AND UNIFIED MESSAGING SERVICES (U.S. CLS. 21, 23, 26, 36 AND 38).

B. PARADEWELAI, EXAMINING ATTORNEY

SN 77-151,714. ELSEVIER LIMITED, KIDLINGTON, OXFORD, UNITED KINGDOM, FILED 4-9-2007.

TETRAHEDRON

THE MARK CONSISTS OF STANDARD CHARACTERS WITHOUT CLAIM TO ANY PARTICULAR FONT, STYLE, SIZE, OR COLOR.

FOR ELECTRONIC DOWNLOADABLE PUBLICATIONS, NAMELY, JOURNALS IN THE FIELDS OF SCIENCE AND CHEMISTRY (U.S. CLS. 21, 23, 26, 36 AND 38).

FIRST USE 3-31-1998; IN COMMERCE 3-31-1998.
MICHELE SWAIN, EXAMINING ATTORNEY

CLASS 9—(Continued).

SN 77-151,742. GRADUATE MANAGEMENT ADMISSION COUNCIL, MCLEAN, VA. FILED 4-9-2007.

THE OFFICIAL GMAT PRACTICE
TEST

THE MARK CONSISTS OF STANDARD CHARACTERS WITHOUT CLAIM TO ANY PARTICULAR FONT, STYLE, SIZE, OR COLOR.

OWNER OF U.S. REG. NOS. 1,220,864, 2,289,281 AND OTHERS.

NO CLAIM IS MADE TO THE EXCLUSIVE RIGHT TO USE "OFFICIAL" AND "PRACTICE TEST", APART FROM THE MARK AS SHOWN.

SEC. 2(F).

FOR COMPUTER PROGRAMS FOR USE IN EDUCATIONAL TESTING, TEST SCORING AND TEST REPORTING RELATED TO A SERIES OF EXAMINATIONS USED AS AN AID IN DETERMINING ADMISSION TO GRADUATE MANAGEMENT EDUCATION PROGRAMS, AS WELL AS GUIDANCE AND PLACEMENT (U.S. CLS. 21, 23, 26, 36 AND 38).

FIRST USE 7-31-1997; IN COMMERCE 7-31-1997.

MICHAEL TANNER, EXAMINING ATTORNEY

SN 77-152,070. AKROS SILICON, INC., FOLSOM, CA. FILED 4-9-2007.

SILICON EDGE

THE MARK CONSISTS OF STANDARD CHARACTERS WITHOUT CLAIM TO ANY PARTICULAR FONT, STYLE, SIZE, OR COLOR.

NO CLAIM IS MADE TO THE EXCLUSIVE RIGHT TO USE "SILICON", APART FROM THE MARK AS SHOWN.

FOR SEMICONDUCTOR CHIPS; SEMICONDUCTORS (U.S. CLS. 21, 23, 26, 36 AND 38).

CHRISTINA SOBRAL, EXAMINING ATTORNEY

SN 77-152,083. WORDEN BROTHERS, INC., DURHAM, NC. FILED 4-9-2007.

BACKSCANNER

THE MARK CONSISTS OF STANDARD CHARACTERS WITHOUT CLAIM TO ANY PARTICULAR FONT, STYLE, SIZE, OR COLOR.

FOR COMPUTER SOFTWARE FOR SEARCHING, COMPILING AND ANALYZING DATA IN THE FIELD OF EXCHANGE TRADING, OPTIONS, COMMODITIES AND FINANCIAL SECURITIES (U.S. CLS. 21, 23, 26, 36 AND 38).

FIRST USE 11-6-2006; IN COMMERCE 11-10-2006.

CHRISTOPHER OTT, EXAMINING ATTORNEY

CLASS 9—(Continued).

SN 77-152,296. KARAWAY GAMING, TUCSON, AZ. FILED 4-9-2007.

TRUE BAN-NAG

THE MARK CONSISTS OF STANDARD CHARACTERS WITHOUT CLAIM TO ANY PARTICULAR FONT, STYLE, SIZE, OR COLOR.

OWNER OF U.S. REG. NO. 2,897,557.

NO CLAIM IS MADE TO THE EXCLUSIVE RIGHT TO USE "BAN-NAG", APART FROM THE MARK AS SHOWN. FOR ELECTRONIC GAME SOFTWARE (U.S. CLS. 21, 23, 26, 36 AND 38).

BARBARA BROWN, EXAMINING ATTORNEY

SN 77-152,610. BAUSCH & LOMB INCORPORATED, ROCHESTER, NY. FILED 4-10-2007.

BOSTON XO2

THE MARK CONSISTS OF STANDARD CHARACTERS WITHOUT CLAIM TO ANY PARTICULAR FONT, STYLE, SIZE, OR COLOR.

OWNER OF U.S. REG. NOS. 1,263,457, 2,965,111 AND OTHERS.

SEC. 2(F) AS TO "BOSTON".

FOR CONTACT LENSES AND PLASTIC BLANKS FOR CONTACT LENSES (U.S. CLS. 21, 23, 26, 36 AND 38).

WILLIAM VERHOSEK, EXAMINING ATTORNEY

SN 77-152,648. ROGUE AMOEBA SOFTWARE, LLC, CRANBURY, NJ. FILED 4-10-2007.

AUDIO HIJACK

THE MARK CONSISTS OF STANDARD CHARACTERS WITHOUT CLAIM TO ANY PARTICULAR FONT, STYLE, SIZE, OR COLOR.

NO CLAIM IS MADE TO THE EXCLUSIVE RIGHT TO USE "AUDIO", APART FROM THE MARK AS SHOWN.

FOR COMPUTER SOFTWARE FOR RECORDING AND MANIPULATING DIGITAL AUDIO INFORMATION FOR USE IN A WIDE VARIETY OF AUDIO MEDIA APPLICATIONS BASED UPON THE DISCRETION OF THE END USER (U.S. CLS. 21, 23, 26, 36 AND 38).

FIRST USE 9-30-2002; IN COMMERCE 9-30-2002.

TRICIA SONNEBORN, EXAMINING ATTORNEY

CLASS 9—(Continued).

SN 77-152,793. FAHMI, AZIM, ORANGE, CT. FILED 4-10-2007.

NOT JUST AN EMR SOLUTION.
TOTAL ELECTRONIC WORK FLOW
SOLUTION

THE MARK CONSISTS OF STANDARD CHARACTERS WITHOUT CLAIM TO ANY PARTICULAR FONT, STYLE, SIZE, OR COLOR.
FOR COMPUTER SOFTWARE FOR CONTROLLING AND MANAGING PATIENT MEDICAL INFORMATION (U.S. CLS. 21, 23, 26, 36 AND 38).
TONJA GASKINS, EXAMINING ATTORNEY

SN 77-152,795. ADVERTISING DATABASE, INC., NEW YORK, NY. FILED 4-10-2007.

ADVERTISING DATABASE CANVAS

THE MARK CONSISTS OF STANDARD CHARACTERS WITHOUT CLAIM TO ANY PARTICULAR FONT, STYLE, SIZE, OR COLOR.
NO CLAIM IS MADE TO THE EXCLUSIVE RIGHT TO USE "ADVERTISING DATABASE", APART FROM THE MARK AS SHOWN.
FOR DOWNLOADABLE COMPUTER SOFTWARE AND CD-ROMS COMPRISED OF A DIRECTORY OF COMMERCIAL INFORMATION ABOUT BRAND AND ADVERTISING AGENCY NAMES AND NEWS, INCLUDING BRAND DEMOGRAPHIC AND GEOGRAPHICAL TARGETS, BUDGETS, PLUS OTHER MEDIA PLANNING CRITERIA, AND INSTRUCTION MANUALS, SOLD AS A UNIT (U.S. CLS. 21, 23, 26, 36 AND 38).
STEVEN PEREZ, EXAMINING ATTORNEY

CLASS 9—(Continued).

SN 77-153,332. ASTRUM, LLC, LAS VEGAS, NV. FILED 4-10-2007.

ASTRUM RECORDS

THE MARK CONSISTS OF STANDARD CHARACTERS WITHOUT CLAIM TO ANY PARTICULAR FONT, STYLE, SIZE, OR COLOR.

NO CLAIM IS MADE TO THE EXCLUSIVE RIGHT TO USE "RECORDS", APART FROM THE MARK AS SHOWN.

THE ENGLISH TRANSLATION OF "ASTRUM" IS "STAR" OR "CONSTELLATION".

FOR AUDIO AND VIDEO RECORDINGS, CDS, DVDS, PHONORECORDS AND OPTICAL, MAGNETIC, DIGITAL AND ELECTRONIC DATA CARRIERS FEATURING ENTERTAINMENT, MUSIC AND MUSICAL PERFORMANCES; DOWNLOADABLE ONLINE DISCUSSION BOARDS, WEB CASTS, AND POD CASTS FEATURING ENTERTAINMENT, MUSIC AND MUSICAL PERFORMANCES; AND ELECTRONIC PUBLICATIONS IN THE FIELDS OF ENTERTAINMENT, MUSIC AND MUSICAL PERFORMANCES RECORDED ON COMPUTER MEDIA (U.S. CLS. 21, 23, 26, 36 AND 38).
REBECCA EISINGER, EXAMINING ATTORNEY

SN 77-154,010. MAXELL CORPORATION OF AMERICA, FAIR LAWN, NJ. FILED 4-11-2007.

PEANUTZ

THE MARK CONSISTS OF STANDARD CHARACTERS WITHOUT CLAIM TO ANY PARTICULAR FONT, STYLE, SIZE, OR COLOR.

FOR HEADPHONES, NAMELY, STEREO EAR BUDS THAT ARE USED IN PORTABLE AUDIO AND VIDEO PLAYERS, NAMELY, CD PLAYERS, DVD PLAYERS, AND MP3 PLAYERS (U.S. CLS. 21, 23, 26, 36 AND 38).
MICHAEL LITZAU, EXAMINING ATTORNEY

SN 77-154,474. APPLIED IDENTITY, INC, SAN FRANCISCO, CA. FILED 4-11-2007.

ID-Audit

THE MARK CONSISTS OF STANDARD CHARACTERS WITHOUT CLAIM TO ANY PARTICULAR FONT, STYLE, SIZE, OR COLOR.

FOR HARDWARE AND SOFTWARE FOR NETWORK ACTIVITY REPORTING AND ANALYSIS (U.S. CLS. 21, 23, 26, 36 AND 38).

KATHERINE E. HALMEN, EXAMINING ATTORNEY

CLASS 9—(Continued).

SN 77-154,881. GOLDEN BITS SOFTWARE, INC., SAN DIEGO, CA. FILED 4-12-2007.

QUERYSHARK

THE MARK CONSISTS OF STANDARD CHARACTERS WITHOUT CLAIM TO ANY PARTICULAR FONT, STYLE, SIZE, OR COLOR.

FOR COMPUTER SOFTWARE WHICH COLLECTS CRITICAL ERROR INFORMATION AND SYSTEM CONFIGURATION INFORMATION TO FACILITATE THE REMOTE MANAGEMENT OF MULTIPLE COMPUTER SYSTEMS AND NETWORKS (U.S. CLS. 21, 23, 26, 36 AND 38).

MICHELLE DUBOIS, EXAMINING ATTORNEY

SN 77-154,927. COPYTELE, INC., MELVILLE, NY. FILED 4-12-2007.

PND

THE MARK CONSISTS OF STANDARD CHARACTERS WITHOUT CLAIM TO ANY PARTICULAR FONT, STYLE, SIZE, OR COLOR.

FOR FLAT PANEL DISPLAYS (U.S. CLS. 21, 23, 26, 36 AND 38).

ANDREA K. NADELMAN, EXAMINING ATTORNEY

SN 77-154,928. FRANCIOSE, LAURAN, SOUTH PORTLAND, ME. FILED 4-12-2007.



THE MARK CONSISTS OF WINGS AROUND A CENTER CIRCLE WITH THE NAME INTINTIONS - THE POWER OF MAGNETIC INTENT.

FOR A SET OF INSPIRATIONAL REFRIGERATOR MAGNETS PACKAGED IN A TIN (U.S. CLS. 21, 23, 26, 36 AND 38).

SHAILA SETTLES, EXAMINING ATTORNEY

CLASS 9—(Continued).

SN 77-154,980. YIYANG ZIJIANG ELECTRON COMPONENTS CO., LTD, YIYANG, CHINA, FILED 4-12-2007.

AISHI

OWNER OF CHINA REG. NO. 3743248, DATED 7-14-2005, EXPIRES 7-13-2015.

THE MARK CONSISTS OF STYLIZED WORDING "AISHI".

FOR CONDENSERS; FOIL ELEMENTS, NAMELY, CIRCUITS FOR HEATING OR ELECTRICAL CONDUCTION (U.S. CLS. 21, 23, 26, 36 AND 38).

TOBY BULLOFF, EXAMINING ATTORNEY

SN 77-155,240. METHOD SOLUTIONS LLC, ADDISON, TX. FILED 4-12-2007.

BLING WINGS

THE MARK CONSISTS OF STANDARD CHARACTERS WITHOUT CLAIM TO ANY PARTICULAR FONT, STYLE, SIZE, OR COLOR.

FOR ELECTRONIC GAME SOFTWARE (U.S. CLS. 21, 23, 26, 36 AND 38).

JENNIFER HETU, EXAMINING ATTORNEY

SN 77-155,655. SEYBOLD, ANDREW, SANTA BARBARA, CA. FILED 4-12-2007.

INFINIG

THE MARK CONSISTS OF STANDARD CHARACTERS WITHOUT CLAIM TO ANY PARTICULAR FONT, STYLE, SIZE, OR COLOR.

FOR PROVIDING DOWNLOADABLE ELECTRONIC NEWSLETTERS IN THE FIELDS OF WIRELESS DATA TECHNOLOGY, MOBILITY COMPUTING TECHNOLOGY, AND MOBILITY COMMUNICATIONS TECHNOLOGY (U.S. CLS. 21, 23, 26, 36 AND 38).

FIRST USE 3-27-2007; IN COMMERCE 3-27-2007.

KEVIN CORWIN, EXAMINING ATTORNEY

CLASS 9—(Continued).

SN 77-155,787. THE NEUTRAL NET, LLC, STERLING, VA. FILED 4-13-2007.

FutureGrid

THE MARK CONSISTS OF STANDARD CHARACTERS WITHOUT CLAIM TO ANY PARTICULAR FONT, STYLE, SIZE, OR COLOR.

FOR AUTOMATED PROCESS CONTROL SYSTEM, NAMELY, MICRO-PROCESSOR BASED HARDWARE AND SOFTWARE USED TO MONITOR THE STATUS OF INDUSTRIAL PROCESSES, NAMELY POWER GENERATION, ELECTRICAL DISTRIBUTION AND OIL AND GAS PROCESSING (U.S. CLS. 21, 23, 26, 36 AND 38).

KIMBERLY PERRY, EXAMINING ATTORNEY

CLASS 9—(Continued).

SN 77-156,057. SYSTEM DEVELOPMENT, INC, HOUSTON, TX. FILED 4-13-2007.

SDI MontagePLUS

THE MARK CONSISTS OF STANDARD CHARACTERS WITHOUT CLAIM TO ANY PARTICULAR FONT, STYLE, SIZE, OR COLOR.

FOR COMPUTER SOFTWARE FOR VIEWING, EDITING, CONVERTING, CUTTING AND SPLICING, MARK-UP, MERGING AND EXPORTING COMPUTER GRAPHICS METAFILES; COMPUTER PROGRAMS FOR VIEWING, EDITING, CONVERTING, CUTTING AND SPLICING, MARK-UP, MERGING AND EXPORTING COMPUTER GRAPHICS METAFILES (U.S. CLS. 21, 23, 26, 36 AND 38).

FIRST USE 3-26-2007; IN COMMERCE 3-26-2007.
MICHELLE DUBOIS, EXAMINING ATTORNEY

SN 77-155,986. PRODISC TECHNOLOGY INC., SHINCHUAN, TAIWAN, FILED 4-13-2007.

iLens

NO CLAIM IS MADE TO THE EXCLUSIVE RIGHT TO USE "LENS", APART FROM THE MARK AS SHOWN.

THE MARK CONSISTS OF THE WORD "ILENS", STYLIZED.

FOR OPTICAL AND OPHTHALMIC LENSES, EYEGLASSES, SPECTACLES, SUNGLASSES, FRAMES FOR SPECTACLES AND SUNGLASSES, LENSES FOR SPECTACLES AND SUNGLASSES, CASES FOR SPECTACLES AND SUNGLASSES, RETAINERS FOR SPECTACLES AND SUNGLASSES, CONTACT LENSES, CASES AND HOLDERS FOR CONTACT LENSES, LENSES FOR DIGITAL CAMERAS (U.S. CLS. 21, 23, 26, 36 AND 38).

ROBIN CHOSID, EXAMINING ATTORNEY

SN 77-156,067. BASIS TECHNOLOGY CORPORATION, CAMBRIDGE, MA. FILED 4-13-2007.

LANTERN SEARCH

THE MARK CONSISTS OF STANDARD CHARACTERS WITHOUT CLAIM TO ANY PARTICULAR FONT, STYLE, SIZE, OR COLOR.

NO CLAIM IS MADE TO THE EXCLUSIVE RIGHT TO USE "SEARCH", APART FROM THE MARK AS SHOWN.

FOR COMPUTER SOFTWARE AND SOFTWARE COMPONENTS FOR CROSS-LINGUAL INFORMATION RETRIEVAL (U.S. CLS. 21, 23, 26, 36 AND 38).

MICHELLE DUBOIS, EXAMINING ATTORNEY

SN 77-155,988. LAIRD TECHNOLOGIES, INC., DELAWARE WATERGAP, PA. FILED 4-13-2007.

ULTRASPHERE

THE MARK CONSISTS OF STANDARD CHARACTERS WITHOUT CLAIM TO ANY PARTICULAR FONT, STYLE, SIZE, OR COLOR.

FOR ANTENNAS (U.S. CLS. 21, 23, 26, 36 AND 38).

ALEXANDER L. POWERS, EXAMINING ATTORNEY

SN 77-156,150. TOTAL PROTECTION SOLUTIONS, LLC, ORLANDO, FL. FILED 4-13-2007.

TOTAL HOME SURGE PROTECTION SOLUTION

THE MARK CONSISTS OF STANDARD CHARACTERS WITHOUT CLAIM TO ANY PARTICULAR FONT, STYLE, SIZE, OR COLOR.

NO CLAIM IS MADE TO THE EXCLUSIVE RIGHT TO USE "HOME SURGE PROTECTION", APART FROM THE MARK AS SHOWN.

FOR VOLTAGE SURGE SUPPRESSORS (U.S. CLS. 21, 23, 26, 36 AND 38).

FIRST USE 1-12-2005; IN COMMERCE 6-24-2006.
JEFF DEFORD, EXAMINING ATTORNEY

CLASS 9—(Continued).

SN 77-156,162. JOB SIGHT SOLUTIONS, SACRAMENTO, CA. FILED 4-13-2007.

JOBLINK

THE MARK CONSISTS OF STANDARD CHARACTERS WITHOUT CLAIM TO ANY PARTICULAR FONT, STYLE, SIZE, OR COLOR.

FOR INTEGRATED WIRELESS TELEPHONE AND HIGH SPEED DATA SYSTEMS COMPRISED OF TELECOMMUNICATIONS EQUIPMENT, NAMELY, TELEPHONES, MODEMS, RADIOS, PRINTED CIRCUITS, RADIO TRANSMITTERS AND RECEIVERS, TRANSCIVERS, WIRELESS ADAPTORS, WIRELESS BRIDGES, TELECOMMUNICATIONS SWITCHES AND ANTENNAS, AND COMPUTER SOFTWARE IN THE FIELD OF MOBILE AND FIXED WIRELESS COMMUNICATIONS FOR TRANSMISSION OF VOICE, DATA AND VIDEO OVER RADIO FREQUENCIES (U.S. CLS. 21, 23, 26, 36 AND 38).

JEFF DEFORD, EXAMINING ATTORNEY

SN 77-156,348. THERMO FISHER SCIENTIFIC INC., SUGAR LAND, TX. FILED 4-13-2007.

M-PULSE

THE MARK CONSISTS OF STANDARD CHARACTERS WITHOUT CLAIM TO ANY PARTICULAR FONT, STYLE, SIZE, OR COLOR.

FOR MEASURING APPARATUS, NAMELY APPARATUS FOR USE IN THE PETROLEUM INDUSTRY FOR MEASURING LARGE VOLUME LIQUID FLOW OR BULK TRANSFER OF CRUDE OIL, PETROLEUM, AND OTHER LIQUID PETROCHEMICAL PRODUCTS (U.S. CLS. 21, 23, 26, 36 AND 38).

JASON BLAIR, EXAMINING ATTORNEY

SN 77-156,386. VEECO INSTRUMENTS INC., WOODBURY, NY. FILED 4-13-2007.

INSIGHT

THE MARK CONSISTS OF STANDARD CHARACTERS WITHOUT CLAIM TO ANY PARTICULAR FONT, STYLE, SIZE, OR COLOR.

FOR METROLOGY INSTRUMENTS AND COMPONENTS THEREOF, NAMELY, SCANNING PROBE MICROSCOPES (SPMS) AND ATOMIC FORCE MICROSCOPES (AFMS) (U.S. CLS. 21, 23, 26, 36 AND 38).

LEE-ANNE BERNIS, EXAMINING ATTORNEY

CLASS 9—(Continued).

SN 77-156,461. MITEK SYSTEMS, INC., SAN DIEGO, CA. FILED 4-13-2007.

BILLIONS OF IMAGES. THOUSANDS OF PATTERNS. ONE SOLUTION.

THE MARK CONSISTS OF STANDARD CHARACTERS WITHOUT CLAIM TO ANY PARTICULAR FONT, STYLE, SIZE, OR COLOR.

FOR COMPUTER SOFTWARE FOR USE IN DOCUMENT IMAGING AND INTELLIGENT CHARACTER RECOGNITION; AND INSTRUCTIONAL BOOKS AND MANUALS SOLD THEREWITH (U.S. CLS. 21, 23, 26, 36 AND 38).

AMY BROZENIC, EXAMINING ATTORNEY

SN 77-156,463. DAVID BROOKS, FONTANA, CA. FILED 4-13-2007.



NO CLAIM IS MADE TO THE EXCLUSIVE RIGHT TO USE "RECORDS", APART FROM THE MARK AS SHOWN.

THE MARK CONSISTS OF A CREST OR SHIELD WITH A SKYLINE OF A CITY EMBOSSED ON IT, A BANNER ACROSS THE FRONT EMBODYING THE WORDS "HOOD ACADEMY", AND THE WORD RECORDS UNDERNEATH THE BANNER. THE TOP OF A MICROPHONE WITH A CROWN (CLOSED AT THE TOP) OVER THE MOUTHPIECE PROTRUDES OUT OF THE TOP OF THE CREST.

FOR DOWNLOADABLE MP3 FILES, MP3 RECORDINGS, ONLINE DISCUSSION BOARDS, WEB CASTS, POD CASTS FEATURING MUSIC, AUDIO BOOKS AND NEWS BROADCASTS; DOWNLOADABLE MUSICAL SOUND RECORDINGS; DOWNLOADABLE RING TONES, GRAPHICS AND MUSIC VIA A GLOBAL COMPUTER NETWORK AND WIRELESS DEVICES; DOWNLOADABLE VIDEO RECORDINGS FEATURING MUSIC; MUSICAL SOUND RECORDINGS; MUSICAL VIDEO RECORDINGS; PRE-RECORDED CDS, VIDEO TAPES, LASER DISKS AND DVDS FEATURING MUSIC; DOWNLOADABLE MUSIC AND RINGTONES VIA THE INTERNET AND WIRELESS DEVICES; SOUND RECORDINGS FEATURING MUSIC; VIDEO RECORDINGS FEATURING MUSIC (U.S. CLS. 21, 23, 26, 36 AND 38).

FIRST USE 4-10-2007; IN COMMERCE 4-10-2007.

AMY BROZENIC, EXAMINING ATTORNEY

CLASS 9—(Continued).

SN 77-156,507. INFINERA CORPORATION, SUNNYVALE, CA. FILED 4-13-2007.

I-PIC

THE MARK CONSISTS OF STANDARD CHARACTERS WITHOUT CLAIM TO ANY PARTICULAR FONT, STYLE, SIZE, OR COLOR.

OWNER OF U.S. REG. NO. 3,144,381.
FOR OPTICAL INTEGRATED CIRCUIT CHIPS EMPLOYED IN OPTICAL APPLICATIONS INVOLVING GENERATION, MANIPULATION AND/OR RECEPTION OF OPTICAL SIGNALS, SUCH AS IN OPTICAL TRANSPORT NETWORKS (U.S. CLS. 21, 23, 26, 36 AND 38).
ADA HAN, EXAMINING ATTORNEY

SN 77-156,984. TEN-8 SOFTWARE SOLUTIONS, LLC, WEST PALM BEACH, FL. FILED 4-15-2007.

CSIP

**CRIMINAL STATUTE
IDENTIFICATION PROGRAM**

NO CLAIM IS MADE TO THE EXCLUSIVE RIGHT TO USE "PROGRAM", APART FROM THE MARK AS SHOWN. THE COLOR(S) BLUE IS/ARE CLAIMED AS A FEATURE OF THE MARK.

THE MARK CONSISTS OF A STYLIZED LETTER "C" A STYLIZED LETTER "S" A STYLIZED LETTER "I" A STYLIZED LETTER "P" THE SYLIZED WORD "CRIMINAL" THE STYLIZED WORD "STATUTE" THE STYLIZED WORD "IDENTIFICATION" THE STYLIZED WORD "PROGRAM".

FOR COMPUTER HARDWARE AND COMPUTER SOFTWARE PROGRAMS FOR THE INTEGRATION OF TEXT, AUDIO, GRAPHICS, STILL IMAGE AND MOVING PICTURES INTO AN INTERACTIVE DELIVERY FOR MULTIMEDIA APPLICATIONS (U.S. CLS. 21, 23, 26, 36 AND 38).

JULIE THOMAS, EXAMINING ATTORNEY

SN 77-157,107. SYSTEMS SOFTWARE AND INSTRUMENTATION LIMITED, CHRISTCHURCH, NEW ZEALAND, FILED 4-15-2007.



Global Bake

THE MARK CONSISTS OF THE WORD GLOBALBAKE SEPERATED WITH A CRESCENT PASSING BETWEEN THE GLOBAL AND BAKE SECTIONS.

FOR COMPUTER SOFTWARE FOR THE FOOD INDUSTRY TO IMPROVE EFFICIENCY IN ADMINISTRATION (U.S. CLS. 21, 23, 26, 36 AND 38).

BRIDGETT SMITH, EXAMINING ATTORNEY

CLASS 9—(Continued).

SN 77-157,198. AUTOMATED PROCESSES, INC., JESSUP, MD. FILED 4-16-2007.

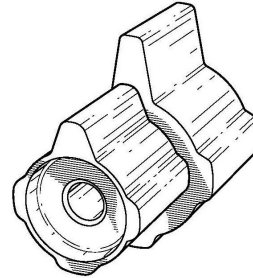

THE LINING IN THE DRAWING IS FOR SHADING PURPOSES ONLY.

THE MARK CONSISTS OF THE PRODUCT CONFIGURATION OF A TWO TIER CONTROL KNOB.

SEC. 2(F).

FOR ELECTRONIC EQUIPMENT, NAMELY, MICROPHONE PREAMPS, AUDIO EQUALIZERS, AUDIO COMPRESSORS FOR PROCESSING AUDIO SIGNALS, AND AUDIO MIXING CONSOLES, NAMELY, AUDIO MIXER CONSOLES (U.S. CLS. 21, 23, 26, 36 AND 38).

FIRST USE 0-0-1968; IN COMMERCE 0-0-1968.

KAREN BRACEY, EXAMINING ATTORNEY

SN 77-157,382. ONEMEDNET CORPORATION, AURORA, OR. FILED 4-16-2007.

OneMedNet

THE MARK CONSISTS OF STANDARD CHARACTERS WITHOUT CLAIM TO ANY PARTICULAR FONT, STYLE, SIZE, OR COLOR.

FOR COMPUTER HARDWARE AND SOFTWARE, FOR USE WITH MEDICAL PATIENT MONITORING EQUIPMENT, FOR RECEIVING, PROCESSING, TRANSMITTING AND DISPLAYING DATA; COMPUTER SOFTWARE FOR CONTROLLING AND MANAGING PATIENT MEDICAL INFORMATION; DOWNLOADABLE SCIENTIFIC AND MEDICAL DATA VIA THE INTERNET; ELECTRONIC APPARATUS, NAMELY, STAND ALONE DISPLAYS FOR MEDICAL IMAGES; ELECTRONIC READERS/RECORDERS FOR MEDICAL PATIENT IDENTIFICATION BANDS (U.S. CLS. 21, 23, 26, 36 AND 38).

KATHLEEN M. VANSTON, EXAMINING ATTORNEY

CLASS 9—(Continued).

SN 77-157,418. SAYAG, MICHEL, MOUNTAIN VIEW, CA.
FILED 4-16-2007.

HIRIS

THE MARK CONSISTS OF STANDARD CHARACTERS
WITHOUT CLAIM TO ANY PARTICULAR FONT, STYLE,
SIZE, OR COLOR.

FOR DIGITAL CAMERAS (U.S. CLS. 21, 23, 26, 36 AND
38).

VIVIAN MICZNIK FIRST, EXAMINING ATTORNEY

SN 77-157,553. VERARI SYSTEMS, INC., SAN DIEGO, CA.
FILED 4-16-2007.

BLADES WITHOUT BOUNDARIES

THE MARK CONSISTS OF STANDARD CHARACTERS
WITHOUT CLAIM TO ANY PARTICULAR FONT, STYLE,
SIZE, OR COLOR.

NO CLAIM IS MADE TO THE EXCLUSIVE RIGHT TO
USE "BLADES", APART FROM THE MARK AS SHOWN.

FOR RACK MOUNTED COMPUTER HARDWARE,
COMPUTER SOFTWARE FOR OPERATING RACK
MOUNTED COMPUTER HARDWARE, COMPUTER
SERVERS, COMPUTER PERIPHERALS, AND COMPU-
TER HARDWARE USED IN THE FIELD OF ANIMA-
TION AND DIGITAL AUDIO; COMPUTER SOFTWARE
USED IN THE GENERATION OF GRAPHICS IN THE
FIELD OF ANIMATION AND DIGITAL AUDIO (U.S.
CLS. 21, 23, 26, 36 AND 38).

FIRST USE 7-8-2005; IN COMMERCE 7-8-2005.

CHARLES L. JENKINS, EXAMINING ATTORNEY

SN 77-157,578. WORLDVISTA, PITTSBURG, CA. FILED 4-16-
2007.

WORLDVISTA EHR

THE MARK CONSISTS OF STANDARD CHARACTERS
WITHOUT CLAIM TO ANY PARTICULAR FONT, STYLE,
SIZE, OR COLOR.

NO CLAIM IS MADE TO THE EXCLUSIVE RIGHT TO
USE "EHR", APART FROM THE MARK AS SHOWN.

FOR COMPUTER SOFTWARE FOR MANAGING THE
DELIVERY OF HEALTH CARE SERVICES FOR USE BY
HEALTH CARE PROFESSIONALS (U.S. CLS. 21, 23, 26,
36 AND 38).

GINA FINK, EXAMINING ATTORNEY

CLASS 9—(Continued).

SN 77-157,655. MEG REICHARDT, BROOKLYN, NY. AND
KURT HOFFMAN, BROOKLYN, NY. FILED 4-16-2007.

LES CHAUDS LAPINS

THE MARK CONSISTS OF STANDARD CHARACTERS
WITHOUT CLAIM TO ANY PARTICULAR FONT, STYLE,
SIZE, OR COLOR.

THE FOREIGN WORDING IN THE MARK TRANSLATES
INTO ENGLISH AS THE HOT RABBITS.

FOR SOUND RECORDINGS FEATURING MUSIC
(U.S. CLS. 21, 23, 26, 36 AND 38).

MICHAEL GAAFAR, EXAMINING ATTORNEY

SN 77-157,741. ALPHASNIFFER, LLC, BOULDER, CO.
FILED 4-16-2007.



NO CLAIM IS MADE TO THE EXCLUSIVE RIGHT TO
USE "ALPHA", APART FROM THE MARK AS SHOWN.

THE COLOR(S) BLACK AND GOLD IS/ARE CLAIMED AS
A FEATURE OF THE MARK.

THE MARK CONSISTS OF TWO WORDS, ALPHA AND
SNIFFER, ALPHA IS ABOVE SNIFFER IN HIGH TECH
ITALIC TEXT AND JUSTIFIED TO THE RIGHT OF THE
ALPHASNIFFER LOGO, WHICH CONSISTS OF FOUR
BASE PAIRS OF A STYLIZED DNA DOUBLE HELIX. ALL
LOGO ELEMENTS ARE IN GOLD ON A BLACK BACK-
GROUND.

FOR ELECTRONIC-BASED INSTRUMENTS FOR
MEASURING ENVIRONMENTAL PARAMETERS IN-
CLUDING HUMIDITY, MOLD, BACTERIA, AIR QUAL-
ITY AND WATER QUALITY (U.S. CLS. 21, 23, 26, 36
AND 38).

RAY THOMAS, EXAMINING ATTORNEY

CLASS 9—(Continued).

SN 77-157,778. EPIC SYSTEMS CORPORATION, VERONA, WI. FILED 4-16-2007.

CLASS 9—(Continued).

SN 77-157,807. EPIC SYSTEMS CORPORATION, VERONA, WI. FILED 4-16-2007.

Lucy

Home Stretch

THE MARK CONSISTS OF STANDARD CHARACTERS WITHOUT CLAIM TO ANY PARTICULAR FONT, STYLE, SIZE, OR COLOR.

FOR COMPUTER SOFTWARE FOR USE IN MEDICAL AND HEALTHCARE FIELDS, NAMELY, COMPUTER SOFTWARE FOR MANAGING, ACQUIRING, STORING, ANALYZING, MAINTAINING, PROCESSING, STRUCTURING, REVIEWING, BUILDING, EDITING, DISTRIBUTING, COMMUNICATING, ORGANIZING, SHARING, REFERENCING, MONITORING AND INTEGRATING INFORMATION, AND ACCOMPANYING MANUALS SOLD AS A UNIT; COMPUTER SOFTWARE FOR AUTOMATING CLINICAL AND ADMINISTRATIVE HEALTHCARE PROCESSES (U.S. CLS. 21, 23, 26, 36 AND 38).

BRENDAN MCCAULEY, EXAMINING ATTORNEY

THE MARK CONSISTS OF STANDARD CHARACTERS WITHOUT CLAIM TO ANY PARTICULAR FONT, STYLE, SIZE, OR COLOR.

FOR COMPUTER SOFTWARE FOR USE IN MEDICAL AND HEALTHCARE FIELDS, NAMELY COMPUTER SOFTWARE FOR MANAGING, ACQUIRING, STORING, ANALYZING, MAINTAINING, PROCESSING, STRUCTURING, REVIEWING, BUILDING, EDITING, DISTRIBUTING, COMMUNICATING, ORGANIZING, SHARING, REFERENCING, MONITORING AND INTEGRATING INFORMATION, AND ACCOMPANYING MANUALS SOLD AS A UNIT; COMPUTER SOFTWARE FOR AUTOMATING CLINICAL AND ADMINISTRATIVE HEALTHCARE PROCESSES (U.S. CLS. 21, 23, 26, 36 AND 38).

BRENDAN MCCAULEY, EXAMINING ATTORNEY

SN 77-157,799. EPIC SYSTEMS CORPORATION, VERONA, WI. FILED 4-16-2007.

SN 77-157,860. GLOBAL COMMUNICATIONS, INC., BEAUMONT, TX. FILED 4-16-2007.

IntraConnect



THE MARK CONSISTS OF STANDARD CHARACTERS WITHOUT CLAIM TO ANY PARTICULAR FONT, STYLE, SIZE, OR COLOR.

FOR COMPUTER SOFTWARE FOR USE IN MEDICAL AND HEALTHCARE FIELDS, NAMELY, COMPUTER SOFTWARE FOR MANAGING, ACQUIRING, STORING, ANALYZING, MAINTAINING, PROCESSING, STRUCTURING, REVIEWING, BUILDING, EDITING, DISTRIBUTING, COMMUNICATING, ORGANIZING, SHARING, REFERENCING, MONITORING AND INTEGRATING INFORMATION, AND ACCOMPANYING MANUALS SOLD AS A UNIT; COMPUTER SOFTWARE FOR AUTOMATING CLINICAL AND ADMINISTRATIVE HEALTHCARE PROCESSES (U.S. CLS. 21, 23, 26, 36 AND 38).

BRENDAN MCCAULEY, EXAMINING ATTORNEY

THE MARK CONSISTS OF LETTER D WITH A STYLIZED W SUPERIMPOSED.

FOR APPARATUS FOR TRANSMISSION OF COMMUNICATION; APPARATUS FOR ENHANCING SIGNAL STRENGTH OF TRANSMISSIONS ON TWISTED PAIR COPPER WIRE; SOFTWARE FOR OPERATING APPARATUS FOR TRANSMISSION OF COMMUNICATION; SOFTWARE FOR OPERATING APPARATUS FOR ENHANCING SIGNAL STRENGTH OF TRANSMISSIONS ON TWISTED PAIR COPPER WIRE FOR VIDEO COMMUNICATIONS AND HIGH SPEED DATA (U.S. CLS. 21, 23, 26, 36 AND 38).

HEATHER THOMPSON, EXAMINING ATTORNEY

CLASS 9—(Continued).

SN 77-157,867. GLOBAL COMMUNICATIONS, INC., BEAUMONT, TX. FILED 4-16-2007.



THE MARK CONSISTS OF LETTER D WITH A STYLIZED W SUPERIMPOSED ABOVE "DEMANDWIDTH" ALL WITHIN A CIRCLE.

FOR APPARATUS FOR TRANSMISSION OF COMMUNICATION; APPARATUS FOR ENHANCING SIGNAL STRENGTH OF TRANSMISSIONS ON TWISTED PAIR COPPER WIRE; SOFTWARE FOR OPERATING APPARATUS FOR TRANSMISSION OF COMMUNICATION; SOFTWARE FOR OPERATING APPARATUS FOR ENHANCING SIGNAL STRENGTH OF TRANSMISSIONS ON TWISTED PAIR COPPER WIRE FOR VIDEO COMMUNICATIONS AND HIGH SPEED DATA (U.S. CLS. 21, 23, 26, 36 AND 38).

HEATHER THOMPSON, EXAMINING ATTORNEY

SN 77-157,873. GLOBAL COMMUNICATIONS, INC., BEAUMONT, TX. FILED 4-16-2007.

DEMANDWIDTH

THE MARK CONSISTS OF STANDARD CHARACTERS WITHOUT CLAIM TO ANY PARTICULAR FONT, STYLE, SIZE, OR COLOR.

FOR APPARATUS FOR TRANSMISSION OF COMMUNICATION; APPARATUS FOR ENHANCING SIGNAL STRENGTH OF TRANSMISSIONS ON TWISTED PAIR COPPER WIRE; SOFTWARE FOR OPERATING APPARATUS FOR TRANSMISSION OF COMMUNICATION; SOFTWARE FOR OPERATING APPARATUS FOR ENHANCING SIGNAL STRENGTH OF TRANSMISSIONS ON TWISTED PAIR COPPER WIRE FOR VIDEO COMMUNICATIONS AND HIGH SPEED DATA (U.S. CLS. 21, 23, 26, 36 AND 38).

HEATHER THOMPSON, EXAMINING ATTORNEY

CLASS 9—(Continued).

SN 77-157,973. INPHI CORPORATION, WESTLAKE VILLAGE, CA. FILED 4-16-2007.

KRONOSC

THE MARK CONSISTS OF STANDARD CHARACTERS WITHOUT CLAIM TO ANY PARTICULAR FONT, STYLE, SIZE, OR COLOR.

FOR INTEGRATED CIRCUITS AND SEMICONDUCTOR DEVICES (U.S. CLS. 21, 23, 26, 36 AND 38).

TIMOTHY FINNEGAN, EXAMINING ATTORNEY

SN 77-157,977. INPHI CORPORATION, WESTLAKE VILLAGE, CA. FILED 4-16-2007.

PHYOPTIC

THE MARK CONSISTS OF STANDARD CHARACTERS WITHOUT CLAIM TO ANY PARTICULAR FONT, STYLE, SIZE, OR COLOR.

FOR INTEGRATED CIRCUITS AND SEMICONDUCTOR DEVICES (U.S. CLS. 21, 23, 26, 36 AND 38).

TIMOTHY FINNEGAN, EXAMINING ATTORNEY

SN 77-158,024. REDLINE MARKETING AND PROMOTIONS LLC, EXCELSIOR, MN. FILED 4-16-2007.



THE MARK CONSISTS OF THE WORDS SING IT WITH THE "I" IN SING STYLED AS A MICROPHONE.

FOR HOME KARAOKE PLAYERS; SOFTWARE AND COMPACT DISCS FOR HOME KARAOKE PLAYERS, KARAOKE HARDWARE, KARAOKE MACHINES, AND KARAOKE SOFTWARE (U.S. CLS. 21, 23, 26, 36 AND 38).

KAREN K. BUSH, EXAMINING ATTORNEY

CLASS 9—(Continued).

SN 77-158,037. PWC INDUSTRIES INC., CAPE CORAL, FL. FILED 4-16-2007.

Full Wave Audio

THE MARK CONSISTS OF STANDARD CHARACTERS WITHOUT CLAIM TO ANY PARTICULAR FONT, STYLE, SIZE, OR COLOR.

NO CLAIM IS MADE TO THE EXCLUSIVE RIGHT TO USE "AUDIO", APART FROM THE MARK AS SHOWN.

FOR MARINE WATERPROOF AUDIO AMPLIFIER, AND WATERPROOF STEREO SPEAKERS (U.S. CLS. 21, 23, 26, 36 AND 38).

FIRST USE 2-15-2007; IN COMMERCE 2-15-2007.
KAREN K. BUSH, EXAMINING ATTORNEY

SN 77-158,053. ISSPRO, INC., PORTLAND, OR. FILED 4-16-2007.



OWNER OF U.S. REG. NOS. 747,593, 2,374,834 AND 2,399,380.

THE MARK CONSISTS OF THE WORD ISSPRO INSIDE A BORDER WITH THE WORD PERFORMAX UNDERNEATH, OUTSIDE THE BORDER.

FOR DATA ACQUISITION AND COMMUNICATION DEVICES, NAMELY, PRESSURE AND TEMPERATURE GAUGES, VOLTMETERS, FUEL LEVEL GAUGES, HOURMETERS, SPEEDOMETERS, TACHOMETERS, PYROMETERS, AMMETERS AND THE ASSOCIATED SENSORS AND SWITCHES USED TO OPERATE THE GAUGES; WIRE HARNESSSES AND SUPPORTING BRACKETS FOR ATTACHMENT TO GAUGES; INSTRUMENT CLUSTERS AND ELECTRONIC CONTROLLERS FOR MOBILE OR STATIONARY EQUIPMENT AND VEHICLES INCORPORATING INTERNAL COMBUSTION OR ELECTRIC MOTORS; ELECTRICAL AND ELECTROMECHANICAL GAUGES AND CONTROLS, NAMELY, PYROMETERS, TACHOMETERS, AND LIQUID LEVEL ALARMS (U.S. CLS. 21, 23, 26, 36 AND 38).
JANICE L. MCMORROW, EXAMINING ATTORNEY

CLASS 9—(Continued).

SN 77-158,056. ISSPRO, INC., PORTLAND, OR. FILED 4-16-2007.



OWNER OF U.S. REG. NOS. 747,593, 2,374,834 AND 2,399,380.

THE MARK CONSISTS OF THE WORD ISSPRO INSIDE A BORDER WITH THE WORD CLASSIC UNDERNEATH, OUTSIDE THE BORDER.

FOR DATA ACQUISITION AND COMMUNICATION DEVICES, NAMELY, PRESSURE AND TEMPERATURE GAUGES, VOLTMETERS, FUEL LEVEL GAUGES, HOURMETERS, SPEEDOMETERS, TACHOMETERS, PYROMETERS, AMMETERS AND THE ASSOCIATED SENSORS AND SWITCHES USED TO OPERATE THE GAUGES; WIRE HARNESSSES AND SUPPORTING BRACKETS FOR ATTACHMENT TO GAUGES; INSTRUMENT CLUSTERS AND ELECTRONIC CONTROLLERS FOR MOBILE OR STATIONARY EQUIPMENT AND VEHICLES INCORPORATING INTERNAL COMBUSTION OR ELECTRIC MOTORS; ELECTRICAL AND ELECTROMECHANICAL GAUGES AND CONTROLS, NAMELY, PYROMETERS, TACHOMETERS, AND LIQUID LEVEL ALARMS (U.S. CLS. 21, 23, 26, 36 AND 38).
JANICE L. MCMORROW, EXAMINING ATTORNEY

SN 77-158,096. RICARDO BOSQUE, SAN JOSE, CA. FILED 4-17-2007.



THE COLOR(S) INDIGO AND WHITE IS/ARE CLAIMED AS A FEATURE OF THE MARK.

THE MARK CONSISTS OF WHITE LETTERS ON AN INDIGO BACKGROUND.

FOR OXYGEN MASKS NOT FOR MEDICAL USE; OXYGEN REGULATORS; SELF-RESCUE APPARATUS, NAMELY, OXYGEN BREATHING UNITS; SUNGLASSES (U.S. CLS. 21, 23, 26, 36 AND 38).
GIANCARLO CASTRO, EXAMINING ATTORNEY

CLASS 9—(Continued).

SN 77-158,173. LUXOR PACIFIC USA INC., CITY OF INDUSTRY, CA. FILED 4-17-2007.

ECONO-FLARE

THE MARK CONSISTS OF STANDARD CHARACTERS WITHOUT CLAIM TO ANY PARTICULAR FONT, STYLE, SIZE, OR COLOR.
FOR HIGHWAY FLARES (U.S. CLS. 21, 23, 26, 36 AND 38).

CHERYL CLAYTON, EXAMINING ATTORNEY

SN 77-158,176. LUXOR PACIFIC USA INC., CITY OF INDUSTRY, CA. FILED 4-17-2007.

DURO-FLASH

THE MARK CONSISTS OF STANDARD CHARACTERS WITHOUT CLAIM TO ANY PARTICULAR FONT, STYLE, SIZE, OR COLOR.
FOR HIGHWAY FLARES (U.S. CLS. 21, 23, 26, 36 AND 38).

CHERYL CLAYTON, EXAMINING ATTORNEY

SN 77-158,220. CGI TECHNOLOGIES AND SOLUTIONS INC., FAIRFAX, VA. FILED 4-17-2007.

CGI ENTERPRISE ORIGINATIONS

THE MARK CONSISTS OF STANDARD CHARACTERS WITHOUT CLAIM TO ANY PARTICULAR FONT, STYLE, SIZE, OR COLOR.

OWNER OF U.S. REG. NO. 3,066,945.

NO CLAIM IS MADE TO THE EXCLUSIVE RIGHT TO USE "ENTERPRISE ORIGINATIONS", APART FROM THE MARK AS SHOWN.

FOR COMPUTER SOFTWARE FOR USE IN THE FIELD OF BUSINESS AND FINANCIAL SERVICES, NAMELY, SOFTWARE FOR PREPARING AND EVALUATING CREDIT AND LOAN APPLICATIONS, FOR OBTAINING PERTINENT DATA RELATING TO SUCH CREDIT AND LOAN APPLICATIONS FROM A VARIETY OF SOURCES, AND FOR IDENTIFYING CATEGORIES OF CREDIT, LOAN OR OTHER FINANCIAL SERVICES WHICH MAY BE SUITABLE FOR THE PERSON OR ORGANIZATION SEEKING THE CREDIT OR LOAN (U.S. CLS. 21, 23, 26, 36 AND 38).

ELLEN BURNS, EXAMINING ATTORNEY

CLASS 9—(Continued).

SN 77-158,289. CGI TECHNOLOGIES AND SOLUTIONS INC., FAIRFAX, VA. FILED 4-17-2007.

CGI ENTERPRISE COLLECTIONS

THE MARK CONSISTS OF STANDARD CHARACTERS WITHOUT CLAIM TO ANY PARTICULAR FONT, STYLE, SIZE, OR COLOR.

NO CLAIM IS MADE TO THE EXCLUSIVE RIGHT TO USE "ENTERPRISE COLLECTIONS", APART FROM THE MARK AS SHOWN.

FOR COMPUTER SOFTWARE FOR USE IN THE FIELD OF BUSINESS AND FINANCIAL SERVICES, NAMELY, SOFTWARE FOR MANAGING DEBT COLLECTIONS (U.S. CLS. 21, 23, 26, 36 AND 38).

ELLEN BURNS, EXAMINING ATTORNEY

SN 77-158,320. CGI TECHNOLOGIES AND SOLUTIONS INC., FAIRFAX, VA. FILED 4-17-2007.

CGI ENTERPRISE GATEWAY

THE MARK CONSISTS OF STANDARD CHARACTERS WITHOUT CLAIM TO ANY PARTICULAR FONT, STYLE, SIZE, OR COLOR.

NO CLAIM IS MADE TO THE EXCLUSIVE RIGHT TO USE "ENTERPRISE GATEWAY", APART FROM THE MARK AS SHOWN.

FOR COMPUTER SOFTWARE FOR USE IN THE FIELD OF BUSINESS AND FINANCIAL SERVICES, NAMELY, SOFTWARE FOR REQUESTING, RETRIEVING AND ANALYZING DATA FROM VARIOUS DATA SOURCES FOR USE IN CREDIT AND LOAN ORIGINATIONS, COLLECTIONS, RECOVERY AND MARKETING (U.S. CLS. 21, 23, 26, 36 AND 38).

ELLEN BURNS, EXAMINING ATTORNEY

SN 77-158,349. MAK TECHNOLOGIES, CAMBRIDGE, MA. FILED 4-17-2007.

GIS-TO-SIM

THE MARK CONSISTS OF STANDARD CHARACTERS WITHOUT CLAIM TO ANY PARTICULAR FONT, STYLE, SIZE, OR COLOR.

FOR SOFTWARE USED TO INTERFACE GIS OBJECT DATA WITH DEFENSE SIMULATION ENVIRONMENTS; COMPUTER NETWORK MANAGEMENT SOFTWARE FOR INTERFACING DATA WITH DEFENSE SIMULATION ENVIRONMENTS; AND USER MANUALS SOLD AS A UNIT THEREWITH (U.S. CLS. 21, 23, 26, 36 AND 38).

KATHLEEN M. VANSTON, EXAMINING ATTORNEY

CLASS 9—(Continued).

SN 77-158,389. HIGH GEAR USA, INC., FLETCHER, NC. FILED 4-17-2007.

PLAN B

THE MARK CONSISTS OF STANDARD CHARACTERS WITHOUT CLAIM TO ANY PARTICULAR FONT, STYLE, SIZE, OR COLOR.

FOR MULTIFUNCTIONAL ELECTRONIC DEVICES DISPLAYING TIME, DATE, BODY AND HEART RATES, GLOBAL POSITIONING, DIRECTION AND DISTANCE (U.S. CLS. 21, 23, 26, 36 AND 38).

RAY THOMAS, EXAMINING ATTORNEY



SN 77-158,503. WINESTIMATOR, INC., KENT, WA. FILED 4-17-2007.

projectMIN

THE MARK CONSISTS OF STANDARD CHARACTERS WITHOUT CLAIM TO ANY PARTICULAR FONT, STYLE, SIZE, OR COLOR.

FOR COMPUTER SOFTWARE FOR THE COLLECTION, EDITING, ORGANIZING, MODIFYING, BOOK MARKING, TRANSMISSION, STORAGE AND SHARING OF DATA AND INFORMATION (U.S. CLS. 21, 23, 26, 36 AND 38).

ELLEN B. AWRICH, EXAMINING ATTORNEY



SN 77-158,573. LIN, HSUAN-LANG, TAIPEI, TAIWAN, FILED 4-17-2007.

QingBar

THE MARK CONSISTS OF STANDARD CHARACTERS WITHOUT CLAIM TO ANY PARTICULAR FONT, STYLE, SIZE, OR COLOR.

FOR MP3 PLAYERS; MP4 PLAYERS; MEDIA PLAYERS; PORTABLE MEDIA PLAYERS; DVD PLAYERS; DIGITAL AUDIO PLAYERS (U.S. CLS. 21, 23, 26, 36 AND 38).

MATTHEW MCDOWELL, EXAMINING ATTORNEY

CLASS 9—(Continued).

SN 77-158,778. VIZREA CORPORATION, BELLEVUE, WA. FILED 4-17-2007.

Crystal Play

THE MARK CONSISTS OF STANDARD CHARACTERS WITHOUT CLAIM TO ANY PARTICULAR FONT, STYLE, SIZE, OR COLOR.

FOR HARDWARE AND SOFTWARE TO PROCESS, PRODUCE, AND ENHANCE ONLINE VIDEO (U.S. CLS. 21, 23, 26, 36 AND 38).

JULIE THOMAS, EXAMINING ATTORNEY



SN 77-158,998. MOBILISA, INC, PORT TOWNSEND, WA. FILED 4-17-2007.

FUGITIVE FINDER

THE MARK CONSISTS OF STANDARD CHARACTERS WITHOUT CLAIM TO ANY PARTICULAR FONT, STYLE, SIZE, OR COLOR.

FOR WIRELESS HANDHELD DEVICES USED AT ENTRY POINTS AND WITHIN FACILITIES FOR USE IN SCANNING PERSONAL IDENTIFICATION AND VERIFYING THE VALIDITY OF SAME, AND CHECKING FOR PERSONS OF INTEREST, USING SOFTWARE THAT INTERACTS WITH A COMPUTER DATABASE (U.S. CLS. 21, 23, 26, 36 AND 38).

KIMBERLY FRYE, EXAMINING ATTORNEY



SN 77-159,043. BIG ANT STUDIOS, MELBOURNE, AUSTRALIA, FILED 4-17-2007.

Soaked

THE MARK CONSISTS OF STANDARD CHARACTERS WITHOUT CLAIM TO ANY PARTICULAR FONT, STYLE, SIZE, OR COLOR.

FOR COMPUTER GAME CARTRIDGES; COMPUTER GAME CASSETTES; COMPUTER GAME DISCS; COMPUTER GAME EQUIPMENT CONTAINING MEMORY DEVICES, NAMELY, DISCS; COMPUTER GAME JOYSTICKS; COMPUTER GAME PROGRAMS; COMPUTER GAME SOFTWARE; COMPUTER GAME SOFTWARE, NAMELY, A COMPUTER CRAPS GAME; COMPUTER GAME TAPES; COMPUTER PROGRAMS FOR PRE-RECORDED GAMES; COMPUTER SOFTWARE AND FIRMWARE FOR GAMES OF CHANCE ON ANY COMPUTERIZED PLATFORM, INCLUDING DEDICATED GAMING CONSOLES, VIDEO BASED SLOT MACHINES, REEL BASED SLOT MACHINES, AND VIDEO LOTTERY TERMINALS; COMPUTERIZED VIDEO GAME TABLES FOR GAMING PURPOSES, NAMELY, A COMPUTERIZED VIDEO CRAPS GAME TABLE; COMPUTERIZED VIDEO TABLE GAMES FOR GAMING PURPOSES; DOWNLOADABLE AUDIO FILES, MULTIMEDIA

CLASS 9—(Continued).

FILES, TEXT FILES, EMAILS, WRITTEN DOCUMENTS, AUDIO MATERIAL, VIDEO MATERIAL AND GAMES FEATURING INFORMATION IN THE FORM OF DOWNLOADABLE SHORT EDUCATIONAL/TRAINING COMMUNICATIONS IN THE FIELD OF HUMAN RESOURCE DEVELOPMENT FOR THE PROMOTION OF EMPLOYEE RETENTION, CAREER GROWTH AND INCREASED PRODUCTIVITY FOR EMPLOYEES AND EMPLOYERS; DOWNLOADABLE COMPUTER PROGRAMS FEATURING POSITIONABLE GAME PIECE FIGURES FOR USE IN THE FIELD OF COMPUTER GAMES; DOWNLOADABLE MULTIMEDIA FILE CONTAINING ARTWORK, TEXT, AUDIO, VIDEO, GAMES, AND INTERNET WEB LINKS RELATING TO ELECTRONIC GAMES; DOWNLOADABLE ELECTRONIC GAMES VIA THE INTERNET AND WIRELESS DEVICES; ELECTRICAL CIRCUITS FOR USE IN AMUSEMENT GAME MACHINES FOR REPRODUCING MUSIC, SPEECH AND SPECIAL EFFECTS; ELECTRONIC AND ELECTRO-MECHANICAL GAMING TABLES WITH VIDEO OUTPUT; ELECTRONIC GAME PROGRAMS; ELECTRONIC GAME SOFTWARE; ELECTRONIC GAME SOFTWARE FOR CELLULAR TELEPHONES; ELECTRONIC GAME SOFTWARE FOR HANDHELD ELECTRONIC DEVICES; ELECTRONIC GAME SOFTWARE FOR WIRELESS DEVICES; GAME SOFTWARE; GAMING DEVICES, NAMELY, GAMING MACHINES, SLOT MACHINES, BINGO MACHINES, WITH OR WITHOUT VIDEO OUTPUT; GAMING EQUIPMENT, NAMELY, SLOT MACHINES WITH OR WITHOUT VIDEO OUTPUT; GAMING MACHINES; HAND HELD JOY STICK UNITS FOR PLAYING VIDEO GAMES; INTEGRATED CIRCUIT CHIPS FOR ELECTRONIC GAMES AS A COMPONENT OF VIDEO GAMES SOFTWARE; INTERACTIVE AUDIO GAME DISCS CONTAINING ELECTRONIC GAMES; INTERACTIVE MULTIMEDIA COMPUTER GAME PROGRAM (U.S. CLS. 21, 23, 26, 36 AND 38).

FIRST USE 1-1-2007; IN COMMERCE 4-16-2007.
RAY THOMAS, EXAMINING ATTORNEY

CLASS 9—(Continued).

SN 77-159,218. I.P. HOLDINGS, INC., GRAND PRAIRIE, TX. FILED 4-18-2007.

PROWLER

THE MARK CONSISTS OF STANDARD CHARACTERS WITHOUT CLAIM TO ANY PARTICULAR FONT, STYLE, SIZE, OR COLOR.

FOR MOTION DETECTING DIGITAL CAMERA; MOTION DETECTING DIGITAL VIDEO CAMERA (U.S. CLS. 21, 23, 26, 36 AND 38).

CHRISTOPHER BUONGIORNO, EXAMINING ATTORNEY

SN 77-159,190. GENESIS INTERNATIONAL, INC., SEOUL, REPUBLIC OF KOREA, FILED 4-18-2007.



The Seventh Element

THE MARK CONSISTS OF THE NUMERAL SEVEN, TWO ANGLED LINES POSITIONED NEAR OR INTERSECTING THE NUMERAL SEVEN, AND THE WORDS THE SEVENTH ELEMENT.

FOR ELECTRONIC SYSTEMS, NAMELY, CIRCUIT BOARDS, INTEGRATED CIRCUITS, AND CONTROL SOFTWARE FOR CONTROLLING PAINTBALL GUNS AND PAINTBALL LOADERS (U.S. CLS. 21, 23, 26, 36 AND 38).

REBECCA EISINGER, EXAMINING ATTORNEY

SN 77-159,228. CONNECTICUT ATTORNEYS TITLE INSURANCE COMPANY, ROCKY HILL, CT. FILED 4-18-2007.



OWNER OF U.S. REG. NOS. 2,100,831, 3,099,414 AND OTHERS.

THE MARK CONSISTS OF A BLOCK C DESIGN WITH THE WORDS "CATIC ACCESS TO SUCCESS."

FOR COMPUTER SOFTWARE FOR USE IN THE FIELDS OF TITLE INSURANCE AND REAL PROPERTY, NAMELY, COMPUTER SOFTWARE FOR USE IN THE FIELD OF REAL PROPERTY TITLE SEARCHING; COMPUTER SOFTWARE FOR SCANNING AND MANAGING TITLE INSURANCE AND REAL PROPERTY RECORDS; COMPUTER SOFTWARE FOR TRANSFERRING TITLE INSURANCE POLICY AND REAL ESTATE FINANCIAL INFORMATION BETWEEN COMPUTER PROGRAMS; COMPUTER SOFTWARE FOR GENERATING TITLE INSURANCE AND REAL ESTATE CLOSING DOCUMENTS (U.S. CLS. 21, 23, 26, 36 AND 38).

CHRIS WELLS, EXAMINING ATTORNEY

CLASS 9—(Continued).

SN 77-159,369. OFI, INC, GURNEE, IL. FILED 4-18-2007.



OWNER OF U.S. REG. NO. 3,129,061.
FOR ELECTRICAL OUTLET TESTER; ELECTRICAL
OUTLETS; ELECTRIC CORDS; ELECTRICAL PLUGS;
ELECTRIC WIRES AND CABLES; ELECTRICAL CON-
NECTORS; ELECTRICAL SOCKETS (U.S. CLS. 21, 23, 26,
36 AND 38).
FIRST USE 2-15-2006; IN COMMERCE 3-1-2006.
ELIZABETH KAJUBI, EXAMINING ATTORNEY

SN 77-159,474. REALM BUSINESS SOLUTIONS, INC., HOUS-
TON, TX. FILED 4-18-2007.

ARGUS360

THE MARK CONSISTS OF STANDARD CHARACTERS
WITHOUT CLAIM TO ANY PARTICULAR FONT, STYLE,
SIZE, OR COLOR.
FOR COMPUTER SOFTWARE FOR ASSET VALUA-
TION IN THE FIELD OF REAL ESTATE; COMPUTER
SOFTWARE FOR PORTFOLIO MANAGEMENT, FINAN-
CIAL ANALYSIS, BUDGETING, DISCOUNTED CASH
FLOW, ANALYSIS OF COMMERCIAL REAL ESTATE
ASSETS AND TRANSACTIONS, EVALUATION OF
MARKET RISKS, DEVELOPMENT OF LEASING STRA-
TEGIES, FORECASTING PROPERTY AND PORTFOLIO
CASH FLOWS, CALCULATION OF INVESTMENT VA-
LUES AND RETURNS, AND SHARING DATA WITH
OTHERS, ALL FOR USE IN THE REAL ESTATE
INDUSTRY (U.S. CLS. 21, 23, 26, 36 AND 38).
GEOFFREY FOSDICK, EXAMINING ATTORNEY

CLASS 9—(Continued).

SN 77-159,599. MONDEC USA, FREMONT, CA. FILED 4-18-
2007.



OWNER OF U.S. REG. NO. 2,478,302.
NO CLAIM IS MADE TO THE EXCLUSIVE RIGHT TO
USE "AUDIO", APART FROM THE MARK AS SHOWN.
THE MARK CONSISTS OF 2 WORDS WITH C-STYLE
SWOOSH DESIGN FROM LOWER LEFT TO TOP RIGHT OF
TEXT.
FOR AUDIO EQUIPMENT FOR VEHICLES, NAMELY,
STEREOS, SPEAKERS, AMPLIFIERS, EQUALIZERS,
CROSSOVERS AND SPEAKER HOUSINGS (U.S. CLS.
21, 23, 26, 36 AND 38).
FIRST USE 6-15-2001; IN COMMERCE 1-15-2002.
JOHN WILKE, EXAMINING ATTORNEY

SN 77-159,653. PALETZ, DANIELLE, GLENDALE, AZ.
FILED 4-18-2007.

WE SECURE YOU

THE MARK CONSISTS OF STANDARD CHARACTERS
WITHOUT CLAIM TO ANY PARTICULAR FONT, STYLE,
SIZE, OR COLOR.
FOR ACCESS CONTROL AND ALARM MONITORING
SYSTEMS, ALARM CENTRAL UNITS, ANTI-INTRU-
SION ALARMS, BURGLAR ALARMS, ELECTRICAL
AND ELECTRONIC BURGLAR ALARMS, FIRE
ALARMS, PERSONAL SECURITY ALARMS, SMOKE
ALARMS, AND THEFT ALARMS (U.S. CLS. 21, 23, 26,
36 AND 38).
FIRST USE 6-29-2004; IN COMMERCE 6-29-2004.
SUE LAWRENCE, EXAMINING ATTORNEY

SN 77-159,655. KATCHITEK CORPORATION, LAS VEGAS,
NV. FILED 4-18-2007.

DENTALMANAGER

THE MARK CONSISTS OF STANDARD CHARACTERS
WITHOUT CLAIM TO ANY PARTICULAR FONT, STYLE,
SIZE, OR COLOR.
FOR COMPUTER SOFTWARE FOR STORING AND
DISPLAYING OF PATIENT'S RECORDS, FOR USE IN
THE MEDICAL FIELD (U.S. CLS. 21, 23, 26, 36 AND 38).
AMY BROZENIC, EXAMINING ATTORNEY

CLASS 9—(Continued).

SN 77-159,716. DROPFIRE, INC., CAMBRIDGE, MA. FILED 4-18-2007.

Blaze

THE MARK CONSISTS OF STANDARD CHARACTERS WITHOUT CLAIM TO ANY PARTICULAR FONT, STYLE, SIZE, OR COLOR.

FOR SOFTWARE DEVELOPMENT TOOLS; COMPUTER SOFTWARE USED FOR ENABLING AND MANAGING INTEROPERABILITY BETWEEN COMMUNICATIONS AND DATA NETWORKS; EMERGENCY RESPONSE COMPUTER SOFTWARE USED FOR EMERGENCY DATA SHARING, COORDINATING EMERGENCY RESPONSE, AND MAPPING CRIME ACTIONS; AND USER MANUALS SOLD AS A UNIT THEREWITH (U.S. CLS. 21, 23, 26, 36 AND 38).

ADA HAN, EXAMINING ATTORNEY

SN 77-159,791. RETURNIL, SIA, RIGA, LATVIA, FILED 4-18-2007.

RETURNIL

THE MARK CONSISTS OF STANDARD CHARACTERS WITHOUT CLAIM TO ANY PARTICULAR FONT, STYLE, SIZE, OR COLOR.

FOR COMPUTER SOFTWARE USED TO PROTECT COMPUTERS FROM VIRUSES, SPYWARE AND UNWANTED PROGRAMS, PRESERVE COMPUTER SETTINGS, AND ENSURE INTERNET PRIVACY (U.S. CLS. 21, 23, 26, 36 AND 38).

FIRST USE 9-0-2006; IN COMMERCE 9-0-2006.
ERIN FALK, EXAMINING ATTORNEY

SN 77-159,798. THE RAND CORPORATION, SANTA MONICA, CA. FILED 4-18-2007.

LOOK ALIKE

THE MARK CONSISTS OF STANDARD CHARACTERS WITHOUT CLAIM TO ANY PARTICULAR FONT, STYLE, SIZE, OR COLOR.

FOR SOFTWARE PROGRAMS FOR DATA ANALYSIS (U.S. CLS. 21, 23, 26, 36 AND 38).

ERIN FALK, EXAMINING ATTORNEY

CLASS 9—(Continued).

SN 77-159,899. INTELLIDINE CORP., FAIRFAX, VA. FILED 4-18-2007.

W8Pal

THE MARK CONSISTS OF STANDARD CHARACTERS WITHOUT CLAIM TO ANY PARTICULAR FONT, STYLE, SIZE, OR COLOR.

FOR ELECTRONIC ADVERTISEMENT AND MESSAGING DISPLAY UNIT WITH MULTI-NETWORKING (TCP/IP) CAPABILITIES AND REMOTE CONNECTIVITY (U.S. CLS. 21, 23, 26, 36 AND 38).

TIMOTHY FINNEGAN, EXAMINING ATTORNEY

SN 77-160,072. ZEAL OPTICS, INC., MOAB, UT. FILED 4-18-2007.

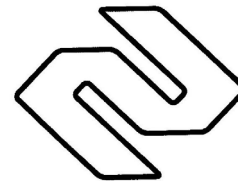

THE MARK CONSISTS OF A STYLIZED LETTER "Z".
FOR SPORT GOGGLES FOR USE IN SKIING, SNOWBOARDING AND SNOWMOBILING; SUNGLASSES; SPORTS EYEWEAR (U.S. CLS. 21, 23, 26, 36 AND 38).

FIRST USE 8-0-2006; IN COMMERCE 8-0-2006.
ALICE BENMAMAN, EXAMINING ATTORNEY

CLASS 9—(Continued).

SN 77-160,080. WARNER BROS. ENTERTAINMENT INC., BURBANK, CA. FILED 4-18-2007.

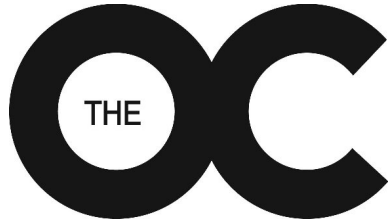

OWNER OF U.S. REG. NOS. 3,172,476, 3,223,488 AND 3,225,868.

THE MARK CONSISTS OF THE LETTERS THE OC. FOR MOTION PICTURE FILMS FEATURING COMEDY, DRAMA, ACTION, ADVENTURE AND/OR ANIMATION, AND MOTION PICTURE FILMS FOR BROADCAST ON TELEVISION FEATURING COMEDY, DRAMA, ACTION, ADVENTURE AND/OR ANIMATION; AUDIO VIDEO DISCS AND DIGITAL VERSATILE DISCS FEATURING MUSIC, COMEDY, DRAMA, ACTION, ADVENTURE, AND/OR ANIMATION; AND DECORATIVE MAGNETS (U.S. CLS. 21, 23, 26, 36 AND 38).

FIRST USE 3-30-2004; IN COMMERCE 3-30-2004.
DORITT L. CARROLL, EXAMINING ATTORNEY

SN 77-160,081. BICK, JOHN, LOS ANGELES, CA. FILED 4-18-2007.

WHAT'S IN YOUR HEAD

THE MARK CONSISTS OF STANDARD CHARACTERS WITHOUT CLAIM TO ANY PARTICULAR FONT, STYLE, SIZE, OR COLOR.

FOR VIDEO RECORDINGS FEATURING INSTRUCTION IN THE FIELD OF SPORTS; DIGITAL MEDIA, NAMELY, DVDS, CDS AND DOWNLOADABLE INTERNET VIDEO RECORDINGS FEATURING INSTRUCTION IN THE FIELD OF SPORTS (U.S. CLS. 21, 23, 26, 36 AND 38).

REBECCA GILBERT, EXAMINING ATTORNEY

CLASS 9—(Continued).

SN 77-160,105. BERDAN II, WILFRED, RICHMOND, ME. FILED 4-18-2007.



THE MARK CONSISTS OF ONE "F" THAT IS READ RIGHT SIDE UP, AND THE OTHER "F" WHICH IS UPSIDE DOWN. THE TWO "F"'S FIT TOGETHER LIKE FINGERS. THE WORD "FOREIGN" IS ON TOP OF THE LOGO, AND THE WORD "FREQUENCY" IS ON THE BOTTOM OF THE LOGO.

FOR MUSICAL SOUND RECORDINGS; PRE-RECORDED CDS, VIDEO TAPES, LASER DISKS AND DVDS FEATURING MUSIC; PHONOGRAPH RECORDS FEATURING MUSIC; AUDIO CASSETTES FEATURING MUSIC (U.S. CLS. 21, 23, 26, 36 AND 38).

FIRST USE 3-29-2007; IN COMMERCE 3-29-2007.
CHRISTINE COOPER, EXAMINING ATTORNEY

SN 77-160,155. SIDEREUS TECHNOLOGIES, INC., BEVERLY HILLS, CA. FILED 4-18-2007.

SpringWidgets

FOR DOWNLOADABLE COMPUTER SOFTWARE FOR ACCESSING, DISPLAYING, ORGANIZING, ASSEMBLING, DISTRIBUTING AND INTEGRATING INFORMATION FROM THE INTERNET; COMPUTER SOFTWARE DEVELOPMENT KIT COMPRISED OF COMPUTER SOFTWARE DEVELOPMENT TOOLS USED FOR DEVELOPING INTERACTIVE CONTENT THAT CAN BE EMBEDDED INTO AN INTERNET WEB PAGE AND LINKED TO A DESKTOP (U.S. CLS. 21, 23, 26, 36 AND 38).

REBECCA SMITH, EXAMINING ATTORNEY

SN 77-160,191. THOMPSON RAPHAEL A., SHARPSBURG, GA. FILED 4-18-2007.

Nighttime

THE MARK CONSISTS OF STANDARD CHARACTERS WITHOUT CLAIM TO ANY PARTICULAR FONT, STYLE, SIZE, OR COLOR.

FOR COMPUTER APPLICATION SOFTWARE FOR MOBILE PHONES (U.S. CLS. 21, 23, 26, 36 AND 38).

JEAN IM, EXAMINING ATTORNEY

CLASS 9—(Continued).

SN 77-160,192. Z RESEARCH, INC., FREMONT, CA. FILED 4-18-2007.

Gluster

THE MARK CONSISTS OF STANDARD CHARACTERS WITHOUT CLAIM TO ANY PARTICULAR FONT, STYLE, SIZE, OR COLOR.

FOR COMPUTER SOFTWARE DEVELOPMENT TOOLS; COMPUTER SOFTWARE FOR APPLICATION AND DATABASE INTEGRATION; COMPUTER SOFTWARE FOR COMPUTER SYSTEM AND APPLICATION DEVELOPMENT, DEPLOYMENT AND MANAGEMENT; COMPUTER SOFTWARE FOR CONTROLLING AND MANAGING ACCESS SERVER APPLICATIONS; COMPUTER SOFTWARE FOR USE IN THE ENCRYPTION AND DECRYPTION OF DIGITAL FILES, INCLUDING AUDIO, VIDEO, TEXT, BINARY, STILL IMAGES, GRAPHICS AND MULTIMEDIA FILES; COMPUTER SOFTWARE PLATFORMS FOR HIGH PERFORMANCE COMPUTING, CLUSTERED FILE STORAGE, VISUALIZATION CLUSTERS, DATABASE CLUSTERS AND ENTERPRISE PROVISIONING; COMPUTER SOFTWARE THAT ASSISTS COMPUTERS IN DEPLOYING PARALLEL APPLICATIONS AND PERFORMING PARALLEL COMPUTATIONS; DATA COMPRESSION SOFTWARE (U.S. CLS. 21, 23, 26, 36 AND 38).

FIRST USE 6-1-2005; IN COMMERCE 6-1-2005.
DORITT L. CARROLL, EXAMINING ATTORNEY

SN 77-160,225. PRICE, LUCINDA GRACE, WINDSOR, CA. FILED 4-18-2007.

wikiKalendar

THE MARK CONSISTS OF STANDARD CHARACTERS WITHOUT CLAIM TO ANY PARTICULAR FONT, STYLE, SIZE, OR COLOR.

FOR COMPUTER PROGRAMS FOR VIEWING AND/OR CONTRIBUTING TO PUBLICATION OF AN ELECTRONIC CALENDAR AND ELECTRONIC CALENDAR EVENTS THEREON; PROGRAMS FOR SHARING CALENDARS AND/OR SCHEDULED EVENTS, NAMELY COLLABORATIVE PROGRAMS FOR FACILITATING THE OPERATION OF A CALENDAR FORMED BY COMMUNITY CONTRIBUTIONS; PROGRAMS FOR RECORDING EVENT DATA ON COMPUTER MEDIA AND/OR DOWNLOADING EVENT DATA VIA A GLOBAL COMPUTER NETWORK; PROGRAMS FOR LINKING MULTIPLE WEB PAGES TO AN ELECTRONIC CALENDAR INTERNET SITE; PROGRAMS FOR ENHANCING EVENT SCHEDULING CAPABILITIES; PROGRAMS FOR MANAGING A DATA BASE, NAMELY, PROGRAMS FOR TRANSFERRING DATA TO AND FROM DATA BASES AND TO AND FROM COMPUTER PROGRAMS, NETWORKS, AND COMPUTER FILES; PROGRAMS FOR REPORTING TO INDIVIDUAL EVENT CONTRIBUTORS; PROGRAMS FOR VERIFYING UNIQUE EVENTS; PROGRAMS FOR REMOVING INAPPROPRIATE EVENT POSTS; PROGRAMS FOR DOWNLOADING, STORING, SHARING, ENHANCING, DISTRIBUTING, EDITING, MANIPULATING AND PRINTING IMAGES AND STORAGE AND MANAGEMENT OF IMAGE DATA FILES; PROGRAMS FOR MANAGING PERSONAL AND BUSINESS INFORMATION FOR INDIVIDUALS AND GROUPS, NAMELY,

CLASS 9—(Continued).

ACCESS TO AND MANAGEMENT OF ELECTRONIC GROUP, BUSINESS, AND PERSONAL CALENDARS; PROGRAMS FOR SYNCHRONIZING EVENT DATA BETWEEN AN ONLINE DATABASE, A HANDHELD ELECTRONIC DEVICE, AND OTHER ELECTRONIC DEVICES; PROGRAMS FOR DEVELOPING, PREPARING, AND PUBLISHING PROMOTIONAL CAMPAIGNS FOR BUSINESSES, NAMELY PUBLISHING ADVERTISING AND PROMOTIONAL MATERIALS VIA A NETWORK RELATED TO EVENTS IN SELECTED CATEGORIES AND EVENTS IN PUBLIC CALENDARS; PROGRAMS FOR PROMOTING CALENDARED EVENTS AND ADVERTISING CAMPAIGNS RELATED TO EVENTS IN SELECTED CATEGORIES; PROGRAMS FOR ADDING EVENT(S) TO PUBLIC CALENDAR LISTS TO ALLOW OTHERS TO INCLUDE THE ADDED EVENT(S) IN PERSONAL CALENDARS; PROGRAMS FOR ADDING EVENT(S) TO PRIVATE NETWORKS TO ALLOW OTHERS IN PRIVATE NETWORK TO INCLUDE THE ADDED EVENT(S) IN PERSONAL CALENDARS (U.S. CLS. 21, 23, 26, 36 AND 38).

FIRST USE 4-13-2007; IN COMMERCE 4-13-2007.
CHERYL CLAYTON, EXAMINING ATTORNEY

SN 77-160,302. FUJIFILM CORPORATION, MINATO-KU, TOKYO, JAPAN, FILED 4-19-2007.

ACUITY

THE MARK CONSISTS OF STANDARD CHARACTERS WITHOUT CLAIM TO ANY PARTICULAR FONT, STYLE, SIZE, OR COLOR.

FOR INKJET PRINTERS FOR INDUSTRIAL USES AND FOR USES IN THE PRINTING INDUSTRY (U.S. CLS. 21, 23, 26, 36 AND 38).
SUNG IN, EXAMINING ATTORNEY

SN 77-160,333. MASTERSON ENTERPRISES, LLC, BENSONVILLE, IL. FILED 4-19-2007.

Safe Sense

THE MARK CONSISTS OF STANDARD CHARACTERS WITHOUT CLAIM TO ANY PARTICULAR FONT, STYLE, SIZE, OR COLOR.

FOR CONVERTERS FOR ELECTRIC PLUGS; COVERS FOR ELECTRIC OUTLETS; ELECTRIC JUNCTION BOXES; ELECTRIC OUTLET COVERS; ELECTRIC PLUGS; ELECTRIC SOCKETS; ELECTRICAL OUTLET PLATES; ELECTRICAL OUTLETS; ELECTRICAL RECEPTACLES; ELECTRICAL SOCKETS; MULTI-OUTLET SOCKET BLOCKS; VOLTAGE SURGE PROTECTORS; VOLTAGE SURGE SUPPRESSORS (U.S. CLS. 21, 23, 26, 36 AND 38).

RAY THOMAS, EXAMINING ATTORNEY

CLASS 9—(Continued).

SN 77-160,339. LEVINE, JASON, NEW YORK, NY. FILED 4-19-2007.

THE FUNNERY

THE MARK CONSISTS OF STANDARD CHARACTERS WITHOUT CLAIM TO ANY PARTICULAR FONT, STYLE, SIZE, OR COLOR.

FOR DOWNLOADABLE MULTIMEDIA FILE CONTAINING ARTWORK, TEXT, AUDIO, VIDEO, GAMES, AND INTERNET WEB LINKS RELATING TO COMEDY; AND DOWNLOADABLE VIDEO RECORDINGS FEATURING COMEDY PROVIDED VIA THE INTERNET (U.S. CLS. 21, 23, 26, 36 AND 38).

CURTIS FRENCH, EXAMINING ATTORNEY

CLASS 9—(Continued).

SN 77-160,454. R. W. BECKETT CORPORATION, NORTH RIDGEVILLE, OH. FILED 4-19-2007.

GENISYS

THE MARK CONSISTS OF STANDARD CHARACTERS WITHOUT CLAIM TO ANY PARTICULAR FONT, STYLE, SIZE, OR COLOR.

FOR HVAC CONTROLS FOR THE CONTROL OF RESIDENTIAL AND COMMERCIAL HVAC SYSTEMS, NAMELY BURNER CONTROLS, BOILER CONTROLS, AND FURNACE CONTROLS (U.S. CLS. 21, 23, 26, 36 AND 38).

FRED MANDIR, EXAMINING ATTORNEY

SN 77-160,348. MASTERSON ENTERPRISES, LLC, BENSENVILLE, IL. FILED 4-19-2007.

Guardian Angel

THE MARK CONSISTS OF STANDARD CHARACTERS WITHOUT CLAIM TO ANY PARTICULAR FONT, STYLE, SIZE, OR COLOR.

FOR ADAPTERS; CONNECTING ELECTRICAL CABLES; CONVERTERS FOR ELECTRIC PLUGS; COVERS FOR ELECTRIC OUTLETS; ELECTRIC CONNECTORS; ELECTRIC CORDS; ELECTRIC JUNCTION BOXES; ELECTRIC OUTLET COVERS; ELECTRIC PLUGS; ELECTRIC SOCKETS; ELECTRICAL CONNECTION BOXES; ELECTRICAL CONNECTORS; ELECTRICAL OUTLET PLATES; ELECTRICAL OUTLETS; ELECTRICAL PLUGS; VOLTAGE REGULATORS FOR ELECTRIC POWER; VOLTAGE SURGE PROTECTORS; VOLTAGE SURGE SUPPRESSORS (U.S. CLS. 21, 23, 26, 36 AND 38).

RAY THOMAS, EXAMINING ATTORNEY

SN 77-160,466. HOBBICO, INC., CHAMPAIGN, IL. FILED 4-19-2007.

INTERLINK

THE MARK CONSISTS OF STANDARD CHARACTERS WITHOUT CLAIM TO ANY PARTICULAR FONT, STYLE, SIZE, OR COLOR.

FOR RADIO-CONTROLLED MODEL AIRCRAFT FLIGHT SIMULATION SOFTWARE (U.S. CLS. 21, 23, 26, 36 AND 38).

FIRST USE 3-27-2002; IN COMMERCE 3-27-2002.
MIDGE BUTLER, EXAMINING ATTORNEY

SN 77-160,389. COGNITIVE CONNECTION, INC., CHICAGO, IL. FILED 4-19-2007.

AS I GROW

THE MARK CONSISTS OF STANDARD CHARACTERS WITHOUT CLAIM TO ANY PARTICULAR FONT, STYLE, SIZE, OR COLOR.

FOR CHILDREN'S VIDEO TAPES (U.S. CLS. 21, 23, 26, 36 AND 38).

SUNG IN, EXAMINING ATTORNEY

SN 77-160,594. GENAUDIO, INC., ENGLEWOOD, CO. FILED 4-19-2007.

ASTOUNDSOUND

THE MARK CONSISTS OF STANDARD CHARACTERS WITHOUT CLAIM TO ANY PARTICULAR FONT, STYLE, SIZE, OR COLOR.

FOR DIGITAL SIGNAL PROCESSING CARDS; COMPUTER SOFTWARE FOR USE IN CONNECTION WITH GENERATING, PROCESSING, RECORDING, TRANSMITTING, RECEIVING AND PLAYING AUDIO SIGNALS AND SOUNDS; COMPUTER SOFTWARE FOR AUDIO PRODUCTION (U.S. CLS. 21, 23, 26, 36 AND 38).

ERNEST SHOSHO, EXAMINING ATTORNEY

CLASS 9—(Continued).

SN 77-160,609. GENAUDIO, INC., ENGLEWOOD, CO. FILED 4-19-2007.



THE MARK CONSISTS OF FOUR CONCENTRIC CIRCLES WITH A WEDGE APPEARING AS AN EXCLAMATION POINT INSERTED IN THE TOP.
 FOR DIGITAL SIGNAL PROCESSING CARDS; COMPUTER SOFTWARE FOR USE IN CONNECTION WITH GENERATING, PROCESSING, RECORDING, TRANSMITTING, RECEIVING AND PLAYING AUDIO SIGNALS AND SOUNDS; COMPUTER SOFTWARE FOR AUDIO PRODUCTION (U.S. CLS. 21, 23, 26, 36 AND 38).
 ERNEST SHOSHO, EXAMINING ATTORNEY

SN 77-160,621. GENAUDIO, INC., ENGLEWOOD, CO. FILED 4-19-2007.

ASTOUNDSTEREO

THE MARK CONSISTS OF STANDARD CHARACTERS WITHOUT CLAIM TO ANY PARTICULAR FONT, STYLE, SIZE, OR COLOR.
 FOR DIGITAL SIGNAL PROCESSING CARDS; COMPUTER SOFTWARE FOR USE IN CONNECTION WITH GENERATING, PROCESSING, RECORDING, TRANSMITTING, RECEIVING AND PLAYING AUDIO SIGNALS AND SOUNDS; COMPUTER SOFTWARE FOR AUDIO PRODUCTION (U.S. CLS. 21, 23, 26, 36 AND 38).
 ERNEST SHOSHO, EXAMINING ATTORNEY

SN 77-160,644. MATRIX PRODUCT DEVELOPMENT, INC., SUN PRAIRIE, WI. FILED 4-19-2007.

WYZE-TEMP

THE MARK CONSISTS OF STANDARD CHARACTERS WITHOUT CLAIM TO ANY PARTICULAR FONT, STYLE, SIZE, OR COLOR.
 FOR TEMPERATURE INDICATORS AND TEMPERATURE SENSORS (U.S. CLS. 21, 23, 26, 36 AND 38).
 JENNY PARK, EXAMINING ATTORNEY

CLASS 9—(Continued).

SN 77-160,651. GENAUDIO, INC., ENGLEWOOD, CO. FILED 4-19-2007.



THE MARK CONSISTS OF AN EXCLAMATION MARK AND INTERCONNECTED SPIRAL.
 FOR DIGITAL SIGNAL PROCESSING CARDS; COMPUTER SOFTWARE FOR USE IN CONNECTION WITH GENERATING, PROCESSING, RECORDING, TRANSMITTING, RECEIVING AND PLAYING AUDIO SIGNALS AND SOUNDS; COMPUTER SOFTWARE FOR AUDIO PRODUCTION (U.S. CLS. 21, 23, 26, 36 AND 38).
 ERNEST SHOSHO, EXAMINING ATTORNEY

SN 77-160,663. GENAUDIO, INC., ENGLEWOOD, CO. FILED 4-19-2007.

GENAUDIO

THE MARK CONSISTS OF STANDARD CHARACTERS WITHOUT CLAIM TO ANY PARTICULAR FONT, STYLE, SIZE, OR COLOR.
 FOR DIGITAL SIGNAL PROCESSING CARDS; COMPUTER SOFTWARE FOR USE IN CONNECTION WITH GENERATING, PROCESSING, RECORDING, TRANSMITTING, RECEIVING AND PLAYING AUDIO SIGNALS AND SOUNDS; COMPUTER SOFTWARE FOR AUDIO PRODUCTION (U.S. CLS. 21, 23, 26, 36 AND 38).
 ERNEST SHOSHO, EXAMINING ATTORNEY

CLASS 9—(Continued).

SN 77-160,679. GENAUDIO, INC., ENGLEWOOD, CO. FILED 4-19-2007.



THE MARK CONSISTS OF TWO INTERLOCKING OVALS ABOVE THE WORD GENAUDIO, WITH A SHARP-ENDED DESIGN INSINUATING THE LETTER "A" WHICH CONSISTS OF A HORIZONTAL LINE BENEATH THE LETTER "N" AND WHICH SLANTS UPWARD INTO A SHARP PEAK, THEN SLANTS DOWNWARD FORMING ANOTHER SHARP PEAK BELOW THE ORIGINAL HORIZONTAL LINE, THEN SLANTS UPWARD AGAIN TO THE SAME LEVEL AS THE ORIGINAL HORIZONTAL LINE AND UNDERLINES THE LETTERS "UDIO".

FOR DIGITAL SIGNAL PROCESSING CARDS; COMPUTER SOFTWARE FOR USE IN CONNECTION WITH GENERATING, PROCESSING, RECORDING, TRANSMITTING, RECEIVING AND PLAYING AUDIO SIGNALS AND SOUNDS; COMPUTER SOFTWARE FOR AUDIO PRODUCTION (U.S. CLS. 21, 23, 26, 36 AND 38).
ERNEST SHOSHO, EXAMINING ATTORNEY

CLASS 9—(Continued).

SN 77-160,834. MICROSTRAIN, INC., WILLISTON, VT. FILED 4-19-2007.

3DM-GX2

THE MARK CONSISTS OF STANDARD CHARACTERS WITHOUT CLAIM TO ANY PARTICULAR FONT, STYLE, SIZE, OR COLOR.

FOR ACCELERATION SENSORS; ACCELEROMETERS; COMPUTER CHIPS; COMPUTER SOFTWARE FOR USE WITH ANALOG AND DIGITAL MEASURING DEVICES, DATA ACQUISITION TRANSCIEVERS AND WIRELESS SENSOR NETWORKS; CONVERTERS; ELECTRIC OR ELECTRONIC SENSORS FOR MEASURING DISPLACEMENTS, DISTANCES, ELONGATIONS, MOTION, MOVEMENT, ORIENTATION, POSITION, OR STRAIN; GYROSCOPES; INCLINOMETERS; LENGTH MEASURING GAUGES; LIQUID LEVEL SENSORS; MAGNETOMETERS; MICROCONTROLLERS; MULTIPLEXERS; PRESSURE GAUGES; PRESSURE SENSORS; PROXIMITY SENSORS; SENSORS FOR THE DETERMINATION OF TEMPERATURES, POSITIONS AND DISTANCES; TEMPERATURE SENSORS; THERMOCOUPLES; TIMING SENSORS; TRANSDUCERS THAT UTILIZE ULTRASONIC OSCILLATIONS TO TEST FOR STRESS AND FATIGUE IN METAL AND METAL STRUCTURES; ULTRASONIC SENSORS; VEHICLE MOUNTED GPS SENSOR FOR DETERMINING THE RATE OF MOTION FOR A VEHICLE (U.S. CLS. 21, 23, 26, 36 AND 38).

FIRST USE 12-12-2006; IN COMMERCE 12-12-2006.
AISHA CLARKE, EXAMINING ATTORNEY

SN 77-160,798. GOOD EARTH ENERGY CONSERVATION, LLC, SPRINGDALE, AR. FILED 4-19-2007.



THE MARK CONSISTS OF A FULLY MATURE TREE WITH GRASS AT THE BASE OF THE TREE.

FOR BATTERIES; DEEP-CYCLE BATTERIES; ELECTRIC POWERED VEHICLE BATTERIES (U.S. CLS. 21, 23, 26, 36 AND 38).

JENNIFER DIXON, EXAMINING ATTORNEY

SN 77-160,854. TRANSLATIONS.COM, INC., NEW YORK, NY. FILED 4-19-2007.

TransStudio

THE MARK CONSISTS OF STANDARD CHARACTERS WITHOUT CLAIM TO ANY PARTICULAR FONT, STYLE, SIZE, OR COLOR.

FOR COMPUTER PROGRAMS IN THE FIELD OF LANGUAGE TRANSLATION (U.S. CLS. 21, 23, 26, 36 AND 38).

JULIE WATSON, EXAMINING ATTORNEY

CLASS 9—(Continued).

SN 77-160,956. PARAGON VISION SCIENCES, INC., MESA, AZ. FILED 4-19-2007.

SUREPAC

THE MARK CONSISTS OF STANDARD CHARACTERS WITHOUT CLAIM TO ANY PARTICULAR FONT, STYLE, SIZE, OR COLOR.

FOR SINGLE USE CONTACT LENS DISPENSING PACKS; CONTACT LENSES (U.S. CLS. 21, 23, 26, 36 AND 38).

JESSICA FATHY, EXAMINING ATTORNEY

CLASS 9—(Continued).

SN 77-161,202. NEWPORT CORPORATION, IRVINE, CA. FILED 4-19-2007.

SOLSTICE

THE MARK CONSISTS OF STANDARD CHARACTERS WITHOUT CLAIM TO ANY PARTICULAR FONT, STYLE, SIZE, OR COLOR.

FOR LASERS FOR NON-MEDICAL USE; LASER AMPLIFIERS (U.S. CLS. 21, 23, 26, 36 AND 38).

JOHN DWYER, EXAMINING ATTORNEY

SN 77-161,036. LIVE NATION WORLDWIDE, INC., BEVERLY HILLS, CA. FILED 4-19-2007.

TRUNK

THE MARK CONSISTS OF STANDARD CHARACTERS WITHOUT CLAIM TO ANY PARTICULAR FONT, STYLE, SIZE, OR COLOR.

OWNER OF U.S. REG. NOS. 2,892,905, 2,980,522 AND 3,109,691.

FOR EYEWEAR, NAMELY, SUNGLASSES, EYEGLASSES, SUNGLASS AND EYEGLASS CASES (U.S. CLS. 21, 23, 26, 36 AND 38).

STEVEN JACKSON, EXAMINING ATTORNEY

SN 77-161,204. SVS SOFTWARE DEVELOPMENT, LLC, LAS VEGAS, NV. FILED 4-19-2007.

EINKSIGN

THE MARK CONSISTS OF STANDARD CHARACTERS WITHOUT CLAIM TO ANY PARTICULAR FONT, STYLE, SIZE, OR COLOR.

FOR COMPUTER SOFTWARE FOR OBTAINING DIGITIZED SIGNATURES FOR ELECTRONICALLY TAGGED DOCUMENTS IN A SECURE ELECTRONIC DOCUMENT FORMAT (U.S. CLS. 21, 23, 26, 36 AND 38).

EMILY CHUO, EXAMINING ATTORNEY

SN 77-161,078. TASKTOP TECHNOLOGIES INCORPORATED, VANCOUVER, CANADA, FILED 4-19-2007.

Tasktop

THE MARK CONSISTS OF STANDARD CHARACTERS WITHOUT CLAIM TO ANY PARTICULAR FONT, STYLE, SIZE, OR COLOR.

FOR COMPUTER SOFTWARE FOR THE COLLECTION, EDITING, ORGANIZING, MODIFYING, BOOK MARKING, TRANSMISSION, STORAGE AND SHARING OF DATA AND INFORMATION (U.S. CLS. 21, 23, 26, 36 AND 38).

JESSICA A. POWERS, EXAMINING ATTORNEY

SN 77-161,205. SVS SOFTWARE DEVELOPMENT, LLC, LAS VEGAS, NV. FILED 4-19-2007.

EINKSOFT

THE MARK CONSISTS OF STANDARD CHARACTERS WITHOUT CLAIM TO ANY PARTICULAR FONT, STYLE, SIZE, OR COLOR.

FOR COMPUTER SOFTWARE FOR EDITING, TAGGING AND CAPTURING ELECTRONIC SIGNATURES ON CD-ROM, DVD-ROM, AND FOR DOWNLOADING OVER THE INTERNET (U.S. CLS. 21, 23, 26, 36 AND 38).

EMILY CHUO, EXAMINING ATTORNEY

CLASS 9—(Continued).

SN 77-161,206. SVS SOFTWARE DEVELOPMENT, LLC, LAS VEGAS, NV. FILED 4-19-2007.

EINKTAG

THE MARK CONSISTS OF STANDARD CHARACTERS WITHOUT CLAIM TO ANY PARTICULAR FONT, STYLE, SIZE, OR COLOR.

FOR COMPUTER SOFTWARE FOR ELECTRONICALLY EDITING AND TAGGING DOCUMENTS (U.S. CLS. 21, 23, 26, 36 AND 38).

EMILY CHUO, EXAMINING ATTORNEY

SN 77-161,384. ACS MARKETING, L.P., DALLAS, TX. FILED 4-20-2007.

AGILEJURY

THE MARK CONSISTS OF STANDARD CHARACTERS WITHOUT CLAIM TO ANY PARTICULAR FONT, STYLE, SIZE, OR COLOR.

FOR JURY MANAGEMENT SOFTWARE (U.S. CLS. 21, 23, 26, 36 AND 38).

DOMINIC J. FERRAIUOLO, EXAMINING ATTORNEY

SN 77-161,386. ACS MARKETING, L.P., DALLAS, TX. FILED 4-20-2007.

AGILECOURT

THE MARK CONSISTS OF STANDARD CHARACTERS WITHOUT CLAIM TO ANY PARTICULAR FONT, STYLE, SIZE, OR COLOR.

FOR COURT MANAGEMENT SOFTWARE (U.S. CLS. 21, 23, 26, 36 AND 38).

DOMINIC J. FERRAIUOLO, EXAMINING ATTORNEY

CLASS 9—(Continued).

SN 77-161,412. SNAPPIN RECORDS, INC., KENNESAW, GA. FILED 4-20-2007.



NO CLAIM IS MADE TO THE EXCLUSIVE RIGHT TO USE "RECORDS", APART FROM THE MARK AS SHOWN. THE COLOR(S) ORANGE, YELLOW, GREEN, BLACK AND WHITE IS/ARE CLAIMED AS A FEATURE OF THE MARK.

THE MARK CONSISTS OF ORANGE AND YELLOW BACKGROUND FLAMES WITH A GREEN TURTLE IN THE FOREGROUND TAKING A BITE OUT OF A BLACK AND WHITE VINYL RECORD, WITH THE WORDS "SNAPPIN" IN GREEN AND "RECORDS" IN BLACK SUPERIMPOSED ACROSS THE LOWER PORTION OF THE MARK.

FOR PRE-RECORDED CDS, VIDEO TAPES, LASER DISKS AND DVDS FEATURING PERFORMANCES OF MUSICAL ARTISTS (U.S. CLS. 21, 23, 26, 36 AND 38).

JOHN DWYER, EXAMINING ATTORNEY

SN 77-161,713. ICON EYEWEAR, INC., NEW YORK, NY. FILED 4-20-2007.



THE MARK CONSISTS OF A RENDITION OF AN EYE CONTAINING A LOWER CASE "I", FOLLOWED BY THE WORD "MOTION".

FOR EYEGLASSES (U.S. CLS. 21, 23, 26, 36 AND 38).

FIRST USE 3-31-2005; IN COMMERCE 3-31-2005.

JUDITH HELFMAN, EXAMINING ATTORNEY

SN 77-161,817. C & A SCIENTIFIC CO., INC., MANASSAS, VA. FILED 4-20-2007.

My First Lab

THE MARK CONSISTS OF STANDARD CHARACTERS WITHOUT CLAIM TO ANY PARTICULAR FONT, STYLE, SIZE, OR COLOR.

FOR MICROSCOPES; MICROSCOPES, INCLUDING STEREOMICROSCOPES (U.S. CLS. 21, 23, 26, 36 AND 38).

FIRST USE 3-10-1998; IN COMMERCE 7-15-1998.

RONALD AIKENS, EXAMINING ATTORNEY

CLASS 9—(Continued).

SN 77-161,865. ICON EYEWEAR, INC., NEW YORK, NY.
FILED 4-20-2007.



THE MARK CONSISTS OF A RENDITION OF AN EYE
CONTAINING A LOWER CASE "I", FOLLOWED BY THE
WORD "PERFORMANCE".

FOR EYEGLASSES (U.S. CLS. 21, 23, 26, 36 AND 38).
FIRST USE 3-31-2005; IN COMMERCE 3-31-2005.
JUDITH HELFMAN, EXAMINING ATTORNEY

SN 77-162,097. FLYING RABBIT ENTERPRISES, LLC, CIN-
CINNATI, OH. FILED 4-20-2007.

BAFFLE!

THE MARK CONSISTS OF STANDARD CHARACTERS
WITHOUT CLAIM TO ANY PARTICULAR FONT, STYLE,
SIZE, OR COLOR.

OWNER OF U.S. REG. NO. 3,034,698.
FOR GAME SOFTWARE (U.S. CLS. 21, 23, 26, 36 AND
38).
FIRST USE 6-6-2004; IN COMMERCE 6-0-2006.
BILL DAWE, EXAMINING ATTORNEY

SN 77-162,398. TEOH, ENG SENG, CHARLOTTE, NC. FILED
4-20-2007.

TD Fish

THE MARK CONSISTS OF STANDARD CHARACTERS
WITHOUT CLAIM TO ANY PARTICULAR FONT, STYLE,
SIZE, OR COLOR.

FOR DIGITAL AUDIO PLAYERS (U.S. CLS. 21, 23, 26,
36 AND 38).
ANNE E. GUSTASON, EXAMINING ATTORNEY

CLASS 9—(Continued).

SN 77-162,486. WISKERCHEN, THOMAS A, MARSHFIELD,
WI. FILED 4-21-2007.

SMARTgift

THE MARK CONSISTS OF STANDARD CHARACTERS
WITHOUT CLAIM TO ANY PARTICULAR FONT, STYLE,
SIZE, OR COLOR.

FOR BLANK ELECTRONIC CHIP CARDS; BLANK
INTEGRATED CIRCUIT CARDS; BLANK SMART
CARDS; ENCODED ELECTRONIC CHIP CARDS CON-
TAINING PROGRAMMING USED TO IDENTIFY THE
TYPE OF CARD, AND TO THEN ALLOW PROCESSING
OF A SALES TRANSACTION; ENCODED ELECTRONIC
CHIP CARDS FOR IDENTIFYING THE TYPE OF CARD,
AND TO THEN ALLOW PROCESSING OF A SALES
TRANSACTION; ENCODED INTEGRATED CIRCUIT
CARDS CONTAINING PROGRAMMING USED TO
IDENTIFY THE TYPE OF CARD, AND TO ALLOW
PROCESSING OF A SALES TRANSACTION; ENCODED
SMART CARDS CONTAINING PROGRAMMING USED
TO IDENTIFY THE TYPE OF CARD, AND TO THEN
ALLOW PROCESSING OF A SALES TRANSACTION
(U.S. CLS. 21, 23, 26, 36 AND 38).

CHERYL CLAYTON, EXAMINING ATTORNEY

SN 77-162,501. BURGE, DAVID LUCAS, HANAIEI, HI.
FILED 4-21-2007.

SUKA

THE MARK CONSISTS OF STANDARD CHARACTERS
WITHOUT CLAIM TO ANY PARTICULAR FONT, STYLE,
SIZE, OR COLOR.

OWNER OF U.S. REG. NO. 2,686,757.
FOR DIGITAL MATERIALS, NAMELY, CDS, DVDS,
AND DOWNLOADABLE VIDEO AND AUDIO FILES
FEATURING INSTRUCTION IN MEDITATION, HOLIS-
TIC DIET, AND NATURAL LIFESTYLE (U.S. CLS. 21, 23,
26, 36 AND 38).

FIRST USE 4-26-2002; IN COMMERCE 4-26-2002.
NORA BUCHANAN WILL, EXAMINING ATTORNEY

CLASS 9—(Continued).

SN 77-163,923. EVEREADY BATTERY COMPANY, INC., ST. LOUIS, MO. FILED 4-24-2007.

ENERGI TO GO

THE MARK CONSISTS OF STANDARD CHARACTERS WITHOUT CLAIM TO ANY PARTICULAR FONT, STYLE, SIZE, OR COLOR.

OWNER OF U.S. REG. NO. 3,137,268.

NO CLAIM IS MADE TO THE EXCLUSIVE RIGHT TO USE "ENERGY", APART FROM THE MARK AS SHOWN.

FOR DC/AC POWER CONVERTERS, ADAPTORS AND INVERTERS (U.S. CLS. 21, 23, 26, 36 AND 38).

SETH A. RAPPAPORT, EXAMINING ATTORNEY

CLASS 9—(Continued).

SN 77-164,264. SENSITRON INC., SAN MATEO, CA. FILED 4-24-2007.

CRITICAL CARETRENDS

THE MARK CONSISTS OF STANDARD CHARACTERS WITHOUT CLAIM TO ANY PARTICULAR FONT, STYLE, SIZE, OR COLOR.

OWNER OF U.S. REG. NO. 3,049,042.

FOR COMPUTER PROGRAM AND SOFTWARE SYSTEM FOR MANAGEMENT AND STORAGE OF CLINICAL, HOSPITAL, AND MEDICAL DATA (U.S. CLS. 21, 23, 26, 36 AND 38).

FIRST USE 11-1-2006; IN COMMERCE 11-1-2006.

LINDSEY RUBIN, EXAMINING ATTORNEY

SN 77-164,021. TWENTIETH CENTURY FOX FILM CORPORATION, LOS ANGELES, CA. FILED 4-24-2007.

TAKE DOWN STAY DOWN

THE MARK CONSISTS OF STANDARD CHARACTERS WITHOUT CLAIM TO ANY PARTICULAR FONT, STYLE, SIZE, OR COLOR.

FOR COMPUTER SOFTWARE FOR MANAGING THE DISSEMINATION OF CONTENT VIA THE INTERNET (U.S. CLS. 21, 23, 26, 36 AND 38).

ROSELLE HERRERA, EXAMINING ATTORNEY

SN 77-164,278. MERCEDES MEDICAL, INC., SARASOTA, FL. FILED 4-24-2007.

THE WHITE LINE

THE MARK CONSISTS OF STANDARD CHARACTERS WITHOUT CLAIM TO ANY PARTICULAR FONT, STYLE, SIZE, OR COLOR.

OWNER OF U.S. REG. NOS. 1,988,621 AND 3,077,176.

NO CLAIM IS MADE TO THE EXCLUSIVE RIGHT TO USE "LINE", APART FROM THE MARK AS SHOWN.

FOR GLASS MICROSCOPE SLIDES FOR USE IN CLINICAL AND MEDICAL LABORATORIES (U.S. CLS. 21, 23, 26, 36 AND 38).

MICHAEL KEATING, EXAMINING ATTORNEY

SN 77-164,033. EVEREADY BATTERY COMPANY, INC., ST. LOUIS, MO. FILED 4-24-2007.

ENERGI TO GO

THE MARK CONSISTS OF STANDARD CHARACTERS WITHOUT CLAIM TO ANY PARTICULAR FONT, STYLE, SIZE, OR COLOR.

OWNER OF U.S. REG. NO. 3,137,268.

NO CLAIM IS MADE TO THE EXCLUSIVE RIGHT TO USE "ENERGY", APART FROM THE MARK AS SHOWN.

FOR ELECTRIC AND BATTERY POWERED POWER STATIONS AND POWER PACKS, NAMELY PORTABLE POWER SUPPLY UNITS, VOLTAGE CONVERTERS, PORTABLE BATTERY JUMP CHARGERS (U.S. CLS. 21, 23, 26, 36 AND 38).

SETH A. RAPPAPORT, EXAMINING ATTORNEY

SN 77-165,409. TEK PANEL INC., SUGAR GROVE, IL. FILED 4-25-2007.

BATTLEBOOK

THE MARK CONSISTS OF STANDARD CHARACTERS WITHOUT CLAIM TO ANY PARTICULAR FONT, STYLE, SIZE, OR COLOR.

FOR NOTEBOOK COMPUTERS (U.S. CLS. 21, 23, 26, 36 AND 38).

ODESSA BIBBINS, EXAMINING ATTORNEY

CLASS 9—(Continued).

SN 77-166,274. FOLLETT CORPORATION, RIVER GROVE, IL. FILED 4-26-2007.

TITLEMAP

THE MARK CONSISTS OF STANDARD CHARACTERS WITHOUT CLAIM TO ANY PARTICULAR FONT, STYLE, SIZE, OR COLOR.

FOR COMPUTER SOFTWARE PROGRAM FOR UPDATING AND REVISING SCHOOL LIBRARY INVENTORY (U.S. CLS. 21, 23, 26, 36 AND 38).

JOHN WILKE, EXAMINING ATTORNEY

SN 77-166,565. VXI CORPORATION, ROLLINSFORD, NH. FILED 4-26-2007.



OWNER OF U.S. REG. NOS. 2,398,354, 2,411,090 AND 2,448,108.

FOR AUDIO HEADSETS FOR TELEPHONES AND SWITCHBOXES FOR USE WITH AUDIO HEADSETS FOR TELEPHONES (U.S. CLS. 21, 23, 26, 36 AND 38).

FIRST USE 5-10-2005; IN COMMERCE 5-10-2005.
JESSICA A. POWERS, EXAMINING ATTORNEY

SN 77-169,067. WAL-MART STORES, INC., BENTONVILLE, AR. FILED 4-30-2007.

ITEMLINK

THE MARK CONSISTS OF STANDARD CHARACTERS WITHOUT CLAIM TO ANY PARTICULAR FONT, STYLE, SIZE, OR COLOR.

FOR COMPUTER SOFTWARE FOR DATABASE MANAGEMENT, NAMELY, TO SYNCHRONIZE DATA FROM IN-HOUSE DATABASES WITH INFORMATION PROVIDED BY OUTSIDE SOURCES (U.S. CLS. 21, 23, 26, 36 AND 38).

SCOTT SISUN, EXAMINING ATTORNEY

CLASS 9—(Continued).

SN 77-172,830. REFEREE ENTERPRISES, INC., RACINE, WI. FILED 5-4-2007.

REFEREE ACTIVE MEDIA

THE MARK CONSISTS OF STANDARD CHARACTERS WITHOUT CLAIM TO ANY PARTICULAR FONT, STYLE, SIZE, OR COLOR.

OWNER OF U.S. REG. NO. 1,569,655.

NO CLAIM IS MADE TO THE EXCLUSIVE RIGHT TO USE "REFEREE" AND "MEDIA", APART FROM THE MARK AS SHOWN.

FOR DIGITAL VISUAL PRODUCTS, NAMELY, PRE-RECORDED DVDS AND DOWNLOADABLE VIDEO MATERIAL VIA THE INTERNET, FEATURING ACTUAL VISUAL REPRESENTATIONS OF OFFICIATING TECHNIQUES AND POSITIONING IN SPORTING EVENTS FOR INSTRUCTIONAL PURPOSES (U.S. CLS. 21, 23, 26, 36 AND 38).

ROBIN CHOSID, EXAMINING ATTORNEY

SN 77-173,957. TURNING TECHNOLOGIES, LLC, YOUNGSTOWN, OH. FILED 5-7-2007.

TOUCHPOINTS

THE MARK CONSISTS OF STANDARD CHARACTERS WITHOUT CLAIM TO ANY PARTICULAR FONT, STYLE, SIZE, OR COLOR.

FOR COMPUTER SOFTWARE SUITE, NAMELY, A GROUPING OF SOFTWARE APPLICATIONS DESIGNED TO PROMOTE AND MANAGE LEARNING ACTIVITIES IN PRIMARY AND SECONDARY EDUCATION MARKETS (U.S. CLS. 21, 23, 26, 36 AND 38).

ROBERT C. CLARK JR., EXAMINING ATTORNEY

SN 77-174,569. TWENTIETH CENTURY FOX FILM CORPORATION, LOS ANGELES, CA. FILED 5-7-2007.

EVIEW

THE MARK CONSISTS OF STANDARD CHARACTERS WITHOUT CLAIM TO ANY PARTICULAR FONT, STYLE, SIZE, OR COLOR.

FOR COMPUTER SOFTWARE AND HARDWARE USED FOR COPYING DVD'S AND OTHER VIDEO RECORDINGS; COMPUTER SOFTWARE AND HARDWARE FOR USE IN THE ENCRYPTION AND DECRYPTION OF DIGITAL MULTIMEDIA FILES (U.S. CLS. 21, 23, 26, 36 AND 38).

ROSELLE HERRERA, EXAMINING ATTORNEY

CLASS 9—(Continued).

SN 77-176,237. SAMSUNG ELECTRONICS CO., LTD., GYEONGGI-DO, REPUBLIC OF KOREA, FILED 5-9-2007.

BORDEAUX

THE MARK CONSISTS OF STANDARD CHARACTERS WITHOUT CLAIM TO ANY PARTICULAR FONT, STYLE, SIZE, OR COLOR.

FOR SEMICONDUCTORS; COMPUTER SOFTWARE TO ENHANCE THE AUDIO-VISUAL CAPABILITIES OF MULTIMEDIA APPLICATIONS, NAMELY, FOR THE INTEGRATION OF TEXT, AUDIO, GRAPHICS, STILL IMAGES AND MOVING PICTURES; COMPUTERS; LAPTOP COMPUTERS; COMPUTER MONITORS; OPTICAL DISC DRIVES; COMPUTER PRINTERS; COMPUTER MOUSE; PERSONAL DIGITAL ASSISTANTS (PDA); DVD PLAYERS; MP3 PLAYERS; COMPACT DISC PLAYERS; HEADPHONES; TELEVISION SETS; TELEPHONES; DRY CELLS; BATTERY CHARGERS; ELECTRIC IRONS; CASH REGISTERS; VIDEO CAMERAS; CAMCORDERS (U.S. CLS. 21, 23, 26, 36 AND 38).

DORITT L. CARROLL, EXAMINING ATTORNEY

SN 77-177,519. GFX INTERNATIONAL, INC., GRAYSLAKE, IL. FILED 5-10-2007.

STORE PROFILER

THE MARK CONSISTS OF STANDARD CHARACTERS WITHOUT CLAIM TO ANY PARTICULAR FONT, STYLE, SIZE, OR COLOR.

NO CLAIM IS MADE TO THE EXCLUSIVE RIGHT TO USE "STORE". APART FROM THE MARK AS SHOWN.

FOR COMPUTER SOFTWARE FOR MANAGING PROMOTIONAL SIGNAGE IN RETAIL STORE ENVIRONMENTS (U.S. CLS. 21, 23, 26, 36 AND 38).

FIRST USE 0-0-1999; IN COMMERCE 0-0-1999.
EDWARD NELSON, EXAMINING ATTORNEY

CLASS 9—(Continued).

SN 77-178,627. SMITH, BRIAN K., LONG BEACH, CA. FILED 5-11-2007.



NO CLAIM IS MADE TO THE EXCLUSIVE RIGHT TO USE "RECORDS", APART FROM THE MARK AS SHOWN.

THE MARK CONSISTS OF A BLACK SILHOUETTE OF A DANCER POSING WITH ONE LEG LIFTED UP WITH BOTH HANDS TO THE BACK OF THE HEAD WITH THE HEAD TILED BACK, WITH THE WORDS "BRI-GUY" CENTERED ABOVE THE DANCER AND THE WORD "RECORDS" CENTERED BELOW THE DANCER, ALL WITHIN A RECTANGULAR BACKGROUND WITH A BORDE.

FOR AUDIO AND VIDEO RECORDINGS FEATURING MUSIC (U.S. CLS. 21, 23, 26, 36 AND 38).

FIRST USE 5-1-1995; IN COMMERCE 5-1-1995.
CARYN GLASSER, EXAMINING ATTORNEY

SN 77-182,073. AUTOMATED PROCESSES, INC., JESSUP, MD. FILED 5-16-2007.

API LUNCHBOX

THE MARK CONSISTS OF STANDARD CHARACTERS WITHOUT CLAIM TO ANY PARTICULAR FONT, STYLE, SIZE, OR COLOR.

OWNER OF U.S. REG. NO. 3,156,120.

FOR ELECTRONIC EQUIPMENT, NAMELY, MICROPHONE PREAMPS, AUDIO EQUALIZERS, AUDIO COMPRESSORS FOR PROCESSING AUDIO SIGNALS, AND AUDIO MIXING CONSOLES, NAMELY, AUDIO MIXER CONSOLES (U.S. CLS. 21, 23, 26, 36 AND 38).

FIRST USE 4-0-1989; IN COMMERCE 4-0-1989.
KAREN BRACEY, EXAMINING ATTORNEY

CLASS 9—(Continued).

SN 77-183,258. PICOTRONICS INDUSTRIES (HOLDINGS) LIMITED, KWUN TONG, KOWLOON, HONG KONG, FILED 5-17-2007.

PICOTRONICS

THE MARK CONSISTS OF STANDARD CHARACTERS WITHOUT CLAIM TO ANY PARTICULAR FONT, STYLE, SIZE, OR COLOR.

OWNER OF HONG KONG REG. NO. 19840894, DATED 6-14-1983, EXPIRES 6-14-2014.

OWNER OF U.S. REG. NO. 1,442,815.

FOR TELEPHONES; TELEPHONE ANSWERING MACHINES; TELEPHONE APPARATUS; TELEPHONE SETS; RADIOS INCORPORATING CLOCKS (U.S. CLS. 21, 23, 26, 36 AND 38).

CURTIS FRENCH, EXAMINING ATTORNEY

SN 77-184,382. KLEIN, ELLIOT, NEW YORK, NY. FILED 5-18-2007.

PRIVATAG

THE MARK CONSISTS OF STANDARD CHARACTERS WITHOUT CLAIM TO ANY PARTICULAR FONT, STYLE, SIZE, OR COLOR.

FOR RADIO FREQUENCY IDENTIFICATION (RFID) TAGS DESIGNED TO PROTECT AND OPTIONALLY SHIELD FROM RFID ENERGY FOR AIRLINE BAGGAGE IDENTIFICATION WITH PRIVACY PROTECTION SERVICE FEATURES (U.S. CLS. 21, 23, 26, 36 AND 38).

CARRIE GENOVESE, EXAMINING ATTORNEY

SN 77-186,722. FOURSTAR GROUP INC., TAIPEI, TAIWAN, FILED 5-22-2007.

Vuescape

THE MARK CONSISTS OF STANDARD CHARACTERS WITHOUT CLAIM TO ANY PARTICULAR FONT, STYLE, SIZE, OR COLOR.

FOR COMPUTER MONITORS; FLAT PANEL DISPLAY SCREENS; DIGITAL PHOTO FRAMES FOR DISPLAYING DIGITAL PICTURES, VIDEO CLIPS AND MUSIC (U.S. CLS. 21, 23, 26, 36 AND 38).

FIRST USE 3-2-2007; IN COMMERCE 4-3-2007.

ANGELA GAW, EXAMINING ATTORNEY

CLASS 9—(Continued).

SN 77-187,216. T-MOBILE USA, INC., BELLEVUE, WA. FILED 5-22-2007.

SIDEKICK SLIDE

THE MARK CONSISTS OF STANDARD CHARACTERS WITHOUT CLAIM TO ANY PARTICULAR FONT, STYLE, SIZE, OR COLOR.

OWNER OF U.S. REG. NOS. 3,012,845, 3,152,740 AND OTHERS.

FOR WIRELESS HANDHELD TELECOMMUNICATIONS DEVICES, NAMELY, CELLULAR TELEPHONE THAT COMBINES WIRELESS VOICE AND DATA TELECOMMUNICATIONS FUNCTIONS, DIGITAL IMAGING FUNCTIONS, COMPUTING FUNCTIONS, PERMITS THE TWO-WAY WIRELESS TRANSMISSION OF E-MAIL AND TEXT, AND PERMITS WIRELESS ACCESS TO A GLOBAL COMPUTER NETWORK (U.S. CLS. 21, 23, 26, 36 AND 38).

JENNIFER KRISP, EXAMINING ATTORNEY

SN 77-188,687. MITSUBISHI ELECTRIC CORPORATION, CHIYODA-KU, TOKYO, JAPAN, FILED 5-23-2007.

Ku-Mate

THE MARK CONSISTS OF STANDARD CHARACTERS WITHOUT CLAIM TO ANY PARTICULAR FONT, STYLE, SIZE, OR COLOR.

FOR ANTENNAS FOR SHIPS AND VESSELS (U.S. CLS. 21, 23, 26, 36 AND 38).

MICHELE SWAIN, EXAMINING ATTORNEY

SN 77-190,864. LAIRD TECHNOLOGIES, INC., DELAWARE WATERGAP, PA. FILED 5-25-2007.

ACTIVV

THE MARK CONSISTS OF STANDARD CHARACTERS WITHOUT CLAIM TO ANY PARTICULAR FONT, STYLE, SIZE, OR COLOR.

FOR ANTENNAS (U.S. CLS. 21, 23, 26, 36 AND 38).

ALEXANDER L. POWERS, EXAMINING ATTORNEY

CLASS 9—(Continued).

SN 77-190,957. ALPINE BIOMED CORP., FOUNTAIN VALLEY, CA. FILED 5-25-2007.

GastroTrac

THE MARK CONSISTS OF STANDARD CHARACTERS WITHOUT CLAIM TO ANY PARTICULAR FONT, STYLE, SIZE, OR COLOR.

FOR COMPUTER SOFTWARE FOR MEDICAL DIAGNOSING; COMPUTERS AND COMPUTER WORKSTATIONS COMPRISING COMPUTER MEMORIES, COMPUTER KEYBOARDS, COMPUTER PRINTERS, COMPUTER INTERFACES, COMPUTER PROCESSORS, VISUAL DISPLAY UNITS AND SCANNERS (U.S. CLS. 21, 23, 26, 36 AND 38).

JOHN HWANG, EXAMINING ATTORNEY

SN 77-191,995. SMARSH, INC., PORTLAND, OR. FILED 5-29-2007.

VIRTUAL COMPLIANCE OFFICER

THE MARK CONSISTS OF STANDARD CHARACTERS WITHOUT CLAIM TO ANY PARTICULAR FONT, STYLE, SIZE, OR COLOR.

NO CLAIM IS MADE TO THE EXCLUSIVE RIGHT TO USE "VIRTUAL", APART FROM THE MARK AS SHOWN.

FOR COMPUTER SOFTWARE FOR USE IN CORPORATE EMAIL SUPERVISION, NAMELY, FOR MONITORING AND DATABASE MANAGEMENT OF EMAIL, FLAGGING EMAIL MESSAGES FOR REVIEW, AND AUTOMATING ARCHIVAL OF EMAIL MESSAGES (U.S. CLS. 21, 23, 26, 36 AND 38).

FIRST USE 4-16-2007; IN COMMERCE 4-16-2007.
HANNO RITTNER, EXAMINING ATTORNEY

SN 77-192,933. TSD INTEGRATED CONTROLS, LLC, PLYMOUTH, MN. FILED 5-30-2007.

FARMLINK

THE MARK CONSISTS OF STANDARD CHARACTERS WITHOUT CLAIM TO ANY PARTICULAR FONT, STYLE, SIZE, OR COLOR.

FOR VEHICLE LOCATOR AND DATA LOGGING DEVICE PROGRAMMED TO USE GLOBAL POSITION SYSTEMS (GPS) AND TELECOMMUNICATIONS (U.S. CLS. 21, 23, 26, 36 AND 38).

JESSICA FATHY, EXAMINING ATTORNEY

CLASS 9—(Continued).

SN 77-195,553. DELAWARE CAPITAL FORMATION, INC., WILMINGTON, DE. FILED 6-1-2007.

SAWGAS

THE MARK CONSISTS OF STANDARD CHARACTERS WITHOUT CLAIM TO ANY PARTICULAR FONT, STYLE, SIZE, OR COLOR.

FOR GAS SENSORS FOR MEASURING GAS CONCENTRATION (U.S. CLS. 21, 23, 26, 36 AND 38).

SUSAN LESLIE DUBOIS, EXAMINING ATTORNEY

SN 77-199,923. NIPPON DENKI KABUSHIKI KAISHA, DBA NEC CORPORATION, TOKYO, JAPAN, FILED 6-7-2007.

SYNACENTER

THE MARK CONSISTS OF STANDARD CHARACTERS WITHOUT CLAIM TO ANY PARTICULAR FONT, STYLE, SIZE, OR COLOR.

FOR COMPUTER SOFTWARE FOR RECORDING AND ANALYZING ELECTROENCEPHALOGRAPHIC DATA; COMPUTER PROGRAMS AND DATA PROCESSORS FOR ANALYZING AND PROCESSING ELECTROENCEPHALOGRAPHIC AND MAGNETOENCEPHALOGRAPHIC DATA (U.S. CLS. 21, 23, 26, 36 AND 38).

DOMINIC J. FERRAIUOLO, EXAMINING ATTORNEY

SN 77-200,005. SAMSUNG ELECTRONICS CO., LTD., GYEONGGI-DO, REPUBLIC OF KOREA, FILED 6-7-2007.

SWAY

THE MARK CONSISTS OF STANDARD CHARACTERS WITHOUT CLAIM TO ANY PARTICULAR FONT, STYLE, SIZE, OR COLOR.

FOR MOBILE TELEPHONES; MOBILE TELEPHONES WITH MP3 PLAYER FUNCTIONS; MOBILE TELEPHONE ACCESSORIES, NAMELY, RECHARGEABLE BATTERIES, BATTERY CHARGERS, HEADSETS AND LEATHER CASES FOR MOBILE TELEPHONES (U.S. CLS. 21, 23, 26, 36 AND 38).

DORITT L. CARROLL, EXAMINING ATTORNEY

CLASS 9—(Continued).

SN 77-201,588. BANOM, INC., WAYNE, PA. FILED 6-8-2007.

REFLEX

THE MARK CONSISTS OF STANDARD CHARACTERS WITHOUT CLAIM TO ANY PARTICULAR FONT, STYLE, SIZE, OR COLOR.
FOR CUT-RESISTANT GLOVES FOR INDUSTRIAL USE (U.S. CLS. 21, 23, 26, 36 AND 38).
REGINA DRUMMOND, EXAMINING ATTORNEY

SN 77-202,621. BIZY, INC., PALM SPRINGS, CA. FILED 6-11-2007.

PLACEMANAGER

THE MARK CONSISTS OF STANDARD CHARACTERS WITHOUT CLAIM TO ANY PARTICULAR FONT, STYLE, SIZE, OR COLOR.
FOR COMPUTER SOFTWARE FOR USE ON COMPUTER COMMUNICATION NETWORKS, NAMELY, SOFTWARE FOR CREATING, EDITING AND DELIVERING TEXTUAL AND GRAPHIC INFORMATION VIA COMPUTER NETWORKS AND GLOBAL COMMUNICATION NETWORKS, AND INSTRUCTION MANUALS SOLD AS A UNIT; WEB SITE DEVELOPMENT SOFTWARE (U.S. CLS. 21, 23, 26, 36 AND 38).
AMEETA JORDAN, EXAMINING ATTORNEY

SN 77-203,549. BANOM, INC., WAYNE, PA. FILED 6-12-2007.

DuraSteel

THE MARK CONSISTS OF STANDARD CHARACTERS WITHOUT CLAIM TO ANY PARTICULAR FONT, STYLE, SIZE, OR COLOR.
FOR CUT-RESISTANT GLOVES FOR INDUSTRIAL USE (U.S. CLS. 21, 23, 26, 36 AND 38).
REGINA DRUMMOND, EXAMINING ATTORNEY

CLASS 9—(Continued).

SN 77-210,331. AGC, INC., CLEVELAND, OH. FILED 6-20-2007.

TREASURED EXPRESSIONS

THE MARK CONSISTS OF STANDARD CHARACTERS WITHOUT CLAIM TO ANY PARTICULAR FONT, STYLE, SIZE, OR COLOR.
FOR DECORATIVE MAGNETS (U.S. CLS. 21, 23, 26, 36 AND 38).
MICHELE SWAIN, EXAMINING ATTORNEY

SN 77-226,460. EMERGENCY ESSENTIALS, INC., OREM, UT. FILED 7-10-2007.

BEPREPARED.COM

THE MARK CONSISTS OF STANDARD CHARACTERS WITHOUT CLAIM TO ANY PARTICULAR FONT, STYLE, SIZE, OR COLOR.
FOR AUTOMOTIVE PREPAREDNESS ROAD KIT CONSISTING OF JUMPER CABLES, FLASHLIGHT, BATTERIES, CANDLES, FIRST AID KIT, FIRST AID GUIDE BOOK, MULTIFUNCTION UTILITY KNIFE, WATER RATIONS, AND SLEEPING BAGS, SOLD AS A UNIT (U.S. CLS. 21, 23, 26, 36 AND 38).
LINDA LAVACHE, EXAMINING ATTORNEY

SN 77-237,943. LUMINEX CORPORATION, AUSTIN, TX. FILED 7-25-2007.

FLEXMAP 3D

THE MARK CONSISTS OF STANDARD CHARACTERS WITHOUT CLAIM TO ANY PARTICULAR FONT, STYLE, SIZE, OR COLOR.
NO CLAIM IS MADE TO THE EXCLUSIVE RIGHT TO USE "3D", APART FROM THE MARK AS SHOWN.
FOR COMPUTER SOFTWARE, COMPUTER HARDWARE AND LABORATORY INSTRUMENTS USED FOR MOLECULAR ANALYSIS FOR HEALTHCARE, MEDICAL, BIO-DEFENSE/ENVIRONMENTAL, AGRICULTURAL, DIAGNOSTIC, LIFE SCIENCES RESEARCH, ACADEMIC AND OTHER APPLICATIONS (U.S. CLS. 21, 23, 26, 36 AND 38).
JENNIFER KRISP, EXAMINING ATTORNEY

CLASS 9—(Continued).

SN 78-028,359. WINCOR NIXDORF INTERNATIONAL GMBH, D-33106 PADERBORN, FED REP GERMANY, FILED 9-29-2000.

CLASS 9—(Continued).

SN 78-446,960. EVERFOCUS ELECTRONICS CORP., SAN MARINO, CA. FILED 7-7-2004.

BEETLE/NETPOS

FOR COMPUTERIZED CASH REGISTERS (U.S. CLS. 21, 23, 26, 36 AND 38).
DEZMONA MIZELLE, EXAMINING ATTORNEY

EVERACCESS

SN 78-319,951. KAISER FOUNDATION HEALTH PLAN, INC., OAKLAND, CA. FILED 10-28-2003.

KP HEALTHCONNECT

FOR COMPUTER SOFTWARE FOR USE IN MAINTAINING MEDICAL AND OTHER RECORDS OF PATIENTS AND MEMBERS OF AN INTEGRATED HEALTH PLAN AND HEALTHCARE PROVIDER ORGANIZATION AND COMMUNICATING INFORMATION AMONG HEALTH CARE PROFESSIONALS AND OTHERS RELATING TO THE CARE OF SUCH PATIENTS AND PLAN MEMBERS (U.S. CLS. 21, 23, 26, 36 AND 38).
CAROLYN CATALDO, EXAMINING ATTORNEY

THE MARK CONSISTS OF STANDARD CHARACTERS WITHOUT CLAIM TO ANY PARTICULAR FONT, STYLE, SIZE, OR COLOR.

FOR ELECTRONIC IDENTIFICATION EQUIPMENT AND ACCESS CONTROL EQUIPMENT, NAMELY, CONTROLLERS, READERS, CODED CARDS, ENCODED SMART CARDS, MEMORY MODULES, NETWORK MODULES IN THE NATURE OF SERIAL TO ETHERNET ADAPTERS OR BUILT-IN ETHERNET ADAPTERS, INPUT/OUTPUT MODULES IN THE NATURE OF DIGITAL INPUT AND OUTPUT SIGNAL PROCESSING CIRCUITS, ALARM MODULES IN THE NATURE OF DOOR CONTROL SIGNAL CIRCUITS, BACKUP POWER MODULES IN THE NATURE OF BACKUP POWER SUPPLIES AND COMPUTER SOFTWARE ASSOCIATED WITH SAID IDENTIFICATION AND ACCESS CONTROL EQUIPMENT AND FOR COLLECTING, STORING AND TRANSFERRING INFORMATION FROM IDENTIFICATION AND ACCESS CONTROL EQUIPMENT TO A COMPUTER, AND ISSUE CONTROL COMMANDS FROM COMPUTER MANAGEMENT CONSOLES TO VARIOUS ACCESS CONTROL DEVICES (U.S. CLS. 21, 23, 26, 36 AND 38).
RICHARD A. STRASER, EXAMINING ATTORNEY

SN 78-427,422. VOICE, LISA FIONA, LONDON, UNITED KINGDOM, FILED 5-29-2004.

SN 78-505,781. STINGER SYSTEMS, INC, TAMPA, FL. FILED 10-26-2004.

BILLY FURY

THE MARK CONSISTS OF STANDARD CHARACTERS WITHOUT CLAIM TO ANY PARTICULAR FONT, STYLE, SIZE, OR COLOR.

OWNER OF ERPN CMNTY TM OFC REG. NO. 000743906, DATED 9-3-1999, EXPIRES 2-9-2008.

THE NAME(S), PORTRAIT(S), AND/OR SIGNATURE(S) SHOWN IN THE MARK DOES NOT IDENTIFY A PARTICULAR LIVING INDIVIDUAL.

FOR PRE-RECORDED VIDEO DISCS AND VIDEO TAPES FEATURING FEATURE FILMS; PRE-RECORDED DVDS FEATURING FEATURE FILMS, DOCUMENTARIES, TRAILERS AND MUSICAL AUDIO RECORDINGS; PRE-RECORDED COMPACT DISCS FEATURING MUSICAL AUDIO RECORDINGS (U.S. CLS. 21, 23, 26, 36 AND 38).
CHRIS WELLS, EXAMINING ATTORNEY

TruVu

THE MARK CONSISTS OF STANDARD CHARACTERS WITHOUT CLAIM TO ANY PARTICULAR FONT, STYLE, SIZE, OR COLOR.

FOR VIDEO CAMERA FOR USE WITH NON-LETHAL WEAPONS IN THE NATURE OF STUN GUNS (U.S. CLS. 21, 23, 26, 36 AND 38).
HENRY S. ZAK, EXAMINING ATTORNEY

CLASS 9—(Continued).

SN 78-565,689. AUDERA INTERNATIONAL SALES INC., WEST INDIES, BARBADOS, FILED 2-11-2005.

CLASSHD

THE MARK CONSISTS OF STANDARD CHARACTERS WITHOUT CLAIM TO ANY PARTICULAR FONT, STYLE, SIZE, OR COLOR.

FOR APPARATUS FOR RECORDING, TRANSMISSION OR REPRODUCTION OF SOUND; AUDIO AMPLIFIER EQUIPMENT (U.S. CLS. 21, 23, 26, 36 AND 38).
GEORGIA CARTY, EXAMINING ATTORNEY

SN 78-605,894. CITEL TECHNOLOGIES LIMITED, EDWALTON, UNITED KINGDOM, FILED 4-11-2005.

PBXGATEWAY

THE MARK CONSISTS OF STANDARD CHARACTERS WITHOUT CLAIM TO ANY PARTICULAR FONT, STYLE, SIZE, OR COLOR.

OWNER OF U.S. REG. NOS. 2,497,294 AND 2,738,556.
SEC. 2(F).

FOR COMPUTER HARDWARE FOR TELECOMMUNICATIONS THAT CONTAIN ANY OR ALL OF THE FOLLOWING: INTEGRATED LOCAL OR WIDE AREA NETWORK INTERFACES, PBX OR HANDSET DIGITAL LINE INTERFACES, SWITCHES, TELECOMMUNICATIONS EQUIPMENT EMULATORS, SIGNAL CONVERTERS, SUB-SYSTEMS USED TO PACKETIZE VOICE SIGNALS OVER COMMUNICATIONS NETWORKS AND/OR ACCESS LINES, AND HARDWARE USED TO ENABLE REMOTE LOCATIONS TO ACCESS PRIVATE TELEPHONE SYSTEMS, OR TELECOMMUNICATIONS SERVICE PROVIDER NETWORKS; TELECOMMUNICATION DEVICES IN THE NATURE OF TRANSMITTERS, RECEIVERS, TRANSCEIVERS, SIGNAL AMPLIFIERS, ANTENNA, AND TELEPHONES; TELECOMMUNICATIONS NETWORK MANAGEMENT SOFTWARE; SOFTWARE EMBEDDED IN INTEGRATED CIRCUITS USED IN TELECOMMUNICATION HARDWARE, TELECOMMUNICATIONS DEVICES AND/OR NETWORK PERIPHERALS; SOFTWARE EMBEDDED IN INTEGRATED CIRCUITS USED TO PROVIDE REMOTE ACCESS TO TELECOMMUNICATIONS NETWORKS; TELECOMMUNICATIONS SOFTWARE TO MANAGE, DIRECT, ROUTE, TRANSMIT AND/OR RECEIVE TELEPHONE CALLS, ELECTRONIC MESSAGES, AND AUDIO AND DATA SIGNALS OVER WIDE OR LOCAL AREA NETWORKS AND TELECOMMUNICATIONS ACCESS LINES; AND COMPUTER UTILITY PROGRAMS USED TO EMULATE OTHER TELECOMMUNICATIONS DEVICES (U.S. CLS. 21, 23, 26, 36 AND 38).

FIRST USE 9-0-1999; IN COMMERCE 9-0-1999.
LINDA ORNDORFF, EXAMINING ATTORNEY

CLASS 9—(Continued).

SN 78-643,940. A1 CABLE SOLUTIONS, INCORPORATED, WATERTOWN, WI. FILED 6-5-2005.

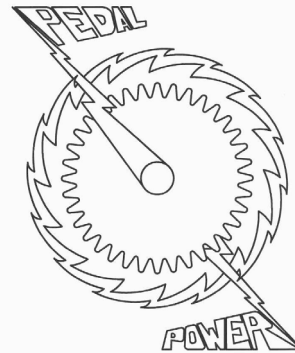

NO CLAIM IS MADE TO THE EXCLUSIVE RIGHT TO USE "PEDAL POWER", APART FROM THE MARK AS SHOWN.

THE MARK CONSISTS OF A STYLIZED BICYCLE SPROCKET AND PEDALS MADE OF LIGHTNING BOLTS WITH THE WORD "PEDAL" AS THE UPPER PEDAL AND THE WORD "POWER" AS THE LOWER PEDAL.

FOR ELECTRIC LUMINESCENT DISPLAY PANEL, USED WHEN EDUCATING OTHERS ON ENERGY CONSERVATION AND ENERGY-RELATED TOPICS (U.S. CLS. 21, 23, 26, 36 AND 38).

FIRST USE 8-15-2004; IN COMMERCE 8-15-2004.
TONJA GASKINS, EXAMINING ATTORNEY

SN 78-684,391. GLOBALSOLUTION INDUSTRY CORPORATION, RIVERSWOOD, IL. FILED 8-3-2005.



NO CLAIM IS MADE TO THE EXCLUSIVE RIGHT TO USE "PROFESSIONAL PROVIDER OF INDUSTRIAL SOLUTION", APART FROM THE MARK AS SHOWN.

THE COLOR(S) BLUE AND RED IS/ARE CLAIMED AS A FEATURE OF THE MARK.

THE COLOR RED APPEARS IN THE TERMS "PROFESSIONAL PROVIDER OF INDUSTRIAL SOLUTION" AND IN THE OUTLINE OF THE TERM "GSI". THE COLOR BLUE APPEARS IN THE TERM "GSI" AND THE DESIGN OF A GLOBE.

FOR ACCESS CONTROL AND ALARM MONITORING SYSTEMS; FIRE ALARM SYSTEMS (U.S. CLS. 21, 23, 26, 36 AND 38).

DAVID HOFFMAN, EXAMINING ATTORNEY

CLASS 9—(Continued).

SN 78-746,248. ROSEMOUNT ANALYTICAL INC., IRVINE, CA. FILED 11-3-2005.

CLARITY

THE MARK CONSISTS OF STANDARD CHARACTERS WITHOUT CLAIM TO ANY PARTICULAR FONT, STYLE, SIZE, OR COLOR.

FOR TURBIDIMETERS FOR USE IN MONITORING INDUSTRIAL PROCESSES (U.S. CLS. 21, 23, 26, 36 AND 38).

FIRST USE 11-2-2004; IN COMMERCE 11-2-2004.
ANNE FARRELL, EXAMINING ATTORNEY

CLASS 9—(Continued).

SN 78-778,801. INTEL CORPORATION, SANTA CLARA, CA. FILED 12-21-2005.



OWNER OF U.S. REG. NOS. 914,978, 3,029,954 AND OTHERS.

FOR FLOPPY DISC DRIVING APPARATUS; ELECTRONIC SECURITY APPARATUS AND SURVEILLANCE APPARATUS, NAMELY, COMPUTER HARDWARE, COMPUTER CHIPS AND MICROPROCESSORS OPTIMIZED FOR ELECTRONIC SECURITY SURVEILLANCE; ALGORITHM SOFTWARE PROGRAMS FOR THE OPERATION AND CONTROL OF COMPUTERS; COMPUTER OPERATING SYSTEM SOFTWARE; COMPUTER OPERATING SYSTEMS; COMPUTER SYSTEM EXTENSIONS, TOOLS AND UTILITIES IN THE FIELD OF APPLICATION SOFTWARE FOR CONNECTING PERSONAL COMPUTERS, NETWORKS, TELECOMMUNICATIONS APPARATUS AND GLOBAL COMPUTER NETWORK APPLICATIONS; COMPUTORIZED TELECOMMUNICATIONS AND NETWORKING EQUIPMENT CONSISTING OF OPERATING SYSTEM SOFTWARE, MODEMS, CAMERAS, HEADSETS, MICROPHONES, CABLES AND ADAPTORS; COMPUTER GAME PROGRAMS; COMPUTER RACKS, COMPUTER CABINETS AND COMPUTER HOLDERS; COMPUTER HARDWARE AND SOFTWARE FOR ENHANCING AND PROVIDING REAL-TIME TRANSFER, TRANSMISSION, RECEPTION, PROCESSING AND DIGITIZING OF AUDIO AND VIDEO GRAPHICS INFORMATION; COMPUTER FIRMWARE, NAMELY, COMPUTER OPERATING SYSTEM SOFTWARE, COMPUTER UTILITY SOFTWARE AND OTHER COMPUTER SOFTWARE USED TO MAINTAIN AND OPERATE COMPUTER SYSTEMS; COMPUTERS; HANDHELD COMPUTERS; MICROCOMPUTERS; MINICOMPUTERS; MEMORY BOARDS; PERSONAL DIGITAL ASSISTANTS; CELLULAR TELEPHONES; SMART PHONES; PORTABLE AND HANDHELD ELECTRONIC PERSONAL ORGANIZERS; COMPUTER HARDWARE; INTEGRATED CIRCUITS; INTEGRATED CIRCUIT MEMORIES; INTEGRATED CIRCUIT CHIPS; COMPUTER CHIPSETS; SEMICONDUCTOR PROCESSORS; SEMICONDUCTOR PROCESSOR CHIPS; SEMICONDUCTOR CHIPS; MICROPROCESSORS; PRINTED CIRCUIT BOARDS; ELECTRONIC CIRCUIT BOARDS; COMPUTER MOTHERBOARDS AND DAUGHTERBOARDS; COMPUTER MEMORIES; COMPUTER OPERATING SYSTEMS; MICROCONTROLLERS; DATA PROCESSORS; CENTRAL PROCESSING UNITS; SEMICONDUCTOR MEMORY DEVICES, NAMELY, SEMICONDUCTOR MEMORIES AND SEMICONDUCTOR MEMORY UNITS; SOFTWARE PROGRAMMABLE PROCESSORS; DIGITAL AND OPTICAL MICROPROCESSORS; COMPUTER PERIPHERALS; VIDEO CIRCUIT BOARDS; AUDIO CIRCUIT BOARDS; AUDIO-VIDEO CIRCUIT BOARDS; VIDEO GRAPHIC ACCELERATORS; MULTIMEDIA ACCELERATORS; VIDEO PROCESSORS; VIDEO PROCESSOR BOARDS; PROCESSOR DIE PACKAGING AND CASINGS; BLANK ELECTRONIC CHIP CARDS, BLANK SMART CARDS, ELECTRONIC CIRCUIT CARDS, FLASH MEMORY CARDS, GRAPHICS CARDS, MAGNETIC CARDS, MICROCHIP CARDS, PCMCIA CARDS, SOUND CARDS, VIDEO CAPTURE CARDS, VIDEO DISPLAY CARDS, ALL FOR THE RECORDAL AND TRANSMISSION OF DATA; MODEMS; COMPUTER HARDWARE AND SOFTWARE FOR PROCESSING, STORAGE, RETRIEVAL, TRANSMISSION, DISPLAY, INPUT, OUTPUT, COMPRESSING, DECOMPRESSING, MODIFYING, BROADCASTING AND PRINTOUT OF

SN 78-771,097. TEGRANT ALLOYD BRANDS, INC., DEKALB, IL. FILED 12-12-2005.

ALLOYD

THE MARK CONSISTS OF STANDARD CHARACTERS WITHOUT CLAIM TO ANY PARTICULAR FONT, STYLE, SIZE, OR COLOR.

FOR HEAT SEALING MACHINES, BOTH WITH AND WITHOUT RADIO FREQUENCY TECHNOLOGY, FOR SEALING PACKAGING, AND PARTS THEREFOR (U.S. CLS. 21, 23, 26, 36 AND 38).

FIRST USE 12-31-1961; IN COMMERCE 12-31-1961.
STEVEN R. FOSTER, EXAMINING ATTORNEY

SN 78-773,695. GEMSTONE SYSTEMS, INC., BEAVERTON, OR. FILED 12-14-2005.

GEMFIRE EDF

THE MARK CONSISTS OF STANDARD CHARACTERS WITHOUT CLAIM TO ANY PARTICULAR FONT, STYLE, SIZE, OR COLOR.

OWNER OF U.S. REG. NO. 2,825,973.
NO CLAIM IS MADE TO THE EXCLUSIVE RIGHT TO USE "EDF", APART FROM THE MARK AS SHOWN.

FOR COMPUTER SOFTWARE, NAMELY, SOFTWARE TO DELIVER, STORE AND MANAGE DATA AND STREAMING EVENTS ACROSS COMPUTER APPLICATIONS (U.S. CLS. 21, 23, 26, 36 AND 38).

ANDREA SAUNDERS, EXAMINING ATTORNEY

CLASS 9—(Continued).

DATA; COMPUTER INPUT AND OUTPUT DEVICES, NAMELY, COMPUTER MICE, TRACKBALLS, COMPUTER MOUSE TOUCHPADS, KEYBOARDS, SCANNERS AND COMPUTER CAMERAS; COMPUTER WORKSTATIONS COMPRISING PROCESSORS, CENTRAL PROCESSING UNITS, COMPUTER MONITORS, COMPUTER PERIPHERALS AND COMPUTER PRINTERS; COMPUTER DATA MEMORIES; STORAGE DEVICES, NAMELY, COMPUTER SERVERS, JUMP DRIVES AND THUMB DRIVES; SECURITY SYSTEMS FOR COMPUTER HARDWARE AND SOFTWARE, NAMELY, FIREWALLS, NETWORK ACCESS SERVER HARDWARE FOR CREATING AND MAINTAINING FIREWALLS, VIRTUAL PRIVATE NETWORK (VPN) COMPUTER HARDWARE AND COMPUTER SERVER OPERATING SOFTWARE FOR CREATING AND MAINTAINING FIREWALLS, SOFTWARE FOR ENSURING THE SECURITY OF COMPUTER NETWORKS, SOFTWARE FOR ACCESS CONTROL AND SECURITY, COMPUTER HARDWARE AND SOFTWARE FOR USE IN PROTECTING COMPUTER NETWORKS FROM DATA THEFT OR DAMAGE BY UNAUTHORIZED USERS; COMPONENTS FOR COMPUTERS AND PRINTED CIRCUITS, NAMELY, INTEGRATED CIRCUIT BOARDS, PRINTED CIRCUIT BOARDS AND ELECTRICAL CIRCUIT BOARDS; COMPUTER VOICE ACCELERATOR BOARDS; COMPUTER VOICE, DATA, IMAGE AND VIDEO ACCELERATOR BOARDS; FLASH MEMORY BOARDS AND FLASH MEMORY CARDS; MEMORY SYSTEMS FOR COMPUTERS PRIMARILY COMPRISED OF COMPUTER HARD DRIVES, BACK-UP DRIVES, DC AND DVD DRIVES, FLOPPY DISK DRIVES, MAGNETIC TAPE DRIVES, OPTICAL DISK DRIVES, AND MEMORY CARDS; TELECOMMUNICATIONS EQUIPMENT AND COMPUTER NETWORKS, NAMELY, PROCESSING AND OPERATING SYSTEMS; HEADSETS; COMPUTER MICE; MICROPHONES; CABLES AND ADAPTERS; COMPUTER TERMINALS AND PRINTERS FOR USE THEREWITH; VIDEO DISPLAY UNITS, NAMELY, COMPUTER MONITORS, ELECTRIC LUMINESCENT DISPLAY PANELS, FLAT PANEL DISPLAY SCREENS, LCD DISPLAYS AND LED DISPLAYS; TELECOMMUNICATIONS APPARATUS AND INSTRUMENTS, NAMELY, COMPUTER ROUTERS, HUBS, SERVERS AND SWITCHES; CAMERAS; COMPUTER HARDWARE AND SOFTWARE FOR THE TRANSMISSION AND RECEIPT OF FACSIMILES; COMPUTER HARDWARE AND SOFTWARE FOR THE DEVELOPMENT, MAINTENANCE, AND USE OF LOCAL AND WIDE AREA COMPUTER NETWORKS; COMPUTER HARDWARE AND SOFTWARE FOR THE DEVELOPMENT, MAINTENANCE, AND USE OF INTERACTIVE AUDIO-VIDEO COMPUTER CONFERENCE SYSTEMS; COMPUTER HARDWARE AND SOFTWARE FOR THE RECEIPT, DISPLAY, AND USE OF BROADCAST VIDEO, AUDIO, AND DIGITAL DATA SIGNALS; SET-TOP BOXES, ELECTRONIC CONTROL DEVICES FOR THE INTERFACE AND CONTROL OF COMPUTERS AND GLOBAL COMPUTER AND TELECOMMUNICATIONS NETWORKS WITH TELEVISION AND CABLE BROADCASTS AND EQUIPMENT; COMPUTER PERIPHERAL MEMORY APPARATUS AND DEVICES, NAMELY COMPUTER PERIPHERALS; COMPUTER FIRMWARE, NAMELY, COMPUTER OPERATING SYSTEMS SOFTWARE; FIXED FUNCTION COMPUTER SERVERS; COMPUTER NETWORKING HARDWARE; SEMICONDUCTOR DEVICES; COMPUTER HARDWARE AND SOFTWARE FOR CREATING, FACILITATING, AND MANAGING REMOTE ACCESS TO AND COMMUNICATION WITH LOCAL AREA NETWORKS (LANS), VIRTUAL PRIVATE NETWORKS (VPN), WIDE AREA NETWORKS (WANS) AND GLOBAL COMPUTER NETWORKS; COMPUTER NETWORK INTERFACE CARDS (NIC), ROUTERS, AND ADAPTERS; COMPUTER SOFTWARE AND HARDWARE FOR USE IN PROVIDING MULTIPLE USER ACCESS TO A GLOBAL COMPUTER INFORMATION NETWORK FOR SEARCHING, RETRIEVING, TRANSFERRING, MANIPULATING AND DISSEMINATING A WIDE RANGE OF INFORMATION; COMPUTER SOFTWARE TOOLS FOR THE FACILITATION OF THIRD PARTY SOFTWARE APPLICATIONS; COMPUTER HARDWARE AND SOFTWARE FOR WIRELESS NETWORK COMMUNICATIONS; DOWNLOADABLE ELECTRONIC PUBLICATIONS, NAMELY, NEWSLETTERS, BOOKS, MAGAZINES, JOURNALS, BROCHURES AND WHITE PAPERS IN THE AREA OF ELECTRONICS, SEMICONDUCTORS AND INTE-

CLASS 9—(Continued).

GRATED ELECTRONIC APPARATUS AND DEVICES, COMPUTERS, TELECOMMUNICATIONS, ENTERTAINMENT, TELEPHONY, AND WIRED AND WIRELESS TELECOMMUNICATIONS; PRERECORDED MAGNETIC DATA CARRIERS, ELECTRONIC FLOPPY DISCS AND OPTICAL DISCS FEATURING INSTRUCTIONAL MATERIALS RELATING TO COMPUTERS; COMPUTER HARDWARE AND SOFTWARE USED TO COLLECT, MEASURE, RECORD, PROCESS, TRANSMIT, RECEIVE, REPRODUCE, MODIFY, COMPRESS, DECOMPRESS, BROADCAST, MERGE AND/OR ENHANCE DATA AND INFORMATION RELATED TO THE WELFARE AND WELL BEING OF INDIVIDUAL PATIENTS; STRUCTURAL PARTS AND FITTINGS FOR ALL THE AFORESAID GOODS; MANUALS SOLD AS A UNIT WITH THE AFOREMENTIONED GOODS AND ELECTRONIC PUBLICATIONS IN THE NATURE OF MANUALS FOR THE AFOREMENTIONED GOODS DOWNLOADABLE FROM A GLOBAL COMPUTER NETWORK (U.S. CLS. 21, 23, 26, 36 AND 38).
CAROLYN CATALDO, EXAMINING ATTORNEY

SN 78-779,124. SATMEDIA GMBH, KARLSRUHE, FED REP GERMANY, FILED 12-22-2005.

CLARKE-TECH

THE MARK CONSISTS OF STANDARD CHARACTERS WITHOUT CLAIM TO ANY PARTICULAR FONT, STYLE, SIZE, OR COLOR.

PRIORITY CLAIMED UNDER SEC. 44(D) ON FED REP GERMANY APPLICATION NO. 30541227209, FILED 7-13-2005, REG. NO. 30541227, DATED 8-31-2005, EXPIRES 7-31-2015.

FOR APPARATUS FOR RECORDING, TRANSMISSION OR REPRODUCTION OF SOUND OR IMAGES, NAMELY, AERIAL INSTALLATIONS AND PARTS THEREFORE, FOR SATELLITE TV PROGRAMS, AS WELL AS ELECTRONIC RECEIVING, DECODING, DISTRIBUTING AND RECORDING APPARATUS FOR DIGITAL TV PROGRAMS; ACCESSORIES FOR THE AFORESAID ELECTRONIC APPARATUS, NAMELY, REMOTE CONTROLS AND PLUG-IN CARDS FOR PERSONAL COMPUTERS AND COMPUTER NETWORKS (U.S. CLS. 21, 23, 26, 36 AND 38).

C. DIONNE CLYBURN, EXAMINING ATTORNEY

SN 78-808,839. EARHUGGER, INC., LINDON, UT. FILED 2-7-2006.

POWERPOD

THE MARK CONSISTS OF STANDARD CHARACTERS WITHOUT CLAIM TO ANY PARTICULAR FONT, STYLE, SIZE, OR COLOR.

FOR BATTERY CHARGE DEVICES (U.S. CLS. 21, 23, 26, 36 AND 38).

FIRST USE 4-0-2004; IN COMMERCE 4-0-2004.

MATTHEW MCDOWELL, EXAMINING ATTORNEY

CLASS 9—(Continued).

SN 78-814,243. DRAKA CABLETEQ HOLDINGS USA, INC.,
PALM BEACH GARDENS, FL. FILED 2-14-2006.

BIW

THE MARK CONSISTS OF STANDARD CHARACTERS
WITHOUT CLAIM TO ANY PARTICULAR FONT, STYLE,
SIZE, OR COLOR.

OWNER OF U.S. REG. NO. 1,982,309.
FOR ELECTRICAL CABLES (U.S. CLS. 21, 23, 26, 36
AND 38).

FIRST USE 4-15-1992; IN COMMERCE 4-15-1992.
KATHERINE CHANG, EXAMINING ATTORNEY

SN 78-824,226. SAFETY SYSTEMS CORPORATION, RO-
SELLE, IL. FILED 2-27-2006.

DRIFIRE

THE MARK CONSISTS OF STANDARD CHARACTERS
WITHOUT CLAIM TO ANY PARTICULAR FONT, STYLE,
SIZE, OR COLOR.

FOR SPECIALIZED PROTECTIVE CLOTHING,
NAMESLY, HIGH PERFORMANCE, FIRE RETARDANT
AND MOISTURE WICKING CLOTHING FOR USE
PRIMARILY BY LAW ENFORCEMENT AGENCIES,
MILITARIES, AND FIRE PROTECTION AND INDUS-
TRIAL PERSONNEL (U.S. CLS. 21, 23, 26, 36 AND 38).

FIRST USE 3-2-2006; IN COMMERCE 3-2-2006.
CARYN GLASSER, EXAMINING ATTORNEY

SN 78-849,375. DEMAGOGUEDVD.COM, LLC, SACRAMEN-
TO, CA. FILED 3-29-2006.

DEMAGOGUE

THE MARK CONSISTS OF STANDARD CHARACTERS
WITHOUT CLAIM TO ANY PARTICULAR FONT, STYLE,
SIZE, OR COLOR.

FOR PRERECORDED DVDS, LASER DISCS, CD
ROMS, COMPACT DISCS, VIDEO CASSETTES, VIDEO
TAPES, AND MOTION PICTURE FILMS IN THE FIELD
OF ADULT ENTERTAINMENT; COMPUTER SOFT-
WARE FOR DATABASE MANAGEMENT; MULTIME-
DIA SOFTWARE FEATURING DATABASES
CONTAINING ENTERTAINMENT-RELATED CON-
TENT; MULTIMEDIA SOFTWARE FOR PLAYING
GAMES (U.S. CLS. 21, 23, 26, 36 AND 38).

MICHAEL KEATING, EXAMINING ATTORNEY

CLASS 9—(Continued).

SN 78-866,627. TELEX COMMUNICATIONS (UK) LIMITED,
WORCESTERSHIRE, UNITED KINGDOM, FILED 4-21-
2006.

MUSCLE MEMORY

THE MARK CONSISTS OF STANDARD CHARACTERS
WITHOUT CLAIM TO ANY PARTICULAR FONT, STYLE,
SIZE, OR COLOR.

PRIORITY CLAIMED UNDER SEC. 44(D) ON UNITED
KINGDOM APPLICATION NO. 2416931, FILED 3-17-2006,
REG. NO. 2416931, DATED 3-17-2006, EXPIRES 3-17-2016.

NO CLAIM IS MADE TO THE EXCLUSIVE RIGHT TO
USE "MEMORY", APART FROM THE MARK AS SHOWN.

FOR APPARATUS AND INSTRUMENTS FOR RE-
CORDING, REPRODUCING, PROCESSING, MEASUR-
ING, AND MIXING OF SOUNDS; AND PARTS AND
FITTINGS FOR THE AFORESAID GOODS (U.S. CLS. 21,
23, 26, 36 AND 38).

TRACY WHITTAKER-BROWN, EXAMINING ATTOR-
NEY

SN 78-871,168. BRAN + LUEBBE GMBH, NORDERSTEDT,
FED REP GERMANY, FILED 4-27-2006.

POWERMON

THE MARK CONSISTS OF STANDARD CHARACTERS
WITHOUT CLAIM TO ANY PARTICULAR FONT, STYLE,
SIZE, OR COLOR.

FOR MICROPROCESSOR CONTROLLED ON-LINE
FLUID ANALYZERS (U.S. CLS. 21, 23, 26, 36 AND 38).

SHAILA SETTLES, EXAMINING ATTORNEY

SN 78-878,738. WU, HSINHAN, KENMORE, WA. FILED 5-8-
2006.

Cord Charmer

FOR ELECTRICAL OUTLET PLATES; VOLTAGE
SURGE PROTECTORS (U.S. CLS. 21, 23, 26, 36 AND 38).

INGA ERVIN, EXAMINING ATTORNEY

CLASS 9—(Continued).

SN 78-880,516. EARTHSEARCH COMMUNICATIONS, INC., MARIETTA, GA. FILED 5-10-2006.

The Power To Find

THE MARK CONSISTS OF STANDARD CHARACTERS WITHOUT CLAIM TO ANY PARTICULAR FONT, STYLE, SIZE, OR COLOR.

FOR COMPUTER SOFTWARE AND HARDWARE DEVICES IN THE NATURE OF MOVEMENT SENSORS, ELECTRIC NAVIGATIONAL INSTRUMENTS, NAMELY, ELECTRONIC NAVIGATIONAL SYSTEMS, NAMELY A GLOBAL POSITIONING SYSTEM (GPS) PROVIDING MOTOR VEHICLE LOCATION, FOR PROVIDING MOTOR VEHICLE FLEET MANAGEMENT DATA REPORTING; COMPUTER SOFTWARE AND HARDWARE DEVICES FOR MOTOR VEHICLE THEFT PREVENTION, NAMELY, MOVEMENT SENSORS, REMOTE CONTROLS, USED FOR DOOR LOCKING/UNLOCKING AND REMOTE CONTROLS USED FOR DISABLING OF MOTOR VEHICLES; ELECTRIC NAVIGATIONAL INSTRUMENTS, NAMELY, ELECTRONIC SATELLITE NAVIGATIONAL SYSTEMS, NAMELY A GLOBAL POSITIONING SYSTEM (GPS) PROVIDING DRIVING DIRECTIONS AND MOTOR VEHICLE LOCATION; AND COMPUTER SOFTWARE AND HARDWARE DEVICES IN THE NATURE OF MOVEMENT SENSORS AND REMOTE VEHICLE OPERATING SENSORS FOR MOTOR VEHICLE SPEED MONITORING (U.S. CLS. 21, 23, 26, 36 AND 38).

MICHAEL LEWIS, EXAMINING ATTORNEY

SN 78-881,695. ALION-MA&D CORPORATION, BOULDER, CO. FILED 5-11-2006.

Total Crew Model

THE MARK CONSISTS OF STANDARD CHARACTERS WITHOUT CLAIM TO ANY PARTICULAR FONT, STYLE, SIZE, OR COLOR.

NO CLAIM IS MADE TO THE EXCLUSIVE RIGHT TO USE "MODEL", APART FROM THE MARK AS SHOWN. SEC. 2(F).

FOR COMPUTER SOFTWARE FEATURING DYNAMIC SIMULATION ARCHITECTURE WHICH CAPTURES FATIGUE DEGRADATION BASED ON SLEEP/WORK SCHEDULES AND CIRCADIAN CYCLES AT A MACRO-LEVEL OVER A COURSE OF TIME (U.S. CLS. 21, 23, 26, 36 AND 38).

FIRST USE 12-0-2000; IN COMMERCE 12-0-2000.
FRED MANDIR, EXAMINING ATTORNEY

CLASS 9—(Continued).

SN 78-883,832. MOIXA ENERGY HOLDINGS LTD., LONDON, UNITED KINGDOM, FILED 5-15-2006.

SWAP AND PLAY

THE MARK CONSISTS OF STANDARD CHARACTERS WITHOUT CLAIM TO ANY PARTICULAR FONT, STYLE, SIZE, OR COLOR.

OWNER OF UNITED KINGDOM REG. NO. 2409712, DATED 8-11-2006, EXPIRES 12-21-2015.

FOR ELECTRICAL POWER SOURCES, NAMELY, ELECTROCHEMICAL CELLS, BATTERIES, RECHARGEABLE BATTERIES, AND RECHARGEABLE BATTERY PACKS (U.S. CLS. 21, 23, 26, 36 AND 38).

AMEETA JORDAN, EXAMINING ATTORNEY

SN 78-894,144. THE CHAMBERLAIN GROUP, INC., ELMHURST, IL. FILED 5-26-2006.

ELITE

THE MARK CONSISTS OF STANDARD CHARACTERS WITHOUT CLAIM TO ANY PARTICULAR FONT, STYLE, SIZE, OR COLOR.

OWNER OF U.S. REG. NOS. 2,002,705 AND 2,982,065.

SEC. 2(F).

FOR REMOTE CONTROL SYSTEMS AND COMPONENTS THEREOF NOT FOR COMMUNICATIONS PURPOSES—NAMELY—RADIO CONTROLS FOR GARAGE AND WAREHOUSE ENTRANCE DOORS OR GATES; AUTOMATIC GARAGE DOOR OPENERS, LIGHTS, MOTORS, ANTENNAS, TRANSMITTERS, RECEIVERS AND CONTROLLERS RESPONDING THERETO AND USED IN SUCH SYSTEMS; ELECTRICAL SAFETY EQUIPMENT, NAMELY, AN ELECTRIC EYE FOR SENSING OBSTRUCTIONS AND CONTROLLING DOORS; ELECTRONIC SECURITY DEVICES, NAMELY, ELECTRONIC CONTROLS FOR GRANTING ACCESS AND EGRESS THROUGH DOORS OR GATES; RADIO RECEIVERS, RADIO TRANSMITTERS, KEYPADS AND CARD READERS; A CENTRALIZED AUTOMATED SYSTEM COMPRISING A PROGRAMMABLE ELECTRICAL CONTROLLER, POWER LINE CARRIER MODULES, AND ONE OR MORE CONTROL MODULES OR CONTROL RECEPTACLES, FOR CONTROLLING AUDIO EQUIPMENT, LIGHTING, AND OTHER APPLIANCES IN A RESIDENCE; ACCESS CONTROL SYSTEMS COMPRISING SPEAKERS, MICROPHONES, MEMORIES FOR STORING TELEPHONE NUMBERS AND CORRESPONDING CODE NUMBERS, ELECTRIC LUMINESCENT DISPLAY PANELS AND LIQUID CRYSTAL DISPLAY PANELS, KEYPADS, AUTODIALERS, GATE/LOCK CONTROL CIRCUITRY AND VANDAL RESISTANT HOUSINGS, FOR ESTABLISHING COMMUNICATION BETWEEN PERSONS IN A SECURED LOCATION AND PERSONS DESIRING TO ENTER THE SECURED LOCATION THROUGH A LOCKED GATE OR DOOR (U.S. CLS. 21, 23, 26, 36 AND 38).

CORY BOONE, EXAMINING ATTORNEY

CLASS 9—(Continued).

SN 78-898,994. NORSK HYDRO ASA, OSLO, NORWAY,
FILED 6-2-2006.

HYDRO

THE MARK CONSISTS OF STANDARD CHARACTERS
WITHOUT CLAIM TO ANY PARTICULAR FONT, STYLE,
SIZE, OR COLOR.

OWNER OF NORWAY REG. NO. 227582, DATED 8-3-2005,
EXPIRES 8-3-2015.
FOR ELECTROLYSERS (U.S. CLS. 21, 23, 26, 36 AND
38).

CHARLOTTE CORWIN, EXAMINING ATTORNEY

SN 78-899,033. NORSK HYDRO ASA, OSLO, NORWAY,
FILED 6-2-2006.

NORSK HYDRO

THE MARK CONSISTS OF STANDARD CHARACTERS
WITHOUT CLAIM TO ANY PARTICULAR FONT, STYLE,
SIZE, OR COLOR.

OWNER OF NORWAY REG. NO. 226782, DATED 5-26-
2005, EXPIRES 5-26-2015.

NO CLAIM IS MADE TO THE EXCLUSIVE RIGHT TO
USE "NORSK", APART FROM THE MARK AS SHOWN.

THE FOREIGN WORDING IN THE MARK TRANSLATES
INTO ENGLISH AS NORWEGIAN.

FOR ELECTROLYSERS (U.S. CLS. 21, 23, 26, 36 AND
38).

CHARLOTTE CORWIN, EXAMINING ATTORNEY

SN 78-912,728. TANGLE, INC., SOUTH SAN FRANCISCO,
CA. FILED 6-20-2006.

AUDIO FORMS

THE MARK CONSISTS OF STANDARD CHARACTERS
WITHOUT CLAIM TO ANY PARTICULAR FONT, STYLE,
SIZE, OR COLOR.

NO CLAIM IS MADE TO THE EXCLUSIVE RIGHT TO
USE "AUDIO", APART FROM THE MARK AS SHOWN.

FOR AUDIO SPEAKER ENCLOSURES, NAMELY,
MOVABLE SCULPTURE USED TO HOLD AUDIO
SPEAKERS (U.S. CLS. 21, 23, 26, 36 AND 38).

KENNETH E. SHARPERSON, EXAMINING ATTORNEY

CLASS 9—(Continued).

SN 78-933,090. QI SYSTEMS, INC., COLLEYVILLE, VT.
FILED 7-19-2006.

QiWAVE

THE MARK CONSISTS OF STANDARD CHARACTERS
WITHOUT CLAIM TO ANY PARTICULAR FONT, STYLE,
SIZE, OR COLOR.

FOR ACCESS CONTROL AND ALARM MONITORING
SYSTEMS; BLANK SMART CARDS; CARD READERS
FOR CREDIT CARDS; CARD READING EQUIPMENT;
CARDS WITH INTEGRATED CIRCUITS; CHIP CARD
READERS; ELECTRONIC AND MAGNETIC ID CARDS
FOR USE IN CONNECTION WITH PAYMENT FOR
SERVICES; ELECTRONIC CARD READERS; ELECTRO-
NIC PAYMENT TERMINAL; ELECTRONIC TERMINAL
FOR AN ELECTRONIC LOTTERY SYSTEM WHICH
GENERATES LOTTERY TICKETS; ENCODED ELEC-
TRONIC CHIP CARDS CONTAINING PROGRAMMING
USED TO CONTROL VENDING PAYMENTS; ENCODED
ELECTRONIC CHIP CARDS FOR LAUNDRY PAY-
MENT; ENCODED INTEGRATED CIRCUIT CARDS
CONTAINING PROGRAMMING USED TO CONTROL
PARKING PAYMENT; ENCODED SMART CARDS CON-
TAINING PROGRAMMING USED TO CONTROL
PHOTOCOPIING PAYMENT; MEMORY CARDS; MI-
CROCHIP CARDS; OPERATING SYSTEM PROGRAMS
(U.S. CLS. 21, 23, 26, 36 AND 38).

FIRST USE 6-15-2006; IN COMMERCE 7-6-2006.

KATHERINE CHANG, EXAMINING ATTORNEY

SN 78-935,992. ACCU-TIME SYSTEMS, INC., ELLINGTON,
CT. FILED 7-24-2006.

CYBER

THE MARK CONSISTS OF STANDARD CHARACTERS
WITHOUT CLAIM TO ANY PARTICULAR FONT, STYLE,
SIZE, OR COLOR.

FOR SECURE TERMINALS FOR ELECTRONIC
TRANSACTIONS IN THE NATURE OF DATA COLLEC-
TION TERMINALS AND ASSOCIATED SOFTWARE FOR
TRACKING TIME AND ATTENDANCE AND HUMAN
RESOURCES APPLICATIONS (U.S. CLS. 21, 23, 26, 36
AND 38).

FIRST USE 4-30-2002; IN COMMERCE 6-24-2002.

LYDIA BELZER, EXAMINING ATTORNEY

CLASS 9—(Continued).

SN 78-937,017. MEDIUM, INC., BOULDER, CO. FILED 7-25-2006.

MEDIUM

THE MARK CONSISTS OF STANDARD CHARACTERS WITHOUT CLAIM TO ANY PARTICULAR FONT, STYLE, SIZE, OR COLOR.

FOR DOWNLOADABLE COMPUTER SOFTWARE THAT IS USED TO CREATE AN INTERACTIVE ONLINE COMMUNITY WHICH ALLOWS USERS TO INTERACT WITH, SHARE THEIR ONLINE BROWSING ACTIVITY WITH, AND BUILD RELATIONSHIPS WITH, OTHER USERS (U.S. CLS. 21, 23, 26, 36 AND 38).

FIRST USE 9-30-2005; IN COMMERCE 5-25-2006.
ELIZABETH KAJUBI, EXAMINING ATTORNEY

SN 78-939,016. 100% PRODUCTIONS, INC., WESTLAKE VILLAGE, CA. FILED 7-27-2006.

**KEEP ● THE
FAITH
SECOND CHANCES**

FOR MUSICAL SOUND RECORDINGS AND MUSICAL VIDEO RECORDINGS FEATURING PROTESTANT CHRISTIAN GOSPEL MUSIC AND ENTERTAINMENT (U.S. CLS. 21, 23, 26, 36 AND 38).

DAWN FELDMAN, EXAMINING ATTORNEY

CLASS 9—(Continued).

SN 78-944,677. 1800 BLK ENTERTAINMENT, LLC, LOS ANGELES, CA. FILED 8-3-2006.

LBG

THE MARK CONSISTS OF STANDARD CHARACTERS WITHOUT CLAIM TO ANY PARTICULAR FONT, STYLE, SIZE, OR COLOR.

THE NAME, "LBG", SHOWN IN THE MARK IDENTIFIES BOBBY WASHINGTON, WHOSE CONSENT(S) TO REGISTER IS OF RECORD.

FOR MUSICAL SOUND RECORDINGS; AUDIO-VISUAL RECORDINGS, NAMELY, COMPACT DISCS, TAPE CASSETTES, RECORDS, CD-ROMS, VHS VIDEO TAPES, DVDS, AND LASER DISCS ALL FEATURING MUSIC, SPORTS, TELEVISION PROGRAMS AND MOVIES; VIDEO GAME SOFTWARE; VIDEO GAME COMPUTER SOFTWARE ADAPTED FOR USE WITH TELEVISION RECEIVERS AND COMPUTERS; DOWNLOADABLE TEXT, VIDEO RECORDINGS, AUDIO RECORDINGS AND STILL IMAGES FEATURING MUSIC, SPORTS, TELEVISION PROGRAMS AND MOVIES VIA WIRELESS DEVICES, NAMELY, CELL PHONES, PERSONAL DIGITAL ASSISTANTS AND PORTABLE ENTERTAINMENT AND GAMING DEVICES; DOWNLOADABLE MUSIC, POLYPHONIC AND MASTER RING TONES, VOICE TONES, VOICE MESSAGES, RING BACKS AND INTERACTIVE GAMES VIA WIRELESS DEVICES, NAMELY, CELL PHONES, PERSONAL DIGITAL ASSISTANTS AND PORTABLE ENTERTAINMENT AND GAMING DEVICES (U.S. CLS. 21, 23, 26, 36 AND 38).

JAY BESCH, EXAMINING ATTORNEY

SN 78-949,525. PERFORMANCE RESULTS INC., LAYTONSVILLE, MD. FILED 8-10-2006.

Results ONLINE

THE MARK CONSISTS OF STANDARD CHARACTERS WITHOUT CLAIM TO ANY PARTICULAR FONT, STYLE, SIZE, OR COLOR.

NO CLAIM IS MADE TO THE EXCLUSIVE RIGHT TO USE "ONLINE", APART FROM THE MARK AS SHOWN.

FOR COMPUTER SOFTWARE FOR APPLICATION AND DATABASE INTEGRATION (U.S. CLS. 21, 23, 26, 36 AND 38).

ROBERT LAVACHE, EXAMINING ATTORNEY

CLASS 9—(Continued).

SN 78-953,547. QUANTUM DATA, INC., ELGIN, IL. FILED 8-16-2006.



quantumdata

OWNER OF U.S. REG. NO. 2,400,601.
THE MARK CONSISTS OF STYLIZED Q ON TOP OF THE WORDS QUANTUM DATA.
FOR CHARACTER GENERATORS, NAMELY, COLOR AND PROGRAMMABLE CHARACTER GENERATORS FOR TESTING CRT DISPLAYS; COMPUTERIZED ALIGNMENT AND ADJUSTMENT TOOLS, NAMELY, COMPUTERIZED TOOLS FOR ALIGNING AND ADJUSTING POTENTIOMETERS, TRIMMER CAPACITORS, AND TUNABLE COILS IN POWER SUPPLIES FOR VARIOUS ELECTRONIC PRODUCTS (U.S. CLS. 21, 23, 26, 36 AND 38).
FIRST USE 3-31-2005; IN COMMERCE 3-31-2005.
JAMES A. RAUEN, EXAMINING ATTORNEY

SN 78-953,673. LILLIPUTIAN SYSTEMS, INC., WILMINGTON, MA. FILED 8-16-2006.

LILLIPUTIAN

THE MARK CONSISTS OF STANDARD CHARACTERS WITHOUT CLAIM TO ANY PARTICULAR FONT, STYLE, SIZE, OR COLOR.
FOR BATTERIES; FUEL CELLS; MEMBRANE ELECTRODE ASSEMBLIES, COMMONLY KNOWN AS MEAS, COMPRISED OF ELECTROLYTE FILM AND ELECTRODES FOR THE GENERATION OF ELECTRIC POWER; ELECTRODES; POWER CELLS (U.S. CLS. 21, 23, 26, 36 AND 38).
JANICE L. MCMORROW, EXAMINING ATTORNEY

CLASS 9—(Continued).

SN 78-953,899. CALYPSO MEDICAL TECHNOLOGIES, INC., SEATTLE, WA. FILED 8-16-2006.

BEACON WITHIN

THE MARK CONSISTS OF STANDARD CHARACTERS WITHOUT CLAIM TO ANY PARTICULAR FONT, STYLE, SIZE, OR COLOR.
OWNER OF U.S. REG. NOS. 3,036,088 AND 3,036,089.
FOR COMPUTER SOFTWARE AND HARDWARE FOR MEDICAL IMAGING, DIAGNOSTICS, VISUALIZATION, TREATMENT AND THERAPY; COMPUTER SOFTWARE AND HARDWARE FOR USE IN CONNECTION WITH IMPLANTABLE TRANSPONDERS IN THE FIELDS OF MEDICAL IMAGING, DIAGNOSTICS, VISUALIZATION, TREATMENT AND THERAPY; COMPUTER SOFTWARE AND HARDWARE FOR THE ACQUISITION, PROCESSING, TRANSFERRING, TRANSMITTING, AND ANALYZING OF LABORATORY, ANATOMIC, PHYSIOLOGICAL AND CLINICAL DATA FROM AND ABOUT THE HUMAN OR ANIMAL BODY (U.S. CLS. 21, 23, 26, 36 AND 38).
BONNIE LUKEN, EXAMINING ATTORNEY

SN 78-953,910. CALYPSO MEDICAL TECHNOLOGIES, INC., SEATTLE, WA. FILED 8-16-2006.

NOTHING TRACKS LIKE A
BEACON

THE MARK CONSISTS OF STANDARD CHARACTERS WITHOUT CLAIM TO ANY PARTICULAR FONT, STYLE, SIZE, OR COLOR.
OWNER OF U.S. REG. NOS. 3,036,088 AND 3,036,089.
FOR COMPUTER SOFTWARE AND HARDWARE FOR MEDICAL IMAGING, DIAGNOSTICS, VISUALIZATION, TREATMENT AND THERAPY; COMPUTER SOFTWARE AND HARDWARE FOR USE IN CONNECTION WITH IMPLANTABLE TRANSPONDERS IN THE FIELDS OF MEDICAL IMAGING, DIAGNOSTICS, VISUALIZATION, TREATMENT AND THERAPY; COMPUTER SOFTWARE AND HARDWARE FOR THE ACQUISITION, PROCESSING, TRANSFERRING, TRANSMITTING, AND ANALYZING OF LABORATORY, ANATOMIC, PHYSIOLOGICAL AND CLINICAL DATA FROM AND ABOUT THE HUMAN OR ANIMAL BODY (U.S. CLS. 21, 23, 26, 36 AND 38).
BONNIE LUKEN, EXAMINING ATTORNEY

CLASS 9—(Continued).

SN 78-955,736. SANRIO COMPANY, LTD., TOKYO, JAPAN,
FILED 8-18-2006.

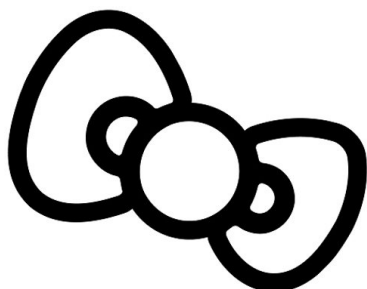

OWNER OF U.S. REG. NOS. 1,200,083, 1,370,105 AND
OTHERS.

THE MARK CONSISTS OF A BOW.

FOR RADIOS, RADIOS INCORPORATING CLOCKS,
BOOM BOXES, COMPACT DISC PLAYERS, AUDIO
CASSETTE PLAYERS, DVD PLAYERS, RADIOS INCOR-
PORATING CD PLAYER, TELEVISIONS, DIGITAL
CAMERAS, VIDEO CAMERAS, VIDEO CASSETTE RE-
CORDERS, ELECTRONIC CALCULATORS, TELE-
PHONES, CHARMS FOR WIRELESS TELEPHONES
AND PAGERS, COMPACT DISC CASES; BAGS, COVER-
INGS, CONTAINERS, CARRYING CASES AND
HOLDERS FOR WIRELESS TELEPHONES, BEEPERS
AND RADIO PAGERS; HEADPHONES, SUNGLASSES,
EYEGGLASS CASES, CONTACT LENS CASES, DECORA-
TIVE SWITCH PLATE COVERS, DECORATIVE MAG-
NETS, ELECTRIC HAIR CURLERS, ELECTRIC HAIR
CRIMPERS; CD CASES FOR USE IN VEHICLES; CELL
PHONE HOLDERS FOR VEHICLES (U.S. CLS. 21, 23, 26,
36 AND 38).

FIRST USE 9-1-2004; IN COMMERCE 9-1-2004.

REGINA DRUMMOND, EXAMINING ATTORNEY

SN 78-956,069. KRJA SYSTEMS, INC., LAKEWOOD, CO.
FILED 8-20-2006.

I-SITE

THE MARK CONSISTS OF STANDARD CHARACTERS
WITHOUT CLAIM TO ANY PARTICULAR FONT, STYLE,
SIZE, OR COLOR.

FOR LASER SCANNING AND IMAGING SYSTEMS
COMPRISING LASER SCANNERS, CAMERAS, ALIGN-
MENT TELESCOPES, TILT COMPENSATORS, AND
DATA AND COMPUTER INTERFACES (U.S. CLS. 21,
23, 26, 36 AND 38).

FIRST USE 7-0-1999; IN COMMERCE 7-0-1999.

ALLISON HOLTZ, EXAMINING ATTORNEY

CLASS 9—(Continued).

SN 78-956,300. OVERWATCH SYSTEMS, LLC, STERLING,
VA. FILED 8-21-2006.

RV SCREENER

THE MARK CONSISTS OF STANDARD CHARACTERS
WITHOUT CLAIM TO ANY PARTICULAR FONT, STYLE,
SIZE, OR COLOR.

NO CLAIM IS MADE TO THE EXCLUSIVE RIGHT TO
USE "SCREENER", APART FROM THE MARK AS SHOWN.

FOR COMPUTER SOFTWARE FOR IMAGE AND
VIDEO GATHERING, PROCESSING, ANALYSIS AND
DISSEMINATION; COMPUTER SOFTWARE FOR IN-
TELLIGENCE GATHERING, PROCESSING, ANALYSIS
AND DISSEMINATION (U.S. CLS. 21, 23, 26, 36 AND 38).

CAROLINE WOOD, EXAMINING ATTORNEY

SN 78-957,363. SURE ID LLC, MULICA HILL, NJ. FILED 8-
22-2006.

PHARMASURE

THE MARK CONSISTS OF STANDARD CHARACTERS
WITHOUT CLAIM TO ANY PARTICULAR FONT, STYLE,
SIZE, OR COLOR.

FOR COMPUTER CONTROLLED SYSTEM FOR
AUTHENTICATING AND VERIFYING THAT THE
PROPER MEDICATION IS GIVEN TO THE PROPER
PERSON COMPRISED OF PLASTIC MEDICATION CON-
TAINERS, RADIO FREQUENCY IDENTIFICATION TAG
READERS AND SOFTWARE FOR READING AND
INTERPRETING THE TAGS, LOGGING THE TIME
AND LOGGING PATIENT AND MEDICATION INFOR-
MATION THAT IS INTERCONNECTED TO THIRD
PARTY COMPUTER SYSTEMS VIA A TELECOMMUNI-
CATIONS NETWORK (U.S. CLS. 21, 23, 26, 36 AND 38).

SETH A. RAPPAPORT, EXAMINING ATTORNEY

CLASS 9—(Continued).

SN 78-957,602. SEIKO EPSON KABUSHIKI KAISHA, TA SEIKO EPSON CORPORATION, TOKYO, JAPAN, FILED 8-22-2006.

PHOTOSENA

THE MARK CONSISTS OF STANDARD CHARACTERS WITHOUT CLAIM TO ANY PARTICULAR FONT, STYLE, SIZE, OR COLOR.

PRIORITY CLAIMED UNDER SEC. 44(D) ON JAPAN APPLICATION NO. 2006-065907, FILED 7-14-2006, REG. NO. 5037758, DATED 3-30-2007, EXPIRES 3-30-2017.

FOR SOFTWARE INSTALLED IN OR EQUIPPED WITH COMPUTER PRINTERS, WHICH AUTOMATICALLY EXTRACT OR CORRECT DATA IN PHOTOGRAPHS FOR PRINTING; SOFTWARE INSTALLED IN OR EQUIPPED WITH INKJET PRINTERS, WHICH AUTOMATICALLY EXTRACT OR CORRECT DATA IN PHOTOGRAPHS FOR PRINTING; SOFTWARE INSTALLED IN OR EQUIPPED WITH MULTI-FUNCTION DIGITAL PRINTERS INCORPORATING COPYING AND/OR SCANNING AND/OR FAXING CAPABILITIES, WHICH AUTOMATICALLY EXTRACT OR CORRECT DATA IN PHOTOGRAPHS FOR PRINTING; INK JET PRINTERS, COMPUTER PRINTERS, MULTI-FUNCTION DIGITAL PRINTERS INCORPORATING COPYING AND/OR SCANNING AND/OR FAXING CAPABILITIES (U.S. CLS. 21, 23, 26, 36 AND 38).

CYNTHIA SLOAN, EXAMINING ATTORNEY

CLASS 9—(Continued).

SN 78-960,948. A P PRODUCTS GMBH, WEIL IM SCHOENBUCH, FED REP GERMANY, FILED 8-25-2006.

A P PRODUCTS

THE MARK CONSISTS OF STANDARD CHARACTERS WITHOUT CLAIM TO ANY PARTICULAR FONT, STYLE, SIZE, OR COLOR.

NO CLAIM IS MADE TO THE EXCLUSIVE RIGHT TO USE "PRODUCTS", APART FROM THE MARK AS SHOWN.

FOR ELECTRICAL CONNECTORS, ELECTRICAL CABLES, ELECTRICAL CABLE ASSEMBLIES, ELECTRICAL SWITCHES, CIRCUIT BOARDS, TEST CLIP CONNECTORS FOR TESTING OF ELECTRICAL CIRCUITS AND COMPONENTS, ELECTRICAL CONNECTORS, NAMELY, ELECTRICAL HEADERS FOR ELECTRICAL AND ELECTRONIC CIRCUITS, ELECTRICAL JUMPER CONNECTORS, ELECTRICAL POLARITY TAB KEYS TO FACILITATE CORRECT ALIGNMENT OF MALE AND FEMALE CONNECTORS, SOLDERLESS BREADBOARD CIRCUIT BUILDING COMPONENTS, NAMELY, ELECTRICAL TERMINALS, CONNECTORS, WIRES AND ELECTRICAL POWER SUPPLIES, ELECTRICAL TERMINALS, ELECTRICAL BREADBOARD UNITS, ELECTRICAL SIGNAL TRANSMITTERS, ELECTRICAL PATCH CORDS AND TELECOMMUNICATION PATCH CORDS (U.S. CLS. 21, 23, 26, 36 AND 38).

ANGELA GAW, EXAMINING ATTORNEY

SN 78-960,677. OCTILOCK, INC., LANSDALE, PA. FILED 8-25-2006.



NO CLAIM IS MADE TO THE EXCLUSIVE RIGHT TO USE "SYSTEMS", APART FROM THE MARK AS SHOWN.

FOR ELECTRONIC LOCKS (U.S. CLS. 21, 23, 26, 36 AND 38).

SCOTT SISUN, EXAMINING ATTORNEY

SN 78-965,003. PALMER, DONALD E., ST. HELENA, CA. FILED 8-31-2006.

HIGHWIRE

THE MARK CONSISTS OF STANDARD CHARACTERS WITHOUT CLAIM TO ANY PARTICULAR FONT, STYLE, SIZE, OR COLOR.

FOR ELECTROMAGNETIC ENERGY SUPPRESSION DEVICES AND ELECTRICAL CABLES, NAMELY, SHIELDED AND UNSHIELDED AUDIO, VIDEO, COMPUTER, RADIO FREQUENCY AND POWER LINE CABLES, AND ELECTROMAGNETIC ENERGY SUPPRESSION DEVICES FOR AUDIO, VIDEO, COMPUTER, RADIO FREQUENCY AND POWER LINE CABLES (U.S. CLS. 21, 23, 26, 36 AND 38).

FIRST USE 10-13-1991; IN COMMERCE 6-20-1992.

KAREN SEVERSON, EXAMINING ATTORNEY

CLASS 9—(Continued).

SN 78-965,004. WILLIS, WILLIAM MICHAEL, DBA OCEAN EAST PUBLISHING, VERO BEACH, FL. FILED 8-31-2006.

SEARCH LIGHT

THE MARK CONSISTS OF STANDARD CHARACTERS WITHOUT CLAIM TO ANY PARTICULAR FONT, STYLE, SIZE, OR COLOR.

FOR COMPUTER SOFTWARE FOR EDUCATING CHILDREN AND ADOLESCENTS IN SOCIAL ISSUES, CHARACTER BUILDING, AND FAITH FORMATION (U.S. CLS. 21, 23, 26, 36 AND 38).

KAREN SEVERSON, EXAMINING ATTORNEY

SN 78-968,989. TRINTECH TECHNOLOGIES LIMITED, DUBLIN 18, IRELAND, FILED 9-7-2006.

TRINTECH

THE MARK CONSISTS OF STANDARD CHARACTERS WITHOUT CLAIM TO ANY PARTICULAR FONT, STYLE, SIZE, OR COLOR.

OWNER OF U.S. REG. NOS. 1,873,115, 2,539,140 AND 2,645,007.

FOR FINANCIAL ACCOUNTING SOFTWARE FOR FINANCIAL GOVERNANCE, ACCOUNT TRANSACTION VERIFICATION AND ACCOUNT RECONCILIATION, GENERAL LEDGER RECONCILIATION AND CERTIFICATION, CASH MANAGEMENT, TREASURY MANAGEMENT, AND BANK FEE ANALYSIS; COMPUTER SOFTWARE FOR FACILITATING CORPORATE COMPLIANCE WITH STATUTORY REGULATIONS (U.S. CLS. 21, 23, 26, 36 AND 38).

BENJAMIN ALLEN, EXAMINING ATTORNEY

SN 78-969,103. 80/20 INC., COLUMBIA CITY, IN. FILED 9-7-2006.



NO CLAIM IS MADE TO THE EXCLUSIVE RIGHT TO USE "AUTO QUOTER", APART FROM THE MARK AS SHOWN.

FOR COMPUTER SOFTWARE FOR DESIGNING 3 DIMENSIONAL FRAMING SYSTEMS AND THEIR RELATED APPLICATIONS (U.S. CLS. 21, 23, 26, 36 AND 38).

FIRST USE 5-24-2004; IN COMMERCE 7-2-2004.
ROBERT LAVACHE, EXAMINING ATTORNEY

CLASS 9—(Continued).

SN 78-969,416. JEFFRY PADIN, EL SEGUNDO, CA. FILED 9-7-2006.

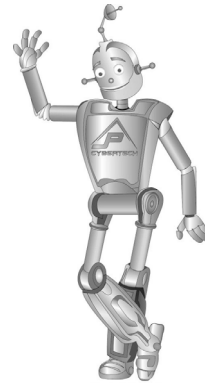

THE MARK CONSISTS OF A ROBOT WITH A DESIGN ON HIS TORSO COMPRISED OF A CHEVRON ABOVE THE LETTERS JP, WITH THE TERM CYBERTECH APPEARING BELOW THE LETTERS JP. THE MARK IS NOT IN COLOR.

FOR ELECTRONIC COMPUTERS (U.S. CLS. 21, 23, 26, 36 AND 38).

FIRST USE 0-0-2006; IN COMMERCE 0-0-2006.

TONI HICKEY, EXAMINING ATTORNEY

SN 78-969,928. REMEDYMD, INC., SALT LAKE CITY, UT. FILED 9-8-2006.

BariEHR

THE MARK CONSISTS OF STANDARD CHARACTERS WITHOUT CLAIM TO ANY PARTICULAR FONT, STYLE, SIZE, OR COLOR.

FOR COMPUTER SOFTWARE IN THE FIELD OF BARIATRICS FOR MANAGEMENT AND ANALYSIS OF INFORMATION PROVIDED BY PATIENTS, MEDICAL STAFF, PHYSICIANS AND INFORMATION DERIVED FROM OTHER SOFTWARE SYSTEMS AND MEDICAL APPLIANCES, FOR THE MANAGEMENT AND ANALYSIS OF DECISION MAKING PROCESSES AND WORKFLOW IN THE MEDICAL FIELD, AND FOR THE MANAGEMENT AND ANALYSIS OF MEDICAL OUTCOMES BASED ON OF INFORMATION PROVIDED VIA PATIENTS, MEDICAL STAFF, PHYSICIANS (U.S. CLS. 21, 23, 26, 36 AND 38).

TONI HICKEY, EXAMINING ATTORNEY

CLASS 9—(Continued).

SN 78-969,932. REMEDYMD, INC., SALT LAKE CITY, UT. FILED 9-8-2006.

EndoEHR

THE MARK CONSISTS OF STANDARD CHARACTERS WITHOUT CLAIM TO ANY PARTICULAR FONT, STYLE, SIZE, OR COLOR.

FOR COMPUTER SOFTWARE IN THE FIELD OF ENDOCRINOLOGY FOR MANAGEMENT AND ANALYSIS OF INFORMATION PROVIDED BY PATIENTS, MEDICAL STAFF, PHYSICIANS AND INFORMATION DERIVED FROM OTHER SOFTWARE SYSTEMS AND MEDICAL APPLIANCES, FOR MANAGEMENT AND ANALYSIS OF DECISION-MAKING PROCESSES AND WORKFLOW IN THE MEDICAL FIELD, AND FOR MANAGEMENT AND ANALYSIS OF MEDICAL OUTCOMES BASED ON OF INFORMATION PROVIDED VIA PATIENTS, MEDICAL STAFF, PHYSICIANS (U.S. CLS. 21, 23, 26, 36 AND 38).

TONI HICKEY, EXAMINING ATTORNEY

SN 78-971,615. AVENZA SYSTEMS INC., TORONTO, CANADA, FILED 9-11-2006.

AVENZA

THE MARK CONSISTS OF STANDARD CHARACTERS WITHOUT CLAIM TO ANY PARTICULAR FONT, STYLE, SIZE, OR COLOR.

OWNER OF U.S. REG. NO. 3,153,285.
FOR COMPUTER SOFTWARE USED TO DESIGN AND CREATE MAPS (U.S. CLS. 21, 23, 26, 36 AND 38).
FIRST USE 1-1-1995; IN COMMERCE 1-1-1995.
GEORGE LORENZO, EXAMINING ATTORNEY

SN 78-971,843. NEPTIUM, INC., SANTA CLARA, CA. FILED 9-11-2006.

ShipGenie

THE MARK CONSISTS OF STANDARD CHARACTERS WITHOUT CLAIM TO ANY PARTICULAR FONT, STYLE, SIZE, OR COLOR.

FOR COMPUTER E-COMMERCE SOFTWARE TO ALLOW USERS TO PERFORM ELECTRONIC BUSINESS TRANSACTIONS VIA A GLOBAL COMPUTER NETWORK; COMPUTER SOFTWARE FOR APPLICATION INTEGRATION; COMPUTER SOFTWARE FOR TRANSPORTATION AND LOGISTICS MANAGEMENT; GRAPHICAL USER INTERFACE SOFTWARE (U.S. CLS. 21, 23, 26, 36 AND 38).

FIRST USE 2-1-2002; IN COMMERCE 10-24-2003.
ELLEN PERKINS, EXAMINING ATTORNEY

CLASS 9—(Continued).

SN 78-973,659. MONSTER CABLE PRODUCTS, INC., BRISBANE, CA. FILED 9-13-2006.

EINSTEIN

THE MARK CONSISTS OF STANDARD CHARACTERS WITHOUT CLAIM TO ANY PARTICULAR FONT, STYLE, SIZE, OR COLOR.

FOR RESIDENTIAL CONTROL SYSTEM COMPRISING CONTROL PROTOCOL SOFTWARE FEATURING INTEROPERABILITY STANDARDS, COMPUTER HARDWARE, AND CONTROLLERS FOR CENTRALIZED HOME CONTROL, NAMELY, FOR CONTROLLING RESIDENTIAL LIGHTING, TELEPHONE SYSTEMS, HEATING, VENTILATION, AIR CONDITIONING SYSTEMS, AND AUDIO AND VIDEO DEVICES (U.S. CLS. 21, 23, 26, 36 AND 38).

JEFF DEFORD, EXAMINING ATTORNEY

SN 78-974,136. SANDISK CORPORATION, MILPITAS, CA. FILED 9-14-2006.



THE MARK CONSISTS OF STYLIZED LETTERS TF WITHIN A CIRCLE.

FOR FLASH AND NON-FLASH MEMORY CARDS AND COMPATIBLE CONSUMER ELECTRONIC DEVICES, NAMELY, USB DRIVES, MOBILE PHONES, PERSONAL DIGITAL ASSISTANTS, DIGITAL CAMERAS, MP3 PLAYERS; AND SOFTWARE FOR CONTROLLING FUNCTIONS OR FEATURES OF MEMORY CARDS (U.S. CLS. 21, 23, 26, 36 AND 38).

LYDIA BELZER, EXAMINING ATTORNEY

CLASS 9—(Continued).

SN 78-974,274. MATTEL, INC., EL SEGUNDO, CA. FILED 9-14-2006.

TUNE BLOSSOM

THE MARK CONSISTS OF STANDARD CHARACTERS WITHOUT CLAIM TO ANY PARTICULAR FONT, STYLE, SIZE, OR COLOR.

NO CLAIM IS MADE TO THE EXCLUSIVE RIGHT TO USE "TUNE", APART FROM THE MARK AS SHOWN.

FOR ELECTRONICS, NAMELY, PERSONAL CD PLAYERS (U.S. CLS. 21, 23, 26, 36 AND 38).

FIRST USE 7-26-2007; IN COMMERCE 7-26-2007.

CAROLYN CATALDO, EXAMINING ATTORNEY

SN 78-974,589. SUI GENERIS SOLUTIONS, INC., ALPHARETTA, GA. FILED 9-14-2006.

CONTACTPOINT

THE MARK CONSISTS OF STANDARD CHARACTERS WITHOUT CLAIM TO ANY PARTICULAR FONT, STYLE, SIZE, OR COLOR.

FOR COMPUTER SOFTWARE, NAMELY, SOFTWARE USED TO MANAGE AND INTEGRATE WORKFORCE OPERATIONS, NAMELY, FORECASTING WORKFORCE REQUIREMENTS, REAL-TIME DECISION SUPPORT, STAFFING REQUIREMENTS, MONITORING ADHERENCE TO SCHEDULES, DEVELOPING JOB COMPETENCY MODELS, MANAGING, ASSESSING, TRAINING, AND ON-LINE CANDIDATE SCREENING AND RECRUITING FOR CONTACT CENTERS AND BUSINESS PROCESS OUTSOURCING CENTERS (U.S. CLS. 21, 23, 26, 36 AND 38).

INGA ERVIN, EXAMINING ATTORNEY

CLASS 9—(Continued).

SN 79-007,247. TOM TOM INTERNATIONAL B.V., NL-1017 CT AMSTERDAM, NETHERLANDS, FILED 10-5-2004.

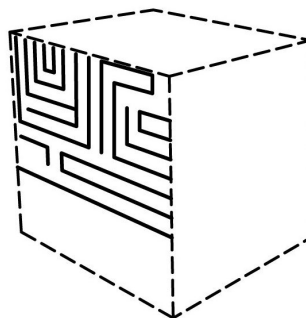

PRIORITY DATE OF 4-5-2004 IS CLAIMED.
OWNER OF INTERNATIONAL REGISTRATION 0838755 DATED 10-5-2004, EXPIRES 10-5-2014.

THE MARK CONSISTS OF A LABYRINTH DESIGN, SHOWN ON THE UPPER HALF PORTION OF THE SIDE OF A BOX, WHICH IS SHOWN IN DOTTED LINES; THE DOTTED LINES MERELY REPRESENT PLACEMENT OF THE MARK AND NEITHER THE DOTTED LINES NOR THE BOX ARE CLAIMED AS PART OF THE MARK.

SEC. 2(F).

FOR COMPUTER HARDWARE; COMPUTER SOFTWARE, NAMELY, SOFTWARE TO BE USED WITH SATELLITE AND/OR GPS NAVIGATION SYSTEMS; SOFTWARE FOR TRAVEL INFORMATION SYSTEMS FOR THE PROVISION OR RENDERING OF TRAVEL ADVICE AND/OR INFORMATION CONCERNING SERVICE STATIONS, CAR PARKS, RESTAURANTS, CAR DEALERS AND OTHER TRAVEL AND TRANSPORT RELATED INFORMATION; SOFTWARE FOR INFORMATION MANAGEMENT FOR THE TRANSPORT AND TRAFFIC INDUSTRIES; SOFTWARE TO BE USED FOR ELECTRONIC MAPS; DOWNLOADABLE ELECTRONIC MAPS; SOFTWARE FOR ROUTE PLANNERS; ROUTE PLANNERS CONSISTING OF HAND-HELD PERSONAL COMPUTERS; SOFTWARE FOR DIGITAL DICTIONARIES; ELECTRONIC DIGITAL DICTIONARIES; HARDWARE, NAMELY, LOCATION, ORIENTATION AND NAVIGATION APPARATUS FOR VEHICLES IN THE NATURE OF ON-BOARD COMPUTERS AND GPS, GLOBAL POSITIONING SYSTEMS, CONSISTING OF COMPUTERS, COMPUTER SOFTWARE, TRANSMITTERS, RECEIVERS AND NETWORK INTERFACE DEVICES AND COMPONENTS THEREFOR, NAMELY, CONNECTION CABLES AND PARTS AND FITTINGS THEREFOR; GLOBAL POSITIONING SYSTEM AND/OR SATELLITE RECEIVERS; COMPUTER CARRYING CASES, NAMELY, CARRYING CASES FOR POCKET PERSONAL COMPUTERS; SATELLITE AND RADIO TRANSMISSION APPARATUS, NAMELY, SATELLITE DISHES FOR SATELLITE TRANSMISSIONS AND DEVICES FOR WIRELESS RADIO TRANSMISSION; RADIO RECEIVERS; TELECOMMUNICATIONS AND DATA NETWORKING HARDWARE, NAMELY DEVICES FOR TRANSPORTING AND AGGREGATING VOICE, DATA, AND VIDEO COMMUNICATIONS ACROSS MULTIPLE NETWORK INFRASTRUCTURES AND COMMUNICATIONS PROTOCOLS; COMPUTER TERMINALS TO BE USED WITH NAVIGATION SYSTEMS, ROUTE PLANNERS AND/OR DIGITAL MAPS; PRERECORDED MAGNETIC DATA CARRIERS AND COMPUTER DISC FEATURING TRAVEL INFORMATION; AUDIO AND VIDEO APPARATUS, NAMELY, APPARATUS FOR RECORDING, TRANSMISSION OR REPRODUCTION OF SOUND AND IMAGES; HANDHELD PERSONAL COMPUTERS; PERSONAL DIGITAL ASSISTANTS; ELECTRIC AND ELECTRONIC APPARATUS AND INSTRUMENTS, NAMELY AUDIO AND VIDEO RECEIVERS AND PROCESSORS (U.S. CLS. 21, 23, 26, 36 AND 38).

ROBERT LAVACHE, EXAMINING ATTORNEY

CLASS 9—(Continued).

SN 79-027,837. JEYDAC PTY LTD, AUSTRALIA, FILED 6-29-2006.



OWNER OF INTERNATIONAL REGISTRATION 0895917 DATED 6-29-2006, EXPIRES 6-29-2016.
FOR COMPUTER SOFTWARE FOR USE IN CREATING SPREADSHEETS FOR HOUSEHOLD BUDGETING PURPOSES (U.S. CLS. 21, 23, 26, 36 AND 38).
VERNA BETH RIRIE, EXAMINING ATTORNEY

SN 79-028,957. ZAKRYTOE AKTSIONERNOE OBSHCHESTVO; "SEKYURIT", RUSSIAN FED., FILED 8-24-2006.

Zserver

THE MARK CONSISTS OF STANDARD CHARACTERS WITHOUT CLAIM TO ANY PARTICULAR FONT, STYLE, SIZE, OR COLOR.

OWNER OF INTERNATIONAL REGISTRATION 0898670 DATED 8-24-2006, EXPIRES 8-24-2016.

FOR RECORDED AND DOWNLOADABLE COMPUTER SOFTWARE FOR THE PROTECTION OF DATA BY ENCRYPTION, USER ACCESS CONTROL, AND DIGITAL RIGHTS MANAGEMENT FROM UNAUTHORIZED USE AND ACCESS (U.S. CLS. 21, 23, 26, 36 AND 38).
COLLEEN KEARNEY, EXAMINING ATTORNEY

SN 79-030,530. ASM; AUTOMATION SENSORIK MESSTECHNIK GMBH, FED REP GERMANY, FILED 8-16-2006.

POSIDOOR

THE MARK CONSISTS OF STANDARD CHARACTERS WITHOUT CLAIM TO ANY PARTICULAR FONT, STYLE, SIZE, OR COLOR.

PRIORITY DATE OF 5-15-2006 IS CLAIMED.
OWNER OF INTERNATIONAL REGISTRATION 0902547 DATED 8-16-2006, EXPIRES 8-16-2016.

FOR ELECTRIC MEASURING APPARATUS AND INSTRUMENTS, NAMELY, ELECTRIC OR ELECTRONIC SENSORS FOR PATH-MEASURING, ELECTRIC OR ELECTRONIC POSITION SENSORS, ELECTRIC OR ELECTRONIC SPEED DETECTORS ALL FOR USE IN DETECTING AND MEASURING LINEAR, ROTATIVE OR MULTI-DIMENSIONAL MOVEMENTS WITH MAGNETIC OR ELECTRIC EFFECTS (U.S. CLS. 21, 23, 26, 36 AND 38).

JULIE THOMAS, EXAMINING ATTORNEY

CLASS 9—(Continued).

SN 79-032,773. NO CLIMB PRODUCTS LIMITED, UNITED KINGDOM, FILED 5-11-2006.

TESTIFIRE

PRIORITY DATE OF 11-14-2005 IS CLAIMED.
OWNER OF INTERNATIONAL REGISTRATION 0908234 DATED 5-11-2006, EXPIRES 5-11-2016.

FOR SMOKE DETECTOR TESTING APPARATUS, NAMELY, AEROSOL PARTICULATE GENERATION APPARATUS; CARBON MONOXIDE DETECTOR TESTING APPARATUS, NAMELY CARBON MONOXIDE GENERATION APPARATUS; HEAT DETECTOR TESTING APPARATUS, NAMELY HEAT GENERATION APPARATUS; REFILL CARTRIDGES NAMELY NON-PRESSURIZED REFILL CAPSULES FOR SMOKE GENERATION AND ACTIVATED CARBON CARTRIDGES FOR CARBON MONOXIDE GENERATION OPERATED BY INTEGRATED CIRCUITS FOR USE WITH FIRE DETECTOR TESTING APPARATUS AND SYSTEMS; RECHARGEABLE BATTERY PACKS; BATTERY CHARGERS; RADIO FREQUENCY IDENTIFICATION TAGS FOR USE WITH FIRE DETECTOR TESTING AND REPORTING APPARATUS AND SYSTEMS; COMPUTER SOFTWARE FOR READING FROM AND WRITING TO RADIO FREQUENCY IDENTIFICATION TAGS, FOR USE IN DATABASE MANAGEMENT, FOR USE IN CONJUNCTION WITH FIRE DETECTOR TESTING AND REPORTING APPARATUS AND SYSTEMS; COMMUNICATIONS SOFTWARE FOR CONNECTING RFID TAGS TO FIRE DETECTOR TESTING APPARATUS AND REPORTING SYSTEMS AND FIRE DETECTOR TESTING APPARATUS AND REPORTING SYSTEMS TO PORTABLE COMPUTING DEVICES FOR USE WITH FIRE DETECTOR TESTING AND REPORTING APPARATUS AND SYSTEMS (U.S. CLS. 21, 23, 26, 36 AND 38).
GILBERT SWIFT, EXAMINING ATTORNEY

SN 79-033,410. INNOVAVENT GMBH, FED REP GERMANY, FILED 10-10-2006.



PRIORITY DATE OF 6-19-2006 IS CLAIMED.
OWNER OF INTERNATIONAL REGISTRATION 0909782 DATED 10-10-2006, EXPIRES 10-10-2016.

THE COLOR(S) BLUE, BLACK, WHITE IS/ARE CLAIMED AS A FEATURE OF THE MARK.

THE COLOR BLACK APPEARS IN THE LETTERS L A V, WITH THE FINAL LETTER A APPEARING IN BLUE. THE BLUE A ATTACHES TO A BLUE HORIZONTAL LINE APPEARING UNDERNEATH THE LAV. THE MARK IS ON WHITE BACKGROUND.

FOR OPTICAL SYSTEM COMPRISED OF BEAM SHAPING, HOMOGENIZING AND PROJECTION OPTICS FOR THERMAL PROCESSING OF THIN SILICON LAYERS FOR ELECTRONICS AND SEMICONDUCTOR INDUSTRY, USING A FREQUENCY-CONVERTED SOLID STATE LASER AND A SPHERICAL PROJECTION OBJECTIVE TO CREATE A NARROW LINE OF LASER LIGHT ON THE SUBSTRATE WHICH IS HEATED BY THE LASER BEAM (U.S. CLS. 21, 23, 26, 36 AND 38).

LYDIA BELZER, EXAMINING ATTORNEY

CLASS 9—(Continued).

SN 79-034,780. OBCHTCHESTVO S OGRANITCHENNOI; OTVETSTVENNOSTYOU; "SVEN GROUP", RU-109518 MOSKVA, RUSSIAN FED., FILED 6-15-2006.

SVEN

THE MARK CONSISTS OF STANDARD CHARACTERS WITHOUT CLAIM TO ANY PARTICULAR FONT, STYLE, SIZE, OR COLOR.

OWNER OF INTERNATIONAL REGISTRATION 0805928 DATED 1-21-2003, EXPIRES 1-21-2013.

FOR ELECTRIC APPARATUS AND INSTRUMENTS, NAMELY, ELECTRIC STORAGE BATTERIES, VOLTAGE REGULATORS, VOLTAGE SURGE PROTECTORS; APPARATUS FOR RECORDING, TRANSMITTING AND REPRODUCING SOUND AND IMAGES; MAGNETIC RECORDING MEDIA, NAMELY, BLANK RECORD DISKS, BLANK SOUND RECORDING DISKS, NAMELY, COMPUTER DISKS; CASH REGISTERS, CALCULATING MACHINES, NAMELY, CALCULATORS; DATA PROCESSING AND COMPUTER EQUIPMENT, NAMELY, DATA PROCESSORS AND COMPUTER HARDWARE (U.S. CLS. 21, 23, 26, 36 AND 38).

JAMES STEIN, EXAMINING ATTORNEY

SN 79-035,705. GAMESA INNOVATION & TECHNOLOGY, S.L., SPAIN, FILED 11-28-2006.

MULTISMART

PRIORITY DATE OF 6-13-2006 IS CLAIMED.

OWNER OF INTERNATIONAL REGISTRATION 0916838 DATED 11-28-2006, EXPIRES 11-28-2016.

FOR APPARATUS FOR CONDUCTING, SWITCHING, TRANSFORMING, ACCUMULATING, REGULATING OR CONTROLLING ELECTRICITY, NAMELY, POWER SWITCHES, ADAPTERS, ELECTRICITY CONDUITS, ELECTRIC WIRES, VOLTAGE REGULATORS FOR ELECTRIC POWER, ELECTRICAL CONDUCTORS; DATA PROCESSORS; CENTRAL PROCESSING UNITS FOR PROCESSING INFORMATION, DATA, SOUND OR IMAGES; DATA PROCESSING COMPUTERS, ALL FOR OPERATING AND CONTROL OF WIND TURBINES (U.S. CLS. 21, 23, 26, 36 AND 38).

GILBERT SWIFT, EXAMINING ATTORNEY

CLASS 9—(Continued).

SN 79-036,823. ADICIONA SERVICIOS INFORMATICOS, S.L., E-08030 BARCELONA, SPAIN, FILED 3-26-2007.

e-polite



OWNER OF INTERNATIONAL REGISTRATION 0919822 DATED 3-26-2007, EXPIRES 3-26-2017.

THE COLOR(S) BLACK, WHITE, RED, YELLOW AND GREEN IS/ARE CLAIMED AS A FEATURE OF THE MARK.

THE MARK CONSISTS IN A GRAPHIC AND DENOMINATIVE COMBINATION FORMED BY THE DENOMINATION "E-POLITE" WRITTEN IN BLACK LOWER-CASE FANCY TYPE, FOLLOWED BY A YELLOW SQUARE BORDERED IN BLACK WHICH RESTS ON ONE OF ITS CORNERS, IN WHICH IS INSERTED A RECTANGULAR FIGURE WITH BLUNT CORNERS STANDING VERTICALLY, WITHIN WHICH ARE ARRANGED THREE WHITE ENVELOPES ON CIRCLES THAT ARE RESPECTIVELY RED, YELLOW AND GREEN.

FOR COMPUTER PROGRAMS FOR FILTERING ELECTRONIC MESSAGES (U.S. CLS. 21, 23, 26, 36 AND 38).

ELLEN BURNS, EXAMINING ATTORNEY

SN 79-037,523. FS MEDIA PTY LTD, AUSTRALIA, FILED 3-2-2007.

OWNER OF INTERNATIONAL REGISTRATION 0921543 DATED 3-2-2007, EXPIRES 3-2-2017.

NO CLAIM IS MADE TO THE EXCLUSIVE RIGHT TO USE "PDF", APART FROM THE MARK AS SHOWN.

FOR SOFTWARE, NAMELY SOFTWARE FOR CREATING, READING, MANAGING, INDEXING AND RETRIEVING DOCUMENTS IN PDF FORMAT (U.S. CLS. 21, 23, 26, 36 AND 38).

MARY BOAGNI, EXAMINING ATTORNEY

SN 79-037,795. SAMSUNG ELECTRONICS CO., LTD., GYEONGGI-DO, REPUBLIC OF KOREA, FILED 4-16-2007.

DUALICIOUS

THE MARK CONSISTS OF STANDARD CHARACTERS WITHOUT CLAIM TO ANY PARTICULAR FONT, STYLE, SIZE, OR COLOR.

PRIORITY DATE OF 4-6-2007 IS CLAIMED.

OWNER OF INTERNATIONAL REGISTRATION 0922252 DATED 4-16-2007, EXPIRES 4-16-2017.

FOR MOBILE TELEPHONES; MOBILE TELEPHONE ACCESSORIES, NAMELY, RECHARGEABLE BATTERIES, BATTERY CHARGERS, HEADSETS AND CASES FOR MOBILE TELEPHONES (U.S. CLS. 21, 23, 26, 36 AND 38).

DORITT L. CARROLL, EXAMINING ATTORNEY

CLASS 9—(Continued).

SN 79-039,089. ALLEN & HEATH LIMITED, UNITED KINGDOM, FILED 1-31-2007.

XONE

THE MARK CONSISTS OF STANDARD CHARACTERS WITHOUT CLAIM TO ANY PARTICULAR FONT, STYLE, SIZE, OR COLOR.

PRIORITY DATE OF 7-31-2006 IS CLAIMED. OWNER OF INTERNATIONAL REGISTRATION 0925671 DATED 1-31-2007, EXPIRES 1-31-2017.

FOR DIGITAL AND ANALOGUE AUDIO AND VIDEO MIXING, ROUTING, PROCESSING AND STORAGE EQUIPMENT, NAMELY, MIXING CONSOLES AND MATRIX MIXING UNITS FOR USE IN BROADCASTING, LIVE PERFORMANCE AND RECORDING INDUSTRIES, SOUND AMPLIFIERS AND PARTS THEREFORE, CONTROL DEVICES, NAMELY, HANDHELD, DESK OR WALL MOUNTED SYSTEM CONTROL UNITS FOR CONNECTION TO DIGITAL SIGNAL PROCESSORS AND INSTALLED SOUND MANAGEMENT SYSTEMS, COMPUTER SOFTWARE FOR STORING, RECALLING, EDITING AND MANUALLY UPDATING AUDIO PARAMETERS, DIGITAL SIGNAL PROCESSORS FOR USE IN INSTALLED SOUND MANAGEMENT SYSTEMS PROVIDING COMPUTER CONTROLLED AUDIO MANIPULATION IN THE FORM OF EQUALIZATION COMPRESSION, LIMITATION, EXPANSION, DUCKERS AND OTHER ASSOCIATED EFFECTS (U.S. CLS. 21, 23, 26, 36 AND 38).

Laurie Kaufman, Examining Attorney

SN 79-039,593. THALES OPTRONIQUE SA, FRANCE, FILED 5-3-2007.

Nitenet

PRIORITY DATE OF 12-19-2006 IS CLAIMED. OWNER OF INTERNATIONAL REGISTRATION 0926894 DATED 5-3-2007, EXPIRES 5-3-2017.

FOR PORTABLE CAMERAS WITH NIGHT VISION FOR USE IN THE MILITARY AND PARAMILITARY FIELDS (U.S. CLS. 21, 23, 26, 36 AND 38).

Barbara Brown, Examining Attorney

CLASS 10—MEDICAL APPARATUS

SN 76-673,218. CHAD THERAPEUTICS, INC., CHATSWORTH, CA. FILED 2-26-2007.

THE POWER OF SIX

THE MARK CONSISTS OF STANDARD CHARACTERS WITHOUT CLAIM TO ANY PARTICULAR FONT, STYLE, SIZE, OR COLOR.

FOR OXYGEN CONCENTRATOR FOR MEDICAL APPLICATIONS (U.S. CLS. 26, 39 AND 44).

Jacqueline A. Lavine, Examining Attorney

SN 76-675,325. VERITT MEDICAL LTD., CHILBOLTON HANTS, ENGLAND, FILED 4-11-2007.

Nu Trac

THE MARK CONSISTS OF STANDARD CHARACTERS WITHOUT CLAIM TO ANY PARTICULAR FONT, STYLE, SIZE, OR COLOR.

FOR MEDICAL DEVICES FOR NON-INVASIVE MEASUREMENT OF NEUROLOGICAL ACTIVITY, NAMELY, ELECTROMYOGRAPHY (EMG) MACHINES WITH COMBINED MUSCLE STIMULATOR (U.S. CLS. 26, 39 AND 44).

Steven Perez, Examining Attorney

SN 77-004,808. MEDINGO LTD., YOKNEAM 20692, ISRAEL, FILED 9-21-2006.

SOLO

THE MARK CONSISTS OF STANDARD CHARACTERS WITHOUT CLAIM TO ANY PARTICULAR FONT, STYLE, SIZE, OR COLOR.

FOR MEDICAL DEVICES FOR THE INFUSION OF THERAPEUTIC FLUID COMPRISING REMOTE CONTROLS, COMPUTER HARDWARE AND SOFTWARE FOR SENSING GLUCOSE AND DISPENSING INSULIN AND PARTS AND ATTACHMENTS FOR THESE DEVICES (U.S. CLS. 26, 39 AND 44).

Alicia Collins, Examining Attorney

CLASS 10—(Continued).

SN 77-017,595. ARTIVENT CORPORATION, SAN FRANCISCO, CA. FILED 10-10-2006.

SAVE

THE MARK CONSISTS OF STANDARD CHARACTERS WITHOUT CLAIM TO ANY PARTICULAR FONT, STYLE, SIZE, OR COLOR.

FOR MEDICAL DEVICES, NAMELY, RESUSCITATION APPARATUS, MANUAL VENTILATORS, MANUAL EMERGENCY VENTILATORS, TRANSPORT VENTILATORS, POWERED VENTILATORS, POWERED EMERGENCY VENTILATORS, POSITIVE END EXPIRATORY VALVES, OXYGEN MASKS, OXYGEN TUBING, OXYGEN FILTERS, ENDOTRACHEAL TUBES, NASOPHARYNGEAL AIRWAY TUBING, LARYNGEAL MASKS, AIRWAY NANOMETERS, ALL FOR USE DURING ARTIFICIAL VENTILATION OR RESUSCITATION, FOR REGULATING OR CONTROLLING VENTILATION, AND FOR REGULATING OR CONTROLLING RESUSCITATION; ACCESSORIES FOR THE AFOREMENTIONED VENTILATORS AND RESUSCITATORS (U.S. CLS. 26, 39 AND 44).

TARAH HARDY, EXAMINING ATTORNEY

CLASS 10—(Continued).

SN 77-028,354. REGENCY INTERNATIONAL MARKETING, LLC, LAS VEGAS, NV. FILED 10-24-2006.

SILICONE GEL ALWAYS 100% PURE

THE MARK CONSISTS OF STANDARD CHARACTERS WITHOUT CLAIM TO ANY PARTICULAR FONT, STYLE, SIZE, OR COLOR.

NO CLAIM IS MADE TO THE EXCLUSIVE RIGHT TO USE "SILICONE GEL", APART FROM THE MARK AS SHOWN.

FOR BREAST PROSTHESES AND PRESSURE RELIEF PADS, CUSHIONS, MATTRESSES AND MATTRESS OVERLAYS FOR THERAPEUTIC PURPOSES (U.S. CLS. 26, 39 AND 44).

ANNE E. GUSTASON, EXAMINING ATTORNEY

SN 77-026,384. LINA MEDICAL APS, DK-2600 GLOSTRUP, DENMARK, FILED 10-20-2006.

POWERBLADE

THE MARK CONSISTS OF STANDARD CHARACTERS WITHOUT CLAIM TO ANY PARTICULAR FONT, STYLE, SIZE, OR COLOR.

FOR BIPOLAR CUTTING AND COAGULATING FORCEPS (U.S. CLS. 26, 39 AND 44).

FIRST USE 3-1-2003; IN COMMERCE 3-1-2003.
JEAN IM, EXAMINING ATTORNEY



SN 77-028,387. REGENCY INTERNATIONAL MARKETING, LLC, LAS VEGAS, NV. FILED 10-24-2006.

SN 77-027,401. ACTIVE IMPLANTS CORPORATION, MEMPHIS, TN. FILED 10-23-2006.

TriboFit

THE MARK CONSISTS OF STANDARD CHARACTERS WITHOUT CLAIM TO ANY PARTICULAR FONT, STYLE, SIZE, OR COLOR.

FOR ORTHOPEDIC JOINT IMPLANTS (U.S. CLS. 26, 39 AND 44).

SETH A. RAPPAPORT, EXAMINING ATTORNEY

NO CLAIM IS MADE TO THE EXCLUSIVE RIGHT TO USE "SILICONE GEL", APART FROM THE MARK AS SHOWN.

THE COLOR(S) RED, GRAY AND PINK IS/ARE CLAIMED AS A FEATURE OF THE MARK.

THE MARK CONSISTS OF A SQUARE OUTLINED IN RED; GRADUATING SHADES OF PINK APPEAR IN AND ABOVE INTERSECTING CURVED LINES INSIDE THE SQUARE; RED APPEARS IN, ABOVE AND BELOW THE INTERSECTING CURVED LINES INSIDE THE SQUARE; AND THE COLOR GRAY APPEARS IN THE WORDING SILICONE GEL ALWAYS 100% PURE BELOW THE SQUARE.

FOR BREAST PROSTHESES AND PRESSURE RELIEF PADS, CUSHIONS, MATTRESSES AND MATTRESS OVERLAYS FOR THERAPEUTIC PURPOSES (U.S. CLS. 26, 39 AND 44).

ANNE E. GUSTASON, EXAMINING ATTORNEY

CLASS 10—(Continued).

SN 77-057,287. SARCOS INVESTMENTS LC, SALT LAKE CITY, UT. FILED 12-5-2006.

BODYPORT

THE MARK CONSISTS OF STANDARD CHARACTERS WITHOUT CLAIM TO ANY PARTICULAR FONT, STYLE, SIZE, OR COLOR.

FOR INTRAVENOUS PUMPS; MEDICAL DEVICES, NAMELY DRUG PUMPS FOR DELIVERY AND INFUSION OF DRUGS; MEDICAL DEVICES, NAMELY, DRUG PUMP KITS PRIMARILY CONSISTING OF DRUG PUMPS FOR DELIVERY AND INFUSION OF DRUGS (U.S. CLS. 26, 39 AND 44).

JASON TURNER, EXAMINING ATTORNEY

SN 77-057,289. SARCOS INVESTMENTS LC, SALT LAKE CITY, UT. FILED 12-5-2006.

BODYPORTAL

THE MARK CONSISTS OF STANDARD CHARACTERS WITHOUT CLAIM TO ANY PARTICULAR FONT, STYLE, SIZE, OR COLOR.

FOR INTRAVENOUS PUMPS; MEDICAL DEVICES, NAMELY DRUG PUMPS FOR DELIVERY AND INFUSION OF DRUGS; MEDICAL DEVICES, NAMELY, DRUG PUMP KITS PRIMARILY CONSISTING OF DRUG PUMPS FOR DELIVERY AND INFUSION OF DRUGS (U.S. CLS. 26, 39 AND 44).

JASON TURNER, EXAMINING ATTORNEY

SN 77-057,917. MENNEN MEDICAL CORP., HORSHAM, PA. FILED 12-6-2006.



NO CLAIM IS MADE TO THE EXCLUSIVE RIGHT TO USE "MEDICAL", APART FROM THE MARK AS SHOWN.

THE COLOR(S) BLUE, WHITE, BLACK, GRAY IS/ARE CLAIMED AS A FEATURE OF THE MARK.

"THE MARK CONSISTS OF A CIRCLE CONTAINING

CLASS 10—(Continued).

THE LETTER "M" IN THE LOWER RIGHT QUADRANT OF THE CIRCLE AND THE WORDING MENNEN ON TOP OF THE WORDING MEDICAL TO THE RIGHT OF THE CIRCLE. THE COLOR BLACK APPEARS IN THE WORD MENNEN AND THE OUTLINE OF THE CIRCLE. THE COLOR GREY APPEARS IN THE WORD MEDICAL AND THE OUTLINE OF THE CIRCLE. THE COLOR WHITE APPEARS IN THE LETTER M, THE CIRCLE, AND THE BACKGROUND OF THE MARK. THE COLOR BLUE APPEARS IN THE CIRCLE."

FOR PATIENT PHYSIOLOGICAL HEART MONITORS FOR USE IN CRITICAL CARE AREAS OF HOSPITALS, SUCH AS THE CARDIAC CATH LAB AND INTENSIVE CARE UNITS (U.S. CLS. 26, 39 AND 44).

FIRST USE 3-1-2006; IN COMMERCE 5-1-2006.

WOODROW HARTZOG, EXAMINING ATTORNEY

SN 77-064,107. ASAHI INTECC CO., LTD., AICHI, JAPAN, FILED 12-14-2006.

CONFIANZA PRO

THE MARK CONSISTS OF STANDARD CHARACTERS WITHOUT CLAIM TO ANY PARTICULAR FONT, STYLE, SIZE, OR COLOR.

OWNER OF U.S. REG. NOS. 2,869,452 AND 2,869,453.

THE FOREIGN WORDING IN THE MARK TRANSLATES INTO ENGLISH AS TRUST.

FOR MEDICAL INSTRUMENTS AND APPARATUS, NAMELY, MEDICAL GUIDE WIRES, PTCA (PERCUTANEOUS TRANSLUMINAL CORONARY ANGIOPLASTY) GUIDE WIRES (U.S. CLS. 26, 39 AND 44).

TIMOTHY FINNEGAN, EXAMINING ATTORNEY

SN 77-066,089. SUROS SURGICAL SYSTEMS, INC., INDIANAPOLIS, IN. FILED 12-18-2006.

SUROS CELERO

THE MARK CONSISTS OF STANDARD CHARACTERS WITHOUT CLAIM TO ANY PARTICULAR FONT, STYLE, SIZE, OR COLOR.

OWNER OF U.S. REG. NOS. 2,988,641 AND 3,180,564.

FOR MEDICAL AND SURGICAL INSTRUMENTS FOR PERFORMING BIOPSIES (U.S. CLS. 26, 39 AND 44).

KAREN SEVERSON, EXAMINING ATTORNEY

CLASS 10—(Continued).

SN 77-117,316. AMERICAN AIR TECHNOLOGY, INC.,
CHALFONT, PA. FILED 2-27-2007.

Air - Easy Oxygen

THE MARK CONSISTS OF STANDARD CHARACTERS
WITHOUT CLAIM TO ANY PARTICULAR FONT, STYLE,
SIZE, OR COLOR.

NO CLAIM IS MADE TO THE EXCLUSIVE RIGHT TO
USE "OXYGEN", APART FROM THE MARK AS SHOWN.

FOR HYPERBARIC OXYGEN CHAMBERS FOR MEDICAL
PURPOSES; OXYGEN CONCENTRATORS FOR
MEDICAL APPLICATIONS (U.S. CLS. 26, 39 AND 44).

LINDA MICKLEBURGH, EXAMINING ATTORNEY

SN 77-119,898. NATHAN, ROBERT S., HAWTHORNE, NJ.
FILED 3-1-2007.

COMFORTABLY COOL

THE MARK CONSISTS OF STANDARD CHARACTERS
WITHOUT CLAIM TO ANY PARTICULAR FONT, STYLE,
SIZE, OR COLOR.

NO CLAIM IS MADE TO THE EXCLUSIVE RIGHT TO
USE "COOL", APART FROM THE MARK AS SHOWN.

FOR MEDICAL ICE PACKS (U.S. CLS. 26, 39 AND 44).
TONI HICKEY, EXAMINING ATTORNEY

SN 77-137,585. MEDTRONIC XOMED, INC., JACKSON-
VILLE, FL. FILED 3-22-2007.

NIM

THE MARK CONSISTS OF STANDARD CHARACTERS
WITHOUT CLAIM TO ANY PARTICULAR FONT, STYLE,
SIZE, OR COLOR.

OWNER OF U.S. REG. NOS. 1,727,352, 2,942,892 AND
OTHERS.

FOR NERVE INTEGRITY MONITOR AND COMPO-
NENT PARTS AND ACCESSORIES THEREFOR,
NAMELY, MEDICAL ELECTRODES, PROBES, ENDO-
TRACHEAL TUBES, EMG ENDOTRACHEAL TUBES
AND NERVE STIMULATION INSTRUMENTS (U.S.
CLS. 26, 39 AND 44).

FIRST USE 5-10-2001; IN COMMERCE 5-10-2001.
ALLISON SCHRODY, EXAMINING ATTORNEY

CLASS 10—(Continued).

SN 77-148,048. ENCOMPASS GROUP LLC, MCDONOUGH,
GA. FILED 4-4-2007.

WORKING SCRUBS

THE MARK CONSISTS OF STANDARD CHARACTERS
WITHOUT CLAIM TO ANY PARTICULAR FONT, STYLE,
SIZE, OR COLOR.

OWNER OF U.S. REG. NO. 2,052,267.

NO CLAIM IS MADE TO THE EXCLUSIVE RIGHT TO
USE "SCRUBS", APART FROM THE MARK AS SHOWN.

FOR HEALTHCARE APPAREL WORN BY PROFES-
SIONAL MEDICAL PERSONNEL, NAMELY, SCRUB
TOPS, SCRUB PANTS, SCRUB JACKETS, SCRUB
SHIRTS AND SURGICAL GOWNS (U.S. CLS. 26, 39
AND 44).

FIRST USE 6-0-1991; IN COMMERCE 6-0-1991.

MICHAEL KEATING, EXAMINING ATTORNEY

SN 77-149,303. AUDIO EVOLUTION DIAGNOSTICS, INC.,
ALBANY, NY. FILED 4-5-2007.

AUDIO EVOLUTION DIAGNOSTICS

THE MARK CONSISTS OF STANDARD CHARACTERS
WITHOUT CLAIM TO ANY PARTICULAR FONT, STYLE,
SIZE, OR COLOR.

NO CLAIM IS MADE TO THE EXCLUSIVE RIGHT TO
USE "AUDIO" OR "DIAGNOSTICS", APART FROM THE
MARK AS SHOWN.

FOR STETHOSCOPES (U.S. CLS. 26, 39 AND 44).

JUSTINE D. PARKER, EXAMINING ATTORNEY

SN 77-151,072. BIOLASE TECHNOLOGY, INC., IRVINE, CA.
FILED 4-6-2007.

DIOLASEPLUS

THE MARK CONSISTS OF STANDARD CHARACTERS
WITHOUT CLAIM TO ANY PARTICULAR FONT, STYLE,
SIZE, OR COLOR.

FOR ELECTROMAGNETIC ENERGY EMITTING DE-
VICES FOR MEDICAL USE, NAMELY, LASERS FOR
MEDICAL USE, AND PARTS AND COMPONENTS
THEREFORE (U.S. CLS. 26, 39 AND 44).

MARK PILARO, EXAMINING ATTORNEY

CLASS 10—(Continued).

SN 77-153,775. QUANTUM PHARMACEUTICALS, HILLS-DALE, NJ. FILED 4-11-2007.

CLASS 10—(Continued).

SN 77-156,944. TRI-CON DEVELOPMENT, LLC, DUBLIN, OH. FILED 4-14-2007.

TickMD

WHEN PRECIOUS MINUTES COUNT

THE MARK CONSISTS OF STANDARD CHARACTERS WITHOUT CLAIM TO ANY PARTICULAR FONT, STYLE, SIZE, OR COLOR.
FOR NON-MEDICATED ADHESIVE SHEETS FOR REMOVING TICKS (U.S. CLS. 26, 39 AND 44).
ANNE MADDEN, EXAMINING ATTORNEY

THE MARK CONSISTS OF STANDARD CHARACTERS WITHOUT CLAIM TO ANY PARTICULAR FONT, STYLE, SIZE, OR COLOR.
FOR MEDICAL APPARATUS, NAMELY, TIMING DEVICES FOR UTERINE CONTRACTIONS (U.S. CLS. 26, 39 AND 44).
ANGELA M. MICHELI, EXAMINING ATTORNEY

SN 77-154,783. TELOS SURGICAL INNOVATIONS, LLC, GRAND PRAIRIE, TX. FILED 4-12-2007.

SN 77-157,339. IMED SURGICAL LLC, FORT LEE, NJ. FILED 4-16-2007.

I-GARD

IMEDSURGICAL

THE MARK CONSISTS OF STANDARD CHARACTERS WITHOUT CLAIM TO ANY PARTICULAR FONT, STYLE, SIZE, OR COLOR.
FOR MEDICAL AND SURGICAL DEVICES AND INSTRUMENTS FOR USE IN SURGICAL PROCEDURES RELATING TO THE SPINE (U.S. CLS. 26, 39 AND 44).
LINDA ESTRADA, EXAMINING ATTORNEY

FOR MEDICAL AND SURGICAL APPARATUS AND INSTRUMENTS, NAMELY, ORTHOPEDIC FIXATION DEVICE USED IN ORTHOPEDIC TRANSPLANT AND/OR IMPLANT SURGERY (U.S. CLS. 26, 39 AND 44).
FIRST USE 9-11-2006; IN COMMERCE 9-11-2006.
ROBIN CHOSID, EXAMINING ATTORNEY

SN 77-155,053. ELI LILLY AND COMPANY, INDIANAPOLIS, IN. FILED 4-12-2007.

SN 77-157,491. COLOPLAST A/S, HUMLEBAEK, DENMARK, FILED 4-16-2007.

KOMPENIUM

TRIFORM

THE MARK CONSISTS OF STANDARD CHARACTERS WITHOUT CLAIM TO ANY PARTICULAR FONT, STYLE, SIZE, OR COLOR.
FOR HYPODERMIC SYRINGES, SOLD EMPTY, FOR HUMAN GROWTH HORMONE MEDICATION (U.S. CLS. 26, 39 AND 44).
MICHAEL GAAFAR, EXAMINING ATTORNEY

THE MARK CONSISTS OF STANDARD CHARACTERS WITHOUT CLAIM TO ANY PARTICULAR FONT, STYLE, SIZE, OR COLOR.
FOR MEDICAL BAGS, NAMELY, LEG BAGS AND BEDSIDE BAGS FOR URINARY DRAINAGE (U.S. CLS. 26, 39 AND 44).
CHARLOTTE CORWIN, EXAMINING ATTORNEY

CLASS 10—(Continued).

SN 77-157,557. CPM PRODUCTS, LLC, BEVERLY HILLS, CA. FILED 4-16-2007.

Vibo Trainer Pro

THE MARK CONSISTS OF STANDARD CHARACTERS WITHOUT CLAIM TO ANY PARTICULAR FONT, STYLE, SIZE, OR COLOR.

NO CLAIM IS MADE TO THE EXCLUSIVE RIGHT TO USE "TRAINER", APART FROM THE MARK AS SHOWN. FOR VIBRATING APPARATUS USED TO STIMULATE MUSCLES AND INCREASE STRENGTH AND PHYSICAL PERFORMANCE FOR HEALTH AND MEDICAL PURPOSES (U.S. CLS. 26, 39 AND 44).

CAROLINE WOOD, EXAMINING ATTORNEY

SN 77-158,792. ALPINE BIOMED CORP., FOUNTAIN VALLEY, CA. FILED 4-17-2007.

RepHlux Tracer

THE MARK CONSISTS OF STANDARD CHARACTERS WITHOUT CLAIM TO ANY PARTICULAR FONT, STYLE, SIZE, OR COLOR.

NO CLAIM IS MADE TO THE EXCLUSIVE RIGHT TO USE REFLUX, APART FROM THE MARK AS SHOWN. FOR MEDICAL INSTRUMENTS FOR USE IN GASTROINTESTINAL AND UROLOGICAL DIAGNOSTICS (U.S. CLS. 26, 39 AND 44).

JOHN HWANG, EXAMINING ATTORNEY

SN 77-158,841. ALPINE BIOMED CORP., FOUNTAIN VALLEY, CA. FILED 4-17-2007.

VersaFlex

THE MARK CONSISTS OF STANDARD CHARACTERS WITHOUT CLAIM TO ANY PARTICULAR FONT, STYLE, SIZE, OR COLOR.

FOR MEDICAL CATHETERS (U.S. CLS. 26, 39 AND 44).

JOHN HWANG, EXAMINING ATTORNEY

CLASS 10—(Continued).

SN 77-158,856. ALPINE BIOMED CORP., FOUNTAIN VALLEY, CA. FILED 4-17-2007.

GeroFlex

THE MARK CONSISTS OF STANDARD CHARACTERS WITHOUT CLAIM TO ANY PARTICULAR FONT, STYLE, SIZE, OR COLOR.

FOR MEDICAL CATHETERS (U.S. CLS. 26, 39 AND 44).

JOHN HWANG, EXAMINING ATTORNEY

SN 77-159,708. LITECURE LLC, NEWARK, DE. FILED 4-18-2007.

ChiroLase

THE MARK CONSISTS OF STANDARD CHARACTERS WITHOUT CLAIM TO ANY PARTICULAR FONT, STYLE, SIZE, OR COLOR.

FOR LASERS FOR MEDICAL USE; LASERS FOR SURGICAL AND MEDICAL USE; LASERS FOR THE COSMETIC TREATMENT OF THE FACE AND SKIN (U.S. CLS. 26, 39 AND 44).

FIRST USE 12-1-2006; IN COMMERCE 12-1-2006.

ESTHER A. BORSUK, EXAMINING ATTORNEY

SN 77-161,618. NEO-FLO, INC. D/B/A MICROCOPY, KENNESAW, GA. FILED 4-20-2007.

CROWNKING

THE MARK CONSISTS OF STANDARD CHARACTERS WITHOUT CLAIM TO ANY PARTICULAR FONT, STYLE, SIZE, OR COLOR.

FOR DENTAL BURRS (U.S. CLS. 26, 39 AND 44).

YONG KIM, EXAMINING ATTORNEY

CLASS 10—(Continued).

SN 77-162,325. JONES, MARTHA SUE, MARICOPA, AZ.
FILED 4-20-2007.

Kitty Sajer

THE MARK CONSISTS OF STANDARD CHARACTERS
WITHOUT CLAIM TO ANY PARTICULAR FONT, STYLE,
SIZE, OR COLOR.

NO CLAIM IS MADE TO THE EXCLUSIVE RIGHT TO
USE "KITTY", APART FROM THE MARK AS SHOWN.
FOR VIBRATING MASSAGE MITS FOR PETS (U.S.
CLS. 26, 39 AND 44).

FIRST USE 1-15-2007; IN COMMERCE 1-15-2007.
MICHAEL SOUDERS, EXAMINING ATTORNEY

CLASS 10—(Continued).

SN 77-164,290. SPINEFRONTIER, INC., BEVERLY, MA.
FILED 4-24-2007.

URSA

THE MARK CONSISTS OF STANDARD CHARACTERS
WITHOUT CLAIM TO ANY PARTICULAR FONT, STYLE,
SIZE, OR COLOR.

FOR ORTHOPEDIC IMPLANTS AND ORTHOPEDIC
INSTRUMENTS TO FACILITATE THE IMPLANTATION
OF ORTHOPEDIC IMPLANTS (U.S. CLS. 26, 39 AND 44).
RENEE MCCRAY, EXAMINING ATTORNEY

SN 77-162,352. JONES, MARTHA SUE, MARICOPA, AZ.
FILED 4-20-2007.

Doggy Sajer

THE MARK CONSISTS OF STANDARD CHARACTERS
WITHOUT CLAIM TO ANY PARTICULAR FONT, STYLE,
SIZE, OR COLOR.

NO CLAIM IS MADE TO THE EXCLUSIVE RIGHT TO
USE "DOGGY", APART FROM THE MARK AS SHOWN.
FOR VIBRATING MASSAGE MITS FOR PETS (U.S.
CLS. 26, 39 AND 44).

FIRST USE 1-15-2007; IN COMMERCE 1-15-2007.
MICHAEL SOUDERS, EXAMINING ATTORNEY

SN 77-164,306. SPINEFRONTIER, INC., BEVERLY, MA.
FILED 4-24-2007.

CRUX

THE MARK CONSISTS OF STANDARD CHARACTERS
WITHOUT CLAIM TO ANY PARTICULAR FONT, STYLE,
SIZE, OR COLOR.

FOR ORTHOPEDIC IMPLANTS AND ORTHOPEDIC
INSTRUMENTS TO FACILITATE THE IMPLANTATION
OF ORTHOPEDIC IMPLANTS (U.S. CLS. 26, 39 AND 44).
RENEE MCCRAY, EXAMINING ATTORNEY

SN 77-164,265. SPINEFRONTIER, INC., BEVERLY, MA.
FILED 4-24-2007.

CANIS

THE MARK CONSISTS OF STANDARD CHARACTERS
WITHOUT CLAIM TO ANY PARTICULAR FONT, STYLE,
SIZE, OR COLOR.

FOR ORTHOPEDIC IMPLANTS AND ORTHOPEDIC
INSTRUMENTS TO FACILITATE THE IMPLANTATION
OF ORTHOPEDIC IMPLANTS (U.S. CLS. 26, 39 AND 44).
RENEE MCCRAY, EXAMINING ATTORNEY

SN 77-164,310. SEATTLE MEDICAL TECHNOLOGIES, INC.,
PORTOLA VALLEY, CA. FILED 4-24-2007.

CLICK-IT

THE MARK CONSISTS OF STANDARD CHARACTERS
WITHOUT CLAIM TO ANY PARTICULAR FONT, STYLE,
SIZE, OR COLOR.

FOR DRUG DELIVERY SYSTEMS (U.S. CLS. 26, 39
AND 44).
HANNO RITTNER, EXAMINING ATTORNEY

CLASS 10—(Continued).

SN 77-178,050. IRIS INTERNATIONAL, INC., CHATSWORTH, CA. FILED 5-10-2007.

CHOICE

THE MARK CONSISTS OF STANDARD CHARACTERS WITHOUT CLAIM TO ANY PARTICULAR FONT, STYLE, SIZE, OR COLOR.

FOR MEDICAL DEVICES, NAMELY, URINE CHEMISTRY SYSTEM CONSISTING ESSENTIALLY OF URINE ANALYZER DEVICE AND CHEMISTRY STRIPS; AND AUTOMATED MICROSCOPY URINE ANALYZER DEVICE (U.S. CLS. 26, 39 AND 44).

JOHN E. MICHOS, EXAMINING ATTORNEY

CLASS 10—(Continued).

SN 77-178,187. IRIS INTERNATIONAL, INC., CHATSWORTH, CA. FILED 5-10-2007.

VELOCITY

THE MARK CONSISTS OF STANDARD CHARACTERS WITHOUT CLAIM TO ANY PARTICULAR FONT, STYLE, SIZE, OR COLOR.

FOR MEDICAL DEVICES, NAMELY, URINE CHEMISTRY SYSTEM CONSISTING ESSENTIALLY OF URINE ANALYZER DEVICE AND CHEMISTRY STRIPS; AND AUTOMATED MICROSCOPY URINE ANALYZER DEVICE (U.S. CLS. 26, 39 AND 44).

JOHN E. MICHOS, EXAMINING ATTORNEY

SN 77-178,109. IRIS INTERNATIONAL, INC., CHATSWORTH, CA. FILED 5-10-2007.

IRICELL

THE MARK CONSISTS OF STANDARD CHARACTERS WITHOUT CLAIM TO ANY PARTICULAR FONT, STYLE, SIZE, OR COLOR.

FOR MEDICAL DEVICES, NAMELY, URINE CHEMISTRY SYSTEM CONSISTING ESSENTIALLY OF URINE ANALYZER DEVICE AND CHEMISTRY STRIPS; AND AUTOMATED MICROSCOPY URINE ANALYZER DEVICE (U.S. CLS. 26, 39 AND 44).

JOHN E. MICHOS, EXAMINING ATTORNEY

SN 77-186,064. SALVIN DENTAL SPECIALTIES, INC., CHARLOTTE, NC. FILED 5-21-2007.

RAPID ROLL

THE MARK CONSISTS OF STANDARD CHARACTERS WITHOUT CLAIM TO ANY PARTICULAR FONT, STYLE, SIZE, OR COLOR.

FOR DISPOSABLE SURGICAL DRAPES (U.S. CLS. 26, 39 AND 44).

FIRST USE 9-1-2006; IN COMMERCE 9-1-2006.
CARYN GLASSER, EXAMINING ATTORNEY

SN 77-178,149. IRIS INTERNATIONAL, INC., CHATSWORTH, CA. FILED 5-10-2007.

VELO

THE MARK CONSISTS OF STANDARD CHARACTERS WITHOUT CLAIM TO ANY PARTICULAR FONT, STYLE, SIZE, OR COLOR.

FOR MEDICAL DEVICES, NAMELY, URINE CHEMISTRY SYSTEM CONSISTING ESSENTIALLY OF URINE ANALYZER DEVICE AND CHEMISTRY STRIPS; AND AUTOMATED MICROSCOPY URINE ANALYZER DEVICE (U.S. CLS. 26, 39 AND 44).

JOHN E. MICHOS, EXAMINING ATTORNEY

SN 77-204,236. BOSTON SCIENTIFIC SCIMED, INC., MAPLE GROVE, MN. FILED 6-12-2007.

KINETIX

THE MARK CONSISTS OF STANDARD CHARACTERS WITHOUT CLAIM TO ANY PARTICULAR FONT, STYLE, SIZE, OR COLOR.

FOR MEDICAL GUIDEWIRES (U.S. CLS. 26, 39 AND 44).

JOHN DALIER, EXAMINING ATTORNEY

CLASS 10—(Continued).

SN 78-034,205. WHITE, ERIC J., WINDSOR, PA. FILED 11-7-2000.

VIRTUAL SEX MACHINE

NO CLAIM IS MADE TO THE EXCLUSIVE RIGHT TO USE "VIRTUAL SEX", APART FROM THE MARK AS SHOWN.

SEC. 2(F).
FOR MEDICAL DEVICE, NAMELY, AN ADULT SEX AID, NAMELY A VIRTUAL REALITY STIMULATION KIT COMPRISING A GENITAL VIBRATOR, VACUUM-TYPE GENITAL SLEEVE, PERIPHERAL HARDWARE AND SOFTWARE FOR REPRODUCING VIDEO AND AUDIO IN LIVE OR PRERECORDED FORMATS, AND PARTS THEREFORE (U.S. CLS. 26, 39 AND 44).
FIRST USE 0-0-1992; IN COMMERCE 6-0-1995.
PATRICIA EVANKÓ, EXAMINING ATTORNEY

CLASS 10—(Continued).

SN 78-732,859. COGRE, DBA HOME THERAPEUTICS, COLLINGWOOD, CANADA, FILED 10-13-2005.

Sonic Relief

THE MARK CONSISTS OF STANDARD CHARACTERS WITHOUT CLAIM TO ANY PARTICULAR FONT, STYLE, SIZE, OR COLOR.

PRIORITY CLAIMED UNDER SEC. 44(D) ON CANADA APPLICATION NO. 1267846, FILED 8-9-2005, REG. NO. TMA677939, DATED 11-30-2006, EXPIRES 11-30-2021.

NO CLAIM IS MADE TO THE EXCLUSIVE RIGHT TO USE "SONIC", APART FROM THE MARK AS SHOWN.

FOR ULTRASONIC THERAPY MACHINES AND APPARATUS (U.S. CLS. 26, 39 AND 44).
IRENE D. WILLIAMS, EXAMINING ATTORNEY

SN 78-289,094. MICRODEXTERITY SYSTEMS, INC., ALBUQUERQUE, NM. FILED 8-19-2003.

NEURODEX

FOR MEDICAL ROBOTS FOR USE IN SURGERY AND PARTS THEREFORE (U.S. CLS. 26, 39 AND 44).
STEVEN JACKSON, EXAMINING ATTORNEY

SN 78-413,345. EVERWIN (CANADA) INTERNATIONAL INC., TORONTO, CANADA, FILED 5-5-2004.



FOR ELECTRICAL MASSAGE APPARATUS, NAMELY, A PULSE MASSAGER FOR THE EYES; ELECTRICAL FACIAL MASSAGE APPARATUS (U.S. CLS. 26, 39 AND 44).
PRISCILLA MILTON, EXAMINING ATTORNEY

SN 78-808,881. DIAZ, R. GARY, HIGHLAND PARK, IL. FILED 2-7-2006.

HEAL SCIENCE

THE MARK CONSISTS OF STANDARD CHARACTERS WITHOUT CLAIM TO ANY PARTICULAR FONT, STYLE, SIZE, OR COLOR.

FOR HEALTH AND MEDICAL CARE DEVICES TO FACILITATE INDEPENDENT LIVING, NAMELY, ARM-SUPPORTED MOBILITY DEVICES AND GAIT MONITORING DEVICES (U.S. CLS. 26, 39 AND 44).

C. DIONNE CLYBURN, EXAMINING ATTORNEY

SN 78-813,481. MERIDIAN MEDICAL TECHNOLOGIES, INC., COLUMBIA, MD. FILED 2-13-2006.

NAAK PAK

THE MARK CONSISTS OF STANDARD CHARACTERS WITHOUT CLAIM TO ANY PARTICULAR FONT, STYLE, SIZE, OR COLOR.

NO CLAIM IS MADE TO THE EXCLUSIVE RIGHT TO USE "NAAK", APART FROM THE MARK AS SHOWN.

FOR NERVE AGENT ANTIDOTE KITS COMPRISING A CASE, AN AUTO-INJECTOR, AND A NERVE AGENT ANTIDOTE (U.S. CLS. 26, 39 AND 44).

JILL C. ALT, EXAMINING ATTORNEY

CLASS 10—(Continued).

SN 78-814,799. MYGENE INTERNATIONAL, INC., SALT LAKE CITY, UT. FILED 2-14-2006.

My HPV Chip Kit

THE MARK CONSISTS OF STANDARD CHARACTERS WITHOUT CLAIM TO ANY PARTICULAR FONT, STYLE, SIZE, OR COLOR.

NO CLAIM IS MADE TO THE EXCLUSIVE RIGHT TO USE "HPV CHIP KIT", APART FROM THE MARK AS SHOWN.

FOR TEST KITS FOR LABORATORY USE FOR DIAGNOSING INFECTIOUS DISEASES (U.S. CLS. 26, 39 AND 44).

ELISSA GARBER KON, EXAMINING ATTORNEY

SN 78-836,827. PURICORE, INC., MALVERN, PA. FILED 3-14-2006.

THERICOR

THE MARK CONSISTS OF STANDARD CHARACTERS WITHOUT CLAIM TO ANY PARTICULAR FONT, STYLE, SIZE, OR COLOR.

FOR FLUID CHEMICAL BIOCIDES DISPENSING MACHINES FOR CLEANSING, DISINFECTING, STERILIZING OR WASHING WOUNDS, BURNS, INVASIVE SURGICAL OPENINGS, HANDS, OTHER SKIN AREAS AND MEDICAL INSTRUMENTS; MEDICAL ELECTRIC GENERATORS SOLD AS A COMPONENT OF STERILIZING AND DISINFECTION SOLUTION DISPENSING MACHINES RELATING TO WOUND CARE; STERILIZATION AND DISINFECTION GENERATORS AND UNITS FOR MEDICAL USE; GENERATORS FOR PRODUCING ALL-PURPOSE STERILIZING AND DISINFECTION SOLUTIONS AND RINSE WATER FOR MEDICAL AND INFECTION CONTROL USE (U.S. CLS. 26, 39 AND 44).

ALICIA COLLINS, EXAMINING ATTORNEY

SN 78-845,504. LIFEWATCH TECHNOLOGIES, INC., SAN DIEGO, CA. FILED 3-24-2006.

ACE OF HEARTS

THE MARK CONSISTS OF STANDARD CHARACTERS WITHOUT CLAIM TO ANY PARTICULAR FONT, STYLE, SIZE, OR COLOR.

OWNER OF U.S. REG. NOS. 1,513,501 AND 1,773,541. FOR ECG MONITORING DEVICES (U.S. CLS. 26, 39 AND 44).

CORY BOONE, EXAMINING ATTORNEY

CLASS 10—(Continued).

SN 78-884,675. PURICORE, INC., MALVERN, PA. FILED 5-16-2006.

APPLIED AQUAMETICS

THE MARK CONSISTS OF STANDARD CHARACTERS WITHOUT CLAIM TO ANY PARTICULAR FONT, STYLE, SIZE, OR COLOR.

FOR FLUID CHEMICAL BIOCIDES DISPENSING MACHINES FOR CLEANSING, DISINFECTING, STERILIZING OR WASHING WOUNDS, BURNS, INVASIVE SURGICAL OPENINGS, HANDS, OTHER SKIN AREAS AND MEDICAL AND DENTAL INSTRUMENTS; MEDICAL ELECTRIC GENERATORS SOLD AS A COMPONENT OF STERILIZING AND DISINFECTION SOLUTION DISPENSING MACHINES RELATING TO DENTAL CARE; DENTAL STERILIZING AND DISINFECTION SOLUTION DISPENSING MACHINES AND UNITS AND DENTAL ELECTRIC GENERATORS SOLD AS A COMPONENT OF DENTAL STERILIZING AND DISINFECTION SOLUTION DISPENSING MACHINES AND UNITS FOR DENTAL USE AND DENTAL INSTRUMENTS, PROCEDURES AND APPLICATIONS; GENERATORS FOR PRODUCING ALL-PURPOSE STERILIZING AND DISINFECTION SOLUTIONS AND RINSE WATER FOR MEDICAL AND DENTAL USE (U.S. CLS. 26, 39 AND 44).

ALICIA COLLINS, EXAMINING ATTORNEY

SN 78-885,316. GEISTER, INC., PLYMOUTH, MA. FILED 5-17-2006.

VALVEGATE

THE MARK CONSISTS OF STANDARD CHARACTERS WITHOUT CLAIM TO ANY PARTICULAR FONT, STYLE, SIZE, OR COLOR.

FOR INSTRUMENTS FOR MINIMALLY INVASIVE VALVE SURGERY, NAMELY, HOOKS, SPATULAS, RETRACTORS, CLAMPS, SCISSORS, NEEDLE HOLDERS, GRASPERS, KNOT PUSHERS, BLADES WITH HOLDERS AND INTRODUCERS, RONGEURS, INSTRUMENT HOLDERS, ENDOSCOPE HOLDERS, ENDOSCOPES, TROCARS, SUTURE RULERS, LINEAR SCALERS AND SIZERS, CADIOPLEGIA NEEDLES, VESSEL HOOKS, SUTURE CATCHERS, MAGNETIC RETRIEVERS AND SCALPEL BLADE HOLDERS (U.S. CLS. 26, 39 AND 44).

FIRST USE 1-1-2005; IN COMMERCE 1-1-2005.

MARLENE BELL, EXAMINING ATTORNEY

CLASS 10—(Continued).

SN 78-888,746. MEDICREA INTERNATIONAL, NEYRON, FRANCE, FILED 5-22-2006.

PASS

THE MARK CONSISTS OF STANDARD CHARACTERS WITHOUT CLAIM TO ANY PARTICULAR FONT, STYLE, SIZE, OR COLOR.

PRIORITY CLAIMED UNDER SEC. 44(D) ON ERPNTY TM OFC APPLICATION NO. 005032941, FILED 4-5-2006, REG. NO. 005032941, DATED 4-12-2007, EXPIRES 4-5-2016.

FOR PROSTHESIS FOR THE SPINAL COLUMN; PROSTHESES OF VERTEBRAL DISCS; INTERVERTEBRAL IMPLANTS CONSISTING OF ARTIFICIAL MATERIAL; MEDICAL INSTRUMENTS FOR THE INSTALLATION OF PROSTHESES AND MATERIALS OF OSTEOSYNTHESIS FOR THE SPINAL COLUMN, PROSTHESES OF VERTEBRAL DISCS, OR INTERVERTEBRAL IMPLANTS (U.S. CLS. 26, 39 AND 44).

WILLIAM VERHOSEK, EXAMINING ATTORNEY

SN 78-924,406. ADIRI, INC., PALO ALTO, CA. FILED 7-7-2006.

NATURAL NURSER

THE MARK CONSISTS OF STANDARD CHARACTERS WITHOUT CLAIM TO ANY PARTICULAR FONT, STYLE, SIZE, OR COLOR.

NO CLAIM IS MADE TO THE EXCLUSIVE RIGHT TO USE "NURSER", APART FROM THE MARK AS SHOWN.

FOR BABY BOTTLES; NURSING BOTTLES; NIPPLES FOR BABY BOTTLES; TEATS; DISPOSABLE TEATS; BREAST MILK STORAGE BOTTLES (U.S. CLS. 26, 39 AND 44).

KENNETH E. SHARPERSON, EXAMINING ATTORNEY

SN 78-924,414. ADIRI, INC., PALO ALTO, CA. FILED 7-7-2006.

ADIRI NATURAL NURSER

THE MARK CONSISTS OF STANDARD CHARACTERS WITHOUT CLAIM TO ANY PARTICULAR FONT, STYLE, SIZE, OR COLOR.

NO CLAIM IS MADE TO THE EXCLUSIVE RIGHT TO USE "NURSER", APART FROM THE MARK AS SHOWN.

FOR BABY BOTTLES; NURSING BOTTLES; NIPPLES FOR BABY BOTTLES; TEATS; DISPOSABLE TEATS; BREAST MILK STORAGE BOTTLES (U.S. CLS. 26, 39 AND 44).

KENNETH E. SHARPERSON, EXAMINING ATTORNEY

CLASS 10—(Continued).

SN 78-925,848. KOPY VENTURES, L.P., HOUSTON, TX. FILED 7-10-2006.



THE COLOR(S) BLUE AND GREY IS/ARE CLAIMED AS A FEATURE OF THE MARK.

THE MARK CONSISTS OF THE WORD, "METASURG", IN BLUE, TOGETHER WITH A STYLIZED M INSIDE A RING TO THE LEFT OF THE WORD, "METASURG", THE RING BEING GREY, THE STYLIZED M BEING GREY, AND THE BACKGROUND WITHIN THE RING BEING BLUE.

FOR MEDICAL INSTRUMENTS AND SURGICAL IMPLANTS COMPRISING ARTIFICIAL MATERIAL FOR BONE SURGICAL PROCEDURES INCLUDING OSTEOSYNTHESIS, INCLUDING BONE SCREWS, BONE PLATES AND KITS CONTAINING DRIVERS, COUNTERSINKS AND DEPTH GAUGES (U.S. CLS. 26, 39 AND 44).

WILLIAM P. SHANAHAN, EXAMINING ATTORNEY

SN 78-928,057. PRETIKA CORPORATION, LAGUNA NIGUEL, CA. FILED 7-12-2006.



"THE COLOR(S) BLUE, WHITE AND YELLOW IS/ARE CLAIMED AS A FEATURE OF THE MARK."

"THE MARK CONSISTS OF THE COLOR BLUE APPEARING IN THE RECTANGULAR BACKGROUND; THE COLOR WHITE APPEARING IN THE WORDING DERMA AND THE COLOR YELLOW APPEARING IN THE WORD HEAT."

FOR PERSONAL AND SKIN CARE PRODUCTS FOR USE IN SKIN REJUVENATION, NAMELY, POWER-OPERATED MASSAGERS, ELECTRONIC APPARATUS FOR APPLYING THERAPEUTIC LIGHT TO THE SKIN (U.S. CLS. 26, 39 AND 44).

ESTHER A. BORSUK, EXAMINING ATTORNEY

SN 78-965,443. ENDOLOGIX, INC., IRVINE, CA. FILED 8-31-2006.

SUREPASS

THE MARK CONSISTS OF STANDARD CHARACTERS WITHOUT CLAIM TO ANY PARTICULAR FONT, STYLE, SIZE, OR COLOR.

FOR MEDICAL DEVICES, NAMELY, CATHETERS FOR USE IN TREATING AORTIC ANEURYSMS AND COMPLICATIONS (U.S. CLS. 26, 39 AND 44).

LINDA ORNDORFF, EXAMINING ATTORNEY

CLASS 10—(Continued).

SN 78-969,524. DESCENT CONTROL SYSTEMS, INC., SANDY, UT. FILED 9-7-2006.

PARASLYDE

THE MARK CONSISTS OF STANDARD CHARACTERS WITHOUT CLAIM TO ANY PARTICULAR FONT, STYLE, SIZE, OR COLOR.

FOR STRETCHERS USED FOR PATIENT TRANSPORT AND FOR TRANSPORTING MEDICAL EQUIPMENT ATTACHED TO PATIENTS, FOR USE IN EVACUATING HOSPITALS (U.S. CLS. 26, 39 AND 44).

STEVEN R. FOSTER, EXAMINING ATTORNEY

SN 79-030,674. SOCIÉTÉ POUR LA CONCEPTION DES; APPLICATIONS DES TECHNIQUES ELECTRONIQUES -; SATELEC (SAS), FRANCE, FILED 9-1-2006.

EXCAVUS

THE MARK CONSISTS OF STANDARD CHARACTERS WITHOUT CLAIM TO ANY PARTICULAR FONT, STYLE, SIZE, OR COLOR.

PRIORITY DATE OF 3-6-2006 IS CLAIMED.

OWNER OF INTERNATIONAL REGISTRATION 0902872 DATED 9-1-2006, EXPIRES 9-1-2016.

FOR DENTAL INSTRUMENTS, NAMELY, EXCAVATOR INSERTS AND ULTRASONIC INSERTS; DENTAL INSTRUMENTS, NAMELY, INSERTS FOR DENTAL INSTRUMENTS FOR USE IN DENTISTRY CHANNELS OF TRADE BY DENTAL PROFESSIONALS (U.S. CLS. 26, 39 AND 44).

CARRIE GENOVESE, EXAMINING ATTORNEY

SN 79-033,571. LINDE AKTIENGESELLSCHAFT, FED REP GERMANY, FILED 7-18-2006.

LIV

THE MARK CONSISTS OF STANDARD CHARACTERS WITHOUT CLAIM TO ANY PARTICULAR FONT, STYLE, SIZE, OR COLOR.

PRIORITY DATE OF 2-8-2006 IS CLAIMED.

OWNER OF INTERNATIONAL REGISTRATION 0910350 DATED 7-18-2006, EXPIRES 7-18-2016.

FOR MEDICAL INSTRUMENTS AND APPARATUS, NAMELY, A PORTABLE OXYGEN DELIVERY SYSTEM COMPRISED PRIMARILY OF A FULLY INTEGRATED CYLINDER, VALVE, REGULATOR, FLOW METER, AND SHOCK ABSORBING GUARD (U.S. CLS. 26, 39 AND 44).

TRACY WHITTAKER-BROWN, EXAMINING ATTORNEY

CLASS 10—(Continued).

SN 79-038,273. SIEMENS AUDIOLOGISCHE TECHNIK GMBH, FED REP GERMANY, FILED 4-20-2007.

Open Power

THE MARK CONSISTS OF STANDARD CHARACTERS WITHOUT CLAIM TO ANY PARTICULAR FONT, STYLE, SIZE, OR COLOR.

OWNER OF INTERNATIONAL REGISTRATION 0923560 DATED 4-20-2007, EXPIRES 4-20-2017.

FOR MEDICAL HEARING AIDS (U.S. CLS. 26, 39 AND 44).

VERNA BETH RIRIE, EXAMINING ATTORNEY

SN 79-038,274. SIEMENS AUDIOLOGISCHE TECHNIK GMBH, FED REP GERMANY, FILED 4-20-2007.

Revo

THE MARK CONSISTS OF STANDARD CHARACTERS WITHOUT CLAIM TO ANY PARTICULAR FONT, STYLE, SIZE, OR COLOR.

OWNER OF INTERNATIONAL REGISTRATION 0923561 DATED 4-20-2007, EXPIRES 4-20-2017.

FOR MEDICAL HEARING AIDS (U.S. CLS. 26, 39 AND 44).

VERNA BETH RIRIE, EXAMINING ATTORNEY

SN 79-038,474. PENTAX EUROPE GMBH, FED REP GERMANY, FILED 4-4-2007.

PBLADE

THE MARK CONSISTS OF STANDARD CHARACTERS WITHOUT CLAIM TO ANY PARTICULAR FONT, STYLE, SIZE, OR COLOR.

PRIORITY DATE OF 11-3-2006 IS CLAIMED.

OWNER OF INTERNATIONAL REGISTRATION 0924153 DATED 4-4-2007, EXPIRES 4-4-2017.

FOR RIGID VIDEO LARYNGOSCOPES (U.S. CLS. 26, 39 AND 44).

JESSICA FATHY, EXAMINING ATTORNEY

CLASS 11—ENVIRONMENTAL CONTROL APPARATUS

SN 76-615,660. DYMEX CORPORATION, TORRINGTON, CT. FILED 10-7-2004.

BLUE WAVE

THE MARK CONSISTS OF STANDARD CHARACTERS WITHOUT CLAIM TO ANY PARTICULAR FONT, STYLE, SIZE, OR COLOR.

FOR LIGHT PRODUCTION AND DELIVERY SYSTEMS COMPRISED OF A POWER SUPPLY, A BULB, AND RADIATION FOCUSING AND DELIVERY OPTICS FOR EFFECTING CURING OF REACTIVE MATERIALS FOR USE IN INDUSTRIAL MANUFACTURING APPLICATIONS, NAMELY, FOR THE AEROSPACE INDUSTRY, THE AUTOMOTIVE INDUSTRY, THE ELECTRONICS INDUSTRY, THE OPTICS INDUSTRY, THE AUDIO SPEAKER INDUSTRY, THE ELECTRICAL MOTOR INDUSTRY, THE GLASS AND PLASTICS FABRICATION INDUSTRIES AND THE MEDICAL DEVICES INDUSTRY (U.S. CLS. 13, 21, 23, 31 AND 34).

FIRST USE 12-19-2001; IN COMMERCE 12-19-2001.
ALICE BENMAMAN, EXAMINING ATTORNEY

SN 76-648,738. GREENWAY HOME PRODUCTS LIMITED, GUELPH, ONTARIO N1G, 4P5, CANADA, FILED 10-18-2005.

Muskoka

PRIORITY CLAIMED UNDER SEC. 44(D) ON CANADA APPLICATION NO. 1273613, FILED 9-27-2005, REG. NO. 690509, DATED 6-21-2007, EXPIRES 6-21-2022.

NO CLAIM IS MADE TO THE EXCLUSIVE RIGHT TO USE MUSKOKA, APART FROM THE MARK AS SHOWN.

THE MARK CONSISTS OF A STYLIZED REPRESENTATION OF THE TERM MUSKOKA WHICH A FLAME DESIGN THAT REPRESENTS THE SMALL LETTER O.

FOR WOOD, GAS, ELECTRIC AND GEL FIRE PLACES, WATER FILTRATION AND PURIFICATION UNITS FOR DOMESTIC AND COMMERCIAL USE; BARBECUES, RESIDENTIAL AND COMMERCIAL ELECTRIC RADIANT HEATERS AND GAS HEATERS NAMELY, BASE BOARD HEATERS, UNIT HEATERS, WALL INSERT HEATERS, PORTABLE HEATERS, CONSTRUCTION HEATERS, CABINET HEATERS, FLOOR INSERT HEATERS, INFRA-RED HEATERS, RADIANT HEATERS, GAS ZONE HEATERS, SPACE HEATERS, AIR HEATERS, CEILING HEATERS, AND UNDER-CONCRETE HEATERS; FURNACES AND GAS RADIANT TUBE HEATERS FOR RESIDENTIAL AND COMMERCIAL USE (U.S. CLS. 13, 21, 23, 31 AND 34).

WARREN L. OLANDRIA, EXAMINING ATTORNEY

CLASS 11—(Continued).

SN 76-653,324. BAKERS PRIDE OVEN CO., INC., NEW ROCHELLE, NY. FILED 1-12-2006.

BAKERS PRIDE

THE MARK CONSISTS OF STANDARD CHARACTERS WITHOUT CLAIM TO ANY PARTICULAR FONT, STYLE, SIZE, OR COLOR.

FOR GAS AND ELECTRIC OVENS AND BROILERS FOR DOMESTIC AND COMMERCIAL USE (U.S. CLS. 13, 21, 23, 31 AND 34).

FIRST USE 9-0-1945; IN COMMERCE 9-0-1945.
SKYE YOUNG, EXAMINING ATTORNEY

SN 76-672,107. ICO, REGINA, SASKATCHEWAN, CANADA, FILED 1-31-2007.

Tuzio

THE MARK CONSISTS OF STANDARD CHARACTERS WITHOUT CLAIM TO ANY PARTICULAR FONT, STYLE, SIZE, OR COLOR.

PRIORITY CLAIMED UNDER SEC. 44(D) ON CANADA APPLICATION NO. 1311941, FILED 8-4-2006.

FOR ELECTRICALLY-HEATED TOWEL RAILS, SHOWER CURTAIN RAILS AND SHOWER STORAGE TOWER UNITS; ELECTRICAL THERMOSTATS, TIMERS AND CONTROLS FOR USE THEREWITH; AND ACCESSORIES, NAMELY, ROBE HOOKS, HANGERS, BRACKETS AND WIRING KITS, ALL SOLD AS A UNIT THEREWITH (U.S. CLS. 13, 21, 23, 31 AND 34).

FIRST USE 6-1-2005; IN COMMERCE 1-10-2007.
CHRISTINE COOPER, EXAMINING ATTORNEY

SN 76-672,108. ICO, REGINA, SASKATCHEWAN, CANADA, FILED 1-31-2007.

CosyFloor

THE MARK CONSISTS OF STANDARD CHARACTERS WITHOUT CLAIM TO ANY PARTICULAR FONT, STYLE, SIZE, OR COLOR.

PRIORITY CLAIMED UNDER SEC. 44(D) ON CANADA APPLICATION NO. 1311946, FILED 8-4-2006.

FOR ELECTRIC INFLOOR HEATING MATS; ELECTRIC INFLOOR HEATING SYSTEMS COMPOSED OF ELECTRIC WIRE EMBEDDED FLOORING UNDERLAYMENTS, THERMOSTATS, TIMERS AND CONTROLS, SOLD AS A UNIT THEREWITH (U.S. CLS. 13, 21, 23, 31 AND 34).

FIRST USE 6-1-2005; IN COMMERCE 1-10-2007.
CHRISTINE COOPER, EXAMINING ATTORNEY

CLASS 11—(Continued).

SN 76-672,109. ICO, REGINA, SASKATCHEWAN, CANADA, FILED 1-31-2007.

CosyBoard

THE MARK CONSISTS OF STANDARD CHARACTERS WITHOUT CLAIM TO ANY PARTICULAR FONT, STYLE, SIZE, OR COLOR.

PRIORITY CLAIMED UNDER SEC. 44(D) ON CANADA APPLICATION NO. 1311948, FILED 8-4-2006.

FOR INSULATED BOARD FOR ELECTRIC INFLOOR HEATING SYSTEMS (U.S. CLS. 13, 21, 23, 31 AND 34).

FIRST USE 1-10-2007; IN COMMERCE 1-10-2007.
CHRISTINE COOPER, EXAMINING ATTORNEY

SN 76-675,557. LEYDEN HOUSE LIMITED, LEYDEN, MA. FILED 4-16-2007.

ESSENTIAL AIR

THE MARK CONSISTS OF STANDARD CHARACTERS WITHOUT CLAIM TO ANY PARTICULAR FONT, STYLE, SIZE, OR COLOR.

NO CLAIM IS MADE TO THE EXCLUSIVE RIGHT TO USE "AIR", APART FROM THE MARK AS SHOWN.

FOR ELECTRIC AIR ODORIZER (U.S. CLS. 13, 21, 23, 31 AND 34).

FIRST USE 9-0-1995; IN COMMERCE 9-0-1995.
STACY WAHLBERG, EXAMINING ATTORNEY

SN 76-675,574. FRENCH, IRVIN L., NORTH VERNON, IN. FILED 4-17-2007.

PEACH

THE MARK CONSISTS OF STANDARD CHARACTERS WITHOUT CLAIM TO ANY PARTICULAR FONT, STYLE, SIZE, OR COLOR.

FOR SELF-CONTAINED, GENERATOR-POWERED HEATING, AIR-CONDITIONING, AND SUPPLEMENTAL ELECTRICITY UNIT (U.S. CLS. 13, 21, 23, 31 AND 34).

CHERYL CLAYTON, EXAMINING ATTORNEY

CLASS 11—(Continued).

SN 76-675,616. SHAEFER, LISA CAVETT, SAN ANTONIO, TX. FILED 4-17-2007.



FOR ELECTRIC NIGHT LIGHTS (U.S. CLS. 13, 21, 23, 31 AND 34).

JOHN GARTNER, EXAMINING ATTORNEY

SN 77-042,473. HONEYWELL INTERNATIONAL INC., MORRISTOWN, NJ. FILED 11-13-2006.



OWNER OF U.S. REG. NOS. 641,730, 1,419,117 AND OTHERS.

NO CLAIM IS MADE TO THE EXCLUSIVE RIGHT TO USE "ABSORBS ODOR WITH, CABIN AIR FILTER, FILTRO DE AIRE DE CABINA, FILTRE D'AIRE D'HABITACLE", APART FROM THE MARK AS SHOWN.

THE COLOR(S) ORANGE, GREEN, WHITE AND BLUE IS/ARE CLAIMED AS A FEATURE OF THE MARK.

THE MARK CONSISTS OF THE WORD FRAM WHICH APPEARS IN ORANGE IN THE UPPER LEFT HAND CORNER, THE WORD FRESH APPEARS IN WHITE AND GREEN, THE WORD BREEZE APPEARS IN WHITE AND BLUE, THE WORDS ABSORBS ODOR WITH AND CABIN AIR FILTER, FILTRO DE AIRE DE CABINA, FILTRE D'AIRE D'HABITACLE APPEAR IN WHITE ON A GREEN BANNER. THE WORDS FRESH BREEZE ALSO APPEAR ON THE BANNER IN LARGER LETTERS.

FOR CABIN AIR FILTERS FOR VEHICLES (U.S. CLS. 13, 21, 23, 31 AND 34).

MATTHEW MCDOWELL, EXAMINING ATTORNEY

SN 77-067,432. CINDEK HOLDINGS LIMITED, KOWLOON BAY, HONG KONG, FILED 12-19-2006.

NIXAN

THE MARK CONSISTS OF STANDARD CHARACTERS WITHOUT CLAIM TO ANY PARTICULAR FONT, STYLE, SIZE, OR COLOR.

FOR LIGHTING FIXTURES; ELECTRIC HOLIDAY CHRISTMAS LIGHTS; ELECTRIC LIGHTS FOR CHRISTMAS TREES; ELECTRIC HOLIDAY LIGHTS; PARTS AND FITTINGS FOR ALL THE AFORESAID GOODS (U.S. CLS. 13, 21, 23, 31 AND 34).

VIVIAN MICZNIK FIRST, EXAMINING ATTORNEY

CLASS 11—(Continued).

SN 77-093,880. THE EXETER ICE HOUSE, LLC, EXETER, NH. FILED 1-29-2007.



NO CLAIM IS MADE TO THE EXCLUSIVE RIGHT TO USE "EXETER ICE HOUSE", APART FROM THE MARK AS SHOWN.

THE COLOR(S) BLUE, RED, BLACK AND WHITE IS/ARE CLAIMED AS A FEATURE OF THE MARK.

THE MARK CONSISTS OF RED HOCKEY STICKS WITH WHITE TAPE, BLACK PUCK, BLUE LETTER "T'S, THE LETTERS "HE", "CE", "EXETER" AND "HOUSE" ARE IN BLACK.

FOR ICE SKATING RINKS (U.S. CLS. 13, 21, 23, 31 AND 34).

FIRST USE 1-23-2007; IN COMMERCE 1-23-2007.
STEVEN JACKSON, EXAMINING ATTORNEY

CLASS 11—(Continued).

SN 77-152,738. STUDIO ITALIA DESIGN USA, LLC, MIAMI, FL. FILED 4-10-2007.

Dream with the lights on

THE MARK CONSISTS OF STANDARD CHARACTERS WITHOUT CLAIM TO ANY PARTICULAR FONT, STYLE, SIZE, OR COLOR.

FOR ELECTRIC LIGHTING FIXTURES, NAMELY SURFACE MOUNTED LIGHTING FIXTURES IN THE NATURE OF WALL SCONCES, CEILING MOUNTED OR SUSPENSION/PENDANTS AND PORTABLE TABLE AND FLOOR LAMPS (U.S. CLS. 13, 21, 23, 31 AND 34).

WILLIAM P. SHANAHAN, EXAMINING ATTORNEY

SN 77-154,779. GREAT LAKES AIR SYSTEMS, CLAWSON, MI. FILED 4-12-2007.

WELDVENT

THE MARK CONSISTS OF STANDARD CHARACTERS WITHOUT CLAIM TO ANY PARTICULAR FONT, STYLE, SIZE, OR COLOR.

FOR INDUSTRIAL AIR FILTRATION EQUIPMENT, NAMELY, AN AIR CLEANER WHICH EXTRACTS SMOKE FROM THE AREA WHERE WELDERS ARE WORKING (U.S. CLS. 13, 21, 23, 31 AND 34).

FIRST USE 2-5-2007; IN COMMERCE 2-5-2007.
BENJAMIN OKEKE, EXAMINING ATTORNEY

SN 77-122,761. ROCHESTER, ALTON D., LAKELAND, FL. FILED 3-5-2007.



OWNER OF U.S. REG. NO. 2,453,044.

NO CLAIM IS MADE TO THE EXCLUSIVE RIGHT TO USE "AQUA SOFT", APART FROM THE MARK AS SHOWN.

THE COLOR(S) GREEN, NAVY BLUE AND TURQUOISE IS/ARE CLAIMED AS A FEATURE OF THE MARK.

THE COLOR GREEN APPEARS IN THE WORD AQUA, THE COLOR NAVY BLUE APPEARS IN THE WORD SOFT, THE COLOR TURQUOISE APPEARS IN ALL THREE RAIN DROPS.

FOR WATER CONDITIONING UNITS; WATER SOFTENING UNITS; WATER TREATMENT EQUIPMENT, NAMELY, REVERSE OSMOSIS FILTRATION UNITS (U.S. CLS. 13, 21, 23, 31 AND 34).

BILL DAWE, EXAMINING ATTORNEY

SN 77-155,451. CURTISON INTERNATIONAL, INC., HOUSTON, TX. FILED 4-12-2007.



FOR CEILING FANS, ELECTRIC FANS, ELECTRIC FANS FOR HOUSEHOLD PURPOSES, ELECTRIC HEATING FANS, ELECTRIC WINDOW FANS, PORTABLE ELECTRIC FANS, VENTILATING EXHAUST FANS, VENTILATING FANS FOR COMMERCIAL AND INDUSTRIAL USE (U.S. CLS. 13, 21, 23, 31 AND 34).

CHRISTINA SOBRAL, EXAMINING ATTORNEY

CLASS 11—(Continued).

SN 77-156,142. EASTRED INC., CORONA, CA. FILED 4-13-2007.

GEHEA

THE MARK CONSISTS OF STANDARD CHARACTERS WITHOUT CLAIM TO ANY PARTICULAR FONT, STYLE, SIZE, OR COLOR.

FOR ELECTRIC KETTLES (U.S. CLS. 13, 21, 23, 31 AND 34).

FIRST USE 1-8-2007; IN COMMERCE 1-8-2007.
JEFF DEFORD, EXAMINING ATTORNEY

CLASS 11—(Continued).

SN 77-158,166. SUBAIR SYSTEMS LLC, GRANITEVILLE, SC. FILED 4-17-2007.

TURFBREEZE

THE MARK CONSISTS OF STANDARD CHARACTERS WITHOUT CLAIM TO ANY PARTICULAR FONT, STYLE, SIZE, OR COLOR.

FOR ELECTRIC FANS (U.S. CLS. 13, 21, 23, 31 AND 34).

FIRST USE 1-1-1998; IN COMMERCE 1-1-1998.
CHERYL CLAYTON, EXAMINING ATTORNEY

SN 77-156,353. NATURE BRIGHT COMPANY, IRVINE, CA. FILED 4-13-2007.

PER3

THE MARK CONSISTS OF STANDARD CHARACTERS WITHOUT CLAIM TO ANY PARTICULAR FONT, STYLE, SIZE, OR COLOR.

FOR LAMPS (U.S. CLS. 13, 21, 23, 31 AND 34).
FIRST USE 4-12-2007; IN COMMERCE 4-12-2007.

JASON BLAIR, EXAMINING ATTORNEY

SN 77-158,313. ZHUZHOU TORCH AUTO LAMP CO., LTD., ZHUZHOU, CHINA, FILED 4-17-2007.

TORCH

THE MARK CONSISTS OF STANDARD CHARACTERS WITHOUT CLAIM TO ANY PARTICULAR FONT, STYLE, SIZE, OR COLOR.

FOR LIGHTS FOR VEHICLES; REAR LIGHTS FOR VEHICLES; TAIL LIGHTS FOR VEHICLES; LAMP REFLECTORS; BICYCLE LIGHTS; VEHICLE TURN-SIGNAL LIGHT BULBS; VEHICLE REFLECTORS; LIGHTING FIXTURES; LAMP SHADES (U.S. CLS. 13, 21, 23, 31 AND 34).

FIRST USE 2-1-2000; IN COMMERCE 2-1-2000.
CHERYL CLAYTON, EXAMINING ATTORNEY

SN 77-156,790. GUANGZHOU FAIRLAND ELECTRIC CO., LTD., GUANGZHOU, CHINA, FILED 4-13-2007.

FAIRLAND

THE MARK CONSISTS OF STANDARD CHARACTERS WITHOUT CLAIM TO ANY PARTICULAR FONT, STYLE, SIZE, OR COLOR.

FOR SWIMMING POOL HEATERS, WATER HEATERS FOR DOMESTIC, COMMERCIAL AND INDUSTRIAL USE, HOT WATER HEATERS, HOT WATER TANKS, AIR CONDITIONERS, AIR CONDITIONERS FOR VEHICLES, AIR-CONDITIONING APPARATUS, CENTRAL AIR-CONDITIONING INSTALLATIONS (U.S. CLS. 13, 21, 23, 31 AND 34).

ANDREA K. NADELMAN, EXAMINING ATTORNEY

SN 77-158,818. GOODSON, KATHARINE B, DALLAS, TX. FILED 4-17-2007.

ChickChill

THE MARK CONSISTS OF STANDARD CHARACTERS WITHOUT CLAIM TO ANY PARTICULAR FONT, STYLE, SIZE, OR COLOR.

FOR COLD PACKS FOR COOLING THE BODY AND NOT FOR MEDICAL PURPOSES (U.S. CLS. 13, 21, 23, 31 AND 34).

BRIAN CALLAGHAN, EXAMINING ATTORNEY

CLASS 11—(Continued).

SN 77-158,925. ZICO USA, INC., CITY OF INDUSTRY, CA.
FILED 4-17-2007.

DIGI-VAPOR

THE MARK CONSISTS OF STANDARD CHARACTERS WITHOUT CLAIM TO ANY PARTICULAR FONT, STYLE, SIZE, OR COLOR.

FOR ELECTRIC VAPORIZERS, ELECTRIC VAPORIZERS FOR SMOKERS (U.S. CLS. 13, 21, 23, 31 AND 34).
FIRST USE 3-0-2007; IN COMMERCE 3-0-2007.
KATHLEEN M. VANSTON, EXAMINING ATTORNEY

SN 77-159,699. POWERTECH, INC., COLLIERVILLE, TN.
FILED 4-18-2007.



THE COLOR(S) RED AND WHITE IS/ARE CLAIMED AS A FEATURE OF THE MARK.

THE MARK CONSISTS OF UPPERCASE P (FOR PATH) UPPERCASE M (FOR MARKER) ALL ONE WORD; WHITE LETTERS INSIDE A RED BACKGROUND.

FOR FLASHLIGHTS (U.S. CLS. 13, 21, 23, 31 AND 34).
LINDA M. KING, EXAMINING ATTORNEY

SN 77-160,441. MARKOWITZ, DAVID, PALO ALTO, CA.
FILED 4-19-2007.

Culminate

THE MARK CONSISTS OF STANDARD CHARACTERS WITHOUT CLAIM TO ANY PARTICULAR FONT, STYLE, SIZE, OR COLOR.

FOR LIGHTING FIXTURES; SOLAR LIGHT FIXTURES, NAMELY, INDOOR AND OUTDOOR SOLAR POWERED LIGHTING UNITS AND FIXTURES (U.S. CLS. 13, 21, 23, 31 AND 34).
SUNG IN, EXAMINING ATTORNEY

CLASS 11—(Continued).

SN 77-160,444. ZHUZHOU TORCH AUTO LAMP CO., LTD.,
ZHUZHOU, CHINA, FILED 4-19-2007.



THE MARK CONSISTS OF STYLLIZED WORDING TORCH.

FOR LIGHTS FOR VEHICLES; REAR LIGHTS FOR VEHICLES; TAIL LIGHTS FOR VEHICLES; BICYCLE LIGHTS; LAMP REFLECTORS; VEHICLE REFLECTORS; VEHICLE TURN-SIGNAL LIGHT BULBS; LIGHTING FIXTURES; LAMP SHADES (U.S. CLS. 13, 21, 23, 31 AND 34).

FIRST USE 2-1-2000; IN COMMERCE 2-1-2000.
CHERYL CLAYTON, EXAMINING ATTORNEY

SN 77-160,699. W.C. BRADLEY COMPANY, COLUMBUS,
GA. FILED 4-19-2007.

HEATWAVE

THE MARK CONSISTS OF STANDARD CHARACTERS WITHOUT CLAIM TO ANY PARTICULAR FONT, STYLE, SIZE, OR COLOR.

OWNER OF U.S. REG. NO. 2,015,549.
FOR BARBEQUE GRILLS (U.S. CLS. 13, 21, 23, 31 AND 34).

BRIAN CALLAGHAN, EXAMINING ATTORNEY

SN 77-161,433. AIR INNOVATIONS, INC., NORTH SYRACUSE, NY. FILED 4-20-2007.

HEPAiRx

THE MARK CONSISTS OF STANDARD CHARACTERS WITHOUT CLAIM TO ANY PARTICULAR FONT, STYLE, SIZE, OR COLOR.

OWNER OF U.S. REG. NO. 2,199,003.
FOR PORTABLE FLOOR-MOUNTED ROOM AIR CONDITIONER WITH INTEGRATED ENERGY RECOVERY VENTILATION AND HIGH EFFICIENCY PARTICULATE AIR FILTER (U.S. CLS. 13, 21, 23, 31 AND 34).
NORA BUCHANAN WILL, EXAMINING ATTORNEY

CLASS 11—(Continued).

SN 77-161,506. TIMBERTECH LIMITED, WILMINGTON, OH. FILED 4-20-2007.

DeckLites

NO CLAIM IS MADE TO THE EXCLUSIVE RIGHT TO USE DECK LIGHTS, APART FROM THE MARK AS SHOWN.

THE MARK CONSISTS OF THE WORDS DECKLITES WITH A LIGHT AND BEAMS OF LIGHT DOTTING THE "I" IN LITES.

FOR LOW VOLTAGE ELECTRIC LIGHTING FIXTURES (U.S. CLS. 13, 21, 23, 31 AND 34).
DAVID H. STINE, EXAMINING ATTORNEY

SN 77-173,432. KOHLER CO., KOHLER, WI. FILED 5-4-2007.

SPRING TIDES

THE MARK CONSISTS OF STANDARD CHARACTERS WITHOUT CLAIM TO ANY PARTICULAR FONT, STYLE, SIZE, OR COLOR.

FOR TOILET SEATS (U.S. CLS. 13, 21, 23, 31 AND 34).
NAPOLEON SHARMA, EXAMINING ATTORNEY

SN 77-173,444. KOHLER CO., KOHLER, WI. FILED 5-4-2007.

AUTUMN TIDES

THE MARK CONSISTS OF STANDARD CHARACTERS WITHOUT CLAIM TO ANY PARTICULAR FONT, STYLE, SIZE, OR COLOR.

FOR TOILET SEATS (U.S. CLS. 13, 21, 23, 31 AND 34).
NAPOLEON SHARMA, EXAMINING ATTORNEY

CLASS 11—(Continued).

SN 77-195,471. STUDIO ITALIA DESIGN USA, LLC, MIAMI, FL. FILED 6-1-2007.



NO CLAIM IS MADE TO THE EXCLUSIVE RIGHT TO USE "ITALIA DESIGN", APART FROM THE MARK AS SHOWN.

THE COLOR(S) RED AND WHITE IS/ARE CLAIMED AS A FEATURE OF THE MARK.

THE MARK CONSISTS OF A RED SQUARE WITH THE WORDS "STUDIO" "ITALIA" AND "DESIGN" IN WHITE. THE WORDS "STUDIO" AND "ITALIA" AND UNDERLINED BY A THIN WHITE LINE.

FOR PORTABLE, TABLE AND FLOOR LAMPS; LIGHTING FIXTURES; ELECTRIC LIGHTING FIXTURES, NAMELY, SCONCES (U.S. CLS. 13, 21, 23, 31 AND 34).

WILLIAM P. SHANAHAN, EXAMINING ATTORNEY

SN 78-397,685. PLUGG LTD, LONDON, UNITED KINGDOM, FILED 4-7-2004.

PLUGG

THE MARK CONSISTS OF STANDARD CHARACTERS WITHOUT CLAIM TO ANY PARTICULAR FONT, STYLE, SIZE, OR COLOR.

PRIORITY CLAIMED UNDER SEC. 44(D) ON ERPNTY TM OFC APPLICATION NO. 3755725, FILED 4-6-2004, REG. NO. 3755725, DATED 4-6-2004, EXPIRES 4-6-2014.

FOR APPARATUS FOR LIGHTING, NAMELY, LASER LIGHT PROJECTORS; DECORATIVE LAMPS; LASER LAMPS; LAMPS WHICH PROJECT LIGHT USING LASERS; LAMPS WHICH PROJECT LIGHT USING LEDS (LIGHT EMITTING DIODES), LAMPS WHICH PROJECT LIGHT USING CRYSTALS, AND LAMPS WHICH PROJECT LIGHT USING HOLOGRAPHS; LAMPS AND LIGHTS WHICH GENERATE LASER EFFECTS; LIGHT DIFFUSERS; PARTS AND FITTINGS FOR ALL THE AFORESAID GOODS (U.S. CLS. 13, 21, 23, 31 AND 34).

KATHRYN COWARD, EXAMINING ATTORNEY

CLASS 11—(Continued).

SN 78-703,662. HYDROKLEEN SYSTEMS INC., PORTERVILLE, CA. FILED 8-30-2005.

HYDROKLEEN

THE MARK CONSISTS OF STANDARD CHARACTERS WITHOUT CLAIM TO ANY PARTICULAR FONT, STYLE, SIZE, OR COLOR.

FOR WATER FILTERS USED TO FILTER OUT MINOR IMPURITIES TO MAINTAIN CLEANER WATER, STRICTLY FOR HOUSEHOLD USE (U.S. CLS. 13, 21, 23, 31 AND 34).

FIRST USE 1-5-1969; IN COMMERCE 7-18-1970.
KRISTIN DAHLING, EXAMINING ATTORNEY

SN 78-750,961. BSH BOSCH UND SIEMENS HAUSGERAETE GMBH, MUNICH, FED REP GERMANY, FILED 11-10-2005.

LIFTMATIC

THE MARK CONSISTS OF STANDARD CHARACTERS WITHOUT CLAIM TO ANY PARTICULAR FONT, STYLE, SIZE, OR COLOR.

PRIORITY CLAIMED UNDER SEC. 44(D) ON FED REP GERMANY APPLICATION NO. 30527579.8/0, FILED 5-12-2005, REG. NO. 30527579, DATED 6-20-2005, EXPIRES 5-31-2015.

FOR HOUSEHOLD AND KITCHEN MACHINES AND EQUIPMENT, NAMELY, HEATING, STEAM PRODUCING, AND COOKING DEVICES, NAMELY, COOKING, BAKING, FRYING, GRILLING, THAWING, AND HOT KEEPING APPARATUS, NAMELY, DOMESTIC COOKING OVENS, ELECTRIC AND GAS RANGES, COOK TOPS; REPLACEMENT PARTS OF ALL AFOREMENTIONED GOODS (U.S. CLS. 13, 21, 23, 31 AND 34).

VIVIAN MICZNIK FIRST, EXAMINING ATTORNEY

SN 78-944,942. RSGA INTERNATIONAL, INC., OGDEN, UT. FILED 8-4-2006.

FIREFLY

THE MARK CONSISTS OF STANDARD CHARACTERS WITHOUT CLAIM TO ANY PARTICULAR FONT, STYLE, SIZE, OR COLOR.

FOR LOW VOLTAGE ELECTRIC LIGHTS FOR USE IN TENTS, BATHROOMS, VEHICLES, OUTDOOR SHELTERS, AND OUTDOOR STRUCTURES (U.S. CLS. 13, 21, 23, 31 AND 34).

ANTHONY RINKER, EXAMINING ATTORNEY

CLASS 11—(Continued).

SN 78-944,967. RSGA INTERNATIONAL, INC., OGDEN, UT. FILED 8-4-2006.

PRE-LIT BY FIREFLY

THE MARK CONSISTS OF STANDARD CHARACTERS WITHOUT CLAIM TO ANY PARTICULAR FONT, STYLE, SIZE, OR COLOR.

NO CLAIM IS MADE TO THE EXCLUSIVE RIGHT TO USE "PRE-LIT", APART FROM THE MARK AS SHOWN.

FOR LOW VOLTAGE ELECTRIC LIGHTS FOR USE IN TENTS, BATHROOMS, VEHICLES, OUTDOOR SHELTERS, AND OUTDOOR STRUCTURES (U.S. CLS. 13, 21, 23, 31 AND 34).

ANTHONY RINKER, EXAMINING ATTORNEY

SN 78-955,740. SANRIO COMPANY, LTD., TOKYO, JAPAN, FILED 8-18-2006.

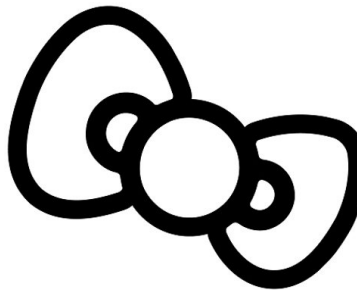

OWNER OF U.S. REG. NOS. 1,200,083, 1,370,105 AND OTHERS.

THE MARK CONSISTS OF A BOW.

FOR ELECTRIC NIGHT LIGHTS, ELECTRIC HOLIDAY LIGHTS, BICYCLE LIGHTS, PEN LIGHTS, FLASHLIGHTS, FLASHLIGHTS INCORPORATING KEY CHAINS, LAMPS, LAMP SHADES, ELECTRIC HOT AIR HAIR DRYERS, HAND HELD ELECTRIC HAIR DRYERS, MICROWAVE OVENS, ELECTRIC WAFFLE MAKERS, ELECTRIC SANDWICH MAKERS, ELECTRIC RICE COOKERS, ELECTRIC TOASTERS, ELECTRIC TOASTER OVENS, ELECTRIC COFFEE MAKERS, ELECTRIC COOKING POTS, ELECTRIC POPCORN POPPERS, SNOW CONE MAKING MACHINES, COTTON CANDY MAKING MACHINES, ELECTRIC FANS, TOILET TRAINING SEATS; ELECTRIC LIGHTS FOR USE IN VEHICLE DASHBOARDS (U.S. CLS. 13, 21, 23, 31 AND 34).

FIRST USE 11-1-2004; IN COMMERCE 11-1-2004.
REGINA DRUMMOND, EXAMINING ATTORNEY

CLASS 11—(Continued).

SN 78-972,555. LF, LLC, WILMINGTON, DE. FILED 9-12-2006.

COMFORT WIDTH

THE MARK CONSISTS OF STANDARD CHARACTERS WITHOUT CLAIM TO ANY PARTICULAR FONT, STYLE, SIZE, OR COLOR.

NO CLAIM IS MADE TO THE EXCLUSIVE RIGHT TO USE "WIDTH", APART FROM THE MARK AS SHOWN.

FOR TOILETS AND TOILET SEATS (U.S. CLS. 13, 21, 23, 31 AND 34).

WARREN L. OLANDRIA, EXAMINING ATTORNEY

SN 79-035,136. COTTONI GABRIELE, ITALY, FILED 1-19-2007.



PRIORITY DATE OF 11-24-2006 IS CLAIMED.

OWNER OF INTERNATIONAL REGISTRATION 0915221 DATED 1-19-2007, EXPIRES 1-19-2017.

"THE COLOR(S) BRIGHT ORANGE, BLACK AND WHITE IS/ARE CLAIMED AS A FEATURE OF THE MARK."

THE COLOR BLACK: THE WORD DLU; THE COLOR BRIGHT ORANGE: THE BACKGROUND AND PART OF THE GLOBE; THE COLOR WHITE: PART OF THE GLOBE.

"THE MARK CONSISTS OF THE TERM DLU TO THE LEFT OF A GLOBE DESIGN. THE WORDING AND THE GLOBE DESIGN APPEAR INSIDE A RECTANGLE."

FOR APPARATUS FOR LIGHTING, NAMELY, ELECTRIC LIGHT BULBS AND LAMPS, INCANDESCENT LIGHT BULBS AND LAMPS, HALOGEN LIGHT BULBS AND LAMPS, FLUORESCENT ELECTRIC BULBS AND LAMPS, FLUORESCENT LIGHTING TUBES, LAMP REFLECTORS (U.S. CLS. 13, 21, 23, 31 AND 34).

SETH A. RAPPAPORT, EXAMINING ATTORNEY

CLASS 12—VEHICLES

SN 76-666,156. STUDEBAKER, ROBERT L., JR., BIXBY, OK. FILED 9-15-2006.

ORANGE OX

THE MARK CONSISTS OF STANDARD CHARACTERS WITHOUT CLAIM TO ANY PARTICULAR FONT, STYLE, SIZE, OR COLOR.

NO CLAIM IS MADE TO THE EXCLUSIVE RIGHT TO USE "ORANGE", APART FROM THE MARK AS SHOWN.

FOR HAY TRAILER (U.S. CLS. 19, 21, 23, 31, 35 AND 44).

FIRST USE 5-23-2001; IN COMMERCE 4-1-2002.

MICHAEL LITZAU, EXAMINING ATTORNEY

CLASS 12—(Continued).

SN 76-674,894. HYDROID, LLC, POCASSET, MA. FILED 4-2-2007.

HYDROID

THE MARK CONSISTS OF STANDARD CHARACTERS WITHOUT CLAIM TO ANY PARTICULAR FONT, STYLE, SIZE, OR COLOR.

FOR UNMANNED AUTONOMOUS UNDERWATER VEHICLES AND THEIR PARTS AND FITTINGS (U.S. CLS. 19, 21, 23, 31, 35 AND 44).

FIRST USE 10-29-2002; IN COMMERCE 10-29-2002.

H. M. FISHER, EXAMINING ATTORNEY

SN 77-009,818. WALLER, JAMES A., PHOENIX, NY. FILED 9-28-2006.

AJS

THE MARK CONSISTS OF STANDARD CHARACTERS WITHOUT CLAIM TO ANY PARTICULAR FONT, STYLE, SIZE, OR COLOR.

FOR MOTORCYCLES; MOTORCYCLE ENGINES; MOTORCYCLE STRUCTURAL PARTS, NAMELY, UPPER FORK BRACKETS, FRONT FORK BRACKETS, ADJUSTABLE FRONT FORK BRACKETS, REAR FORKS, REAR FORK PROTECTOR PLATES, UNDER SEAT FRAME COVERS, REAR FENDER BRACES; MOTORCYCLE STRUCTURAL PARTS IN THE NATURE FOOTRESTS, NAMELY, HIGHWAY BARS AND FLIP UP FOOTBOARDS, STANDS, REAR BUMPER, AND HANDLEBAR RISER ADAPTORS; MOTORCYCLE TRANSMISSION PARTS, NAMELY, FORWARD CONTROLS AND FORWARD CONTROL SHIFTERS, FILL PLUGS WITH DIP STICKS, TRANSMISSION COVERS AND MOUNTS, PRIMARY DRIVE COVERS, CRANK CASE COVERS; MOTORCYCLE BRAKE LINE FITTINGS, NAMELY, BRACKETS AND GUIDES, REAR BRAKE FITTINGS, CALIPER COVERS, FRONT BRAKE DISC COVERS; AND KNURLED VALVE STEM CAPS FOR VEHICLE TIRES (U.S. CLS. 19, 21, 23, 31, 35 AND 44).

TONI HICKEY, EXAMINING ATTORNEY

CLASS 12—(Continued).

SN 77-014,476. MONTAGUE INVENTIVE TECHNOLOGIES, INC., CAMBRIDGE, MA. FILED 10-5-2006.

CLIX

THE MARK CONSISTS OF STANDARD CHARACTERS WITHOUT CLAIM TO ANY PARTICULAR FONT, STYLE, SIZE, OR COLOR.

FOR BICYCLE WHEELS FEATURING A QUICK-RELEASE LEVER; BICYCLE PARTS, NAMELY, FORKS FEATURING A QUICK-RELEASE LEVER FOR WHEELS (U.S. CLS. 19, 21, 23, 31, 35 AND 44).

REBECCA EISINGER, EXAMINING ATTORNEY

SN 77-014,728. RAMM, SHARALYN S., EDMONDS, WA. FILED 10-5-2006.

TURNING LEG CADDY

THE MARK CONSISTS OF STANDARD CHARACTERS WITHOUT CLAIM TO ANY PARTICULAR FONT, STYLE, SIZE, OR COLOR.

NO CLAIM IS MADE TO THE EXCLUSIVE RIGHT TO USE "TURNING", APART FROM THE MARK AS SHOWN.

FOR NON-MOTORIZED SCOOTERS, NAMELY, KNEE SCOOTERS AND KNEE WALKERS (U.S. CLS. 19, 21, 23, 31, 35 AND 44).

FIRST USE 12-31-2005; IN COMMERCE 12-31-2005.

FLORENTINA BLANDU, EXAMINING ATTORNEY

SN 77-080,694. MAXI MILIAAN B.V., HELMOND, NETHERLANDS, FILED 1-11-2007.

MAXI-COSI MICO

THE MARK CONSISTS OF STANDARD CHARACTERS WITHOUT CLAIM TO ANY PARTICULAR FONT, STYLE, SIZE, OR COLOR.

OWNER OF U.S. REG. NOS. 2,721,687 AND 3,206,453.

FOR BABY CARRIAGES, NAMELY, PUSHCHAIRS, BUGGIES, PRAMS AND STRUCTURAL PARTS THEREFOR; SAFETY SEATS FOR CHILDREN AND BABIES FOR USE IN AND ON VEHICLES FOR TRANSPORT BY LAND, AIR AND WATER, PARTS THEREFOR SOLD AS A UNIT WITH THE GOODS; SAFETY BELTS FOR VEHICLE SEATS FOR CHILDREN AND ADULTS; WHEELED SUPPORTS FOR CAR SEATS FOR CHILDREN AND BABIES FOR USE AS A STROLLER; FITTED COVERS AND INSERTS ADAPTED FOR CAR SEATS (U.S. CLS. 19, 21, 23, 31, 35 AND 44).

AMY BROZENIC, EXAMINING ATTORNEY

CLASS 12—(Continued).

SN 77-102,739. DEERE & COMPANY, MOLINE, IL. FILED 2-8-2007.

AUTOTRAC

THE MARK CONSISTS OF STANDARD CHARACTERS WITHOUT CLAIM TO ANY PARTICULAR FONT, STYLE, SIZE, OR COLOR.

FOR STEERING SYSTEMS FOR LAND VEHICLES COMPRISED OF HYDROSTATIC STEERING CONTROL UNIT AND ASSISTED BY GLOBAL POSITIONING SYSTEM RECEIVER (U.S. CLS. 19, 21, 23, 31, 35 AND 44).

CHRISTOPHER OTT, EXAMINING ATTORNEY

SN 77-111,507. ANNWIL, INC., TAMPA, FL. FILED 2-20-2007.

ULTRA SEAL

THE MARK CONSISTS OF STANDARD CHARACTERS WITHOUT CLAIM TO ANY PARTICULAR FONT, STYLE, SIZE, OR COLOR.

NO CLAIM IS MADE TO THE EXCLUSIVE RIGHT TO USE "SEAL", APART FROM THE MARK AS SHOWN.

FOR ENCLOSURES FOR MOTORIZED GOLF CARTS IN THE NATURE OF FITTED AND SEMI-FITTED COVERS. (U.S. CLS. 19, 21, 23, 31, 35 AND 44).

WILLIAM P. SHANAHAN, EXAMINING ATTORNEY

SN 77-113,576. JOHN W. SPICER, BURNSVILLE, MN. FILED 2-22-2007.

MONKEYRACK

THE MARK CONSISTS OF STANDARD CHARACTERS WITHOUT CLAIM TO ANY PARTICULAR FONT, STYLE, SIZE, OR COLOR.

FOR HITCH ACCESSORIES, NAMELY, ATTACHMENTS FOR MOUNTING EXTENSION LADDERS ON RECEIVER HITCHES OF PICK-UP TRUCKS AND SPORT UTILITY VEHICLES, AND REPLACEMENT PARTS THEREFOR (U.S. CLS. 19, 21, 23, 31, 35 AND 44).

INGA ERVIN, EXAMINING ATTORNEY

CLASS 12—(Continued).

SN 77-138,208. OTIS, WEBSTER, STINSON BEACH, CA.
FILED 3-22-2007.

SIT-N-SCOOT

THE MARK CONSISTS OF STANDARD CHARACTERS WITHOUT CLAIM TO ANY PARTICULAR FONT, STYLE, SIZE, OR COLOR.

FOR NON-MOTORIZED 2 WHEELED SCOOTERS WITH ADJUSTABLE SEAT AND HAND BRAKE (U.S. CLS. 19, 21, 23, 31, 35 AND 44).

CHERYL CLAYTON, EXAMINING ATTORNEY

SN 77-142,825. VELOTEQ CORPORATION, HOUSTON, TX.
FILED 3-28-2007.

VELOTEQ

THE MARK CONSISTS OF STANDARD CHARACTERS WITHOUT CLAIM TO ANY PARTICULAR FONT, STYLE, SIZE, OR COLOR.

FOR ELECTRIC MOTORIZED BICYCLES (U.S. CLS. 19, 21, 23, 31, 35 AND 44).

FIRST USE 11-1-2006; IN COMMERCE 11-1-2006.
MICHAEL WEBSTER, EXAMINING ATTORNEY

SN 77-151,464. YONGFANG, GUO, WEIHAI CITY, CHINA,
FILED 4-9-2007.

DURATOUGH

THE MARK CONSISTS OF 'DURATOUGH' WITH STY-
LIZED LETTERS D AND O.

FOR INNER TUBES; INNER TUBES FOR VEHICLE TIRES; TIRES; TIRES FOR LAND VEHICLES; TREAD USED TO RETREAD TIRES; TREADS FOR RETREADING TIRES FOR CIVIL ENGINEERING VEHICLES; TREADS FOR RETREADING TIRES FOR FORESTRY VEHICLES; TREADS FOR RETREADING TIRES FOR VEHICLES USED IN THE CIVIL ENGINEERING INDUSTRY; TIRES AND INNER TUBES FOR THE WHEELS OF FORESTRY VEHICLES (U.S. CLS. 19, 21, 23, 31, 35 AND 44).

JOHN WILKE, EXAMINING ATTORNEY

CLASS 12—(Continued).

SN 77-152,970. ADVANCED TRANSIT DYNAMICS, INC.,
NORWICH, VT. FILED 4-10-2007.

TRAILERTAIL

THE MARK CONSISTS OF STANDARD CHARACTERS WITHOUT CLAIM TO ANY PARTICULAR FONT, STYLE, SIZE, OR COLOR.

FOR AERODYNAMIC FAIRINGS FOR VEHICLES (U.S. CLS. 19, 21, 23, 31, 35 AND 44).

TONJA GASKINS, EXAMINING ATTORNEY

SN 77-153,832. SEASWIRL BOATS, INC., CULVER, OR.
FILED 4-11-2007.

REEL INNOVATIVE

THE MARK CONSISTS OF STANDARD CHARACTERS WITHOUT CLAIM TO ANY PARTICULAR FONT, STYLE, SIZE, OR COLOR.

FOR BOATS AND STRUCTURAL PARTS THEREFOR (U.S. CLS. 19, 21, 23, 31, 35 AND 44).

MATTHEW PAPPAS, EXAMINING ATTORNEY

SN 77-155,467. ADVANCED ELEMENTS, INC., CONCORD,
CA. FILED 4-12-2007.

ADVANCED ELEMENTS

THE MARK CONSISTS OF STANDARD CHARACTERS WITHOUT CLAIM TO ANY PARTICULAR FONT, STYLE, SIZE, OR COLOR.

FOR KAYAKS (U.S. CLS. 19, 21, 23, 31, 35 AND 44).

AMY MCMENAMIN, EXAMINING ATTORNEY

CLASS 12—(Continued).

SN 77-155,470. ADVANCED ELEMENTS, INC., CONCORD, CA. FILED 4-12-2007.

BACKBONE

THE MARK CONSISTS OF STANDARD CHARACTERS WITHOUT CLAIM TO ANY PARTICULAR FONT, STYLE, SIZE, OR COLOR.

FOR STRUCTURAL BRACING FOR INFLATABLE KAYAKS (U.S. CLS. 19, 21, 23, 31, 35 AND 44).
AMY MCMENAMIN, EXAMINING ATTORNEY

SN 77-155,582. DOTY, GEORGE, INGLEWOOD, CA. FILED 4-12-2007.

CRAZY HORSE

THE MARK CONSISTS OF WORDS CRAZY AND HORSE, ALL UPPERCASE LETTER HEIGHT INCREASING FROM THE C IN CRAZY TO E AT THE END OF HORSE.

FOR RACING CARS; RACING MOTOR CARS (U.S. CLS. 19, 21, 23, 31, 35 AND 44).

FIRST USE 6-1-2004; IN COMMERCE 6-1-2004.
SAMUEL E. SHARPER JR., EXAMINING ATTORNEY

SN 77-155,812. HAULMAX TRAILER COMPANY, LLC, ELKHART, IN. FILED 4-13-2007.

HAULMAX

THE MARK CONSISTS OF STANDARD CHARACTERS WITHOUT CLAIM TO ANY PARTICULAR FONT, STYLE, SIZE, OR COLOR.

FOR CARGO TRAILERS (U.S. CLS. 19, 21, 23, 31, 35 AND 44).

KIMBERLY PERRY, EXAMINING ATTORNEY

CLASS 12—(Continued).

SN 77-156,172. FEDERAL CORPORATION, TAOYUAN, TAIWAN, FILED 4-13-2007.



THE COLOR(S) BLACK, WHITE, GREY, RED, GREEN AND BEIGE IS/ARE CLAIMED AS A FEATURE OF THE MARK.

THE MARK CONSISTS OF A CARTOON CHARACTER, WHICH IS OUTLINED IN BLACK, WITH WHITE GLOVED HANDS, A LARGE, OVAL, LIGHT BEIGE OR FLESH COLORED FACE, BLACK EARS, AND BLACK LINES FOR EYES AND MOUTH. THE TOP OF THE CHARACTER'S HEAD IS LIGHT GREY, WITH A DARK GREY AND BLACK STRIP OF HAIR DOWN THE MIDDLE. THE CHARACTER IS WEARING A RED, WHITE AND GREEN JUMP SUIT, WITH RED DOWN THE CENTER, A THIN WHITE STRIPE AND A GREEN STRIPE EXTENDING TO THE EACH SHOULDER ON BOTH SIDES, AND RED SHIRT CUFFS AND FEET. THE CHARACTER IS STANDING WITH FEET APART, WITH ONE ARM OUTSTRETCHED AND THE OTHER BENT, WITH BOTH HANDS MAKING A THUMPS-UP GESTURE.

FOR TIRES FOR VEHICLES; TIRES FOR AUTOMOBILES AND MOTORCYCLES (U.S. CLS. 19, 21, 23, 31, 35 AND 44).

JEFF DEFORD, EXAMINING ATTORNEY

SN 77-156,650. ENERGYTECH MARINE GROUP, LLC, CHULA VISTA, CA. FILED 4-13-2007.

EnergyTech

THE MARK CONSISTS OF STANDARD CHARACTERS WITHOUT CLAIM TO ANY PARTICULAR FONT, STYLE, SIZE, OR COLOR.

FOR BOATS AND STRUCTURAL PARTS THEREFOR (U.S. CLS. 19, 21, 23, 31, 35 AND 44).

FIRST USE 10-25-2006; IN COMMERCE 10-25-2006.
KEVIN CORWIN, EXAMINING ATTORNEY

CLASS 12—(Continued).

SN 77-157,794. FLEETWOOD ENTERPRISES, INC., RIVERSIDE, CA. FILED 4-16-2007.

AMERICAN ALLEGIANCE

THE MARK CONSISTS OF STANDARD CHARACTERS WITHOUT CLAIM TO ANY PARTICULAR FONT, STYLE, SIZE, OR COLOR.

OWNER OF U.S. REG. NOS. 1,759,144, 2,318,980 AND OTHERS.
FOR MOTOR HOMES (U.S. CLS. 19, 21, 23, 31, 35 AND 44).

PATRICIA EVANKO, EXAMINING ATTORNEY

SN 77-158,341. TREPPA, KEVIN ENZO, GILBERT, AZ. FILED 4-17-2007.



NO CLAIM IS MADE TO THE EXCLUSIVE RIGHT TO USE "BUGGY" AND "A BABY STROLLER WHEEL COVER", APART FROM THE MARK AS SHOWN.

THE COLOR(S) WHITE TO SKY BLUE GRADIENT, PURPLE, TAN, BLACK, WHITE TO 20% GREY GRADIENT, YELLOW, AND BURNT ORANGE IS/ARE CLAIMED AS A FEATURE OF THE MARK.

THE COLOR SKY BLUE APPEARS IN THE WORDING BUGGY BOTTOMS. THE COLORS PURPLE AND TAN APPEAR IN THE OUTLINE OF THE WORDING BUGGY BOTTOMS. THE COLOR BLACK APPEARS IN THE WORDING A BABY STROLLER WHEEL COVER. THE COLORS WHITE AND GREY APPEAR IN THE CLOUD BEHIND THE WORDING BUGGY BOTTOMS. THE COLOR YELLOW APPEARS IN THE DESIGN OF THE SUN BEHIND THE CLOUD. THE COLOR BURNT ORANGE APPEARS IN THE OUTLINE OF THE SUN.

FOR COVERS FOR BABY STROLLERS (U.S. CLS. 19, 21, 23, 31, 35 AND 44).

JANET LEE, EXAMINING ATTORNEY

SN 77-158,421. INTERNATIONAL E-Z UP, INC., RIVERSIDE, CA. FILED 4-17-2007.

E-Z UP STOW & GROW

THE MARK CONSISTS OF STANDARD CHARACTERS WITHOUT CLAIM TO ANY PARTICULAR FONT, STYLE, SIZE, OR COLOR.

FOR PORTABLE GARDEN CARTS WITH STORAGE CAPACITY (U.S. CLS. 19, 21, 23, 31, 35 AND 44).

KATHLEEN M. VANSTON, EXAMINING ATTORNEY

CLASS 12—(Continued).

SN 77-158,708. KIND BICYCLES LLC, JANESVILLE, WI. FILED 4-17-2007.

KIND BICYCLES

THE MARK CONSISTS OF STANDARD CHARACTERS WITHOUT CLAIM TO ANY PARTICULAR FONT, STYLE, SIZE, OR COLOR.

NO CLAIM IS MADE TO THE EXCLUSIVE RIGHT TO USE "BICYCLES", APART FROM THE MARK AS SHOWN.

FOR BICYCLE FRAMES; BICYCLE PARTS, NAMELY, BRAKE SHOES; BICYCLE PARTS, NAMELY, CHANGE-SPEED GEARS; BICYCLE PARTS, NAMELY, DISK WHEELS; BICYCLE PARTS, NAMELY, DRIVE CHAINS; BICYCLE PARTS, NAMELY, DRIVE TRAINS; BICYCLE PARTS, NAMELY, FORK CROWN COVERS; BICYCLE PARTS, NAMELY, FORKS; BICYCLE PARTS, NAMELY, FRONT FORK JOINTS; BICYCLE PARTS, NAMELY, GEAR WHEELS; BICYCLE PARTS, NAMELY, HANDLE BAR ENDS; BICYCLE PARTS, NAMELY, HANDLE BAR STEMS; BICYCLE PARTS, NAMELY, SPROCKETS; BICYCLE PARTS, NAMELY, TUBES AND CONNECTORS FOR BICYCLE FRAMES; BICYCLE PEDALS; BICYCLE PUMPS; BICYCLE SADDLES; BICYCLE SEAT POSTS; BICYCLES (U.S. CLS. 19, 21, 23, 31, 35 AND 44).

GEOFFREY FOSDICK, EXAMINING ATTORNEY

SN 77-159,833. CORRENTE, CHRISTOPHER R., OCEANSIDE, CA. FILED 4-18-2007.



NO CLAIM IS MADE TO THE EXCLUSIVE RIGHT TO USE "USA", APART FROM THE MARK AS SHOWN.

THE MARK CONSISTS OF SCREWED, DOUBLE OVAL AROUND TEXT LEGACY POWERCYCLE USA.

FOR PARTS OF MOTORCYCLES, NAMELY, FRAMES, CHASSIS, TRANSMISSION BOXES, AND GAS TANKS (U.S. CLS. 19, 21, 23, 31, 35 AND 44).

JAMES A. RAÜEN, EXAMINING ATTORNEY

SN 77-160,431. KANEI INC., CHINO, CA. FILED 4-19-2007.

RAZE

THE MARK CONSISTS OF STANDARD CHARACTERS WITHOUT CLAIM TO ANY PARTICULAR FONT, STYLE, SIZE, OR COLOR.

FOR WHEELS FOR AUTOMOBILES (U.S. CLS. 19, 21, 23, 31, 35 AND 44).

KYLE PEETE, EXAMINING ATTORNEY

CLASS 12—(Continued).

SN 77-160,782. COUNTRY COACH LLC, JUNCTION CITY, OR. FILED 4-19-2007.

MAGNA

THE MARK CONSISTS OF STANDARD CHARACTERS WITHOUT CLAIM TO ANY PARTICULAR FONT, STYLE, SIZE, OR COLOR.

OWNER OF U.S. REG. NO. 2,133,616.
FOR MOTOR HOMES AND STRUCTURAL PARTS THEREFOR (U.S. CLS. 19, 21, 23, 31, 35 AND 44).
FIRST USE 7-3-1991; IN COMMERCE 7-3-1991.
SUSAN LESLIE DUBOIS, EXAMINING ATTORNEY

SN 77-161,093. DESALVO, MICHAEL, YUMA, AZ. FILED 4-19-2007.

MADE IN AMERICANA

THE MARK CONSISTS OF STANDARD CHARACTERS WITHOUT CLAIM TO ANY PARTICULAR FONT, STYLE, SIZE, OR COLOR.

FOR MOTORCYCLES (U.S. CLS. 19, 21, 23, 31, 35 AND 44).
JAY FLOWERS, EXAMINING ATTORNEY

SN 77-161,323. DAHON CALIFORNIA, INC., DUARTE, CA. FILED 4-19-2007.

ECOLOGIC

THE MARK CONSISTS OF STANDARD CHARACTERS WITHOUT CLAIM TO ANY PARTICULAR FONT, STYLE, SIZE, OR COLOR.

FOR BICYCLES (U.S. CLS. 19, 21, 23, 31, 35 AND 44).
KAREN SEVERSON, EXAMINING ATTORNEY

CLASS 12—(Continued).

SN 77-161,487. BRUNSWICK CORPORATION, LAKE FOREST, IL. FILED 4-20-2007.

SS

THE MARK CONSISTS OF STANDARD CHARACTERS WITHOUT CLAIM TO ANY PARTICULAR FONT, STYLE, SIZE, OR COLOR.

FOR PONTOON BOATS (U.S. CLS. 19, 21, 23, 31, 35 AND 44).
BARBARA A. LOUGHRAN, EXAMINING ATTORNEY

SN 77-161,595. TOTAL RESOURCES INTERNATIONAL, WALNUT, CA. FILED 4-20-2007.

CAR-GO KART

THE MARK CONSISTS OF STANDARD CHARACTERS WITHOUT CLAIM TO ANY PARTICULAR FONT, STYLE, SIZE, OR COLOR.

FOR COMPARTMENTALIZED ORGANIZER FOR THE TRUNK OF A MOTOR VEHICLE TO SEPARATE GROCERIES, TOOLS, SPORTING EQUIPMENT, AND OTHER MISCELLANEOUS ITEMS (U.S. CLS. 19, 21, 23, 31, 35 AND 44).
GIANCARLO CASTRO, EXAMINING ATTORNEY

SN 77-163,302. QIUPING, WANG, CITY OF INDUSTRY, CA. FILED 4-23-2007.

WOMOTO

THE MARK CONSISTS OF STANDARD CHARACTERS WITHOUT CLAIM TO ANY PARTICULAR FONT, STYLE, SIZE, OR COLOR.

FOR ALL-TERRAIN VEHICLES; ALL-TERRAIN, SELF-PROPELLED TRACKED CARRIERS; BRAKE DISCS; BRAKE DISCS FOR MOTORCYCLES; BRAKE DRUMS; DOLLIES; GO CARTS; GO-CARTS; GO-KART TRANSPORT TRUCKS; HAND TRUCKS; HANDLEBAR CONTROLS FOR MOPEDS; MOPEDS; MOTOR VEHICLE ALARM SYSTEMS; MOTORBIKES; MOTORCYCLE ACCESSORIES, NAMELY, FRONT AND SIDE PLATES; MOTORCYCLE ACCESSORIES, NAMELY, GAS TANK AND RADIATOR SHROUDS; MOTORCYCLE AND AUTOMOBILE STRUCTURAL PARTS, NAMELY, SUMP-GUARDS; MOTORCYCLE ENGINES; MOTORCYCLE GRIP TAPE; MOTORCYCLE KICKSTANDS; MINIBIKES; MOTORCYCLE PARTS, NAMELY, CHROMED SAFETY PADS; MOTORCYCLE PARTS, NAMELY, HEEL GUARDS; MOTORCYCLE SADDLEBAGS; MOTORCYCLE SIDECARS; MOTORCYCLE TRIKE CONVERSION KITS FOR CONVERTING A TWO-WHEELED MOTORCYCLE INTO A THREE-WHEELED MOTORCYCLE; MOTORCYCLES; MOTORCYCLES AND STRUCTURAL PARTS THEREFOR; MOTORCYCLES

CLASS 12—(Continued).

FOR MOTOCROSS; MOTORIZED AND COMPUTERIZED GOLF CARTS; MOTORIZED SCOOTERS; MOTORIZED VEHICLES, NAMELY, GO-CARTS; PARTS OF MOTORCYCLES, NAMELY, HANDLE BAR THROTTLES; PARTS OF MOTORCYCLES, NAMELY, BRAKE CABLES; PARTS OF MOTORCYCLES, NAMELY, BRAKE CALIPERS; PARTS OF MOTORCYCLES, NAMELY, BRAKE PEDALS; PARTS OF MOTORCYCLES, NAMELY, BRAKE ROTORS; PARTS OF MOTORCYCLES, NAMELY, CLUTCH CABLES; PARTS OF MOTORCYCLES, NAMELY, FORK BEARINGS AND RACES; PARTS OF MOTORCYCLES, NAMELY, FORK DUST BOOTS; PARTS OF MOTORCYCLES, NAMELY, FORK SEALS; PARTS OF MOTORCYCLES, NAMELY, FRONT DASH PANELS; PARTS OF MOTORCYCLES, NAMELY, FRONT SPACERS; PARTS OF MOTORCYCLES, NAMELY, HANDLE BAR CONTROL LEVERS; PARTS OF MOTORCYCLES, NAMELY, HANDLE BAR DAMPERS; PARTS OF MOTORCYCLES, NAMELY, HANDLE BAR GRIPS; PARTS OF MOTORCYCLES, NAMELY, HANDLE BARS; PARTS OF MOTORCYCLES, NAMELY, HEADLIGHT MOUNTS; PARTS OF MOTORCYCLES, NAMELY, SHIFT LEVERS; SCOOTERS; THREE-WHEELED MOTOR VEHICLES; TIRE LINERS; TIRE PATCHES; TIRE PUMPS; TIRE RETREADING CAPS; TIRE VALVES FOR VEHICLE TIRES; TIRES; TIRES; TIRES; TWO-WHEELED MOTOR VEHICLES (U.S. CLS. 19, 21, 23, 31, 35 AND 44).

ALICE BENMAMAN, EXAMINING ATTORNEY

SN 77-171,078. NAUTICA APPAREL, INC., NEW YORK, NY. FILED 5-2-2007.

NAUTICA

THE MARK CONSISTS OF STANDARD CHARACTERS WITHOUT CLAIM TO ANY PARTICULAR FONT, STYLE, SIZE, OR COLOR.

OWNER OF U.S. REG. NOS. 1,464,663, 3,233,030 AND OTHERS.

THE FOREIGN WORDING IN THE MARK TRANSLATES INTO ENGLISH AS "NAUTICAL."

FOR BOATS; RAFTS; CANOE PADDLES; CANOES; KAYAKS; DINGHIES (U.S. CLS. 19, 21, 23, 31, 35 AND 44).

DOMINIC J. FERRAIUOLO, EXAMINING ATTORNEY

SN 77-214,236. TOYOTA JIDOSHA KABUSHIKI KAISHA, TA TOYOTA MOTOR CORPORATION, TOYOTA-SHI, JAPAN, FILED 6-25-2007.

VAQUERO

THE MARK CONSISTS OF STANDARD CHARACTERS WITHOUT CLAIM TO ANY PARTICULAR FONT, STYLE, SIZE, OR COLOR.

FOR AUTOMOBILES AND STRUCTURAL PARTS THEREOF (U.S. CLS. 19, 21, 23, 31, 35 AND 44).

GEORGE LORENZO, EXAMINING ATTORNEY

CLASS 12—(Continued).

SN 78-298,285. BRIDGESTONE CORPORATION, TOKYO, JAPAN, FILED 9-10-2003.

NANOTIRE

FOR TIRES; WHEELS FOR LAND VEHICLES; INNER TUBES FOR VEHICLE TIRES; WHEEL RIMS FOR VEHICLES; RIMS FOR BICYCLE WHEELS; AND PARTS AND FITTINGS FOR ALL THE AFORESAID GOODS (U.S. CLS. 19, 21, 23, 31, 35 AND 44).

CHRISIE B. KING, EXAMINING ATTORNEY

SN 78-416,950. DNP, INC., BRASELTON, GA. FILED 5-11-2004.

PANOZ GFORCE

THE MARK CONSISTS OF STANDARD CHARACTERS WITHOUT CLAIM TO ANY PARTICULAR FONT, STYLE, SIZE, OR COLOR.

OWNER OF U.S. REG. NOS. 2,119,044 AND 2,299,170.

FOR AUTOMOBILE RACING CARS AND STRUCTURAL PARTS THEREFOR, AND RACING CAR CHASSIS (U.S. CLS. 19, 21, 23, 31, 35 AND 44).

FIRST USE 9-14-2002; IN COMMERCE 9-14-2002.

SCOTT BALDWIN, EXAMINING ATTORNEY

SN 78-811,588. DANE TECHNOLOGIES, INC., BROOKLYN PARK, MN. FILED 2-9-2006.



OWNER OF U.S. REG. NO. 2,440,712.

NO CLAIM IS MADE TO THE EXCLUSIVE RIGHT TO USE "TECHNOLOGIES", APART FROM THE MARK AS SHOWN.

FOR LAND VEHICLES AND STRUCTURAL PARTS THEREFOR; CARTS; HOSPITAL CARTS; MATERIAL HANDLING VEHICLES USED TO MOVE LOADS, MATERIALS, OR EQUIPMENT, NAMELY, POWER ASSIST CARTS, LIFT TRUCKS, PLATFORM TRUCKS, AND REACH TRUCKS; FORK LIFT TRUCK; AUTOMATIC GUIDED VEHICLES (AGVS); PERSONAL MOBILITY DEVICES, NAMELY, WHEELCHAIRS, MOTORIZED SCOOTERS, UTILITY CARTS, AND MOTORIZED, ELECTRIC-POWERED, SELF-PROPELLED, SELF-BALANCING, WHEELED PERSONAL MOBILITY, TRANSPORTATION CHARIOTS; SHOPPING CARTS; GROCERY CARTS (U.S. CLS. 19, 21, 23, 31, 35 AND 44).

HANNO RITTNER, EXAMINING ATTORNEY

CLASS 12—(Continued).

SN 78-811,608. DANE TECHNOLOGIES, INC., BROOKLYN PARK, MN. FILED 2-9-2006.

DANE TECHNOLOGIES

THE MARK CONSISTS OF STANDARD CHARACTERS WITHOUT CLAIM TO ANY PARTICULAR FONT, STYLE, SIZE, OR COLOR.

OWNER OF U.S. REG. NO. 2,440,712.

NO CLAIM IS MADE TO THE EXCLUSIVE RIGHT TO USE "TECHNOLOGIES", APART FROM THE MARK AS SHOWN.

FOR LAND VEHICLES AND STRUCTURAL PARTS THEREFOR; CARTS; HOSPITAL CARTS; MATERIAL HANDLING VEHICLES USED TO MOVE LOADS, MATERIALS, OR EQUIPMENT, NAMELY, POWER ASSIST CARTS, LIFT TRUCKS, PLATFORM TRUCKS, AND REACH TRUCKS; FORK LIFT TRUCK; AUTOMATIC GUIDED VEHICLES (AGVS); PERSONAL MOBILITY DEVICES, NAMELY, WHEELCHAIRS, MOTORIZED SCOOTERS, UTILITY CARTS, AND MOTORIZED, ELECTRIC-POWERED, SELF-PROPELLED, SELF-BALANCING, WHEELED PERSONAL MOBILITY, TRANSPORTATION CHARIOTS; SHOPPING CARTS; GROCERY CARTS (U.S. CLS. 19, 21, 23, 31, 35 AND 44).
HANNO RITTNER, EXAMINING ATTORNEY

SN 78-860,634. MACDON INDUSTRIES LTD., WINNIPEG, MANITOBA, CANADA, FILED 4-13-2006.



OWNER OF CANADA REG. NO. 694484, DATED 8-21-2007, EXPIRES 8-21-2022.

NO CLAIM IS MADE TO THE EXCLUSIVE RIGHT TO USE "DUAL DIRECTION", APART FROM THE MARK AS SHOWN.

FOR AGRICULTURAL EQUIPMENT, NAMELY, WINDROWER TRACTORS (U.S. CLS. 19, 21, 23, 31, 35 AND 44).

LANA PHAM, EXAMINING ATTORNEY

CLASS 12—(Continued).

SN 78-887,765. CYCLE GEAR, INC., BENICIA, CA. FILED 5-19-2006.

VAULT

THE MARK CONSISTS OF STANDARD CHARACTERS WITHOUT CLAIM TO ANY PARTICULAR FONT, STYLE, SIZE, OR COLOR.

FOR SECURITY AND ANTI-THEFT SYSTEMS FOR MOTORCYCLES, NAMELY, ANTI-THEFT WARNING APPARATUS FOR MOTORCYCLES, ALARM SYSTEMS FOR MOTORCYCLES, ANTI-THEFT LOCKS FOR MOTORCYCLES (U.S. CLS. 19, 21, 23, 31, 35 AND 44).

MATTHEW MCDOWELL, EXAMINING ATTORNEY

SN 78-901,202. QLINK, L.P., GRAPEVINE, TX. FILED 6-6-2006.



THE COLOR(S) RED AND GRAY ARE CLAIMED AS A FEATURE OF THE MARK.

THE COLOR RED REPRESENTS THE STYLIZED Q ENCIRCLED IN AN ELONGATED OVAL DESIGN AND GRAY REPRESENTS THE WORDING "Q LINK."

THE MARK CONSISTS OF A STYLIZED Q ENCIRCLED IN AN ELONGATED OVAL DESIGN SITUATED NEXT TO THE WORDING QLINK.

FOR MOTORCYCLES; MOTORIZED SCOOTERS (U.S. CLS. 19, 21, 23, 31, 35 AND 44).

FIRST USE 10-1-2005; IN COMMERCE 10-1-2005.

NAKIA HENRY, EXAMINING ATTORNEY

SN 78-926,503. DANE TECHNOLOGIES, INC., BROOKLYN PARK, MN. FILED 7-11-2006.

DANE

THE MARK CONSISTS OF STANDARD CHARACTERS WITHOUT CLAIM TO ANY PARTICULAR FONT, STYLE, SIZE, OR COLOR.

OWNER OF U.S. REG. NO. 2,440,712.

FOR LAND VEHICLES AND STRUCTURAL PARTS THEREFOR; CARTS; HOSPITAL CARTS; MATERIAL HANDLING VEHICLES USED TO MOVE LOADS, MATERIALS, OR EQUIPMENT, NAMELY, POWER ASSIST CARTS, LIFT TRUCKS, PLATFORM TRUCKS, AND REACH TRUCKS; FORK LIFT TRUCK; AUTOMATIC GUIDED VEHICLES (AGVS); PERSONAL MOBILITY DEVICES, NAMELY, WHEELCHAIRS, MOTORIZED SCOOTERS, UTILITY CARTS, AND MOTORIZED, ELECTRIC-POWERED, SELF-PROPELLED, SELF-BALANCING, WHEELED PERSONAL MOBILITY, TRANSPORTATION CHARIOTS; SHOPPING CARTS; GROCERY CARTS (U.S. CLS. 19, 21, 23, 31, 35 AND 44).

HANNO RITTNER, EXAMINING ATTORNEY

CLASS 12—(Continued).

SN 78-952,264. GOODYEAR TIRE & RUBBER COMPANY, THE, AKRON, OH. FILED 8-15-2006.

GOODYEAR

THE MARK CONSISTS OF STANDARD CHARACTERS WITHOUT CLAIM TO ANY PARTICULAR FONT, STYLE, SIZE, OR COLOR.

FOR BICYCLE TIRES AND BICYCLE TIRE REPAIR KITS COMPRISING PATCHES, TIRE PLUGS, TIRE BUFFER AND BICYCLE TIRE GLUE; BICYCLE TUBES AND BICYCLE TUBE REPAIR KITS COMPRISING PATCHES, METAL TUBE BUFFERS, AIR NEEDLE AND PRESTA VALVE; BICYCLE CHAINS AND BICYCLE CHAIN REPAIR KITS COMPRISING CHAIN BRUSH, DEGREASER, CHAIN LUBE, BICYCLE CHAIN LINKS TOOL AND CHAIN LINKS; AND BICYCLE PUMPS (U.S. CLS. 19, 21, 23, 31, 35 AND 44).
ALLISON HOLTZ, EXAMINING ATTORNEY

SN 79-029,819. VAN OOSSANEN & ASSOCIATES B.V., NETHERLANDS, FILED 9-8-2006.

HULL VANE

THE MARK CONSISTS OF STANDARD CHARACTERS WITHOUT CLAIM TO ANY PARTICULAR FONT, STYLE, SIZE, OR COLOR.

PRIORITY DATE OF 3-13-2006 IS CLAIMED.
OWNER OF INTERNATIONAL REGISTRATION 0900286 DATED 9-8-2006, EXPIRES 9-8-2016.

NO CLAIM IS MADE TO THE EXCLUSIVE RIGHT TO USE "HULL", APART FROM THE MARK AS SHOWN.

FOR SHIPS AND STRUCTURAL PARTS THEREOF (U.S. CLS. 19, 21, 23, 31, 35 AND 44).
TRICIA SONNEBORN, EXAMINING ATTORNEY

SN 79-036,648. DR. ING. H.C.F. PORSCHE AG, FED REP GERMANY, FILED 1-26-2007.

PDK

THE MARK CONSISTS OF STANDARD CHARACTERS WITHOUT CLAIM TO ANY PARTICULAR FONT, STYLE, SIZE, OR COLOR.

PRIORITY DATE OF 9-27-2006 IS CLAIMED.
OWNER OF INTERNATIONAL REGISTRATION 0919272 DATED 1-26-2007, EXPIRES 1-26-2017.

FOR AUTOMOBILES AND THEIR PARTS, NAMELY, CLUTCHES AND GEARBOXES (U.S. CLS. 19, 21, 23, 31, 35 AND 44).
ELI HELLMAN, EXAMINING ATTORNEY

CLASS 12—(Continued).

SN 79-036,747. PIRELLI TYRE S.P.A., ITALY, FILED 2-23-2007.

ASSOLUTO

THE MARK CONSISTS OF STANDARD CHARACTERS WITHOUT CLAIM TO ANY PARTICULAR FONT, STYLE, SIZE, OR COLOR.

PRIORITY DATE OF 12-5-2006 IS CLAIMED.
OWNER OF INTERNATIONAL REGISTRATION 0919646 DATED 2-23-2007, EXPIRES 2-23-2017.

"THE FOREIGN WORDING IN THE MARK TRANSLATES INTO ENGLISH AS ABSOLUTE."

FOR TYRES; PNEUMATIC, SEMI-PNEUMATIC AND SOLID TYRES FOR VEHICLE WHEELS; WHEELS FOR VEHICLES, WHEEL RIMS (U.S. CLS. 19, 21, 23, 31, 35 AND 44).
FLORENTINA BLANDU, EXAMINING ATTORNEY

CLASS 13—FIREARMS

SN 77-130,786. B.J. ALAN COMPANY, YOUNGSTOWN, OH. FILED 3-14-2007.

LOCO-LOCUSTS

THE MARK CONSISTS OF STANDARD CHARACTERS WITHOUT CLAIM TO ANY PARTICULAR FONT, STYLE, SIZE, OR COLOR.

FOR FIREWORKS (U.S. CLS. 2 AND 9).
FIRST USE 5-7-2003; IN COMMERCE 5-7-2003.
ELLEN B. AWRICH, EXAMINING ATTORNEY

SN 77-153,747. ACCU-LOCK PISTOLS, LLC, RINGGOLD, GA. FILED 4-11-2007.

ACCU-LOCK BY STRAHAN

THE MARK CONSISTS OF STANDARD CHARACTERS WITHOUT CLAIM TO ANY PARTICULAR FONT, STYLE, SIZE, OR COLOR.

FOR FIREARMS (U.S. CLS. 2 AND 9).
FIRST USE 7-0-2006; IN COMMERCE 7-0-2006.
B. PARADEWELAI, EXAMINING ATTORNEY

CLASS 13—(Continued).

SN 77-158,665. NEW WORLD MANUFACTURING, INC., CLOVERDALE, CA. FILED 4-17-2007.

E-Z BREACH

THE MARK CONSISTS OF STANDARD CHARACTERS WITHOUT CLAIM TO ANY PARTICULAR FONT, STYLE, SIZE, OR COLOR.

OWNER OF U.S. REG. NO. 3,264,835.

NO CLAIM IS MADE TO THE EXCLUSIVE RIGHT TO USE "BREACH", APART FROM THE MARK AS SHOWN.

FOR AN ACCESSORY FOR EXPLOSIVES, NAMELY, A FLUID-FILLED PROTECTIVE JACKET TO SHAPE AND DIRECT EXPLOSIVE CHARGES FOR BREACHING LOCKED DOORS (U.S. CLS. 2 AND 9).

FIRST USE 8-25-2006; IN COMMERCE 8-25-2006.

AMY ALFIERI, EXAMINING ATTORNEY

SN 77-158,864. ALLIANT TECHSYSTEMS INC., EDINA, MN. FILED 4-17-2007.



OWNER OF U.S. REG. NO. 2,051,560.

NO CLAIM IS MADE TO THE EXCLUSIVE RIGHT TO USE "OPTICS", APART FROM THE MARK AS SHOWN.

THE COLOR(S) BLACK, BROWN AND TAN IS/ARE CLAIMED AS A FEATURE OF THE MARK.

THE MARK CONSISTS OF THE STYLIZED DEPICTION OF THE NITREX OPTICS MARK AND ANTLER DESIGN, WHERE THE LETTERS NI IN NITREX, THE WORD OPTICS, AND THE SHADOWING OF THE WORDING NITREX OPTICS AND ANTLER DESIGN ARE IN THE COLOR BLACK, AND WHERE THE LETTERS TREX IN NITREX, THE DOT ABOVE THE LETTER I IN NITREX, AND THE ANTLER DESIGN ARE IN THE COLORS BROWN AND TAN.

FOR FIREARM SIGHTS (U.S. CLS. 2 AND 9).

LINDA M. KING, EXAMINING ATTORNEY

SN 78-816,835. BATTENFELD TECHNOLOGIES, INC., COLUMBIA, MO. FILED 2-16-2006.

LEGACY SERIES

THE MARK CONSISTS OF STANDARD CHARACTERS WITHOUT CLAIM TO ANY PARTICULAR FONT, STYLE, SIZE, OR COLOR.

NO CLAIM IS MADE TO THE EXCLUSIVE RIGHT TO USE "SERIES", APART FROM THE MARK AS SHOWN.

FOR GUNSTOCKS FOR USE IN THE MANUFACTURE AND REPAIR OF CENTERFIRE AND RIMFIRE FIREARMS (U.S. CLS. 2 AND 9).

SAMUEL E. SHARPER JR., EXAMINING ATTORNEY

CLASS 13—(Continued).

SN 78-960,118. CIMARRON FIREARMS CO. INC., FREDERICKSBURG, TX. FILED 8-24-2006.

Pistolero

THE MARK CONSISTS OF STANDARD CHARACTERS WITHOUT CLAIM TO ANY PARTICULAR FONT, STYLE, SIZE, OR COLOR.

SEC. 2(F).

FOR FIREARMS (U.S. CLS. 2 AND 9).

FIRST USE 1-1-1998; IN COMMERCE 3-1-1998.

GEORGIA CARTY, EXAMINING ATTORNEY

CLASS 14—JEWELRY

SN 77-018,946. WAL-MART STORES, INC., BENTONVILLE, AR. FILED 10-11-2006.

METRO 7

THE MARK CONSISTS OF STANDARD CHARACTERS WITHOUT CLAIM TO ANY PARTICULAR FONT, STYLE, SIZE, OR COLOR.

OWNER OF U.S. REG. NOS. 2,760,786, 3,222,155 AND OTHERS.

FOR JEWELRY; WATCHES (U.S. CLS. 2, 27, 28 AND 50).

JAMES MACFARLANE, EXAMINING ATTORNEY

SN 77-070,636. AEROPOSTALE WEST, INC., WAYNE, NJ. FILED 12-22-2006.

AEROPOSTALE

THE MARK CONSISTS OF STANDARD CHARACTERS WITHOUT CLAIM TO ANY PARTICULAR FONT, STYLE, SIZE, OR COLOR.

OWNER OF U.S. REG. NOS. 1,485,368, 1,548,372 AND OTHERS.

THE FOREIGN WORDING IN THE MARK TRANSLATES INTO ENGLISH AS AIR MAIL.

FOR JEWELRY AND WATCHES (U.S. CLS. 2, 27, 28 AND 50).

FIRST USE 6-1-2006; IN COMMERCE 6-1-2006.

BARBARA BROWN, EXAMINING ATTORNEY

CLASS 14—(Continued).

SN 77-113,386. CARLE, SALLY, VERMILION, OH. FILED 2-22-2007.

karmacraft

THE MARK CONSISTS OF STANDARD CHARACTERS WITHOUT CLAIM TO ANY PARTICULAR FONT, STYLE, SIZE, OR COLOR.

FOR BRACELETS; EARRINGS; NECKLACES (U.S. CLS. 2, 27, 28 AND 50).

FIRST USE 11-1-2005; IN COMMERCE 2-1-2006.

KIM SAITO, EXAMINING ATTORNEY

SN 77-123,423. ACCURIST WATCHES LIMITED, LONDON, UNITED KINGDOM, FILED 3-6-2007.



NO CLAIM IS MADE TO THE EXCLUSIVE RIGHT TO USE "COMMEMORATIVES", APART FROM THE MARK AS SHOWN.

FOR WATCHES, CLOCKS, WATCH BRACELETS AND WATCH STRAPS; HOROLOGICAL AND CHRONOMETRIC INSTRUMENTS AND PARTS AND FITTINGS THEREFOR (U.S. CLS. 2, 27, 28 AND 50).

AISHA CLARKE, EXAMINING ATTORNEY

SN 77-123,450. ACCURIST WATCHES LIMITED, LONDON, UNITED KINGDOM, FILED 3-6-2007.

THE GREENWICH
COMMEMORATIVE COLLECTION

THE MARK CONSISTS OF STANDARD CHARACTERS WITHOUT CLAIM TO ANY PARTICULAR FONT, STYLE, SIZE, OR COLOR.

NO CLAIM IS MADE TO THE EXCLUSIVE RIGHT TO USE "COMMEMORATIVE COLLECTION", APART FROM THE MARK AS SHOWN.

FOR WATCHES, CLOCKS, WATCH BRACELETS AND WATCH STRAPS; HOROLOGICAL AND CHRONOMETRIC INSTRUMENTS AND PARTS AND FITTINGS THEREFOR (U.S. CLS. 2, 27, 28 AND 50).

AISHA CLARKE, EXAMINING ATTORNEY

CLASS 14—(Continued).

SN 77-125,077. SORIANO, JESSE, IRVINE, CA. AND DALMACIO, MYLENE, IRVINE, CA. FILED 3-7-2007.

Daliano

THE MARK CONSISTS OF STANDARD CHARACTERS WITHOUT CLAIM TO ANY PARTICULAR FONT, STYLE, SIZE, OR COLOR.

FOR BEADS FOR USE IN THE MANUFACTURE OF JEWELRY; BRACELETS; BRONZE JEWELRY; BROOCHES; CHARMS; COSTUME JEWELRY; IDENTIFICATION BRACELETS; JEWELRY; JEWELRY BOXES; JEWELRY BOXES NOT OF METAL; JEWELRY BOXES OF METAL; JEWELRY BOXES OF PRECIOUS METAL; JEWELRY CASES; JEWELRY CASES NOT OF PRECIOUS METAL; JEWELRY CASES OF PRECIOUS METAL; JEWELRY CASKETS; JEWELRY CASKETS OF PRECIOUS METAL; JEWELRY CHAINS; JEWELRY FINDINGS; JEWELRY FOR THE HEAD; JEWELRY PINS FOR USE ON HATS; JEWELRY WATCHES; JEWELRY, NAMELY, AMULETS; JEWELRY, NAMELY, CROSSES; JEWELRY, NAMELY, PRECIOUS METAL PLATED REAL LEAVES AND FLOWERS; LAPEL PINS; LEATHER JEWELRY AND ACCESSORY BOXES; PET JEWELRY; PINS BEING JEWELRY; RINGS BEING JEWELRY (U.S. CLS. 2, 27, 28 AND 50).

NORA BUCHANAN WILL, EXAMINING ATTORNEY

SN 77-130,932. MOVADO LLC, WILMINGTON, DE. FILED 3-14-2007.

METIO

THE MARK CONSISTS OF STANDARD CHARACTERS WITHOUT CLAIM TO ANY PARTICULAR FONT, STYLE, SIZE, OR COLOR.

THE ENGLISH TRANSLATION OF THE WORD METIO IN THE MARK IS TO PUT.

FOR HOROLOGICAL AND CHRONOMETRIC INSTRUMENTS (U.S. CLS. 2, 27, 28 AND 50).

TONI HICKEY, EXAMINING ATTORNEY

SN 77-150,622. SLATER, BONITA, MESA, AZ. FILED 4-6-2007.

GOD CAN

THE MARK CONSISTS OF STANDARD CHARACTERS WITHOUT CLAIM TO ANY PARTICULAR FONT, STYLE, SIZE, OR COLOR.

FOR JEWELRY (U.S. CLS. 2, 27, 28 AND 50).

ELIZABETH KAJUBI, EXAMINING ATTORNEY

CLASS 14—(Continued).

SN 77-151,442. SHEN, RONG, SAN FRANCISCO, CA. FILED 4-8-2007.



THE COLOR(S) BLACK, WHITE, DARK BLUE, LIGHT BLUE, DARK RED IS/ARE CLAIMED AS A FEATURE OF THE MARK.

THE MARK CONSISTS OF TWO PHOENIXES IN DARK AND LIGHT BLUE COLOR FLANKING A SHIELD WITH A DARK RED DIAMOND ON THE BOTTOM AND "I WINGS" LETTERS ON TOP OF THE SHIELD.

FOR JEWELRY (U.S. CLS. 2, 27, 28 AND 50).
SANJEEV VOHRA, EXAMINING ATTORNEY

SN 77-153,492. WOLTER, KATHLEEN L., CHICAGO, IL. FILED 4-10-2007.

*Mother To Be
Celebration Pendant*

NO CLAIM IS MADE TO THE EXCLUSIVE RIGHT TO USE "MOTHER TO BE" AND "PENDANT", APART FROM THE MARK AS SHOWN.

FOR JEWELRY (U.S. CLS. 2, 27, 28 AND 50).
BENJAMIN OKEKE, EXAMINING ATTORNEY

SN 77-156,022. BLUE SKY (FAR EAST) LIMITED, KOW-LOON, HONG KONG, FILED 4-13-2007.

BSL

THE MARK CONSISTS OF STANDARD CHARACTERS WITHOUT CLAIM TO ANY PARTICULAR FONT, STYLE, SIZE, OR COLOR.

FOR ANKLE BRACELETS; BRACELETS; BRACELETS OF PRECIOUS METAL; BROOCHES; CHARMS; CHOKERS; CUFF-LINKS; DIAMONDS; EARRINGS; JEWELRY; NECKLACES; PENDANTS; RINGS BEING JEWELRY; WEDDING BANDS (U.S. CLS. 2, 27, 28 AND 50).

DANIEL RUSSELL, EXAMINING ATTORNEY

CLASS 14—(Continued).

SN 77-156,972. CELEB HOLDINGS LLC, NEW YORK, NY. FILED 4-15-2007.

Stars by Knight

THE MARK CONSISTS OF STANDARD CHARACTERS WITHOUT CLAIM TO ANY PARTICULAR FONT, STYLE, SIZE, OR COLOR.

FOR JEWELRY (U.S. CLS. 2, 27, 28 AND 50).
KATHLEEN M. VANSTON, EXAMINING ATTORNEY

SN 77-157,630. DEPLOY PEACE, LLC, TUCSON, AZ. FILED 4-16-2007.



THE MARK CONSISTS OF A PEACE SIGN COMPRISING A B-52 BOMBER. THE BODY AND WINGS OF THE B-52 BOMBER FORMING THE PEACE SIGN. THE OUTER CIRCLE INCLUDES THE WORDS DEPLOY PEACE..

FOR JEWELRY (U.S. CLS. 2, 27, 28 AND 50).
MICHAEL LITZAU, EXAMINING ATTORNEY

SN 77-157,847. SCOTT KAY, INC., TEANECK, NJ. FILED 4-16-2007.

DOBERMAN

THE MARK CONSISTS OF STANDARD CHARACTERS WITHOUT CLAIM TO ANY PARTICULAR FONT, STYLE, SIZE, OR COLOR.

FOR JEWELRY (U.S. CLS. 2, 27, 28 AND 50).
ANNE E. GUSTASON, EXAMINING ATTORNEY

CLASS 14—(Continued).

SN 77-158,234. ALFRED BUTLER, INC., NEW YORK, NY.
FILED 4-17-2007.

WHITER MEANS BRIGHTER

THE MARK CONSISTS OF STANDARD CHARACTERS
WITHOUT CLAIM TO ANY PARTICULAR FONT, STYLE,
SIZE, OR COLOR.

FOR JEWELRY (U.S. CLS. 2, 27, 28 AND 50).
JUDITH HELFMAN, EXAMINING ATTORNEY

SN 77-158,278. ALFRED BUTLER, INC., NEW YORK, NY.
FILED 4-17-2007.

WHITER MEANS BRILLIANT

THE MARK CONSISTS OF STANDARD CHARACTERS
WITHOUT CLAIM TO ANY PARTICULAR FONT, STYLE,
SIZE, OR COLOR.

FOR JEWELRY (U.S. CLS. 2, 27, 28 AND 50).
JUDITH HELFMAN, EXAMINING ATTORNEY

SN 77-158,324. GOLOVE, ROB, WINTERGARDEN, FL.
FILED 4-17-2007.

DADDY'S LITTLE GIRL

THE MARK CONSISTS OF STANDARD CHARACTERS
WITHOUT CLAIM TO ANY PARTICULAR FONT, STYLE,
SIZE, OR COLOR.

FOR JEWELRY (U.S. CLS. 2, 27, 28 AND 50).
FIRST USE 4-17-2007; IN COMMERCE 4-17-2007.
SARA THOMAS, EXAMINING ATTORNEY

SN 77-159,268. SAMUEL AARON, INC., LONG ISLAND
CITY, NY. FILED 4-18-2007.

PAST PRESENT FOREVER

THE MARK CONSISTS OF STANDARD CHARACTERS
WITHOUT CLAIM TO ANY PARTICULAR FONT, STYLE,
SIZE, OR COLOR.

OWNER OF U.S. REG. NO. 2,644,312.
FOR JEWELRY (U.S. CLS. 2, 27, 28 AND 50).
ELISSA GARBER KON, EXAMINING ATTORNEY

CLASS 14—(Continued).

SN 77-159,583. FIRESTONE, INC., NEW YORK, NY. FILED 4-
18-2007.

AMOR Y FE

THE MARK CONSISTS OF STANDARD CHARACTERS
WITHOUT CLAIM TO ANY PARTICULAR FONT, STYLE,
SIZE, OR COLOR.

THE FOREIGN WORDING IN THE MARK TRANSLATES
INTO ENGLISH AS LOVE AND FAITH.
FOR JEWELRY (U.S. CLS. 2, 27, 28 AND 50).
ANDREA K. NADELMAN, EXAMINING ATTORNEY

SN 77-160,060. SAMUEL AARON, INC., LONG ISLAND
CITY, NY. FILED 4-18-2007.

PAST PRESENT FUTURE

THE MARK CONSISTS OF STANDARD CHARACTERS
WITHOUT CLAIM TO ANY PARTICULAR FONT, STYLE,
SIZE, OR COLOR.

OWNER OF U.S. REG. NO. 2,644,312.
FOR JEWELRY (U.S. CLS. 2, 27, 28 AND 50).
FIRST USE 2-15-2001; IN COMMERCE 2-15-2001.
ELISSA GARBER KON, EXAMINING ATTORNEY

SN 77-160,179. SWAT.FAME, INC., CITY OF INDUSTRY, CA.
FILED 4-18-2007.

SPEECHLESS

THE MARK CONSISTS OF STANDARD CHARACTERS
WITHOUT CLAIM TO ANY PARTICULAR FONT, STYLE,
SIZE, OR COLOR.

OWNER OF U.S. REG. NO. 1,923,815.
FOR JEWELRY, WATCHES AND CLOCKS (U.S. CLS.
2, 27, 28 AND 50).
DAVID H. STINE, EXAMINING ATTORNEY

CLASS 14—(Continued).

SN 77-160,401. MILLS, JAMES L., LAFAYETTE, LA. FILED 4-19-2007.

CLASS 14—(Continued).

SN 77-161,465. SCHUMACHER, BERNARD, BISMARCK, ND. FILED 4-20-2007.

In Memory Of . . .

THE MARK CONSISTS OF STANDARD CHARACTERS WITHOUT CLAIM TO ANY PARTICULAR FONT, STYLE, SIZE, OR COLOR.
FOR RUBBER OR SILICON WRISTBANDS IN THE NATURE OF A BRACELET (U.S. CLS. 2, 27, 28 AND 50).
SUNG IN, EXAMINING ATTORNEY

FOREVER HOT

THE MARK CONSISTS OF STANDARD CHARACTERS WITHOUT CLAIM TO ANY PARTICULAR FONT, STYLE, SIZE, OR COLOR.
FOR JEWELRY (U.S. CLS. 2, 27, 28 AND 50).
BENJAMIN ALLEN, EXAMINING ATTORNEY

SN 77-161,061. LEAKEY, KATY, NEWPORT BEACH, CA. FILED 4-19-2007.

SN 77-161,913. ALISA B., INC., TIMONIUM, MD. FILED 4-20-2007.

MAASAI-GRASS

THE MARK CONSISTS OF STANDARD CHARACTERS WITHOUT CLAIM TO ANY PARTICULAR FONT, STYLE, SIZE, OR COLOR.
NO CLAIM IS MADE TO THE EXCLUSIVE RIGHT TO USE "GRASS", APART FROM THE MARK AS SHOWN.
FOR JEWELRY (U.S. CLS. 2, 27, 28 AND 50).
FIRST USE 3-19-2007; IN COMMERCE 3-19-2007.
SUSAN LESLIE DUBOIS, EXAMINING ATTORNEY

D'LISH

THE MARK CONSISTS OF STANDARD CHARACTERS WITHOUT CLAIM TO ANY PARTICULAR FONT, STYLE, SIZE, OR COLOR.
FOR JEWELRY (U.S. CLS. 2, 27, 28 AND 50).
BENJAMIN ALLEN, EXAMINING ATTORNEY

SN 77-161,321. GLOVEBRUSH CORP., SIMI VALLEY, CA. FILED 4-19-2007.

SN 77-175,056. SAMUEL AARON, INC., LONG ISLAND CITY, NY. FILED 5-8-2007.

Père de Temps

THE MARK CONSISTS OF STANDARD CHARACTERS WITHOUT CLAIM TO ANY PARTICULAR FONT, STYLE, SIZE, OR COLOR.
THE FOREIGN WORDING IN THE MARK TRANSLATES INTO ENGLISH AS "FATHER OF TIME."
FOR CLOCKS, WATCHES, AND OTHER TIMING DEVICES, NAMELY, CHRONOGRAPHS FOR USE AS TIMEPIECES AND AS WATCHES (U.S. CLS. 2, 27, 28 AND 50).
PAUL F. GAST, EXAMINING ATTORNEY

DIAMONLUXE

THE MARK CONSISTS OF STANDARD CHARACTERS WITHOUT CLAIM TO ANY PARTICULAR FONT, STYLE, SIZE, OR COLOR.
FOR JEWELRY (U.S. CLS. 2, 27, 28 AND 50).
ELISSA GARBER KON, EXAMINING ATTORNEY

CLASS 14—(Continued).

SN 77-189,531. ALESSANDRO MASINI, FIRENZE, ITALY, FILED 5-24-2007.

ALESSANDRO MASINI

THE MARK CONSISTS OF STANDARD CHARACTERS WITHOUT CLAIM TO ANY PARTICULAR FONT, STYLE, SIZE, OR COLOR.

THE NAME(S), PORTRAIT(S), AND/OR SIGNATURE(S) SHOWN IN THE MARK IDENTIFIES ALESSANDRO MASINI, WHOSE CONSENT(S) TO REGISTER IS SUBMITTED.

FOR JEWELRY, WATCHES AND JEWELRY WATCHES (U.S. CLS. 2, 27, 28 AND 50).

KENNETH E. SHARPERSON, EXAMINING ATTORNEY

CLASS 14—(Continued).

SN 78-546,172. LTD COMMODITIES LLC, BANNOCKBURN, IL. FILED 1-12-2005.

MOTHERHOOD

THE MARK CONSISTS OF STANDARD CHARACTERS WITHOUT CLAIM TO ANY PARTICULAR FONT, STYLE, SIZE, OR COLOR.

FOR JEWELRY (U.S. CLS. 2, 27, 28 AND 50).

JOANNA DUKOVIC, EXAMINING ATTORNEY

SN 77-192,305. FIRESTONE, INC., NEW YORK, NY. FILED 5-29-2007.



mi joya divina

NO CLAIM IS MADE TO THE EXCLUSIVE RIGHT TO USE "JOYA", APART FROM THE MARK AS SHOWN.

THE FOREIGN WORDING IN THE MARK TRANSLATES INTO ENGLISH AS MY DIVINE JEWEL.

FOR JEWELRY (U.S. CLS. 2, 27, 28 AND 50).

ANDREA K. NADELMAN, EXAMINING ATTORNEY

SN 78-826,492. VIVA ENTERPRISES LLC, NORTHBROOK, IL. FILED 3-1-2006.

VIVA BEADS

THE MARK CONSISTS OF STANDARD CHARACTERS WITHOUT CLAIM TO ANY PARTICULAR FONT, STYLE, SIZE, OR COLOR.

NO CLAIM IS MADE TO THE EXCLUSIVE RIGHT TO USE "BEADS", APART FROM THE MARK AS SHOWN.

FOR JEWELRY (U.S. CLS. 2, 27, 28 AND 50).

LINDA M. KING, EXAMINING ATTORNEY

SN 77-208,160. SCOTT KAY, INC., TEANECK, NJ. FILED 6-18-2007.

UNKAGED

THE MARK CONSISTS OF STANDARD CHARACTERS WITHOUT CLAIM TO ANY PARTICULAR FONT, STYLE, SIZE, OR COLOR.

FOR JEWELRY (U.S. CLS. 2, 27, 28 AND 50).

ANNE E. GUSTASON, EXAMINING ATTORNEY

SN 78-962,229. STRAPPYART, LLC, LAKEWOOD, CO. FILED 8-28-2006.

StrappyArt

THE MARK CONSISTS OF STANDARD CHARACTERS WITHOUT CLAIM TO ANY PARTICULAR FONT, STYLE, SIZE, OR COLOR.

FOR COSTUME JEWELRY, NAMELY, JEWELRY USED TO KEEP BRASSIERE STRAPS CONCEALED BENEATH A STRAPPED TOP (U.S. CLS. 2, 27, 28 AND 50).

FIRST USE 7-27-2006; IN COMMERCE 7-27-2006.

JANICE KIM, EXAMINING ATTORNEY

CLASS 14—(Continued).

SN 78-968,726. LIEBERFARB, INC., ORANGE, NJ. FILED 9-7-2006.

NATURALLY WHITE NATURALLY
BEAUTIFUL

THE MARK CONSISTS OF STANDARD CHARACTERS WITHOUT CLAIM TO ANY PARTICULAR FONT, STYLE, SIZE, OR COLOR.

FOR PALLADIUM JEWELRY (U.S. CLS. 2, 27, 28 AND 50).

FIRST USE 3-14-2006; IN COMMERCE 3-14-2006.
JERI J. FICKES, EXAMINING ATTORNEY

SN 79-032,285. MONSIEUR DAVID ATTIAS, FRANCE,
FILED 11-17-2006.

NAVITEC



OWNER OF INTERNATIONAL REGISTRATION 0906932
DATED 11-17-2006, EXPIRES 11-17-2016.
FOR WATCHES (U.S. CLS. 2, 27, 28 AND 50).
MARK PILARO, EXAMINING ATTORNEY

SN 79-032,316. VERDUCCI SERGIO, NERVIANO (MI),
ITALY, FILED 9-27-2006.



BELLO & PRECISO
MILANO

OWNER OF INTERNATIONAL REGISTRATION 0907008
DATED 9-27-2006, EXPIRES 9-27-2016.

NO CLAIM IS MADE TO THE EXCLUSIVE RIGHT TO USE "PRECISO" AND "MILANO", APART FROM THE MARK AS SHOWN.

THE ENGLISH TRANSLATION OF THE ITALIAN WORDING "BELLO & PRECISO" AND "MILANO" IS "BEAUTIFUL AND PRECISE" AND "MILAN."

FOR CHRONOMETRIC INSTRUMENTS, WATCHES; WRIST-WATCHES AND WALL CLOCKS; CHRONOMETERS (U.S. CLS. 2, 27, 28 AND 50).

ROBERT LAVACHE, EXAMINING ATTORNEY

CLASS 14—(Continued).

SN 79-035,751. KARAT TAKI VE MÜCEVHERAT; SANAYI VE TICARET ANONIM SİRKETİ, TURKEY, FILED 12-7-2006.



KARATTI

PRIORITY DATE OF 11-20-2006 IS CLAIMED.
OWNER OF INTERNATIONAL REGISTRATION 0916930
DATED 12-7-2006, EXPIRES 12-7-2016.

THE COLOR(S) DARK GREEN AND WHITE IS/ARE CLAIMED AS A FEATURE OF THE MARK.

THE WORDING "KARATTI" APPEARS IN THE COLOR DARK GREEN. THERE IS A CIRCLE ABOVE THE WORDING KARATTI. THE LETTER K WITH THE COLOR WHITE IS PLACED INTO THIS DARK GREEN CIRCLE.

FOR GOLD INGOTS, EARRINGS BEING JEWELRY, RINGS BEING JEWELRY, BRACELETS BEING JEWELRY, PINS BEING JEWELRY, TIE PINS, CUFF-LINKS, JEWELRY CHAINS, MEDALLIONS, BROOCHES, PRECIOUS METALS AND THEIR ALLOYS, NAMELY GOLD, SILVER, DIAMONDS (U.S. CLS. 2, 27, 28 AND 50).

KATHERINE E. HALMEN, EXAMINING ATTORNEY

CLASS 15—MUSICAL INSTRUMENTS

SN 77-149,139. RICO CORPORATION, TA RICO INTERNATIONAL, SUN VALLEY, CA. FILED 4-5-2007.

RICO INTERNATIONAL

THE MARK CONSISTS OF STANDARD CHARACTERS WITHOUT CLAIM TO ANY PARTICULAR FONT, STYLE, SIZE, OR COLOR.

OWNER OF U.S. REG. NOS. 712,864, 1,185,684 AND 1,622,415.

NO CLAIM IS MADE TO THE EXCLUSIVE RIGHT TO USE "INTERNATIONAL", APART FROM THE MARK AS SHOWN.

FOR MUSICAL INSTRUMENTS AND PARTS AND FITTINGS FOR USE WITH MUSICAL INSTRUMENTS, NAMELY, MOUTHPIECES, REEDS, AND MUTES; ABSORBENT MATERIALS MADE OF NATURAL OR SYNTHETIC YARN SPECIALLY DESIGNED FOR PLACEMENT INSIDE WIND INSTRUMENTS AND MOUTHPIECES FOR MUSICAL INSTRUMENTS; REED HOLDERS (U.S. CLS. 2, 21 AND 36).

FIRST USE 1-0-1991; IN COMMERCE 1-0-1991.

JACLYN KIDWELL, EXAMINING ATTORNEY

CLASS 15—(Continued).

SN 77-152,194. SANRIO COMPANY, LTD., TOKYO, JAPAN, FILED 4-9-2007.

KUROMI

THE MARK CONSISTS OF STANDARD CHARACTERS WITHOUT CLAIM TO ANY PARTICULAR FONT, STYLE, SIZE, OR COLOR.

FOR MUSIC BOXES, MUSICAL JEWELRY BOXES, MUSICAL TEA POTS, GUITARS, HANDBELLS, CARRY CASES, BAGS, AND COVERS FOR MUSICAL INSTRUMENTS (U.S. CLS. 2, 21 AND 36).

NAKWAMA ANKRAH, EXAMINING ATTORNEY

SN 77-155,012. AMERICAN WAY MARKETING LLC, ELKHART, IN. FILED 4-12-2007.

FAXX

THE MARK CONSISTS OF STANDARD CHARACTERS WITHOUT CLAIM TO ANY PARTICULAR FONT, STYLE, SIZE, OR COLOR.

FOR MOUTHPIECES FOR MUSICAL INSTRUMENTS (U.S. CLS. 2, 21 AND 36).

FIRST USE 2-1-2004; IN COMMERCE 2-1-2004.
MARLENE BELL, EXAMINING ATTORNEY

CLASS 16—PAPER GOODS AND PRINTED MATTER

SN 76-370,170. DORLING KINDERSLEY LIMITED, LONDON, ENGLAND, FILED 2-11-2002.

DK

OWNER OF U.S. REG. NOS. 1,763,689, 2,197,415 AND 2,243,408.

FOR EDUCATIONAL BOOKS, NAMELY BOOKS FOR NATURAL SCIENCES, HISTORY, SOCIAL STUDIES, TECHNOLOGY, ARTS AND CRAFTS, EARLY CHILDHOOD DEVELOPMENT, MATH, GEOGRAPHY, NATURE, SPACE, CHILDREN'S FICTION, RELIGIOUS STUDIES, GENERAL REFERENCE, SPORTS, COOKING, GAMES AND PUZZLES FOR CHILDREN AGED 1 THROUGH 16, PUBLICATION PAPER, PRINTED WALL CHARTS, POSTER MAPS (U.S. CLS. 2, 5, 22, 23, 29, 37, 38 AND 50).

FIRST USE 9-30-1991; IN COMMERCE 9-30-1991.
MONIQUE MILLER, EXAMINING ATTORNEY

CLASS 16—(Continued).

SN 76-653,580. INTERNATIONAL BROADCASTING SERVICES, LTD., PENN'S PARK, PA. FILED 1-17-2006.

PASSPORT TO WORLD BAND RADIO

THE MARK CONSISTS OF STANDARD CHARACTERS WITHOUT CLAIM TO ANY PARTICULAR FONT, STYLE, SIZE, OR COLOR.

OWNER OF U.S. REG. NO. 1,789,358.

NO CLAIM IS MADE TO THE EXCLUSIVE RIGHT TO USE "WORLD BAND RADIO", APART FROM THE MARK AS SHOWN.

FOR GUIDEBOOKS, NEWSLETTERS AND PRINTED REPORTS ALL ON THE SUBJECTS OF INTERNATIONAL RADIO PROGRAMMING AND EQUIPMENT AND RELATED TOPICS (U.S. CLS. 2, 5, 22, 23, 29, 37, 38 AND 50).

FIRST USE 0-0-1988; IN COMMERCE 0-0-1988.

MAUREEN DALL, EXAMINING ATTORNEY

SN 76-666,518. LENNOX INDUSTRIES INC., RICHARDSON, TX. FILED 9-25-2006.

HOME COMFORT STYLE

NO CLAIM IS MADE TO THE EXCLUSIVE RIGHT TO USE "HOME" AND "STYLE", APART FROM THE MARK AS SHOWN.

FOR PERIODICAL MAGAZINES DEALING WITH TOPICS OF INTEREST TO HOMEOWNERS (U.S. CLS. 2, 5, 22, 23, 29, 37, 38 AND 50).

KELLY BOULTON, EXAMINING ATTORNEY

SN 76-668,771. ANDERSON, JOSEPH M., SANBORN, NY. FILED 11-9-2006.

SMOKIN DEALS SPOTLIGHT

THE MARK CONSISTS OF STANDARD CHARACTERS WITHOUT CLAIM TO ANY PARTICULAR FONT, STYLE, SIZE, OR COLOR.

FOR PRINTED MATERIALS, NAMELY BROCHURES AND NEWSLETTERS FEATURING INFORMATION ABOUT MERCHANDISE, ENTERTAINMENT AND CURRENT EVENTS (U.S. CLS. 2, 5, 22, 23, 29, 37, 38 AND 50).

FIRST USE 10-23-2006; IN COMMERCE 11-6-2006.

NAKWAMA ANKRAH, EXAMINING ATTORNEY

CLASS 16—(Continued).

SN 76-671,345. METALS SERVICE CENTER INSTITUTE, CHICAGO, IL. FILED 1-12-2007.

METALS ACTIVITY REPORT

NO CLAIM IS MADE TO THE EXCLUSIVE RIGHT TO USE "REPORT", APART FROM THE MARK AS SHOWN.

SEC. 2(F).
FOR ONGOING PUBLICATION, NAMELY, A PRINTED BROCHURE OF INFORMATION REGARDING SHIPMENTS AND INVENTORIES IN THE METALS INDUSTRY (U.S. CLS. 2, 5, 22, 23, 29, 37, 38 AND 50).
FIRST USE 5-1-2003; IN COMMERCE 5-1-2003.
CHARLES L. JENKINS, EXAMINING ATTORNEY

SN 76-672,198. RICK LAWRENCE AND JEAN LAWRENCE, WADSWORTH, IL. FILED 2-2-2007.

PICTURE-IT POSTCARD

THE MARK CONSISTS OF STANDARD CHARACTERS WITHOUT CLAIM TO ANY PARTICULAR FONT, STYLE, SIZE, OR COLOR.

NO CLAIM IS MADE TO THE EXCLUSIVE RIGHT TO USE "POSTCARD", APART FROM THE MARK AS SHOWN.

FOR ADHESIVE PAPER DESIGNED FOR APPLICATION TO THE BACKSIDE OF A PHOTOGRAPH, CREATING A PERSONALIZED POSTCARD (U.S. CLS. 2, 5, 22, 23, 29, 37, 38 AND 50).

FIRST USE 1-1-1986; IN COMMERCE 3-11-1986.
ERNEST SHOSHO, EXAMINING ATTORNEY

SN 76-675,519. NATIONAL PUBLISHERS GROUP, INC., DERBY, KS. FILED 4-16-2007.

AOGR

THE MARK CONSISTS OF STANDARD CHARACTERS WITHOUT CLAIM TO ANY PARTICULAR FONT, STYLE, SIZE, OR COLOR.

OWNER OF U.S. REG. NOS. 1,117,238, 1,117,239 AND OTHERS.

FOR PUBLICATIONS, NAMELY, MAGAZINES FEATURING THE OIL AND GAS INDUSTRY (U.S. CLS. 2, 5, 22, 23, 29, 37, 38 AND 50).

FIRST USE 1-0-2000; IN COMMERCE 1-0-2000.
LINDA M. KING, EXAMINING ATTORNEY

CLASS 16—(Continued).

SN 76-675,617. BARBARA DENTI POOL AND LINDA SUE CUBERO, LUTZ, FL. FILED 4-17-2007.

QUEENBEES

THE MARK CONSISTS OF STANDARD CHARACTERS WITHOUT CLAIM TO ANY PARTICULAR FONT, STYLE, SIZE, OR COLOR.

FOR PATTERNS FOR SEWING (U.S. CLS. 2, 5, 22, 23, 29, 37, 38 AND 50).

FIRST USE 3-15-2005; IN COMMERCE 3-15-2005.
ERNEST SHOSHO, EXAMINING ATTORNEY

SN 76-675,676. PANISH, SHARON LOUISE, WOODLAND HILLS, CA. AND PANISH, MICHAEL STEVEN, WOODLAND HILLS, CA. FILED 4-18-2007.

HALF BIRTHDAY

THE MARK CONSISTS OF STANDARD CHARACTERS WITHOUT CLAIM TO ANY PARTICULAR FONT, STYLE, SIZE, OR COLOR.

OWNER OF U.S. REG. NOS. 2,455,883, 2,476,854 AND OTHERS.

SEC. 2(F).
FOR PENS, PENCILS, PAPER NAPKINS, PAPER TABLECLOTHS AND GREETING CARDS (U.S. CLS. 2, 5, 22, 23, 29, 37, 38 AND 50).

FIRST USE 1-10-2001; IN COMMERCE 1-10-2001.
ANDREA SAUNDERS, EXAMINING ATTORNEY

SN 76-675,745. SCHLUGER, ALLEN, NEW YORK, NY. FILED 4-19-2007.

GIFTELOPE

THE MARK CONSISTS OF STANDARD CHARACTERS WITHOUT CLAIM TO ANY PARTICULAR FONT, STYLE, SIZE, OR COLOR.

FOR STATIONERY AND GREETING CARDS (U.S. CLS. 2, 5, 22, 23, 29, 37, 38 AND 50).

GIANCARLO CASTRO, EXAMINING ATTORNEY

CLASS 16—(Continued).

SN 76-675,769. JONES, RONALD E., SR., BROCKPORT, NY. FILED 4-20-2007.

SCRAP-A-DORNS

THE MARK CONSISTS OF STANDARD CHARACTERS WITHOUT CLAIM TO ANY PARTICULAR FONT, STYLE, SIZE, OR COLOR.

FOR DECORATIONS MADE OF PAPER (U.S. CLS. 2, 5, 22, 23, 29, 37, 38 AND 50).

FIRST USE 7-31-2006; IN COMMERCE 2-16-2007.
ERNEST SHOSHO, EXAMINING ATTORNEY

SN 77-000,242. TELMEX USA, L.L.C., MIRAMAR, FL. FILED 9-15-2006.

BELISSIMO

THE MARK CONSISTS OF STANDARD CHARACTERS WITHOUT CLAIM TO ANY PARTICULAR FONT, STYLE, SIZE, OR COLOR.

"THE FOREIGN WORDING IN THE MARK TRANSLATES INTO ENGLISH AS VERY BEAUTIFUL."

FOR PRE-PAID TELEPHONE CALLING CARDS, NOT MAGNETICALLY ENCODED (U.S. CLS. 2, 5, 22, 23, 29, 37, 38 AND 50).

ANN E. SAPPENFIELD, EXAMINING ATTORNEY

SN 77-005,587. AMCOR LIMITED, ABBOTSFORD, VICTORIA, AUSTRALIA, FILED 9-22-2006.

HYDRO-ARMOUR

THE MARK CONSISTS OF STANDARD CHARACTERS WITHOUT CLAIM TO ANY PARTICULAR FONT, STYLE, SIZE, OR COLOR.

OWNER OF AUSTRALIA REG. NO. 1062447, DATED 6-29-2005, EXPIRES 6-29-2015.

FOR PAPER, CARDBOARD, PACKAGING MATERIALS, NAMELY CARTONS MADE OF PAPER AND CARDBOARD; CONTAINERS, NAMELY, BOXES AND CARTONS MADE FROM CARDBOARD, FIBREBOARD, AND PAPER (U.S. CLS. 2, 5, 22, 23, 29, 37, 38 AND 50).

JOHN WILKE, EXAMINING ATTORNEY

CLASS 16—(Continued).

SN 77-022,305. THE LBC, WESTMINSTER, CA. FILED S.R. 10-16-2006; AM. P.R. 10-16-2006.

The LBC

OWNER OF U.S. REG. NO. 2,939,200.
FOR STICKERS, BUMPER STICKERS, TEMPORARY TATTOOS AND PRINTED HEAT TRANSFER PAPER (U.S. CLS. 2, 5, 22, 23, 29, 37, 38 AND 50).

KATHERINE CHANG, EXAMINING ATTORNEY

SN 77-025,154. FLAT CREEK MOUNTAIN, INC., ASHEVILLE, NC. FILED 10-19-2006.

LOVE FLOWERS

THE MARK CONSISTS OF STANDARD CHARACTERS WITHOUT CLAIM TO ANY PARTICULAR FONT, STYLE, SIZE, OR COLOR.

OWNER OF U.S. REG. NOS. 2,849,040 AND 2,983,770.

NO CLAIM IS MADE TO THE EXCLUSIVE RIGHT TO USE "FLOWERS", APART FROM THE MARK AS SHOWN.

FOR ADDRESS BOOKS; ADDRESS LABELS; ADHESIVE TAPES FOR STATIONERY OR HOUSEHOLD PURPOSES; AGENDAS; ANIMATION CELLS; ANNIVERSARY BOOKS; ANNOUNCEMENT CARDS; APPLIQUES IN THE FORM OF DECALS; APPOINTMENT BOOKS; ART ETCHINGS; ARTISTS' PASTELS; ART PAPER; ART PICTURES; ART PRINTS; ARTS AND CRAFTS PAINT KITS; AUTOGRAPH BOOKS; BABY BOOKS; BALL POINT PENS; BANK CHECKS; BATHROOM TISSUE; BINDERS; BLANK CARDS; BLANK NOTE CARDS; BLANK OR PARTIALLY PRINTED POSTCARDS; BLANK OR PARTIALLY PRINTED PAPER LABELS; BOND PAPER; BOOK COVERS; BOOKENDS; BOOKLETS ABOUT FLOWERS, GARDENING, HERBS, COOKING; BOOKMARKS; BOOK PLATES; BULLETIN BOARDS; BUMPER STICKERS; BUSINESS CARDS; CALENDAR DESK PADS; CALENDAR DESK STANDS; CALENDARS; CALENDAR STANDS; CARDBOARD FLOOR DISPLAY UNITS FOR MERCHANDISING PRODUCTS; CARDS BEARING UNIVERSAL GREETINGS; CARICATURES; CATALOGS ABOUT FLOWERS, GARDENING; CHALK; CHECKBOOK AND PASSBOOK WALLETS; CHECKBOOK COVERS; CHECK BOOKS; CHILDREN'S ACTIVITY BOOKS; CHILDREN'S BOOKS; CHRISTMAS CARDS; CLIP BOARDS; COASTERS MADE OF PAPER; COLLAGES; COLORING BOOKS; COLOR PRINTS; COMMEMORATIVE STAMP SHEETS; COMPOSITION BOOKS; COMPUTER PAPER; COOK BOOKS; COSMETIC PENCIL SHARPENERS; CRAYONS; DAILY PLANNERS; DATA BOOKS; DECALS; DECORATIVE PAPER CENTERPIECES; DECORATIVE PENCIL TOP ORNAMENTS; DESK BASKETS FOR DESK ACCESSORIES; DESK CALENDARS; DESK FILE TRAYS; DESK SETS; DESK TOP ORGANIZERS; DESK TOP PLANNERS; DESK TOP REVOLVING ROTARY CARD FILES; DIARIES; DICTIONARIES; DISPENSERS FOR ADHESIVE TAPES FOR STATIONERY OR HOUSEHOLD PURPOSES; DISPOSABLE WIPES NOT IMPREGNATED WITH CHEMICALS OR COMPOUNDS; EMBROIDERY DESIGN PATTERNS; ENGAGEMENT BOOKS; ENGRAVINGS; ENVELOPES; FACIAL TISSUE; FOUNTAIN PENS; GENERAL FEATURE MAGAZINES; GENERAL PURPOSE PLASTIC BAGS; GIFT WRAPPING PAPER; GRAPHIC ART REPRODUCTIONS; GRAPHIC NOVELS; GUEST BOOKS; HEAT TRANSFER PAPER; PRINTED HOLOGRAMS;

CLASS 16—(Continued).

ILLUSTRATIONS; INFORMATIONAL FLYERS ABOUT FLOWERS, GARDENING; LAP BOARDS FOR READING AND WRITING; LEAFLETS ABOUT FLOWERS, GARDENING; LETTER OPENERS; LINING PAPER; LITHOGRAPHIC PRINTS; LITHOGRAPHS; MAGAZINE COLUMNS ABOUT FLOWERS, GARDENING, COOKING, POETRY; MAGAZINE DEPARTMENTS ABOUT FLOWERS, GARDENING, COOKING, POETRY; MAGAZINES ABOUT FLOWERS, GARDENING, COOKING, POETRY; MAGAZINE SECTIONS ABOUT FLOWERS, GARDENING, COOKING, POETRY; MAGNETIC BOARDS; MEMO PADS; MEMORANDUM BOARDS; MEMORY BOOKS; MERCHANDISE BAGS; METALLIC GIFT WRAP; METALLIC GIFT WRAPPING PAPER; MONOGRAPHS ABOUT FLOWERS, GARDENING, COOKING, POETRY; MOTIVATIONAL CARDS; MURALS; OCCASION CARDS; OIL PASTELS; PAINTINGS; PAINTING SETS FOR CHILDREN; PAPER HANDKERCHIEFS; PAPER BAGS; PAPER BANNERS; PAPER BIBS; PAPER BOXES; PAPER CAKE DECORATIONS; PAPER COVERS FOR TELEPHONE RECEIVERS; PAPER DOILIES; PAPER EMBLEMS; PAPER FLAGS; PAPER GIFT BAGS; PAPER GIFT WRAP BOWS; PAPER GIFT WRAPPING RIBBONS; PAPER MACHE; PAPER MACHE FIGURINES; PAPER MATS; PAPER NAME BADGES; PAPER NAPKINS; PAPER PARTY BAGS; PAPER PARTY DECORATIONS; PAPER PARTY HATS; PAPER TABLE CLOTHS; PAPER TABLE LINEN; PAPER TEACHING MATERIALS ABOUT FLOWERS, GARDENING, COOKING, POETRY; PAPER TOWELS; PAPER TRANSPARENCIES; PAPER WASHCLOTHS; PAPERWEIGHTS; PASTELS; PEN CASES; PENCIL BOXES; PENCIL CASES; PENCILS; PENS; PERSONAL PLANNERS; PHOTO-ENGRAVINGS; PHOTOGRAPH ALBUMS; PHOTOGRAPHIC PRINTS; PICTORIAL PRINTS; PICTURE BOOKS; PICTURE POSTCARDS; PICTURES; PLACE MATS OF PAPER; PLASTIC OR PAPER BAGS FOR MERCHANDISE PACKAGING; MATS, NAMELY TABLE MATS OF PAPER; PLASTIC TRANSPARENCIES; POCKET CALENDARS; PORTRAITS; POSY HOLDERS MADE OF PAPER; POSTERS; PRINTED ART REPRODUCTIONS; PRINTED EMBLEMS; PRINTED INSTRUCTIONAL, EDUCATIONAL, AND TEACHING MATERIALS ABOUT FLOWERS, GARDENING, POETRY, COOKING; PRINTED INVITATIONS; PRINTED PAPER LABELS; PRINTED PAPER SIGNS, NAMELY, TABLE TENTS; PRINTED TEACHING MATERIALS ABOUT FLOWERS, GARDENING, POETRY, COOKING; RECIPE BOOKS; REFERENCE BOOKS ABOUT FLOWERS, GARDENING, COOKING, POETRY; RUBBER STAMPS; SCENTED DRAWER LINERS; SCENTED PAPER DRAWER LINERS; SCRAPBOOK ALBUMS; SCRAPBOOKS; SEALING WAX; SERIES OF NON-FICTION BOOKS ABOUT FLOWERS, GARDENING, POETRY, COOKING; SHEET MUSIC; SHELF PAPER; SKETCHES; SOCIAL NOTE CARDS; STATIONERY; STATIONERY BOXES; STATIONERY FOLDERS; STENCILS; STICKERS; TALKING CHILDREN'S BOOKS; TELEPHONE NUMBER BOOKS; THREE DIMENSIONAL MODELS FOR EDUCATIONAL PURPOSES; TISSUE PAPER; TRADING CARDS; TREATED PAPER FOR WRAPPING FLOWERS AND FLORAL DISPLAYS; WALL CALENDARS; WALL COVERING SAMPLE BOOKS; WALLPAPER SAMPLE BOOK; WATERCOLOR PICTURES; WEDDING ALBUMS; WEDDING BOOKS; WRITING INK; WRITING INSTRUMENTS; AND WRITING PADS (U.S. CLS. 2, 5, 22, 23, 29, 37, 38 AND 50).

CARYN GLASSER, EXAMINING ATTORNEY

CLASS 16—(Continued).

SN 77-026,846. CUMMINS INTELLECTUAL PROPERTY, INC., COLUMBUS, IN. FILED 10-23-2006.

INNOVATION YOU CAN DEPEND
ON

THE MARK CONSISTS OF STANDARD CHARACTERS WITHOUT CLAIM TO ANY PARTICULAR FONT, STYLE, SIZE, OR COLOR.

FOR PRINTED MATTER, NAMELY, PRINTED CHARTS, INSTRUCTION BOOKS AND MANUALS IN THE FIELD OF MOTORS, ENGINES, POWER GENERATORS, FUEL SYSTEMS, CONTROLS, AIR HANDLING SYSTEMS, FILTRATION, EMISSIONS CONTROL SYSTEMS AND PARTS THEREOF; POSTERS; AND STICKERS (U.S. CLS. 2, 5, 22, 23, 29, 37, 38 AND 50).

WARREN L. OLANDRIA, EXAMINING ATTORNEY

SN 77-027,227. TODAY MEDIA, INC., WILMINGTON, DE. FILED 10-23-2006.

MAIN LINE TODAY

THE MARK CONSISTS OF STANDARD CHARACTERS WITHOUT CLAIM TO ANY PARTICULAR FONT, STYLE, SIZE, OR COLOR.

SEC. 2(F) AS TO "MAIN LINE".
FOR GENERAL FEATURE MAGAZINES (U.S. CLS. 2, 5, 22, 23, 29, 37, 38 AND 50).
FIRST USE 3-1-1996; IN COMMERCE 3-1-1996.

HENRY S. ZAK, EXAMINING ATTORNEY

SN 77-028,713. THOMPSON, ADAM, PAYNEHAM, AUSTRALIA, FILED 10-25-2006.

THE DIVINITY CODE

THE MARK CONSISTS OF STANDARD CHARACTERS WITHOUT CLAIM TO ANY PARTICULAR FONT, STYLE, SIZE, OR COLOR.

FOR A SERIES OF NON-FICTION BOOKS, MAGAZINES AND WRITTEN ARTICLES IN THE FIELDS OF CHRISTIANITY, SPIRITUALITY, DREAM INTERPRETATION AND HISTORY (U.S. CLS. 2, 5, 22, 23, 29, 37, 38 AND 50).

H. M. FISHER, EXAMINING ATTORNEY

CLASS 16—(Continued).

SN 77-037,474. CROME MEDIA GROUP, INC., WHITMORE LAKE, MI. FILED 11-6-2006.

CROME

THE MARK CONSISTS OF STANDARD CHARACTERS WITHOUT CLAIM TO ANY PARTICULAR FONT, STYLE, SIZE, OR COLOR.

FOR PRINTED MATTER AND PUBLICATIONS, NAMELY MAGAZINES AND PERIODICAL PUBLICATIONS, IN THE FIELD OF MEN'S LIFESTYLES, ENTERTAINMENT, FITNESS, HEALTH, AND RECREATIONAL ACTIVITIES (U.S. CLS. 2, 5, 22, 23, 29, 37, 38 AND 50).

PRISCILLA MILTON, EXAMINING ATTORNEY

CLASS 16—(Continued).

SN 77-041,747. TELMEX USA, L.L.C., MIRAMAR, FL. FILED 11-10-2006.

ORGULLOSAMENTE SPANGLISH

THE MARK CONSISTS OF STANDARD CHARACTERS WITHOUT CLAIM TO ANY PARTICULAR FONT, STYLE, SIZE, OR COLOR.

"THE FOREIGN WORDING IN THE MARK TRANSLATES INTO ENGLISH AS PROUDLY SPANGLISH."

FOR PRE-PAID TELEPHONE CALLING CARDS, NOT MAGNETICALLY ENCODED (U.S. CLS. 2, 5, 22, 23, 29, 37, 38 AND 50).

ANN E. SAPPENFIELD, EXAMINING ATTORNEY

SN 77-040,754. PAPERS BY DESIGN, LLC, MAGNOLIA, TX. FILED 11-9-2006.

Papers by Design

THE MARK CONSISTS OF STANDARD CHARACTERS WITHOUT CLAIM TO ANY PARTICULAR FONT, STYLE, SIZE, OR COLOR.

NO CLAIM IS MADE TO THE EXCLUSIVE RIGHT TO USE "PAPERS", APART FROM THE MARK AS SHOWN.

FOR CARDS, NAMELY, GREETING CARDS, NOTE-CARDS, OCCASION CARDS, INVITATION CARDS, AND ANNOUNCEMENT CARDS; STATIONERY (U.S. CLS. 2, 5, 22, 23, 29, 37, 38 AND 50).

FIRST USE 10-1-1995; IN COMMERCE 12-15-1995.
PRISCILLA MILTON, EXAMINING ATTORNEY

SN 77-043,876. TELMEX USA, L.L.C., MIRAMAR, FL. FILED 11-14-2006.

DONDE SEA

THE MARK CONSISTS OF STANDARD CHARACTERS WITHOUT CLAIM TO ANY PARTICULAR FONT, STYLE, SIZE, OR COLOR.

"THE FOREIGN WORDING IN THE MARK TRANSLATES INTO ENGLISH AS WHEREVER."

FOR PRE-PAID TELEPHONE CALLING CARDS, NOT MAGNETICALLY ENCODED (U.S. CLS. 2, 5, 22, 23, 29, 37, 38 AND 50).

ANN E. SAPPENFIELD, EXAMINING ATTORNEY

SN 77-041,725. TELMEX USA, L.L.C., MIRAMAR, FL. FILED 11-10-2006.

EL AVENTURERO

THE MARK CONSISTS OF STANDARD CHARACTERS WITHOUT CLAIM TO ANY PARTICULAR FONT, STYLE, SIZE, OR COLOR.

"THE FOREIGN WORDING IN THE MARK TRANSLATES INTO ENGLISH AS THE ADVENTURER."

FOR PRE-PAID TELEPHONE CALLING CARDS, NOT MAGNETICALLY ENCODED (U.S. CLS. 2, 5, 22, 23, 29, 37, 38 AND 50).

ANN E. SAPPENFIELD, EXAMINING ATTORNEY

SN 77-045,903. TELMEX USA, L.L.C., MIRAMAR, FL. FILED 11-16-2006.

SU BOLETO

THE MARK CONSISTS OF STANDARD CHARACTERS WITHOUT CLAIM TO ANY PARTICULAR FONT, STYLE, SIZE, OR COLOR.

"THE FOREIGN WORDING IN THE MARK TRANSLATES INTO ENGLISH AS YOUR TICKET."

FOR PRE-PAID TELEPHONE CALLING CARDS, NOT MAGNETICALLY ENCODED (U.S. CLS. 2, 5, 22, 23, 29, 37, 38 AND 50).

ANN E. SAPPENFIELD, EXAMINING ATTORNEY

CLASS 16—(Continued).

SN 77-048,465. ACTIVATOR METHODS INTERNATIONAL, LTD., PHOENIX, AZ. FILED 11-21-2006.

**Activator Methods Analysis:
When, Where, and When
Not to Adjust the Spine.**

THE MARK CONSISTS OF STANDARD CHARACTERS WITHOUT CLAIM TO ANY PARTICULAR FONT, STYLE, SIZE, OR COLOR.

OWNER OF U.S. REG. NOS. 1,124,263, 2,559,540 AND OTHERS.

FOR NEWSLETTERS, BROCHURES AND MAGAZINES IN THE FIELD OF CHIROPRACTIC TECHNIQUES, RESEARCH AND EQUIPMENT (U.S. CLS. 2, 5, 22, 23, 29, 37, 38 AND 50).

BILL DAWE, EXAMINING ATTORNEY

SN 77-055,800. TELMEX USA, L.L.C., MIRAMAR, FL. FILED 12-1-2006.

4 POINTS

THE MARK CONSISTS OF STANDARD CHARACTERS WITHOUT CLAIM TO ANY PARTICULAR FONT, STYLE, SIZE, OR COLOR.

FOR PRE-PAID TELEPHONE CALLING CARDS, NOT MAGNETICALLY ENCODED (U.S. CLS. 2, 5, 22, 23, 29, 37, 38 AND 50).

ANN E. SAPPENFIELD, EXAMINING ATTORNEY

SN 77-058,219. SET EDITIONS, LLC, BROOKLYN, NY. FILED 12-6-2006.

**CARDSTOCK. EVERY CARD YOU
NEED THIS YEAR**

THE MARK CONSISTS OF STANDARD CHARACTERS WITHOUT CLAIM TO ANY PARTICULAR FONT, STYLE, SIZE, OR COLOR.

NO CLAIM IS MADE TO THE EXCLUSIVE RIGHT TO USE "CARDSTOCK", APART FROM THE MARK AS SHOWN.

FOR BLANK CARDS, BLANK NOTE CARDS, GREETING CARDS, OCCASION CARDS AND HOLIDAY CARDS (U.S. CLS. 2, 5, 22, 23, 29, 37, 38 AND 50).

FIRST USE 5-10-2005; IN COMMERCE 5-10-2005.

ANDREA K. NADELMAN, EXAMINING ATTORNEY

CLASS 16—(Continued).

SN 77-068,180. ALAN J. MARTIN, EAST WINDSOR, NJ. FILED 12-20-2006.

THE CARDKEEPER

THE MARK CONSISTS OF STANDARD CHARACTERS WITHOUT CLAIM TO ANY PARTICULAR FONT, STYLE, SIZE, OR COLOR.

FOR SCORECARD AND PENCIL HOLDER FOR GOLF AND OTHER SPORTS, IN A CLEAR VINYL POUCH THAT SLIPS EASILY INTO YOUR BACK POCKET (U.S. CLS. 2, 5, 22, 23, 29, 37, 38 AND 50).

FIRST USE 9-1-2005; IN COMMERCE 2-26-2006.

NAAKWAMA ANKRAH, EXAMINING ATTORNEY

SN 77-071,297. ROIZEN, MICHAEL F., SHAKER HEIGHTS, OH. AND OZ, MEHMET C., NEW YORK, NY. FILED 12-26-2006.

YOU-TURN

THE MARK CONSISTS OF STANDARD CHARACTERS WITHOUT CLAIM TO ANY PARTICULAR FONT, STYLE, SIZE, OR COLOR.

OWNER OF U.S. REG. NO. 3,220,841.

FOR PUBLICATIONS, NAMELY, A SERIES OF BOOKS IN THE FIELD OF HEALTH, FITNESS, DIET, EXERCISE AND LIFESTYLE (U.S. CLS. 2, 5, 22, 23, 29, 37, 38 AND 50).

CHRISTINE COOPER, EXAMINING ATTORNEY

SN 77-076,616. ELEMENT MARKETS PARTNERS, LP, SUGAR LAND, TX. FILED 1-5-2007.

Climate Sustaining Power Card

NO CLAIM IS MADE TO THE EXCLUSIVE RIGHT TO USE CARD, APART FROM THE MARK AS SHOWN.

THE MARK CONSISTS OF THE FIRST LETTER OF EACH WORD IS CAPITALIZED, AND THE REST OF THE LETTERS ARE IN LOWER CASES; ALL LETTERS ARE IN POPYRUS FONT.

FOR CARDS NOT MAGNETICALLY CODED FOR USE IN BUSINESS TRANSACTIONS; PRINTED INFORMATIONAL CARDS IN THE FIELD OF EMISSION CREDITS, CARBON CREDITS, RENEWABLE ENERGY CREDITS, ENVIRONMENTAL ATTRIBUTES, AND THE LIKE (U.S. CLS. 2, 5, 22, 23, 29, 37, 38 AND 50).

CHRIS WELLS, EXAMINING ATTORNEY

CLASS 16—(Continued).

SN 77-080,497. MAC CHIANG ENTERPRISE CO., LTD.,
TAICHUNG, TAIWAN, FILED 1-11-2007.

CoilMac

FOR PAPER CUTTER; PAPER SHREDDER FOR OFFICE USE; ELECTRIC STAPLER FOR OFFICES; LETTER OPENER; ELECTRIC LETTER OPENER; PENCIL SHARPENER; ADHESIVE TAPE DISPENSER; OFFICE DOCUMENT BINDING MACHINES FOR BINDING DOCUMENTS; PAPER HOLE PUNCHER (U.S. CLS. 2, 5, 22, 23, 29, 37, 38 AND 50).

FIRST USE 6-1-2000; IN COMMERCE 6-1-2000.
RENEE SERVANCE, EXAMINING ATTORNEY

SN 77-082,402. TRANSAMERICA OCCIDENTAL LIFE INSURANCE COMPANY, LOS ANGELES, CA. FILED 1-12-2007.

ADVANCED MATTERS

THE MARK CONSISTS OF STANDARD CHARACTERS WITHOUT CLAIM TO ANY PARTICULAR FONT, STYLE, SIZE, OR COLOR.

FOR NEWSLETTERS IN THE FIELD OF LIFE INSURANCE AND RELATED TOPICS (U.S. CLS. 2, 5, 22, 23, 29, 37, 38 AND 50).

FIRST USE 7-17-2006; IN COMMERCE 7-17-2006.
PRISCILLA MILTON, EXAMINING ATTORNEY

SN 77-107,767. SWIGOR, J. TIMOTHY, MARBLEHEAD, MA. FILED 2-14-2007.

DOGS LUV CARS

THE MARK CONSISTS OF STANDARD CHARACTERS WITHOUT CLAIM TO ANY PARTICULAR FONT, STYLE, SIZE, OR COLOR.

FOR ADDRESS BOOKS; BLANK JOURNAL BOOKS; BLANK WRITING JOURNALS; CALENDARS; CARDS, NAMELY, GREETING CARDS AND NOTE CARDS; DAILY PLANNERS; DESK CALENDARS; PHOTOGRAPH ALBUMS; PHOTOGRAPHIC PRINTS; PHOTOGRAPHS; PICTURE BOOKS; POSTERS; STATIONERY (U.S. CLS. 2, 5, 22, 23, 29, 37, 38 AND 50).

ALICIA COLLINS, EXAMINING ATTORNEY

CLASS 16—(Continued).

SN 77-109,594. THE SCIENTIST, LLC, PHILADELPHIA, PA. FILED 2-16-2007.

Biotech360

THE MARK CONSISTS OF STANDARD CHARACTERS WITHOUT CLAIM TO ANY PARTICULAR FONT, STYLE, SIZE, OR COLOR.

NO CLAIM IS MADE TO THE EXCLUSIVE RIGHT TO USE BIOTECH, APART FROM THE MARK AS SHOWN.

FOR MAGAZINES FEATURING THE PEOPLE, SCIENCE, BUSINESS, AND CULTURE OF THE BIOTECHNOLOGY INDUSTRY (U.S. CLS. 2, 5, 22, 23, 29, 37, 38 AND 50).

FIRST USE 1-1-2007; IN COMMERCE 1-1-2007.
HENRY S. ZAK, EXAMINING ATTORNEY

SN 77-118,314. ENVIRO CYCLE PAPER PRODUCTS, LLC, FREDERICK, MD. FILED 2-28-2007.

RHIMAX

THE MARK CONSISTS OF STANDARD CHARACTERS WITHOUT CLAIM TO ANY PARTICULAR FONT, STYLE, SIZE, OR COLOR.

FOR PAPER GOODS, NAMELY, WRAPPING PAPER, CRAFT PAPER, TABLECLOTHS OF PAPER, TABLEMATS OF PAPER, DROP CLOTHS MADE OF PAPER, PAPER FOR USE UNDER MULCH OR SOIL TO INHIBIT THE GROWTH OF WEEDS; PACKAGING MATERIALS, NAMELY, PACKING PAPER, LINER, AND FILLER; AND FLOOR COVERINGS MADE OF PAPER, NAMELY, PAPER FLOOR MATS EXCLUDING PAPER BATH MATS, AUTO FLOOR MATS, COMMERCIAL-GRADE PROTECTION SHEETS, AND MASKING PAPER (U.S. CLS. 2, 5, 22, 23, 29, 37, 38 AND 50).

FIRST USE 2-26-2007; IN COMMERCE 2-26-2007.
BARBARA A. LOUGHRAN, EXAMINING ATTORNEY

SN 77-136,337. SALES ACTIVITY MANAGEMENT, INC., OAK BROOK, IL. FILED 3-21-2007.

THE MILE BOOK

THE MARK CONSISTS OF STANDARD CHARACTERS WITHOUT CLAIM TO ANY PARTICULAR FONT, STYLE, SIZE, OR COLOR.

NO CLAIM IS MADE TO THE EXCLUSIVE RIGHT TO USE "BOOK", APART FROM THE MARK AS SHOWN.

FOR A RECORD-KEEPING FITNESS JOURNAL (U.S. CLS. 2, 5, 22, 23, 29, 37, 38 AND 50).

FIRST USE 1-30-2007; IN COMMERCE 1-30-2007.
ARETHA SOMERVILLE, EXAMINING ATTORNEY

CLASS 16—(Continued).

SN 77-138,132. NEWS-PRESS GAZETTE COMPANY, ST. JOSEPH, MO. FILED 3-22-2007.



THE MARK CONSISTS OF A BURNING LIGHT BULB DESIGN AND THE WORDS ST. JOSEPH NEWS-PRESS WAY TO KNOW!

FOR NEWSPAPERS (U.S. CLS. 2, 5, 22, 23, 29, 37, 38 AND 50).

FIRST USE 2-23-2007; IN COMMERCE 2-23-2007.
CHERYL CLAYTON, EXAMINING ATTORNEY

SN 77-144,420. BRUMMETT, MICHAEL, IRVINE, CA. FILED 3-30-2007.



NO CLAIM IS MADE TO THE EXCLUSIVE RIGHT TO USE "DIRECTORY", APART FROM THE MARK AS SHOWN.

THE COLOR(S) RED AND GRAY IS/ARE CLAIMED AS A FEATURE OF THE MARK.

THE MARK CONSISTS OF THE WORD "THE" IN RED, POSITIONED VERTICALLY TO THE RIGHT OF THE WORDS "IRVINE" AND "DIRECTORY", ALSO BOTH IN RED, WHICH ARE ALIGNED HORIZONTALLY, WITH A GRAY SHADOW AS A BACKDROP TO ALL THE WORDS. SEC. 2(F).

FOR DIRECTORIES OF BUSINESSES IN IRVINE, CALIFORNIA (U.S. CLS. 2, 5, 22, 23, 29, 37, 38 AND 50).

FIRST USE 1-15-1997; IN COMMERCE 1-15-1997.
JENNY PARK, EXAMINING ATTORNEY

SN 77-148,550. WSL MARKETING, INC., DBA WSL STRATEGIC RETAIL, NEW YORK, NY. FILED 4-4-2007.

RETAIL SAFARI

THE MARK CONSISTS OF STANDARD CHARACTERS WITHOUT CLAIM TO ANY PARTICULAR FONT, STYLE, SIZE, OR COLOR.

NO CLAIM IS MADE TO THE EXCLUSIVE RIGHT TO USE "RETAIL", APART FROM THE MARK AS SHOWN.

FOR BUSINESS REPORTS ON CONSUMER SHOPPING TRENDS IN AMERICA (U.S. CLS. 2, 5, 22, 23, 29, 37, 38 AND 50).

FIRST USE 1-1-2004; IN COMMERCE 4-1-2006.
ALICE BENMAMAN, EXAMINING ATTORNEY

CLASS 16—(Continued).

SN 77-150,116. ELSEVIER LIMITED, KIDLINGTON, OXFORD, UNITED KINGDOM. FILED 4-5-2007.

TETRAHEDRON

THE MARK CONSISTS OF STANDARD CHARACTERS WITHOUT CLAIM TO ANY PARTICULAR FONT, STYLE, SIZE, OR COLOR.

FOR PRINTED PUBLICATIONS, NAMELY, JOURNALS IN THE FIELDS OF SCIENCE AND CHEMISTRY (U.S. CLS. 2, 5, 22, 23, 29, 37, 38 AND 50).

FIRST USE 6-30-1957; IN COMMERCE 6-30-1957.
MICHELE SWAIN, EXAMINING ATTORNEY

SN 77-151,505. INTERNET WEBPAGES NEWSPAPER INC, CHICAGO, IL. FILED 4-9-2007.

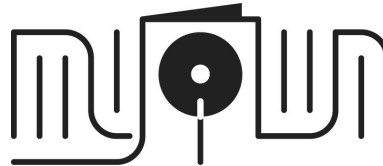

THE MARK CONSISTS OF MYIWN, CONSISTING OF STYLIZED LETTERS RENDERED IN A SOLID STROKE THAT ALSO CONTAIN A DEPICTION OF A PAGE AND CIRCLE DEPICTING A CD/DVD DISC. PAGE AND DISC ARE LOCATED CENTER OF MARK IN BETWEEN LETTERS "MY" AND "WN" WITH THE "I" LOCATED CENTER WITHIN THE DISC IMAGE (SOLID CIRCLE). THE "I" APPEARS LOWER CASE AS A SOLID BLACK STROKE OUTSIDE THE DISC/CIRCLE AND A WHITE STROKE WITHIN THE DISC/CIRCLE. THE MIDDLE OF THE DISC/CIRCLE CONTAINS A SMALLER WHITE DOT OVER THE "I" THAT APPEARS AS A CIRCLE WITHIN THE SOLID BLACK DISC CIRCLE. LETTERS "MY" ARE JOINED TOGETHER WHERE THE END OF THE "M" BECOMES THE BEGINNING OF THE "Y". LIKEWISE, THE END OF THE "Y" FORMS THE LEFT SIDE OF THE PAGE THAT IS A RECTANGLE WITH A SOLID BLACK WEDGE ATOP THE RECTANGLE GIVING THE APPEARANCE OF AN OPEN PAGE OF A PUBLICATION. THE RIGHT SIDE OF THE PAGE/RECTANGLE FORMS THE START OF THE LETTER "W". THE END OF THE "W" FORMS THE BEGINNING OF THE "N" THE RECTANGLE/PAGE IS OPEN AT THE BOTTOM.

FOR NEWSPAPERS (U.S. CLS. 2, 5, 22, 23, 29, 37, 38 AND 50).

KIM SAITO, EXAMINING ATTORNEY

CLASS 16—(Continued).

SN 77-153,489. WALLACK, ROBERT C., PHOENIX, AZ. FILED 4-10-2007.

RacePlace

THE MARK CONSISTS OF STANDARD CHARACTERS WITHOUT CLAIM TO ANY PARTICULAR FONT, STYLE, SIZE, OR COLOR.

FOR A PERIODIC MAGAZINE CONTAINING A SCHEDULE OF UPCOMING SPORTING EVENTS AND APPLICATIONS TO PARTICIPATE IN THOSE EVENTS (U.S. CLS. 2, 5, 22, 23, 29, 37, 38 AND 50).

FIRST USE 12-4-1984; IN COMMERCE 12-4-1984.
BENJAMIN OKEKE, EXAMINING ATTORNEY

CLASS 16—(Continued).

SN 77-153,946. ERIC ARMIN INC., DBA EAI EDUCATION, OAKLAND, NJ. FILED 4-11-2007.

GEOMODEL

THE MARK CONSISTS OF STANDARD CHARACTERS WITHOUT CLAIM TO ANY PARTICULAR FONT, STYLE, SIZE, OR COLOR.

FOR THREE DIMENSIONAL MODELS FOR EDUCATIONAL PURPOSES (U.S. CLS. 2, 5, 22, 23, 29, 37, 38 AND 50).

LEE-ANNE BERNS, EXAMINING ATTORNEY

SN 77-153,707. GIBBENS JR., RICHARD DEAN, YOUNGSTOWN, FL. FILED 4-11-2007.

On The Spot Vinyl

THE MARK CONSISTS OF STANDARD CHARACTERS WITHOUT CLAIM TO ANY PARTICULAR FONT, STYLE, SIZE, OR COLOR.

NO CLAIM IS MADE TO THE EXCLUSIVE RIGHT TO USE "VINYL", APART FROM THE MARK AS SHOWN.

FOR VINYL LETTERS AND NUMBERS FOR USE IN MAKING SIGNS, FOR USE TO CUSTOMIZE COMPUTERS, CARS, AND BICYCLES, AND FOR USE IN MAKING LABELS (U.S. CLS. 2, 5, 22, 23, 29, 37, 38 AND 50).

STEVEN R. FOSTER, EXAMINING ATTORNEY

SN 77-154,910. VICINITY ADS, SPRING, TX. FILED 4-12-2007.

cardCapsule

THE MARK CONSISTS OF STANDARD CHARACTERS WITHOUT CLAIM TO ANY PARTICULAR FONT, STYLE, SIZE, OR COLOR.

FOR PORTABLE ADVERTISEMENT CARD DISPENSER (U.S. CLS. 2, 5, 22, 23, 29, 37, 38 AND 50).

FIRST USE 3-1-2007; IN COMMERCE 3-1-2007.
AMY BROZENIC, EXAMINING ATTORNEY

SN 77-153,740. INSTITUTE OF MANAGEMENT ACCOUNTANTS, MONTVALE, NJ. FILED 4-11-2007.

IMA EDUCATIONAL CASE JOURNAL

THE MARK CONSISTS OF STANDARD CHARACTERS WITHOUT CLAIM TO ANY PARTICULAR FONT, STYLE, SIZE, OR COLOR.

NO CLAIM IS MADE TO THE EXCLUSIVE RIGHT TO USE "EDUCATIONAL CASE JOURNAL", APART FROM THE MARK AS SHOWN.

FOR JOURNALS IN THE FIELD OF MANAGEMENT ACCOUNTING (U.S. CLS. 2, 5, 22, 23, 29, 37, 38 AND 50).
B. PARADEWELAI, EXAMINING ATTORNEY

SN 77-155,503. ORTIZ, TIM, LA JOLLA, CA. FILED 4-12-2007.

NEUROGRAVITY

THE MARK CONSISTS OF STANDARD CHARACTERS WITHOUT CLAIM TO ANY PARTICULAR FONT, STYLE, SIZE, OR COLOR.

FOR BOOKS IN THE FIELD OF SELF AWARENESS (U.S. CLS. 2, 5, 22, 23, 29, 37, 38 AND 50).
LEE-ANNE BERNS, EXAMINING ATTORNEY

CLASS 16—(Continued).

SN 77-155,572. YOUR HARTFORD ENTERPRISES, LLC, BLOOMFIELD, CT. FILED 4-12-2007.



THE MARK CONSISTS OF THE STYLIZED LETTERS Y AND H AND THE STYLIZED WORDS YOUR HARTFORD. FOR PRINTED MATTER AND PUBLICATIONS, NAMELY, MAGAZINES FEATURING PHOTOJOURNALISM (U.S. CLS. 2, 5, 22, 23, 29, 37, 38 AND 50).
LINDA ORNDORFF, EXAMINING ATTORNEY

CLASS 16—(Continued).

SN 77-155,744. AMERIKU LTD, HARTVILLE, OH. FILED 4-12-2007.

Ameriku

THE MARK CONSISTS OF STANDARD CHARACTERS WITHOUT CLAIM TO ANY PARTICULAR FONT, STYLE, SIZE, OR COLOR.

FOR ART PICTURES; ART PRINTS; GRAPHIC ART REPRODUCTIONS; PICTURE POSTCARDS; PICTURES; PRINTED ART REPRODUCTIONS; PRINTS IN THE NATURE OF PHOTOGRAPHS, PICTURES, GRAPHIC ART; BLANK CARDS; BLANK JOURNAL BOOKS; BLANK NOTE CARDS; BLANK OR PARTIALLY PRINTED POSTCARDS; BLANK WRITING JOURNALS; CARDS, NAMELY, NOTE CARDS, GREETING CARDS, OCCASION CARDS, SOCIAL CARDS, BLANK CARDS, INVITATION CARDS; GREETING CARDS; INVITATION CARDS; NOTE CARDS; OCCASION CARDS; SOCIAL NOTE CARDS; BOOKMARKS; CALENDARS; PRINTED CALENDARS; WALL CALENDARS; FABRIC GIFT BAGS; GIFT CARDS; MOUNTED AND UNMOUNTED PHOTOGRAPHS; MOUNTED POSTERS; PHOTOGRAPHIC PRINTS; UNMOUNTED POSTERS; COLOR PRINTS; PICTORIAL PRINTS; POSTCARDS; POSTERS; POSTERS MADE OF PAPER; PRINTS (U.S. CLS. 2, 5, 22, 23, 29, 37, 38 AND 50).

FIRST USE 10-6-2006; IN COMMERCE 12-1-2006.

RAUL CORDOVA, EXAMINING ATTORNEY

SN 77-155,779. BUFALO, CAMILLO L, INDIANA, PA. FILED 4-13-2007.

Side Effect Euphoria

THE MARK CONSISTS OF STANDARD CHARACTERS WITHOUT CLAIM TO ANY PARTICULAR FONT, STYLE, SIZE, OR COLOR.

FOR COMIC BOOKS (U.S. CLS. 2, 5, 22, 23, 29, 37, 38 AND 50).

KIMBERLY PERRY, EXAMINING ATTORNEY

SN 77-155,658. ALVORD, ALYSSA M, AUSTIN, TX. AND ALVORD, JONATHAN A, AUSTIN, TX. FILED 4-12-2007.

Zen Sexy

THE MARK CONSISTS OF STANDARD CHARACTERS WITHOUT CLAIM TO ANY PARTICULAR FONT, STYLE, SIZE, OR COLOR.

FOR MAGAZINES FEATURING NATURAL HEALTH AND LIVING, WOMEN'S ISSUES, CLOTHING, GREEN LIVING, SPIRITUAL GROWTH (U.S. CLS. 2, 5, 22, 23, 29, 37, 38 AND 50).

GEORGIA CARTY, EXAMINING ATTORNEY

SN 77-156,652. JACKIE GINGRICH CUSHMAN CONSULTING, INC., ATLANTA, GA. FILED 4-13-2007.

INSPIRATION TO GO

THE MARK CONSISTS OF STANDARD CHARACTERS WITHOUT CLAIM TO ANY PARTICULAR FONT, STYLE, SIZE, OR COLOR.

FOR PRINTED CARDS CONTAINING RELIGIOUS OR NOTABLE QUOTES HELD IN A SLEEVE ADAPTED TO ATTACH TO A CAR VISOR (U.S. CLS. 2, 5, 22, 23, 29, 37, 38 AND 50).

KATHERINE M. DUBRAY, EXAMINING ATTORNEY

CLASS 16—(Continued).

SN 77-156,655. DEMARTINI, CHRISTA, RAMONA, CA.
FILED 4-13-2007.

Wall Slicks

THE MARK CONSISTS OF STANDARD CHARACTERS WITHOUT CLAIM TO ANY PARTICULAR FONT, STYLE, SIZE, OR COLOR.

NO CLAIM IS MADE TO THE EXCLUSIVE RIGHT TO USE "WALL", APART FROM THE MARK AS SHOWN, FOR WALL DECALS, NAMELY, ADHESIVE VINYL WALL GRAPHICS FOR INTERIOR SPACES (U.S. CLS. 2, 5, 22, 23, 29, 37, 38 AND 50).

JAY FLOWERS, EXAMINING ATTORNEY

SN 77-156,721. ALIZZANO, LLC, SANTA MONICA, CA.
FILED 4-13-2007.

BREADBYTES

THE MARK CONSISTS OF STANDARD CHARACTERS WITHOUT CLAIM TO ANY PARTICULAR FONT, STYLE, SIZE, OR COLOR.

FOR NEWSLETTERS IN THE FIELD OF BAKERY GOODS (U.S. CLS. 2, 5, 22, 23, 29, 37, 38 AND 50).

GENE MACIOL, EXAMINING ATTORNEY

SN 77-156,732. CERNIK, LEONARD G., LINCOLN, NE.
FILED 4-13-2007.

Cosmic Eliminator

THE MARK CONSISTS OF STANDARD CHARACTERS WITHOUT CLAIM TO ANY PARTICULAR FONT, STYLE, SIZE, OR COLOR.

FOR SERIES OF FICTION BOOKS (U.S. CLS. 2, 5, 22, 23, 29, 37, 38 AND 50).

GENE MACIOL, EXAMINING ATTORNEY

CLASS 16—(Continued).

SN 77-156,735. CERNIK, LEONARD G, LINCOLN, NE.
FILED 4-13-2007.

Cosmic Eliminator Unanimous Anonymous

THE MARK CONSISTS OF STANDARD CHARACTERS WITHOUT CLAIM TO ANY PARTICULAR FONT, STYLE, SIZE, OR COLOR.

FOR SERIES OF FICTION BOOKS (U.S. CLS. 2, 5, 22, 23, 29, 37, 38 AND 50).

GENE MACIOL, EXAMINING ATTORNEY

SN 77-156,894. GRETCHEN COWEN, SAN DIEGO, CA.
FILED 4-14-2007.

Sarea Hamna

THE MARK CONSISTS OF STANDARD CHARACTERS WITHOUT CLAIM TO ANY PARTICULAR FONT, STYLE, SIZE, OR COLOR.

THE NAME SAREA HAMNA DOES NOT IDENTIFY A LIVING INDIVIDUAL.

FOR ART PRINTS (U.S. CLS. 2, 5, 22, 23, 29, 37, 38 AND 50).

FIRST USE 2-0-2007; IN COMMERCE 2-0-2007.

MICHELE SWAIN, EXAMINING ATTORNEY

SN 77-156,949. SURF SAFARI, INC., SAN CLEMENTE, CA.
FILED 4-14-2007.



OWNER OF U.S. REG. NO. 2,115,968.

THE MARK CONSISTS OF THE MARK CONSISTS OF A PETROGLYPH TYPE DESIGN OF A STICK FIGURE SURFER CARRYING A SURFBOARD OVER HIS HEAD. THE STIPPLING SHOWN IN THE DRAWING IS A FEATURE OF THE MARK AND NOT INTENDED TO INDICATE COLOR.

FOR POSTCARDS; CALENDARS; PRINTED PERIODICALS IN THE FIELD OF SURFING (U.S. CLS. 2, 5, 22, 23, 29, 37, 38 AND 50).

FIRST USE 2-28-1994; IN COMMERCE 2-28-1994.

ANGELA M. MICHELI, EXAMINING ATTORNEY

CLASS 16—(Continued).

SN 77-157,070. CLG2, LLC, LAUREL, MD. FILED 4-15-2007.

CLG2

THE MARK CONSISTS OF STANDARD CHARACTERS WITHOUT CLAIM TO ANY PARTICULAR FONT, STYLE, SIZE, OR COLOR.

FOR CHILDREN'S BOOKS (U.S. CLS. 2, 5, 22, 23, 29, 37, 38 AND 50).

CHRISTINA SOBRAL, EXAMINING ATTORNEY

SN 77-157,136. LOPEZ, ROBERT G., NEW YORK, NY. FILED 4-16-2007.



NO CLAIM IS MADE TO THE EXCLUSIVE RIGHT TO USE "GLOBAL" AND "PUBLISHING", APART FROM THE MARK AS SHOWN.

FOR PUBLICATIONS, NAMELY, BROCHURES, BOOKLETS, AND TEACHING MATERIALS IN THE FIELD OF CRIMINAL JUSTICE AND PRISON LIFE; NEWSLETTERS IN THE FIELD OF CRIMINAL LAW DEVELOPMENTS AND PRISON STATISTICS; SERIES OF FICTION BOOKS; SERIES OF NON-FICTION BOOKS IN THE FIELD OF TRUE CRIME AND URBAN STREET CULTURE; MAGAZINES FEATURING NEWS, INTERVIEWS AND INFORMATION ON THE CRIMINAL JUSTICE SYSTEM, PRISON LIFE AND URBAN STREET CULTURE (U.S. CLS. 2, 5, 22, 23, 29, 37, 38 AND 50).

FIRST USE 11-4-2006; IN COMMERCE 11-4-2006.

LINDSEY RUBIN, EXAMINING ATTORNEY

CLASS 16—(Continued).

SN 77-157,308. LABRO GUIDETTI, INC. D/B/A SAVOIR FAIRE, NOVATO, CA. FILED 4-16-2007.

PAINT WITH JANE

THE MARK CONSISTS OF STANDARD CHARACTERS WITHOUT CLAIM TO ANY PARTICULAR FONT, STYLE, SIZE, OR COLOR.

FOR ARTS AND CRAFT SUPPLIES, NAMELY, ART PAPER, ARTISTS' BRUSHES, ARTISTS' PASTELS, ARTISTS' PENCILS, ARTISTS' PENS, ARTS AND CRAFTS PAINT KITS, BRISTOL BOARDS, CANVAS FOR PAINTING, CANVAS PANELS FOR ARTISTS, CHALK, CHALK ERASERS, CHARCOAL PENCILS, CHILDREN'S ACTIVITY BOOKS, COLOR PENCILS, COLORING BOOKS, COLORED PENS, CONSTRUCTION PAPER, CRAFT PAPER, CRAYONS, CREPE PAPER, DRAWING BRUSHES, DRAWING PADS, DRAWING PAPER, DRAWING PENCILS, EASEL PADS, EASELS, FELT PENS, MODELING CLAY, MOLDS FOR MODELING CLAY, PAINT BRUSHES, PAINTING PALETTES, OIL PASTELS, PASTEL CRAYONS, PASTELS, PENCIL SHARPENERS, PENCILS FOR PAINTING AND DRAWING, SKETCH BOOKS, SKETCH PADS, STENCILS AND ARTISTS' EASELS (U.S. CLS. 2, 5, 22, 23, 29, 37, 38 AND 50).

JOHN GARTNER, EXAMINING ATTORNEY

SN 77-157,338. DAVIS WINDOW AND DOOR CO., NORCROSS, GA. FILED 4-16-2007.

beat the uglies

THE MARK CONSISTS OF STANDARD CHARACTERS WITHOUT CLAIM TO ANY PARTICULAR FONT, STYLE, SIZE, OR COLOR.

FOR ADVERTISING PAMPHLETS; ADVERTISING SIGNS OF PAPER OR CARDBOARD; BROCHURES ABOUT HOME IMPROVEMENT; INFORMATIONAL FLYERS FEATURING HOME IMPROVEMENT; INFORMATIONAL SHEETS ABOUT HOME IMPROVEMENT; LEAFLETS ABOUT HOME IMPROVEMENT (U.S. CLS. 2, 5, 22, 23, 29, 37, 38 AND 50).

ROBIN CHOSID, EXAMINING ATTORNEY

CLASS 16—(Continued).

SN 77-157,550. BLIEDEN, PAUL, MANHATTAN BEACH, CA. FILED 4-16-2007.

THE EMERGING GODDESS

THE MARK CONSISTS OF STANDARD CHARACTERS WITHOUT CLAIM TO ANY PARTICULAR FONT, STYLE, SIZE, OR COLOR.

FOR BOOKMARKS; CALENDAR DESK PADS; CALENDAR REFILLS; CALENDAR STANDS; CALENDAR-FINISHED PAPER; CALENDARS; DESK CALENDARS; MOUNTED POSTERS; POSTERS; POSTERS MADE OF PAPER; PRINTED CALENDARS; UNMOUNTED POSTERS; WALL CALENDARS (U.S. CLS. 2, 5, 22, 23, 29, 37, 38 AND 50).

CHARLES L. JENKINS, EXAMINING ATTORNEY

SN 77-157,561. TUROWSKI, THOMAS, A, VALRICO, FL. FILED 4-16-2007.

A"MAZE"ING Quotes and Sayings

THE MARK CONSISTS OF STANDARD CHARACTERS WITHOUT CLAIM TO ANY PARTICULAR FONT, STYLE, SIZE, OR COLOR.

NO CLAIM IS MADE TO THE EXCLUSIVE RIGHT TO USE "QUOTES AND SAYINGS", APART FROM THE MARK AS SHOWN.

FOR WORD PUZZLES FEATURED IN MAGAZINES AND NEWSPAPERS (U.S. CLS. 2, 5, 22, 23, 29, 37, 38 AND 50).

FIRST USE 5-1-2006; IN COMMERCE 11-1-2006. SCOTT SISUN, EXAMINING ATTORNEY

CLASS 16—(Continued).

SN 77-157,574. PAINTING AND DECORATING CONTRACTORS OF AMERICA, INCORPORATED, ST. LOUIS, MO. FILED 4-16-2007.



NO CLAIM IS MADE TO THE EXCLUSIVE RIGHT TO USE "PAINTING AND DECORATING CONTRACTORS OF AMERICA" AND "OFFICIAL MAGAZINE", APART FROM THE MARK AS SHOWN.

THE MARK CONSISTS OF A RECTANGLE WITH THE WORDING PDCA ON THE LEFT AND THE WORDING PAINTING AND DECORATING CONTRACTORS OF AMERICA IN A CONCENTRIC CIRCLE ABOVE A PAINT BRUSH AND PAINT PALETTE DESIGN WITH THE LETTERS 18 ON THE LEFT SIDE AND 84 ON THE RIGHT. THE TERMS DECO OFFICIAL MAGAZINE OF THE PDCA APPEAR NEXT TO AND UNDER THE DESIGN.

FOR MAGAZINES FEATURING INFORMATION AND ARTICLES ABOUT INTERIOR AND EXTERIOR PAINTING AND DECORATIVE FINISHING IN THE RESIDENTIAL, COMMERCIAL AND INDUSTRIAL ENVIRONMENTS DIRECTED TO PAINTING AND DECORATING CONTRACTORS (U.S. CLS. 2, 5, 22, 23, 29, 37, 38 AND 50).

CAROLINE WOOD, EXAMINING ATTORNEY

SN 77-157,671. AGC, INC., CLEVELAND, OH. FILED 4-16-2007.

TRUE TO YOU

THE MARK CONSISTS OF STANDARD CHARACTERS WITHOUT CLAIM TO ANY PARTICULAR FONT, STYLE, SIZE, OR COLOR.

FOR GREETING CARDS (U.S. CLS. 2, 5, 22, 23, 29, 37, 38 AND 50).

MICHELE SWAIN, EXAMINING ATTORNEY

CLASS 16—(Continued).

SN 77-157,872. PACKAGING MACHINERY MANUFACTURERS INSTITUTE, ARLINGTON, VA. FILED 4-16-2007.

PACK EXPO CONTAINERS & MATERIALS SPOTLIGHT

THE MARK CONSISTS OF STANDARD CHARACTERS WITHOUT CLAIM TO ANY PARTICULAR FONT, STYLE, SIZE, OR COLOR.

OWNER OF U.S. REG. NOS. 1,407,016, 2,345,710 AND OTHERS.

NO CLAIM IS MADE TO THE EXCLUSIVE RIGHT TO USE "CONTAINERS AND MATERIALS", APART FROM THE MARK AS SHOWN.

FOR PRINTED PUBLICATIONS, NAMELY MAGAZINES CONTAINING ARTICLES AND CONTENT OF INTEREST TO THE CONTAINERS AND MATERIALS SEGMENT OF THE PACKAGING INDUSTRY (U.S. CLS. 2, 5, 22, 23, 29, 37, 38 AND 50).

KIMBERLY FRYE, EXAMINING ATTORNEY

SN 77-158,266. WILLIAMS, RON, OWASSO, OK. FILED 4-17-2007.

HANG ON CRYSTAL

THE MARK CONSISTS OF STANDARD CHARACTERS WITHOUT CLAIM TO ANY PARTICULAR FONT, STYLE, SIZE, OR COLOR.

NO CLAIM IS MADE TO THE EXCLUSIVE RIGHT TO USE "CRYSTAL", APART FROM THE MARK AS SHOWN.

FOR PAPER, NAMELY CONSTRUCTION PAPER ON WHICH CRYSTALS ARE GROWN (U.S. CLS. 2, 5, 22, 23, 29, 37, 38 AND 50).

FIRST USE 4-2-2007; IN COMMERCE 4-2-2007.

MARGERY A. TIERNEY, EXAMINING ATTORNEY

SN 77-158,267. JAMES, SARA, BROOKLYN, NY. AND RUCKDESCHEL, LIZ, LOS ANGELES, CA. FILED 4-17-2007.

Choose Your Destiny

THE MARK CONSISTS OF STANDARD CHARACTERS WITHOUT CLAIM TO ANY PARTICULAR FONT, STYLE, SIZE, OR COLOR.

FOR NOVELS (U.S. CLS. 2, 5, 22, 23, 29, 37, 38 AND 50).

FIRST USE 6-27-2006; IN COMMERCE 6-27-2006.

MARGERY A. TIERNEY, EXAMINING ATTORNEY

CLASS 16—(Continued).

SN 77-158,375. STANLEY, DONALD, BRIARCLIFF, TX. FILED 4-17-2007.

Yoga for the Pleasingly Plump

THE MARK CONSISTS OF STANDARD CHARACTERS WITHOUT CLAIM TO ANY PARTICULAR FONT, STYLE, SIZE, OR COLOR.

NO CLAIM IS MADE TO THE EXCLUSIVE RIGHT TO USE "YOGA", APART FROM THE MARK AS SHOWN.

FOR BOOKS IN THE FIELD OF YOGA INSTRUCTION (U.S. CLS. 2, 5, 22, 23, 29, 37, 38 AND 50).

KATHLEEN M. VANSTON, EXAMINING ATTORNEY

SN 77-158,508. ROCKLINE INDUSTRIES, INC., SHEBOYGAN, WI. FILED 4-17-2007.

NATURAL CHOICE

THE MARK CONSISTS OF STANDARD CHARACTERS WITHOUT CLAIM TO ANY PARTICULAR FONT, STYLE, SIZE, OR COLOR.

OWNER OF U.S. REG. NO. 2,458,214.

FOR DISPOSABLE DIAPERS AND TRAINING PANTS (U.S. CLS. 2, 5, 22, 23, 29, 37, 38 AND 50).

KEVIN DINALLO, EXAMINING ATTORNEY

SN 77-158,524. THREE DESIGNING WOMEN, INC., CARROLLTON, TX. FILED 4-17-2007.

THREE DESIGNING WOMEN

THE MARK CONSISTS OF STANDARD CHARACTERS WITHOUT CLAIM TO ANY PARTICULAR FONT, STYLE, SIZE, OR COLOR.

FOR STATIONERY, ENVELOPES, NOTE PAPER, WRITING PAPER HOLDERS, NOTE PADS, INK STAMPS, PAPER EMBOSSERS, FOIL SEALS FOR EMBOSSERS, STAMP INKS, PAPER TAGS, PAPER GIFT TAGS, PAPER WINE TAGS, ANNOUNCEMENT CARDS, INVITATION CARDS AND PERSONALIZED NON-MAGNETIC CALLING CARDS (U.S. CLS. 2, 5, 22, 23, 29, 37, 38 AND 50).

ELLEN BURNS, EXAMINING ATTORNEY

CLASS 16—(Continued).

SN 77-158,538. TRI-CITY VALLEYCATS, INC., TROY, NY. FILED 4-17-2007.



FOR PAPER GOODS AND PRINTED MATTER, NAMELY, AUTOGRAPH BOOKS, BINDERS, BOOK-MARKS, BUMPER STICKERS, CALENDARS, DECALS, MERCHANDISE BAGS, NEWSLETTERS OF INTEREST TO BASEBALL FANS IN THE FIELD OF BASEBALL, NOTE PADS, PAPER CONTAINERS, PAPER PENNANTS, PRINTED PAPER SPORTS AND TOURNAMENT SCHEDULES, PENS, PENCILS, POSTCARDS, POSTERS, PRINTED AWARDS, PRINTED GAME TICKETS, SCORE BOOKS, SCORE CARDS, SCORE SHEETS, STATIONERY, STICKERS, STICKER ALBUMS AND TRADING CARDS (U.S. CLS. 2, 5, 22, 23, 29, 37, 38 AND 50).

FIRST USE 4-1-2002; IN COMMERCE 4-1-2002.
TANYA AMOS, EXAMINING ATTORNEY

SN 77-158,600. JOHNSON, SHERESE Y, CHARLOTTE, NC. FILED 4-17-2007.

The Small Business Addiction

THE MARK CONSISTS OF STANDARD CHARACTERS WITHOUT CLAIM TO ANY PARTICULAR FONT, STYLE, SIZE, OR COLOR.

NO CLAIM IS MADE TO THE EXCLUSIVE RIGHT TO USE "SMALL BUSINESS", APART FROM THE MARK AS SHOWN.

FOR PRINTED INSTRUCTIONAL, EDUCATIONAL, AND TEACHING MATERIALS IN THE FIELD OF PERSONAL AND BUSINESS ISSUES OF ENTREPRENEURSHIP AND THE OPERATION OF SMALL BUSINESSES CONSISTING OF BOOKS, STICKERS, BOOKMARKS, WORKBOOKS, INFORMATION PACKS, CERTIFICATES, MANUALS, WORK SHEETS, TEMPLATES, AND FORMS (U.S. CLS. 2, 5, 22, 23, 29, 37, 38 AND 50).

ALICE SUE CARRUTHERS, EXAMINING ATTORNEY

CLASS 16—(Continued).

SN 77-159,188. RESOURCE LABELGROUP, LLC, FRANK-LIN, TN. FILED 4-18-2007.

Smooth-peel

THE MARK CONSISTS OF STANDARD CHARACTERS WITHOUT CLAIM TO ANY PARTICULAR FONT, STYLE, SIZE, OR COLOR.

FOR ADHESIVE LABELS; BAR CODE LABELS; BLANK OR PARTIALLY PRINTED PAPER LABELS; PAPER LABELS; PRINTED NOVELTY WINE LABELS; PRINTED PAPER LABELS; SHIPPING LABELS (U.S. CLS. 2, 5, 22, 23, 29, 37, 38 AND 50).

CHRIS WELLS, EXAMINING ATTORNEY

SN 77-159,219. CONNECTICUT ATTORNEYS TITLE INSURANCE COMPANY, ROCKY HILL, CT. FILED 4-18-2007.



OWNER OF U.S. REG. NOS. 2,100,831, 3,099,414 AND OTHERS.

THE MARK CONSISTS OF A BLOCK C DESIGN WITH THE WORDS "CATIC ACCESS TO SUCCESS."

FOR PRINTED PUBLICATIONS, NAMELY, NEWSLETTERS, BULLETINS, AND PROFESSIONAL JOURNALS IN THE FIELD OF TITLE INSURANCE AND REAL PROPERTY LAW (U.S. CLS. 2, 5, 22, 23, 29, 37, 38 AND 50).

CHRIS WELLS, EXAMINING ATTORNEY

SN 77-159,546. JONASSEN, JANICE B., WESTLAKE VIL-LAGE, CA. FILED 4-18-2007.

THOU SHALT NOT WHINE - THE 11TH COMMANDMENT

THE MARK CONSISTS OF STANDARD CHARACTERS WITHOUT CLAIM TO ANY PARTICULAR FONT, STYLE, SIZE, OR COLOR.

FOR SERIES OF NON-FICTION BOOKS IN THE FIELD OF SELF-HELP (U.S. CLS. 2, 5, 22, 23, 29, 37, 38 AND 50).

AMY BROZENIC, EXAMINING ATTORNEY

CLASS 16—(Continued).

SN 77-159,965. MARK NEWMAN, ANAHEIM, CA. FILED 4-18-2007.

theMANgene[↗]
the 47th Chromosome

THE COLOR(S) RED AND BLACK IS/ARE CLAIMED AS A FEATURE OF THE MARK.

THE MARK CONSISTS OF THE WORDS "THE MAN GENE THE 47TH CHROMOSOME" IN A CHARACTERISTIC FONT AND THE DESIGN OF AN ARROW EXTENDING OUT FROM THE SECOND "E" IN THE WORD "GENE." THE WORD "MAN" APPEARS IN RED WITH BLACK OUTLINE. THE WORDS "THE" AND "GENE" AND THE ARROW APPEAR IN BLACK WITH RED OUTLINES. THE WORDING "THE 47TH CHROMOSOME" APPEARS IN BLACK.

FOR A SERIES OF BOOKS, WRITTEN ARTICLES, HANDOUTS AND WORKSHEETS IN THE FIELD OF MEN'S HEALTH AND FITNESS; BOOKS IN THE FIELD OF MEN'S HEALTH AND FITNESS; EDUCATIONAL BOOKS FEATURING MEN'S HEALTH AND FITNESS; SERIES OF NON-FICTION BOOKS IN THE FIELD OF MEN'S HEALTH AND FITNESS (U.S. CLS. 2, 5, 22, 23, 29, 37, 38 AND 50).

KATHERINE CONNOLLY, EXAMINING ATTORNEY

SN 77-160,230. NEW HEIGHTS MEDIA, INC., FORT LEE, NJ. FILED 4-18-2007.

The People Skills Experts

THE MARK CONSISTS OF STANDARD CHARACTERS WITHOUT CLAIM TO ANY PARTICULAR FONT, STYLE, SIZE, OR COLOR.

FOR A SERIES OF BOOKS, WRITTEN ARTICLES, HANDOUTS AND WORKSHEETS IN THE FIELD OF BUSINESS COMMUNICATIONS (U.S. CLS. 2, 5, 22, 23, 29, 37, 38 AND 50).

CHERYL CLAYTON, EXAMINING ATTORNEY

CLASS 16—(Continued).

SN 77-160,579. TINA COLLEN ASSOCIATES, LTD., BOULDER, CO. FILED 4-19-2007.

Fleurotica

THE MARK CONSISTS OF STANDARD CHARACTERS WITHOUT CLAIM TO ANY PARTICULAR FONT, STYLE, SIZE, OR COLOR.

FOR ART PRINTS; BLANK OR PARTIALLY PRINTED POSTCARDS; COLLAGES; COLOR PRINTS; LITHOGRAPHIC PRINTS; LITHOGRAPHS; MOUNTED AND UNMOUNTED PHOTOGRAPHS; MOUNTED POSTERS; PHOTOGRAPHIC ALBUMS; PHOTOGRAPHIC PRINTS; PHOTOGRAPHS; POSTERS; POSTERS MADE OF PAPER; PRINTED ART REPRODUCTIONS; PRINTED CALENDARS; PRINTED PAPER LABELS; PRINTS; PRINTS IN THE NATURE OF PHOTOGRAPHS AND LITHOGRAPHS; UNMOUNTED POSTERS (U.S. CLS. 2, 5, 22, 23, 29, 37, 38 AND 50).

FIRST USE 6-28-1996; IN COMMERCE 1-6-1997.

KRISTIN DAHLING, EXAMINING ATTORNEY

SN 77-161,436. AGC, INC., CLEVELAND, OH. FILED 4-20-2007.

LAUGH TRACKS

THE MARK CONSISTS OF STANDARD CHARACTERS WITHOUT CLAIM TO ANY PARTICULAR FONT, STYLE, SIZE, OR COLOR.

FOR GREETING CARDS (U.S. CLS. 2, 5, 22, 23, 29, 37, 38 AND 50).

MICHELE SWAIN, EXAMINING ATTORNEY

SN 77-161,527. MCCLATCHY U.S.A., INC., SACRAMENTO, CA. FILED 4-20-2007.

THE BRIEF

THE MARK CONSISTS OF STANDARD CHARACTERS WITHOUT CLAIM TO ANY PARTICULAR FONT, STYLE, SIZE, OR COLOR.

FOR PRINTED PERIODICAL IN THE FIELD OF BUSINESS (U.S. CLS. 2, 5, 22, 23, 29, 37, 38 AND 50).

FIRST USE 8-1-2006; IN COMMERCE 8-1-2006.

KAREN K. BUSH, EXAMINING ATTORNEY

CLASS 16—(Continued).

SN 77-161,643. EUGENE DAYMUDE, NEW ORLEANS, LA. FILED 4-20-2007.

REVELATION IS THE REVOLUTION

THE MARK CONSISTS OF STANDARD CHARACTERS WITHOUT CLAIM TO ANY PARTICULAR FONT, STYLE, SIZE, OR COLOR.

FOR WORKS OF ART, NAMELY, ART PRINTS, PRINTED ART REPRODUCTIONS, POSTERS, LITHOGRAPHS, COLOR PRINTS AND PICTORIAL PRINTS (U.S. CLS. 2, 5, 22, 23, 29, 37, 38 AND 50).

JOHN DWYER, EXAMINING ATTORNEY

SN 77-161,812. MCCLATCHY U.S.A., INC., SACRAMENTO, CA. FILED 4-20-2007.

SURGE

THE MARK CONSISTS OF STANDARD CHARACTERS WITHOUT CLAIM TO ANY PARTICULAR FONT, STYLE, SIZE, OR COLOR.

FOR PRINTED PERIODICAL FEATURING NEWS, ENTERTAINMENT AND LEISURE INFORMATION (U.S. CLS. 2, 5, 22, 23, 29, 37, 38 AND 50).

FIRST USE 8-3-2006; IN COMMERCE 8-3-2006.

KAREN K. BUSH, EXAMINING ATTORNEY

SN 77-162,068. BOOK FAIRY, INC., OMAHA, NE. FILED 4-20-2007.

BOOK FAIRY

THE MARK CONSISTS OF STANDARD CHARACTERS WITHOUT CLAIM TO ANY PARTICULAR FONT, STYLE, SIZE, OR COLOR.

NO CLAIM IS MADE TO THE EXCLUSIVE RIGHT TO USE BOOK, APART FROM THE MARK AS SHOWN.

FOR BOOK HOLDERS (U.S. CLS. 2, 5, 22, 23, 29, 37, 38 AND 50).

ELLEN PERKINS, EXAMINING ATTORNEY

CLASS 16—(Continued).

SN 77-162,074. BOOK FAIRY, INC., OMAHA, NE. FILED 4-20-2007.



NO CLAIM IS MADE TO THE EXCLUSIVE RIGHT TO USE BOOK, APART FROM THE MARK AS SHOWN.

THE MARK CONSISTS OF A FAIRY BETWEEN THE WORD, BOOK, AND THE WORD, FAIRY. THE FAIRY HOLDS A WAND WITH A STAR AT THE END OF THE WAND.

FOR BOOK HOLDERS (U.S. CLS. 2, 5, 22, 23, 29, 37, 38 AND 50).

ELLEN PERKINS, EXAMINING ATTORNEY

SN 77-162,210. BOUNCING CRANBERRIES LLC, NARRAGANSETT, RI. FILED 4-20-2007.

SHARE YOUR FLAVOR

THE MARK CONSISTS OF STANDARD CHARACTERS WITHOUT CLAIM TO ANY PARTICULAR FONT, STYLE, SIZE, OR COLOR.

FOR CARTOON PRINTS; PHOTOGRAPHIC PRINTS; BUSINESS CARDS; SOCIAL NOTE CARDS; CARDS BEARING UNIVERSAL GREETINGS; GREETING CARDS; TRADING CARDS; STATIONERY; ANNOUNCEMENT CARDS; CARD FILES; CHRISTMAS CARDS; HOLIDAY CARDS; INVITATION CARDS; MOTIVATIONAL CARDS; NOTE CARDS; OCCASION CARDS; PLACE CARDS; BOXES OF PAPER OR CARDBOARD; CARDBOARD BOXES; PAPER BOXES; PAPER BOXES FOR STORING GREETING CARDS (U.S. CLS. 2, 5, 22, 23, 29, 37, 38 AND 50).

RAY THOMAS, EXAMINING ATTORNEY

CLASS 16—(Continued).

SN 77-162,328. AMERICAN CHRISTIAN COLLEGE, INC.,
MANITOU SPRINGS, CO. FILED 4-20-2007.

SUMMIT MINISTRIES

THE MARK CONSISTS OF STANDARD CHARACTERS
WITHOUT CLAIM TO ANY PARTICULAR FONT, STYLE,
SIZE, OR COLOR.

NO CLAIM IS MADE TO THE EXCLUSIVE RIGHT TO
USE "MINISTRIES", APART FROM THE MARK AS
SHOWN.

FOR PAMPHLETS AND TEXTBOOKS FOR JUNIOR
HIGH AND HIGH SCHOOL HOME SCHOOLING, AND
ADULT EDUCATION (U.S. CLS. 2, 5, 22, 23, 29, 37, 38
AND 50).

FIRST USE 7-4-1993; IN COMMERCE 7-4-1993.
DORITT L. CARROLL, EXAMINING ATTORNEY

SN 77-162,397. GAGLIARDI, HELENE TONI, LOS ANGELES,
CA. FILED 4-20-2007.

LIFEQUAKE

THE MARK CONSISTS OF STANDARD CHARACTERS
WITHOUT CLAIM TO ANY PARTICULAR FONT, STYLE,
SIZE, OR COLOR.

FOR PRINTED TEACHING MATERIALS IN THE
FIELD OF SELF IMPROVEMENT (U.S. CLS. 2, 5, 22, 23,
29, 37, 38 AND 50).

FIRST USE 2-10-1989; IN COMMERCE 2-10-1989.
DAVID H. STINE, EXAMINING ATTORNEY

SN 77-162,426. LEN TRINCA, ST. AUGUSTINE, FL. AND
RENEE TRINCA, ST. AUGUSTINE, FL. FILED 4-21-2007.

TWINKLE TUNES

THE MARK CONSISTS OF STANDARD CHARACTERS
WITHOUT CLAIM TO ANY PARTICULAR FONT, STYLE,
SIZE, OR COLOR.

NO CLAIM IS MADE TO THE EXCLUSIVE RIGHT TO
USE TUNES, APART FROM THE MARK AS SHOWN.

FOR CHILDREN'S INTERACTIVE EDUCATIONAL
BOOKS, NAMELY, MUSICAL BOOKS THAT ALLOW
THE USER TO PLAY A TUNE BY HITTING A KEY-
BOARD THAT IS PART OF THE BOOK (U.S. CLS. 2, 5,
22, 23, 29, 37, 38 AND 50).

JANET LEE, EXAMINING ATTORNEY

CLASS 16—(Continued).

SN 77-164,213. HEYER, JOHN, CORTEZ, CO. FILED 4-24-
2007.

QwikRoute

THE MARK CONSISTS OF STANDARD CHARACTERS
WITHOUT CLAIM TO ANY PARTICULAR FONT, STYLE,
SIZE, OR COLOR.

FOR MAPS (U.S. CLS. 2, 5, 22, 23, 29, 37, 38 AND 50).
FIRST USE 4-0-2007; IN COMMERCE 4-0-2007.
JOHN GARTNER, EXAMINING ATTORNEY

SN 77-164,275. TRENDSETTING MOMS, INC., WINCHE-
STER, MA. FILED 4-24-2007.

Trendsetting Moms

THE MARK CONSISTS OF STANDARD CHARACTERS
WITHOUT CLAIM TO ANY PARTICULAR FONT, STYLE,
SIZE, OR COLOR.

FOR MERCHANDISE BAGS (U.S. CLS. 2, 5, 22, 23, 29,
37, 38 AND 50).

JUDITH HELFMAN, EXAMINING ATTORNEY

SN 77-165,527. MCCLATCHY U.S.A., INC., SACRAMENTO,
CA. FILED 4-25-2007.

BELLE

THE MARK CONSISTS OF STANDARD CHARACTERS
WITHOUT CLAIM TO ANY PARTICULAR FONT, STYLE,
SIZE, OR COLOR.

FOR MAGAZINES FEATURING INFORMATION FOR
WOMEN (U.S. CLS. 2, 5, 22, 23, 29, 37, 38 AND 50).

FIRST USE 12-1-2005; IN COMMERCE 12-1-2005.
KAREN K. BUSH, EXAMINING ATTORNEY

CLASS 16—(Continued).

SN 77-166,146. SHIPMAN & GOODWIN LLP, HARTFORD, CT. FILED 4-26-2007.



SHIPMAN & GOODWINLLP

OWNER OF U.S. REG. NOS. 2,536,828, 2,556,160 AND OTHERS.

NO CLAIM IS MADE TO THE EXCLUSIVE RIGHT TO USE "LLP", APART FROM THE MARK AS SHOWN.

THE MARK CONSISTS OF A DEPICTION OF SAILS OVER THE WORDS "SHIPMAN & GOODWIN LLP".

FOR NEWSLETTERS, PRINTED REPORTS AND MEMORANDA, AND PRINTED INSTRUCTIONAL MATERIALS IN THE FIELD OF LAW (U.S. CLS. 2, 5, 22, 23, 29, 37, 38 AND 50).

DAYNA BROWNE, EXAMINING ATTORNEY

SN 77-166,489. MCNEILLY, JAMES C., BUFFALO, NY. FILED 4-26-2007.

JACKALS OF JUSTICE

THE MARK CONSISTS OF STANDARD CHARACTERS WITHOUT CLAIM TO ANY PARTICULAR FONT, STYLE, SIZE, OR COLOR.

FOR SERIES OF FICTION BOOKS (U.S. CLS. 2, 5, 22, 23, 29, 37, 38 AND 50).

MICHAEL LITZAU, EXAMINING ATTORNEY

CLASS 16—(Continued).

SN 77-175,455. IRENE ZEYGOLIS CHRISTIAN, OLNEY, MD. FILED 5-8-2007.

The Dreamer & The Moon



THE COLOR(S) PURPLE, YELLOW, BLUE, MAGENTA, PINK, BROWN, AND BLACK IS/ARE CLAIMED AS A FEATURE OF THE MARK.

THE MARK CONSISTS OF THE WORDING "THE DREAMER & THE MOON" IN PURPLE, ABOVE A YELLOW CIRCLE DESIGN CONTAINING A BLUE SKY, YELLOW STARS, YELLOW MOON, AND A BROWN-HAIRED, PINK-FACED GIRL WITH MAGENTA FEATURES AND A MAGENTA DRESS, ALL WITH BLACK HIGHLIGHTS AND SHADING THROUGHOUT.

FOR SCHOOL SUPPLY KITS CONTAINING VARIOUS COMBINATIONS OF SELECTED SCHOOL SUPPLIES, NAMELY, WRITING INSTRUMENTS, PENS, PENCILS, MECHANICAL PENCILS, ERASERS, MARKERS, CRAYONS, HIGHLIGHTERS, FOLDERS, NOTEBOOKS, PAPER, GRADUATED RULERS, PROTRACTORS, PAPER CLIPS, PENCIL SHARPENERS, WRITING GRIPS, GLUE AND BOOK MARKS; SOCIAL NOTE CARDS; STORY BOOKS; SERIES OF FICTION BOOKS; OCCASION CARDS; PICTURE BOOKS; INVITATION CARDS; MOTIVATIONAL CARDS; NOTE BOOKS; NOTE CARDS; GREETING CARDS; HOLIDAY CARDS; CHILDREN'S ACTIVITY BOOKS; CHILDREN'S BOOKS; CHRISTMAS CARDS; COLORING BOOKS; CARDS BEARING UNIVERSAL GREETINGS; CARDS, NAMELY, GREETING CARDS, HOLIDAY CARDS, ANY OCCASION CARDS, INSPIRATIONAL CARDS, NOTE CARDS, STATIONERY (U.S. CLS. 2, 5, 22, 23, 29, 37, 38 AND 50).

FIRST USE 11-24-2006; IN COMMERCE 5-7-2007.

JASON LOTT, EXAMINING ATTORNEY

SN 77-176,440. CPAMERICA INTERNATIONAL, INC., ALACHUA, FL. FILED 5-9-2007.

**FRAUD
MATTERS**

THE COLOR(S) GREEN, BLACK AND WHITE IS/ARE CLAIMED AS A FEATURE OF THE MARK.

THE MARK CONSISTS OF THE TERM "FRAUD" IN GREEN FONT, OVER LAYED BY "MATTERS" IN BLACK AND ALL ON A WHITE RECTANGLE.

FOR NEWSLETTERS IN THE FIELD OF FRAUD (U.S. CLS. 2, 5, 22, 23, 29, 37, 38 AND 50).

FIRST USE 1-1-2005; IN COMMERCE 1-1-2005.

LINDA MICKLEBURGH, EXAMINING ATTORNEY

CLASS 16—(Continued).

SN 77-181,610. AGC, INC., CLEVELAND, OH. FILED 5-15-2007.

CLICKS & WISHES

THE MARK CONSISTS OF STANDARD CHARACTERS WITHOUT CLAIM TO ANY PARTICULAR FONT, STYLE, SIZE, OR COLOR.

FOR GREETING CARDS (U.S. CLS. 2, 5, 22, 23, 29, 37, 38 AND 50).

MICHELE SWAIN, EXAMINING ATTORNEY

SN 77-183,298. CHELSEA INDUSTRIES, INC., PEABODY, MA. FILED 5-17-2007.

Re^{♻️}Claim

OWNER OF U.S. REG. NO. 1,920,931.

NO CLAIM IS MADE TO THE EXCLUSIVE RIGHT TO USE THE RECYCLE SYMBOL, APART FROM THE MARK AS SHOWN.

THE MARK CONSISTS OF THE WORD RECLAIM WITH A RECYCLE LOGO IN BETWEEN THE WORDS "RE" AND "CLAIM".

FOR TRASH CAN LINERS (U.S. CLS. 2, 5, 22, 23, 29, 37, 38 AND 50).

FIRST USE 3-0-2007; IN COMMERCE 3-0-2007.
ANDREA BUTLER, EXAMINING ATTORNEY

SN 77-186,107. BUSH INDUSTRIES, INC., JAMESTOWN, NY. FILED 5-21-2007.

READY OPEN

THE MARK CONSISTS OF STANDARD CHARACTERS WITHOUT CLAIM TO ANY PARTICULAR FONT, STYLE, SIZE, OR COLOR.

FOR A CARDBOARD CARTON HAVING A TEAR AWAY PORTION FOR PACKING AND SHIPPING FURNITURE (U.S. CLS. 2, 5, 22, 23, 29, 37, 38 AND 50).

RICHARD A. STRASER, EXAMINING ATTORNEY

CLASS 16—(Continued).

SN 77-186,177. COLLABORATIVE GROWTH, L.L.C., GOLDEN, CO. FILED 5-21-2007.

TESI

THE MARK CONSISTS OF STANDARD CHARACTERS WITHOUT CLAIM TO ANY PARTICULAR FONT, STYLE, SIZE, OR COLOR.

FOR BUSINESS FORMS, NAMELY TEAM AND TEAM MEMBER PERFORMANCE SURVEYS (U.S. CLS. 2, 5, 22, 23, 29, 37, 38 AND 50).

FIRST USE 11-22-2006; IN COMMERCE 11-22-2006.
MARIAM MAHMOUDI, EXAMINING ATTORNEY

SN 77-188,043. BUCHART HORN, INC., YORK, PA. FILED 5-23-2007.

SOLUTIONS TODAY & TOMORROW

THE MARK CONSISTS OF STANDARD CHARACTERS WITHOUT CLAIM TO ANY PARTICULAR FONT, STYLE, SIZE, OR COLOR.

OWNER OF U.S. REG. NO. 3,215,464.

NO CLAIM IS MADE TO THE EXCLUSIVE RIGHT TO USE "SOLUTIONS", APART FROM THE MARK AS SHOWN.

FOR NEWSLETTERS IN THE FIELD OF ARCHITECTURE AND ENGINEERING (U.S. CLS. 2, 5, 22, 23, 29, 37, 38 AND 50).

FIRST USE 12-0-2005; IN COMMERCE 12-0-2005.
LINDA ORNDORFF, EXAMINING ATTORNEY

SN 77-188,872. FRANK MILLER, INC., WEST HOLLYWOOD, CA. FILED 5-23-2007.

300

THE MARK CONSISTS OF STANDARD CHARACTERS WITHOUT CLAIM TO ANY PARTICULAR FONT, STYLE, SIZE, OR COLOR.

FOR SERIES OF COMIC BOOKS, OVERSIZED COMIC BOOKS, GRAPHIC NOVELS, COLORING BOOKS, FICTION AND NONFICTION MAGAZINES AND BOOKS IN THE FIELD OF LEISURE AND ENTERTAINMENT AND NONSPORTS POSTERS, NONSPORTS TRADING CARDS, AND NONSPORTS STICKERS (U.S. CLS. 2, 5, 22, 23, 29, 37, 38 AND 50).

FIRST USE 0-0-1998; IN COMMERCE 0-0-1998.
ALICE BENMAMAN, EXAMINING ATTORNEY

CLASS 16—(Continued).

SN 77-197,091. AGC, INC., CLEVELAND, OH. FILED 6-4-2007.

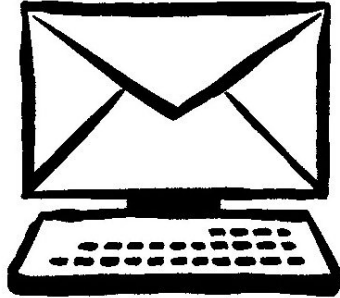

THE MARK CONSISTS OF ENVELOPE IN PLACE OF A COMPUTER MONITOR AND COMPUTER KEYBOARD. FOR GREETING CARDS (U.S. CLS. 2, 5, 22, 23, 29, 37, 38 AND 50).
MICHELE SWAIN, EXAMINING ATTORNEY

SN 77-206,523. MCCLATCHY MANAGEMENT SERVICES, INC., SACRAMENTO, CA. FILED 6-14-2007.

PRIME LIFE

THE MARK CONSISTS OF STANDARD CHARACTERS WITHOUT CLAIM TO ANY PARTICULAR FONT, STYLE, SIZE, OR COLOR.
FOR PRINTED PERIODICAL FEATURING CURRENT EVENTS AND LIFESTYLE INFORMATION FOR SENIORS (U.S. CLS. 2, 5, 22, 23, 29, 37, 38 AND 50).
FIRST USE 11-13-2001; IN COMMERCE 11-13-2001.
ERIN FALK, EXAMINING ATTORNEY

SN 77-210,319. AGC, INC., CLEVELAND, OH. FILED 6-20-2007.

TREASURED EXPRESSIONS

THE MARK CONSISTS OF STANDARD CHARACTERS WITHOUT CLAIM TO ANY PARTICULAR FONT, STYLE, SIZE, OR COLOR.
FOR BLANK JOURNAL BOOKS; BOOKMARKS; ERASERS; MEMO PADS; ADHESIVE NOTE PADS; NOTE PADS; PENCILS; PENS; STATIONERY; PAPER NOTE TABLETS (U.S. CLS. 2, 5, 22, 23, 29, 37, 38 AND 50).
MICHELE SWAIN, EXAMINING ATTORNEY

CLASS 16—(Continued).

SN 78-166,045. PRODUCTOS FAMILIA S.A., MEDELLIN, COLOMBIA, FILED 9-19-2002.



OWNER OF COLOMBIA REG. NO. 266308, DATED 4-22-2003, EXPIRES 4-22-2013.
NO CLAIM IS MADE TO THE EXCLUSIVE RIGHT TO USE "PREMIUM", APART FROM THE MARK AS SHOWN. COLOR IS NOT CLAIMED AS A FEATURE OF THE MARK.
THE ENGLISH TRANSLATION OF "PENQUENIN" IS SMALL AND THE ENGLISH TRANSLATION OF "ADVENTUREROS" IS ADVENTURES. THE MARK IS IN SPANISH. FOR DISPOSABLE DIAPERS (U.S. CLS. 2, 5, 22, 23, 29, 37, 38 AND 50).
FLORENTINA BLANDU, EXAMINING ATTORNEY

SN 78-166,049. PRODUCTOS FAMILIA S.A., MEDELLIN, COLOMBIA, FILED 9-19-2002.



OWNER OF COLOMBIA REG. NO. 266310, DATED 4-22-2003, EXPIRES 4-22-2013.
NO CLAIM IS MADE TO THE EXCLUSIVE RIGHT TO USE "PREMIUM", APART FROM THE MARK AS SHOWN. COLOR IS NOT CLAIMED AS A FEATURE OF THE MARK.
THE ENGLISH TRANSLATION OF "PENQUENIN" IS SMALL AND THE ENGLISH TRANSLATION OF "ACOSTADITOS" IS TO LAY DOWN. THE MARK IS IN SPANISH. FOR DISPOSABLE DIAPERS (U.S. CLS. 2, 5, 22, 23, 29, 37, 38 AND 50).
FLORENTINA BLANDU, EXAMINING ATTORNEY

CLASS 16—(Continued).

SN 78-441,707. AMERICAN MARKETING SERVICES, INC.,
POTOMAC, MD. FILED 6-25-2004.

THE MERCHANDISER NEWSPAPERS

THE MARK CONSISTS OF STANDARD CHARACTERS
WITHOUT CLAIM TO ANY PARTICULAR FONT, STYLE,
SIZE, OR COLOR.

NO CLAIM IS MADE TO THE EXCLUSIVE RIGHT TO
USE "NEWSPAPERS", APART FROM THE MARK AS
SHOWN.

SEC. 2(F).

FOR NEWSPAPERS (U.S. CLS. 2, 5, 22, 23, 29, 37, 38
AND 50).

FIRST USE 9-0-1982; IN COMMERCE 9-0-1982.

CAROL SPILS, EXAMINING ATTORNEY

CLASS 16—(Continued).

SN 78-552,042. BIERMANN PRODUCTIONS LLC, WICHITA,
KS. FILED 1-21-2005.

LIVENTERTAINMENT HD

THE MARK CONSISTS OF STANDARD CHARACTERS
WITHOUT CLAIM TO ANY PARTICULAR FONT, STYLE,
SIZE, OR COLOR.

OWNER OF U.S. REG. NOS. 3,121,699 AND 3,167,983.

NO CLAIM IS MADE TO THE EXCLUSIVE RIGHT TO
USE "LIVE ENTERTAINMENT", APART FROM THE
MARK AS SHOWN.

FOR PRINTED MATERIALS, NAMELY, MAGAZINES,
NEWSPAPERS, ARTICLES, NEWSLETTERS, INFORMA-
TIONAL BROCHURES AND INFORMATIONAL FLYERS
ABOUT THE ENTERTAINMENT INDUSTRY (U.S. CLS.
2, 5, 22, 23, 29, 37, 38 AND 50).

MAUREEN DALL, EXAMINING ATTORNEY

SN 78-630,314. HELMERS PUBLISHING, INC., DUBLIN, NH.
FILED 5-16-2005.

Desktop Engineering

THE MARK CONSISTS OF STANDARD CHARACTERS
WITHOUT CLAIM TO ANY PARTICULAR FONT, STYLE,
SIZE, OR COLOR.

OWNER OF U.S. REG. NO. 2,427,628.

SEC. 2(F).

FOR MAGAZINE PUBLICATION ABOUT COMPU-
TERS AND SOFTWARE IN ENGINEERING (U.S. CLS.
2, 5, 22, 23, 29, 37, 38 AND 50).

FIRST USE 10-1-1995; IN COMMERCE 10-1-1995.

YONG KIM, EXAMINING ATTORNEY

SN 78-497,854. CURLEY, MARK DANIEL, WESLEY CHA-
PEL, FL. FILED 10-11-2004.

Markoni

SN 78-716,769. HUTCHINSON, LYDIA, NASHVILLE, TN.
FILED 9-20-2005.

BE HEARD

THE MARK CONSISTS OF STANDARD CHARACTERS
WITHOUT CLAIM TO ANY PARTICULAR FONT, STYLE,
SIZE, OR COLOR.

FOR PRINTED MATTER, NAMELY, BOOKS, PERIOD-
ICALS, MAGAZINES, POSTERS, STICKERS AND PENS
RELATING TO MUSIC AND THE ENTERTAINMENT
INDUSTRY; PRINTED TRACKING CHARTS FEATUR-
ING STATISTICAL INFORMATION AND COMPARA-
TIVE RANKINGS RELATING TO AIRPLAY OF
RECORDED MUSIC. (U.S. CLS. 2, 5, 22, 23, 29, 37, 38
AND 50).

FIRST USE 7-1-2004; IN COMMERCE 7-1-2004.

WENDY JUN, EXAMINING ATTORNEY

THE MARK CONSISTS OF STANDARD CHARACTERS
WITHOUT CLAIM TO ANY PARTICULAR FONT, STYLE,
SIZE, OR COLOR.

FOR PRINTED MATTER, NAMELY, WEEKLY COM-
MENTARY OF GENERAL INFORMATION APPEARING
IN A SECTION IN A WEEKLY NEWSPAPER IN THE
FIELD OF ENTERTAINMENT (U.S. CLS. 2, 5, 22, 23, 29,
37, 38 AND 50).

FIRST USE 5-13-1999; IN COMMERCE 5-13-1999.

GINA HAYES, EXAMINING ATTORNEY

CLASS 16—(Continued).

SN 78-787,348. DURATECH PLASTICS CORPORATION, CARLSTADT, NJ. FILED 1-9-2006.



NO CLAIM IS MADE TO THE EXCLUSIVE RIGHT TO USE "GROUP", APART FROM THE MARK AS SHOWN. THE MARK CONSISTS OF A STYLIZED VERSION OF THE LETTER "D" AND THE WORDS "DURATECH GROUP". FOR GENERAL PURPOSE PLASTIC GROCERY AND MERCHANDISE BAGS (U.S. CLS. 2, 5, 22, 23, 29, 37, 38 AND 50). FIRST USE 2-28-2002; IN COMMERCE 2-28-2002. DARRYL SPRUILL, EXAMINING ATTORNEY

SN 78-787,379. DURATECH PLASTICS CORPORATION, CARLSTADT, NJ. FILED 1-9-2006.



NO CLAIM IS MADE TO THE EXCLUSIVE RIGHT TO USE "DOGGY", APART FROM THE MARK AS SHOWN. FOR PLASTIC BAGS FOR DISPOSING OF PET WASTE AND/OR STORAGE OF ACCESSORIES, NAMELY, TOYS AND PET SUPPLIES (U.S. CLS. 2, 5, 22, 23, 29, 37, 38 AND 50). FIRST USE 8-1-2005; IN COMMERCE 8-1-2005. DARRYL SPRUILL, EXAMINING ATTORNEY

CLASS 16—(Continued).

SN 78-795,209. XMA, L.L.C., MIDWEST CITY, OK. FILED 1-19-2006.



THE MARK CONSISTS OF STANDARD CHARACTERS WITHOUT CLAIM TO ANY PARTICULAR FONT, STYLE, SIZE, OR COLOR. OWNER OF U.S. REG. NO. 2,911,499. FOR PRINTED MATTER, NAMELY, ADVERTISING SIGNS OF PAPER OR CARDBOARD, CALENDARS, CALENDAR REFILLS, NEWSLETTERS IN THE FIELD OF MARTIAL ARTS, PAPER LABELS, BUMPER STICKERS, MEMORY BOOKS, PHOTOGRAPH ALBUM PAGES, PICTURE BOOKS, PICTURE FRAMING MAT BOARDS, PICTURE POSTCARDS, SCORE BOOKS, SCORE CARDS, STICKERS; STATIONERY; PAPER; DIARIES; PLANNERS, NAMELY, AGENDAS, DAILY PLANNERS, DATE BOOKS, DESKTOP PLANNERS, POCKET PLANNERS, TIME PLANNERS, CALENDAR DESK PADS, POCKET CALENDARS; PARTY GOODS, NAMELY, PAPER PARTY BAGS, PAPER PARTY FAVORS, PAPER PARTY DECORATIONS, PAPER PARTY HATS, PAPER PARTY ORNAMENTS; POSTERS; BOXES, NAMELY, CARDBOARD BOXES, FILE BOXES FOR STORAGE OF BUSINESS AND PERSONAL RECORD, PAPER BOXES, PENCIL OR PEN BOXES, STATIONERY BOXES; PAPER BANNERS (U.S. CLS. 2, 5, 22, 23, 29, 37, 38 AND 50). SANDRA MANIOS, EXAMINING ATTORNEY

SN 78-795,596. XMA, L.L.C., MIDWEST CITY, OK. FILED 1-20-2006.

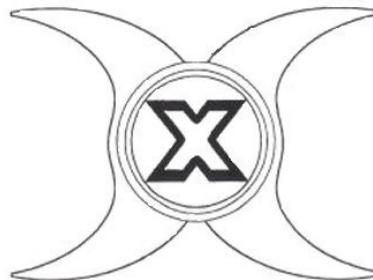

OWNER OF U.S. REG. NOS. 2,977,843 AND 2,985,919. THE MARK CONSISTS OF X AND DESIGN. FOR PRINTED MATTER, NAMELY, ADVERTISING SIGNS OF PAPER OR CARDBOARD, CALENDAR REFILLS, NEWSLETTERS IN THE FIELD OF MARTIAL ARTS, PAPER LABELS, BUMPER STICKERS, MEMORY BOOKS, PHOTOGRAPH ALBUM PAGES, PICTURE BOOKS, PICTURE FRAMING MAT BOARDS, PICTURE POSTCARDS, SCORE BOOKS, SCORE CARDS, STICKERS; STATIONERY; PAPER; CALENDARS; DIARIES; PLANNERS, NAMELY, AGENDAS, DAILY PLANNERS, DATE BOOKS, DESKTOP PLANNERS, TIME PLANNERS, CALENDAR DESK PADS, POCKET CALENDARS; PARTY GOODS, NAMELY, PAPER PARTY BAGS, PAPER PARTY FAVORS, PAPER PARTY DECORATIONS, PAPER PARTY HATS, PAPER PARTY ORNAMENTS; POSTERS; BOXES, NAMELY, CARDBOARD BOXES, FILE BOXES FOR STORAGE OF BUSINESS AND PERSONAL RECORDS, PAPER BOXES, PENCIL OR PEN BOXES, STATIONERY BOXES; PAPER BANNERS (U.S. CLS. 2, 5, 22, 23, 29, 37, 38 AND 50). BARNEY CHARLON, EXAMINING ATTORNEY

CLASS 16—(Continued).

SN 78-865,785. JOHNSON, TINA, PLANO, TX. FILED 4-20-2006.

CLASS 16—(Continued).

SN 78-922,585. SOVEREIGN DEED, LLC, CHICAGO, IL. FILED 7-5-2006.

YEAH BABY

THE MARK CONSISTS OF STANDARD CHARACTERS WITHOUT CLAIM TO ANY PARTICULAR FONT, STYLE, SIZE, OR COLOR.
FOR DISPOSABLE DIAPERS (U.S. CLS. 2, 5, 22, 23, 29, 37, 38 AND 50).
TINA BROWN, EXAMINING ATTORNEY

RESCUE

SN 78-907,504. HOMIESHOP,LLC, HERCULES, CA. FILED 6-13-2006.

FIGHT CLUB

THE MARK CONSISTS OF STANDARD CHARACTERS WITHOUT CLAIM TO ANY PARTICULAR FONT, STYLE, SIZE, OR COLOR.
FOR POSTERS; STICKERS (U.S. CLS. 2, 5, 22, 23, 29, 37, 38 AND 50).
MARILYN IZZI, EXAMINING ATTORNEY

THE MARK CONSISTS OF STANDARD CHARACTERS WITHOUT CLAIM TO ANY PARTICULAR FONT, STYLE, SIZE, OR COLOR.
FOR BATHROOM TISSUE; BIBLES; BLANK FORMS; BOOKLETS IN THE FIELD OF PERSONAL SECURITY AND SAFETY; BOOKS IN THE FIELD OF PERSONAL SECURITY AND SAFETY; BROCHURES ABOUT PERSONAL SECURITY AND SAFETY; BULLETINS CONCERNING PERSONAL SECURITY AND SAFETY; BUSINESS FORMS; CORRUGATED PAPER; EDUCATIONAL PUBLICATION, NAMELY TRAINING MANUALS IN THE FIELD OF SECURITY, SAFETY AND EMERGENCY; ILLUSTRATION BOARDS; INK PENS; INSTRUCTION SHEETS; MANUALS IN THE FIELD OF PERSONAL SECURITY AND SAFETY; MAPS; MARKERS; MEDICAL IDENTIFICATION CARDS; NEWS BULLETINS; NEWSPAPERS; ORDER FORMS; PAMPHLETS IN THE FIELD OF PERSONAL SECURITY AND SAFETY; PARTIALLY PRINTED FORMS; PLASTIC OR PAPER BAGS FOR HOUSEHOLD USE; PLASTIC WRAP; PRINTED CHARTS; PRINTED FORMS; PRINTED GRAPHS; PRINTED GUIDES FOR PERSONAL SECURITY AND SAFETY; PRINTED INSTRUCTIONAL, EDUCATIONAL, AND TEACHING MATERIALS IN THE FIELD OF PERSONAL SECURITY AND SAFETY; PRINTED INSTRUCTIONAL MATERIAL ON TELECOMMUNICATIONS; PRINTED PERIODICALS IN THE FIELD OF PERSONAL SECURITY AND SAFETY; PRINTED REPORTS FEATURING PERSONAL SECURITY AND SAFETY; PRINTED VISUALS IN THE NATURE OF INFORMATION GRAPHICS AND PROMOTIONAL MATERIALS; QUICK REFERENCE POCKET GUIDES IN THE FIELD OF PERSONAL SECURITY AND SAFETY; RESEARCH REPORTS FEATURING PERSONAL SECURITY AND SAFETY (U.S. CLS. 2, 5, 22, 23, 29, 37, 38 AND 50).
ANNE FARRELL, EXAMINING ATTORNEY

CLASS 16—(Continued).

SN 78-928,202. FRONTIER CONSULTING GROUP, INC., HEWITT, NJ. FILED 7-12-2006.



THE COLOR(S) PURPLE, YELLOW, MAGENTA, BLACK AND WHITE IS/ARE CLAIMED AS A FEATURE OF THE MARK.

THE MARK CONSISTS OF THE COLOR PURPLE APPEARS IN THE LETTER "F", THE COLOR YELLOW APPEARS IN THE LETTER "U", THE COLOR MAGENTA APPEARS IN THE TOP PORTION OF THE LETTER "N", THE COLOR BLACK APPEARS AS AN OUTLINE OF ALL THE LETTERS AND THE DESIGN ELEMENT, AND THE COLOR WHITE APPEARS IN THE WORD "WORKS", AND IN THE LOWER PART OF THE LETTER "N".

FOR PRINTED INSTRUCTIONAL MATERIAL ON TELECOMMUNICATIONS; PRINTED INSTRUCTIONAL, EDUCATIONAL, AND TEACHING MATERIALS IN THE FIELD OF ORGANIZATIONAL AND INDIVIDUAL DEVELOPMENT (U.S. CLS. 2, 5, 22, 23, 29, 37, 38 AND 50).

FIRST USE 1-15-1997; IN COMMERCE 1-15-1997.
DAYNA BROWNE, EXAMINING ATTORNEY

SN 78-945,034. THE UPPER DECK COMPANY, NORTH LAS VEGAS, NV. FILED 8-4-2006.

EXTRA EDITION

THE MARK CONSISTS OF STANDARD CHARACTERS WITHOUT CLAIM TO ANY PARTICULAR FONT, STYLE, SIZE, OR COLOR.

NO CLAIM IS MADE TO THE EXCLUSIVE RIGHT TO USE "EDITION", APART FROM THE MARK AS SHOWN. FOR TRADING CARDS (U.S. CLS. 2, 5, 22, 23, 29, 37, 38 AND 50).

FIRST USE 9-30-1997; IN COMMERCE 9-30-1997.
ANNE MADDEN, EXAMINING ATTORNEY

CLASS 16—(Continued).

SN 78-951,789. CAROLE JOY CREATIONS, INC., BROOKFIELD, CT. FILED 8-14-2006.



NO CLAIM IS MADE TO THE EXCLUSIVE RIGHT TO USE "CREATIONS, INC.", APART FROM THE MARK AS SHOWN.

THE MARK IDENTIFIES A LIVING INDIVIDUAL WHOSE CONSENT IS OF RECORD.

FOR GREETING CARDS; STATIONERY ITEMS, NAMELY, BLANK NOTE CARDS, THANK YOU NOTE CARDS, INVITATION CARDS, BIRTH ANNOUNCEMENT CARDS, BLANK WRITING JOURNALS, CALENDARS, PERSONAL PLANNERS, GIFT WRAP PAPER, ADDRESS BOOKS, A BABY DEVELOPMENT LOG AND RECORD BOOK (U.S. CLS. 2, 5, 22, 23, 29, 37, 38 AND 50).

FIRST USE 6-0-1986; IN COMMERCE 6-0-1986.

ANDREW RHIM, EXAMINING ATTORNEY

SN 78-956,719. THE BOSTON PHOENIX TRUST, BOSTON, MA. FILED 8-21-2006.

ON THE TOWN

THE MARK CONSISTS OF STANDARD CHARACTERS WITHOUT CLAIM TO ANY PARTICULAR FONT, STYLE, SIZE, OR COLOR.

FOR MAGAZINES FEATURING RESTAURANTS (U.S. CLS. 2, 5, 22, 23, 29, 37, 38 AND 50).

FIRST USE 5-19-2006; IN COMMERCE 5-19-2006.

TIMOTHY FINNEGAN, EXAMINING ATTORNEY

SN 78-960,744. BIGGER PICTURE PRODUCTIONS, LLC, PHOENIX, AZ. FILED 8-25-2006.

TOGETHER BOOK

THE MARK CONSISTS OF STANDARD CHARACTERS WITHOUT CLAIM TO ANY PARTICULAR FONT, STYLE, SIZE, OR COLOR.

NO CLAIM IS MADE TO THE EXCLUSIVE RIGHT TO USE "BOOK", APART FROM THE MARK AS SHOWN.

FOR PHOTO ALBUMS (U.S. CLS. 2, 5, 22, 23, 29, 37, 38 AND 50).

FLORENTINA BLANDU, EXAMINING ATTORNEY

CLASS 16—(Continued).

SN 78-964,188. PUBLISHING HOUSE OF THE EVANGELICAL LUTHERAN CHURCH IN AMERICA, MINNEAPOLIS, MN. FILED 8-30-2006.

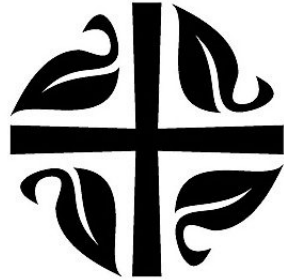

THE MARK CONSISTS OF A CROSS SURROUNDED BY FOUR STYLIZED LEAVES.

FOR PRINTED RELIGIOUS PUBLICATIONS, NAMELY, BOOKS FEATURING PRAYERS, HYMNS, LITURGY, AND MUSIC; BIBLE STUDY BOOKS, WORKBOOKS, AND PAMPHLETS CONTAINING WORSHIP MATERIALS (U.S. CLS. 2, 5, 22, 23, 29, 37, 38 AND 50).
FIRST USE 7-0-2001; IN COMMERCE 7-0-2001.
JOHN DALIER, EXAMINING ATTORNEY

SN 78-964,228. PUBLISHING HOUSE OF THE EVANGELICAL LUTHERAN CHURCH IN AMERICA, MINNEAPOLIS, MN. FILED 8-30-2006.

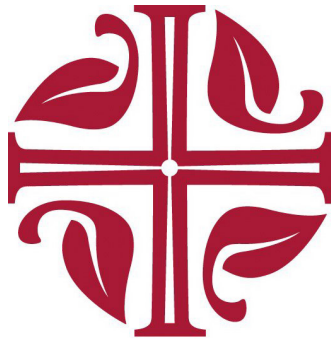

THE COLOR(S) RED IS/ARE CLAIMED AS A FEATURE OF THE MARK.

THE COLOR RED APPEARS IN THE DESIGN OF THE CROSS AND LEAVES.

FOR PRINTED RELIGIOUS PUBLICATIONS, NAMELY, BOOKS FEATURING PRAYERS, HYMNS, LITURGY, AND MUSIC; BIBLE STUDY BOOKS, WORKBOOKS, AND PAMPHLETS CONTAINING WORSHIP MATERIALS (U.S. CLS. 2, 5, 22, 23, 29, 37, 38 AND 50).
FIRST USE 4-0-2006; IN COMMERCE 4-0-2006.
JOHN DALIER, EXAMINING ATTORNEY

CLASS 16—(Continued).

SN 78-965,092. PUBLISHING HOUSE OF THE EVANGELICAL LUTHERAN CHURCH IN AMERICA, MINNEAPOLIS, MN. FILED 8-31-2006.

RENEWING WORSHIP

THE MARK CONSISTS OF STANDARD CHARACTERS WITHOUT CLAIM TO ANY PARTICULAR FONT, STYLE, SIZE, OR COLOR.

NO CLAIM IS MADE TO THE EXCLUSIVE RIGHT TO USE "WORSHIP", APART FROM THE MARK AS SHOWN.

FOR PRINTED RELIGIOUS PUBLICATIONS, NAMELY, BOOKS FEATURING PRAYERS, HYMNS, LITURGY, AND MUSIC; BIBLE STUDY BOOKS, WORKBOOKS, AND PAMPHLETS CONTAINING WORSHIP MATERIALS (U.S. CLS. 2, 5, 22, 23, 29, 37, 38 AND 50).

FIRST USE 7-0-2001; IN COMMERCE 7-0-2001.

JOHN DALIER, EXAMINING ATTORNEY

SN 78-965,151. DAVENPORT, BRANDON (IN HIS CAPACITY AS THE PARENT, AND ON BEHALF OF, THE MINOR MADISON DAVENPORT), LOS ANGELES, CA. FILED 8-31-2006.

Shapesville

THE MARK CONSISTS OF STANDARD CHARACTERS WITHOUT CLAIM TO ANY PARTICULAR FONT, STYLE, SIZE, OR COLOR.

FOR ADDRESS BOOKS; PHOTOGRAPH ALBUMS; APPLIQUES IN THE FORM OF DECALS; APPOINTMENT BOOKS; ARTS AND CRAFT PAINT KITS; AUTOGRAPH BOOKS; BABY BOOKS; PAPER PARTY BAGS; BALL-POINT PENS; BINDERS; BOOKENDS; BOOKMARKS; SERIES OF CHILDREN'S FICTION BOOKS; PAPER GIFT WRAP BOWS; PAPER CAKE DECORATIONS; CALENDARS; GIFT CARDS; GREETING CARDS; CARTOON PRINTS; PEN AND PENCIL CASES; DECORATIVE PAPER CENTERPIECES; CHALK; CHILDREN'S ACTIVITY BOOKS; MODELING CLAY; PAPER TABLE CLOTHS; COLORING BOOKS; COMIC STRIPS; COMIC BOOKS; PAPER PARTY DECORATIONS; DIARIES; GIFT WRAPPING PAPER; MAGAZINES IN THE FIELD OF ENTERTAINMENT; PAPER PARTY HATS; PRINTED PERIODICALS IN THE FIELD OF ENTERTAINMENT; PAPER NAPKINS; PENS; PENCILS; STATIONERY; STICKERS; POSTERS; NOTEBOOKS; MEMO PADS; ERASERS; PENCIL SHARPENERS; STAPLERS; WRITING PAPER; ENVELOPES; PAPER WEIGHTS; PAPER COASTERS; PAPER MATS; NON-CALIBRATED RULERS; PHOTOGRAPHS; POSTCARDS; TRADING CARDS (U.S. CLS. 2, 5, 22, 23, 29, 37, 38 AND 50).

WON TEAK OH, EXAMINING ATTORNEY

CLASS 16—(Continued).

SN 78-967,362. PENNWELL CORPORATION, TULSA, OK.
FILED 9-5-2006.

COGENERATION & ON-SITE
POWER PRODUCTION

THE MARK CONSISTS OF STANDARD CHARACTERS WITHOUT CLAIM TO ANY PARTICULAR FONT, STYLE, SIZE, OR COLOR.

SEC. 2(F).
FOR MAGAZINE IN THE FIELD OF POWER PRODUCTION FOR INDUSTRIES (U.S. CLS. 2, 5, 22, 23, 29, 37, 38 AND 50).

FIRST USE 12-31-2000; IN COMMERCE 12-31-2000.
TIMOTHY FINNEGAN, EXAMINING ATTORNEY

CLASS 16—(Continued).

SN 78-970,613. WILLIAMS JR., JAMES EDDIE, MIAMI, FL.
FILED 9-8-2006.



NO CLAIM IS MADE TO THE EXCLUSIVE RIGHT TO USE "FITNESS", APART FROM THE MARK AS SHOWN.

THE COLOR(S) RED, BLUE, YELLOW, LIGHT BLUE, GREEN, GRAY, BLACK IS/ARE CLAIMED AS A FEATURE OF THE MARK.

THE MARK CONSISTS OF POCKET FULL OF FITNESS ABOVE HALF OF BODY TORSO WAIST HIPS IN BLUE. HALF OF BODY TORSO WAIST HIPS SHIRT IN RED. PANTS ARE BLUE. PANTS POCKET IS BLUE WITH BLACK AND LIGHT BLUE TRIM OUTLINE. YOUR NEXT ACTIVITY IS AS CLOSE AS YOUR POCKET WITHIN PANTS POCKET YELLOW BOOK INSIDE OF PANTS POCKET IS RED, YELLOW, GRAY, GREEN AND BLUE.

FOR BOOKS IN THE FIELD OF FITNESS (U.S. CLS. 2, 5, 22, 23, 29, 37, 38 AND 50).

DEZMONA MIZELLE, EXAMINING ATTORNEY

SN 78-969,370. THE 24 KARAT EXPERIENCE, INC., ASHLAND, OR. FILED 9-7-2006.

24 KARAT

THE MARK CONSISTS OF STANDARD CHARACTERS WITHOUT CLAIM TO ANY PARTICULAR FONT, STYLE, SIZE, OR COLOR.

FOR PRINTED INSTRUCTIONAL, EDUCATIONAL, AND TEACHING MATERIALS IN THE FIELD OF MUSIC (U.S. CLS. 2, 5, 22, 23, 29, 37, 38 AND 50).

FIRST USE 8-1-1989; IN COMMERCE 8-1-1989.
IRA J. GOODSaid, EXAMINING ATTORNEY

SN 78-971,579. ONCOLOGY TODAY, L.P., HOUSTON, TX.
FILED 9-11-2006.



NO CLAIM IS MADE TO THE EXCLUSIVE RIGHT TO USE "ONCOLOGY", APART FROM THE MARK AS SHOWN.

FOR PRINTED MATERIALS, NAMELY, NEWSLETTERS, BROCHURES, EDUCATIONAL SEMINAR MATERIALS AND OUTLINES, AND MONOGRAPHS FEATURING INFORMATION IN THE FIELDS OF ONCOLOGY AND HEMATOLOGY AND ISSUES RELATED TO THE DIAGNOSIS, TREATMENT AND MANAGEMENT OF HEMATOLOGY AND ONCOLOGY AND RELATED CONDITIONS (U.S. CLS. 2, 5, 22, 23, 29, 37, 38 AND 50).

KEVIN DINALLO, EXAMINING ATTORNEY

CLASS 16—(Continued).

SN 78-972,506. LEIGH RUBIN, NIPOMO, CA. FILED 9-12-2006.

THE WILD LIFE OF A RUBES CARTOON BOOK

THE MARK CONSISTS OF STANDARD CHARACTERS WITHOUT CLAIM TO ANY PARTICULAR FONT, STYLE, SIZE, OR COLOR.

OWNER OF U.S. REG. NOS. 2,048,015 AND 2,070,005.

NO CLAIM IS MADE TO THE EXCLUSIVE RIGHT TO USE "CARTOON BOOK", APART FROM THE MARK AS SHOWN.

FOR CARTOON BOOKS (U.S. CLS. 2, 5, 22, 23, 29, 37, 38 AND 50).

JULIE WATSON, EXAMINING ATTORNEY

CLASS 16—(Continued).

SN 78-972,861. HOP, LLC, BALTIMORE, MD. FILED 9-12-2006.

THE SURE THING FOR PRE-K SUCCESS!

THE MARK CONSISTS OF STANDARD CHARACTERS WITHOUT CLAIM TO ANY PARTICULAR FONT, STYLE, SIZE, OR COLOR.

FOR EDUCATIONAL ACTIVITY KITS CONSISTING PRIMARILY OF WORKBOOKS, FLASHCARDS, BINGO CARDS, POSTERS, STICKERS, PARENT'S GUIDES, CD-ROMS, AUDIO CDS, AND DVD'S, ALL FOR EDUCATIONAL PURPOSES AND RELATING TO GENERAL EDUCATION (U.S. CLS. 2, 5, 22, 23, 29, 37, 38 AND 50).

RICHARD A. STRASER, EXAMINING ATTORNEY

SN 78-972,855. HOP, LLC, BALTIMORE, MD. FILED 9-12-2006.

THE SURE THING FOR READING SUCCESS!

THE MARK CONSISTS OF STANDARD CHARACTERS WITHOUT CLAIM TO ANY PARTICULAR FONT, STYLE, SIZE, OR COLOR.

FOR EDUCATIONAL ACTIVITY KITS CONSISTING PRIMARILY OF WORKBOOKS, BOOKS, FLASHCARDS, POSTERS, STICKERS, PARENT'S GUIDES, CD-ROMS, AUDIO CDS, AND DVD'S, ALL FOR EDUCATIONAL PURPOSES AND RELATING TO READING (U.S. CLS. 2, 5, 22, 23, 29, 37, 38 AND 50).

RICHARD A. STRASER, EXAMINING ATTORNEY

SN 78-972,870. HOP, LLC, BALTIMORE, MD. FILED 9-12-2006.

THE SURE THING FOR KINDERGARTEN SUCCESS!

THE MARK CONSISTS OF STANDARD CHARACTERS WITHOUT CLAIM TO ANY PARTICULAR FONT, STYLE, SIZE, OR COLOR.

FOR EDUCATIONAL ACTIVITY KITS CONSISTING PRIMARILY OF FLASHCARDS, WORKBOOKS, BOOKS, CRAYONS, MARKERS, PENCILS, PENCIL GRIPS, POSTERS, STICKERS, PLAY MONEY AND GAME PIECES, PARENT'S GUIDES, CD-ROMS, AND AUDIO CDS, ALL FOR EDUCATIONAL PURPOSES AND RELATING TO GENERAL EDUCATION (U.S. CLS. 2, 5, 22, 23, 29, 37, 38 AND 50).

RICHARD A. STRASER, EXAMINING ATTORNEY

SN 78-972,858. HOP, LLC, BALTIMORE, MD. FILED 9-12-2006.

THE SURE THING FOR MATH SUCCESS!

THE MARK CONSISTS OF STANDARD CHARACTERS WITHOUT CLAIM TO ANY PARTICULAR FONT, STYLE, SIZE, OR COLOR.

FOR EDUCATIONAL ACTIVITY KITS CONSISTING PRIMARILY OF WORKBOOKS, BOOKS, FLASHCARDS, POSTERS, STICKERS, PARENT'S GUIDES, CD-ROMS, AUDIO CDS, AND DVD'S, ALL FOR EDUCATIONAL PURPOSES AND RELATING TO MATH (U.S. CLS. 2, 5, 22, 23, 29, 37, 38 AND 50).

RICHARD A. STRASER, EXAMINING ATTORNEY

SN 78-973,608. CHICOPEE, INC., CHARLOTTE, NC. FILED 9-13-2006.



FOR DISPOSABLE WIPES NOT IMPREGNATED WITH CHEMICALS OR COMPOUNDS (U.S. CLS. 2, 5, 22, 23, 29, 37, 38 AND 50).

LYDIA BELZER, EXAMINING ATTORNEY

CLASS 16—(Continued).

SN 79-032,041. 3L-LUDVIGSEN A/S, DK-5690 TOMMERUP, DENMARK, FILED 7-4-2006.

E-Z MAGNETS

THE MARK CONSISTS OF STANDARD CHARACTERS WITHOUT CLAIM TO ANY PARTICULAR FONT, STYLE, SIZE, OR COLOR.

OWNER OF INTERNATIONAL REGISTRATION 0906341 DATED 7-4-2006, EXPIRES 7-4-2016.

OWNER OF U.S. REG. NOS. 3,063,788 AND 3,087,829.

NO CLAIM IS MADE TO THE EXCLUSIVE RIGHT TO USE "MAGNETS", APART FROM THE MARK AS SHOWN.

FOR DISPENSER FOR DISPENSING DOUBLE-SIDED, ADHESIVE TAPE FOR OFFICE AND HOUSEHOLD USE; A DISPENSER FOR DISPENSING SELF-ADHESIVE, MAGNETIC TAPE FOR OFFICE AND HOUSEHOLD USE; DOUBLE-SIDED, SELF-ADHESIVE TAPE FOR OFFICE AND HOUSEHOLD USE; SELF-ADHESIVE, MAGNETIC TAPE FOR OFFICE AND HOUSEHOLD USE; SELF-ADHESIVE STRIPS, STICKERS AND LABELS FOR INDEX CARDS, APPARATUS FOR MOUNTING STRIPS, TRANSPARENT RINGS FOR STRENGTHENING, TRANSPARENT SELF-ADHESIVE HOLDERS FOR BUSINESS AND VISITING CARDS AND OTHER SELF-ADHESIVE HOLDERS; LABELS, NAMELY, SELF-LAMINATING LABELS, SELF-ADHESIVE LABELS, LABEL HOLDERS, SHELVING LABEL HOLDERS, LABELS FOR 3 1/2" DISKETTES AND ZIP DISKETTES, SELF-LAMINATING CARDS AND SELF-LAMINATING ADHESIVE CARDS, PHOTOGRAPH CORNERS, DOUBLE-SIDED ADHESIVE LABELS FOR OFFICE AND HOUSEHOLD USE (U.S. CLS. 2, 5, 22, 23, 29, 37, 38 AND 50).

SANJEEV VOHRA, EXAMINING ATTORNEY

SN 79-037,174. YADA ENTERPRISE CO., LTD., CHINA, FILED 3-13-2007.



OWNER OF INTERNATIONAL REGISTRATION 0920646 DATED 3-13-2007, EXPIRES 3-13-2017.

FOR LOOSE-LEAF BINDERS; BOOKBINDING MATERIAL, NAMELY BOOKBINDING TAPE, BOOKBINDING WIRE, BOOKBINDINGS, AND CLOTH FOR BOOKBINDING; PAPER KNIVES; PAPER SHREDDERS; DOCUMENT LAMINATORS FOR OFFICE USE; STATIONERY; PAPER FILE JACKETS; WRAPPING PAPER; OFFICE REQUISITES, NAMELY, STAPLES, PENCIL SHARPENERS, AND ERASERS; FILM FOR OFFICE, STATIONERY AND TEACHING, NAMELY CORRECTING FILM FOR TYPE AND ADHESIVE PLASTIC FILM USED FOR MOUNTING IMAGES (U.S. CLS. 2, 5, 22, 23, 29, 37, 38 AND 50).

JASON BLAIR, EXAMINING ATTORNEY

CLASS 17—RUBBER GOODS

SN 76-664,037. TROY ACOUSTICS CORPORATION, VAN NUYS, CA, FILED 8-2-2006.

TROY BOARD

THE MARK CONSISTS OF STANDARD CHARACTERS WITHOUT CLAIM TO ANY PARTICULAR FONT, STYLE, SIZE, OR COLOR.

NO CLAIM IS MADE TO THE EXCLUSIVE RIGHT TO USE "BOARD", APART FROM THE MARK AS SHOWN.

FOR NON-ASBESTOS, NON-METAL BUILDING MATERIALS FOR SOUND ATTENUATION AND THERMAL CONTROL, NAMELY, TILES, WALL AND CEILING PANELS, FRAMING, BUILDING INSULATION, AND ACOUSTICAL PANELS AND TILES (U.S. CLS. 1, 5, 12, 13, 35 AND 50).

FIRST USE 3-31-2001; IN COMMERCE 3-31-2001.

KIMBERLY FRYE, EXAMINING ATTORNEY

SN 76-664,038. TROY ACOUSTICS CORPORATION, VAN NUYS, CA, FILED 8-2-2006.

TROY WOOL

THE MARK CONSISTS OF STANDARD CHARACTERS WITHOUT CLAIM TO ANY PARTICULAR FONT, STYLE, SIZE, OR COLOR.

NO CLAIM IS MADE TO THE EXCLUSIVE RIGHT TO USE "WOOL", APART FROM THE MARK AS SHOWN.

FOR NON-ASBESTOS, NON-METAL BUILDING MATERIALS FOR SOUND ATTENUATION AND THERMAL CONTROL, NAMELY, TILES, WALL AND CEILING PANELS, FRAMING, BUILDING INSULATION, AND ACOUSTICAL PANELS AND TILES (U.S. CLS. 1, 5, 12, 13, 35 AND 50).

FIRST USE 3-31-2001; IN COMMERCE 3-31-2001.

KIMBERLY FRYE, EXAMINING ATTORNEY

SN 76-673,831. MOCAP, INC., ST. LOUIS, MO. FILED 3-9-2007.

QUICK CLAMP WRAP

THE MARK CONSISTS OF STANDARD CHARACTERS WITHOUT CLAIM TO ANY PARTICULAR FONT, STYLE, SIZE, OR COLOR.

NO CLAIM IS MADE TO THE EXCLUSIVE RIGHT TO USE "CLAMP WRAP", APART FROM THE MARK AS SHOWN.

FOR SILICONE BASE STRETCH TAPE FOR USE IN FURNITURE REPAIR (U.S. CLS. 1, 5, 12, 13, 35 AND 50).

ELLEN PERKINS, EXAMINING ATTORNEY

CLASS 17—(Continued).

SN 77-001,238. REINOSO-RODRIGUEZ, CESAR TULIO, BOGOTA DC, COLOMBIA, FILED 9-18-2006.

CTR

THE MARK CONSISTS OF STANDARD CHARACTERS WITHOUT CLAIM TO ANY PARTICULAR FONT, STYLE, SIZE, OR COLOR.

FOR CONNECTING HOSES FOR VEHICLE RADIATORS; FLEXIBLE PLASTIC HOSES FOR USE IN VENTILATION; FLOATING ANTI-POLLUTION BARRIERS; HOSES FOR AIR CONDITIONERS MADE OF RUBBER OR PLASTIC; NON-METAL TUBING AND TUBING COUPLINGS FOR JOINING AND TERMINATING PIPES; RUBBER TUBES AND PIPES; SEMI-PROCESSED PLASTIC IN THE FORM OF FILMS, SHEETS, TUBES, BARS, OR RODS; VEHICLE RADIATOR CONNECTING HOSES (U.S. CLS. 1, 5, 12, 13, 35 AND 50).

KATHERINE CHANG, EXAMINING ATTORNEY

SN 77-116,486. TRU VUE, INC., MCCOOK, IL. FILED 2-26-2007.

PRESERVATION CLEAR

THE MARK CONSISTS OF STANDARD CHARACTERS WITHOUT CLAIM TO ANY PARTICULAR FONT, STYLE, SIZE, OR COLOR.

NO CLAIM IS MADE TO THE EXCLUSIVE RIGHT TO USE "CLEAR", APART FROM THE MARK AS SHOWN.

FOR ACRYLIC SHEETS FOR PICTURE FRAMES AND DISPLAY CASES (U.S. CLS. 1, 5, 12, 13, 35 AND 50).

LINDA ORNDORFF, EXAMINING ATTORNEY

SN 77-158,814. RUBBERSIDEWALKS, INC., GARDENA, CA. FILED 4-17-2007.

Rubberoo

THE MARK CONSISTS OF STANDARD CHARACTERS WITHOUT CLAIM TO ANY PARTICULAR FONT, STYLE, SIZE, OR COLOR.

FOR RUBBER PRODUCTS, NAMELY, MULCH MADE OF RECYCLED RUBBER FOR USE IN LANDSCAPING AND HORTICULTURE APPLICATIONS; RUBBER CHIPS OR GRANULES FOR USE AS A PLAYGROUND GROUND COVER (U.S. CLS. 1, 5, 12, 13, 35 AND 50).

AHSEN KHAN, EXAMINING ATTORNEY

CLASS 17—(Continued).

SN 77-159,558. DEARING, DAVID, WOODSTOCK, GA. FILED 4-18-2007.

speedFilm

FOR POLYURETHANE FILM FOR AUTOMOTIVE PAINT PROTECTION (U.S. CLS. 1, 5, 12, 13, 35 AND 50). FIRST USE 5-1-2003; IN COMMERCE 5-1-2003.

AHSEN KHAN, EXAMINING ATTORNEY

SN 77-160,693. AMES TRUE TEMPER PROPERTIES, INC., WILMINGTON, DE. FILED 4-19-2007.

ESP TECHNOLOGY

THE MARK CONSISTS OF STANDARD CHARACTERS WITHOUT CLAIM TO ANY PARTICULAR FONT, STYLE, SIZE, OR COLOR.

NO CLAIM IS MADE TO THE EXCLUSIVE RIGHT TO USE "TECHNOLOGY", APART FROM THE MARK AS SHOWN.

FOR WATERING HOSES (U.S. CLS. 1, 5, 12, 13, 35 AND 50).

JORDAN BAKER, EXAMINING ATTORNEY

SN 77-161,049. ADVANCE PRODUCTS & SYSTEMS, INC., SCOTT, LA. FILED 4-19-2007.

Integra SSA

THE MARK CONSISTS OF STANDARD CHARACTERS WITHOUT CLAIM TO ANY PARTICULAR FONT, STYLE, SIZE, OR COLOR.

FOR PIPE GASKETS (U.S. CLS. 1, 5, 12, 13, 35 AND 50). FIRST USE 11-1-2006; IN COMMERCE 11-1-2006.

JULIE THOMAS, EXAMINING ATTORNEY

CLASS 17—(Continued).

SN 77-166,540. TEKNOR APEX COMPANY, PAWTUCKET, RI. FILED 4-26-2007.

Triflex Technology

THE MARK CONSISTS OF STANDARD CHARACTERS WITHOUT CLAIM TO ANY PARTICULAR FONT, STYLE, SIZE, OR COLOR.

OWNER OF U.S. REG. NO. 1,430,238.

NO CLAIM IS MADE TO THE EXCLUSIVE RIGHT TO USE "TECHNOLOGY", APART FROM THE MARK AS SHOWN.

FOR WATERING HOSES; GARDEN HOSES; LAWN HOSES (U.S. CLS. 1, 5, 12, 13, 35 AND 50).

SHAILA SETTLES, EXAMINING ATTORNEY

SN 77-166,557. TEKNOR APEX COMPANY, PAWTUCKET, RI. FILED 4-26-2007.

Triflex

THE MARK CONSISTS OF STANDARD CHARACTERS WITHOUT CLAIM TO ANY PARTICULAR FONT, STYLE, SIZE, OR COLOR.

OWNER OF U.S. REG. NO. 1,430,238.

FOR WATERING HOSES; GARDEN HOSES; LAWN HOSES (U.S. CLS. 1, 5, 12, 13, 35 AND 50).

SHAILA SETTLES, EXAMINING ATTORNEY

SN 77-172,183. AMES TRUE TEMPER PROPERTIES, INC., WILMINGTON, DE. FILED 5-3-2007.

NEVERLEAK

THE MARK CONSISTS OF STANDARD CHARACTERS WITHOUT CLAIM TO ANY PARTICULAR FONT, STYLE, SIZE, OR COLOR.

FOR WATERING HOSES (U.S. CLS. 1, 5, 12, 13, 35 AND 50).

JORDAN BAKER, EXAMINING ATTORNEY

CLASS 17—(Continued).

SN 77-175,588. AMES TRUE TEMPER PROPERTIES, INC., WILMINGTON, DE. FILED 5-8-2007.

NO LEAK

THE MARK CONSISTS OF STANDARD CHARACTERS WITHOUT CLAIM TO ANY PARTICULAR FONT, STYLE, SIZE, OR COLOR.

FOR WATERING HOSES (U.S. CLS. 1, 5, 12, 13, 35 AND 50).

JORDAN BAKER, EXAMINING ATTORNEY

SN 77-196,644. ELMER'S PRODUCTS, INC., COLUMBUS, OH. FILED 6-4-2007.

SQUEEZ'N CAULK

THE MARK CONSISTS OF STANDARD CHARACTERS WITHOUT CLAIM TO ANY PARTICULAR FONT, STYLE, SIZE, OR COLOR.

NO CLAIM IS MADE TO THE EXCLUSIVE RIGHT TO USE "CAULK", APART FROM THE MARK AS SHOWN.

FOR CAULKING COMPOUNDS (U.S. CLS. 1, 5, 12, 13, 35 AND 50).

FIRST USE 8-9-1991; IN COMMERCE 8-9-1991.

PAM WILLIS, EXAMINING ATTORNEY

SN 78-787,492. RAVENHORST CONCRETE PRODUCTS, INC., RACINE, MN. FILED 1-9-2006.

FLEXSUL-SEAL

THE MARK CONSISTS OF STANDARD CHARACTERS WITHOUT CLAIM TO ANY PARTICULAR FONT, STYLE, SIZE, OR COLOR.

OWNER OF U.S. REG. NO. 2,035,957.

FOR NON-METAL FLEXIBLE INSULATED WATER PIPES (U.S. CLS. 1, 5, 12, 13, 35 AND 50).

FIRST USE 12-10-2005; IN COMMERCE 12-10-2005.

DOMINIC J. FERRAIUOLO, EXAMINING ATTORNEY

CLASS 17—(Continued).

SN 78-974,842. MAINSAVER TECHNOLOGY LLC, GOLDEN, CO. FILED 9-14-2006.



MainSaver

FOR FLEXIBLE PIPES, NOT OF METAL; FLEXIBLE PLASTIC TUBES FOR LINING PASSAGEWAYS FOR USE IN WATER, SEWAGE, ELECTRICAL, TELECOMMUNICATION AND NATURAL GAS UTILITY CONDUITS, PIPES, DUCTS, TUBES, MAINS, AND THE LIKE; EXTRUDED PLASTICS AND POLYMER MATERIAL IN SHEET FORM FOR USE IN MANUFACTURING AND GENERAL INDUSTRIAL USE (U.S. CLS. 1, 5, 12, 13, 35 AND 50).

ELISSA GARBER KON, EXAMINING ATTORNEY

SN 78-974,857. MAINSAVER TECHNOLOGY LLC, GOLDEN, CO. FILED 9-14-2006.



FOR FLEXIBLE PIPES, NOT OF METAL; FLEXIBLE PLASTIC TUBES FOR LINING PASSAGEWAYS FOR USE IN WATER, SEWAGE, ELECTRICAL, TELECOMMUNICATION AND NATURAL GAS UTILITY CONDUITS, PIPES, DUCTS, TUBES, MAINS, AND THE LIKE; EXTRUDED PLASTICS AND POLYMER MATERIAL IN SHEET FORM FOR USE IN MANUFACTURING AND GENERAL INDUSTRIAL USE (U.S. CLS. 1, 5, 12, 13, 35 AND 50).

ELISSA GARBER KON, EXAMINING ATTORNEY

CLASS 18—LEATHER GOODS

SN 77-006,955. THE MADDEN CORPORATION, WAIPAHU, HI. FILED 9-25-2006.



ISLAND CHIC

THE MARK CONSISTS OF THE WORDS ISLAND CHIC WITH A SUN DESIGN.

FOR LUGGAGE, TRUNKS, AND TRAVELLING BAGS; HANDBAGS, WALLETS WITH CARD COMPARTMENTS, COSMETIC CASES SOLD EMPTY, OVERNIGHT CASES, TOTE BAGS, BEACH BAGS AND BACKPACKS (U.S. CLS. 1, 2, 3, 22 AND 41).

FIRST USE 10-27-2006; IN COMMERCE 10-27-2006.

MONIQUE MILLER, EXAMINING ATTORNEY

CLASS 18—(Continued).

SN 77-070,654. AEROPOSTALE WEST, INC., WAYNE, NJ. FILED 12-22-2006.

AEROPOSTALE

THE MARK CONSISTS OF STANDARD CHARACTERS WITHOUT CLAIM TO ANY PARTICULAR FONT, STYLE, SIZE, OR COLOR.

OWNER OF U.S. REG. NOS. 1,485,368, 1,548,372 AND OTHERS.

THE FOREIGN WORDING IN THE MARK TRANSLATES INTO ENGLISH AS AIR MAIL.

FOR WALLETS, TOTE BAGS, HAND BAGS, SHOULDER BAGS, POCKET BOOKS AND MESSENGER BAGS (U.S. CLS. 1, 2, 3, 22 AND 41).

FIRST USE 3-1-1998; IN COMMERCE 3-1-1998.

BARBARA BROWN, EXAMINING ATTORNEY

SN 77-076,349. COSTUME-IZER LTD., BROOKLYN, NY. FILED 1-4-2007.

THE DANCER'S PORTABLE VALET

THE MARK CONSISTS OF STANDARD CHARACTERS WITHOUT CLAIM TO ANY PARTICULAR FONT, STYLE, SIZE, OR COLOR.

NO CLAIM IS MADE TO THE EXCLUSIVE RIGHT TO USE "DANCER'S PORTABLE", APART FROM THE MARK AS SHOWN.

FOR NON-MOTORIZED, COLLAPSIBLE LUGGAGE CARTS (U.S. CLS. 1, 2, 3, 22 AND 41).

FIRST USE 3-29-1999; IN COMMERCE 5-19-1999.

TIMOTHY FINNEGAN, EXAMINING ATTORNEY

CLASS 18—(Continued).

SN 77-077,840. AEROPOSTALE WEST, INC., WAYNE, NJ.
FILED 1-8-2007.



OWNER OF U.S. REG. NOS. 1,354,292, 1,487,211 AND OTHERS.

NO CLAIM IS MADE TO THE EXCLUSIVE RIGHT TO USE "SINCE 1987", APART FROM THE MARK AS SHOWN.

THE MARK CONSISTS OF THE WORD AEROSTALE AND A GRAPHIC DESIGN OF A BUTTERFLY ENCLOSED IN A CIRCLE.

THE FOREIGN WORDING IN THE MARK TRANSLATES INTO ENGLISH AS AIR MAIL.

FOR BAGS, NAMELY, PURSES AND HANDBAGS (U.S. CLS. 1, 2, 3, 22 AND 41).

FIRST USE 6-1-2005; IN COMMERCE 6-1-2005.

BARBARA BROWN, EXAMINING ATTORNEY

CLASS 18—(Continued).

SN 77-096,200. JENNIFER MILLER, LTD., NEW YORK, NY.
FILED 1-31-2007.

JENNIFER MILLER

THE MARK CONSISTS OF STANDARD CHARACTERS WITHOUT CLAIM TO ANY PARTICULAR FONT, STYLE, SIZE, OR COLOR.

THE NAME "JENNIFER MILLER" IDENTIFIES A LIVING INDIVIDUAL WHOSE CONSENT IS OF RECORD.

FOR BAGS, NAMELY, HANDBAGS, SHOULDER BAGS, TOTE BAGS, CLUTCHES, BACK PACKS, WALLETS AND LUGGAGE (U.S. CLS. 1, 2, 3, 22 AND 41).

FIRST USE 1-1-2002; IN COMMERCE 1-1-2002.

BERYL GARDNER, EXAMINING ATTORNEY

SN 77-140,455. DISNEY ENTERPRISES, INC., BURBANK, CA. FILED 3-26-2007.

SN 77-089,465. JMBP, INC., LOS ANGELES, CA. FILED 1-23-2007.

IRIDESSA

ARE YOU SMARTER THAN A 5TH
GRADER?

THE MARK CONSISTS OF STANDARD CHARACTERS WITHOUT CLAIM TO ANY PARTICULAR FONT, STYLE, SIZE, OR COLOR.

FOR LUGGAGE, TRAVEL BAGS, TOTE BAGS AND BACKPACKS; PET ACCESSORIES, NAMELY, PET CLOTHING, PET COLLARS AND PET COLLAR ACCESSORIES, NAMELY, BOWS AND CHARMS; LEATHER KEY CHAINS (U.S. CLS. 1, 2, 3, 22 AND 41).

KYLE PEETE, EXAMINING ATTORNEY

THE MARK CONSISTS OF STANDARD CHARACTERS WITHOUT CLAIM TO ANY PARTICULAR FONT, STYLE, SIZE, OR COLOR.

FOR ALL PURPOSE SPORT BAGS; ATHLETIC BAGS; BABY BACKPACKS; BACKPACKS; BEACH BAGS; BOOK BAGS; CALLING CARD CASES; CHANGE PURSES; COIN PURSES; DIAPER BAGS; DUFFEL BAGS; FANNY PACKS; GYM BAGS; HANDBAGS; KNAPSACKS; KEY CASES; LEATHER KEY CHAINS; LUGGAGE; LUGGAGE TAGS; OVERNIGHT BAGS; PURSES; SATCHELS; SHOPPING BAGS, NAMELY LEATHER SHOPPING BAGS, MESH SHOPPING BAGS, AND TEXTILE SHOPPING BAGS; TOTE BAGS; UMBRELLAS; WAIST PACKS; WALLETS (U.S. CLS. 1, 2, 3, 22 AND 41).

AMY BROZENIC, EXAMINING ATTORNEY

CLASS 18—(Continued).

SN 77-152,213. SANRIO COMPANY, LTD., TOKYO, JAPAN, FILED 4-9-2007.

KUROMI

THE MARK CONSISTS OF STANDARD CHARACTERS WITHOUT CLAIM TO ANY PARTICULAR FONT, STYLE, SIZE, OR COLOR.

FOR TOTE BAGS, HANDBAGS, SHOULDER BAGS, TRAVEL BAGS, SCHOOL BAGS, BEACH BAGS, BOOK BAGS, ALL PURPOSE SPORT BAGS, VINYL ATHLETIC BAGS, DRAWSTRING BARREL BAGS, DRAWSTRING CARRY-ON BAGS, DRAWSTRING CLUTCH BAGS, OVERNIGHT CARRYING CASES, SUITCASES, OVERNIGHT SUITCASES, GARMENT BAGS FOR TRAVEL, LUGGAGE TAGS, BACKPACKS, WAIST PACKS, PURSES, BRIEFCASES, COIN PURSES, WALLETS, BUSINESS CARD CASES, COSMETIC BAGS SOLD EMPTY, VANITY CASES SOLD EMPTY, KEY CASES, UMBRELLAS, DIAPER BAGS, PET CLOTHING, BANDANAS FOR PETS, SHOES FOR PETS, BOOTS FOR PETS, COSTUMES FOR PETS, ANIMAL CARRIERS, COLLARS FOR PETS, PET COLLAR ACCESSORIES, NAMELY, CHARMS; ANIMAL LEASHES (U.S. CLS. 1, 2, 3, 22 AND 41).
NAAKWAMA ANKRAH, EXAMINING ATTORNEY

SN 77-156,496. ASCONA INGREDIENTS INC., MISSISSAUGA, CANADA, FILED 4-13-2007.

NUTRACASING

THE MARK CONSISTS OF STANDARD CHARACTERS WITHOUT CLAIM TO ANY PARTICULAR FONT, STYLE, SIZE, OR COLOR.

FOR FIBROUS FOOD CASINGS MADE FROM POLYSACCHARIDE (U.S. CLS. 1, 2, 3, 22 AND 41).
MARK PILARO, EXAMINING ATTORNEY

CLASS 18—(Continued).

SN 77-156,898. VADHERA, SHALINI, ENCINITAS, CA. FILED 4-14-2007.

GLOBAL GODDESS

THE MARK CONSISTS OF STANDARD CHARACTERS WITHOUT CLAIM TO ANY PARTICULAR FONT, STYLE, SIZE, OR COLOR.

FOR ATHLETIC AND ALL PURPOSE SPORT BAGS, BOOK BAGS, CARRY-ON BAGS, CLUTCH BAGS, DIAPER BAGS, GYM BAGS, LEATHER, MESH AND TEXTILE SHOPPING BAGS, SHOULDER BAGS, GARMENT BAGS FOR TRAVEL, SHOE BAGS FOR TRAVEL, BEACH BAGS, BRIEFCASES, BUSINESS CARD CASES, CALLING CARD CASES, CHANGE AND COIN PURSES, BACKPACKS, UMBRELLAS, BEACH UMBRELLAS, FRAMES FOR UMBRELLAS, GOLF UMBRELLAS, VANITY CASES SOLD EMPTY, COSMETIC CASES SOLD EMPTY, DOCUMENT CASES, HANDBAGS, KEY CASES, LUGGAGE, OVERNIGHT BAGS, PARASOLS (U.S. CLS. 1, 2, 3, 22 AND 41).
FIRST USE 1-1-2005; IN COMMERCE 1-1-2005.
MICHELE SWAIN, EXAMINING ATTORNEY

SN 77-156,959. THE LORD'S PORTER, CO., WAUKESHA, WI. FILED 4-14-2007.

Marathon

THE MARK CONSISTS OF STANDARD CHARACTERS WITHOUT CLAIM TO ANY PARTICULAR FONT, STYLE, SIZE, OR COLOR.

FOR FANCIFULLY DECORATED ORNAMENTAL GOODS MADE OF LEATHER, HIDE OR ANIMAL SKIN, NAMELY- BASEBALL GLOVES AND MITTS (U.S. CLS. 1, 2, 3, 22 AND 41).
DAYNA BROWNE, EXAMINING ATTORNEY

SN 77-156,962. THE LORD'S PORTER, CO., WAUKESHA, WI. FILED 4-14-2007.

Revelation

THE MARK CONSISTS OF STANDARD CHARACTERS WITHOUT CLAIM TO ANY PARTICULAR FONT, STYLE, SIZE, OR COLOR.

FOR FANCIFULLY DECORATED ORNAMENTAL GOODS MADE OF LEATHER, HIDE OR ANIMAL SKIN, NAMELY- BASEBALL GLOVES AND MITTS (U.S. CLS. 1, 2, 3, 22 AND 41).
DAYNA BROWNE, EXAMINING ATTORNEY

CLASS 18—(Continued).

SN 77-157,488. FREEBURG, CHARLES, EDINA, MN. FILED 4-16-2007.

ORIGINAL GAME DAY TOTE

THE MARK CONSISTS OF STANDARD CHARACTERS WITHOUT CLAIM TO ANY PARTICULAR FONT, STYLE, SIZE, OR COLOR.

NO CLAIM IS MADE TO THE EXCLUSIVE RIGHT TO USE "ORIGINAL" AND "TOTE", APART FROM THE MARK AS SHOWN.

FOR TOTE BAGS INCORPORATING BUILT-IN STADIUM SEAT CUSHIONS AND PONCHOS (U.S. CLS. 1, 2, 3, 22 AND 41).

CHARLOTTE CORWIN, EXAMINING ATTORNEY

SN 77-160,190. SWAT.FAME, INC., CITY OF INDUSTRY, CA. FILED 4-18-2007.

SPEECHLESS

THE MARK CONSISTS OF STANDARD CHARACTERS WITHOUT CLAIM TO ANY PARTICULAR FONT, STYLE, SIZE, OR COLOR.

OWNER OF U.S. REG. NO. 1,923,815.

FOR PURSES, WALLETS, HANDBAGS, BACKPACKS, TOTE BAGS, SHOULDER BAGS, CREDIT CARD CASES, LUGGAGE, ATTACHE CASES, TRAVELING BAGS, CARRY-ON BAGS, SPORTS BAGS, BOOK BAGS, SUITCASES, DUFFLE BAGS, CLUTCHES, FANNY PACKS, RUCKSACKS, BEACH BAGS, GARMENT BAGS FOR TRAVEL, AND TOILETRY CASES SOLD EMPTY (U.S. CLS. 1, 2, 3, 22 AND 41).

DAVID H. STINE, EXAMINING ATTORNEY

SN 77-161,021. 3Q1BAG, SAN FRANCISCO, CA. FILED 4-19-2007.

3Q1Bag

THE MARK CONSISTS OF STANDARD CHARACTERS WITHOUT CLAIM TO ANY PARTICULAR FONT, STYLE, SIZE, OR COLOR.

FOR COSMETIC BAGS SOLD EMPTY (U.S. CLS. 1, 2, 3, 22 AND 41).

MARILYN IZZI, EXAMINING ATTORNEY

CLASS 18—(Continued).

SN 77-161,072. SUSAN DELL, INC., NEW YORK, NY. FILED 4-19-2007.

PRETTY POWER

THE MARK CONSISTS OF STANDARD CHARACTERS WITHOUT CLAIM TO ANY PARTICULAR FONT, STYLE, SIZE, OR COLOR.

FOR BACK PACKS, DUFFLE BAGS, FANNY PACKS, GYM BAGS AND SPORTS BAGS (U.S. CLS. 1, 2, 3, 22 AND 41).

LEE-ANNE BERNIS, EXAMINING ATTORNEY

SN 77-166,282. WILI CORPORATION, IRVINE, CA. FILED 4-26-2007.

BARK IN THE DARK

THE MARK CONSISTS OF STANDARD CHARACTERS WITHOUT CLAIM TO ANY PARTICULAR FONT, STYLE, SIZE, OR COLOR.

FOR ILLUMINATED AND LIGHT-REFLECTING DOG CLOTHING, DOG LEASHES AND COLLARS (U.S. CLS. 1, 2, 3, 22 AND 41).

JOHN WILKE, EXAMINING ATTORNEY

SN 77-170,827. HAMILTON, PAIGE, LOS ANGELES, CA. FILED 5-2-2007.

**CHANGE THE WAY YOU CARRY
YOUR LIFE**

THE MARK CONSISTS OF STANDARD CHARACTERS WITHOUT CLAIM TO ANY PARTICULAR FONT, STYLE, SIZE, OR COLOR.

FOR HANDBAGS; PURSES; POCKETBOOKS; WALLETS; WRISTLET BAGS; TOTE BAGS; BEACH BAGS; TRAVEL BAGS; COSMETIC BAGS SOLD EMPTY; COIN PURSES; KEY CASES; LUGGAGE; LUGGAGE TAGS; SUITCASES; GARMENT BAGS FOR TRAVEL; BACKPACKS; ATTACHE CASES; BUSINESS CARD CASES; ALL-PURPOSE CARRYING BAGS; MESSENGER BAGS; ANIMAL CARRIERS; BRIEFCASES (U.S. CLS. 1, 2, 3, 22 AND 41).

ANDREA K. NADELMAN, EXAMINING ATTORNEY

CLASS 18—(Continued).

SN 77-183,309. SPARK INNOVATORS, INC., FAIRFIELD, NJ.
FILED 5-17-2007.

INSTABAG

THE MARK CONSISTS OF STANDARD CHARACTERS WITHOUT CLAIM TO ANY PARTICULAR FONT, STYLE, SIZE, OR COLOR.
FOR TOTE BAGS (U.S. CLS. 1, 2, 3, 22 AND 41).
FIRST USE 5-20-2007; IN COMMERCE 6-1-2007.
SANDRA MANIOS, EXAMINING ATTORNEY

SN 77-198,734. BROOKSTONE PURCHASING, INC., MERRIMACK, NH. FILED 6-6-2007.

Scooter

THE MARK CONSISTS OF STANDARD CHARACTERS WITHOUT CLAIM TO ANY PARTICULAR FONT, STYLE, SIZE, OR COLOR.
FOR LUGGAGE; CARRY-ON BAGS; DUFFEL BAGS; BACKPACKS; SUITCASES (U.S. CLS. 1, 2, 3, 22 AND 41).
JAMES LOVELACE, EXAMINING ATTORNEY

SN 78-781,370. TRUE INDUSTRIAL CO., LTD., SEOUL, REPUBLIC OF KOREA, FILED 12-28-2005.



OWNER OF U.S. REG. NO. 2,824,566.
THE MARK CONSISTS IN PART OF THE STYLIZED WORD TRUE.
FOR BACKPACKS, ATHLETIC BAGS, BOOK BAGS, DUFFEL BAGS, GYM BAGS, TOTE BAGS, TRAVEL BAGS, BRIEFCASES, COIN PURSES, WAIST PACKS, HANDBAGS, HAVERSACKS, KEY CASES, LUGGAGE, PURSES, SCHOOL BAGS, SUITCASES, TRAVELING TRUNKS, SPORTSMAN'S HUNTING BAGS, KNAPSACKS FOR CLIMBERS, UMBRELLAS AND WALLETS (U.S. CLS. 1, 2, 3, 22 AND 41).
FIRST USE 9-10-2005; IN COMMERCE 9-10-2005.
MARY BOAGNI, EXAMINING ATTORNEY

CLASS 18—(Continued).

SN 78-932,610. EQUI-TERNATIVES, INC., BUSHNELL, FL.
FILED 7-19-2006.

Hit the Trail

THE MARK CONSISTS OF STANDARD CHARACTERS WITHOUT CLAIM TO ANY PARTICULAR FONT, STYLE, SIZE, OR COLOR.
FOR LUGGAGE, SUITCASES, DUFFLE BAGS, TOTE BAGS (U.S. CLS. 1, 2, 3, 22 AND 41).
MICHAEL LEWIS, EXAMINING ATTORNEY

SN 78-943,332. PEACHTREE PRODUCTS INC, CRYSTAL RIVER, FL. FILED 8-2-2006.

Rock Dog Couture

THE MARK CONSISTS OF STANDARD CHARACTERS WITHOUT CLAIM TO ANY PARTICULAR FONT, STYLE, SIZE, OR COLOR.
NO CLAIM IS MADE TO THE EXCLUSIVE RIGHT TO USE "DOG COUTURE", APART FROM THE MARK AS SHOWN.
FOR CLOTHING FOR DOMESTIC PETS; COLLARS FOR PETS; PET CLOTHING; PET COLLAR ACCESSORIES, NAMELY, BOWS AND CHARMS (U.S. CLS. 1, 2, 3, 22 AND 41).
FIRST USE 7-25-2006; IN COMMERCE 7-25-2006.
PAULA MAHONEY, EXAMINING ATTORNEY

SN 78-948,057. BOBBI BROWN PROFESSIONAL COSMETICS, INC., NEW YORK, NY. FILED 8-9-2006.

BOBBI BROWN

THE MARK CONSISTS OF STANDARD CHARACTERS WITHOUT CLAIM TO ANY PARTICULAR FONT, STYLE, SIZE, OR COLOR.
OWNER OF U.S. REG. NOS. 1,700,112, 2,154,628 AND 2,431,768.
THE NAME BOBBI BROWN IDENTIFIES A LIVING INDIVIDUAL WHOSE CONSENT IS OF RECORD.
FOR COSMETIC BAGS SOLD EMPTY (U.S. CLS. 1, 2, 3, 22 AND 41).
FIRST USE 1-1-1995; IN COMMERCE 1-1-1995.
LINDA MICKLEBURGH, EXAMINING ATTORNEY

CLASS 18—(Continued).

SN 78-957,116. ADELINE MEDIA, INC., LOS ANGELES, CA.
FILED 8-21-2006.



THE NAME SHOWN IN THE MARK IDENTIFIES THOMAS AUGUST PARO WHOSE CONSENT IS OF RECORD. THE MARK CONSISTS OF THE SIGNATURE OF "TOM AUGUST".
FOR PURSES, BACKPACKS, WALLETS, TOTE BAGS AND LEATHER KEY CHAINS. (U.S. CLS. 1, 2, 3, 22 AND 41).
MATTHEW PAPPAS, EXAMINING ATTORNEY

SN 78-971,712. BALLY TOTAL FITNESS HOLDING CORPORATION, CHICAGO, IL. FILED 9-11-2006.

BALLY TOTAL FITNESS

THE MARK CONSISTS OF STANDARD CHARACTERS WITHOUT CLAIM TO ANY PARTICULAR FONT, STYLE, SIZE, OR COLOR.
OWNER OF U.S. REG. NOS. 1,992,150, 2,917,971 AND OTHERS.
NO CLAIM IS MADE TO THE EXCLUSIVE RIGHT TO USE "FITNESS", APART FROM THE MARK AS SHOWN.
FOR KNAPSACKS, GYM BAGS AND TOTE BAGS RELATED TO FITNESS, SPORTS OR ATHLETICS (U.S. CLS. 1, 2, 3, 22 AND 41).
PATRICIA EVANKO, EXAMINING ATTORNEY

SN 79-040,006. STARGATE BRAND GROUP AB, SWEDEN,
FILED 12-20-2006.



OWNER OF INTERNATIONAL REGISTRATION 0928172 DATED 12-20-2006, EXPIRES 12-20-2016.
FOR CREDIT CARD HOLDERS; BUSINESS CARD HOLDERS; WALLETS; BAGS, NAMELY, ATHLETIC BAGS, TRAVEL BAGS, HAND BAGS, SHOULDER BAGS (U.S. CLS. 1, 2, 3, 22 AND 41).
KAREN K. BUSH, EXAMINING ATTORNEY

CLASS 19—NON-METALLIC BUILDING MATERIALS

SN 76-673,433. AFG INDUSTRIES, INC., KINGSPORT, TN.
FILED 3-1-2007.

DEFENDER

THE MARK CONSISTS OF STANDARD CHARACTERS WITHOUT CLAIM TO ANY PARTICULAR FONT, STYLE, SIZE, OR COLOR.
FOR LAMINATED GLASS (U.S. CLS. 1, 12, 33 AND 50).
FIRST USE 9-1-2006; IN COMMERCE 9-1-2006.
BONNIE LUKEN, EXAMINING ATTORNEY

SN 76-675,170. AFG INDUSTRIES, INC., KINGSPORT, TN.
FILED 4-5-2007.

DEFENDER TI

THE MARK CONSISTS OF STANDARD CHARACTERS WITHOUT CLAIM TO ANY PARTICULAR FONT, STYLE, SIZE, OR COLOR.
NO CLAIM IS MADE TO THE EXCLUSIVE RIGHT TO USE "TI", APART FROM THE MARK AS SHOWN.
FOR LAMINATED GLASS (U.S. CLS. 1, 12, 33 AND 50).
FIRST USE 9-1-2006; IN COMMERCE 9-1-2006.
BONNIE LUKEN, EXAMINING ATTORNEY

SN 77-036,127. LF, LLC, WILMINGTON, DE. FILED 11-3-2006.

CUSTOM SIZE NOW

THE MARK CONSISTS OF STANDARD CHARACTERS WITHOUT CLAIM TO ANY PARTICULAR FONT, STYLE, SIZE, OR COLOR.
OWNER OF U.S. REG. NO. 2,556,718.
NO CLAIM IS MADE TO THE EXCLUSIVE RIGHT TO USE "CUSTOM SIZE", APART FROM THE MARK AS SHOWN.
FOR NON-METAL WINDOW SHUTTERS (U.S. CLS. 1, 12, 33 AND 50).
WOODROW HARTZOG, EXAMINING ATTORNEY

CLASS 19—(Continued).

SN 77-053,612. CONSTRUCTION DJL INC., BOUCHERVILLE, QUEBEC, CANADA, FILED 11-29-2006.

CLASS 19—(Continued).

SN 77-155,953. SALEMIE, BERNARD, LANHAM, MD. FILED 4-13-2007.

RECYFLEX

THAT DAM THING

THE MARK CONSISTS OF STANDARD CHARACTERS WITHOUT CLAIM TO ANY PARTICULAR FONT, STYLE, SIZE, OR COLOR.
OWNER OF CANADA REG. NO. TMA583744, DATED 6-13-2003, EXPIRES 6-13-2018.
FOR BITUMINOUS CONCRETE (U.S. CLS. 1, 12, 33 AND 50).
JULIE WATSON, EXAMINING ATTORNEY

THE MARK CONSISTS OF STANDARD CHARACTERS WITHOUT CLAIM TO ANY PARTICULAR FONT, STYLE, SIZE, OR COLOR.
FOR PORTABLE, INFLATABLE NON-METAL FLOOD BARRIERS (U.S. CLS. 1, 12, 33 AND 50).
LINDA ESTRADA, EXAMINING ATTORNEY

SN 77-142,784. TIMBERTECH LIMITED, WILMINGTON, OH. FILED 3-28-2007.

SN 77-156,850. DAVINCI DRIVEWAYS,LLC, STRATFORD, CT. FILED 4-14-2007.

BUILDERRAIL

StoneBond

THE MARK CONSISTS OF STANDARD CHARACTERS WITHOUT CLAIM TO ANY PARTICULAR FONT, STYLE, SIZE, OR COLOR.
OWNER OF U.S. REG. NO. 3,178,753.
FOR NON-METAL RAILING SYSTEMS FOR USE IN BUILDING CONSTRUCTION, CONSISTING OF RAILINGS, BOARDS AND BALUSTERS (U.S. CLS. 1, 12, 33 AND 50).
DAVID H. STINE, EXAMINING ATTORNEY

THE MARK CONSISTS OF STANDARD CHARACTERS WITHOUT CLAIM TO ANY PARTICULAR FONT, STYLE, SIZE, OR COLOR.
FOR STONES (U.S. CLS. 1, 12, 33 AND 50).
SOPHIA S. KIM, EXAMINING ATTORNEY

SN 77-151,621. M2M RESEARCH INC., WRIGHTSVILLE BEACH, NC. FILED 4-9-2007.

SN 77-157,811. INDUSTRIAL LAMINATES/NORPLEX, INC., POSTVILLE, IA. FILED 4-16-2007.

SMAR-T-POLE

STORMBLOCKER

THE MARK CONSISTS OF STANDARD CHARACTERS WITHOUT CLAIM TO ANY PARTICULAR FONT, STYLE, SIZE, OR COLOR.
FOR NON-METAL TEMPORARY POLES FOR ELECTRIC POWER LINES (U.S. CLS. 1, 12, 33 AND 50).
ALYSSA PALADINO, EXAMINING ATTORNEY

THE MARK CONSISTS OF STANDARD CHARACTERS WITHOUT CLAIM TO ANY PARTICULAR FONT, STYLE, SIZE, OR COLOR.
FOR BUILDING CONSTRUCTION MATERIALS, NAMELY, COMPOSITE PANELS MADE OF WOVEN FIBERGLASS AND CELLULOSIC MATERIALS (U.S. CLS. 1, 12, 33 AND 50).
FIRST USE 0-0-2001; IN COMMERCE 1-0-2003.
CYNTHIA SLOAN, EXAMINING ATTORNEY

CLASS 19—(Continued).

SN 77-157,922. GRANITE & MARBLE RESOURCES, INC., CHICAGO, IL. FILED 4-16-2007.

StoneWood

FOR STONE FOR BUILDING AND CONSTRUCTION (U.S. CLS. 1, 12, 33 AND 50).
MATTHEW MCDOWELL, EXAMINING ATTORNEY

SN 77-158,443. STELLAR WOOD PRODUCTS LLC, SUMNER, WA. FILED 4-17-2007.

PROPLANK

THE MARK CONSISTS OF STANDARD CHARACTERS WITHOUT CLAIM TO ANY PARTICULAR FONT, STYLE, SIZE, OR COLOR.
FOR NON-METAL SCAFFOLDING (U.S. CLS. 1, 12, 33 AND 50).
LYDIA BELZER, EXAMINING ATTORNEY

SN 77-161,687. TIMBERTECH LIMITED, WILMINGTON, OH. FILED 4-20-2007.

XLM

THE MARK CONSISTS OF STANDARD CHARACTERS WITHOUT CLAIM TO ANY PARTICULAR FONT, STYLE, SIZE, OR COLOR.
FOR NON-METALLIC BUILDING MATERIAL, NAMELY, DECKING BOARDS MADE OF POLYMERS (U.S. CLS. 1, 12, 33 AND 50).
DAVID H. STINE, EXAMINING ATTORNEY

CLASS 19—(Continued).

SN 77-161,891. ROMEO RIM, INC., ROMEO, MI. FILED 4-20-2007.

ROMEOROCK

THE MARK CONSISTS OF STANDARD CHARACTERS WITHOUT CLAIM TO ANY PARTICULAR FONT, STYLE, SIZE, OR COLOR.

FOR POLYURETHANE PANELS USED AS BUILDING SUPPLY MATERIALS FOR EXTERIOR AND INTERIOR APPLICATIONS ON STRUCTURES (U.S. CLS. 1, 12, 33 AND 50).
RENEE SERVANCE, EXAMINING ATTORNEY

SN 77-165,499. CERTAINTEED CORPORATION, VALLEY FORGE, PA. FILED 4-25-2007.

WINTERGUARD

THE MARK CONSISTS OF STANDARD CHARACTERS WITHOUT CLAIM TO ANY PARTICULAR FONT, STYLE, SIZE, OR COLOR.

FOR ROOFING MATERIAL, NAMELY WATER-PROOFING UNDERLAYMENT (U.S. CLS. 1, 12, 33 AND 50).
FIRST USE 0-0-1987; IN COMMERCE 0-0-1987.
LOURDES AYALA, EXAMINING ATTORNEY

SN 77-189,760. RBG PRODUCTS, LLC, KENNETT SQUARE, PA. FILED 7-27-2007.

Zandur

THE MARK CONSISTS OF STANDARD CHARACTERS WITHOUT CLAIM TO ANY PARTICULAR FONT, STYLE, SIZE, OR COLOR.

FOR PARQUET FLOORING OF CORK; RUBBER FLOORING (U.S. CLS. 1, 12, 33 AND 50).
GISELLE AGOSTO, EXAMINING ATTORNEY

CLASS 19—(Continued).

SN 78-870,228. NICHIIHA CORPORATION, NAGOYA-SHI, JAPAN, FILED 4-26-2006.



OWNER OF U.S. REG. NOS. 2,307,765 AND 2,503,376.
THE MARK CONSISTS OF IN PART OF THE LETTER "N" IN STYLIZED FORM.

FOR NON-METAL BUILDING MATERIALS, NAMELY, CEMENT EXTERIOR WALLS FOR RESIDENTIAL/COMMERCIAL BUILDINGS (U.S. CLS. 1, 12, 33 AND 50).
MONIQUE MILLER, EXAMINING ATTORNEY

CLASS 19—(Continued).

SN 79-029,429. LAFARGE, FRANCE, FILED 9-18-2006.

SENSIUM

PRIORITY DATE OF 3-23-2006 IS CLAIMED.
OWNER OF INTERNATIONAL REGISTRATION 0899820 DATED 9-18-2006, EXPIRES 9-18-2016.

FOR NON-METALLIC BUILDING MATERIALS, NAMELY, HYDRAULIC BINDERS, NAMELY, MINERAL BASED CEMENTITIOUS MATERIALS IN THE NATURE OF PORTLAND, HYDRAULIC, WHITE, MASONRY, PLASTIC, STUCCO AND OIL WELL CEMENT, OTHER MINERAL-BASED CEMENTITIOUS MATERIALS AND POZZOLANIC MATERIALS IN THE NATURE OF BLAST FURNACE SLAG, COAL CLINKER AND FLY ASH; CEMENT MIXES, SPECIAL CEMENT, SILICA FUME CEMENTS, BLAST FURNACE CEMENTS, DRILLING CEMENTS, ALUMINATE CEMENTS, NON-AGRICULTURAL LIME FOR USE IN CONSTRUCTION; CONCRETES; MORTARS (U.S. CLS. 1, 12, 33 AND 50).
AMY BROZENIC, EXAMINING ATTORNEY

SN 78-932,405. ASTRAL PROPERTY PTY LTD, CHATSWOOD, AUSTRALIA, FILED 7-18-2006.

G-OCELL

THE MARK CONSISTS OF STANDARD CHARACTERS WITHOUT CLAIM TO ANY PARTICULAR FONT, STYLE, SIZE, OR COLOR.

OWNER OF AUSTRALIA REG. NO. 1058108, DATED 5-26-2005, EXPIRES 5-26-2015.

FOR UNDERGROUND PLASTIC DRAINAGE CELLS; PLASTIC CONDUITS FOR DRAINAGE AND INFILTRATION, NAMELY, UNDERGROUND PERFORATED PLASTIC PIPES; AND WALL PANELS NOT OF METAL, NAMELY, PERFORATED PLASTIC OR POROUS WALL PANELS FOR USE IN DRAINAGE (U.S. CLS. 1, 12, 33 AND 50).
SKYE YOUNG, EXAMINING ATTORNEY

SN 79-037,480. MAC DOUGLAS WOOD FLOORING; (SUZHOU) CO., LTD., CHINA, FILED 3-13-2007.



OWNER OF INTERNATIONAL REGISTRATION 0921436 DATED 3-13-2007, EXPIRES 3-13-2017.

NO CLAIM IS MADE TO THE EXCLUSIVE RIGHT TO USE "FLOOR" AND "DI BAN", APART FROM THE MARK AS SHOWN.

THE ENGLISH TRANSLATION OF THE FOREIGN WORD(S) IN THE MARK IS: THE FIRST CHINESE CHARACTER MEANS "WHEAT", THE SECOND CHINESE CHARACTER MEANS "WAY". THE TWO CHINESE CHARACTERS ARE OF NO MEANING IN COMBINATION, THE LAST TWO CHINESE CHARACTERS MEAN "FLOOR BOARD".

THE TRANSLITERATION OF THE NON-LATIN CHARACTERS IN THE MARK IS: "MAI DAO DI BAN".

FOR FLOOR BOARDS (U.S. CLS. 1, 12, 33 AND 50).
KAREN SEVERSON, EXAMINING ATTORNEY

CLASS 20—FURNITURE AND ARTICLES NOT OTHERWISE CLASSIFIED

SN 76-661,110. HASELTINE, FLORENCE P., ALEXANDRIA, VA. FILED 6-2-2006.

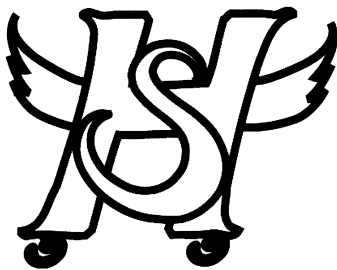

OWNER OF U.S. REG. NO. 2,055,208.

THE MARK CONSISTS OF A STYLIZED LETTER S ON TOP OF A STYLIZED LETTER H WHICH FEATURES WINGS TO THE LEFT AND RIGHT OF THE LETTER H AND TWO WHEELS ON THE BOTTOM PORTION OF THE LETTER H.

FOR CONTAINERS MADE OF PLASTIC FOR THE PROTECTION OF WHEELCHAIRS DURING THE TRANSPORT (U.S. CLS. 2, 13, 22, 25, 32 AND 50).

FIRST USE 2-5-1996; IN COMMERCE 2-5-1996.

WARREN L. OLANDRIA, EXAMINING ATTORNEY

SN 76-665,194. LIFESTYLE SOLUTIONS, INC., MILPITAS, CA. FILED 8-28-2006.



FOR FURNITURE, NAMELY, SOFABEDS, FUTONS, BEDS, NIGHTSTANDS, ARMOIRES, DRESSERS AND TABLES (U.S. CLS. 2, 13, 22, 25, 32 AND 50).

FIRST USE 7-0-2003; IN COMMERCE 7-0-2003.

ALICE BENMAMAN, EXAMINING ATTORNEY

CLASS 20—(Continued).

SN 76-676,676. JAY FRANCO & SONS, INC., NEW YORK, NY. FILED 5-11-2007.

PILLOWSCAPES

THE MARK CONSISTS OF STANDARD CHARACTERS WITHOUT CLAIM TO ANY PARTICULAR FONT, STYLE, SIZE, OR COLOR.

FOR PILLOWS CONTAINING SOUND PRODUCING DEVICES (U.S. CLS. 2, 13, 22, 25, 32 AND 50).

PATRICIA EVANKO, EXAMINING ATTORNEY

SN 77-034,657. LUTZ, EUGENE, LIGHTHOUSE POINT, FL. FILED 11-1-2006.

BAGRITE

THE MARK CONSISTS OF STANDARD CHARACTERS WITHOUT CLAIM TO ANY PARTICULAR FONT, STYLE, SIZE, OR COLOR.

FOR A PLASTIC FRAME FOR HOLDING A GARBAGE BAG OPEN, NAMELY, A HAND HELD BAG HOLDER (U.S. CLS. 2, 13, 22, 25, 32 AND 50).

ZACHARY BELLO, EXAMINING ATTORNEY

SN 77-037,225. ORIGINAL ARTS MANUFACTURING CORPORATION, RAHWAY, NJ. FILED 11-6-2006.

**ANDRE ORIGINALS
MANUFACTURING CO.**

THE MARK CONSISTS OF STANDARD CHARACTERS WITHOUT CLAIM TO ANY PARTICULAR FONT, STYLE, SIZE, OR COLOR.

NO CLAIM IS MADE TO THE EXCLUSIVE RIGHT TO USE "ORIGINALS MANUFACTURING CO.", APART FROM THE MARK AS SHOWN.

SEC. 2(F) AS TO "ORIGINALS".

FOR CHAIR CUSHIONS; CHAIRS; DINING CHAIRS; DINING TABLES; FURNITURE; FURNITURE CHESTS; FURNITURE PARTITIONS; FURNITURE, NAMELY, DRESSERS; FURNITURE, NAMELY, WALL UNITS; FURNITURE, NAMELY, WARDROBES; RECLINERS; SEATING FURNITURE; SEATS; TABLES; TEA TABLES (U.S. CLS. 2, 13, 22, 25, 32 AND 50).

FIRST USE 5-21-1991; IN COMMERCE 5-21-1991.

MICHAEL ENGEL, EXAMINING ATTORNEY

CLASS 20—(Continued).

SN 77-074,594. C.D.I. ENTERPRISES, INC., INDIANAPOLIS, IN. FILED 1-2-2007.

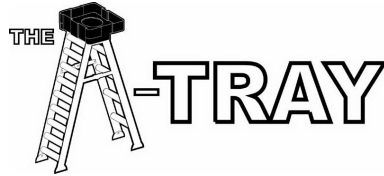

FOR LADDER ACCESSORIES, NAMELY NON-METAL TRAYS (U.S. CLS. 2, 13, 22, 25, 32 AND 50).
CHRISIE B. KING, EXAMINING ATTORNEY

SN 77-080,311. DATAKEY ELECTRONICS, INC., SAVAGE, MN. FILED 1-10-2007.

DATAKEY

THE MARK CONSISTS OF STANDARD CHARACTERS WITHOUT CLAIM TO ANY PARTICULAR FONT, STYLE, SIZE, OR COLOR.

OWNER OF U.S. REG. NOS. 1,455,104 AND 1,457,273.
FOR PLASTIC CONTAINERS FOR COMMERCIAL USE TO HOUSE SEMICONDUCTORS, INTEGRATED CIRCUITS, MICROPROCESSORS AND MICROCOMPUTERS (U.S. CLS. 2, 13, 22, 25, 32 AND 50).

FIRST USE 2-1-1980; IN COMMERCE 2-1-1980.
WENDY GOODMAN, EXAMINING ATTORNEY

SN 77-085,693. ABOUTSPACE, INC., ZEELAND, MI. FILED 1-18-2007.

ABOUTSPACE

THE MARK CONSISTS OF STANDARD CHARACTERS WITHOUT CLAIM TO ANY PARTICULAR FONT, STYLE, SIZE, OR COLOR.

FOR TABLES SPECIALLY DESIGNED FOR HOLDING PRINTERS; RESIDENTIAL AND OFFICE ORGANIZING FURNITURE, NAMELY, CABINETS FOR TOOLS AND CLOTHING; SHELVING; CLOTHING RODS; CLOTHES HANGERS; DESKS; CABINETS FOR STORAGE OF LIQUID PRODUCTS, IN CONTAINERS; CABINETS FOR GENERAL STORAGE OF HOME AND OFFICE SUPPLIES (U.S. CLS. 2, 13, 22, 25, 32 AND 50).

FIRST USE 6-0-2005; IN COMMERCE 6-0-2005.
DEZMONA MIZELLE, EXAMINING ATTORNEY

CLASS 20—(Continued).

SN 77-089,467. JMBP, INC., LOS ANGELES, CA. FILED 1-23-2007.

ARE YOU SMARTER THAN A 5TH GRADER?

THE MARK CONSISTS OF STANDARD CHARACTERS WITHOUT CLAIM TO ANY PARTICULAR FONT, STYLE, SIZE, OR COLOR.

FOR FURNITURE; PILLOWS (U.S. CLS. 2, 13, 22, 25, 32 AND 50).
KYLE PEETE, EXAMINING ATTORNEY

SN 77-106,349. FSH, INC., WESTBURY, NY. FILED 2-13-2007.



NO CLAIM IS MADE TO THE EXCLUSIVE RIGHT TO USE "FULLSIZE", APART FROM THE MARK AS SHOWN.

THE MARK CONSISTS OF A HANGER WITH THE WORDS "FULL SIZE" WRITTEN INSIDE. THE TOP OF THE LETTER "S" IS DRAWN AS THE HOOK OF THE HANGER..

FOR CLOTHES HANGERS; COAT HANGERS; HANGERS FOR CLOTHES (U.S. CLS. 2, 13, 22, 25, 32 AND 50).
FIRST USE 9-15-2006; IN COMMERCE 9-15-2006.
AMY MCMENAMIN, EXAMINING ATTORNEY

SN 77-130,578. TERRIBLE, PAUL V, NEW BERN, NC. FILED 3-14-2007.

NO CLAIM IS MADE TO THE EXCLUSIVE RIGHT TO USE "WINDOW FASHIONS", APART FROM THE MARK AS SHOWN.

THE COLOR(S) ORANGE AND BLUE IS/ARE CLAIMED AS A FEATURE OF THE MARK.

THE MARK CONSISTS OF ORANGE SUN WITH BLUE OUTLINE AND BLUE TEXT.

FOR WINDOW BLINDS; BLINDS OF REED, RATTAN OR BAMBOO (SUDARE); DECORATIVE WINDOW FINIALS; FABRIC WINDOW BLINDS; METAL INDOOR WINDOW BLINDS; NON-METAL WINDOW TRIMS; VENETIAN BLINDS; WINDOW SHADES (U.S. CLS. 2, 13, 22, 25, 32 AND 50).

FIRST USE 5-1-2006; IN COMMERCE 5-1-2006.
PAM WILLIS, EXAMINING ATTORNEY

CLASS 20—(Continued).

SN 77-148,660. MIX IT SMOOTH, LLC, NEW YORK, NY.
FILED 4-4-2007.

The Bath Bloomers Aroma Bar

THE MARK CONSISTS OF STANDARD CHARACTERS WITHOUT CLAIM TO ANY PARTICULAR FONT, STYLE, SIZE, OR COLOR.

OWNER OF U.S. REG. NO. 2,255,164.
FOR PRODUCT DISPLAY EQUIPMENT, NAMELY, DISPLAY UNITS FOR PERFUMES, SKIN CARE PRODUCTS, BODY SOAPS, AND RELATED TOILETRIES (U.S. CLS. 2, 13, 22, 25, 32 AND 50).
THOMAS MANOR, EXAMINING ATTORNEY

CLASS 20—(Continued).

SN 77-153,058. STEINHAFELS, INC., WAUKESHA, WI.
FILED 4-10-2007.

SMALL SPACE SOLUTIONS

THE MARK CONSISTS OF STANDARD CHARACTERS WITHOUT CLAIM TO ANY PARTICULAR FONT, STYLE, SIZE, OR COLOR.

NO CLAIM IS MADE TO THE EXCLUSIVE RIGHT TO USE "SMALL SPACE", APART FROM THE MARK AS SHOWN.
FOR FURNITURE (U.S. CLS. 2, 13, 22, 25, 32 AND 50).
RUSS HERMAN, EXAMINING ATTORNEY

SN 77-149,777. WILSON MATTRESS, INC., MIAMI, FL.
FILED 4-5-2007.

Wilson Mattress

THE MARK CONSISTS OF STANDARD CHARACTERS WITHOUT CLAIM TO ANY PARTICULAR FONT, STYLE, SIZE, OR COLOR.

NO CLAIM IS MADE TO THE EXCLUSIVE RIGHT TO USE "MATTRESS", APART FROM THE MARK AS SHOWN.
FOR MATTRESSES; SLEEP PRODUCTS, NAMELY, MATTRESSES, SPRING MATTRESSES, BOX SPRINGS AND MATTRESS FOUNDATIONS (U.S. CLS. 2, 13, 22, 25, 32 AND 50).
ALYSSA PALADINO, EXAMINING ATTORNEY

SN 77-153,085. STEINHAFELS, INC., WAUKESHA, WI.
FILED 4-10-2007.

DIRECT DESIGNS

THE MARK CONSISTS OF STANDARD CHARACTERS WITHOUT CLAIM TO ANY PARTICULAR FONT, STYLE, SIZE, OR COLOR.

NO CLAIM IS MADE TO THE EXCLUSIVE RIGHT TO USE "DESIGNS", APART FROM THE MARK AS SHOWN.
FOR FURNITURE (U.S. CLS. 2, 13, 22, 25, 32 AND 50).
RUSS HERMAN, EXAMINING ATTORNEY

SN 77-152,101. KING RANCH IP, LLC, WILMINGTON, DE.
FILED 4-9-2007.



OWNER OF U.S. REG. NOS. 3,049,538, 3,116,089 AND OTHERS.
FOR FURNITURE (U.S. CLS. 2, 13, 22, 25, 32 AND 50).
FIRST USE 12-31-1984; IN COMMERCE 12-31-1984.
KATHERINE M. DUBRAY, EXAMINING ATTORNEY

SN 77-153,338. GOTOMYOB, LLC, SOUTH SALEM, NY.
FILED 4-10-2007.

THE BABY CUBE

THE MARK CONSISTS OF STANDARD CHARACTERS WITHOUT CLAIM TO ANY PARTICULAR FONT, STYLE, SIZE, OR COLOR.

NO CLAIM IS MADE TO THE EXCLUSIVE RIGHT TO USE "CUBE", APART FROM THE MARK AS SHOWN.
FOR PICTURE FRAMES (U.S. CLS. 2, 13, 22, 25, 32 AND 50).
KATHERINE CHANG, EXAMINING ATTORNEY

CLASS 20—(Continued).

SN 77-155,807. WILSON, BARBARA JO, NAPLES, FL. FILED 4-13-2007.

Gwinny Mango

THE MARK CONSISTS OF STANDARD CHARACTERS WITHOUT CLAIM TO ANY PARTICULAR FONT, STYLE, SIZE, OR COLOR.

FOR FURNITURE (U.S. CLS. 2, 13, 22, 25, 32 AND 50).
KIMBERLY PERRY, EXAMINING ATTORNEY

SN 77-157,593. PINKSIDE, NEWPORT BEACH, CA. FILED 4-16-2007.

HIPPY HANGERS

THE MARK CONSISTS OF STANDARD CHARACTERS WITHOUT CLAIM TO ANY PARTICULAR FONT, STYLE, SIZE, OR COLOR.

NO CLAIM IS MADE TO THE EXCLUSIVE RIGHT TO USE "HANGERS", APART FROM THE MARK AS SHOWN. FOR HANGERS FOR CLOTHES (U.S. CLS. 2, 13, 22, 25, 32 AND 50).

ALEX KEAM, EXAMINING ATTORNEY

SN 77-158,437. KRAFTMAID CABINETRY, INC., MIDDLEFIELD, OH. FILED 4-17-2007.

IT BECOMES YOU

THE MARK CONSISTS OF STANDARD CHARACTERS WITHOUT CLAIM TO ANY PARTICULAR FONT, STYLE, SIZE, OR COLOR.

FOR CABINETRY (U.S. CLS. 2, 13, 22, 25, 32 AND 50).
ANTHONY RINKER, EXAMINING ATTORNEY

CLASS 20—(Continued).

SN 77-159,297. WORLDWIDE ACCESS LLC, COLLIERVILLE, TN. FILED 4-18-2007.

Outdoor Retreat

THE MARK CONSISTS OF STANDARD CHARACTERS WITHOUT CLAIM TO ANY PARTICULAR FONT, STYLE, SIZE, OR COLOR.

NO CLAIM IS MADE TO THE EXCLUSIVE RIGHT TO USE "OUTDOOR", APART FROM THE MARK AS SHOWN. FOR CUSHIONS; FITTED FABRIC FURNITURE COVERS; LAWN FURNITURE; OUTDOOR FURNITURE; PLASTIC FURNITURE FOR GARDENS (U.S. CLS. 2, 13, 22, 25, 32 AND 50).

MICHELE SWAIN, EXAMINING ATTORNEY

SN 77-159,492. LEXOR, INC., BALTIMORE, MD. FILED 4-18-2007.



THE MARK CONSISTS OF THE "ELITE ULTRA" DESIGN AS THE WORD "ELITE" ENCIRCLED AND "ULTRA" IS A SUBSCRIPT NEXT TO "ELITE".

FOR PEDICURE SPA CHAIR (U.S. CLS. 2, 13, 22, 25, 32 AND 50).

FIRST USE 9-0-2000; IN COMMERCE 9-0-2000.

CHARLOTTE CORWIN, EXAMINING ATTORNEY

SN 77-159,496. LEXOR, INC., BALTIMORE, MD. FILED 4-18-2007.



THE MARK CONSISTS OF THE WORD "LEXOR" ABOVE A CIRCLE COMPOSED OF SIX TRIANGLES.

FOR PEDICURE SPA CHAIRS (U.S. CLS. 2, 13, 22, 25, 32 AND 50).

FIRST USE 3-0-2000; IN COMMERCE 3-0-2000.

CHARLOTTE CORWIN, EXAMINING ATTORNEY

CLASS 20—(Continued).

SN 77-159,503. LEXOR, INC, SANTA ANA, CA. FILED 4-18-2007.



NO CLAIM IS MADE TO THE EXCLUSIVE RIGHT TO USE "FOOT SPA", APART FROM THE MARK AS SHOWN. THE MARK CONSISTS OF THE WORDS VERSAS FOOT SPA IN A STYLIZED FONT AND ENCASED IN A CIRCLE. FOR PEDICURE SPA CHAIR (U.S. CLS. 2, 13, 22, 25, 32 AND 50).
FIRST USE 9-0-2000; IN COMMERCE 9-0-2000.
CHARLOTTE CORWIN, EXAMINING ATTORNEY

CLASS 20—(Continued).

SN 77-159,554. ORGANIZERAGAMI, INC., SAN JOSE, CA. FILED 4-18-2007.

We don't make the space...
we help you make it better.

THE MARK CONSISTS OF STANDARD CHARACTERS WITHOUT CLAIM TO ANY PARTICULAR FONT, STYLE, SIZE, OR COLOR.
FOR USER-ASSEMBLED PARTITIONS, DIVIDERS AND SEPARATORS FOR KITCHEN, LAUNDRY, BATH AND OTHER HOUSEHOLD DRAWERS (U.S. CLS. 2, 13, 22, 25, 32 AND 50).
ALICE SUE CARRUTHERS, EXAMINING ATTORNEY

SN 77-159,505. LEXOR, INC., BALTIMORE, MD. FILED 4-18-2007.



THE MARK CONSISTS OF A SYTLIZED LOGO DESIGN OF THE WORD "MYSTIQUE".
FOR PEDICURE SPA CHAIR (U.S. CLS. 2, 13, 22, 25, 32 AND 50).
FIRST USE 5-0-2004; IN COMMERCE 5-0-2004.
CHARLOTTE CORWIN, EXAMINING ATTORNEY

SN 77-159,582. NORWOOD OPERATING COMPANY, DBA NORWOOD PROMOTIONAL PRODUCTS, INDIANAPOLIS, IN. FILED 4-18-2007.

EVOLUCENT

THE MARK CONSISTS OF STANDARD CHARACTERS WITHOUT CLAIM TO ANY PARTICULAR FONT, STYLE, SIZE, OR COLOR.
FOR PLAQUES OF ACRYLIC; NON-METAL TROPHIES (U.S. CLS. 2, 13, 22, 25, 32 AND 50).
ANDREA K. NADELMAN, EXAMINING ATTORNEY

SN 77-159,530. ORGANIZERAGAMI, INC., SAN JOSE, CA. FILED 4-18-2007.

OrganizerAgami

THE MARK CONSISTS OF STANDARD CHARACTERS WITHOUT CLAIM TO ANY PARTICULAR FONT, STYLE, SIZE, OR COLOR.
FOR USER-ASSEMBLED PARTITIONS, DIVIDERS AND SEPARATORS FOR KITCHEN, LAUNDRY, BATH AND OTHER HOUSEHOLD DRAWERS (U.S. CLS. 2, 13, 22, 25, 32 AND 50).
ALICE SUE CARRUTHERS, EXAMINING ATTORNEY

SN 77-160,245. RICH XIBERTA, S.A., GIRONA, SPAIN, FILED 4-19-2007.

RICH XIBERTA

THE MARK CONSISTS OF STANDARD CHARACTERS WITHOUT CLAIM TO ANY PARTICULAR FONT, STYLE, SIZE, OR COLOR.
FOR CORKS; NON-METAL TIME CAPSULES (U.S. CLS. 2, 13, 22, 25, 32 AND 50).
FIRST USE 12-31-1875; IN COMMERCE 12-31-1985.
CHERYL CLAYTON, EXAMINING ATTORNEY

CLASS 20—(Continued).

SN 77-160,818. WAL-MART STORES, INC., BENTONVILLE, AR. FILED 4-19-2007.

PARKLANE

THE MARK CONSISTS OF STANDARD CHARACTERS WITHOUT CLAIM TO ANY PARTICULAR FONT, STYLE, SIZE, OR COLOR.
FOR FURNITURE (U.S. CLS. 2, 13, 22, 25, 32 AND 50).
SCOTT SISUN, EXAMINING ATTORNEY

SN 77-160,835. WAL-MART STORES, INC., BENTONVILLE, AR. FILED 4-19-2007.

SHOREWOOD

THE MARK CONSISTS OF STANDARD CHARACTERS WITHOUT CLAIM TO ANY PARTICULAR FONT, STYLE, SIZE, OR COLOR.
FOR FURNITURE (U.S. CLS. 2, 13, 22, 25, 32 AND 50).
SCOTT SISUN, EXAMINING ATTORNEY

SN 77-161,314. AWAD, JAMIL, ANAHEIM, CA. FILED 4-19-2007.

Maximum Comfort

THE MARK CONSISTS OF STANDARD CHARACTERS WITHOUT CLAIM TO ANY PARTICULAR FONT, STYLE, SIZE, OR COLOR.
FOR MATTRESSES; SLEEP PRODUCTS, NAMELY, MATTRESSES, SPRING MATTRESSES, BOX SPRINGS AND MATTRESS FOUNDATIONS; BED FRAMES; BEDS; PILLOWS; FUTON MATTRESSES; MATTRESS CUSHIONS; MATTRESS TOPPERS; AIR MATTRESSES FOR USE WHEN CAMPING; INFLATABLE MATTRESSES FOR USE WHEN CAMPING; MATTRESS FOUNDATIONS; MATTRESSES MADE OF FLEXIBLE WOOD; NAP MATS; BED HEADBOARDS; BED RAILS; BEDS FOR HOUSEHOLD PETS (U.S. CLS. 2, 13, 22, 25, 32 AND 50).
GINA HAYES, EXAMINING ATTORNEY

CLASS 20—(Continued).

SN 77-161,980. DANIEL JOSHUA GOLDSTEIN, SAN FRANCISCO, CA. FILED 4-20-2007.

TV2ART

THE MARK CONSISTS OF STANDARD CHARACTERS WITHOUT CLAIM TO ANY PARTICULAR FONT, STYLE, SIZE, OR COLOR.
FOR WORKS OF ART OF PLASTIC AND WOOD (U.S. CLS. 2, 13, 22, 25, 32 AND 50).
DANIEL CAPSHAW, EXAMINING ATTORNEY

SN 77-167,287. WAL-MART STORES, INC., BENTONVILLE, AR. FILED 4-27-2007.

ROBINWOOD

THE MARK CONSISTS OF STANDARD CHARACTERS WITHOUT CLAIM TO ANY PARTICULAR FONT, STYLE, SIZE, OR COLOR.
FOR FURNITURE (U.S. CLS. 2, 13, 22, 25, 32 AND 50).
SCOTT SISUN, EXAMINING ATTORNEY

SN 77-177,499. STANDARD TEXTILE CO., INC., CINCINNATI, OH. FILED 5-10-2007.

BETH

THE MARK CONSISTS OF STANDARD CHARACTERS WITHOUT CLAIM TO ANY PARTICULAR FONT, STYLE, SIZE, OR COLOR.
FOR PILLOWS (U.S. CLS. 2, 13, 22, 25, 32 AND 50).
FIRST USE 0-0-1982; IN COMMERCE 0-0-1982.
DEIRDRE ROBERTSON, EXAMINING ATTORNEY

CLASS 20—(Continued).

SN 77-188,742. NORWOOD OPERATING COMPANY, LLC., DBA NORWOOD PROMOTIONAL PRODUCTS, INDIANAPOLIS, IN. FILED 5-23-2007.



THE MARK CONSISTS OF THE WORD EVOLUCENT, STYLIZED, WITH ASCENDING CIRCLES. FOR PLAQUES OF ACRYLIC; NON-METAL TROPHIES (U.S. CLS. 2, 13, 22, 25, 32 AND 50).
ANDREA K. NADELMAN, EXAMINING ATTORNEY

SN 77-194,836. SPITZER, ROBERT, NAPLES, FL. AND SPARTZ, LAUREN, NAPLES, FL. AND SPITZER, MICHELLE, NAPLES, FL. FILED 5-31-2007.

"Binky in the belly"

THE MARK CONSISTS OF STANDARD CHARACTERS WITHOUT CLAIM TO ANY PARTICULAR FONT, STYLE, SIZE, OR COLOR. FOR STUFFED ANIMALS (U.S. CLS. 2, 13, 22, 25, 32 AND 50).
BILL DAWE, EXAMINING ATTORNEY

SN 78-691,817. AMERICAN PACIFIC PLASTIC FABRICATORS, INC., GARDEN GROVE, CA. FILED 8-12-2005.

STERLING

THE MARK CONSISTS OF STANDARD CHARACTERS WITHOUT CLAIM TO ANY PARTICULAR FONT, STYLE, SIZE, OR COLOR. FOR MATTRESSES; WATERBED MATTRESSES; FOAM MATTRESSES; BOX SPRINGS; MATTRESS FOUNDATIONS; MATTRESS TOPPERS; MATTRESS CUSHIONS; WATERBEDS; PILLOWS; FOAM PILLOWS; BED FRAMES (U.S. CLS. 2, 13, 22, 25, 32 AND 50).
FIRST USE 12-31-1987; IN COMMERCE 12-31-1987.
ANNE E. GUSTASON, EXAMINING ATTORNEY

CLASS 20—(Continued).

SN 78-691,824. AMERICAN PACIFIC PLASTIC FABRICATORS, INC., GARDEN GROVE, CA. FILED 8-12-2005.

STERLING SLEEP SYSTEMS

THE MARK CONSISTS OF STANDARD CHARACTERS WITHOUT CLAIM TO ANY PARTICULAR FONT, STYLE, SIZE, OR COLOR.

NO CLAIM IS MADE TO THE EXCLUSIVE RIGHT TO USE "SLEEP SYSTEMS", APART FROM THE MARK AS SHOWN.

FOR MATTRESSES; WATERBED MATTRESSES; FOAM MATTRESSES; BOX SPRINGS; MATTRESS FOUNDATIONS; MATTRESS TOPPERS; MATTRESS CUSHIONS; WATERBEDS; PILLOWS; FOAM PILLOWS; BED FRAMES (U.S. CLS. 2, 13, 22, 25, 32 AND 50).
FIRST USE 12-31-1987; IN COMMERCE 12-31-1987.
ANNE E. GUSTASON, EXAMINING ATTORNEY

SN 78-706,172. LAFAYETTE VENETIAN BLIND, INC., WEST LAFAYETTE, IN. FILED 9-2-2005.

Accu-Rise

THE MARK CONSISTS OF STANDARD CHARACTERS WITHOUT CLAIM TO ANY PARTICULAR FONT, STYLE, SIZE, OR COLOR.

FOR WINDOW BLINDS; WINDOW SHADES; LIFT SYSTEM FOR WINDOW BLINDS AND SHADES CONSISTING OF SPOOLS, MOTOR, AND TRANSMISSION; NON-METAL INTERIOR WINDOW SHADES AND BLINDS; LIFT SYSTEM FOR INTERIOR WINDOW SHADES AND BLINDS CONSISTING OF SPOOLS, MOTOR, AND TRANSMISSION (U.S. CLS. 2, 13, 22, 25, 32 AND 50).
MARIA-VICTORIA SUAREZ, EXAMINING ATTORNEY

CLASS 20—(Continued).

SN 78-795,248. XMA, L.L.C., MIDWEST CITY, OK. FILED 1-19-2006.

XMA

THE MARK CONSISTS OF STANDARD CHARACTERS WITHOUT CLAIM TO ANY PARTICULAR FONT, STYLE, SIZE, OR COLOR.

FOR FURNITURE PARTS IN THE NATURE OF TABLE TOPS, DISPLAY TABLES, WORKTOPS, WORK SURFACES; FRAMES, NAMELY, PICTURE FRAMES NOT OF PRECIOUS METAL, PICTURE FRAMES OF PRECIOUS METAL, MIRROR FRAMES, LEATHER PICTURE FRAMES, PAPER PICTURE FRAMES; COLLECTIBLES, NAMELY, DESKTOP STATUARY AND FIGURINES MADE OF PLASTER, PLASTIC, WAX, AND WOOD, NON-METAL AND NON-LEATHER KEY CHAINS, NON-METAL DOG TAGS, PLAQUES OF PLASTER, PLASTIC, WAX AND WOOD, PLASTIC KEY RINGS, PLASTIC KEY CHAIN TAGS, PILLOWS, PLASTIC NOVELTY LICENSE PLATES, SEAT CUSHIONS, STATUES OF PLASTER, PLASTIC, WAX AND WOOD (U.S. CLS. 2, 13, 22, 25, 32 AND 50).

MARK PILARO, EXAMINING ATTORNEY

CLASS 20—(Continued).

SN 78-935,319. SLAM BRANDS, INC., REDMOND, WA. FILED 7-21-2006.

SAVANTE

THE MARK CONSISTS OF STANDARD CHARACTERS WITHOUT CLAIM TO ANY PARTICULAR FONT, STYLE, SIZE, OR COLOR.

THE ENGLISH TRANSLATION OF THE FRENCH WORD SAVANTE IN THE MARK IS "A WISE AND LEARNED PERSON".

FOR CABINETS; COMPUTER FURNITURE; ENTERTAINMENT CENTERS; LIVING ROOM FURNITURE (U.S. CLS. 2, 13, 22, 25, 32 AND 50).

ALEX KEAM, EXAMINING ATTORNEY

SN 78-835,279. JOHN BOONE, INC., NEW YORK, NY. FILED 3-13-2006.

Paul M. Jones Collection

THE MARK CONSISTS OF STANDARD CHARACTERS WITHOUT CLAIM TO ANY PARTICULAR FONT, STYLE, SIZE, OR COLOR.

NO CLAIM IS MADE TO THE EXCLUSIVE RIGHT TO USE "COLLECTION", APART FROM THE MARK AS SHOWN.

PAUL M. JONES DOES NOT IDENTIFY A LIVING INDIVIDUAL.

FOR FURNITURE (U.S. CLS. 2, 13, 22, 25, 32 AND 50). FIRST USE 1-1-1958; IN COMMERCE 1-1-1958.

JASON BLAIR, EXAMINING ATTORNEY

SN 78-958,524. BORROUGHS CORPORATION, KALAMAZOO, MI. FILED 8-23-2006.

SYNERGY SERIES

THE MARK CONSISTS OF STANDARD CHARACTERS WITHOUT CLAIM TO ANY PARTICULAR FONT, STYLE, SIZE, OR COLOR.

NO CLAIM IS MADE TO THE EXCLUSIVE RIGHT TO USE "SERIES", APART FROM THE MARK AS SHOWN.

FOR MOVABLE STORAGE SYSTEMS COMPRISED PRIMARILY OF SHELVING FOR USE IN COMMERCIAL SETTINGS AND INSTITUTIONAL SETTINGS (U.S. CLS. 2, 13, 22, 25, 32 AND 50).

JOHN DALIER, EXAMINING ATTORNEY

CLASS 20—(Continued).

SN 79-038,804. HÜLSTA-WERKE HÜLS GMBH & CO. KG, FED REP GERMANY, FILED 3-5-2007.



PRIORITY DATE OF 9-6-2006 IS CLAIMED.
OWNER OF INTERNATIONAL REGISTRATION 0925021
DATED 3-5-2007, EXPIRES 3-5-2017.

"THE MARK CONSISTS OF THE WORD "NOW" WITH AN EXCLAMATION MARK AND "BY HÜLSTA" ALL ON A SOLID, FILLED-IN SQUARE."

FOR FURNITURE, MIRRORS, PICTURE FRAMES; MATTRESSES; BED SLATS, NOT OF METAL (U.S. CLS. 2, 13, 22, 25, 32 AND 50).

DAVID C. REIHNER, EXAMINING ATTORNEY

CLASS 21—HOUSEWARES AND GLASS

SN 76-670,326. POPE-GRUBB, DORA, URBANA, IL. FILED 12-14-2006.

FOR CUP WITH LOVE AND BIBLE SCRIPTURE TEXT MESSAGES PRINTED FROM TOP TO BOTTOM ON THE INSIDE WALLS AND BOTTOM (U.S. CLS. 2, 13, 23, 29, 30, 33, 40 AND 50).

DAVID H. STINE, EXAMINING ATTORNEY

CLASS 21—(Continued).

SN 77-035,878. WHEELER, WESLEY D., NAPA, CA. FILED 11-3-2006.



THE MARK CONSISTS OF THE SILHOUETTE OF A LONGHORN STEER WITH ITS HEAD THROUGH A CIRCLE AND THE WORDS AMERICAN ABOVE AND HERITAGE BELOW.

FOR GARDENING GLOVES; HOUSEHOLD GLOVES FOR GENERAL USE (U.S. CLS. 2, 13, 23, 29, 30, 33, 40 AND 50).

BRENDAN MCCAULEY, EXAMINING ATTORNEY

SN 77-087,503. NEW VENTURE GROUP, LLC, COLUMBIA, MD. FILED 1-21-2007.

Coffee Coins

THE MARK CONSISTS OF STANDARD CHARACTERS WITHOUT CLAIM TO ANY PARTICULAR FONT, STYLE, SIZE, OR COLOR.

NO CLAIM IS MADE TO THE EXCLUSIVE RIGHT TO USE "COINS", APART FROM THE MARK AS SHOWN.

SEC. 2(F).

FOR CERAMIC DISCS FOR USE AS PURCHASE TOKENS (U.S. CLS. 2, 13, 23, 29, 30, 33, 40 AND 50).

FIRST USE 2-17-2001; IN COMMERCE 4-13-2001.

SARA THOMAS, EXAMINING ATTORNEY

SN 77-116,493. TRU VUE, INC., MCCOOK, IL. FILED 2-26-2007.

PRESERVATION CLEAR

THE MARK CONSISTS OF STANDARD CHARACTERS WITHOUT CLAIM TO ANY PARTICULAR FONT, STYLE, SIZE, OR COLOR.

NO CLAIM IS MADE TO THE EXCLUSIVE RIGHT TO USE "CLEAR", APART FROM THE MARK AS SHOWN.

FOR GLASS SHEETS FOR PICTURE FRAMES AND DISPLAY CASES (U.S. CLS. 2, 13, 23, 29, 30, 33, 40 AND 50).

LINDA ORNDORFF, EXAMINING ATTORNEY

CLASS 21—(Continued).

SN 77-125,314. HOLLY M. MUNGAL, FORT LAUDERDALE, FL. FILED 3-8-2007.



NO CLAIM IS MADE TO THE EXCLUSIVE RIGHT TO USE "WINE", APART FROM THE MARK AS SHOWN.

"THE MARK CONSISTS OF A DESIGN FEATURING A STYLIZED TREE CONSISTING OF SEVEN LEAVES ARCHED ABOVE A STYLIZED TREE TRUNK. TWO WINE GLASSES ARE DISPLAYED ON BOTH SIDES OF THE DESIGN. TWO HORIZONTAL LINES APPEAR UNDER THE TREE AND WINE GLASSES WITH THE WORDING "WINE HOST" DISPLAYED IN THE MIDDLE OF THE TWO LINES. UNDER THE SECOND HORIZONTAL LINE THE WORDING "IT NEVER GETS TIPSY" IS DISPLAYED."

FOR BEVERAGE GLASS AND BOTTLE HOLDER (U.S. CLS. 2, 13, 23, 29, 30, 33, 40 AND 50).
RENEE SERVANCE, EXAMINING ATTORNEY

SN 77-151,663. DIVINE INNOVATIONS, LLC, KNOXVILLE, TN. FILED 4-9-2007.

LipStix Remix

THE MARK CONSISTS OF STANDARD CHARACTERS WITHOUT CLAIM TO ANY PARTICULAR FONT, STYLE, SIZE, OR COLOR.

NO CLAIM IS MADE TO THE EXCLUSIVE RIGHT TO USE LIPSTICK, APART FROM THE MARK AS SHOWN.

FOR A COSMETIC MATERIAL RECYCLE KIT CONTAINING MOLDS, CONTAINERS, MEASURING CUPS AND SPATULAS USED IN RECOVERING REMAINING UNUSED PORTIONS OF COSMETIC MATERIALS SUCH AS LIPSTICK AND LIP GLOSS FROM THEIR ORIGINAL CONTAINERS, MELTING THE RECOVERED PORTIONS AND MOLDING THE RECOVERED PORTIONS TO FORM RECONSTITUTED COSMETIC MATERIALS (U.S. CLS. 2, 13, 23, 29, 30, 33, 40 AND 50).

DAVID H. STINE, EXAMINING ATTORNEY

CLASS 21—(Continued).

SN 77-153,631. BANOM, INC., WAYNE, PA. FILED 4-11-2007.

THORNBLOCKER

THE MARK CONSISTS OF STANDARD CHARACTERS WITHOUT CLAIM TO ANY PARTICULAR FONT, STYLE, SIZE, OR COLOR.

FOR PUNCTURE RESISTANT GARDEN GLOVES (U.S. CLS. 2, 13, 23, 29, 30, 33, 40 AND 50).
REGINA DRUMMOND, EXAMINING ATTORNEY

SN 77-154,571. CAN-COCTIONS, GARNETT, KS. FILED 4-11-2007.



NO CLAIM IS MADE TO THE EXCLUSIVE RIGHT TO USE "CAN", APART FROM THE MARK AS SHOWN.

THE STIPPLING IS FOR SHADING PURPOSES ONLY.
THE MARK CONSISTS OF AN OVAL SHAPED DESIGN WITH A ARM AND HAND EXTENDING ACROSS THE BOTTOM. THE WORD CAN-PANION CONTAINING A PADDLE BETWEEN CAN AND PANION. KIDNEY SHAPED DESIGN ABOVE THE HAND.

FOR PLASTIC ATTACHABLE BEVERAGE HOLDER FOR CANOES, KAYAKS, LAWN CHAIRS AND JOHN BOATS (U.S. CLS. 2, 13, 23, 29, 30, 33, 40 AND 50).

FIRST USE 3-3-2007; IN COMMERCE 3-3-2007.
KIM SAITO, EXAMINING ATTORNEY

SN 77-154,829. THE HOMER LAUGHLIN CHINA COMPANY, NEWELL, WV. FILED 4-12-2007.

KENILWORTH

THE MARK CONSISTS OF STANDARD CHARACTERS WITHOUT CLAIM TO ANY PARTICULAR FONT, STYLE, SIZE, OR COLOR.

FOR DINNERWARE (U.S. CLS. 2, 13, 23, 29, 30, 33, 40 AND 50).

MICHAEL LEWIS, EXAMINING ATTORNEY

CLASS 21—(Continued).

SN 77-156,195. MARGARET MAUNDER, HAMDEN, CT. FILED 4-13-2007.

WASKET

THE MARK CONSISTS OF STANDARD CHARACTERS WITHOUT CLAIM TO ANY PARTICULAR FONT, STYLE, SIZE, OR COLOR.

FOR WASTE BASKETS (U.S. CLS. 2, 13, 23, 29, 30, 33, 40 AND 50).

KATHERINE E. HALMEN, EXAMINING ATTORNEY

CLASS 21—(Continued).

SN 77-157,296. GROBAL, L.L.C., CHANDLER, AZ. FILED 4-16-2007.

CULTIVATE STYLE

THE MARK CONSISTS OF STANDARD CHARACTERS WITHOUT CLAIM TO ANY PARTICULAR FONT, STYLE, SIZE, OR COLOR.

FOR PLANT CONTAINERS, NAMELY, SELF-WATERING PLANTERS AND POTS FOR PLANTS (U.S. CLS. 2, 13, 23, 29, 30, 33, 40 AND 50).

FIRST USE 3-1-2007; IN COMMERCE 3-1-2007.

JASON BLAIR, EXAMINING ATTORNEY

SN 77-157,303. GROBAL, L.L.C., CHANDLER, AZ. FILED 4-16-2007.

SN 77-156,890. OLIVIA HAVILAND D'ALBIS, SHERMAN OAKS, CA. FILED 4-14-2007.

GROBIE

THE MARK CONSISTS OF STANDARD CHARACTERS WITHOUT CLAIM TO ANY PARTICULAR FONT, STYLE, SIZE, OR COLOR.

FOR PLANT CONTAINERS, NAMELY, SELF-WATERING PLANTERS AND POTS FOR PLANTS (U.S. CLS. 2, 13, 23, 29, 30, 33, 40 AND 50).

JASON BLAIR, EXAMINING ATTORNEY

SN 77-158,388. ON TAP LLC, CLEVELAND HEIGHTS, OH. FILED 4-17-2007.



NO CLAIM IS MADE TO THE EXCLUSIVE RIGHT TO USE "LOS ANGELES", APART FROM THE MARK AS SHOWN.

THE COLOR(S) PINK, DARK BLUE AND LIGHT BLUE IS/ARE CLAIMED AS A FEATURE OF THE MARK.

THE COLOR DARK BLUE APPEARS IN THE CENTER RECTANGLE. THE COLOR PINK APPEARS IN THE BORDER OF THE RECTANGLE. THE COLOR LIGHT BLUE APPEARS IN THE WORDING.

FOR DINNERWARE, NAMELY, PLATES, CUPS, SAUCERS; DINNERWARE; CARDBOARD CUPS; COFFEE CUPS; DRINKING CUPS; DRINKING GLASSES; PAPER PLATES; PLATES; COMMEMORATIVE PLATES; DECORATIVE PLATES; DISPOSABLE TABLE PLATES; PLASTIC PLATES; PLASTIC BATHTUBS FOR CHILDREN; POTTIES FOR CHILDREN; BIODEGRADABLE PAPER PULP-BASED PLATES, BOWLS AND CUPS (U.S. CLS. 2, 13, 23, 29, 30, 33, 40 AND 50).

ESTHER A. BORSUK, EXAMINING ATTORNEY

PARTY LAUNCHER

THE MARK CONSISTS OF STANDARD CHARACTERS WITHOUT CLAIM TO ANY PARTICULAR FONT, STYLE, SIZE, OR COLOR.

FOR PORTABLE BEVERAGE DISPENSERS (U.S. CLS. 2, 13, 23, 29, 30, 33, 40 AND 50).

LYDIA BELZER, EXAMINING ATTORNEY

CLASS 21—(Continued).

SN 77-158,604. MOUNT VERNON LADIES' ASSOCIATION OF THE UNION, MOUNT VERNON, VA. FILED 4-17-2007.

MOUNT VERNON

THE MARK CONSISTS OF STANDARD CHARACTERS WITHOUT CLAIM TO ANY PARTICULAR FONT, STYLE, SIZE, OR COLOR.

OWNER OF U.S. REG. NOS. 1,782,999, 2,490,179 AND OTHERS.

FOR ARTIFICIAL EGGS; BASINS; BATH ACCESSORIES, NAMELY, CUP HOLDERS; BEER JUGS; BEER MUGS; BEVERAGE GLASSWARE; BEVERAGeware; BOWLS; BUSTS MADE OF CRYSTAL, CHINA, TERRA COTTA, EARTHENWARE, GLASS, PORCELAIN; CAKE SERVERS; CAKE STANDS; CANDLE HOLDERS; CANDLESTICKS; CANDLESTICKS OF PRECIOUS METAL; CERAMIC SCULPTURES; CERAMIC VASES; CERAMIC VESSELS; CERAMIC BOWLS; CERAMIC PLATES; CERAMIC POTS; CHINA ORNAMENTS; COASTERS NOT OF PAPER AND NOT BEING TABLE LINEN; CUTTING BOARDS; DECANTERS; DECORATIVE PLATES; DESKTOP STATUARY MADE OF CHINA, CRYSTAL, EARTHENWARE, GLASS, PORCELAIN; DINERWARE; DISHES; DISHES AND PLATES, NOT OF PRECIOUS METAL; DRINKING CUPS, NOT OF PRECIOUS METAL; DRINKING CUPS; DRINKING GLASSES; DRINKING STEINS; DRINKING VESSELS; GLASS BEVERAGeware; GLASS BOWLS; MUGS; ORNAMENTS MADE OF CHINA, CRYSTAL, GLASS, PORCELAIN, NOT INCLUDING CHRISTMAS TREE ORNAMENTS; PORCELAIN MUGS; RINSING BOWLS; SALT AND PEPPER SHAKERS; SCULPTURES MADE OF CHINA, CRYSTAL, EARTHENWARE, TERRA COTTA, GLASS, PORCELAIN; SERVING DISHES; SHOT GLASSES; SOAP DISHES; SOAP DISPENSERS; SOUVENIR PLATES; STATUES AND STATUETTES MADE OF CHINA, CRYSTAL, EARTHENWARE, GLASS, PORCELAIN; STEMWARE; SUN CATCHERS; TEA SETS; TOOTHBRUSH HOLDERS; WATERING CANS (U.S. CLS. 2, 13, 23, 29, 30, 33, 40 AND 50).

REBECCA GILBERT, EXAMINING ATTORNEY

SN 77-161,683. VAN CLINE, MARY, SEATTLE, WA. FILED 4-20-2007.

MARY VAN CLINE

THE MARK CONSISTS OF STANDARD CHARACTERS WITHOUT CLAIM TO ANY PARTICULAR FONT, STYLE, SIZE, OR COLOR.

THE NAME(S), PORTRAIT(S), AND/OR SIGNATURE(S) SHOWN IN THE MARK IDENTIFIES MARY VAN CLINE, WHOSE CONSENT(S) TO REGISTER IS MADE OF RECORD.

FOR WORKS OF ART CONSISTING PRIMARILY OF GLASS, WITH AND WITHOUT PHOTOGRAPHIC IMAGES (U.S. CLS. 2, 13, 23, 29, 30, 33, 40 AND 50).

FIRST USE 0-0-1979; IN COMMERCE 0-0-1979.

ELI HELLMAN, EXAMINING ATTORNEY

CLASS 21—(Continued).

SN 77-162,498. ITOUCHLESS HOUSEWARES & PRODUCTS, INC., FOSTER CITY, CA. FILED 4-21-2007.

TOWEL-MATIC

THE MARK CONSISTS OF STANDARD CHARACTERS WITHOUT CLAIM TO ANY PARTICULAR FONT, STYLE, SIZE, OR COLOR.

FOR DISPENSERS FOR PAPER TOWELS, TOWEL HOLDERS (U.S. CLS. 2, 13, 23, 29, 30, 33, 40 AND 50).

FIRST USE 12-1-2006; IN COMMERCE 12-1-2006.

NORA BUCHANAN WILL, EXAMINING ATTORNEY

SN 77-164,183. LEGACY CONVERTING, CARLSTADT, NJ. FILED 4-24-2007.

TITAN

THE MARK CONSISTS OF STANDARD CHARACTERS WITHOUT CLAIM TO ANY PARTICULAR FONT, STYLE, SIZE, OR COLOR.

FOR CLEANING CLOTHS (U.S. CLS. 2, 13, 23, 29, 30, 33, 40 AND 50).

FIRST USE 10-31-2002; IN COMMERCE 10-31-2002.

LAURIE MAYES, EXAMINING ATTORNEY

SN 77-180,372. SENTRON INTERNATIONAL, INC., LA VERNE, CA. FILED 5-14-2007.

AUTO EYE

THE MARK CONSISTS OF STANDARD CHARACTERS WITHOUT CLAIM TO ANY PARTICULAR FONT, STYLE, SIZE, OR COLOR.

NO CLAIM IS MADE TO THE EXCLUSIVE RIGHT TO USE "AUTO", APART FROM THE MARK AS SHOWN.

FOR GARBAGE CANS (U.S. CLS. 2, 13, 23, 29, 30, 33, 40 AND 50).

EDWARD NELSON, EXAMINING ATTORNEY

CLASS 21—(Continued).

SN 77-186,646. DOWIN ENTERPRISES(USA) INC, CHICAGO, IL. FILED 5-22-2007.



THE COLOR(S) GREEN, WHITE AND BLACK IS/ARE CLAIMED AS A FEATURE OF THE MARK.

THE MARK CONSISTS OF A CUSTOMIZED LETTER "DO". THE FONT COLOR OF THE "DO" LOGO IS GREEN AND WHITE. THE FONT COLOR OF THE "DOWIN" IS BLACK.

FOR BROOMS; MOPS; CLOTHES BRUSHES; DISH-WASHING BRUSHES; DUSTING BRUSHES; FLOOR BRUSHES; SCRAPING BRUSHES; SCRUBBING BRUSHES; SHOE BRUSHES; TOILET BRUSH HOLDERS; TOILET BRUSHES; WASHING BRUSHES; PLUNGERS FOR CLEARING BLOCKED DRAINS; DISPOSABLE GLOVES FOR HOME USE; DISPOSABLE LATEX AND NITRILE GLOVES FOR GENERAL USE; DISPOSABLE LATEX GLOVES FOR GENERAL USE; DISPOSABLE PLASTIC GLOVES FOR GENERAL USE; DUST GLOVES; DUSTING GLOVES; HOUSEHOLD GLOVES FOR GENERAL USE; HOUSEHOLD PLASTIC GLOVES; PLASTIC HOUSEHOLD GLOVES; RUBBER HOUSEHOLD GLOVES; DUSTERS; FEATHER DUSTERS; PAILS; BOWLS; BASKETS FOR WASTE PAPER LITTERING; PLASTIC HAND-HELD SHOPPING BASKETS; WASTE BASKETS; PORTABLE PLASTIC CONTAINERS FOR STORING HOUSEHOLD AND KITCHEN GOODS; CLOTHES DRYING HANGERS (U.S. CLS. 2, 13, 23, 29, 30, 33, 40 AND 50).

C. DIONNE CLYBURN, EXAMINING ATTORNEY

SN 77-187,284. MIZUNO USA, INC., NORCROSS, GA. FILED 5-22-2007.

MIZUNO ENDURABLADDER

THE MARK CONSISTS OF STANDARD CHARACTERS WITHOUT CLAIM TO ANY PARTICULAR FONT, STYLE, SIZE, OR COLOR.

FOR PERSONAL FLUID HYDRATION SYSTEM COMPRISING A FLUID RESERVOIR, A DELIVERY TUBE, A MOUTHPIECE, AND A CARRYING PACK (U.S. CLS. 2, 13, 23, 29, 30, 33, 40 AND 50).

JIM RINGLE, EXAMINING ATTORNEY

CLASS 21—(Continued).

SN 77-201,691. HELEN OF TROY LIMITED, ST. MICHAEL, BARBADOS, FILED 6-8-2007.

Fresco by Comare

THE MARK CONSISTS OF STANDARD CHARACTERS WITHOUT CLAIM TO ANY PARTICULAR FONT, STYLE, SIZE, OR COLOR.

OWNER OF U.S. REG. NO. 1,185,842.
FOR HAIR BRUSHES (U.S. CLS. 2, 13, 23, 29, 30, 33, 40 AND 50).

FIRST USE 6-1-2006; IN COMMERCE 6-1-2006.
LAURA HAMMEL, EXAMINING ATTORNEY

SN 77-201,746. HELEN OF TROY LIMITED, ST. MICHAEL, BARBADOS, FILED 6-8-2007.

Accusilver

THE MARK CONSISTS OF STANDARD CHARACTERS WITHOUT CLAIM TO ANY PARTICULAR FONT, STYLE, SIZE, OR COLOR.

FOR HAIR BRUSHES (U.S. CLS. 2, 13, 23, 29, 30, 33, 40 AND 50).

LAURA HAMMEL, EXAMINING ATTORNEY

SN 77-219,315. ROSENTHAL, MICHAEL BAIN, BALTIMORE, MD. FILED 6-29-2007.

Triangapot

THE MARK CONSISTS OF STANDARD CHARACTERS WITHOUT CLAIM TO ANY PARTICULAR FONT, STYLE, SIZE, OR COLOR.

FOR FLOWER POTS (U.S. CLS. 2, 13, 23, 29, 30, 33, 40 AND 50).

DAVID MURRAY, EXAMINING ATTORNEY

CLASS 21—(Continued).

SN 77-233,712. BEAUTY HOLDING LLC, DENTON, TX. FILED 7-19-2007.

PLUGGED IN

THE MARK CONSISTS OF STANDARD CHARACTERS WITHOUT CLAIM TO ANY PARTICULAR FONT, STYLE, SIZE, OR COLOR.
FOR HAIR BRUSHES (U.S. CLS. 2, 13, 23, 29, 30, 33, 40 AND 50).
FIRST USE 7-27-2007; IN COMMERCE 7-27-2007.
ANDREA HACK, EXAMINING ATTORNEY

SN 77-237,367. THE HOMER LAUGHLIN CHINA COMPANY, NEWELL, WV. FILED 7-24-2007.

FLIPSIDE

THE MARK CONSISTS OF STANDARD CHARACTERS WITHOUT CLAIM TO ANY PARTICULAR FONT, STYLE, SIZE, OR COLOR.
FOR DINNERWARE (U.S. CLS. 2, 13, 23, 29, 30, 33, 40 AND 50).
MICHAEL LEWIS, EXAMINING ATTORNEY

SN 78-711,642. WATKINS GLEN INTERNATIONAL, INC., DAYTONA BEACH, FL. FILED 9-13-2005.



OWNER OF U.S. REG. NOS. 1,366,768, 1,862,034 AND OTHERS.
FOR HOUSEWARES AND GLASS PRODUCTS; NAMELY MUGS, SHOT GLASSES, DRINKING GLASSES, SALT AND PEPPER SHAKERS, DECANTERS, PORTABLE COOLERS, INSULATING SLEEVE HOLDERS FOR BEVERAGE CANS, AND PLASTIC SPORT BOTTLES SOLD EMPTY (U.S. CLS. 2, 13, 23, 29, 30, 33, 40 AND 50).
MARY BOAGNI, EXAMINING ATTORNEY

CLASS 21—(Continued).

SN 78-787,364. DURATECH PLASTICS CORPORATION, CARLSTADT, NJ. FILED 1-9-2006.



"THE MARK CONSISTS OF THE LETTERS CYMA ENCLOSED IN A PEANUT SHAPE FIGURE."
FOR PLASTIC INSULATED BAGS FOR FOOD, BEVERAGES, AND TO HOLD ACCESSORIES, NAMELY, KEYS, CREDIT CARDS AND CELL PHONES (U.S. CLS. 2, 13, 23, 29, 30, 33, 40 AND 50).
FIRST USE 10-15-2005; IN COMMERCE 10-15-2005.
DARRYL SPRUILL, EXAMINING ATTORNEY

SN 78-829,416. LOFTON, CORTNEY, D. SHERMAN OAKS, CA. AND ESSER, THORIN, CYNTHIA, L. SHERMAN OAKS, CA. FILED 3-5-2006.



THE MARK CONSISTS OF A CONFIGURATION OF BEAR IN CRAWLING POSTURE.
FOR FIBERGLASS RESIN FIGURINES AND FIBERGLASS RESIN STATUES (U.S. CLS. 2, 13, 23, 29, 30, 33, 40 AND 50).
BERYL GARDNER, EXAMINING ATTORNEY

CLASS 21—(Continued).

SN 78-936,726. SADRIWALLA, ABBAS A., FT LAUDERDALE, FL. FILED 7-25-2006.

FIDO-FEEDER

THE MARK CONSISTS OF STANDARD CHARACTERS WITHOUT CLAIM TO ANY PARTICULAR FONT, STYLE, SIZE, OR COLOR.

FOR PET FEEDING BOWL WITH ADJUSTABLE BOWL HEIGHT (U.S. CLS. 2, 13, 23, 29, 30, 33, 40 AND 50).

SCOTT BALDWIN, EXAMINING ATTORNEY

SN 78-960,084. BURKE, CHRISTINE C., NEW YORK, NY. FILED 8-24-2006.

ONLY IN NEW ORLEANS

THE MARK CONSISTS OF STANDARD CHARACTERS WITHOUT CLAIM TO ANY PARTICULAR FONT, STYLE, SIZE, OR COLOR.

NO CLAIM IS MADE TO THE EXCLUSIVE RIGHT TO USE "NEW ORLEANS", APART FROM THE MARK AS SHOWN.

FOR BEVERAGE GLASSWARE; BEER MUGS; BEVERAGE STIRRERS; GLASS BOWLS; PLASTIC COASTERS; COCKTAIL SHAKERS; DRINKING CUPS NOT MADE OF PRECIOUS METAL; EARTHENWARE MUGS; GLASS MUGS; PLASTIC CUPS; SHOT GLASSES; STEAMWARE; DECORATIVE PLATES; SPOON RESTS; SALT AND PEPPER SHAKERS; NON-METAL PIGGY BANKS; BOTTLE OPENERS (U.S. CLS. 2, 13, 23, 29, 30, 33, 40 AND 50).

RONALD AIKENS, EXAMINING ATTORNEY

SN 78-966,020. LF, LLC, WILMINGTON, DE. FILED 9-1-2006.



OWNER OF U.S. REG. NOS. 3,091,250 AND 3,172,353. NO CLAIM IS MADE TO THE EXCLUSIVE RIGHT TO USE "SUPERIOR GRILLING", APART FROM THE MARK AS SHOWN.

THE MARK CONSISTS OF THE STYLIZED WORDS PERFECT FLAME PLACED TO THE RIGHT OF A STYLIZED FLAME WITH THE STYLIZED WORDS BUILT FOR SUPERIOR GRILLING BELOW, ALL INSIDE A BLACK ELONGATED RECTANGLE WITH ROUNDED EDGES, ALL ENCLOSED IN A LARGER ELONGATED RECTANGLE WITH ROUNDED EDGES.

FOR GRILL ACCESSORIES, NAMELY, GRILL BRUSHES, SCRUB BRUSHES, SCRAPING BRUSHES, PORCELAIN GRID BRUSHES, COOKING SKEWERS, TONGS, LONG-HANDLED FORKS AND SPATULAS (U.S. CLS. 2, 13, 23, 29, 30, 33, 40 AND 50).

WARREN L. OLANDRIA, EXAMINING ATTORNEY

CLASS 22—CORDAGE AND FIBERS

SN 77-056,339. LEWIS HYMAN, INC., CARSON, CA. FILED 12-4-2006.

SHADES FOR STYLE

THE MARK CONSISTS OF STANDARD CHARACTERS WITHOUT CLAIM TO ANY PARTICULAR FONT, STYLE, SIZE, OR COLOR.

OWNER OF U.S. REG. NO. 2,839,097. NO CLAIM IS MADE TO THE EXCLUSIVE RIGHT TO USE "SHADES", APART FROM THE MARK AS SHOWN.

FOR NON-METAL CANOPIES, NOT FOR USE WITH STROLLERS, BEDS AND CRIBS; AND AWNINGS OF FABRIC (U.S. CLS. 1, 2, 7, 19, 22, 42 AND 50).

ALEXANDER L. POWERS, EXAMINING ATTORNEY

SN 77-138,550. DANIEL SICURELLA, KEMAH, TX. FILED 3-23-2007.

NETWORX

THE MARK CONSISTS OF STANDARD CHARACTERS WITHOUT CLAIM TO ANY PARTICULAR FONT, STYLE, SIZE, OR COLOR.

FOR STRUCTURAL ANCHORING SYSTEMS, NAMELY, NETTING CONNECTED TO ANCHORS WITH CORDS OR STRAPS (U.S. CLS. 1, 2, 7, 19, 22, 42 AND 50).

LEIGH CAROLINE CASE, EXAMINING ATTORNEY

SN 77-158,010. SHINING SEA TRADING COMPANY, WEST VALLEY, UT. FILED 4-16-2007.



NO CLAIM IS MADE TO THE EXCLUSIVE RIGHT TO USE "BAGS", APART FROM THE MARK AS SHOWN.

THE MARK CONSISTS OF A PICTURE OF SANTA CARRYING A BAG.

FOR BAGS, NAMELY FABRIC BAGS FOR STORING ARTIFICIAL CHRISTMAS TREES (U.S. CLS. 1, 2, 7, 19, 22, 42 AND 50).

HEATHER THOMPSON, EXAMINING ATTORNEY

CLASS 22—(Continued).

SN 78-962,701. ALPHASOURCE INC., PHILADELPHIA, PA.
FILED 8-29-2006.

TOOLS AVER

THE MARK CONSISTS OF STANDARD CHARACTERS WITHOUT CLAIM TO ANY PARTICULAR FONT, STYLE, SIZE, OR COLOR.

FOR DEVICE IN THE NATURE OF A LANYARD USED TO RETAIN HAND TOOLS, IMPLEMENTS AND INSTRUMENTS WORN BY A USER ON THE ARM, LEG OR NECK OR AS AN ATTACHMENT TO A TOOL BELT, TOOL BAG, TOOL POUCH OR SCUBA GEAR (U.S. CLS. 1, 2, 7, 19, 22, 42 AND 50).

KEVIN DINALLO, EXAMINING ATTORNEY

CLASS 23—YARNS AND THREADS

SN 77-152,505. BERROCO, INC., UXBRIDGE, MA. FILED 4-10-2007.

BERROCO COMFORT

THE MARK CONSISTS OF STANDARD CHARACTERS WITHOUT CLAIM TO ANY PARTICULAR FONT, STYLE, SIZE, OR COLOR.

OWNER OF U.S. REG. NOS. 1,597,403, 3,060,436 AND OTHERS.

FOR YARNS FOR KNITTING (U.S. CL. 43).

KATHERINE CONNOLLY, EXAMINING ATTORNEY

SN 78-939,018. ESQUEL ENTERPRISES LIMITED, WAN-CHAI, HONG KONG, FILED 7-27-2006.

Cashcotton

PRIORITY CLAIMED UNDER SEC. 44(D) ON HONG KONG APPLICATION NO. 300682902, FILED 7-19-2006, REG. NO. 300682902, DATED 7-19-2006, EXPIRES 7-19-2016.

FOR YARNS AND THREADS, FOR TEXTILE USE, MADE IN WHOLE OR IN SIGNIFICANT PART OF COTTON (U.S. CL. 43).

SAMUEL E. SHARPER JR., EXAMINING ATTORNEY

CLASS 24—FABRICS

SN 77-148,844. SOBEL WESTEX, INC., LAS VEGAS, NV.
FILED 4-4-2007.



NO CLAIM IS MADE TO THE EXCLUSIVE RIGHT TO USE "DRY", APART FROM THE MARK AS SHOWN.

THE MARK CONSISTS OF THE WORDS SOBEL DRY WITH THE "O" IN SOBEL SHAPED LIKE A TEAR-DROP. THE WORD SOBEL IS SITUATED ON TOP OF THE WORD DRY, SEPARATED BY A CURVED LINE.

FOR BED PADS, BED LINEN, MATTRESS PADS (U.S. CLS. 42 AND 50).

ELLEN B. AWRICH, EXAMINING ATTORNEY

SN 77-155,140. BASS PRO TRADEMARKS, L.L.C., SPRINGFIELD, MO. FILED 4-12-2007.



OWNER OF U.S. REG. NOS. 2,120,188 AND 3,015,509.

THE MARK CONSISTS OF AN ILLUSTRATION OF A BUCK OVER THE WORDS KING OF BUCKS.

FOR BEDDING, NAMELY, COMFORTER SETS COMPRISING BED SHEETS, BED SKIRTS, COMFORTERS AND PILLOW SHAMS; BED BLANKETS; BLANKET THROWS; CLOTH WINDOW TREATMENTS, NAMELY, DRAPES, CURTAINS AND VALANCES; SHOWER CURTAINS (U.S. CLS. 42 AND 50).

FIRST USE 9-30-2005; IN COMMERCE 9-30-2005.

ROBERT C. CLARK JR., EXAMINING ATTORNEY

CLASS 24—(Continued).

SN 77-155,788. JIANGSU KUANGDA AUTOMOBILE TEXTILE GROUP CO., LTD., CHANGZHO CITY., CHINA, FILED 4-13-2007.



THE MARK CONSISTS OF AN OVAL WITH TWO CURVED LINES IN THE UPPER HALF AND ONE CURVED LINE IN THE LOWER HALF ABOVE THE WORD "KUANGDA" IN STYLIZED LETTERS.

THE FOREIGN WORDING IN THE MARK TRANSLATES INTO ENGLISH AS BROAD MINDED.

FOR FABRICS FOR THE MANUFACTURE OF SEATING, DOOR PANELS, ARM RESTS, HEADLINERS, SUNVISORS AND THE COMPONENTS FOR AUTOMOBILES AND OTHER MOTOR VEHICLES (U.S. CLS. 42 AND 50).

KIMBERLY PERRY, EXAMINING ATTORNEY

SN 77-158,250. SIGMATEX, INC., NEW YORK, NY. FILED 4-17-2007.

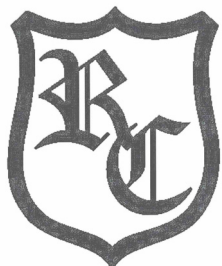

ROYAL CREST
Crown Reserve

OWNER OF U.S. REG. NOS. 2,669,546, 2,906,961 AND OTHERS.

FOR LARGE BATH TOWELS; TERRY TOWELS; TOWEL SETS; TOWELS; BATH LINEN; BATH SHEETS; BATH TOWELS; BEACH TOWELS; FACE TOWELS; HAND TOWELS; HAND TOWELS OF TEXTILE; HAND-TOWELS MADE OF TEXTILE FABRICS; WASHCLOTHS (U.S. CLS. 42 AND 50).

MATTHEW MCDOWELL, EXAMINING ATTORNEY

CLASS 24—(Continued).

SN 77-158,533. SIGMATEX, INC., NEW YORK, NY. FILED 4-17-2007.



ROYAL CREST
Townhouse Reserve

OWNER OF U.S. REG. NOS. 2,669,546, 2,906,961 AND OTHERS.

FOR LARGE BATH TOWELS; TERRY TOWELS; TOWEL SETS; BATH LINEN; BATH SHEETS; BATH TOWELS; FACE TOWELS; HAND TOWELS; HAND TOWELS OF TEXTILE; HAND-TOWELS MADE OF TEXTILE FABRICS; WASHCLOTHS (U.S. CLS. 42 AND 50).

MATTHEW MCDOWELL, EXAMINING ATTORNEY

SN 77-159,597. PRACTICAL WHIMSY, INC., MARINA DEL REY, CA. FILED 4-18-2007.

PRACTICAL WHIMSY

THE MARK CONSISTS OF STANDARD CHARACTERS WITHOUT CLAIM TO ANY PARTICULAR FONT, STYLE, SIZE, OR COLOR.

FOR BABY BLANKETS, TEXTILE TABLECLOTHS, PILLOWCASES (U.S. CLS. 42 AND 50).

FIRST USE 10-31-2004; IN COMMERCE 10-31-2004.

RICHARD WHITE, EXAMINING ATTORNEY

SN 77-159,625. SOUTH CONE, INC., CARLSBAD, CA. FILED 4-18-2007.

REEF

THE MARK CONSISTS OF STANDARD CHARACTERS WITHOUT CLAIM TO ANY PARTICULAR FONT, STYLE, SIZE, OR COLOR.

OWNER OF U.S. REG. NOS. 2,244,373, 2,418,438 AND OTHERS.

FOR BEACH TOWELS (U.S. CLS. 42 AND 50).

MAUREEN DALL, EXAMINING ATTORNEY

CLASS 24—(Continued).

SN 77-159,770. SIGMATEX, INC., NEW YORK, NY. FILED 4-18-2007.



NO CLAIM IS MADE TO THE EXCLUSIVE RIGHT TO USE "PREMIUM SELECT", APART FROM THE MARK AS SHOWN.

FOR BATH TOWELS; BEACH TOWELS; FACE TOWELS; GOLF TOWELS; HAND TOWELS; HAND TOWELS OF TEXTILE; TEA TOWELS; TERRY TOWELS; TOWEL SETS; TOWELS; WASHCLOTHS (U.S. CLS. 42 AND 50).

MATTHEW MCDOWELL, EXAMINING ATTORNEY

SN 77-167,454. MOISTURE MAGIC, INC., LAFAYETTE, IN. FILED 4-27-2007.

Moisture Magic

THE MARK CONSISTS OF STANDARD CHARACTERS WITHOUT CLAIM TO ANY PARTICULAR FONT, STYLE, SIZE, OR COLOR.

NO CLAIM IS MADE TO THE EXCLUSIVE RIGHT TO USE "MOISTURE", APART FROM THE MARK AS SHOWN.

FOR CLOTH COASTERS (U.S. CLS. 42 AND 50).

FIRST USE 8-1-2006; IN COMMERCE 1-1-2007.

IRENE D. WILLIAMS, EXAMINING ATTORNEY

SN 77-217,347. SWADDLEDESIGNS, LLC, SEATTLE, WA. FILED 6-27-2007.

WEESWADDLE

THE MARK CONSISTS OF STANDARD CHARACTERS WITHOUT CLAIM TO ANY PARTICULAR FONT, STYLE, SIZE, OR COLOR.

FOR RECEIVING BLANKETS; INFANT OR CHILD WRAPPING BLANKETS (U.S. CLS. 42 AND 50).

PAMELA HIRSCHMAN, EXAMINING ATTORNEY

CLASS 24—(Continued).

SN 78-795,269. XMA, L.L.C., MIDWEST CITY, OK. FILED 1-19-2006.

XMA

THE MARK CONSISTS OF STANDARD CHARACTERS WITHOUT CLAIM TO ANY PARTICULAR FONT, STYLE, SIZE, OR COLOR.

FOR DOMESTICS, NAMELY, BED BLANKETS, CHILDREN'S BLANKETS, COMFORTERS, COVERS FOR CUSHIONS, THROW BLANKETS, DRAPERIES, PILLOW CASES, PILLOW COVERS, PILLOW SHAMS, PLASTIC PLACE MATS, SHOWER CURTAINS, TABLE CLOTHS NOT OF PAPER, TABLE LINENS, TABLE MATS NOT OF PAPER, TOWELS; BATH, BED, DINING, AND KITCHEN LINENS; THROWS; FABRIC BATHROOM ACCESSORIES; NAMELY, FITTED TOILET LID COVERS MADE OF FABRIC OR FABRIC SUBSTITUTES (U.S. CLS. 42 AND 50).

MARK PILARO, EXAMINING ATTORNEY

SN 78-833,646. STRIKE INVESTMENTS, LLC, LOVELAND, OH. FILED 3-9-2006.

FIBRIQ

THE MARK CONSISTS OF STANDARD CHARACTERS WITHOUT CLAIM TO ANY PARTICULAR FONT, STYLE, SIZE, OR COLOR.

FOR TEXTILE AND TEXTILE GOODS, NAMELY, FABRICS FOR USE IN THE FURTHER MANUFACTURE OF CLOTHING AND UPHOLSTERY; BED COVERS, SHEETS, BLANKETS AND BEDSPREADS; AND TABLECLOTHS (U.S. CLS. 42 AND 50).

AMY MCMENAMIN, EXAMINING ATTORNEY

SN 78-866,563. W.M.S. TRADE GROUP INTERNATIONAL, INC., SARASOTA, FL. FILED 4-21-2006.

ENCHANTED SPA

THE MARK CONSISTS OF STANDARD CHARACTERS WITHOUT CLAIM TO ANY PARTICULAR FONT, STYLE, SIZE, OR COLOR.

NO CLAIM IS MADE TO THE EXCLUSIVE RIGHT TO USE SPA, APART FROM THE MARK AS SHOWN.

FOR WASHING MITTS (U.S. CLS. 42 AND 50).

FIRST USE 3-1-2006; IN COMMERCE 3-1-2006.

WILLIAM VERHOSEK, EXAMINING ATTORNEY

CLASS 24—(Continued).

SN 78-961,822. LONDON LUXURY LLC, NEW ROCHELLE, NY. FILED 8-28-2006.

ESSENTIALS BY LUXE SPA

THE MARK CONSISTS OF STANDARD CHARACTERS WITHOUT CLAIM TO ANY PARTICULAR FONT, STYLE, SIZE, OR COLOR.

OWNER OF U.S. REG. NOS. 3,027,329 AND 3,092,304. FOR BATH LINENS, NAMELY, BATH TOWELS, HAND TOWELS, WASH CLOTHS, BATH SHEETS, SHOWER CURTAINS; BED LINENS, NAMELY, BED BLANKETS, DUVET COVERS, COVERLETS, COMFORTERS, TROWS, QUILTS, PILLOW SHAMS, BED SKIRTS, BED SHEETS, PILLOW CASES (U.S. CLS. 42 AND 50).

MARK PILARO, EXAMINING ATTORNEY

CLASS 25—(Continued).

SN 76-343,991. MILLER, STANLEY F., MADISON, WI. FILED 11-30-2001.

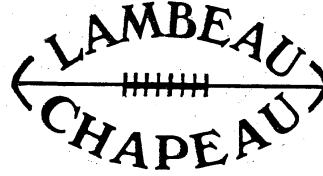

NO CLAIM IS MADE TO THE EXCLUSIVE RIGHT TO USE "CHAPEAU", APART FROM THE MARK AS SHOWN. THE LINING IS A FEATURE OF THE MARK AND DOES NOT INDICATE COLOR.

COLOR IS NOT CLAIMED AS A FEATURE OF THE MARK.

FOR FEDORA-STYLE HEADWEAR (U.S. CLS. 22 AND 39).

RUSS HERMAN, EXAMINING ATTORNEY

SN 78-971,170. A. LYONS CO., INC., MANCHESTER, MA. FILED 9-11-2006.

COOL VAPOR

THE MARK CONSISTS OF STANDARD CHARACTERS WITHOUT CLAIM TO ANY PARTICULAR FONT, STYLE, SIZE, OR COLOR.

FOR FABRIC FOR BOOTS AND SHOES; FABRICS FOR THE MANUFACTURE OF BOOTS AND SHOES; MESH-WOVEN FABRICS; WOVEN FABRICS (U.S. CLS. 42 AND 50).

GINA HAYES, EXAMINING ATTORNEY

SN 76-590,378. BC INTERNATIONAL GROUP, INC., TOTOWA, NJ. FILED 5-4-2004.

BLACK DIAMOND

THE MARK CONSISTS OF STANDARD CHARACTERS WITHOUT CLAIM TO ANY PARTICULAR FONT, STYLE, SIZE, OR COLOR.

FOR LUXURY FUR COATS; FUR SCARVES, FUR STOLES, FUR JACKETS, FUR CAPES, FUR VESTS, FUR HATS; FUR ACCESSORIES, NAMELY MUFFS SOLD IN FUR BOUTIQUES IN DEPARTMENT STORES AND NOT SOLD IN SPORTING GOODS STORES (U.S. CLS. 22 AND 39).

FIRST USE 0-0-1950; IN COMMERCE 0-0-1950. SUE LAWRENCE, EXAMINING ATTORNEY

CLASS 25—CLOTHING

SN 76-069,152. VIDA ENTERPRISE CORP., LOS ANGELES, CA. FILED 6-13-2000.



FOR SOCKS (U.S. CLS. 22 AND 39). FIRST USE 12-31-1985; IN COMMERCE 12-31-1985. MARY ROSSMAN, EXAMINING ATTORNEY

SN 76-642,478. STEWART, BRUCE, AKRON, OH. FILED 7-8-2005.

BUBBA GO FIGURE

THE MARK CONSISTS OF STANDARD CHARACTERS WITHOUT CLAIM TO ANY PARTICULAR FONT, STYLE, SIZE, OR COLOR.

FOR CLOTHING, NAMELY, SHIRTS, PANTS; CAPS, AND VISORS (U.S. CLS. 22 AND 39).

ALEX KEAM, EXAMINING ATTORNEY

CLASS 25—(Continued).

SN 76-650,792. NEIGHBORHOOD CO., LTD., TOKYO, JAPAN, FILED 11-22-2005.

NEIGHBORHOOD

THE MARK CONSISTS OF STANDARD CHARACTERS WITHOUT CLAIM TO ANY PARTICULAR FONT, STYLE, SIZE, OR COLOR.

FOR JACKETS, SWEATSHIRTS, BUSINESS SUITS, COATS, SWEATERS, T-SHIRTS, UNDERWEAR, NECK BANDS, CAPS, BELTS, SHOES, FOOTWEAR, BOOTS FOR SPORTS, TROUSERS, PANTS (U.S. CLS. 22 AND 39).

DAHLIA GEORGE, EXAMINING ATTORNEY



SN 76-651,582. UNITED SOUVENIR & APPAREL, INC., BALTIMORE, MD. FILED 12-8-2005.

CAVIAR KIDS

THE MARK CONSISTS OF STANDARD CHARACTERS WITHOUT CLAIM TO ANY PARTICULAR FONT, STYLE, SIZE, OR COLOR.

NO CLAIM IS MADE TO THE EXCLUSIVE RIGHT TO USE "KIDS", APART FROM THE MARK AS SHOWN.

FOR CLOTHING, NAMELY, T-SHIRTS, SWEAT-PANTS, SWEATSHIRTS, DRESSES, CAPS, HATS AND TANK TOPS FOR CHILDREN (U.S. CLS. 22 AND 39).

FIRST USE 3-1-2005; IN COMMERCE 3-1-2005.
JESSICA A. POWERS, EXAMINING ATTORNEY



SN 76-652,044. JVL LOS ANGELES, BEVERLY HILLS, CA. FILED 12-19-2005.

JVL LOS ANGELES

THE MARK CONSISTS OF STANDARD CHARACTERS WITHOUT CLAIM TO ANY PARTICULAR FONT, STYLE, SIZE, OR COLOR.

NO CLAIM IS MADE TO THE EXCLUSIVE RIGHT TO USE "LOS ANGELES", APART FROM THE MARK AS SHOWN.

FOR T-SHIRTS (U.S. CLS. 22 AND 39).
ARETHA SOMERVILLE, EXAMINING ATTORNEY

CLASS 25—(Continued).

SN 76-663,932. YIELD ALL WAYS, LLC, SOUTHLAKE, TX. FILED 8-1-2006.

PURCHASE WITH PURPOSE

THE MARK CONSISTS OF STANDARD CHARACTERS WITHOUT CLAIM TO ANY PARTICULAR FONT, STYLE, SIZE, OR COLOR.

FOR CLOTHING FOR MEN AND WOMEN, NAMELY, JEANS, SHIRTS, SHORTS, SKIRTS, SHOES, HATS, PANTS, SOCKS, UNDERWEAR, JACKETS, SWEATERS (U.S. CLS. 22 AND 39).

B. PARADEWELAI, EXAMINING ATTORNEY



SN 76-663,971. YIELD ALL WAYS, SOUTHLAKE, TX. FILED 8-1-2006.

FASHION WITH PURPOSE

THE MARK CONSISTS OF STANDARD CHARACTERS WITHOUT CLAIM TO ANY PARTICULAR FONT, STYLE, SIZE, OR COLOR.

NO CLAIM IS MADE TO THE EXCLUSIVE RIGHT TO USE "FASHION", APART FROM THE MARK AS SHOWN.

FOR CLOTHING FOR MEN AND WOMEN, NAMELY, JEANS, SHIRTS, SHORTS, PANTS, JACKETS, SHOES, SWEATERS, HATS, SOCKS, UNDERWEAR (U.S. CLS. 22 AND 39).

B. PARADEWELAI, EXAMINING ATTORNEY



SN 76-663,996. YIELD ALL WAYS, LLC, SOUTHLAKE, TX. FILED 8-1-2006.

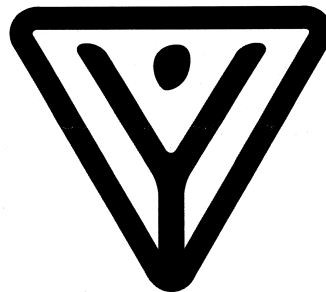

FOR CLOTHING FOR MEN AND WOMEN, NAMELY, JEANS, SHIRTS, SHORTS, PANTS, SWEATERS, JACKETS, HATS, SHOES, SOCKS, UNDERWEAR (U.S. CLS. 22 AND 39).

B. PARADEWELAI, EXAMINING ATTORNEY

CLASS 25—(Continued).

SN 76-664,293. YIELD ALL WAYS, LLC, SOUTHLAKE, TX.
FILED 8-8-2006.

YIELD

THE MARK CONSISTS OF STANDARD CHARACTERS WITHOUT CLAIM TO ANY PARTICULAR FONT, STYLE, SIZE, OR COLOR.

FOR CLOTHING FOR MEN AND WOMEN, NAMELY, JEANS, SHIRTS, SHORTS, SKIRTS, PANTS, JACKETS, SWEATERS, SHOES, HATS, SOCKS, UNDERWEAR (U.S. CLS. 22 AND 39).

B. PARADEWELAI, EXAMINING ATTORNEY

SN 76-666,284. BLOOMBERG, JON J., NEW YORK, NY.
FILED 9-19-2006.

I AM 911

THE MARK CONSISTS OF STANDARD CHARACTERS WITHOUT CLAIM TO ANY PARTICULAR FONT, STYLE, SIZE, OR COLOR.

FOR CLOTHING TO BE SOLD FOR MEMBERS OF THE 911 SYSTEM AND OTHER INDIVIDUALS OR CORPORATIONS, NAMELY, T-SHIRTS, SWEATSHIRTS, GOLF-STYLE SHIRTS, BASEBALL CAPS, VISORS, SWEATPANTS, RUNNING SUITS, CLOTH BIBS AND INFANT BODYSUITS, AND BARBECUE APRONS (U.S. CLS. 22 AND 39).

BARBARA GAYNOR, EXAMINING ATTORNEY

SN 76-666,687. BLOOMBERG, JON J., NEW YORK, NY.
FILED 9-27-2006.

WE ARE 911

THE MARK CONSISTS OF STANDARD CHARACTERS WITHOUT CLAIM TO ANY PARTICULAR FONT, STYLE, SIZE, OR COLOR.

FOR CLOTHING TO BE SOLD TO MEMBERS OF THE 911 SYSTEM AND OTHER INDIVIDUALS OR CORPORATIONS, NAMELY, T-SHIRTS, SWEATSHIRTS, GOLF-STYLE SHIRTS, BASEBALL CAPS, VISORS, SWEATPANTS, RUNNING SUITS, CLOTH BIBS AND INFANT BODYSUITS, AND BARBECUE APRONS (U.S. CLS. 22 AND 39).

BARBARA GAYNOR, EXAMINING ATTORNEY

CLASS 25—(Continued).

SN 76-667,431. THECIRCLE.ORG, LLC, CINCINNATI, OH.
FILED 10-12-2006.

THE CIRCLE

THE MARK CONSISTS OF STANDARD CHARACTERS WITHOUT CLAIM TO ANY PARTICULAR FONT, STYLE, SIZE, OR COLOR.

FOR CLOTHING, NAMELY, T-SHIRTS, POLO SHIRTS, SHORTS, SWEATERS, SWEAT SHIRTS, SWEAT PANTS, JACKETS AND SOCKS; HEADWEAR, NAMELY, BASEBALL HATS AND HIKING HATS (U.S. CLS. 22 AND 39).

PAULA MAYS, EXAMINING ATTORNEY

SN 76-670,077. BRASSEUR, INC., LOS ANGELES, CA. FILED
12-6-2006.

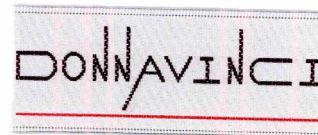

OWNER OF U.S. REG. NOS. 2,028,928 AND 3,115,813.
THE NAME DONNA VINCI DOES NOT IDENTIFY A LIVING INDIVIDUAL.

THE COLOR(S) BLACK, WHITE AND RED IS/ARE CLAIMED AS A FEATURE OF THE MARK.

THE COLOR BLACK APPEARS IN THE WORDING "DONNA VINCI." THE COLOR WHITE APPEARS IN THE BACKGROUND OF THE MARK. THE COLOR RED APPEARS IN THE DESIGN AS A SOLID LINE BELOW THE WORDING

FOR SHOES, LEATHER SHOES, RUBBER SHOES, DRESSY SHOES, WOMAN'S SHOES AND BOOTS, RUNNING SHOES, AND FOOTWEAR NAMELY PUMPS (U.S. CLS. 22 AND 39).

FIRST USE 10-0-2006; IN COMMERCE 10-0-2006.
CHRISTINA SOBRAL, EXAMINING ATTORNEY

CLASS 25—(Continued).

SN 76-672,354. TENNYSON, BRIAN, BRADENTON, FL. FILED 2-2-2007.

Dawgone...Jeans

NO CLAIM IS MADE TO THE EXCLUSIVE RIGHT TO USE "JEANS", APART FROM THE MARK AS SHOWN. FOR JEANS; SHIRTS (U.S. CLS. 22 AND 39). ERNEST SHOSHO, EXAMINING ATTORNEY

SN 76-673,493. BRANNON, RONALD, JR., NEW YORK, NY. FILED 3-2-2007.

MONSTER SWEETS

THE MARK CONSISTS OF STANDARD CHARACTERS WITHOUT CLAIM TO ANY PARTICULAR FONT, STYLE, SIZE, OR COLOR.

NO CLAIM IS MADE TO THE EXCLUSIVE RIGHT TO USE "SWEETS", APART FROM THE MARK AS SHOWN.

FOR CLOTHING APPAREL FEATURING CANDY OR CONFECTIONARY THEMES, NAMELY SHIRTS, T-SHIRTS, SWEATSHIRTS, LONG SLEEVE SHIRTS, SCARVES, HATS, PANTS, TIES, SNEAKERS, SOCKS, UNDERGARMENTS, AND JACKETS (U.S. CLS. 22 AND 39).

HOWARD SMIGA, EXAMINING ATTORNEY

SN 76-675,099. OSINUGA, KIM, STONE MOUNTAIN, GA. AND OSINUGA, BRANDON, STONE MOUNTAIN, GA. AND OSINUGA, JOHN, STONE MOUNTAIN, GA. FILED 4-5-2007.



*A since of style and Elegance at your feet.

FOR SHOES (U.S. CLS. 22 AND 39). ANNE MADDEN, EXAMINING ATTORNEY

CLASS 25—(Continued).

SN 76-675,668. ESSEX MUSIC, INC., NEW YORK, NY. FILED 4-18-2007.

NIGHTS IN WHITE SATIN THE TRIP

THE MARK CONSISTS OF STANDARD CHARACTERS WITHOUT CLAIM TO ANY PARTICULAR FONT, STYLE, SIZE, OR COLOR.

FOR CLOTHING, NAMELY T-SHIRTS, POLO SHIRTS, SWEATSHIRTS, CAPS, HATS, FOOTWEAR AND JACKETS (U.S. CLS. 22 AND 39).

GIANCARLO CASTRO, EXAMINING ATTORNEY

SN 77-003,333. MOSS, GREGORY V., CYPRESS, CA. FILED 9-20-2006.

FOOTSTEPS OF A CHAMPION

THE MARK CONSISTS OF STANDARD CHARACTERS WITHOUT CLAIM TO ANY PARTICULAR FONT, STYLE, SIZE, OR COLOR.

FOR CLOTHING, NAMELY, SHIRTS, PANTS, SHORTS AND JACKETS (U.S. CLS. 22 AND 39).

LYDIA BELZER, EXAMINING ATTORNEY

SN 77-004,196. ALISON HARLOW GERSHENSON, NEW YORK, NY. FILED 9-21-2006.

GET IN THE GAME... SCORE!

THE MARK CONSISTS OF STANDARD CHARACTERS WITHOUT CLAIM TO ANY PARTICULAR FONT, STYLE, SIZE, OR COLOR.

FOR CLOTHING, NAMELY, ANORAKS, BATHROBES, BEACH COVER-UPS, BEACH SHIRTS, BEACHWEAR, BELTS, BIKINIS, BLAZERS, BLOUSES, BODY SHAPERS, BODY SUITS, BOXER SHORTS, BOY SHORTS, BRAS, BRASSIERES, BRIEFS, BUSTIERS, CAFTANS, CAMI-SOLES, CAPS, CARDIGANS, COATS, CORSETS, DRESSES, DRESSING GOWNS, FOUNDATION GARMENTS, G-STRINGS, GARTER BELTS, GIRDLES, GLOVES, GOWNS, HALTER TOPS, HEADBANDS, HOSIERY, JACKETS, JEANS, JERSEYS, JOGGING SUITS, JUMPERS, JUMPSUITS, KIMONOS, KNEE HIGHS, KNIT SHIRTS, KNIT TOPS, LEGGINGS, LEOTARDS, LINGERIE, LOUNGEWEAR, MITTENS, NEGLIGES, NIGHTGOWNS, NIGHTSHIRTS, OVERCOATS, PAJAMAS, PANTIES, PANTS, PANTYHOSE, PETTICOATS, PULLOVERS, ROBES, RAINCOATS, SARONGS, SCARVES, SHIRTS, SHORTS, SKIRTS, SLACKS, SLEEPWEAR, SLIPS, SOCKS, STOCKINGS, SUITS, SWEAT-PANTS, SWEATSHIRTS, SWEAT SHORTS, SWEAT SUITS, SWEATERS, SWIMWEAR, T-SHIRTS, TANK TOPS, TAP PANTS, TEDDIES, TENNIS WEAR, UNDERWEAR THONGS, TIES, TIGHTS, TRACK SUITS, TROUSERS, TRUNKS, TUBE TOPS, UNDERPANTS, UNDERSHIRTS, UNDERWEAR, VESTS, WARM-UP SUITS AND WRISTBANDS; FOOTWEAR; AND HEADWEAR (U.S. CLS. 22 AND 39).

DAVID C. REIHNER, EXAMINING ATTORNEY

CLASS 25—(Continued).

SN 77-013,040. DIRT WEAR INC., MIRA LOMA, CA. FILED 10-3-2006.

LETS GET DIRTY

THE MARK CONSISTS OF STANDARD CHARACTERS WITHOUT CLAIM TO ANY PARTICULAR FONT, STYLE, SIZE, OR COLOR.

FOR SHIRTS, SHORTS, SOCKS, SWEAT PANTS, SWEAT SHIRTS, BELTS, UNDERWEAR, HATS, CAPS, BEANIES, VISORS (U.S. CLS. 22 AND 39).

FIRST USE 0-0-1998; IN COMMERCE 0-0-2003.
DAVID HOFFMAN, EXAMINING ATTORNEY

SN 77-013,605. HADDOCK, SHANE, DENISON, TX. FILED 10-4-2006.

SUPREME
FITNESS GEAR

NO CLAIM IS MADE TO THE EXCLUSIVE RIGHT TO USE "SUPREME FITNESS GEAR", APART FROM THE MARK AS SHOWN.

FOR PANTS; SHIRTS; SWEAT SHIRTS; JACKETS; SWEAT PANTS; WARM UP SUITS; BEANIES; HATS; TANK TOPS; SHORTS; WRISTBANDS (U.S. CLS. 22 AND 39).

GENE MACIOL, EXAMINING ATTORNEY

SN 77-013,651. RATHKE, DAVID AUGUST JR, BROOKLYN, NY. FILED 10-4-2006.

(mi'ngks)

THE MARK CONSISTS OF STANDARD CHARACTERS WITHOUT CLAIM TO ANY PARTICULAR FONT, STYLE, SIZE, OR COLOR.

"THE NON-LATIN CHARACTER(S) IN THE MARK TRANSLITERATES INTO EITHER MYNX OR MINNEKEN, AND THIS MEANS DARLING, PLAYFUL LITTLE DOG, PERT, SAUCY, BOLD, FLIRTATIOUS IN ENGLISH."

FOR EVENING DRESSES; HALTER TOPS; KNIT SHIRTS; SHORT-SLEEVED OR LONG-SLEEVED T-SHIRTS; SKIRTS AND DRESSES; SWEATERS; TOPS; V-NECK SWEATERS, ALL COMPOSED OF EITHER PART OR ALL OF THE FOLLOWING: SILK, CASHMERE, COTTON, LEATHER, SPANDEX, AND/OR RAYON (U.S. CLS. 22 AND 39).

FIRST USE 8-25-2005; IN COMMERCE 6-25-2006.
HENRY S. ZAK, EXAMINING ATTORNEY

CLASS 25—(Continued).

SN 77-014,221. CHAMBLISS, MICHELLE, LAKE ELSINORE, CA. FILED 10-4-2006.



THE MARK CONSISTS OF THE WORD 'GETTIN' IN STYLIZED FORM AND A DESIGN SHOWN IN HEBREW CHARACTERS. TO THE LEFT OF THE HEBREW CHARACTER IS A DESIGN OF A RABBI PLAYING A SHOFAR OR ANIMAL HORN USED IN THE JEWISH FAITH AND CARRYING A TORAH SCROLL.

THE NON-LATIN CHARACTERS IN THE MARK TRANSLITERATE TO "CHAI" AND THIS MEANS "LIFE" IN ENGLISH.

FOR MEN'S, WOMEN'S AND CHILDREN'S CLOTHING, NAMELY, SHIRTS, T-SHIRTS, SWEATSHIRTS, SHORTS, SOCKS, HATS, GLOVES, PANTS, SKIRTS, BLOUSES, DRESSES, SWEATERS, JACKETS, COATS (U.S. CLS. 22 AND 39).

FIRST USE 9-16-2006; IN COMMERCE 9-18-2006.
CIMMERIAN COLEMAN, EXAMINING ATTORNEY

SN 77-019,348. FRATEX INDUSTRIAL E COMERCIO LTDA., SAO PAULO - SP, BRAZIL, FILED 10-12-2006.

T & F BRAZIL

THE MARK CONSISTS OF STANDARD CHARACTERS WITHOUT CLAIM TO ANY PARTICULAR FONT, STYLE, SIZE, OR COLOR.

NO CLAIM IS MADE TO THE EXCLUSIVE RIGHT TO USE "BRAZIL", APART FROM THE MARK AS SHOWN.

FOR BATHING SUITS; BATHING TRUNKS; BIKINIS; BREECHES; JACKETS; LEGGINGS; SWIMSUITS; T-SHIRTS; TANK TOPS; TOPS; TROUSERS (U.S. CLS. 22 AND 39).

JOANNA DUKOVIC, EXAMINING ATTORNEY

CLASS 25—(Continued).

SN 77-020,499. SROUR, MARK, SUNNY ISLES, FL. FILED 10-13-2006.

AZULU

THE MARK CONSISTS OF STANDARD CHARACTERS WITHOUT CLAIM TO ANY PARTICULAR FONT, STYLE, SIZE, OR COLOR.

FOR CLOTHING, NAMELY, HATS, LONG PANTS, CAPRI PANTS, SHORTS, BERMUDA SHORTS, SKIRTS, MINI-SKIRTS, T-SHIRTS, SHIRTS, GUAYABERAS, BLOUSES, UNDERWEAR, SWEATERS, PULLOVERS, BLAZER, JACKETS, BLAZERS, BATHING SUITS, HOSIERY, SOCKS, JEANS, BUSTIERS, AND TIES (U.S. CLS. 22 AND 39).

FIRST USE 10-0-2005; IN COMMERCE 10-0-2005.
SANJEEV VOHRA, EXAMINING ATTORNEY

SN 77-029,230. BELLINI, EILEEN, MANHASSET, NY. FILED 10-25-2006.

THE HAMPTONS - WHERE THE
SEA GREETES THE STARS

THE MARK CONSISTS OF STANDARD CHARACTERS WITHOUT CLAIM TO ANY PARTICULAR FONT, STYLE, SIZE, OR COLOR.

FOR CLOTHING, NAMELY, SWEATSHIRTS, SWEATPANTS, SWEATSHORTS, BATHING SUITS, GYM SUITS, JOGGING SUITS, SUN VISORS, SWIM TRUNKS, SWIM WEAR, SWIMSUITS, T-SHIRTS, TANK TOPS, TAP PANTS, TENNIS WEAR, HALTER TOPS, TOPS, BATHING TRUNKS, WARM-UP SUITS, VISORS, WIND RESISTANT JACKETS (U.S. CLS. 22 AND 39).

TARAH HARDY, EXAMINING ATTORNEY

SN 77-031,301. TADASHI, SHOJI, VERNON, CA. FILED 10-27-2006.

FOR DRESSES, SHIRTS, BELTS (U.S. CLS. 22 AND 39).
EVELYN BRADLEY, EXAMINING ATTORNEY

CLASS 25—(Continued).

SN 77-033,187. SHAFFER, MARIE KENNEDY, LOS ANGELES, CA. AND SHAFFER, JAMES, LOS ANGELES, CA. FILED 10-31-2006.

BELLBOTTOM BLUES

THE MARK CONSISTS OF STANDARD CHARACTERS WITHOUT CLAIM TO ANY PARTICULAR FONT, STYLE, SIZE, OR COLOR.

NO CLAIM IS MADE TO THE EXCLUSIVE RIGHT TO USE "BELLBOTTOM", APART FROM THE MARK AS SHOWN.

FOR BLOUSES; BOTTOMS; COATS; DRESSES; JACKETS; PANTS; SHIRTS; SHORT-SLEEVED OR LONG-SLEEVED T-SHIRTS; SHORTS; SKIRTS; T-SHIRTS; TOPS; VESTS (U.S. CLS. 22 AND 39).

KEVON CHISOLM, EXAMINING ATTORNEY

SN 77-035,634. FONTENÉ CARTELL, INC., NEW ORLEANS, LA. FILED 11-2-2006.

THE TERM "FONTENÉ CARTELL" DOES NOT IDENTIFY ANY LIVING INDIVIDUAL.

THE MARK CONSISTS OF LETTERS TO MAKE TWO WORDS.

FOR CLOTHING ITEMS, NAMELY, SHIRTS, T-SHIRTS, SWEATPANTS, PANTS, SWEATSHIRTS, JACKETS, SWEATERS, VESTS, SHORTS, SKIRTS, BASEBALL CAPS, HATS, SOCKS AND SHOES (U.S. CLS. 22 AND 39).

BILL DAWE, EXAMINING ATTORNEY

SN 77-037,901. TONY LARUSSA'S ANIMAL RESCUE FOUNDATION, WALNUT CREEK, CA. FILED 11-6-2006.



Smooch Your Pooch!

THE COLOR(S) FUSCHIA IS/ARE CLAIMED AS A FEATURE OF THE MARK.

THE MARK CONSISTS OF AN IMPRINT OF LIPS CENTERED OVER THE WORDS 'SMOOCH YOUR POOCH' IN STYLIZED LETTERS. THE COLOR FUSCHIA APPEARS IN THE DESIGN AND THE OUTLINE OF THE LETTERING. THE LETTERING IS TRANSPARENT. THE COLOR WHITE ELSEWHERE IN THE DRAWING IS NOT A FEATURE OF THE MARK AND IS MERELY THE BACKGROUND.

FOR BASEBALL CAPS; T-SHIRTS (U.S. CLS. 22 AND 39).

FIRST USE 4-1-2006; IN COMMERCE 4-1-2006.
MELVIN AXILBUND, EXAMINING ATTORNEY

CLASS 25—(Continued).

SN 77-051,047. BYONG-JIN, JOO, MAPO-KU, SEOUL, REPUBLIC OF KOREA, FILED 11-27-2006.

PRIORITY CLAIMED UNDER SEC. 44(D) ON REPUBLIC OF KOREA APPLICATION NO. TM(40)-2006-, FILED 9-14-2006.

NO CLAIM IS MADE TO THE EXCLUSIVE RIGHT TO USE "Y&CO.", APART FROM THE MARK AS SHOWN.

FOR SHOES, SWIMMING SUITS, T-SHIRTS, GLOVES, SOCKS, CAPS, BRACES FOR CLOTHING, LEATHER BELTS, SANDALS, CHILDREN'S PANTS, INFANTS' WEAR, UNIFORMS FOR SPORTS, BRASSIERES, UNDERCLOTHING, UNDERPANTS, UNDERSHIRTS, NIGHTGOWNS (U.S. CLS. 22 AND 39).

DORITT L. CARROLL, EXAMINING ATTORNEY

SN 77-056,847. RENTERIA, ADRIAN, SANTA CLARITA, CA. FILED 12-5-2006.



THE MARK CONSISTS OF A RECTANGLE TO THE RIGHT OF THE LITERARY ELEMENT WITH A BOLDED S-SHAPED NON STANDARD LETTER.

FOR SHIRTS; SHORT-SLEEVED OR LONG-SLEEVED T-SHIRTS; SHORTS; SWEAT SHIRTS; TANK TOPS (U.S. CLS. 22 AND 39).

LESLIE RICHARDS, EXAMINING ATTORNEY

SN 77-057,976. HICKS, INDIA, WOODSTOCK, CT. FILED 12-6-2006.

INDIA HICKS ISLAND LIVING

THE MARK CONSISTS OF STANDARD CHARACTERS WITHOUT CLAIM TO ANY PARTICULAR FONT, STYLE, SIZE, OR COLOR.

THE NAME(S), PORTRAIT(S), AND/OR SIGNATURE(S) SHOWN IN THE MARK IDENTIFIES INDIA HICKS, WHOSE CONSENT(S) TO REGISTER IS MADE OF RECORD.

FOR SLEEPWEAR; ROBES; SLIPPERS (U.S. CLS. 22 AND 39).

CAROLYN GRAY, EXAMINING ATTORNEY

CLASS 25—(Continued).

SN 77-065,840. FELIPE, ROBERTO A., SOUTH RICHMOND HILL, NY. FILED 12-16-2006.

THE NAME ALFONSO FELIPE DOES NOT IDENTIFY A LIVING INDIVIDUAL.

FOR BLAZERS; COATS FOR MEN AND WOMEN; DRESS SUITS; FOOTWEAR; FUR COATS AND JACKETS; FUR JACKETS; HATS; JACKETS; KNIT SHIRTS; LEATHER JACKETS; MEN AND WOMEN JACKETS, COATS, TROUSERS, VESTS; MEN'S SOCKS; MEN'S SUITS; MEN'S SUITS, WOMEN'S SUITS; PANTS; SCARVES; SHIRTS; SHIRTS FOR SUITS; SILK SCARVES; SOCKS; SWEAT BANDS; SWEAT PANTS; SWEAT SHIRTS; TIES (U.S. CLS. 22 AND 39).

KATHERINE CHANG, EXAMINING ATTORNEY

SN 77-068,279. ROBERTS, VICKI, DBA I REST MY CASE, SANTA MONICA, CA. FILED 12-20-2006.

I Rest My Case

THE MARK CONSISTS OF STANDARD CHARACTERS WITHOUT CLAIM TO ANY PARTICULAR FONT, STYLE, SIZE, OR COLOR.

FOR CLOTHING, NAMELY, SHIRTS, PANTS, JACKETS, HATS, SKIRTS AND BLOUSES ALL FOR USE AS DRESSWEAR, SPORTSWEAR AND CASUALWEAR (U.S. CLS. 22 AND 39).

SKYE YOUNG, EXAMINING ATTORNEY

SN 77-069,017. LOPEZ, JOSEFINA, LOS ANGELES, CA. FILED 12-21-2006.

Real Women Have Curves

THE MARK CONSISTS OF STANDARD CHARACTERS WITHOUT CLAIM TO ANY PARTICULAR FONT, STYLE, SIZE, OR COLOR.

FOR JERSEYS; SHORT SETS; TOPS (U.S. CLS. 22 AND 39).

FIRST USE 6-18-1988; IN COMMERCE 4-1-1991.

STANLEY I. OSBORNE, EXAMINING ATTORNEY

CLASS 25—(Continued).

SN 77-077,133. REBELDE BOOT'S S.A. DE C.V., LEON, GUANAJUATO, MEXICO, FILED 1-5-2007.

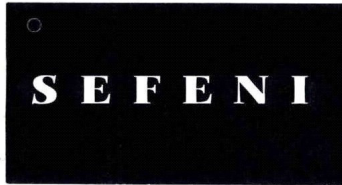

FOR FOOTWEAR; AND APPAREL, NAMELY, SHIRTS AND PANTS (U.S. CLS. 22 AND 39).
DANIEL CAPSHAW, EXAMINING ATTORNEY

SN 77-092,061. COSTELLO, SHELAGH, SWAMPSCOTT, MA. FILED 1-26-2007.

TO KNIT OR KNOT TO KNIT

THE MARK CONSISTS OF STANDARD CHARACTERS WITHOUT CLAIM TO ANY PARTICULAR FONT, STYLE, SIZE, OR COLOR.

FOR CLOTHING, NAMELY, T-SHIRTS, SHIRTS, APRONS, SWEATSHIRTS, PAJAMAS, HATS, GLOVES, SCARFS, SOCKS, PANTS, AND SKIRTS (U.S. CLS. 22 AND 39).

ELISSA GARBER KON, EXAMINING ATTORNEY

SN 77-095,573. GRENCI, DAVID L., BUTLER, PA. FILED 1-31-2007.

SIX SHOOTIN'

THE MARK CONSISTS OF STANDARD CHARACTERS WITHOUT CLAIM TO ANY PARTICULAR FONT, STYLE, SIZE, OR COLOR.

FOR CAPS; JACKETS; SHIRTS (U.S. CLS. 22 AND 39).
FIRST USE 11-21-2006; IN COMMERCE 11-21-2006.
DAWN HAN, EXAMINING ATTORNEY

CLASS 25—(Continued).

SN 77-100,279. K Aidanovits-Rogers, Jekaterina, Sunny Isles Beach, FL. FILED 2-6-2007.

Race Fashion

THE MARK CONSISTS OF STANDARD CHARACTERS WITHOUT CLAIM TO ANY PARTICULAR FONT, STYLE, SIZE, OR COLOR.

NO CLAIM IS MADE TO THE EXCLUSIVE RIGHT TO USE "FASHION", APART FROM THE MARK AS SHOWN.

FOR CLOTHING, NAMELY, T-SHIRTS, SHIRTS, SHORTS, LONG-SLEEVED SHIRTS, SHORT-SLEEVED SHIRTS, SLEEVELESS SHIRTS, POLO SHIRT, MATERNITY T-SHIRTS, JERSEYS, APRONS, BABY BIBS NOT OF PAPER, CLOTH BIBS, BELTS, BRAS, BRIEFS, JACKETS, TANK TOPS, TOPS, TRACK PANTS, TRACK SUITS, TRACKSUITS, TRUNKS, DRESSES, PULLOVERS, FOOTWEAR, GOLF SHIRTS, CARDIGANS, HEADWEAR, HATS, HEAD WEAR, BASEBALL CAPS, TRUCKER HATS, CAP VISORS, CAPS, SUN VISORS, HOODS, INFANT AND TODDLER ONE PIECE CLOTHING, INFANT WEAR, JACKETS, LINGERIE, LOUNGEWEAR, NECKWEAR, SHIRTS, OVERALLS, PAJAMAS, PANTS, PANTSUITS, PONCHOS, SKIRTS, DRESSES, SLEEPWEAR, SWEAT PANTS, SWEAT SHIRTS, SWEAT SHORTS, SWEAT SUITS, SWEATERS, SWIM WEAR, SWIMSUITS, TUNICS, T-SHIRTS AND UNDERWEAR (U.S. CLS. 22 AND 39).

FIRST USE 12-10-2006; IN COMMERCE 12-10-2006.

RONALD AIKENS, EXAMINING ATTORNEY

SN 77-102,026. ORGANIC GENES, REDONDO BEACH, CA. FILED 2-7-2007.

ORGANIC GENES

THE MARK CONSISTS OF STANDARD CHARACTERS WITHOUT CLAIM TO ANY PARTICULAR FONT, STYLE, SIZE, OR COLOR.

NO CLAIM IS MADE TO THE EXCLUSIVE RIGHT TO USE "ORGANIC", APART FROM THE MARK AS SHOWN.

FOR CLOTHING MADE WHOLLY OR SIGNIFICANTLY IN PART OF ORGANIC FIBERS, NAMELY, BLOUSES, COATS, HATS, JACKETS, JEANS, OVERALLS, PANTS, SHIRTS, SHORTS, SKIRTS, SLACKS, SPORT COATS, SWEAT PANTS, SWEAT SHIRTS, SWEATERS, T-SHIRTS, TROUSERS, AND VESTS (U.S. CLS. 22 AND 39).

WOODROW HARTZOG, EXAMINING ATTORNEY

CLASS 25—(Continued).

SN 77-108,979. EXPRESS, LLC, COLUMBUS, OH. FILED 2-16-2007.

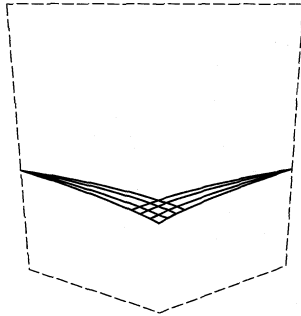

THE MARK CONSISTS OF A STYLIZED COMET DESIGN. THE MATTER SHOWN BY THE DOTTED LINES IS NOT A PART OF THE MARK AND SERVES ONLY TO SHOW THE POSITION OF THE MARK ON THE GOODS.
FOR CLOTHING, NAMELY, JEANS (U.S. CLS. 22 AND 39).

WILLIAM P. SHANAHAN, EXAMINING ATTORNEY

CLASS 25—(Continued).

SN 77-108,987. EXPRESS, LLC, COLUMBUS, OH. FILED 2-16-2007.

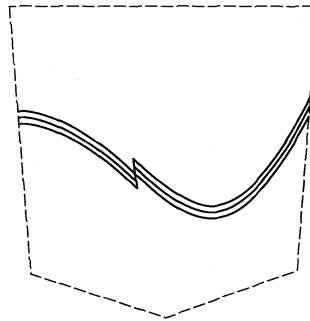

THE MARK CONSISTS OF A STYLIZED "Z" DESIGN. THE MATTER SHOWN BY THE DOTTED LINES IS NOT A PART OF THE MARK AND SERVES ONLY TO SHOW THE POSITION OF THE MARK ON THE GOODS.

FOR CLOTHING, NAMELY, JEANS (U.S. CLS. 22 AND 39).

WILLIAM P. SHANAHAN, EXAMINING ATTORNEY

SN 77-108,983. EXPRESS, LLC, COLUMBUS, OH. FILED 2-16-2007.

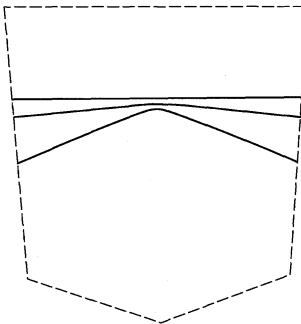

THE MARK CONSISTS OF A STYLIZED PEAK DESIGN. THE MATTER SHOWN BY THE DOTTED LINES IS NOT A PART OF THE MARK AND SERVES ONLY TO SHOW THE POSITION OF THE MARK ON THE GOODS.

FOR CLOTHING, NAMELY, JEANS (U.S. CLS. 22 AND 39).

WILLIAM P. SHANAHAN, EXAMINING ATTORNEY

SN 77-109,515. EVANS, MICHAEL A, WEST CHESTER, PA. FILED 2-16-2007.



THE MARK CONSISTS OF A SPARTAN HELMET LOGO DESIGNED WITH VERY SHARP EDGES. BENEATH THE PICTURE OF THE HELMET IS THE WORD "SPARTAN" THAT HAS BEEN CRUSHED DOWN VERTICALLY.

FOR BOARD SHORTS; KIMONOS; MARTIAL ARTS UNIFORMS; RASH GUARDS; T-SHIRTS; SWEATSHIRTS; HATS (U.S. CLS. 22 AND 39).

FIRST USE 6-10-2007; IN COMMERCE 6-10-2007.

DOMINIC J. FERRAIUOLO, EXAMINING ATTORNEY

CLASS 25—(Continued).

SN 77-112,696. ZOOEY APPAREL, INC., SANTA MONICA, CA. FILED 2-21-2007.

zooley

THE MARK CONSISTS OF STANDARD CHARACTERS WITHOUT CLAIM TO ANY PARTICULAR FONT, STYLE, SIZE, OR COLOR.

THE NAME ZOOEY DOES NOT IDENTIFY A LIVING INDIVIDUAL.

FOR BEACHWEAR; BLOUSES; CAPS; COATS; DENIMS; DRESSES; FOOTWEAR; GLOVES; HATS; HOSIERY; JACKETS; JEANS; JOGGING SUITS; KNIT SHIRTS; LINGERIE; LOUNGEWEAR; NECKWEAR; PAJAMAS; PANTS; PINAFORES; SCARVES; SHIRTS; SHORTS; SKIRTS; SLEEPWEAR; SUITS; SWEAT SHIRTS; SWEATERS; SWIM WEAR; T-SHIRTS; TROUSERS; UNDERGARMENTS; VESTS (U.S. CLS. 22 AND 39).

FIRST USE 1-1-2004; IN COMMERCE 1-1-2004.

PAM WILLIS, EXAMINING ATTORNEY

CLASS 25—(Continued).

SN 77-117,888. SKIN KISS LIMITED, BRISTOL, UNITED KINGDOM, FILED 2-28-2007.



THE COLOR(S) GOLD AND BLACK IS/ARE CLAIMED AS A FEATURE OF THE MARK.

THE MARK CONSISTS OF THE WORD SKINKISS SUPERIMPOSED OVER SOME GOLD COLOURED LIPS. THE COLOR BLACK APPEARS IN THE WORDING SKINKISS AND THE COLOR GOLD APPEARS IN THE DESIGN OF LIPS.

FOR HOSIERY; LADIES' UNDERWEAR; UNDERWEAR; WOMEN'S UNDERWEAR (U.S. CLS. 22 AND 39).

ANNE MADDEN, EXAMINING ATTORNEY

SN 77-117,959. BOSTON RED SOX BASEBALL CLUB LIMITED PARTNERSHIP, BOSTON, MA. FILED 2-28-2007.

BOSTON SOMERSETS

SN 77-112,714. ZOOEY APPAREL, INC., SANTA MONICA, CA. FILED 2-21-2007.

zøey

THE NAME(S), PORTRAIT(S), AND/OR SIGNATURE(S) SHOWN IN THE MARK DOES NOT IDENTIFY A PARTICULAR LIVING INDIVIDUAL.

THE MARK CONSISTS OF ZOOEY WITH INTERLOCKING LETTERS.

FOR BEACHWEAR; BLOUSES; CAPS; COATS; DENIMS; DRESSES; FOOTWEAR; GLOVES; HATS; HOSIERY; JACKETS; JEANS; JOGGING SUITS; KNIT SHIRTS; LINGERIE; LOUNGEWEAR; NECKWEAR; PAJAMAS; PANTS; PINAFORES; SCARVES; SHIRTS; SHORTS; SKIRTS; SLEEPWEAR; SUITS; SWEAT SHIRTS; SWEATERS; SWIM WEAR; T-SHIRTS; TROUSERS; UNDERGARMENTS; VESTS (U.S. CLS. 22 AND 39).

FIRST USE 1-1-2004; IN COMMERCE 1-1-2004.

PAM WILLIS, EXAMINING ATTORNEY

THE MARK CONSISTS OF STANDARD CHARACTERS WITHOUT CLAIM TO ANY PARTICULAR FONT, STYLE, SIZE, OR COLOR.

NO CLAIM IS MADE TO THE EXCLUSIVE RIGHT TO USE BOSTON, APART FROM THE MARK AS SHOWN.

FOR CLOTHING, NAMELY, CAPS, HATS, VISORS, KNITTED HEADWEAR, HEADBANDS, BANDANAS, SHIRTS, T-SHIRTS, TANK TOPS, BLOUSES, SWEATERS, TURTLENECKS, PULLOVERS, VESTS, SHORTS, PANTS, SLACKS, DRESSES, SKIRTS, OVERALLS, BODYSUITS, BASEBALL UNIFORMS, JERSEYS, WARM-UP SUITS, JOGGING SUITS, SWEATSHIRTS, SWEATPANTS, UNDERWEAR, BOXER SHORTS, ROBES, SLEEPWEAR, THERMAL LOUNGEWEAR, NIGHTSHIRTS, NIGHTGOWNS, SWIMWEAR, CLOTHING WRAPS, COATS, JACKETS, PONCHOS, RAINCOATS, CLOTH BIBS, INFANT WEAR, INFANT DIAPER COVERS, CLOTH DIAPER SETS WITH UNDERSHIRT AND DIAPER COVER, JUMPERS, ROMPERS, COVERALLS, CREEPERS, BABY BOOTIES, TODDLER ANKLETS, TIES, SUSPENDERS, BELTS, MONEY BELTS, MITTENS, GLOVES, WRISTBANDS, EARMUFFS, SCARVES, FOOTWEAR, SOCKS, HOSIERY, SLIPPERS, APRONS, SLIDING GIRDLES AND HALLOWEEN AND MASQUERADE COSTUMES (U.S. CLS. 22 AND 39).

DOMINICK J. SALEMI, EXAMINING ATTORNEY

CLASS 25—(Continued).

SN 77-122,852. AHMED, FAISAL, KARACHI, PAKISTAN, FILED 3-6-2007.

DENIM  LIMITED

NO CLAIM IS MADE TO THE EXCLUSIVE RIGHT TO USE "DENIM", APART FROM THE MARK AS SHOWN. THE MARK CONSISTS OF THE MARK OF OUR LINE OF DENIM JEANS AND OTHER CLOTHING.

FOR JEANS MADE SIGNIFICANTLY IN PART OF DENIM (U.S. CLS. 22 AND 39).

FIRST USE 9-1-2005; IN COMMERCE 9-1-2005.

GINA HAYES, EXAMINING ATTORNEY

CLASS 25—(Continued).

SN 77-124,557. ROUGHRIDERS BASEBALL PARTNERS, L.P., LOS ANGELES, FL. FILED 3-7-2007.



OWNER OF U.S. REG. NOS. 2,853,394 AND 2,855,849. FOR CLOTHING, NAMELY, SHIRTS, SHORTS, T-SHIRTS, POLO SHIRTS, GOLF SHIRTS, TANK TOPS, SOCKS, JACKETS, SWEATERS, VESTS, PANTS, PONCHOS, VISORS, HATS, CAPS, TIES, SWEATSHIRTS, MITTENS, GLOVES, KNITTED HATS, SCARVES, WRIST BANDS, HEAD BANDS, WIND RESISTENT JACKETS, JUMPSUITS, SWEATPANTS, BANDANAS, COATS, DRESSES, GYM SUITS, HEAD WEAR, LEATHER JACKETS, JERSEYS, PULLOVERS, RAINWEAR, NECKWEAR, V-NECK SWEATERS AND KNIT SHIRTS (U.S. CLS. 22 AND 39).

FIRST USE 7-3-2002; IN COMMERCE 7-3-2002.

CAROLYN GRAY, EXAMINING ATTORNEY

SN 77-124,391. ELROD RACING STYLE, SAUGUS, CA. FILED 3-7-2007.

Elrod Racing

THE MARK CONSISTS OF STANDARD CHARACTERS WITHOUT CLAIM TO ANY PARTICULAR FONT, STYLE, SIZE, OR COLOR.

NO CLAIM IS MADE TO THE EXCLUSIVE RIGHT TO USE "RACING", APART FROM THE MARK AS SHOWN.

FOR ATHLETIC FOOTWEAR; BEACH FOOTWEAR; BELTS; CAPS; CLOTHING, NAMELY, ARM WARMERS; CLOTHING, NAMELY, KNEE WARMERS; CLOTHING, NAMELY, WRAP-AROUNDS; DUSTERS; FLIP FLOPS; FOOTWEAR; FOOTWEAR FOR MEN AND WOMEN; HEADGEAR, NAMELY, CAPS, BEANIES; HOODS; JERSEYS; PERSPIRATION ABSORBENT UNDERWEAR CLOTHING; SHIRTS; SHORT SETS; THONGS; TOPS; WRAPS (U.S. CLS. 22 AND 39).

FIRST USE 11-24-2006; IN COMMERCE 11-24-2006.

ALICE BENMAMAN, EXAMINING ATTORNEY

SN 77-125,620. ZOOEY APPAREL, INC., SANTA MONICA, CA. FILED 3-8-2007.

zooley
by alice heller

THE MARK CONSISTS OF STANDARD CHARACTERS WITHOUT CLAIM TO ANY PARTICULAR FONT, STYLE, SIZE, OR COLOR.

THE NAME ALICE HELLER IDENTIFIES A LIVING INDIVIDUAL WHOSE CONSENT IS OF RECORD.

FOR SHIRTS; BEACHWEAR; BLOUSES; CAPS; COATS; DENIMS; DRESSES; FOOTWEAR; GLOVES; HATS; HOSIERY; JACKETS; JEANS; JOGGING SUITS; KNIT SHIRTS; LINGERIE; LOUNGEWEAR; NECKWEAR; PAJAMAS; PANTS; SCARVES; SHORTS; SKIRTS; SLEEPWEAR; SUITS; SWEATERS; T-SHIRTS; TROUSERS; UNDERGARMENTS; VESTS (U.S. CLS. 22 AND 39).

PAM WILLIS, EXAMINING ATTORNEY

CLASS 25—(Continued).

SN 77-126,186. BURCAR, MARK S., SHOREWOOD, IL.
FILED 3-8-2007.

WILL OVER SKILL

THE MARK CONSISTS OF STANDARD CHARACTERS WITHOUT CLAIM TO ANY PARTICULAR FONT, STYLE, SIZE, OR COLOR.

FOR APRONS, ATHLETIC FOOTWEAR, ATHLETIC SHOES, ATHLETIC UNIFORMS, BANDANAS, BASEBALL CAPS, BATHING SUITS, BATHING TRUNKS, BATHROBES, BEACH COVER-UPS, BEACH SHOES, BEACH WEAR, BERMUDA SHORTS, BIKINIS, BIKER SHORTS, BODY SUITS, BOXER SHORTS, SPORT BRAS, BRIEFS, CAPS, CHEF'S HAT, COATS, JACKETS, CROP TOPS, DENIM JACKETS, EAR MUFFS, GOLF SHIRTS, GOLF TEE SHIRTS, VESTS, GYM SHORTS, HALTER TOPS, HATS, HEADBANDS AGAINST SWEATING, HEAD WEAR, INFANT WEAR, CHILD CLOTH BIBS, TODDLER WEAR, NAMELY, A ONE PIECE GARMENT FOR TODDLERS, JEANS, JOGGING SUITS, RUNNING SHIRTS, RUNNING SHORTS, LEATHER JACKETS, LEGGINGS, LIGHT REFLECTING JACKETS, LOUNGE WEAR, MOCK TURTLE NECK SWEATERS, NECK BANDS, NECKWEAR, NIGHT SHIRTS, PAJAMAS, PANTIES, PANTS, POLO SHIRTS, PONCHOS, PULLOVERS, RAIN JACKETS, SANDALS, SASHES, SCARVES, SHAWLS, SHIRTS, FLEECE PULLOVERS, SHOES, SHORTS, SLEEP SHIRTS, SLEEP WEAR, SLIPPERS, SNEAKERS, SOCKS, SPORT SHIRTS, SUN VISORS, FISHING HATS, SKULL CAPS, KNIT CAPS, BEANIE CAPS, SWEATBANDS, SWEAT PANTS, SWEATSHIRTS, SWEAT SHORTS, SWEAT SUITS, GLOVES, SWEATERS, SWEAT SOCKS, SWIM CAPS, SWIM TRUNKS, SWIM WEAR, TANK TOPS, T-SHIRTS, VISORS, WIND RESISTANT JACKETS, WRIST BANDS (U.S. CLS. 22 AND 39).
CARYN GLASSER, EXAMINING ATTORNEY

SN 77-127,077. DYEABLES, INC., FARMINGTON, ME.
FILED 3-9-2007.

**PRIVATE COLLECTION BY
DYEABLES**

THE MARK CONSISTS OF STANDARD CHARACTERS WITHOUT CLAIM TO ANY PARTICULAR FONT, STYLE, SIZE, OR COLOR.

OWNER OF U.S. REG. NOS. 1,450,934 AND 2,647,687.
NO CLAIM IS MADE TO THE EXCLUSIVE RIGHT TO USE COLLECTION, APART FROM THE MARK AS SHOWN, SEC. 2(F) DYEABLES.
FOR FOOTWEAR (U.S. CLS. 22 AND 39).
FIRST USE 12-31-2005; IN COMMERCE 12-31-2005.
B. PARADEWELAI, EXAMINING ATTORNEY

CLASS 25—(Continued).

SN 77-129,748. RADFORD, CAROLYN ELIZABETH, BLOOMINGTON, IL. FILED 3-13-2007.

Go Jesus Go

THE MARK CONSISTS OF STANDARD CHARACTERS WITHOUT CLAIM TO ANY PARTICULAR FONT, STYLE, SIZE, OR COLOR.

FOR WEARING APPAREL, NAMELY, T-SHIRTS, SHIRTS, PANTS AND SKIRTS (U.S. CLS. 22 AND 39).
SEAN CROWLEY, EXAMINING ATTORNEY

SN 77-129,851. E.S. ORIGINALS, INC., NEW YORK, NY.
FILED 3-13-2007.

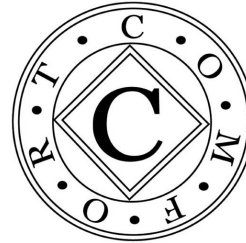

NO CLAIM IS MADE TO THE EXCLUSIVE RIGHT TO USE "COMFORT", APART FROM THE MARK AS SHOWN. THE MARK CONSISTS OF THE LETTER "C" IN A DIAMOND WITHIN A CIRCLE THAT CONTAINS THE WORD COMFORT AROUND THE CIRCUMFERENCE OF THE OUTER CIRCLE.

FOR FOOTWEAR (U.S. CLS. 22 AND 39).
INGA ERVIN, EXAMINING ATTORNEY

SN 77-132,263. MEYNARD DESIGNS INC., WALTHAM, MA.
FILED 3-15-2007.

A HIGHER CALLING

THE MARK CONSISTS OF STANDARD CHARACTERS WITHOUT CLAIM TO ANY PARTICULAR FONT, STYLE, SIZE, OR COLOR.

FOR FOOTWEAR AND APPAREL, NAMELY, T-SHIRTS, SWEATERS, PANTS, SHORTS, SKIRTS, JACKETS, DRESSES AND LOUNGEWEAR (U.S. CLS. 22 AND 39).

KIMBERLY PERRY, EXAMINING ATTORNEY

CLASS 25—(Continued).

SN 77-133,311. D.P.I. IMPORTS, INC., BAY SHORE, NY.
FILED 3-16-2007.

THERMA BY WEATHERPROOF

THE MARK CONSISTS OF STANDARD CHARACTERS WITHOUT CLAIM TO ANY PARTICULAR FONT, STYLE, SIZE, OR COLOR.

OWNER OF U.S. REG. NOS. 3,189,057 AND 3,192,099.

SEC. 2(F) AS TO WEATHERPROOF.

FOR CLOTHING NAMELY COATS, JACKETS, BELTS, GLOVES, HATS, CAPS, HOSIERY, JEANS, SWEAT SUITES, SWEATSHIRTS, SWEAT PANTS, NECKWEAR, PANTS, PARKAS, PONCHOS, SWEATERS, RAINCOATS, PAJAMAS, ROBES, SHIRTS, SOCKS, SHORT SUITS, SWIMSUITS, T-SHIRTS, UNDERWEAR, SCARVES, AND VESTS; FOOTWEAR (U.S. CLS. 22 AND 39).

TRACY WHITTAKER-BROWN, EXAMINING ATTORNEY

SN 77-133,542. XTREME COUTURE, INC., SIGNAL HILL, CA. FILED 3-16-2007.

XTREME COUTURE

THE MARK CONSISTS OF STANDARD CHARACTERS WITHOUT CLAIM TO ANY PARTICULAR FONT, STYLE, SIZE, OR COLOR.

NO CLAIM IS MADE TO THE EXCLUSIVE RIGHT TO USE "COUTURE", APART FROM THE MARK AS SHOWN.

FOR CLOTHING, NAMELY, SWEATSHIRTS, T-SHIRTS, TANK TOPS, SWEATPANTS, PANTS, SHORTS, TRUNKS, SOCKS, CAPS, FIGHTER'S ROBES, JACKETS, JOGGING SUITS, SWEAT SUITS, TRACK SUITS, KICK BOXING TROUSERS, BOXING SHORTS, POLO SHIRTS, CORNER MAN VESTS, BELTS, ARM BANDS, SPORTS BRAS, HEAD BANDS (U.S. CLS. 22 AND 39).

TANYA AMOS, EXAMINING ATTORNEY

CLASS 25—(Continued).

SN 77-138,947. MASCOTTE HOLDINGS, INC., NEW YORK, NY. FILED 3-23-2007.

THE PAST TELLS EVERYTHING

THE MARK CONSISTS OF STANDARD CHARACTERS WITHOUT CLAIM TO ANY PARTICULAR FONT, STYLE, SIZE, OR COLOR.

FOR CLOTHING, NAMELY, SHIRTS, T-SHIRTS, UNDER SHIRTS, NIGHT SHIRTS, RUGBY SHIRTS, POLO SHIRTS, CARDIGANS, JERSEYS, UNIFORMS, SCRUBS NOT FOR MEDICAL PURPOSES, SMOCKS, DRESS SHIRTS, PANTS, TROUSERS, SLACKS, JEANS, CULOTTES, CARGO PANTS, STRETCH PANTS, DENIM JEANS, OVERALLS, COVERALLS, JUMPERS, JUMP SUITS, SHORTS, BOXER SHORTS, TOPS, STRETCH TOPS, CROP TOPS, TANK TOPS, HALTER TOPS, SWEAT SHIRTS, SWEAT SHORTS, SWEAT PANTS, WRAPS, WARM-UP SUITS, JOGGING SUITS, TRACK SUITS, PLAY SUITS, BLOUSES, SKIRTS, DRESSES, GOWNS, SWEATERS, VESTS, FLEECE VESTS, PULLOVERS, SNOW SUITS, PARKAS, CAPES, ANORAKS, PONCHOS, JACKETS, REVERSIBLE JACKETS, SHELL JACKETS, COATS, HEAVY COATS, BLAZERS, SUITS, TURTLE-NECKS, CLOTH SKI BIBS, SWIMWEAR, BEACHWEAR, TENNIS WEAR, SURF WEAR, SKI WEAR, LAYETTES, INFANTWEAR, INFANTS SLEEPERS, BOOTIES, BABY BIBS NOT OF PAPER, CLOTH DIAPERS, CAPS, SWIM CAPS, BERETS, BEANIES, HATS, VISORS, HEADBANDS, WRIST BANDS, SWEAT BANDS, HEADWEAR, EAR MUFFS, APRONS, SCARVES, BANDANAS, BELTS, SUSPENDERS, NECKWEAR, TIES, NECKERCHIEFS, ASCOTS, UNDERWEAR, THERMAL UNDERWEAR, LONG UNDERWEAR, BRIEFS, SWIM AND BATHING TRUNKS, BRAS, SPORTS BRAS, BRASSIERES, BUSTIERS, CORSETS, PANTIES, THONGS, G-STRINGS, GARTERS AND GARTER BELTS, TEDDIES, GIRDLES, FOUNDATION GARMENTS, SINGLET, SOCKS, LOUNGEWEAR, ROBES, SMOCKS, UNDERCLOTHES, PAJAMAS, SLEEPWEAR, NIGHT GOWNS, LINGERIE, CAMISOLES, NEGLIGEEES, CHEMISES, CHEMISETTES, SLIPS, SARONGS, LEG WARMERS, HOSIERY, PANTY-HOSE, BODY STOCKINGS, KNEE HIGHS, LEGGINGS, TIGHTS, LEOTARDS, BODY SUITS, UNITARDS, BODY SHAPERS, GLOVES, MITTENS, RAINWEAR, FOOTWEAR, SHOES, SNEAKERS, BOOTS, GALOSHES, SANDALS, FLIP-FLOPS, AND SLIPPERS (U.S. CLS. 22 AND 39).

CHRISTOPHER OTT, EXAMINING ATTORNEY

SN 77-139,413. CARTER, RALPH, C, CYPRESS, CA. FILED 3-23-2007.

Duck Skinz
Like water off a ducks back

THE MARK CONSISTS OF STANDARD CHARACTERS WITHOUT CLAIM TO ANY PARTICULAR FONT, STYLE, SIZE, OR COLOR.

FOR JACKETS; SHIRTS; HATS (U.S. CLS. 22 AND 39).
DORITT L. CARROLL, EXAMINING ATTORNEY

CLASS 25—(Continued).

SN 77-140,450. DISNEY ENTERPRISES, INC., BURBANK, CA. FILED 3-26-2007.

IRIDESSA

THE MARK CONSISTS OF STANDARD CHARACTERS WITHOUT CLAIM TO ANY PARTICULAR FONT, STYLE, SIZE, OR COLOR.

FOR ATHLETIC SHOES; BANDANAS; BASEBALL CAPS; BEACH COVER-UPS; BEACHWEAR; BELTS; BIKINIS; BLAZERS; BOOTS; BOW TIES; BRAS; CAPS; CHAPS; CLOTH BIBS FOR BABIES; COATS; DRESSES; EAR MUFFS; FOOTWEAR; GLOVES; GOLF SHIRTS; HALLOWEEN COSTUMES; HATS; HEAD BANDS; HEAD WEAR; HOSIERY; INFANTWEAR; JACKETS; JEANS; JERSEYS; KERCHIEFS; LEOTARDS; LEG WARMERS; MITTENS; NECKTIES; NIGHT SHIRTS; NIGHT GOWNS; OVERALLS; PAJAMAS; PANTS; PANTY HOSE; POLO SHIRTS; PONCHOS; RAINWEAR; ROBES; SANDALS; SCARVES; SHIRTS; SHOES; SKIRTS; SHORTS; SLACKS; SLIPPERS; SLEEPWEAR; SOCKS; STOCKINGS; SWEATERS; SWEAT PANTS; SWEAT SHIRTS; SWIMSUITS; TANK TOPS; TIGHTS; T-SHIRTS; UNDERWEAR; VESTS; WRIST BANDS (U.S. CLS. 22 AND 39).

AMY BROZENIC, EXAMINING ATTORNEY

SN 77-140,451. 88 INTERNATIONAL, INC., ALHAMBRA, CA. FILED 3-26-2007.

PROJECT BY CARBON DENIM

THE MARK CONSISTS OF STANDARD CHARACTERS WITHOUT CLAIM TO ANY PARTICULAR FONT, STYLE, SIZE, OR COLOR.

OWNER OF U.S. REG. NO. 3,098,541.

NO CLAIM IS MADE TO THE EXCLUSIVE RIGHT TO USE "CARBON DENIM", APART FROM THE MARK AS SHOWN.

FOR CLOTHING MADE WHOLLY OR SIGNIFICANTLY IN PART OF DENIM, NAMELY WOMEN AND FEMALE CHILDREN'S JEANS, PANTS, SHORTS, OVERALLS, SKIRTS, JACKETS, VESTS AND SHIRTS (U.S. CLS. 22 AND 39).

KATHERINE STOIDES, EXAMINING ATTORNEY

SN 77-142,614. BARRY, KELLY K., PORTLAND, ME. FILED 3-28-2007.

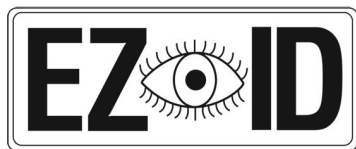

THE MARK CONSISTS OF IN PART, THE DEPICTION OF AN EYE.

FOR CLOTHING, NAMELY, VESTS (U.S. CLS. 22 AND 39).

CHRISIE B. KING, EXAMINING ATTORNEY

CLASS 25—(Continued).

SN 77-142,696. DAVIE, MIKE, LOS ANGELES, CA. FILED 3-28-2007.

JUST LIVING!

THE MARK CONSISTS OF STANDARD CHARACTERS WITHOUT CLAIM TO ANY PARTICULAR FONT, STYLE, SIZE, OR COLOR.

FOR CLOTHING, NAMELY SHIRTS, T-SHIRTS, PANTS, SKIRTS, BLOUSES, SHORTS, SWEATERS, SWEATSHIRTS, SWEATPANTS (U.S. CLS. 22 AND 39).

FIRST USE 10-1-2006; IN COMMERCE 10-1-2006.

KENNETH E. SHARPERSON, EXAMINING ATTORNEY

SN 77-142,712. SLOANE & TATE LLC, LOS ANGELES, CA. FILED 3-28-2007.

SLOANE & TATE

THE MARK CONSISTS OF STANDARD CHARACTERS WITHOUT CLAIM TO ANY PARTICULAR FONT, STYLE, SIZE, OR COLOR.

FOR CLOTHING, NAMELY INNERWEAR IN THE NATURE OF CAMISOLES AND BOXER BRIEFS; UNDERWEAR; UNDERSHIRTS; T-SHIRTS; SPORTSWEAR IN THE NATURE OF TANK TOPS; SLEEPWEAR; AND LINGERIE (U.S. CLS. 22 AND 39).

FIRST USE 7-0-2006; IN COMMERCE 1-0-2007.

MARK RADEMACHER, EXAMINING ATTORNEY

SN 77-146,711. JUDY HONG, MENIFEE, CA. FILED 4-2-2007.



THE MARK CONSISTS OF A STYLIZED GRAPHIC OF A JAPANESE WARRIOR HELMET FOLLOWED BY THE WORDS THE SHOGUN.

FOR COATS; DENIM JACKETS; DENIMS; DRESS SHIRTS; DRESSES; JERSEYS; MINISKIRTS; JUMPERS; KNIT SHIRTS; PAJAMAS; PANTS; POLO SHIRTS; PONCHOS; PULLOVERS; SHIRTS; SHORTS; SKIRTS; SKORTS; SLACKS; SPORT COATS; SPORT SHIRTS; SPORTS JACKETS; SPORTS SHIRTS; SUITS; SWEAT PANTS; SWEAT SHIRTS; SWEAT SHORTS; SWEAT SUITS; SWEATERS; T-SHIRTS; TANK TOPS; TANK-TOPS; TOP COATS; TOPCOATS; TRENCH COATS; TROUSERS; VESTS (U.S. CLS. 22 AND 39).

ALYSSA PALADINO, EXAMINING ATTORNEY

CLASS 25—(Continued).

SN 77-146,955. LAU, DAVID Y, WALNUT CREEK, CA. FILED 4-3-2007.

PILE  FACE

THE COLOR(S) BLACK, RED IS/ARE CLAIMED AS A FEATURE OF THE MARK.

THE MARK CONSISTS OF THE WORD "PILE" AND "FACE" ARE IN BLACK. THE WORD "OU" IS IN RED. THE LETTERS "O" AND "U" OVERLAPS EACH OTHER.

THE ENGLISH TRANSLATION OF THE FRENCH WORDING "PILE OU FACE" IS "HEADS OR TAILS."

FOR SCARVES; TANK TOPS; TOP COATS; TOPS; TIES; BLOUSES (U.S. CLS. 22 AND 39).

BENJAMIN OKEKE, EXAMINING ATTORNEY

CLASS 25—(Continued).

SN 77-147,966. FERGUSON, JAQUELINE RENEE, VISTA, CA. FILED 4-3-2007.



THE COLOR(S) BLACK, WHITE, PURPLE, RED AND BLUE IS/ARE CLAIMED AS A FEATURE OF THE MARK.

THE MARK CONSISTS OF A BLACK-OUTLINED SHOPPING BAG, WITH TWO BLACK HANDLES, CONTAINING THE WORDS PEACE LOVE AND SHOPPING IN WHITE LETTERING. SHOPPING BAG IS SHADES OF PURPLE. A SMALLER RECTANGLE IS INSIDE THE SHOPPING BAG. INSIDE THE SMALLER RECTANGLE IS A HEART SHAPE WITH A PEACE SIGN INSIDE OF IT. THE HEART AND PEACE SIGN ARE RED, BLACK, AND SHADES OF PURPLE. THE SPACE ON THE OUTSIDE OF THE HEART IS SHADES OF PURPLE AND WHITE.

FOR T-SHIRTS (U.S. CLS. 22 AND 39).

FIRST USE 2-26-2007; IN COMMERCE 2-27-2007.

CHRISIE B. KING, EXAMINING ATTORNEY

SN 77-147,474. VANITY FAIR, INC., BOWLING GREEN, KY. FILED 4-3-2007.

ORIGINAL SKIN ONE BRA
FEATHER-LIGHT

THE MARK CONSISTS OF STANDARD CHARACTERS WITHOUT CLAIM TO ANY PARTICULAR FONT, STYLE, SIZE, OR COLOR.

OWNER OF U.S. REG. NOS. 2,744,932 AND 2,837,167.

NO CLAIM IS MADE TO THE EXCLUSIVE RIGHT TO USE "BRA", APART FROM THE MARK AS SHOWN.

FOR HOSE; LINGERIE; SLEEPWEAR (U.S. CLS. 22 AND 39).

PAUL F. GAST, EXAMINING ATTORNEY

SN 77-148,649. DOOLAS DESIGNS, LLC, MANHATTAN BEACH, CA. FILED 4-4-2007.

Couture Chef

THE MARK CONSISTS OF STANDARD CHARACTERS WITHOUT CLAIM TO ANY PARTICULAR FONT, STYLE, SIZE, OR COLOR.

NO CLAIM IS MADE TO THE EXCLUSIVE RIGHT TO USE "CHEF", APART FROM THE MARK AS SHOWN.

FOR APRONS (U.S. CLS. 22 AND 39).

THOMAS MANOR, EXAMINING ATTORNEY

CLASS 25—(Continued).

SN 77-148,989. DADOURIAN, MICHAEL, REDFORD, MI.
FILED 4-4-2007.

CLASS 25—(Continued).

SN 77-149,685. CONDUCT HAPPINESS, INC., WOODLAND
HILLS, CA. FILED 4-5-2007.



So Crucial

THE MARK CONSISTS OF STANDARD CHARACTERS WITHOUT CLAIM TO ANY PARTICULAR FONT, STYLE, SIZE, OR COLOR.

FOR SHIRTS; CAMP SHIRTS; DRESS SHIRTS; GOLF SHIRTS; KNIT SHIRTS; NIGHT SHIRTS; OPEN-NECKED SHIRTS; PIQUE SHIRTS; POLO SHIRTS; SHIRT FRONTS; SHIRT YOKES; SHIRTS FOR SUITS; SHORT-SLEEVED OR LONG-SLEEVED T-SHIRTS; SHORT-SLEEVED SHIRTS; SLEEP SHIRTS; SPORT SHIRTS; SPORTS SHIRTS; SPORTS SHIRTS WITH SHORT SLEEVES; SWEAT SHIRTS; T-SHIRTS; WIND SHIRTS; YOGA SHIRTS; BALLOON PANTS; CAPRI PANTS; CARGO PANTS; DENIMS; JOGGING PANTS; LEATHER PANTS; NON-DISPOSABLE CLOTH TRAINING PANTS; NURSE PANTS; PANTS; PETTI-PANTS; SKI PANTS; SNOW PANTS; SNOWBOARD PANTS; SWEAT PANTS; TAP PANTS; TOBOGGAN HATS, PANTS AND CAPS; TRACK PANTS; WATERPROOF JACKETS AND PANTS; BRIEFS; DISPOSABLE UNDERWEAR; KNITTED UNDERWEAR; LADIES' UNDERWEAR; PARTS OF CLOTHING, NAMELY, GUSSETS FOR TIGHTS, GUSSETS FOR STOCKINGS, GUSSETS FOR BATHING SUITS, GUSSETS FOR UNDERWEAR, GUSSETS FOR LEOTARDS AND GUSSETS FOR FOOTLETS; PERSPIRATION ABSORBENT UNDERWEAR CLOTHING; THERMAL UNDERWEAR; THONGS; UNDERWEAR; WOMEN'S UNDERWEAR; WOVEN OR KNITTED UNDERWEAR; ANKLE SOCKS; ANKLETS; ANTI-PERSPIRANT SOCKS; JAPANESE STYLE SOCKS (TABI COVERS); JAPANESE STYLE SOCKS (TABI); MEN'S SOCKS; SOCK SUSPENDERS; SOCKS; SOCKS AND STOCKINGS; THERMAL SOCKS; WATER SOCKS; WOOLLEN SOCKS; CHEF'S HATS; FUR HATS; HAT BANDS; HATS; PAPER HATS FOR USE AS CLOTHING ITEMS; SEDGE HATS (SUGEGASA); SMALL HATS; WOOLLY HATS; ADHESIVE BRAS; BRAS; FITTED SWIMMING COSTUMES WITH BRA CUPS; SPORTS BRA; STRAPLESS BRAS; STRAPS FOR BRAS; BIKINIS; BOXER BRIEFS; BOXER SHORTS; BERMUDA SHORTS; BOARD SHORTS; FLEECE SHORTS; GYM SHORTS; PANTIES, SHORTS AND BRIEFS; RUGBY SHORTS; SHORT OVERCOAT FOR KIMONO (HAORI); SHORT PETTICOATS; SHORT SETS; SHORT TROUSERS; SHORTS; SLIDING SHORTS; SWEAT SHORTS; WALKING SHORTS; ATHLETIC UNIFORMS; MARTIAL ARTS UNIFORMS; SCHOOL UNIFORMS; UNIFORMS; BOOTIES (U.S. CLS. 22 AND 39).
KEVIN CORWIN, EXAMINING ATTORNEY

THE COLOR(S) RED, BLUE, BLACK, LIGHT BLUE, AND PINK IS/ARE CLAIMED AS A FEATURE OF THE MARK.

THE MARK CONSISTS OF LARGE STYLIZED WHITE LETTERS "C" AND "H" IN ABILENE FONT, PLACED INSIDE OF BLUE AND RED CIRCLES, RESPECTIVELY. BEHIND THE LARGE "C" AND "H" CIRCLES ARE BLACK RAILROAD TRACKS, CRISS-CROSSED WITH BLUE, LIGHT BLUE, PINK AND RED RAILROAD TIES. "CONDUCT HAPPINESS" APPEARS UNDERNEATH THE "C" AND "H" CIRCLES IN BLACK STYLIZED TYPE..

FOR KNIT SHIRTS; SHIRTS; SHORT-SLEEVED OR LONG-SLEEVED T-SHIRTS; SLEEP SHIRTS; SWEAT SHIRTS; TANK TOPS; JACKETS; PANTIES, SHORTS AND BRIEFS; SHORTS; SKIRTS; SWEAT SHORTS; PANTS; SWEAT PANTS; HATS; SCARVES; BEANIES; BRAS; SOCKS; ROMPERS (U.S. CLS. 22 AND 39).
FIRST USE 10-1-2004; IN COMMERCE 10-1-2004.

RONALD MCMORROW, EXAMINING ATTORNEY

SN 77-151,545. BAMBOULA 8, LLC, ANNAPOLIS, MD.
FILED 4-9-2007.

Reggae Royalty

THE MARK CONSISTS OF STANDARD CHARACTERS WITHOUT CLAIM TO ANY PARTICULAR FONT, STYLE, SIZE, OR COLOR.

NO CLAIM IS MADE TO THE EXCLUSIVE RIGHT TO USE "REGGAE", APART FROM THE MARK AS SHOWN.

FOR SHORT-SLEEVED OR LONG-SLEEVED T-SHIRTS; POLO SHIRTS; SWEAT BANDS; SWEAT PANTS; SWEAT SHIRTS; SWEAT SHORTS; HEADBANDS AGAINST SWEATING; BERMUDA SHORTS; BOARD SHORTS; BOXER SHORTS; GYM SHORTS; PANTIES, SHORTS AND BRIEFS; RUGBY SHORTS; SHORTS; SKIRTS AND DRESSES; SOCKS; PANTS (U.S. CLS. 22 AND 39).
ANGELA GAW, EXAMINING ATTORNEY

CLASS 25—(Continued).

SN 77-151,862. CLARK KARL E, WHITE LAKE, MI. FILED 4-9-2007.



THE COLOR(S) RED, WHITE, BLACK, YELLOW, GREY IS/ARE CLAIMED AS A FEATURE OF THE MARK.

THE MARK CONSISTS OF THE COLOR YELLOW IN THE CENTER TRIANGLE. ALL THE FOLLOWING WORDS, PRAISE, PRAYER, PROSPERITY, TRUE AND BELIEVERS ON THE OUTER EDGES OF THE TRIANGLE AND OUTSIDE THE CIRCLE ARE LINED IN BLACK AND ARE FILLED WITH RED. BOTH LETTER T & B IN THE CENTER OF THE TRIANGLE ARE LINED IN BLACK AND FILLED WITH RED. THE TRIANGLE AND THE CIRCLE THAT ENCIRCLES THE TRIANGLE HAVE A BLACK OUTER EDGE WITH A GREY AND WHITE COLOR FILLING.

FOR SLEEPWEAR; JACKETS; SHIRTS (U.S. CLS. 22 AND 39).

MICHAEL LITZAU, EXAMINING ATTORNEY

SN 77-152,377. RANG, ULLA CAMILLA, DEL MAR, CA. FILED 4-9-2007.

A Viking's Joy

THE MARK CONSISTS OF STANDARD CHARACTERS WITHOUT CLAIM TO ANY PARTICULAR FONT, STYLE, SIZE, OR COLOR.

FOR BUTTON-FRONT ALOHA SHIRTS; CAMP SHIRTS; DRESS SHIRTS; GOLF SHIRTS; KNIT SHIRTS; NIGHT SHIRTS; OPEN-NECKED SHIRTS; PIQUE SHIRTS; POLO SHIRTS; SHIRT FRONTS; SHIRT YOKES; SHIRTS; SHIRTS FOR SUITS; SHORT-SLEEVED OR LONG-SLEEVED T-SHIRTS; SHORT-SLEEVED SHIRTS; SLEEP SHIRTS; SPORT SHIRTS; SPORTS SHIRTS; SPORTS SHIRTS WITH SHORT SLEEVES; SWEAT SHIRTS; T-SHIRTS; WIND SHIRTS; YOGA SHIRTS (U.S. CLS. 22 AND 39).

FIRST USE 4-1-2007; IN COMMERCE 4-1-2007.
LOURDES AYALA, EXAMINING ATTORNEY

CLASS 25—(Continued).

SN 77-152,769. PETERS, BARBARA S., CROZET, VA. FILED 4-10-2007.

THE CAMISOIL

THE MARK CONSISTS OF STANDARD CHARACTERS WITHOUT CLAIM TO ANY PARTICULAR FONT, STYLE, SIZE, OR COLOR.

FOR BIB-LIKE ARTICLE OF CLOTHING, NOT OF PAPER, DESIGNED TO PROTECT CLOTHES FROM STAINS (U.S. CLS. 22 AND 39).

ROSELLE HERRERA, EXAMINING ATTORNEY

SN 77-153,310. LIPTON, FERROL K., NY, NY. FILED 4-10-2007.

Royal Drama

THE MARK CONSISTS OF STANDARD CHARACTERS WITHOUT CLAIM TO ANY PARTICULAR FONT, STYLE, SIZE, OR COLOR.

FOR T-SHIRTS (U.S. CLS. 22 AND 39).

REBECCA EISINGER, EXAMINING ATTORNEY

SN 77-153,350. ASTRUM, LLC, LAS VEGAS, NV. FILED 4-10-2007.

ASTRUM RECORDS

THE MARK CONSISTS OF STANDARD CHARACTERS WITHOUT CLAIM TO ANY PARTICULAR FONT, STYLE, SIZE, OR COLOR.

THE ENGLISH TRANSLATION OF "ASTRUM" IS "STAR" OR "CONSTELLATION".

FOR CLOTHING AND CLOTHING ACCESSORIES, NAMELY, HEADWEAR, COATS, JACKETS, JERSEYS, SHIRTS, T-SHIRTS, POLO SHIRTS, PANTS, SWEATERS, SWEATSHIRTS, SWEATPANTS, PULLOVERS, TANK TOPS AND VESTS (U.S. CLS. 22 AND 39).

REBECCA EISINGER, EXAMINING ATTORNEY

CLASS 25—(Continued).

SN 77-153,429. BING KAVEY INC., RICHMOND, CA. FILED 4-10-2007.

Love Polly

THE MARK CONSISTS OF STANDARD CHARACTERS WITHOUT CLAIM TO ANY PARTICULAR FONT, STYLE, SIZE, OR COLOR.

FOR TROUSERS; TUNICS; VESTS; WAISTCOATS; SKIRTS; SWEATERS; T-SHIRTS; PANTS; PULLOVERS; JACKETS; COATS; DRESSES; BLAZERS; BLOUSES; BOTTOMS; CARDIGANS (U.S. CLS. 22 AND 39).

FIRST USE 8-0-2005; IN COMMERCE 8-0-2005.
KAPIL BHANOT, EXAMINING ATTORNEY

SN 77-153,567. SECURITY SOURCING INTERNATIONAL, INC., LOS ANGELES, CA. FILED 4-10-2007.

TWIN FIN

THE MARK CONSISTS OF STANDARD CHARACTERS WITHOUT CLAIM TO ANY PARTICULAR FONT, STYLE, SIZE, OR COLOR.

FOR CLOTHING, NAMELY BLOUSES, DRESSES, JACKETS, JEANS, JERSEYS, PANTS, SHIRTS, SHORTS, SKIRTS, SWEAT PANTS, SWEAT SHIRTS, SWEATERS, T-SHIRTS, AND TANK TOPS (U.S. CLS. 22 AND 39).

DAVID HOFFMAN, EXAMINING ATTORNEY

SN 77-153,572. SECURITY SOURCING INTERNATIONAL, INC., LOS ANGELES, CA. FILED 4-10-2007.

1457

THE MARK CONSISTS OF STANDARD CHARACTERS WITHOUT CLAIM TO ANY PARTICULAR FONT, STYLE, SIZE, OR COLOR.

FOR CLOTHING, NAMELY, BLOUSES, DRESSES, JACKETS, JEANS, JERSEYS, PANTS, SHIRTS, SHORTS, SKIRTS, SWEAT PANTS, SWEAT SHIRTS, SWEATERS, T-SHIRTS, AND TANK TOPS (U.S. CLS. 22 AND 39).

DAVID HOFFMAN, EXAMINING ATTORNEY

CLASS 25—(Continued).

SN 77-153,593. QUYSCAAEE CLOTHING COMPANY, NEWPORT NEWS, VA. FILED 4-11-2007.

Quyscaae

THE MARK CONSISTS OF STANDARD CHARACTERS WITHOUT CLAIM TO ANY PARTICULAR FONT, STYLE, SIZE, OR COLOR.

FOR SHIRTS, PANTS, HATS, SHOES, JACKETS, SWEAT SUITS, SKIRTS, DRESSES (U.S. CLS. 22 AND 39).
RUSS HERMAN, EXAMINING ATTORNEY

SN 77-153,831. LEONE, ANTHONY, EL CAJON, CA. FILED 4-11-2007.

all out brawl

THE MARK CONSISTS OF STANDARD CHARACTERS WITHOUT CLAIM TO ANY PARTICULAR FONT, STYLE, SIZE, OR COLOR.

FOR BATHING SUITS; BEANIES; BOARD SHORTS; HATS; MARTIAL ARTS UNIFORMS; PANTS; SHIRTS; SHOES; SHORT-SLEEVED OR LONG-SLEEVED T-SHIRTS; SHORTS; SWEATERS (U.S. CLS. 22 AND 39).

MATTHEW PAPPAS, EXAMINING ATTORNEY

SN 77-154,521. LIMA, MICHAEL, MENIFEE, CA. FILED 4-11-2007.



THE MARK CONSISTS OF "#1 DADDY" WHERE "#1" IS ON A FLAG AND THE FIRST "D" AND THE "Y" ARE GOLF CLUBS.

FOR GOLF CLOTHING AND APPAREL, NAMELY POLO SHIRTS, TEE SHIRTS, SWEAT SHIRTS, SWEATERS, JACKETS, HATS, SHORTS AND PANTS; AND BABY CLOTHING, NAMELY INFANT AND TODDLER ONE PIECE CLOTHING, TEE SHIRTS AND CLOTH BIBS (U.S. CLS. 22 AND 39).

TANYA AMOS, EXAMINING ATTORNEY

CLASS 25—(Continued).

SN 77-154,597. G RECORDS, LAS VEGAS, NV. FILED 4-11-2007.

G MUSIC

THE MARK CONSISTS OF STANDARD CHARACTERS WITHOUT CLAIM TO ANY PARTICULAR FONT, STYLE, SIZE, OR COLOR.

OWNER OF U.S. REG. NOS. 2,771,589 AND 3,003,956.

NO CLAIM IS MADE TO THE EXCLUSIVE RIGHT TO USE "MUSIC", APART FROM THE MARK AS SHOWN.

FOR FIGURE SKATING CLOTHING, NAMELY, SHIRTS, T SHIRTS, SWEAT SHIRTS, UNDER SHIRTS, TANK TOPS, JERSEYS, COATS, JACKETS, CAPS, AND HEAD WEAR (U.S. CLS. 22 AND 39).

FIRST USE 11-0-2003; IN COMMERCE 12-0-2003.

BRENDAN REGAN, EXAMINING ATTORNEY

CLASS 25—(Continued).

SN 77-154,916. REINHOLD LANG LLC, MIDDLEBURG, VA. FILED 4-12-2007.

REINHOLD LANG

THE MARK CONSISTS OF STANDARD CHARACTERS WITHOUT CLAIM TO ANY PARTICULAR FONT, STYLE, SIZE, OR COLOR.

THE NAME(S), PORTRAIT(S), AND/OR SIGNATURE(S) SHOWN IN THE MARK DOES NOT IDENTIFY A PARTICULAR LIVING INDIVIDUAL.

FOR CLOTHING, NAMELY, TEE SHIRTS, SHIRTS, SWEATERS, PANTS, JEANS, JACKETS, COATS, SCARVES, TIES, UNDERGARMENTS, HATS AND FOOTWEAR (U.S. CLS. 22 AND 39).

FIRST USE 4-1-2007; IN COMMERCE 4-1-2007.

LEE-ANNE BERNS, EXAMINING ATTORNEY

SN 77-154,831. CASTLESTARR LLC, NEW YORK, NY. FILED 4-12-2007.

BRUNYA

THE MARK CONSISTS OF STANDARD CHARACTERS WITHOUT CLAIM TO ANY PARTICULAR FONT, STYLE, SIZE, OR COLOR.

FOR CLOTHING, NAMELY, DRESSES, SKIRTS, COATS, RAIN COATS, JACKETS, JEANS, PANTS, T-SHIRTS, SHIRTS, SUITS, BLOUSES, SWEAT SUITS, HATS, SCARVES, UNDERWEAR, BELTS, AND, FOOTWEAR (U.S. CLS. 22 AND 39).

FIRST USE 4-1-2007; IN COMMERCE 4-1-2007.

MICHAEL LEWIS, EXAMINING ATTORNEY

SN 77-154,945. CURE COUTURE INC., HUNTINGTON BEACH, CA. FILED 4-12-2007.

C U R E

 C O U T U R E

NO CLAIM IS MADE TO THE EXCLUSIVE RIGHT TO USE "COUTURE", APART FROM THE MARK AS SHOWN.

THE MARK CONSISTS OF THE WORDS CURE COUTURE WITH A STYLIZED EGYPTIAN ANKH IN THE MIDDLE.

FOR HATS; JACKETS; PAJAMAS; T-SHIRTS; TANK TOPS; SWEAT SHIRTS (U.S. CLS. 22 AND 39).

STEVEN PEREZ, EXAMINING ATTORNEY

SN 77-154,851. TOP LINE SCREEN PRINTING AND EMBROIDERY, INC., ORLANDO, FL. FILED 4-12-2007.

RED LAUNDRY

THE MARK CONSISTS OF STANDARD CHARACTERS WITHOUT CLAIM TO ANY PARTICULAR FONT, STYLE, SIZE, OR COLOR.

FOR SHORT-SLEEVED OR LONG-SLEEVED T-SHIRTS (U.S. CLS. 22 AND 39).

ESTHER BELENKER, EXAMINING ATTORNEY

SN 77-155,152. FITZPATRICK, KRISTINE, DIX HILLS, NY. FILED 4-12-2007.

Fitz-Band

THE MARK CONSISTS OF STANDARD CHARACTERS WITHOUT CLAIM TO ANY PARTICULAR FONT, STYLE, SIZE, OR COLOR.

FOR HEADBANDS (U.S. CLS. 22 AND 39).

ROBERT C. CLARK JR., EXAMINING ATTORNEY

CLASS 25—(Continued).

SN 77-155,245. SEBASTIAN RESOURCING INTL. LLC, NEW YORK, NY. FILED 4-12-2007.

NATURAL STUFF

THE MARK CONSISTS OF STANDARD CHARACTERS WITHOUT CLAIM TO ANY PARTICULAR FONT, STYLE, SIZE, OR COLOR.

NO CLAIM IS MADE TO THE EXCLUSIVE RIGHT TO USE "NATURAL", APART FROM THE MARK AS SHOWN.

FOR CLOTHING FOR MEN, WOMEN AND CHILDREN, NAMELY SHIRTS, TOPS, TROUSERS, JACKETS, SWEATERS, JUMP SUITS, T-SHIRTS AND UNDERWEAR, ALL COMPOSED IN WHOLE OR IN PART OF NATURAL FIBERS OR FABRICS (U.S. CLS. 22 AND 39).
CURTIS FRENCH, EXAMINING ATTORNEY

SN 77-155,734. ALFRED, KAREEM A., BRONX, NY. FILED 4-12-2007.

AMERICAN INJUNCTION

THE MARK CONSISTS OF STANDARD CHARACTERS WITHOUT CLAIM TO ANY PARTICULAR FONT, STYLE, SIZE, OR COLOR.

NO CLAIM IS MADE TO THE EXCLUSIVE RIGHT TO USE "AMERICAN", APART FROM THE MARK AS SHOWN.

FOR SHIRTS; PANTS; HATS; SOCKS; JEANS; BOXER SHORTS (U.S. CLS. 22 AND 39).

BENJAMIN OKEKE, EXAMINING ATTORNEY

CLASS 25—(Continued).

SN 77-156,147. CLARK, STANLEY K., STILLWATER, OK. FILED 4-13-2007.



OWNER OF U.S. REG. NOS. 1,461,454 AND 1,501,689.

NO CLAIM IS MADE TO THE EXCLUSIVE RIGHT TO USE "STILLWATER, OKLAHOMA", APART FROM THE MARK AS SHOWN.

THE MARK CONSISTS OF THE STYLIZED WORDS "ESKIMO JOE'S STILLWATER, OK." SURROUNDING A CIRCLE CONTAINING THE CHARACTERS JOE AND DOG BUFFY.

FOR CLOTHING, SPORTS CLOTHING APPAREL AND OUTERWEAR, NAMELY, T-SHIRTS, SHIRTS, SPORTS SHIRTS, GOLF SHIRTS, TANK TOPS, POLO SHIRTS, RUGBY SHIRTS, SWEATERS, VESTS, SWEATSHIRTS, JERSEYS, TURTLENECKS, JACKETS, PANTS, JEANS, SWEATPANTS, SHORTS, GYM SHORTS, PLASTIC BABY BIBS, HATS, CAPS, VISORS, BLAZERS, NECKTIES, LEATHER COATS, RAIN COATS, RAIN PONCHOS, WIND RESISTANT JACKETS AND PANTS, WARMUP SUITS, GLOVES, MITTENS, EAR MUFFS, HATS, CAPS, VISORS, BANDANNAS, SCARVES, BELTS, SUSPENDERS, ATHLETIC UNIFORMS, ATHLETIC SNEAKERS, SANDALS, SOCKS, HOSIERY, LEOTARDS, APRONS, WRIST BANDS, BATHING CAPS, BATHING SUITS, BATHING TRUNKS, BATHROBES, INFANT WEAR, CLOTH BIBS, CREEPERS, BOOTIES, GOLF SHIRTS, NIGHT SHIRTS, NIGHTIES, SLEEPWEAR, BOXER SHORTS AND FOOTWEAR (U.S. CLS. 22 AND 39).

FIRST USE 7-21-1975; IN COMMERCE 7-21-1975.

JEFF DEFORD, EXAMINING ATTORNEY

SN 77-156,183. WINGERIZE IT, INC., FOLSOM, CA. FILED 4-13-2007.

Cinch-Eaze Waistbands

THE MARK CONSISTS OF STANDARD CHARACTERS WITHOUT CLAIM TO ANY PARTICULAR FONT, STYLE, SIZE, OR COLOR.

NO CLAIM IS MADE TO THE EXCLUSIVE RIGHT TO USE "WAISTBANDS", APART FROM THE MARK AS SHOWN.

FOR WAISTBANDS (U.S. CLS. 22 AND 39).

ADA HAN, EXAMINING ATTORNEY

CLASS 25—(Continued).

SN 77-156,791. CHACO, INC., PAONIA, CO. FILED 4-13-2007.

FLIP

THE MARK CONSISTS OF STANDARD CHARACTERS WITHOUT CLAIM TO ANY PARTICULAR FONT, STYLE, SIZE, OR COLOR.

FOR FOOTWEAR, NAMELY, SANDALS (U.S. CLS. 22 AND 39).

FIRST USE 6-30-2003; IN COMMERCE 6-30-2003.
ALICE BENMAMAN, EXAMINING ATTORNEY

SN 77-156,793. CHACO, INC., PAONIA, CO. FILED 4-13-2007.

HIPTHONG

THE MARK CONSISTS OF STANDARD CHARACTERS WITHOUT CLAIM TO ANY PARTICULAR FONT, STYLE, SIZE, OR COLOR.

FOR FOOTWEAR, NAMELY, SANDALS (U.S. CLS. 22 AND 39).

FIRST USE 6-30-2005; IN COMMERCE 6-30-2005.
ALICE BENMAMAN, EXAMINING ATTORNEY

SN 77-156,799. CHACO, INC., PAONIA, CO. FILED 4-13-2007.

LATITUDE

THE MARK CONSISTS OF STANDARD CHARACTERS WITHOUT CLAIM TO ANY PARTICULAR FONT, STYLE, SIZE, OR COLOR.

FOR FOOTWEAR, NAMELY, SANDALS (U.S. CLS. 22 AND 39).

FIRST USE 6-30-2006; IN COMMERCE 6-30-2006.
ALICE BENMAMAN, EXAMINING ATTORNEY

CLASS 25—(Continued).

SN 77-156,830. ROTHERT, JEAN L., EASTON, MD. FILED 4-14-2007.

Cape Kid

THE MARK CONSISTS OF STANDARD CHARACTERS WITHOUT CLAIM TO ANY PARTICULAR FONT, STYLE, SIZE, OR COLOR.

NO CLAIM IS MADE TO THE EXCLUSIVE RIGHT TO USE "KID", APART FROM THE MARK AS SHOWN.

FOR CHILDREN'S AND INFANTS' CLOTH BIBS; INFANT AND TODDLER ONE PIECE CLOTHING (U.S. CLS. 22 AND 39).

CHARLES L. JENKINS, EXAMINING ATTORNEY

SN 77-156,953. HOLMAN, REX E, NEW ALBANY DR, OH. FILED 4-14-2007.



THE MARK CONSISTS OF STYLIZED LETTERS T AND A. TWO STYLIZED FISTS AT OPPOSITE ENDS OF EACH OTHER. THE FISTS RESEMBLE AN O AND THE YIN AND YANG.

FOR BOARD SHORTS; HATS; PANTIES, SHORTS AND BRIEFS; SHIRTS; SHORTS; SWEAT PANTS; SWEAT SHIRTS; T-SHIRTS (U.S. CLS. 22 AND 39).

ANGELA M. MICHELI, EXAMINING ATTORNEY

SN 77-156,958. HOLLINGSWORTH, SUSAN, NATCHEZ, MS. FILED 4-14-2007.



THE MARK CONSISTS OF THE WORD "SUKAZ," WRITTEN IN HIGHLY STYLIZED LETTERS, AND INCLUDES A SMALL STAR UNDER THE LETTER "K" NEAR THE BOTTOM OF THE MARK.

FOR MEN AND WOMEN JACKETS, COATS, TROUSERS, VESTS; JACKETS (U.S. CLS. 22 AND 39).

FIRST USE 0-0-2006; IN COMMERCE 0-0-2006.

ANGELA M. MICHELI, EXAMINING ATTORNEY

CLASS 25—(Continued).

SN 77-156,983. DAVID AMBOS, KEY WEST, FL. FILED 4-15-2007.

PIRATE DOG

THE MARK CONSIST OF THE WORDS PIRATE DOG IN THE WINDLASS FONT.

FOR DRESS SHIRTS; OPEN-NECKED SHIRTS; PIQUE SHIRTS; POLO SHIRTS; SHIRT FRONTS; SHORT-SLEEVED OR LONG-SLEEVED T-SHIRTS; SHORT-SLEEVED SHIRTS; SWEAT SHIRTS; T-SHIRTS (U.S. CLS. 22 AND 39).

JULIE THOMAS, EXAMINING ATTORNEY

SN 77-157,006. MCDUGALD, ZHIPI, THOUSAND OAKS, CA. FILED 4-15-2007.

Here comes the Tee

THE MARK CONSISTS OF TEXT IN THE FONT OF MA SEXY.

FOR SHORT-SLEEVED OR LONG-SLEEVED T-SHIRTS; SLEEP SHIRTS; SWEAT SHIRTS; TANK TOPS; TOPS; TUBE TOPS; HATS; SHORTS; PAJAMAS (U.S. CLS. 22 AND 39).

PAMELA HIRSCHMAN, EXAMINING ATTORNEY

SN 77-157,313. PEERLESS DELAWARE, INC., ST. ALBANS, VT. FILED 4-16-2007.

OAKLOOM

THE MARK CONSISTS OF STANDARD CHARACTERS WITHOUT CLAIM TO ANY PARTICULAR FONT, STYLE, SIZE, OR COLOR.

OWNER OF U.S. REG. NO. 643,305.

FOR MEN'S OUTER CLOTHING, NAMELY, MEN'S SUITS COMPRISING COATS, PANTS AND VESTS, KNICKERS, TOP COATS AND OVERCOATS (U.S. CLS. 22 AND 39).

FIRST USE 10-0-1935; IN COMMERCE 10-0-1935.

JOHN GARTNER, EXAMINING ATTORNEY

CLASS 25—(Continued).

SN 77-157,393. MEDINA, ROBERT, CASTLE ROCK, CO. FILED 4-16-2007.

SASYN

THE MARK CONSISTS OF STANDARD CHARACTERS WITHOUT CLAIM TO ANY PARTICULAR FONT, STYLE, SIZE, OR COLOR.

FOR MEN'S, WOMEN'S AND CHILDREN'S CLOTHING, NAMELY, SKI GLOVES, SKI HATS, SKI EAR WARMERS/HEADBANDS, SKI JACKETS, SKI PANTS, MITTENS, SCARVES, VESTS, GLOVES, BEANIES, HATS, VISORS, JACKETS, PANTS, SHIRTS, T-SHIRTS, POLO SHIRTS, SWEAT SHIRTS, RAIN JACKETS AND WIND RESISTANT JACKETS (U.S. CLS. 22 AND 39).

KATHLEEN M. VANSTON, EXAMINING ATTORNEY

SN 77-157,447. BALBOA MANUFACTURING COMPANY, LLC, POWAY, CA. FILED 4-16-2007.



THE MARK CONSISTS OF A PROFILE WITH THE WORD "ZAN" ACROSS THE HEAD OF THE PROFILE.

FOR BANDANAS; CAP VISORS; CAPS; HATS; HEADBANDS; SHIRTS; SKIRTS; PANTS; SWIMSUITS; SKI MASKS (U.S. CLS. 22 AND 39).

FIRST USE 2-28-1997; IN COMMERCE 2-28-1997.

LAURA HAMMEL, EXAMINING ATTORNEY

SN 77-157,471. PARTNERS IN PAJAMAS, ALTADENA, CA. FILED 4-16-2007.

Pajamas of the Month

THE MARK CONSISTS OF STANDARD CHARACTERS WITHOUT CLAIM TO ANY PARTICULAR FONT, STYLE, SIZE, OR COLOR.

NO CLAIM IS MADE TO THE EXCLUSIVE RIGHT TO USE PAJAMAS, APART FROM THE MARK AS SHOWN. FOR PAJAMAS (U.S. CLS. 22 AND 39).

KATHLEEN M. VANSTON, EXAMINING ATTORNEY

CLASS 25—(Continued).

SN 77-157,501. HOANG, CAM CHAU, IRVINE, CA. FILED 4-16-2007.

SIMPLY PROVOCATIVE

THE MARK CONSISTS OF STANDARD CHARACTERS WITHOUT CLAIM TO ANY PARTICULAR FONT, STYLE, SIZE, OR COLOR.

FOR CLOTHING, NAMELY, LINGERIE (U.S. CLS. 22 AND 39).

RENEE SERVANCE, EXAMINING ATTORNEY

SN 77-157,709. MORRISON, SCOTT, ALEXANDRIA, VA. FILED 4-16-2007.

phat assets

THE MARK CONSISTS OF STANDARD CHARACTERS WITHOUT CLAIM TO ANY PARTICULAR FONT, STYLE, SIZE, OR COLOR.

FOR ANGLERS' SHOES; APRES-SKI SHOES; ATHLETIC SHOES; BALLET SHOES; BASEBALL SHOES; BEACH SHOES; BOWLING SHOES; BOXING SHOES; BUTTON-FRONT ALOHA SHIRTS; CAMP SHIRTS; CANVAS SHOES; CHEF'S HATS; CLEATS FOR ATTACHMENT TO SPORTS SHOES; CYCLING SHOES; DECK SHOES; DRESS SHIRTS; DRIVERS; FOOTBALL SHOES; FUR HATS; GOLF SHIRTS; GOLF SHOES; GYMNASTIC SHOES; HANDBALL SHOES; HAT BANDS; HATS; HEADWEAR, NAMELY, HATS, CAPS, BONNETS AND HEAD SCARVES; HEEL PIECES FOR SHOES; HOCKEY SHOES; INFANTS' SHOES AND BOOTS; INSOLES; KNIT SHIRTS; LEATHER SHOES; NIGHT SHIRTS; OPEN-NECKED SHIRTS; PAPER HATS FOR USE AS CLOTHING ITEMS; PIQUE SHIRTS; POLO SHIRTS; PROTECTIVE METAL MEMBERS FOR SHOES AND BOOTS; RUBBER SHOES; RUGBY SHOES; RUNNING SHOES; SEDGE HATS (SUGE-GASA); SHIRT FRONTS; SHIRT YOKES; SHIRTS; SHIRTS FOR SUITS; SHOE DOWELS; SHOE INSERTS FOR PRIMARILY NON-ORTHOPEDIC PURPOSES; SHOE PEGS; SHOE SOLES; SHOES; SHOES SOLES FOR REPAIR; SHORT-SLEEVED OR LONG-SLEEVED T-SHIRTS; SHORT-SLEEVED SHIRTS; SKI AND SNOWBOARD SHOES AND PARTS THEREOF; SKIING SHOES; SLEEP SHIRTS; SMALL HATS; SOCCER SHOES; SPORT SHIRTS; SPORTS SHIRTS; SPORTS SHIRTS WITH SHORT SLEEVES; SWEAT SHIRTS; T-SHIRTS; TAP SHOES; TENNIS SHOES; TOBOGGAN HATS, PANTS AND CAPS; TONGUE OR PULLSTRAP FOR SHOES AND BOOTS; TRACK AND FIELD SHOES; TRAINING SHOES; VOLLEYBALL SHOES; WIND SHIRTS; WOMEN'S SHOES; WOOLLY HATS; WORK SHOES AND BOOTS; YOGA SHIRTS (U.S. CLS. 22 AND 39).

JAMES LOVELACE, EXAMINING ATTORNEY

CLASS 25—(Continued).

SN 77-157,745. JAMHOUR, QASEM, MIAMI, FL. FILED 4-16-2007.

URBAN SOURCES

THE MARK CONSISTS OF STANDARD CHARACTERS WITHOUT CLAIM TO ANY PARTICULAR FONT, STYLE, SIZE, OR COLOR.

FOR BALLOON PANTS; BERMUDA SHORTS; BOARD SHORTS; BOXER SHORTS; CAPRI PANTS; CARGO PANTS; DENIMS; FLEECE SHORTS; GYM SHORTS; JOGGING PANTS; LEATHER PANTS; NURSE PANTS; PANTIES, SHORTS AND BRIEFS; PANTS; POLO SHIRTS; RUGBY SHORTS; SHORT SETS; SHORT TROUSERS; SHORT-SLEEVED OR LONG-SLEEVED T-SHIRTS; SHORT-SLEEVED SHIRTS; SHORTS; SPORTS SHIRTS WITH SHORT SLEEVES; SWEAT PANTS; SWEAT SHORTS; TOBOGGAN HATS, PANTS AND CAPS; TRACK PANTS; WALKING SHORTS; WATERPROOF JACKETS AND PANTS (U.S. CLS. 22 AND 39).

CARYN GLASSER, EXAMINING ATTORNEY

SN 77-157,780. ANTHONY HANSON, MIAMI, FL. FILED 4-16-2007.

EQUIP UNITED

THE MARK CONSISTS OF STANDARD CHARACTERS WITHOUT CLAIM TO ANY PARTICULAR FONT, STYLE, SIZE, OR COLOR.

FOR BALLOON PANTS; BED JACKETS; BERMUDA SHORTS; BOARD SHORTS; BOXER SHORTS; CAPRI PANTS; CARGO PANTS; DENIM JACKETS; DENIMS; DOWN JACKETS; FISHERMEN'S JACKETS; FLEECE SHORTS; FUR COATS AND JACKETS; FUR JACKETS; GYM SHORTS; HEAVY JACKETS; JACKET LINERS; JOGGING PANTS; LEATHER JACKETS; LEATHER PANTS; LIGHT-REFLECTING JACKETS; LONG JACKETS; MEN AND WOMEN JACKETS, COATS, TROUSERS, VESTS; NON-DISPOSABLE CLOTH TRAINING PANTS; NURSE PANTS; PANTIES, SHORTS AND BRIEFS; PANTS; PETTI-PANTS; POLO SHIRTS; RAIN JACKETS; RAINPROOF JACKETS; RUGBY SHORTS; SHORT OVERCOAT FOR KIMONO (HAORI); SHORT PETTI-COATS; SHORT SETS; SHORT TROUSERS; SHORT-SLEEVED OR LONG-SLEEVED T-SHIRTS; SHORT-SLEEVED SHIRTS; SHORTS; SKI JACKETS; SKI PANTS; SNOW PANTS; SNOWBOARD PANTS; SPORTS JACKETS; SPORTS SHIRTS WITH SHORT SLEEVES; STUFF JACKETS; SUEDE JACKETS; SWEAT PANTS; SWEAT SHORTS; TAP PANTS; TOBOGGAN HATS, PANTS AND CAPS; TRACK PANTS; WALKING SHORTS; WATERPROOF JACKETS AND PANTS; WIND RESISTANT JACKETS; WIND-JACKETS; YOGA PANTS (U.S. CLS. 22 AND 39).

MICHAEL LITZAU, EXAMINING ATTORNEY

CLASS 25—(Continued).

SN 77-157,828. KAMINER, DANNY, JERICO, NY. FILED 4-16-2007.

Meyeworld

THE MARK CONSISTS OF STANDARD CHARACTERS WITHOUT CLAIM TO ANY PARTICULAR FONT, STYLE, SIZE, OR COLOR.

FOR FOOTWEAR, NAMELY, FOOTWEAR MADE FROM ORGANIC AND SUSTAINABLE MATERIALS, SLIPPERS, FLIP-FLOPS, WATER SHOES, CHILDREN'S SHOES, CANVAS AND ATHLETIC SHOES, COSTUME SHOES (U.S. CLS. 22 AND 39).

MATTHEW MCDOWELL, EXAMINING ATTORNEY

SN 77-157,839. KAMINER, DANNY, JERICO, NY. FILED 4-16-2007.

Meye

THE MARK CONSISTS OF STANDARD CHARACTERS WITHOUT CLAIM TO ANY PARTICULAR FONT, STYLE, SIZE, OR COLOR.

FOR FOOTWEAR, NAMELY, FOOTWEAR MADE FROM ORGANIC AND SUSTAINABLE MATERIALS, SLIPPERS, FLIP-FLOPS, WATER SHOES, CHILDREN'S SHOES, CANVAS AND ATHLETIC SHOES, COSTUME SHOES (U.S. CLS. 22 AND 39).

MATTHEW MCDOWELL, EXAMINING ATTORNEY

SN 77-158,066. BATISTA, CHARLIE, NEW YORK, NY. FILED 4-16-2007.



THE MARK CONSISTS OF A DESTROYED PLANET WITH A COMPLETE RING AND A FEW INCOMPLETE RINGS AND MULTIPLE SIZED DOTS SURROUNDING IT.

FOR SHORT-SLEEVED OR LONG-SLEEVED T-SHIRTS; SWEAT SHIRTS; T-SHIRTS; HATS; HEADGEAR, NAMELY, CAPS (U.S. CLS. 22 AND 39).

JANICE L. MCMORROW, EXAMINING ATTORNEY

CLASS 25—(Continued).

SN 77-158,089. PASCAL, ENRIQUE, RICHMOND, VA. FILED 4-17-2007.

NO CLAIM IS MADE TO THE EXCLUSIVE RIGHT TO USE "CLOTHING", APART FROM THE MARK AS SHOWN. ENRIQUE PIERRE DOES NOT REPRESENT THE NAME OF A LIVING INDIVIDUAL.

THE COLOR(S) RED, WHITE, BLACK, NAVY BLUE, YELLOW, AND ORANGE IS/ARE CLAIMED AS A FEATURE OF THE MARK.

THE MARK CONSISTS, IN PART, OF THE NAMES ENRIQUE AND PIERRE IN THE SAME STYLIZED SCRIPT, AND THE TERM CLOTHING IN A SERIF STYLIZED SCRIPT. A DESIGN OF A SWIRL LOLLIPOP IN THE COLORS RED, WHITE, BLACK, NAVY BLUE, YELLOW, AND ORANGE APPEARS BETWEEN THE NAMES ENRIQUE AND PIERRE.

FOR SHORT-SLEEVED OR LONG-SLEEVED T-SHIRTS; T-SHIRTS; BUTTON-FRONT ALOHA SHIRTS; CAMP SHIRTS; DRESS SHIRTS; GOLF SHIRTS; KNIT SHIRTS; NIGHT SHIRTS; OPEN-NECKED SHIRTS; PIQUE SHIRTS; POLO SHIRTS; SHIRT FRONTS; SHIRT YOKES; SHIRTS; SHIRTS FOR SUITS; SHORT-SLEEVED SHIRTS; SLEEP SHIRTS; SPORT SHIRTS; SPORTS SHIRTS; SPORTS SHIRTS WITH SHORT SLEEVES; SWEAT SHIRTS; WIND SHIRTS; YOGA SHIRTS (U.S. CLS. 22 AND 39).

FIRST USE 2-2-2007; IN COMMERCE 2-2-2007.

ZHALEH DELANEY, EXAMINING ATTORNEY

SN 77-158,101. CRUZLEGUEN GROUP INC., NEW YORK, NY. FILED 4-17-2007.

CRUZLEGUEN

THE MARK CONSISTS OF STANDARD CHARACTERS WITHOUT CLAIM TO ANY PARTICULAR FONT, STYLE, SIZE, OR COLOR.

FOR DENIM JACKETS; DENIMS; SHORT-SLEEVED T-SHIRTS; LONG-SLEEVED T-SHIRTS; SWEATERS; DRESS SHIRTS; POLO SHIRTS; LEATHER JACKETS; HATS; JACKETS (U.S. CLS. 22 AND 39).

FIRST USE 4-17-2007; IN COMMERCE 4-17-2007.

GIANCARLO CASTRO, EXAMINING ATTORNEY

CLASS 25—(Continued).

SN 77-158,103. ZHIYONG, CHEN, TONGAN DISTRICT,XIAMEN, CHINA, FILED 4-17-2007.



FOR COATS; CYCLISTS' JERSEYS; RAINWEAR; GYMNAS TIC SHOES; SHOES; HEADGEAR, NAMELY, HATS AND CAPS; HOSIERY; GLOVES; TURBANS; BELTS (U.S. CLS. 22 AND 39).

BARBARA RUTLAND, EXAMINING ATTORNEY

SN 77-158,124. CABAZES, LUIS, LOS ANGELES, CA. FILED 4-17-2007.

Because I'm Awesome

THE MARK CONSISTS OF STANDARD CHARACTERS WITHOUT CLAIM TO ANY PARTICULAR FONT, STYLE, SIZE, OR COLOR.

FOR SHIRTS; SHORT-SLEEVED OR LONG-SLEEVED T-SHIRTS; T-SHIRTS; POLO SHIRTS; HATS; INFANT AND TODDLER ONE PIECE CLOTHING; WOMEN'S UNDERWEAR; SWEAT SHIRTS; SWEAT SUITS (U.S. CLS. 22 AND 39).

RAMONA ORTIGA, EXAMINING ATTORNEY

CLASS 25—(Continued).

SN 77-158,293. TRI-CITY VALLEYCATS, INC., TROY, NY. FILED 4-17-2007.



FOR CLOTHING, NAMELY, ATHLETIC UNIFORMS, BANDANAS, CAPS, CLOTH BABY BIBS, COATS, GOLF SHIRTS, GYM SHORTS, HATS, JACKETS, JERSEYS, KNIT SHIRTS, PAJAMAS, POLO SHIRTS, PONCHOS, PULLOVERS, RAIN COATS, RAINWEAR, SWEATERS, SWEAT PANTS, SWEAT SHIRTS, SWEAT SUITS, SOCKS, SPORT SHIRTS, T- SHIRTS, TANK TOPS, TIES, VISORS, WIND RESISTANT JACKETS AND WRISTBANDS (U.S. CLS. 22 AND 39).

FIRST USE 4-1-2002; IN COMMERCE 4-1-2002.
TANYA AMOS, EXAMINING ATTORNEY

SN 77-158,308. IRVIN, DAVID, LOS ANGELES, CA. FILED 4-17-2007.

SHEIST

THE MARK CONSISTS OF STANDARD CHARACTERS WITHOUT CLAIM TO ANY PARTICULAR FONT, STYLE, SIZE, OR COLOR.

FOR CAPS; HOODS; TOPS (U.S. CLS. 22 AND 39).
CHERYL CLAYTON, EXAMINING ATTORNEY

CLASS 25—(Continued).

SN 77-158,318. THREE SISTAS UNITED, INC., PALM COAST, FL. FILED 4-17-2007.



THE MARK CONSISTS OF A SHADED OVAL WITH 3SU ENCLOSED.
FOR SWEAT SHIRTS; T-SHIRTS; TANK TOPS (U.S. CLS. 22 AND 39).
LANA PHAM, EXAMINING ATTORNEY

CLASS 25—(Continued).

SN 77-158,452. CITY OF NEW YORK, NEW YORK, NY. FILED 4-17-2007.



OWNER OF U.S. REG. NOS. 3,014,363 AND 3,061,459.
FOR SWEAT SHIRTS; T-SHIRTS; BASEBALL CAPS (U.S. CLS. 22 AND 39).
BRIAN CALLAGHAN, EXAMINING ATTORNEY

SN 77-158,436. NEW YORK CITY LAW DEPARTMENT, NEW YORK, NY. FILED 4-17-2007.



NO CLAIM IS MADE TO THE EXCLUSIVE RIGHT TO USE "POLICE EMERGENCY SQUAD", APART FROM THE MARK AS SHOWN.
FOR SWEAT SHIRTS; T-SHIRTS; BASEBALL CAPS (U.S. CLS. 22 AND 39).
ANTHONY RINKER, EXAMINING ATTORNEY

SN 77-158,599. CASCADIA FASHIONS RESOURCES INC., BURNABY, CANADA, FILED 4-17-2007.

SEG'MENTS

THE MARK CONSISTS OF STANDARD CHARACTERS WITHOUT CLAIM TO ANY PARTICULAR FONT, STYLE, SIZE, OR COLOR.
OWNER OF U.S. REG. NO. 2,065,649.
FOR CLOTHING, NAMELY T-SHIRTS, JACKETS, PANTS, SHORTS, SKORTS, SHIRTS (U.S. CLS. 22 AND 39).
FIRST USE 3-31-1996; IN COMMERCE 3-31-1996.
ANTHONY RINKER, EXAMINING ATTORNEY

CLASS 25—(Continued).

SN 77-158,728. MS. BUBBLES, INC., LOS ANGELES, CA.
FILED 4-17-2007.

Eighth Avenue

THE MARK CONSISTS OF STANDARD CHARACTERS WITHOUT CLAIM TO ANY PARTICULAR FONT, STYLE, SIZE, OR COLOR.

FOR MEN'S CLOTHING, NAMELY, OVERCOATS, RAINCOATS, JACKETS, SUITS, SPORTS JACKETS, VESTS, JEANS, TROUSERS, SHORTS, SHIRTS, SWEATERS, SWIM WEAR, BRIEFS, BOXERS, T-SHIRTS, TANK SHIRTS, SWEAT SHIRTS, SWEAT PANTS, PAJAMAS, TIES, BELTS, GLOVES, SOCKS, SHOES, BOOTS, SLIPPERS, SANDALS, AND HEADWEAR; LADIES CLOTHING, NAMELY, OVERCOATS, RAIN COATS, JACKETS, SUITS, BLAZERS, VESTS, JEANS, TROUSERS, DRESSES, SKIRTS, SHORTS, SHIRTS, BLOUSES, SWEATERS, SWIM WEAR, UNDERGARMENTS, T-SHIRTS, TANK SHIRTS, SWEAT SHIRTS, SWEAT PANTS, PAJAMAS, SCARVES, BELTS, GLOVES, SOCKS, HOSIERY, SHOES, BOOTS, SLIPPERS, SANDALS, AND HEADWEAR (U.S. CLS. 22 AND 39).

FIRST USE 9-1-2004; IN COMMERCE 9-1-2004.
CARRIE GENOVESE, EXAMINING ATTORNEY

SN 77-158,879. TRI-CITY VALLEYCATS, INC., TROY, NY.
FILED 4-17-2007.



FOR CLOTHING, NAMELY, ATHLETIC UNIFORMS, BANDANAS, CAPS, CLOTH BABY BIBS, COATS, GOLF SHIRTS, GYM SHORTS, HATS, JACKETS, JERSEYS, KNIT SHIRTS, PAJAMAS, POLO SHIRTS, PONCHOS, PULLOVERS, RAIN COATS, RAINWEAR, SWEATERS, SWEAT PANTS, SWEAT SHIRTS, SWEAT SUITS, SOCKS, SPORT SHIRTS, T-SHIRTS, TANK TOPS, TIES, VISORS, WIND RESISTANT JACKETS AND WRISTBANDS (U.S. CLS. 22 AND 39).

FIRST USE 4-1-2002; IN COMMERCE 4-1-2002.
TANYA AMOS, EXAMINING ATTORNEY

CLASS 25—(Continued).

SN 77-158,947. BENSEN, ANGELIA, PORT WASHINGTON, WI. FILED 4-17-2007.

GG AND ME

THE MARK CONSISTS OF STANDARD CHARACTERS WITHOUT CLAIM TO ANY PARTICULAR FONT, STYLE, SIZE, OR COLOR.

FOR BOTTOMS; DRESSES; HATS; PAJAMAS; PANTS; SHIRTS; SKIRTS; TOPS; BEACH COVERUPS; JACKETS; ROBES; SLIPPERS; SOCKS; SWIM WEAR; INFANT SLEEPERS; INFANTS' TROUSERS; SWEAT SHIRTS; T-SHIRTS (U.S. CLS. 22 AND 39).

GISELLE AGOSTO, EXAMINING ATTORNEY

SN 77-158,971. JUST JEN, INC., ROLLING HILLS ESTATES, CA. FILED 4-17-2007.

Just Jen

THE MARK CONSISTS OF STANDARD CHARACTERS WITHOUT CLAIM TO ANY PARTICULAR FONT, STYLE, SIZE, OR COLOR.

FOR T-SHIRTS; SHIRTS; PANTS; SHORTS; SWEAT PANTS; SWEAT SHIRTS; SWEAT SHORTS; SWEAT SUITS; COATS; JACKETS; SKIRTS; DRESSES; HATS; CAPS; BEACHWEAR; SWIM WEAR; FOOTWEAR; FLIP FLOPS; LINGERIE; SOCKS; INFANTWEAR; BELTS; PAJAMAS (U.S. CLS. 22 AND 39).

FIRST USE 2-1-2004; IN COMMERCE 2-1-2004.
MIDGE BUTLER, EXAMINING ATTORNEY

SN 77-159,010. PURSLEY, RUSSELL H, BAKERSFIELD, CA.
FILED 4-17-2007.

XTREME JUVENILE

THE MARK CONSISTS OF STANDARD CHARACTERS WITHOUT CLAIM TO ANY PARTICULAR FONT, STYLE, SIZE, OR COLOR.

FOR HATS; SWEAT SHIRTS; T-SHIRTS (U.S. CLS. 22 AND 39).

TARAH HARDY, EXAMINING ATTORNEY

CLASS 25—(Continued).

SN 77-159,025. BARILLAS, YAZMIN S., LOS ANGELES, CA. FILED 4-17-2007.

Dirtee Karma

THE MARK CONSISTS OF STANDARD CHARACTERS WITHOUT CLAIM TO ANY PARTICULAR FONT, STYLE, SIZE, OR COLOR.

FOR TOPS; OPEN-NECKED SHIRTS; SHORT-SLEEVED OR LONG-SLEEVED T-SHIRTS; SHORT-SLEEVED SHIRTS; SWEAT SHIRTS; T-SHIRTS (U.S. CLS. 22 AND 39).

MARK T. MULLEN, EXAMINING ATTORNEY

CLASS 25—(Continued).

SN 77-159,082. HOLLIS, DENNIS, NORFOLK, VA. FILED 4-17-2007.

NAPPY WEAR



NO CLAIM IS MADE TO THE EXCLUSIVE RIGHT TO USE WEAR, APART FROM THE MARK AS SHOWN.

THE COLOR(S) BROWN AND BLACK IS/ARE CLAIMED AS A FEATURE OF THE MARK.

THE MARK CONSISTS OF A HAPPY FACE THAT IS BROWN WITH BLACK EYES, EYE BROWS AND MOUTH, BLACK DOTS REPRESENTING HAIR, THE WORDS NAPPY WEAR ARE SHADED BLACK AND OUTLINED IN BROWN.

FOR SHORT-SLEEVED OR LONG-SLEEVED T-SHIRTS (U.S. CLS. 22 AND 39).

STEPHEN AQUILA, EXAMINING ATTORNEY

SN 77-159,087. FREER, JOHN L., FLAGSTAFF, AZ. AND CLARK, JAMES S., DRAPER, UT. FILED 4-17-2007.

SN 77-159,072. MELANGE INTERNATIONAL INC, NEW YORK, NY. FILED 4-17-2007.

ALAN & COMPANY

THE MARK CONSISTS OF STANDARD CHARACTERS WITHOUT CLAIM TO ANY PARTICULAR FONT, STYLE, SIZE, OR COLOR.

NO CLAIM IS MADE TO THE EXCLUSIVE RIGHT TO USE "& COMPANY", APART FROM THE MARK AS SHOWN.

FOR BATHING SUITS FOR MEN; CLOTHING FOR WEAR IN JUDO PRACTICES; CLOTHING FOR WEAR IN WRESTLING GAMES; COATS FOR MEN AND WOMEN; FOOTWEAR FOR MEN; FOOTWEAR FOR MEN AND WOMEN; HEAD WEAR; LEOTARDS AND TIGHTS FOR WOMEN, MEN AND CHILDREN OF NYLON, COTTON OR OTHER TEXTILE FIBERS; MEN AND WOMEN JACKETS, COATS, TROUSERS, VESTS; MEN'S SOCKS; MEN'S SUITS; MEN'S SUITS, WOMEN'S SUITS; SKI WEAR; SURF WEAR; SUSPENDER BELTS FOR MEN; SWIM WEAR; SWIM WEAR FOR GENTLEMEN AND LADIES; TENNIS WEAR (U.S. CLS. 22 AND 39).

JAY FLOWERS, EXAMINING ATTORNEY

HEADJOCK

THE MARK CONSISTS OF STANDARD CHARACTERS WITHOUT CLAIM TO ANY PARTICULAR FONT, STYLE, SIZE, OR COLOR.

FOR CLOTHING, NAMELY, HATS, CAPS, LONG-SLEEVED OR SHORT-SLEEVED T-SHIRTS, SWEAT SHIRTS, SWEAT PANTS, PANTS, JACKETS, SHORTS AND SOCKS (U.S. CLS. 22 AND 39).

AISHA SALEM, EXAMINING ATTORNEY

SN 77-159,383. FISHING FOX, CHICO, CA. FILED 4-18-2007.

A Fishing Sisterhood

NO CLAIM IS MADE TO THE EXCLUSIVE RIGHT TO USE "FISHING", APART FROM THE MARK AS SHOWN.

THE MARK CONSISTS OF 3 WORDS TOGETHER: A FISHING SISTERHOOD."

FOR VESTS; FISHING VESTS; TANK TOPS; TANK-TOPS; TOPS; FISHERMEN'S JACKETS; JACKETS; GOLF SHIRTS; SHIRTS; SPORT SHIRTS; HATS (U.S. CLS. 22 AND 39).

FIRST USE 3-1-2007; IN COMMERCE 3-1-2007.

PAUL F. GAST, EXAMINING ATTORNEY

CLASS 25—(Continued).

SN 77-159,389. DARE TO TRI, LLC, MADISON, WI. FILED 4-18-2007.

DARE TO TRI

THE MARK CONSISTS OF STANDARD CHARACTERS WITHOUT CLAIM TO ANY PARTICULAR FONT, STYLE, SIZE, OR COLOR.

FOR POLO SHIRTS; SHIRTS; SHORT-SLEEVED OR LONG-SLEEVED T-SHIRTS; SPORT SHIRTS; SPORTS SHIRTS WITH SHORT SLEEVES; SWEAT SHIRTS; T-SHIRTS; WIND SHIRTS; OPEN-NECKED SHIRTS; SHORT-SLEEVED SHIRTS; VESTS; HATS; VISORS; SOCKS; SHORTS; TIGHTS; JOGGING PANTS; SWEAT PANTS; TRACK PANTS; BICYCLING GLOVES; SPORTS JACKETS; WIND RESISTANT JACKETS; SWEAT BANDS; SWEAT SHORTS; BOXER SHORTS; BANDANAS (U.S. CLS. 22 AND 39).

JOHN E. MICHOS, EXAMINING ATTORNEY



SN 77-159,426. PANNULLO, VINCENT, MONROE TWP., NJ. FILED 4-18-2007.

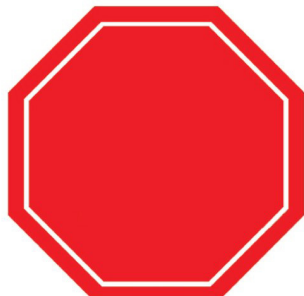

i STOP for

THE COLOR(S) BLACK, RED AND WHITE IS/ARE CLAIMED AS A FEATURE OF THE MARK.

THE MARK CONSISTS OF THE WORDS "I" AND "FOR" ARE BLACK. THE WORD "STOP" AND MOST OF THE STOP SIGN DESIGN ARE RED. THE PERIMETER LINING OF THE SIGN AND BACKGROUND TO THE MARK ARE WHITE.

FOR SHIRTS (U.S. CLS. 22 AND 39).
FIRST USE 1-24-2007; IN COMMERCE 1-24-2007.
IRA J. GOODSAD, EXAMINING ATTORNEY

CLASS 25—(Continued).

SN 77-159,686. ARTSMART, INC., NEW ORLEANS, LA. FILED 4-18-2007.

We put the now in knowing

THE MARK CONSISTS OF STANDARD CHARACTERS WITHOUT CLAIM TO ANY PARTICULAR FONT, STYLE, SIZE, OR COLOR.

FOR NECKTIES (U.S. CLS. 22 AND 39).
BARNEY CHARLON, EXAMINING ATTORNEY



SN 77-159,719. FENEMORE, KELLY, EDGEWOOD, FL. FILED 4-18-2007.

MVMNNT

FOR T-SHIRTS; SHIRTS; SPORTS JERSEYS; JEANS; SHORTS; SWEATERS; SWEAT SHIRTS; SWEAT SUITS; DRESS SHIRTS; SLACKS; BASEBALL CAPS; SUITS; SOCKS; UNDERWEAR; LEATHER JACKETS; JACKETS; BELTS (U.S. CLS. 22 AND 39).

LINDA M. KING, EXAMINING ATTORNEY



SN 77-159,727. FENEMORE, KELLY, EDGEWOOD, FL. FILED 4-18-2007.

MVMNNT THE[®]Y

FOR T-SHIRTS; SHIRTS; SPORTS JERSEYS; JEANS; SHORTS; SWEATERS; SWEAT SHIRTS; SWEAT SUITS; DRESS SHIRTS; SLACKS; BASEBALL CAPS; SUITS; SOCKS; UNDERWEAR; LEATHER JACKETS; JACKETS; BELTS (U.S. CLS. 22 AND 39).

LINDA M. KING, EXAMINING ATTORNEY

CLASS 25—(Continued).

SN 77-159,800. KROTHER, JASON N, BLOOMINGTON, IN.
FILED 4-18-2007.

correct

THE MARK CONSISTS OF STANDARD CHARACTERS WITHOUT CLAIM TO ANY PARTICULAR FONT, STYLE, SIZE, OR COLOR.

FOR AFTER SKI BOOTS; ANGLERS' SHOES; ANKLE BOOTS; ANKLE GARTERS; ANKLE SOCKS; ANKLETS; ANORAKS; ANTI-PERSPIRANT SOCKS; APRES-SKI SHOES; APRONS; ASCOTS; ATHLETIC FOOTWEAR; ATHLETIC SHOES; BANDANAS; BASEBALL CAPS; BASKETBALL SNEAKERS; BATH SLIPPERS; BATHING CAPS; BATHING SUITS; BATHING SUITS FOR MEN; BATHING TRUNKS; BATHROBES; BEACH COVERUPS; BEACH FOOTWEAR; BEACH SHOES; BEACHWEAR; BEANIES; BED JACKETS; BELTS; BELTS MADE OF LEATHER; BELTS OF TEXTILE; BERMUDA SHORTS; BIB OVERALLS; BICYCLE GLOVES; BICYCLING GLOVES; BIKINIS; BLAZERS; BLOOMERS; BLOUSES; BOARD SHORTS; BOARDSHORTS; BODY SUITS; BOLLEROS; BOLO TIES; BONNETS; BOOTIES; BOOTS; BOTTOMS; BOW TIES; BOWLING SHOES; BOXER BRIEFS; BOXER SHORTS; BOXING SHOES; BRAS; BRASSIERES; BRIEFS; BRIEFS; BUTTON-FRONT ALOHA SHIRTS; CAMISOLES; CAMP SHIRTS; CANVAS SHOES; CAP VISORS; CAPELETS; CAPRI PANTS; CAPRIS; CAPS; CAPS WITH VISORS; CARDIGANS; CARGO PANTS; CHEMISES; CHEMISSETTES; CHILDREN'S AND INFANTS' CLOTH BIBS; CHILDREN'S CLOTH EATING BIBS; CHILDREN'S HEADWEAR; CLOGS; CLOTHING, NAMELY, ARM WARMERS; CLOTHING, NAMELY, KNEE WARMERS; CLOTHING, NAMELY, NECK TUBES; CLOTHING, NAMELY, WRAP-AROUNDS; COATS; COATS FOR MEN AND WOMEN; COATS MADE OF COTTON; COATS OF DENIM; COVERALLS; COVERUPS; CYCLISTS' JERSEYS; DECK-SHOES; DENIM JACKETS; DENIMS; DICKIES; DO RAGS; DOWN JACKETS; DRESS SHIELDS; DRESS SHIRTS; DRESS SUITS; DRESSES; DRIVERS; DRY SUITS; DUNGAREES; EAR MUFFS; EARBANDS; FABRIC BELTS; FISHERMEN'S JACKETS; FISHING VESTS; FISHING WADERS; FLEECE PULLOVERS; FLEECE SHORTS; FLIP FLOPS; FOOTWEAR; FOOTWEAR; FOOTWEAR FOR MEN; FOOTWEAR FOR MEN AND WOMEN; FOOTWEAR FOR TRACK AND FIELD ATHLETICS; FOOTWEAR FOR WOMEN; FOOTWEAR MADE OF WOOD; FOOTWEAR NOT FOR SPORTS; FOOTWEAR, NAMELY, PUMPS; FOOTWEAR, NAMELY, RUBBERS; FOUL WEATHER GEAR; FUR COATS; FUR COATS AND JACKETS; FUR HATS; FUR JACKETS; FUR MUFFS; G-STRINGS; GALOSHES; GAUCHOS; GLOVES; GLOVES INCLUDING THOSE MADE OF SKIN, HIDE OR FUR; GOLF CAPS; GOLF SHIRTS; GOLF SHOES; GOLF TROUSERS; GREATCOATS; GYM SHORTS; GYM SUITS; HALTER TOPS; HAT BANDS; HATS; HEAD SCARVES; HEAD SWEATBANDS; HEAD WEAR; HEADBANDS; HEADBANDS AGAINST SWEATING; HEADWEAR; HEAVY JACKETS; HEELS; HIGH RAIN CLOGS (ASHIDA); HIKING BOOTS; HOODS; HOODS; HOUSECOATS; INFANT AND TODDLER ONE PIECE CLOTHING; INFANT SLEEPERS; INFANTS' SHOES AND BOOTS; INFANTS' TROUSERS; INFANTWEAR; JACKETS; JEANS; JERSEYS; JOGGING OUTFITS; JOGGING PANTS; JOGGING SUITS; JUMPERS; JUMPSUITS; KILTS; KNEE HIGHS; KNEE-HIGH STOCKINGS; KNICKERS; KNIT SHIRTS; KNITTED CAPS; KNITTED UNDERWEAR; LACE BOOTS; LADIES' BOOTS; LADIES' SUITS; LADIES' UNDERWEAR; LEATHER BELTS; LEATHER COATS; LEATHER HEADWEAR; LEATHER JACKETS; LEATHER PANTS; LEATHER SHOES; LEATHER SLIPPERS; LEG WARMERS; LEG-WARMERS; LEGGINGS; LIGHT-REFLECTING COATS; LIGHT-REFLECTING JACKETS; LONG JACKETS; LONG SLEEVED VESTS; LOUNGEWEAR; MEN AND WOMEN JACKETS, COATS, TROUSERS, VESTS; MEN'S SOCKS; MEN'S SUITS; MEN'S SUITS, WOMEN'S SUITS; MINISKIRTS; MITTENS; MOCCASINS; MOCK TURTLE-NECK

CLASS 25—(Continued).

SWEATERS; MONEY BELTS; MORNING COATS; MOTORCYCLE GLOVES; MOTORCYCLIST BOOTS; MUSCLE TOPS; NECK BANDS; NECK GAITERS; NECKERCHIEFS; NECKERCHIEVES; NECKTIES; NECKWEAR; NIGHT GOWNS; NIGHT SHIRTS; NIGHTCAPS; NIGHTDRESSES; NIGHTIES; NIGHTWEAR; ONE PIECE GARMENT FOR INFANTS AND TODDLERS; OPEN-NECKED SHIRTS; OVER COATS; OVER-TROUSERS; OVERALLS; OVERCOATS; OVERSHOES; PAJAMAS; PANTIES; PANTIES, SHORTS AND BRIEFS; PANTS; PANTSUITS; PARKAS; PERSPIRATION ABSORBENT UNDERWEAR CLOTHING; PETTICOATS; PIQUE SHIRTS; PLASTIC BABY BIBS; PLAY SUITS; POCKET KERCHIEFS; POCKET SQUARES; POLO SHIRTS; PONCHOS; PULLOVERS; PUMPS; PYJAMAS; QUILTED VESTS; RAIN BOOTS; RAIN COATS; RAIN JACKETS; RAIN SLICKERS; RAIN SUITS; RAIN TROUSERS; RAINCOATS; RAINPROOF JACKETS; RAINWEAR; ROBES; RUBBER SHOES; RUBBERS; RUGBY SHORTS; RUGBY TOPS; RUNNING SHOES; SANDAL-CLOGS; SANDALS; SARIS; SARONGS; SASHES; SCARVES; SCRUBS NOT FOR MEDICAL PURPOSES; SHAWLS; SHAWLS; SHAWLS AND HEADSCARVES; SHAWLS AND STOLE; SHIRTS; SHIRTS FOR SUITS; SHOES; SHORT PETTICOATS; SHORT SETS; SHORT TROUSERS; SHORT-SLEEVED OR LONG-SLEEVED T-SHIRTS; SHORT-SLEEVED SHIRTS; SHOWER CAPS; SILK SCARVES; SKI AND SNOWBOARD SHOES AND PARTS THEREOF; SKI BIBS; SKI BOOT BAGS; SKI GLOVES; SKI JACKETS; SKI MASKS; SKI PANTS; SKI SUITS; SKI SUITS FOR COMPETITION; SKI WEAR; SKIING SHOES; SKIRT SUITS; SKIRTS; SKIRTS AND DRESSES; SKIWEAR; SKULL CAPS; SKULLIES; SLACKS; SLEEP SHIRTS; SLEEPING GARMENTS; SLEEPWEAR; SLEEVED OR SLEEVELESS JACKETS; SLEEVELESS JERSEYS; SLIPPERS; SMALL HATS; SMOKING JACKETS; SNEAKERS; SNOW BOARDING SUITS; SNOW PANTS; SNOW SUITS; SNOWBOARD BOOTS; SNOWBOARD GLOVES; SNOWBOARD PANTS; SOCK SUSPENDERS; SOCKS; SOCKS AND STOCKINGS; SPORT COATS; SPORT SHIRTS; SPORTS JACKETS; SPORTS JERSEYS; SPORTS JERSEYS AND BREECHES FOR SPORTS; SPORTS OVERUNIFORMS; SPORTS SHIRTS; SPORTS SHIRTS WITH SHORT SLEEVES; STOCKINGS; STOCKINGS; STUFF JACKETS; SUEDE JACKETS; SUIT COATS; SUITS; SUITS OF LEATHER; SUN VISORS; SUNSUITS; SURF WEAR; SUSPENDER BELTS FOR MEN; SUSPENDER BELTS FOR WOMEN; SUSPENDERS; SWEAT BANDS; SWEAT PANTS; SWEAT SHIRTS; SWEAT SHORTS; SWEAT SUITS; SWEATBANDS; SWEATERS; SWEATSOCKS; SWIM CAPS; SWIM TRUNKS; SWIM WEAR; SWIM WEAR FOR GENTLEMEN AND LADIES; SWIMMING CAPS; SWIMMING CAPS; SWIMMING COSTUMES; SWIMMING TRUNKS; SWIMSUITS; T-SHIRTS; TANK TOPS; TANK-TOPS; TEDDIES; TENNIS SHOES; TENNIS WEAR; THERMAL SOCKS; THERMAL UNDERWEAR; THONGS; TIES; TIGHTS; TOBOGGAN HATS, PANTS AND CAPS; TOP COATS; TOPCOATS; TOPS; TRACK PANTS; TRACK SUITS; TRACKSUITS; TRAINING SHOES; TRAINING SUITS; TRENCH COATS; TROUSERS; TROUSERS FOR SWEATING; TROUSERS OF LEATHER; TRUNKS; TUBE TOPS; TURTLENECK SWEATERS; TURTLENECKS; TUXEDO BELTS; TUXEDOS; UNDER GARMENTS; UNDERCLOTHES; UNDERGARMENTS; UNDERPANTS; UNDERSHIRTS; UNDERSKIRTS; UNDERWEAR; UNIFORMS; V-NECK SWEATERS; VESTED SUITS; VESTS; VISORS; WAIST BELTS; WAISTCOATS; WALKING SHORTS; WARM UP SUITS; WATER SOCKS; WATERPROOF JACKETS AND PANTS; WET SUIT GLOVES; WET SUITS; WET SUITS FOR WATER-SKIING AND SUB-AQUA; WIND COATS; WIND RESISTANT JACKETS; WIND SHIRTS; WIND VESTS; WIND-JACKETS; WINDSHIRTS; WINTER BOOTS; WOMEN'S SHOES; WOMEN'S UNDERWEAR; WOOLLEN SOCKS; WOOLLY HATS; WORK SHOES AND BOOTS; WORKING OVERALLS; WOVEN OR KNITTED UNDERWEAR; WRIST BANDS; WRISTBANDS; WRISTBANDS CONTAINING A COOLING SUBSTANCE TO COOL THE WEARER; ZOOT SUITS (U.S. CLS. 22 AND 39).

JAMES A. RAUEN, EXAMINING ATTORNEY

CLASS 25—(Continued).

SN 77-159,836. KROTHER, JASON N, BLOOMINGTON, IN.
FILED 4-18-2007.



THE MARK CONSISTS OF A CROSS OVERLAIN ON AN ANGULAR SHAPE.

FOR AFTER SKI BOOTS; ANGLERS' SHOES; ANKLE BOOTS; ANKLE GARTERS; ANKLE SOCKS; ANKLETS; ANORAKS; ANTI-PERSPIRANT SOCKS; APRES-SKI SHOES; APRONS; ASCOTS; ATHLETIC FOOTWEAR; ATHLETIC SHOES; BANDANAS; BASEBALL CAPS; BASKETBALL SNEAKERS; BATH SLIPPERS; BATHING CAPS; BATHING SUITS; BATHING SUITS FOR MEN; BATHING TRUNKS; BATHROBES; BEACH COVERUPS; BEACH FOOTWEAR; BEACH SHOES; BEACHWEAR; BEANIES; BED JACKETS; BELTS; BELTS MADE OF LEATHER; BELTS OF TEXTILE; BERMUDA SHORTS; BIB OVERALLS; BICYCLE GLOVES; BICYCLING GLOVES; BIKINIS; BLAZERS; BLOOMERS; BLOUSES; BOARD SHORTS; BOARDSHORTS; BODY SUITS; BOLEROS; BOLO TIES; BONNETS; BOOTIES; BOOTS; BOTTOMS; BOW TIES; BOWLING SHOES; BOXER BRIEFS; BOXER SHORTS; BOXING SHOES; BRAS; BRASSIERES; BRIEFS; BRIEFS; BUTTON-FRONT ALOHA SHIRTS; CAMISOLES; CAMP SHIRTS; CANVAS SHOES; CAP VISORS; CAPELETS; CAPRI PANTS; CAPRIS; CAPS; CAPS WITH VISORS; CARDIGANS; CARGO PANTS; CHEMISES; CHEMISETTES; CHILDREN'S AND INFANTS' CLOTH BIBS; CHILDREN'S CLOTH EATING BIBS; CHILDREN'S HEADWEAR; CLOGS; CLOTHING, NAMELY, ARM WARMERS; CLOTHING, NAMELY, KNEE WARMERS; CLOTHING, NAMELY, NECK TUBES; CLOTHING, NAMELY, WRAP-AROUNDS; COATS; COATS FOR MEN AND WOMEN; COATS MADE OF COTTON; COATS OF DENIM; COVERALLS; COVERUPS; CYCLISTS' JERSEYS; DECK-SHOES; DENIM JACKETS; DENIMS; DICKIES; DO RAGS; DOWN JACKETS; DRESS SHIELDS; DRESS SHIRTS; DRESS SUITS; DRESSES; DRIVERS; DRY SUITS; DUNGAREES; EAR MUFFS; EARBANDS; FABRIC BELTS; FISHERMEN'S JACKETS; FISHING VESTS; FISHING WADERS; FLEECE PULLOVERS; FLEECE SHORTS; FLIP FLOPS; FOOTWEAR; FOOTWEAR; FOOTWEAR FOR MEN; FOOTWEAR FOR MEN AND WOMEN; FOOTWEAR FOR TRACK AND FIELD ATHLETICS; FOOTWEAR FOR WOMEN; FOOTWEAR MADE OF WOOD; FOOTWEAR NOT FOR SPORTS; FOOTWEAR, NAMELY, PUMPS; FOOTWEAR, NAMELY, RUBBERS; FOUL WEATHER GEAR; FUR COATS; FUR COATS AND JACKETS; FUR HATS; FUR JACKETS; FUR MUFFS; G-STRINGS; GALOSHES; GAUCHOS; GLOVES; GLOVES INCLUDING THOSE MADE OF SKIN, HIDE OR FUR; GOLF CAPS; GOLF SHIRTS; GOLF SHOES; GOLF TROUSERS; GREATCOATS; GYM SHORTS; GYM SUITS; HALTER TOPS; HAT BANDS; HATS; HEAD SCARVES; HEAD SWEATBANDS; HEAD WEAR; HEADBANDS; HEADBANDS AGAINST SWEATING; HEADWEAR; HEAVY JACKETS; HEELS; HIGH RAIN CLOGS (ASHIDA); HIKING BOOTS; HOODS; HOODS; HOUSECOATS; INFANT AND TODDLER ONE PIECE CLOTHING; INFANT SLEEPERS; INFANTS' SHOES AND BOOTS; INFANTS' TROUSERS; INFANTWEAR; JACKETS; JEANS; JERSEYS; JOGGING OUTFITS; JOGGING PANTS; JOGGING SUITS; JUMPERS; JUMPSUITS; KILTS; KNEE HIGHS; KNEE-HIGH STOCKINGS; KNICKERS; KNIT SHIRTS; KNITTED CAPS; KNITTED

CLASS 25—(Continued).

UNDERWEAR; LACE BOOTS; LADIES' BOOTS; LADIES' SUITS; LADIES' UNDERWEAR; LEATHER BELTS; LEATHER COATS; LEATHER HEADWEAR; LEATHER JACKETS; LEATHER PANTS; LEATHER SHOES; LEATHER SLIPPERS; LEG WARMERS; LEG-WARMERS; LEGGINGS; LIGHT-REFLECTING COATS; LIGHT-REFLECTING JACKETS; LONG JACKETS; LONG SLEEVED VESTS; LOUNGEWEAR; MEN AND WOMEN JACKETS, COATS, TROUSERS, VESTS; MEN'S SOCKS; MEN'S SUITS; MEN'S SUITS, WOMEN'S SUITS; MINISKIRTS; MITTENS; MOCCASINS; MOCK TURTLE-NECK SWEATERS; MONEY BELTS; MORNING COATS; MOTORCYCLE GLOVES; MOTORCYCLIST BOOTS; MUSCLE TOPS; NECK BANDS; NECK GAITERS; NECKERCHIEFS; NECKERCHIEVES; NECKTIES; NECKWEAR; NIGHT GOWNS; NIGHT SHIRTS; NIGHTCAPS; NIGHTDRESSES; NIGHTIES; NIGHTWEAR; ONE PIECE GARMENT FOR INFANTS AND TODDLERS; OPEN-NECKED SHIRTS; OVER COATS; OVER-TROUSERS; OVERALLS; OVERCOATS; OVERSHOES; PAJAMAS; PANTIES; PANTIES, SHORTS AND BRIEFS; PANTS; PANTSUITS; PARKAS; PERSPIRATION ABSORBENT UNDERWEAR CLOTHING; PETTICOATS; PIQUE SHIRTS; PLASTIC BABY BIBS; PLAY SUITS; POCKET KERCHIEFS; POCKET SQUARES; POLO SHIRTS; PONCHOS; PULLOVERS; PUMPS; PYJAMAS; QUILTED VESTS; RAIN BOOTS; RAIN COATS; RAIN JACKETS; RAIN SLICKERS; RAIN SUITS; RAIN TROUSERS; RAINCOATS; RAINPROOF JACKETS; RAINWEAR; ROBES; RUBBER SHOES; RUBBERS; RUGBY SHORTS; RUGBY TOPS; RUNNING SHOES; SANDAL-CLOGS; SANDALS; SARIS; SARONGS; SASHERS; SCARVES; SCRUBS NOT FOR MEDICAL PURPOSES; SHAWLS; SHAWLS; SHAWLS AND HEADSCARVES; SHAWLS AND STOLE; SHIRTS; SHIRTS FOR SUITS; SHOES; SHORT PETTICOATS; SHORT SETS; SHORT TROUSERS; SHORT-SLEEVED OR LONG-SLEEVED T-SHIRTS; SHORT-SLEEVED SHIRTS; SHOWER CAPS; SILK SCARVES; SKI AND SNOWBOARD SHOES AND PARTS THEREOF; SKI BIBS; SKI BOOT BAGS; SKI GLOVES; SKI JACKETS; SKI MASKS; SKI PANTS; SKI SUITS; SKI SUITS FOR COMPETITION; SKI WEAR; SKIING SHOES; SKIRT SUITS; SKIRTS; SKIRTS AND DRESSES; SKIWEAR; SKULL CAPS; SKULLIES; SLACKS; SLEEP SHIRTS; SLEEPING GARMENTS; SLEEPWEAR; SLEEVED OR SLEEVELESS JACKETS; SLEEVELESS JERSEYS; SLIPPERS; SMALL HATS; SMOKING JACKETS; SNEAKERS; SNOW BOARDING SUITS; SNOW PANTS; SNOW SUITS; SNOWBOARD BOOTS; SNOWBOARD GLOVES; SNOWBOARD PANTS; SOCK SUSPENDERS; SOCKS; SOCKS AND STOCKINGS; SPORT COATS; SPORT SHIRTS; SPORTS JACKETS; SPORTS JERSEYS; SPORTS JERSEYS AND BREECHES FOR SPORTS; SPORTS OVERUNIFORMS; SPORTS SHIRTS; SPORTS SHIRTS WITH SHORT SLEEVES; STOCKINGS; STOCKINGS; STUFF JACKETS; SUEDE JACKETS; SUIT COATS; SUITS; SUITS OF LEATHER; SUN VISORS; SUNSUITS; SURF WEAR; SUSPENDER BELTS FOR MEN; SUSPENDER BELTS FOR WOMEN; SUSPENDERS; SWEAT BANDS; SWEAT PANTS; SWEAT SHIRTS; SWEAT SHORTS; SWEAT SUITS; SWEATBANDS; SWEATERS; SWEATSOCKS; SWIM CAPS; SWIM TRUNKS; SWIM WEAR; SWIM WEAR FOR GENTLEMEN AND LADIES; SWIMMING CAPS; SWIMMING CAPS; SWIMMING COSTUMES; SWIMMING TRUNKS; SWIMSUITS; T-SHIRTS; TANK TOPS; TANK-TOPS; TEDDIES; TENNIS SHOES; TENNIS WEAR; THERMAL SOCKS; THERMAL UNDERWEAR; THONGS; TIES; TIGHTS; TOBOGGAN HATS, PANTS AND CAPS; TOP COATS; TOPCOATS; TOPS; TRACK PANTS; TRACK SUITS; TRACKSUITS; TRAINING SHOES; TRAINING SUITS; TRENCH COATS; TROUSERS; TROUSERS FOR SWEATING; TROUSERS OF LEATHER; TRUNKS; TUBE TOPS; TURTLENECK SWEATERS; TURTLENECKS; TUXEDO BELTS; TUXEDOS; UNDER GARMENTS; UNDERCLOTHES; UNDERGARMENTS; UNDERPANTS; UNDERSHIRTS; UNDERSKIRTS; UNDERWEAR; UNIFORMS; V-NECK SWEATERS; VESTED SUITS; VESTS; VISORS; WAIST BELTS; WAISTCOATS; WALK-

CLASS 25—(Continued).

ING SHORTS; WARM UP SUITS; WATER SOCKS; WATERPROOF JACKETS AND PANTS; WET SUIT GLOVES; WET SUITS; WET SUITS FOR WATER-SKIING AND SUB-AQUA; WIND COATS; WIND RESISTANT JACKETS; WIND SHIRTS; WIND VESTS; WIND-JACKETS; WINDSHIRTS; WINTER BOOTS; WOMEN'S SHOES; WOMEN'S UNDERWEAR; WOOLLEN SOCKS; WOOLLY HATS; WORK SHOES AND BOOTS; WORKING OVERALLS; WOVEN OR KNITTED UNDERWEAR; WRIST BANDS; WRISTBANDS; WRISTBANDS CONTAINING A COOLING SUBSTANCE TO COOL THE WEARER; ZOOT SUITS (U.S. CLS. 22 AND 39).

JAMES A. RAUEN, EXAMINING ATTORNEY

SN 77-159,888. WINDTOSS LLC, NEW YORK, NY. FILED 4-18-2007.

WINDTOSS

THE MARK CONSISTS OF STANDARD CHARACTERS WITHOUT CLAIM TO ANY PARTICULAR FONT, STYLE, SIZE, OR COLOR.

FOR HEADWEAR, NAMELY, VISORS, HATS AND CAPS (U.S. CLS. 22 AND 39).

GEORGE LORENZO, EXAMINING ATTORNEY

SN 77-160,051. MARPESSA, INC., SOLANA BEACH, CA. FILED 4-18-2007.

KISSED BY THE SUN

THE MARK CONSISTS OF STANDARD CHARACTERS WITHOUT CLAIM TO ANY PARTICULAR FONT, STYLE, SIZE, OR COLOR.

FOR BIKINIS, BATHING SUITS, SWIMWEAR, BEACHWEAR (U.S. CLS. 22 AND 39).

SAMUEL E. SHARPER JR., EXAMINING ATTORNEY

SN 77-160,102. TRUE CERTAINTY, INC., LOS ANGELES, CA. FILED 4-18-2007.

BELIEVE OR LEAVE

THE MARK CONSISTS OF STANDARD CHARACTERS WITHOUT CLAIM TO ANY PARTICULAR FONT, STYLE, SIZE, OR COLOR.

FOR MEN'S AND WOMEN'S CLOTHING, NAMELY, SHIRTS, SHORTS, PANTS, JACKETS, HATS, BELTS AND FOOTWEAR (U.S. CLS. 22 AND 39).

FIRST USE 11-1-2006; IN COMMERCE 11-1-2006.
CHRISTINE COOPER, EXAMINING ATTORNEY

CLASS 25—(Continued).

SN 77-160,148. GETSOME SPORTS LLC, LITTLETON, CO. FILED 4-18-2007.



NO CLAIM IS MADE TO THE EXCLUSIVE RIGHT TO USE "SPORTS", APART FROM THE MARK AS SHOWN.

THE MARK CONSISTS OF A CIRCLE CONTAINING A STYLIZED LETTER G AND STYLIZED LETTER S WITH A STYLIZED DIAMOND AT ITS CENTER WITH THE STYLIZED WORD GETSOME ON LEFT SIDE AND THE STYLIZED WORD SPORTS ON ITS RIGHT SIDE.

FOR SOCKS; SPORTS SHIRTS; SPORTS SHIRTS WITH SHORT SLEEVES; SWEAT PANTS; SWEAT SHIRTS; T-SHIRTS; TOBOGGAN HATS, PANTS AND CAPS; WATER SOCKS; WATERPROOF JACKETS AND PANTS; WIND SHIRTS; WOOLLY HATS; POLO SHIRTS; SHORT-SLEEVED OR LONG-SLEEVED T-SHIRTS; SKI PANTS; SNOW PANTS; SNOWBOARD PANTS; GOLF SHIRTS; HEADGEAR, NAMELY, BASEBALL CAPS; JOGGING PANTS; ANKLE SOCKS; ANKLETS; THERMAL SOCKS; TRACK PANTS (U.S. CLS. 22 AND 39).

KATHRYN COWARD, EXAMINING ATTORNEY

SN 77-160,222. TARDUGNO, CHAD S., HAMPSTEAD, NH. FILED 4-18-2007.

WHEREUWANNA

THE MARK CONSISTS OF THE STYLIZED TERM WHEREUWANNA.

FOR SHIRTS; HATS (U.S. CLS. 22 AND 39).

FIRST USE 12-0-2006; IN COMMERCE 12-0-2006.

INGRID C. EULIN, EXAMINING ATTORNEY

SN 77-160,265. NEU AURA, INC., MONTCLAIR, NJ. FILED 4-19-2007.

neuaura

THE MARK CONSISTS OF STANDARD CHARACTERS WITHOUT CLAIM TO ANY PARTICULAR FONT, STYLE, SIZE, OR COLOR.

FOR SHOES (U.S. CLS. 22 AND 39).

FIRST USE 3-19-2007; IN COMMERCE 3-25-2007.

SONYA STEPHENS, EXAMINING ATTORNEY

CLASS 25—(Continued).

SN 77-160,285. ARTSMART, INC., NEW ORLEANS, LA.
FILED 4-19-2007.

NAUTICAL KNOTS

THE MARK CONSISTS OF STANDARD CHARACTERS WITHOUT CLAIM TO ANY PARTICULAR FONT, STYLE, SIZE, OR COLOR.

FOR NECKTIES (U.S. CLS. 22 AND 39).
BARNEY CHARLON, EXAMINING ATTORNEY

SN 77-160,404. FUNDERBURK, CHARLES C., APPLE VALLEY, MN. FILED 4-19-2007.

CHARLESTON CHICK'N

THE MARK CONSISTS OF STANDARD CHARACTERS WITHOUT CLAIM TO ANY PARTICULAR FONT, STYLE, SIZE, OR COLOR.

FOR SHORT-SLEEVED OR LONG-SLEEVED T-SHIRTS; SWEAT SHIRTS (U.S. CLS. 22 AND 39).
SUNG IN, EXAMINING ATTORNEY

SN 77-160,471. ADVANCED GRAPHICS, INC., COCOA, FL.
FILED 4-19-2007.



THE MARK CONSISTS OF THE WORD MY IN CAPS AND THE WORD CHICK IN CURSIVE LETTERS WITH A BABY CHICK BETWEEN THE TWO WORDS.

FOR CLOTHING, FOR MEN, WOMEN AND CHILDREN, NAMELY, PAJAMAS, NIGHTSHIRTS, ROBES, JOGGING SUITS, SWEAT SUITS, WARM UP SUITS, BEACHWEAR, T-SHIRTS, SWEATSHIRTS, JERSEYS, TANK TOPS, SHIRTS, BLOUSES, SHORTS, BOXER SHORTS, TROUSERS, PANTS, JUMPERS, OVERALLS, ROMPERS, DRESSES, SKIRTS, SHORT SETS COMPRISED OF SHORTS AND TOPS, SWEATERS, CARDIGANS, JACKETS, COATS, ANORAKS, PONCHOS, RAINCOATS, SCARVES, BANDANNAS, UNDERWEAR, LINGERIE, VESTS, HEADWEAR, HATS AND CAPS, VISORS, TIES, BELTS AND SUSPENDERS, SOCKS, TIGHTS, LEGGINGS, HOSIERY, GLOVES, MITTENS, APRONS, SWIMSUITS, CLOTH BABY BIBS, FOOTWEAR, ATHLETIC SHOES, ATHLETIC UNIFORMS, SLIPPERS, AND MASQUERADE COSTUMES (U.S. CLS. 22 AND 39).

CARYN GLASSER, EXAMINING ATTORNEY

CLASS 25—(Continued).

SN 77-160,562. MEDINA, ROBERT, CASTLE ROCK, CO.
FILED 4-19-2007.

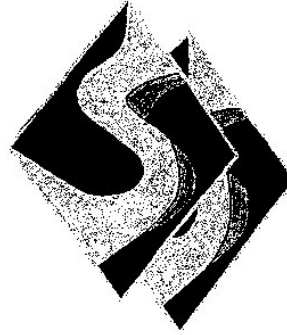

THE STIPPLING IS FOR SHADING PURPOSES ONLY.
THE MARK CONSISTS OF A LETTER S CONTAINED INSIDE A DIAMOND OF ANY SIZE, OFFSET BEHIND THE FIRST LETTER S AND DIAMOND, IS A SECOND S CONTAINED INSIDE A SECOND DIAMOND OF ANY SIZE.

FOR MEN'S, WOMEN'S AND CHILDREN'S CLOTHING, NAMELY, SKI GLOVES, SKI HATS, SKI EAR WARMERS/HEADBANDS, SKI JACKETS, SKI PANTS, MITTENS, SCARVES, VESTS, GLOVES, BEANIES, HATS, VISORS, JACKETS, PANTS, SHIRTS, T-SHIRTS, POLO SHIRTS, SWEAT SHIRTS, RAIN JACKETS AND WIND RESISTANT JACKETS (U.S. CLS. 22 AND 39).

KATHLEEN M. VANSTON, EXAMINING ATTORNEY

SN 77-160,610. COHEN, CHAD, LOS ANGELES, CA. FILED 4-19-2007.

DAUGHTERS OF THE REVOLUTION

THE MARK CONSISTS OF STANDARD CHARACTERS WITHOUT CLAIM TO ANY PARTICULAR FONT, STYLE, SIZE, OR COLOR.

FOR BANDANAS; BEANIES; BLOUSES; BOOTS; BRAS; BRIEFS; COATS FOR MEN AND WOMEN; DRESSES; EVENING GOWNS; FOOTWEAR FOR WOMEN; GARTER BELTS; HATS; HEAD SCARVES; HOODS; JEANS; JERSEYS; JUMPSUITS; LADIES' SUITS; MINISKIRTS; PANTIES; PANTS; SHIRTS; SHORTS; SKIRTS; SOCKS; SWEAT PANTS; SWEAT SHIRTS; UNDERWEAR; MATERNITY SLEEPWEAR (U.S. CLS. 22 AND 39).

FIRST USE 1-1-2007; IN COMMERCE 3-1-2007.

BARBARA BROWN, EXAMINING ATTORNEY

CLASS 25—(Continued).

SN 77-160,767. DIBLASI, CHRIS, SAN BERNARDINO, CA. FILED 4-19-2007.

INFALLIBLE ONE

THE MARK CONSISTS OF STANDARD CHARACTERS WITHOUT CLAIM TO ANY PARTICULAR FONT, STYLE, SIZE, OR COLOR.

FOR CLOTHING ITEMS, NAMELY, JACKETS, SWEATERS, SHORTS, SHIRTS, SWEATSHIRTS, HATS, VISORS, T-SHIRTS, SWEAT PANTS, JERSEYS, BATHING SUITS, BEANIES, UNDERWEAR, LINGERIE, DRESSES, NIGHTIES, TANK TOPS, CAPS, MITTENS, SCARVES, SOCKS, GLOVES, SHOES, JEANS, BANDANAS, HEADBANDS, WRISTBANDS, BELTS, ROBES, HOODED SWEATSHIRTS, PAJAMAS, AND TIES (U.S. CLS. 22 AND 39).

LYDIA BELZER, EXAMINING ATTORNEY

CLASS 25—(Continued).

SN 77-160,843. KIDS STOP LLC, NEW YORK, NY. FILED 4-19-2007.

DREAMSTAR

THE MARK CONSISTS OF STANDARD CHARACTERS WITHOUT CLAIM TO ANY PARTICULAR FONT, STYLE, SIZE, OR COLOR.

FOR SWEATERS; TURTLENECK SWEATERS; V-NECK SWEATERS; CROP TOPS; TANK TOPS; DRESS SHIRTS; GOLF SHIRTS; KNIT SHIRTS; NIGHT SHIRTS; POLO SHIRTS; SHIRTS; SHORT-SLEEVED OR LONG-SLEEVED T-SHIRTS; SLEEP SHIRTS; SPORT SHIRTS; SWEAT SHIRTS; T-SHIRTS; PAJAMA BOTTOMS; PAJAMAS; SLEEPWEAR; JACKETS; UNDERWEAR; WOMEN'S UNDERWEAR; HATS; ANKLE SOCKS; BELTS; FOOTWEAR; GLOVES; HOSIERY; SOCKS AND STOCKINGS; BOARD SHORTS; BOXER SHORTS; CAPRI PANTS; CARGO PANTS; JOGGING PANTS; LOUNGE PANTS; PANTIES, SHORTS AND BRIEFS; PANTS; SKIRTS AND DRESSES; BATHROBES; BLOUSES; BODY SUITS; BOOTS; COATS; JEANS; CAPRIS; JUMPERS; SANDALS; SWIM WEAR; TIGHTS; SWIMSUITS (U.S. CLS. 22 AND 39).

FIRST USE 1-3-2007; IN COMMERCE 3-1-2007.

JOHN DWYER, EXAMINING ATTORNEY

SN 77-160,965. LENNON, YOKO ONO, NEW YORK, NY. FILED 4-19-2007.

**THIS IS MY STORY BOTH
HUMBLE AND TRUE**

THE MARK CONSISTS OF STANDARD CHARACTERS WITHOUT CLAIM TO ANY PARTICULAR FONT, STYLE, SIZE, OR COLOR.

FOR MEN'S AND WOMEN CLOTHING, NAMELY, PANTS, JEANS, SHORTS, OVERALLS, SHIRTS, T-SHIRTS, BLOUSES, VESTS, SKIRTS, JACKETS, COATS, SPORTCOATS, SWEATERS, SWEATSHIRTS, SWEATPANTS, HATS, TIES, BELTS, SOCKS AND UNDERWEAR, AND CHILDREN'S AND INFANTS' CLOTHING, NAMELY, SHORTS, SHORT SETS CONSISTING OF TOP AND BOTTOM; SHIRTS, PANTS, DRESSES, COVERALLS, ROMPERS, CREEPERS, OVERALLS, OVERALL SETS COMPRISED OF OVERALL AND TOP; INFANTS' AND CHILDREN'S UNDERWEAR, SHORTALLS, SHORTALL SETS COMPRISED OF SHORTALL AND TOP; T-SHIRTS, THREE-PIECE SETS CONSISTING OF DIAPER SHIRTS, TOPS AND BOTTOMS; COORDINATING SETS CONSISTING OF TOPS AND BOTTOMS; LAYETTE SETS COMPRISED OF GOWN AND CAP, TOP AND PANT, CARDIGAN, TOP AND PANT, SHORTALL AND TOP, OVERALL AND TOP, CARDIGAN AND PANT, CREEPER AND PANT, CREEPER AND SHORTS OR COVERALLS AND BLANKET; SLEEPWEAR; JACKETS; ZIPPERED PULL-OVER JACKETS, WINDSUITS, BABY BUNTINGS, SNOWSUITS, RAINCOATS, PONCHOS, RAIN JACKETS, RAIN SUITS, SWIM SUITS, SWIM COVER-UPS; SWIMWEAR SETS CONSISTING OF SWIMSUIT OR SWIM TRUNKS AND COVER-UP; SHORT SETS CONSISTING OF SHORTS AND TOPS (U.S. CLS. 22 AND 39).

JASON ROTH, EXAMINING ATTORNEY

SN 77-160,815. PREMIER LEGENDS, INC., MALVERN, PA. FILED 4-19-2007.

A Legend is a Legacy

THE MARK CONSISTS OF STANDARD CHARACTERS WITHOUT CLAIM TO ANY PARTICULAR FONT, STYLE, SIZE, OR COLOR.

FOR SHORT-SLEEVED OR LONG-SLEEVED T-SHIRTS; T-SHIRTS; JERSEYS; SHIRTS; SHORT-SLEEVED SHIRTS; SPORTS SHIRTS; SPORTS SHIRTS WITH SHORT SLEEVES; SWEAT SHIRTS; HATS; PANTS; SWEAT PANTS; SHORTS; SWEAT SHORTS; GYM SHORTS; ATHLETIC SHOES; SHOES; JACKETS (U.S. CLS. 22 AND 39).

DAVID C. REIHNER, EXAMINING ATTORNEY

CLASS 25—(Continued).

SN 77-161,069. DOMERACKI, JOHN, AUSTIN, TX. FILED 4-19-2007.

TOO CUTE TO BE NAUGHTY

THE MARK CONSISTS OF STANDARD CHARACTERS WITHOUT CLAIM TO ANY PARTICULAR FONT, STYLE, SIZE, OR COLOR.

FOR CLOTHING, NAMELY, T-SHIRTS, TOPS, JACKETS, SWEAT SUITS, SWEATSHIRTS, PANTS, SHORTS AND SKIRTS (U.S. CLS. 22 AND 39).

MARK SPARACINO, EXAMINING ATTORNEY

SN 77-161,075. CAMP BRANDS HOLDINGS LLC, NEW YORK, NY. FILED 4-19-2007.

CAMP HAMPTONS

THE MARK CONSISTS OF STANDARD CHARACTERS WITHOUT CLAIM TO ANY PARTICULAR FONT, STYLE, SIZE, OR COLOR.

FOR TOPS; SHIRTS; PANTS; SKIRTS; DRESSES; SHORTS; JACKETS; COATS; HEADWEAR; FOOTWEAR; UNDERWEAR; SLEEPWEAR; SWIM WEAR; LOUNGEWEAR (U.S. CLS. 22 AND 39).

JESSICA A. POWERS, EXAMINING ATTORNEY

SN 77-161,145. RONALD DESMOND WATSON, MORTON GROVE, IL. FILED 4-19-2007.

HADTO

THE MARK CONSISTS OF STANDARD CHARACTERS WITHOUT CLAIM TO ANY PARTICULAR FONT, STYLE, SIZE, OR COLOR.

FOR CLOTHING, NAMELY, T-SHIRTS, JACKETS, JEANS, SWEAT PANTS, SWEAT SHIRTS, SWEAT SUITS, SWEAT BANDS, SWEAT SHORTS, WRIST BANDS, CAPS, HATS, PANTS, TRACK PANTS, WATERPROOF JACKETS AND PANTS, COATS, SOCKS, SHOES, UNDERWEAR, UNDERSHIRTS AND ATHLETIC UNIFORMS (U.S. CLS. 22 AND 39).

ALICE BENMAMAN, EXAMINING ATTORNEY

CLASS 25—(Continued).

SN 77-161,150. RED STEER GLOVE COMPANY, SALEM, OR. FILED 4-19-2007.

HUMPYGRIP

THE MARK CONSISTS OF STANDARD CHARACTERS WITHOUT CLAIM TO ANY PARTICULAR FONT, STYLE, SIZE, OR COLOR.

FOR GLOVES (U.S. CLS. 22 AND 39).

GEORGE LORENZO, EXAMINING ATTORNEY

SN 77-161,257. ARTHUR, MARIA, GILBERT, AZ. FILED 4-19-2007.

Pashka

THE MARK CONSISTS OF STANDARD CHARACTERS WITHOUT CLAIM TO ANY PARTICULAR FONT, STYLE, SIZE, OR COLOR.

FOR BOTTOMS; CAMISOLES; INFANT AND TODDLER ONE PIECE CLOTHING; SHIRTS; T-SHIRTS; TANK TOPS; TOPS (U.S. CLS. 22 AND 39).

JOHN SCHUYLER YARD, EXAMINING ATTORNEY

SN 77-161,394. NAUTICA APPAREL, INC., NEW YORK, NY. FILED 4-20-2007.

OUTERLITE

THE MARK CONSISTS OF STANDARD CHARACTERS WITHOUT CLAIM TO ANY PARTICULAR FONT, STYLE, SIZE, OR COLOR.

FOR JACKETS; RAIN JACKETS; SKI JACKETS; SPORTS JACKETS; WIND RESISTANT JACKETS; VESTS; SHIRTS; SWEAT SHIRTS; COATS (U.S. CLS. 22 AND 39).

DOMINIC J. FERRAIUOLO, EXAMINING ATTORNEY

CLASS 25—(Continued).

SN 77-161,462. SNAPPIN RECORDS, INC., KENNESAW, GA.
FILED 4-20-2007.



NO CLAIM IS MADE TO THE EXCLUSIVE RIGHT TO USE "RECORDS", APART FROM THE MARK AS SHOWN. THE COLOR(S) ORANGE, YELLOW, GREEN, BLACK AND WHITE IS/ARE CLAIMED AS A FEATURE OF THE MARK.

THE MARK CONSISTS OF ORANGE AND YELLOW BACKGROUND FLAMES WITH A GREEN TURTLE IN THE FOREGROUND TAKING A BITE OUT OF A BLACK AND WHITE VINYL RECORD, WITH THE WORDS "SNAPPIN" IN GREEN AND "RECORDS" IN BLACK SUPERIMPOSED ACROSS THE LOWER PORTION OF THE MARK. FOR HATS; SHIRTS; JERSEYS; TIES; TOPS; BELTS; SWEAT SHIRTS; T-SHIRTS; ATHLETIC SHOES; SHOES; PANTS; SOCKS (U.S. CLS. 22 AND 39).

JOHN DWYER, EXAMINING ATTORNEY

SN 77-161,647. JACKSON, DONALD D., LAKE CHARLES, LA. FILED 4-20-2007.

H.I.G.O.

THE MARK CONSISTS OF STANDARD CHARACTERS WITHOUT CLAIM TO ANY PARTICULAR FONT, STYLE, SIZE, OR COLOR.

FOR MEN'S, WOMEN'S AND CHILDREN'S CLOTHING, NAMELY, T-SHIRTS, PANTS, JEANS, COATS, GOWNS, DRESSES, SKIRTS, SUITS, SUSPENDERS, JACKETS, SHIRTS, JUMPSUITS, SLACKS, SWEATERS, SHORTS, BODYSUITS, SWIMSUITS, SCARVES, ROBES, HOODED SWEATSHIRTS, JOGGING SUITS, SLEEPWEAR, SOCKS, STOCKINGS, SHAWLS, NECKTIES, PULLOVERS, BELTS, EARMUFFS, TENNIS SHOES, SLIPPERS, BOOTS, GLOVES, MITTENS, CAPS AND HATS (U.S. CLS. 22 AND 39).

VIVIAN MICZNIK FIRST, EXAMINING ATTORNEY

CLASS 25—(Continued).

SN 77-162,220. BEST OF CHUMS INT'L, INC., MONTEREY PARK, CA. FILED 4-20-2007.

Isobella's Tea Party

THE MARK CONSISTS OF STANDARD CHARACTERS WITHOUT CLAIM TO ANY PARTICULAR FONT, STYLE, SIZE, OR COLOR.

FOR CHILDREN'S HEADWEAR; DRESSES; PANTS; JACKETS; SLEEVED OR SLEEVELESS JACKETS; BLOUSES; SKIRTS; SKIRTS AND DRESSES; SHIRTS; SHORT-SLEEVED SHIRTS (U.S. CLS. 22 AND 39).

DANIEL CAPSHAW, EXAMINING ATTORNEY

SN 77-163,221. GRAYHAIR SOFTWARE, INC., MOUNT LAUREL, NJ. FILED 4-23-2007.



THE MARK CONSISTS OF A GRAPHICAL STYLIZED REPRESENTATION OF HAIR.

FOR BASEBALL CAPS; CAPS; GOLF SHIRTS; JACKETS; KNIT SHIRTS; SHIRTS (U.S. CLS. 22 AND 39).

FIRST USE 4-2-2006; IN COMMERCE 4-2-2006.

AISHA CLARKE, EXAMINING ATTORNEY

SN 77-163,718. CAMP BRANDS HOLDINGS LLC, NEW YORK, NY. FILED 4-23-2007.

CAMP MALIBU

THE MARK CONSISTS OF STANDARD CHARACTERS WITHOUT CLAIM TO ANY PARTICULAR FONT, STYLE, SIZE, OR COLOR.

FOR TOPS; SHIRTS; PANTS; SKIRTS; DRESSES; SHORTS; JACKETS; COATS; HEADWEAR; FOOTWEAR; UNDERWEAR; SLEEPWEAR; SWIM WEAR; LOUNGEWEAR (U.S. CLS. 22 AND 39).

JESSICA A. POWERS, EXAMINING ATTORNEY

CLASS 25—(Continued).

SN 77-164,211. TRIXXI CLOTHING COMPANY, INC., VERNON, CA. FILED 4-24-2007.



THE MARK CONSISTS OF THE IMAGE OF THREE HEARTS ENCUMPPASSES BY A RECTANGLE, WITH THE WORDS "THREE PINK HEARTS" ABOVE THE THREE HEARTS, AND THE WORD "TRIXXI" BELOW THE THREE HEARTS.

FOR SKIRTS; SHIRTS; T-SHIRTS; SWEATERS; PANTS; SHORTS; TOPS; BLOUSES; JACKETS; FOOTWEAR; DRESSES; GOWNS (U.S. CLS. 22 AND 39).

MICHAEL SOUDERS, EXAMINING ATTORNEY

SN 77-164,311. RANDAL A. ORTIZ, PHOENIX, AZ. FILED 4-24-2007.

DON'T WEEP

THE MARK CONSISTS OF STANDARD CHARACTERS WITHOUT CLAIM TO ANY PARTICULAR FONT, STYLE, SIZE, OR COLOR.

FOR TOPS; JERSEYS; CAPS; HATS; HEADGEAR, NAMELY, CAPS (U.S. CLS. 22 AND 39).

MARK T. MULLEN, EXAMINING ATTORNEY

SN 77-165,113. LIVE NATION WORLDWIDE, INC., BEVERLY HILLS, CA. FILED 4-25-2007.

ARTIST NATION

THE MARK CONSISTS OF STANDARD CHARACTERS WITHOUT CLAIM TO ANY PARTICULAR FONT, STYLE, SIZE, OR COLOR.

FOR CLOTHING, NAMELY, SHIRTS, T-SHIRTS, RUGBY SHIRTS, POLO SHIRTS, CARDIGANS, JERSEYS, UNIFORMS, PANTS, TANK TOPS, SWEAT SHIRTS, SWEAT PANTS, WARM-UP SUITS, AND JACKETS (U.S. CLS. 22 AND 39).

STEVEN JACKSON, EXAMINING ATTORNEY

CLASS 25—(Continued).

SN 77-166,038. URBAN OUTFITTERS (DELAWARE), INC., PHILADELPHIA, PA. FILED 4-26-2007.

CARTONNIER

THE MARK CONSISTS OF STANDARD CHARACTERS WITHOUT CLAIM TO ANY PARTICULAR FONT, STYLE, SIZE, OR COLOR.

FOR SWEATERS, PANTS, JACKETS, SKIRTS (U.S. CLS. 22 AND 39).

FIRST USE 7-1-2006; IN COMMERCE 7-1-2006.

JASON BLAIR, EXAMINING ATTORNEY

SN 77-166,281. BRIAN REYES, LLC, NEW YORK, NY. FILED 4-26-2007.

brian reyes

THE MARK CONSISTS OF STANDARD CHARACTERS WITHOUT CLAIM TO ANY PARTICULAR FONT, STYLE, SIZE, OR COLOR.

FOR CLOTHING, NAMELY, SHORTS, SHIRTS, PANTS, JACKETS, SKIRTS, DRESSES, HATS, BELTS AND SOCKS (U.S. CLS. 22 AND 39).

FIRST USE 1-1-2005; IN COMMERCE 1-1-2005.

JOHN WILKE, EXAMINING ATTORNEY

SN 77-166,793. ARTSMART, INC, NEW ORLEANS, LA. FILED 4-26-2007.

PELICAN APPAREL

THE MARK CONSISTS OF STANDARD CHARACTERS WITHOUT CLAIM TO ANY PARTICULAR FONT, STYLE, SIZE, OR COLOR.

NO CLAIM IS MADE TO THE EXCLUSIVE RIGHT TO USE "APPAREL", APART FROM THE MARK AS SHOWN. FOR NECKTIES (U.S. CLS. 22 AND 39).

BARNEY CHARLON, EXAMINING ATTORNEY

CLASS 25—(Continued).

SN 77-168,094. BURCAR, MARK S., SHOREWOOD, IL.
FILED 4-27-2007.



FOR APRONS, ATHLETIC FOOTWEAR, ATHLETIC SHOES, ATHLETIC UNIFORMS, BANDANAS, BASEBALL CAPS, BATHING SUITS, BATHING TRUNKS, BATHROBES, BEACH COVER-UPS, BEACH SHOES, BEACH WEAR, BERMUDA SHORTS, BIKINIS, BIKER SHORTS, BODY SUITS, BOXER SHORTS, SPORT BRAS, BRIEFS, CAPS, CHEF'S HAT, COATS, JACKETS, CROP TOPS, DENIM JACKETS, EAR MUFFS, GOLF SHIRTS, GOLF TEE SHIRTS, VESTS, GYM SHORTS, HALTER TOPS, HATS, HEADBANDS AGAINST SWEATING, HEAD WEAR, INFANT WEAR, CHILD CLOTH BIBS, TODDLER WEAR, NAMELY, A ONE PIECE GARMENT FOR TODDLERS, JEANS, JOGGING SUITS, RUNNING SHIRTS, RUNNING SHORTS, LEATHER JACKETS, LEGGINGS, LIGHT REFLECTING JACKETS, LOUNGE WEAR, MOCK TURTLE NECK SWEATERS, NECK BANDS, NECKWEAR, NIGHT SHIRTS, PAJAMAS, PANTIES, PANTS, POLO SHIRTS, PONCHOS, PULLOVERS, RAIN JACKETS, SANDALS, SASHES, SCARVES, SHAWLS, SHIRTS, FLEECE PULLOVERS, SHOES, SHORTS, SLEEP SHIRTS, SLEEP WEAR, SLIPPERS, SNEAKERS, SOCKS, SPORT SHIRTS, SUN VISORS, FISHING HATS, SKULL CAPS, KNIT CAPS, BEANIE CAPS, SWEATBANDS, SWEAT PANTS, SWEATSHIRTS, SWEAT SHORTS, SWEAT SUITS, GLOVES, SWEATERS, SWEAT SOCKS, SWIM CAPS, SWIM TRUNKS, SWIM WEAR, TANK TOPS, T-SHIRTS, VISORS, WIND RESISTANT JACKETS, WRIST BANDS (U.S. CLS. 22 AND 39).
CARYN GLASSER, EXAMINING ATTORNEY

SN 77-169,971. ARTSMART, INC., NEW ORLEANS, LA.
FILED 5-1-2007.

PELICAN COAST

THE MARK CONSISTS OF STANDARD CHARACTERS WITHOUT CLAIM TO ANY PARTICULAR FONT, STYLE, SIZE, OR COLOR.
FOR NECKTIES (U.S. CLS. 22 AND 39).
BARNEY CHARLON, EXAMINING ATTORNEY

SN 77-170,961. WAL-MART STORES, INC., BENTONVILLE, AR. FILED 5-2-2007.

ENERGY NOODLE

THE MARK CONSISTS OF STANDARD CHARACTERS WITHOUT CLAIM TO ANY PARTICULAR FONT, STYLE, SIZE, OR COLOR.
FOR FOOTWEAR (U.S. CLS. 22 AND 39).
SCOTT SISUN, EXAMINING ATTORNEY

CLASS 25—(Continued).

SN 77-170,993. WAL-MART STORES, INC., BENTONVILLE, AR. FILED 5-2-2007.



THE MARK CONSISTS OF THE WORDS ENERGY NOODLE, WITH THE INFINITY SYMBOL, OUTLINED FOR EMPHASIS, USED TO RESEMBLE THE LETTERS "OO" IN THE WORD, "NOODLE".

FOR FOOTWEAR (U.S. CLS. 22 AND 39).
SCOTT SISUN, EXAMINING ATTORNEY

SN 77-171,148. WAL-MART STORES, INC., BENTONVILLE, AR. FILED 5-2-2007.

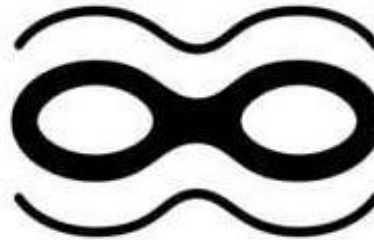

THE MARK CONSISTS OF THE INFINITY SYMBOL OUTLINED FOR EMPHASIS.
FOR FOOTWEAR (U.S. CLS. 22 AND 39).
SCOTT SISUN, EXAMINING ATTORNEY

SN 77-172,009. OXFORD INDUSTRIES, INC., ATLANTA, GA.
FILED 5-3-2007.

Micro cure

THE MARK CONSISTS OF STANDARD CHARACTERS WITHOUT CLAIM TO ANY PARTICULAR FONT, STYLE, SIZE, OR COLOR.
FOR SHIRTS (U.S. CLS. 22 AND 39).
MAUREEN DALL, EXAMINING ATTORNEY

CLASS 25—(Continued).

SN 77-174,294. NBA DEVELOPMENT LEAGUE, LLC, SE-CAUCUS, NJ. FILED 5-7-2007.



NO CLAIM IS MADE TO THE EXCLUSIVE RIGHT TO USE "TULSA", APART FROM THE MARK AS SHOWN.

THE MARK CONSISTS OF A SHIELD, A HIGHWAY, MOUNTAINS, AND A BASKETBALL WITH THE WORDS TULSA 66ERS STYLIZED.

FOR CLOTHING, NAMELY, HOSIERY, FOOTWEAR, BASKETBALL SHOES, BASKETBALL SNEAKERS, T-SHIRTS, SHIRTS, POLO SHIRTS, SWEATSHIRTS, SWEATPANTS, PANTS, TANK TOPS, JERSEYS, SHORTS, PAJAMAS, SPORT SHIRTS, RUGBY SHIRTS, SWEATERS, BELTS, TIES, NIGHTSHIRTS, HATS, CAPS, VISORS, WARM-UP SUITS, WARM-UP PANTS, WARM-UP TOPS/SHOOTING SHIRTS, JACKET, WIND RESISTANT JACKET, PARKA, COATS, BABY BIBS NOT OF PAPER, HEAD BANDS, WRIST BANDS, APRONS, UNDERGARMENTS, BOXER SHORTS, SLACKS, EAR MUFFS, GLOVES, MITTENS, SCARVES, WOVEN AND KNIT SHIRTS, JERSEY DRESSES, DRESSES, CHEER-LEADING DRESSES AND UNIFORMS, SWIM WEAR, BATHING SUITS, SWIMSUITS, BIKINIS, TANKINIS, SWIM TRUNKS, BATHING TRUNKS, BOARD SHORTS, WET SUITS, BEACH COVER-UPS, BATHING SUIT COVER-UPS, BATHING SUIT WRAPS, SANDALS, BEACH SANDALS, BEACH HATS, SUN VISORS, SWIM CAPS, BATHING CAPS, NOVELTY HEADWEAR WITH ATTACHED WIGS (U.S. CLS. 22 AND 39).

CARRIE GENOVESE, EXAMINING ATTORNEY

SN 77-174,944. THE CARTOON NETWORK, INC., ATLANTA, GA. FILED 5-7-2007.

XAVIER: RENEGADE ANGEL

THE MARK CONSISTS OF STANDARD CHARACTERS WITHOUT CLAIM TO ANY PARTICULAR FONT, STYLE, SIZE, OR COLOR.

FOR ATHLETIC SHOES; BANDANAS; BASEBALL CAPS; BEACH COVER-UPS; BEACHWEAR; BELTS; PLASTIC BABY BIBS; BOOTS; CLOTH BIBS; DRESSES; EAR MUFFS; GLOVES; GOLF SHIRTS; HALLOWEEN COSTUMES AND MASKS; HATS; HEAD BANDS; INFANTWEAR; JACKETS; JEANS; JERSEYS; JOGGING SUITS; LINGERIE; MITTENS; NECKTIES; PANTS; PANTIES; POLO SHIRTS; PONCHOS; RAINWEAR; ROBES; SANDALS; SCARVES; SHIRTS; SHOES; SKIRTS; SHORTS; SLIPPERS; SLEEPWEAR; SOCKS; SNEAKERS; SWEATERS; SWEAT PANTS; SWEAT SHIRTS; SWIMSUITS; TANK TOPS; TIGHTS; T-SHIRTS; UNDERWEAR; UNDERSHIRTS; VESTS; WRIST BANDS (U.S. CLS. 22 AND 39).

RAMONA ORTIGA, EXAMINING ATTORNEY

CLASS 25—(Continued).

SN 77-175,077. SCHOONEMAN, TROY ANDREW, BANGKOK, THAILAND, FILED 5-8-2007.

mucho macho

THE MARK CONSISTS OF STANDARD CHARACTERS WITHOUT CLAIM TO ANY PARTICULAR FONT, STYLE, SIZE, OR COLOR.

THE FOREIGN WORDING IN THE MARK TRANSLATES INTO ENGLISH AS VERY MASCULINE.

FOR CLOTHING AND SPORTSWEAR, NAMELY, SWIMWEAR, SHORTS, SHIRTS, SINGLET, UNDERWEAR, HEADWEAR, AND FOOTWEAR (U.S. CLS. 22 AND 39).

TARAH HARDY, EXAMINING ATTORNEY

SN 77-179,097. THE DENALI COMPANY, LLC, RED BANK, NJ. FILED 5-11-2007.



NO CLAIM IS MADE TO THE EXCLUSIVE RIGHT TO USE "WICKS" AND "EVAPORATIVE COOLING", APART FROM THE MARK AS SHOWN.

THE COLOR(S) BLUE, ORANGE IS/ARE CLAIMED AS A FEATURE OF THE MARK.

THE WORDING IN THE MARK IS BLUE. THE CIRCLES ARE VARIOUS SHADES OF ORANGE.

FOR SHIRTS, T-SHIRTS, SWEAT SHIRTS, SHORTS, SWEAT SHORTS, SWEAT PANTS, HEADGEAR, NAMELY, HATS AND CAPS (U.S. CLS. 22 AND 39).

FIRST USE 1-2-2004; IN COMMERCE 3-2-2004.

PAUL F. GAST, EXAMINING ATTORNEY

SN 77-184,612. JLSS, LLC, ROYAL OAK, MI. FILED 5-18-2007.

GARDEN HOE.

THE MARK CONSISTS OF STANDARD CHARACTERS WITHOUT CLAIM TO ANY PARTICULAR FONT, STYLE, SIZE, OR COLOR.

FOR T-SHIRTS; HATS; FOOTWEAR; JACKETS; SWEAT PANTS; SWEAT SHIRTS; SWEAT SHORTS; SWEAT SUITS; UNDER GARMENTS; SHIRTS; BOXER SHORTS; TANK TOPS; PANTS; SHORTS (U.S. CLS. 22 AND 39).

DANIEL BRODY, EXAMINING ATTORNEY

CLASS 25—(Continued).

SN 77-185,274. S. LOWREY HEAVER, MALVERN, PA. FILED 5-18-2007.

A PERSONAL HUG

THE MARK CONSISTS OF STANDARD CHARACTERS WITHOUT CLAIM TO ANY PARTICULAR FONT, STYLE, SIZE, OR COLOR.

FOR SEWN CLOTH SASH, WITH A POCKET TO HOLD A PERSONAL NOTE, RESEMBLING ARMS COMPLETE WITH HANDS THAT WRAP AROUND RECIPIENT AND FASTEN TO FORM A HUG (U.S. CLS. 22 AND 39).

WENDY GOODMAN, EXAMINING ATTORNEY

CLASS 25—(Continued).

SN 77-188,918. SEVEN WELLS, LLC, NEWPORT BEACH, CA. FILED 5-23-2007.

WORLD INDUSTRIES

THE MARK CONSISTS OF STANDARD CHARACTERS WITHOUT CLAIM TO ANY PARTICULAR FONT, STYLE, SIZE, OR COLOR.

OWNER OF U.S. REG. NOS. 2,099,036 AND 2,101,100.

NO CLAIM IS MADE TO THE EXCLUSIVE RIGHT TO USE "INDUSTRIES", APART FROM THE MARK AS SHOWN.

FOR FOOTWEAR (U.S. CLS. 22 AND 39).

MORGAN WYNNE, EXAMINING ATTORNEY

SN 77-186,418. MANNING TRADING CO., INC., SOUTH SAN FRANCISCO, CA. FILED 5-21-2007.

TRIA

THE MARK CONSISTS OF STANDARD CHARACTERS WITHOUT CLAIM TO ANY PARTICULAR FONT, STYLE, SIZE, OR COLOR.

FOR WOMEN'S SPORTSWEAR, NAMELY, JACKETS (U.S. CLS. 22 AND 39).

FIRST USE 6-6-2007; IN COMMERCE 6-6-2007.

AMY MCMENAMIN, EXAMINING ATTORNEY



SN 77-188,924. SEVEN WELLS, LLC, NEWPORT BEACH, CA. FILED 5-23-2007.

OWNER OF U.S. REG. NOS. 2,099,036 AND 2,101,100. NO CLAIM IS MADE TO THE EXCLUSIVE RIGHT TO USE "INDUSTRIES", APART FROM THE MARK AS SHOWN.

THE MARK CONSISTS OF A CARTOON DEPICTION OF A DEVIL HOLDING A PITCHFORK, WHERE THE PRONGS OF THE PITCHFORK FORM THE W IN THE TERM WORLD INDUSTRIES.

FOR FOOTWEAR (U.S. CLS. 22 AND 39).

MORGAN WYNNE, EXAMINING ATTORNEY

SN 77-187,328. FOREMOST DESIGNERS, LTD., NEW YORK, NY. FILED 5-22-2007.

INT'S

THE MARK CONSISTS OF STANDARD CHARACTERS WITHOUT CLAIM TO ANY PARTICULAR FONT, STYLE, SIZE, OR COLOR.

FOR CLOTHING, NAMELY, DRESSES SKIRTS, TOPS, BLOUSES, PANTS, SWEATERS, JACKETS, COATS AND SUITS (U.S. CLS. 22 AND 39).

ANGELA M. MICHELI, EXAMINING ATTORNEY

SN 77-189,599. HOLLYWOOD FASHION TAPE, INC., MINNEAPOLIS, MN. FILED 5-24-2007.

HOLLYWOOD EXTRAS

THE MARK CONSISTS OF STANDARD CHARACTERS WITHOUT CLAIM TO ANY PARTICULAR FONT, STYLE, SIZE, OR COLOR.

OWNER OF U.S. REG. NOS. 2,800,109 AND 3,107,397.

FOR LINGERIE ACCESSORIES, NAMELY, REMOVABLE SILICONE BREAST ENHANCER PADS USED IN A BRA (U.S. CLS. 22 AND 39).

TANYA AMOS, EXAMINING ATTORNEY

CLASS 25—(Continued).

SN 77-193,048. LADON ECHOLS, MIAMI, FL. FILED 5-30-2007.

No One Is Innocent

THE MARK CONSISTS OF STANDARD CHARACTERS WITHOUT CLAIM TO ANY PARTICULAR FONT, STYLE, SIZE, OR COLOR.

FOR T-SHIRTS (U.S. CLS. 22 AND 39).
TRACY CROSS, EXAMINING ATTORNEY

SN 77-196,825. ELAN-POLO, INC., NASHVILLE, TN. FILED 6-4-2007.

WALK 'N' ROLL SHOE

THE MARK CONSISTS OF STANDARD CHARACTERS WITHOUT CLAIM TO ANY PARTICULAR FONT, STYLE, SIZE, OR COLOR.

NO CLAIM IS MADE TO THE EXCLUSIVE RIGHT TO USE "SHOE", APART FROM THE MARK AS SHOWN.
FOR FOOTWEAR (U.S. CLS. 22 AND 39).
ANDREA K. NADELMAN, EXAMINING ATTORNEY

SN 77-197,564. RUSSELL CORPORATION, ATLANTA, GA. FILED 6-5-2007.



THE MARK CONSISTS OF TWO VERTICAL BOOMERANG SHAPES THAT INTERLOCK BUT DO NOT TOUCH.
FOR CLOTHING, NAMELY BRAS, SPORTS BRAS, SHORTS, PANTS, SHIRTS, AND JACKETS; FOOTWEAR, NAMELY ATHLETIC FOOTWEAR, CASUAL FOOTWEAR, AND SANDALS (U.S. CLS. 22 AND 39).
AISHA SALEM, EXAMINING ATTORNEY

CLASS 25—(Continued).

SN 77-203,517. DELTA GALIL INDUSTRIES LTD., NEW YORK, NY. FILED 6-12-2007.

The Featherweight Bra

THE MARK CONSISTS OF STANDARD CHARACTERS WITHOUT CLAIM TO ANY PARTICULAR FONT, STYLE, SIZE, OR COLOR.

NO CLAIM IS MADE TO THE EXCLUSIVE RIGHT TO USE "BRA", APART FROM THE MARK AS SHOWN.
FOR BRASSIERES; CAMISOLES; NIGHT GOWNS; SWIMSUITS (U.S. CLS. 22 AND 39).
GIANCARLO CASTRO, EXAMINING ATTORNEY

SN 77-207,659. SWAT.FAME, INC., CITY OF INDUSTRY, CA. FILED 6-15-2007.

LOVE, HUGS N' KISSES

THE MARK CONSISTS OF STANDARD CHARACTERS WITHOUT CLAIM TO ANY PARTICULAR FONT, STYLE, SIZE, OR COLOR.

OWNER OF U.S. REG. NO. 2,124,710.
FOR CLOTHING AND WEARING APPAREL, NAMELY, JEANS, SHIRTS, BLOUSES, DRESSES, JUMPERS, JACKETS, PANTS, SHORTS, SKIRTS (U.S. CLS. 22 AND 39).

FIRST USE 7-17-1995; IN COMMERCE 7-17-1995.
DAVID H. STINE, EXAMINING ATTORNEY

SN 77-209,279. OXFORD INDUSTRIES, INC., ATLANTA, GA. FILED 6-19-2007.

Pant Guard

THE MARK CONSISTS OF STANDARD CHARACTERS WITHOUT CLAIM TO ANY PARTICULAR FONT, STYLE, SIZE, OR COLOR.

NO CLAIM IS MADE TO THE EXCLUSIVE RIGHT TO USE "PANT", APART FROM THE MARK AS SHOWN.
FOR PANTS (U.S. CLS. 22 AND 39).
MAUREEN DALL, EXAMINING ATTORNEY

CLASS 25—(Continued).

SN 77-211,576. OXFORD INDUSTRIES, INC., ATLANTA, GA.
FILED 6-21-2007.

Energy Saving

THE MARK CONSISTS OF STANDARD CHARACTERS
WITHOUT CLAIM TO ANY PARTICULAR FONT, STYLE,
SIZE, OR COLOR.
FOR SHIRTS (U.S. CLS. 22 AND 39).
MAUREEN DALL, EXAMINING ATTORNEY

SN 77-214,125. OXFORD INDUSTRIES, INC., ATLANTA, GA.
FILED 6-25-2007.

Perma Shape Collar

THE MARK CONSISTS OF STANDARD CHARACTERS
WITHOUT CLAIM TO ANY PARTICULAR FONT, STYLE,
SIZE, OR COLOR.
NO CLAIM IS MADE TO THE EXCLUSIVE RIGHT TO
USE "COLLAR", APART FROM THE MARK AS SHOWN.
FOR SHIRTS (U.S. CLS. 22 AND 39).
MAUREEN DALL, EXAMINING ATTORNEY

SN 77-215,825. NAUTICA APPAREL, INC., NEW YORK, NY.
FILED 6-26-2007.

POWERFULLY FIT

THE MARK CONSISTS OF STANDARD CHARACTERS
WITHOUT CLAIM TO ANY PARTICULAR FONT, STYLE,
SIZE, OR COLOR.
FOR HATS; SHIRTS; T-SHIRTS; PANTS; SHORTS (U.S.
CLS. 22 AND 39).
DOMINIC J. FERRAIUOLO, EXAMINING ATTORNEY

CLASS 25—(Continued).

SN 77-216,358. ALFRED, KAREEM A., BRONX, NY. FILED
6-27-2007.

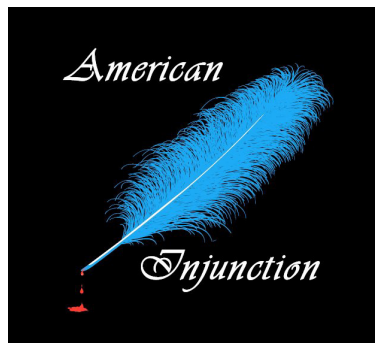

NO CLAIM IS MADE TO THE EXCLUSIVE RIGHT TO
USE "AMERICAN", APART FROM THE MARK AS SHOWN.
THE COLOR(S) BLUE, RED, BLACK AND WHITE IS/ARE
CLAIMED AS A FEATURE OF THE MARK.

THE COLOR BLUE APPEARS IN THE QUILL; THE
COLOR RED APPEARS IN THE INK OR BLOOD DRIPPING
FROM THE QUILL; THE COLOR BLACK APPEARS AND
THE BACKGROUND FILL COLOR OF THE CARRIER
RECTANGLE; AND THE COLOR WHITE APPEARS IN
THE LITERAL PORTION "AMERICAN INJUNCTION"
AND IN THE STEM OF THE QUILL.

FOR BOXER SHORTS; SHIRTS; PANTS; HATS; SOCKS;
JEANS (U.S. CLS. 22 AND 39).

FIRST USE 6-25-2007; IN COMMERCE 6-25-2007.
BENJAMIN OKEKE, EXAMINING ATTORNEY

SN 77-228,930. WRANGLER APPAREL CORP., WILMING-
TON, DE. FILED 7-13-2007.

WRANGLER HERO

THE MARK CONSISTS OF STANDARD CHARACTERS
WITHOUT CLAIM TO ANY PARTICULAR FONT, STYLE,
SIZE, OR COLOR.

OWNER OF U.S. REG. NOS. 1,842,413, 2,575,861 AND
OTHERS.

FOR LEATHER BELTS (U.S. CLS. 22 AND 39).
FIRST USE 4-28-1993; IN COMMERCE 4-28-1993.

KENNETH E. SHARPERSON, EXAMINING ATTORNEY

CLASS 25—(Continued).

SN 78-611,795. PUSSER'S WEST INDIES LIMITED, ROAD TOWN, TORTOLA, BR.VIRGIN ISLANDS, FILED 4-19-2005.

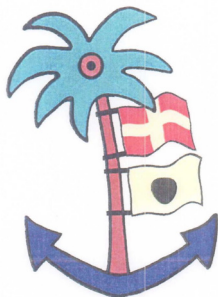

THE COLOR(S) BLACK, GREEN, BROWN, RED, BLUE AND YELLOW IS/ARE CLAIMED AS A FEATURE OF THE MARK.

THE COLOR BLACK APPEARS IN THE CENTER OF THE CIRCULAR DESIGN ELEMENT AT THE TOP OF THE PALM TREE, IN THE OUTLINE OF THE CIRCULAR DESIGN ELEMENT AT THE TOP OF THE PALM TREE, IN THE CIRCULAR DESIGN IN THE LOWER FLAG, IN THE STRAPS FOR THE FLAGS, AND IN THE OUTLINE OF THE MARK; THE COLOR GREEN APPEARS IN THE LEAVES OF THE PALM TREE; THE COLOR BROWN APPEARS IN THE LIGHTER SHADED AREA SURROUNDING THE CENTER OF THE CIRCULAR DESIGN ELEMENT AT THE TOP OF THE PALM TREE AND IN THE TRUNK OF THE PALM TREE; THE COLOR RED APPEARS IN THE BACKGROUND OF THE TOP FLAG IN THE DRAWING; THE COLOR YELLOW APPEARS IN THE CROSS DESIGN IN THE TOP FLAG AND IN THE BACKGROUND OF THE LOWER FLAG; AND THE COLOR BLUE APPEARS IN THE DEPICTION OF THE ANCHOR AT THE BOTTOM OF THE DRAWING

FOR MEN'S, WOMEN'S, AND CHILDREN'S CLOTHING, NAMELY JACKETS, COATS, RAINCOATS, BLAZERS, SHOES, SHIRTS, POLO SHIRTS, COLLARED SHIRTS, TANK TOPS, BLOUSES, SLACKS, PANTS, TRACK PANTS, JEANS, SKIRTS, DRESSES, JUMPERS, SWEATERS, TIES, BELTS OF TEXTILE, LEATHER BELTS, SCARVES, HATS, CAPS, SOCKS, JERSEYS, SWEATSHIRTS, SWEATPANTS, SLEEPWEAR, SHIRTS, SHORT SETS, BOXER SHORTS, PULLOVERS, SUITS, SWIMSUITS, SWIM TRUNKS (U.S. CLS. 22 AND 39).

FIRST USE 11-0-2004; IN COMMERCE 11-0-2004.
MICHAEL GAAFAR, EXAMINING ATTORNEY

SN 78-711,644. WATKINS GLEN INTERNATIONAL, INC., DAYTONA BEACH, FL. FILED 9-13-2005.



OWNER OF U.S. REG. NOS. 1,366,768, 1,862,034 AND OTHERS.

FOR CLOTHING, NAMELY, T-SHIRTS, COLLARED SHIRTS, SPORT SHIRTS, SWEATSHIRTS, SLEEVELESS TANK TOPS, JACKETS, SWEATERS, CAPS, HATS, SUN VISORS, SHORTS, PANTS, SHOES, SOCKS, BELTS, BANDANAS, AND HEADBANDS (U.S. CLS. 22 AND 39).
MARY BOAGNI, EXAMINING ATTORNEY

CLASS 25—(Continued).

SN 78-770,644. AYMB DIGITAL INC, LOS ANGELES, CA. FILED S.R. 12-9-2005; AM. P.R. 12-19-2006.

akiko

THE MARK CONSISTS OF STANDARD CHARACTERS WITHOUT CLAIM TO ANY PARTICULAR FONT, STYLE, SIZE, OR COLOR.

FOR WOMEN'S AND MEN'S CLOTHING, NAMELY T-SHIRTS, TOPS, BLOUSES, DRESSES, JACKETS, PANTS, SHORTS, SOCKS, SWIMWEAR, SHOES, SWEATERS, SHIRTS, BELTS, HATS, SCARVES, GLOVES, LINGERIE (U.S. CLS. 22 AND 39).

FIRST USE 1-15-2003; IN COMMERCE 1-15-2003.
DAVID ELTON, EXAMINING ATTORNEY

SN 78-783,585. BABY GASSY GOOMA, LLC, ARDEN, NC. AND BABY GASSY GOOMA, LLC, ARDEN, NC. FILED 1-2-2006.

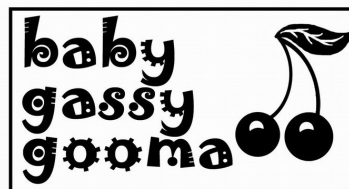

NO CLAIM IS MADE TO THE EXCLUSIVE RIGHT TO USE "BABY", APART FROM THE MARK AS SHOWN.

THE MARK CONSISTS OF THREE WORDS AND A CHERRY INSIDE A RECTANGULAR CHECKED BORDER. FOR SHIRTS, PANTS, JEANS, DRESSES, SKIRTS, BLOUSES, COATS AND HEADWEAR (U.S. CLS. 22 AND 39).

DOMINICK J. SALEMI, EXAMINING ATTORNEY

SN 78-784,790. COQUETTE INTERNATIONAL INC., WATERLOO, ONTARIO, CANADA, FILED 1-4-2006.

LA PETITE COQUETTE

THE MARK CONSISTS OF STANDARD CHARACTERS WITHOUT CLAIM TO ANY PARTICULAR FONT, STYLE, SIZE, OR COLOR.

OWNER OF U.S. REG. NOS. 2,312,799 AND 2,545,681. FOR GARTER BELTS; GLOVES; LINGERIE; PANTS; SHORTS; STOCKINGS; TOP COATS (U.S. CLS. 22 AND 39).

FIRST USE 4-0-2004; IN COMMERCE 4-0-2004.
NELSON SNYDER, EXAMINING ATTORNEY

CLASS 25—(Continued).

SN 78-796,009. DEER STAGS, INC., NEW YORK, NY. FILED 1-20-2006.

GLIDERS

THE MARK CONSISTS OF STANDARD CHARACTERS WITHOUT CLAIM TO ANY PARTICULAR FONT, STYLE, SIZE, OR COLOR.

FOR ADULT COMFORT FOOTWEAR. (U.S. CLS. 22 AND 39).

FIRST USE 2-10-2006; IN COMMERCE 2-10-2006.
MARK PILARO, EXAMINING ATTORNEY

CLASS 25—(Continued).

SN 78-810,231. HARLAN BRANDON HOLDING COMPANY, L.L.C., UPPER MONTCLAIR, NJ. FILED 2-8-2006.



THE NAME(S), PORTRAIT(S), AND/OR SIGNATURE(S) SHOWN IN THE MARK IDENTIFIES HARLAN BRANDON, WHOSE CONSENT(S) TO REGISTER IS SUBMITTED.

FOR FOOTWEAR AND SHOES (U.S. CLS. 22 AND 39).
FIRST USE 6-30-1997; IN COMMERCE 6-30-1997.
SHANNON TWOHIG, EXAMINING ATTORNEY

SN 78-807,046. GOLDSTEIN, ADAM, SHERMAN OAKS, CA. FILED 2-3-2006.

LAX

THE MARK CONSISTS OF STANDARD CHARACTERS WITHOUT CLAIM TO ANY PARTICULAR FONT, STYLE, SIZE, OR COLOR.

FOR CLOTHING, NAMELY, SHIRTS, JACKETS, PANTS; HATS (U.S. CLS. 22 AND 39).
JAY BESCH, EXAMINING ATTORNEY

SN 78-833,581. STRIKE INVESTMENTS, LLC, LOVELAND, OH. FILED 3-9-2006.

FIBRIQ

THE MARK CONSISTS OF STANDARD CHARACTERS WITHOUT CLAIM TO ANY PARTICULAR FONT, STYLE, SIZE, OR COLOR.

FOR CLOTHING, NAMELY, SHIRTS, PANTS, DRESSES, BLOUSES, UNDERWEAR AND SOCKS; FOOTWEAR AND HEADWEAR (U.S. CLS. 22 AND 39).
AMY MCMENAMIN, EXAMINING ATTORNEY

SN 78-810,185. HARLAN BRANDON HOLDING COMPANY, L.L.C., UPPER MONTCLAIR, NJ. FILED 2-8-2006.

HARLAN BRANDON

THE MARK CONSISTS OF STANDARD CHARACTERS WITHOUT CLAIM TO ANY PARTICULAR FONT, STYLE, SIZE, OR COLOR.

THE NAME(S), PORTRAIT(S), AND/OR SIGNATURE(S) SHOWN IN THE MARK IDENTIFIES HARLAN BRANDON, WHOSE CONSENT(S) TO REGISTER IS SUBMITTED.

FOR FOOTWEAR AND SHOES (U.S. CLS. 22 AND 39).
FIRST USE 6-30-1997; IN COMMERCE 6-30-1997.
SHANNON TWOHIG, EXAMINING ATTORNEY

SN 78-841,291. RIVER HILLS WILSONS, INC., BROOKLYN PARK, MN. FILED 3-20-2006.

M. JULIAN

THE MARK CONSISTS OF STANDARD CHARACTERS WITHOUT CLAIM TO ANY PARTICULAR FONT, STYLE, SIZE, OR COLOR.

THE NAME "M. JULIAN" IDENTIFIES A LIVING INDIVIDUAL WHOSE CONSENT IS OF RECORD.

FOR LEATHER AND CLOTH OVERCOATS, JACKETS (U.S. CLS. 22 AND 39).
FIRST USE 1-5-1980; IN COMMERCE 1-5-1980.
CAROLINE WOOD, EXAMINING ATTORNEY

CLASS 25—(Continued).

SN 78-880,353. NBA PROPERTIES, INC., NEW YORK, NY.
FILED 5-10-2006.



OWNER OF U.S. REG. NOS. 1,505,559, 1,833,902 AND OTHERS.

NO CLAIM IS MADE TO THE EXCLUSIVE RIGHT TO USE "LATINO", APART FROM THE MARK AS SHOWN.

THE MARK CONSISTS OF THE STYLIZED WORDS NBA LATINO WITH A GLOBE AND A SILHOUETTE OF A BASKETBALL PLAYER.

FOR CLOTHING, NAMELY HOSIERY, FOOTWEAR, BASKETBALL SHOES, BASKETBALL SNEAKERS, T-SHIRTS, SHIRTS, POLO SHIRTS, SWEATSHIRTS, SWEATPANTS, PANTS, TANK TOPS, JERSEYS, SHORTS, PAJAMAS, SPORT SHIRTS, RUGBY SHIRTS, SWEATERS, BELTS, TIES, NIGHTSHIRTS, HATS, CAPS, VISORS, WARM-UP SUITS, WARM-UP PANTS, WARM-UP TOPS/SHOOTING SHIRTS, JACKETS, WIND RESISTANT JACKETS, PARKAS, COATS, BABY BIBS NOT OF PAPER, HEAD BANDS, WRIST BANDS, APRONS, UNDERGARMENTS, BOXER SHORTS, SLACKS, EAR MUFFS, GLOVES, MITTENS, SCARVES, WOVEN AND KNIT SHIRTS, JERSEY DRESSES, DRESSES, CHEERLEADING DRESSES AND UNIFORMS, SWIM WEAR, BATHING SUITS, SWIMSUITS, BIKINIS, TANKINIS, SWIM TRUNKS, BATHING TRUNKS, BOARD SHORTS, WET SUITS, BEACH COVER-UPS, BATHING SUIT COVER-UPS, BATHING SUIT WRAPS, SANDALS, BEACH SANDALS, BEACH HATS, SUN VISORS, SWIM CAPS, BATHING CAPS, NOVELTY HEADWEAR WITH ATTACHED WIGS (U.S. CLS. 22 AND 39).

FIRST USE 2-17-2006; IN COMMERCE 2-17-2006.

WOODROW HARTZOG, EXAMINING ATTORNEY

SN 78-929,630. MOTHERS IN LOVE WITH FASHION, SANTA MONICA, CA. FILED 7-14-2006.

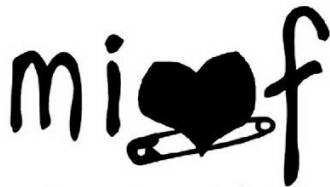

FOR T-SHIRTS, BABY T'S, SWEATSHIRTS, SWEATPANTS, PANTS, SHORTS, SOCKS, TANK TOPS, BELTS, BLOUSES, SKIRTS, DRESSES AND SWEATERS (U.S. CLS. 22 AND 39).

FIRST USE 10-1-2005; IN COMMERCE 11-15-2005.

KEVON CHISOLM, EXAMINING ATTORNEY

CLASS 25—(Continued).

SN 78-933,926. HALL, ANTHONY C, HENDERSON, NV.
FILED 7-20-2006.

REPUKES

THE MARK CONSISTS OF STANDARD CHARACTERS WITHOUT CLAIM TO ANY PARTICULAR FONT, STYLE, SIZE, OR COLOR.

FOR CLOTHING, NAMELY, SHIRTS, T-SHIRTS, UNDER SHIRTS, NIGHT SHIRTS, RUGBY SHIRTS, POLO SHIRTS, CARDIGANS, JERSEYS, UNIFORMS, SMOCKS, DRESS SHIRTS, PANTS, TROUSERS, SLACKS, JEANS, CULOTTES, CARGO PANTS, STRETCH PANTS, DENIM JEANS, OVERALLS, COVERALLS, JUMPERS, JUMP SUITS, SHORTS, BOXER SHORTS, TOPS, STRETCH TOPS, CROP TOPS, TANK TOPS, HALTER TOPS, SWEAT SHIRTS, SWEAT SHORTS, SWEAT PANTS, WRAPS, WARM-UP SUITS, JOGGING SUITS, TRACK SUITS, PLAY SUITS, BLOUSES, SKIRTS, DRESSES, GOWNS, SWEATERS, VESTS, FLEECE VESTS, PULLOVERS, SNOW SUITS, PARKAS, CAPES, ANORAKS, PONCHOS, JACKETS, REVERSIBLE JACKETS, SHELL JACKETS, COATS, HEAVY COATS, BLAZERS, SUITS, TURTLENECKS, CLOTH SKI BIBS, SWIMWEAR, BEACHWEAR, TENNIS WEAR, SURF WEAR, SKI WEAR, LAYETTES, INFANTWEAR, CAPS, SWIM CAPS, BERETS, BEANIES, HATS, VISORS, HEADBANDS, WRIST BANDS, SWEAT BANDS, HEADWEAR, EAR MUFFS, APRONS, SCARVES, BANDANAS, BELTS, SUSPENDERS, NECKWEAR, TIES, NECKERCHIEFS, ASCOTS, UNDERWEAR, THERMAL UNDERWEAR, LONG UNDERWEAR, BRIEFS, SWIM AND BATHING TRUNKS, BRAS, SPORTS BRAS, BRASSIERES, BUSTIERS, CORSETS, PANTIES, THONGS, G-STRINGS, GARTERS AND GARTER BELTS, TEDDIES, GIRDLES, FOUNDATION GARMENTS, SINGLETS, SOCKS, LOUNGEWEAR, ROBES, SMOCKS, UNDERCLOTHES, PAJAMAS, SLEEPWEAR, NIGHT GOWNS, LINGERIE, CAMISOLES, NEGLIGEEES, CHEMISES, CHEMISETTES, SLIPS, SARONGS, LEG WARMERS, HOSIERY, PANTYHOSE, BODY STOCKINGS, KNEE HIGHS, LEGGINGS, TIGHTS, LEOTARDS, BODY SUITS, UNITARDS, BODY SHAPERS, GLOVES, MITTENS, RAINWEAR, FOOTWEAR, SHOES, SNEAKERS, BOOTS, GALOSHES, SANDALS, FLIP-FLOPS, AND SLIPPERS (U.S. CLS. 22 AND 39).

MICHAEL LEWIS, EXAMINING ATTORNEY

CLASS 25—(Continued).

SN 78-936,343. ALMARINEZ, DEVON, ANTIOCH, CA. FILED 7-24-2006.



NO CLAIM IS MADE TO THE EXCLUSIVE RIGHT TO USE "CLOTHING", APART FROM THE MARK AS SHOWN. FOR CLOTHING, NAMELY, T-SHIRTS, SHIRTS, JACKETS, PANTS, SHORTS, SKIRTS, SWEATERS, SWEATSHIRTS, HATS, AND JEANS (U.S. CLS. 22 AND 39).

ARETHA SOMERVILLE, EXAMINING ATTORNEY

SN 78-936,430. LOPEZ, NORMA JEAN, DBA STARS AT NOON, LOS ANGELES, CA. FILED 7-24-2006.

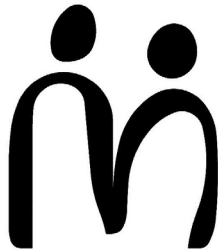

MARY & MAGGIE

FOR BELTS ; BELTS MADE OF LEATHER; DENIM JACKETS; DENIMS ; DRESSES; JACKETS; JEANS; MEN AND WOMEN JACKETS, COATS, TROUSERS, VESTS; PAJAMAS; SHIRTS; SHORT-SLEEVED OR LONG-SLEEVED T-SHIRTS; SLEEVED OR SLEEVELESS JACKETS (U.S. CLS. 22 AND 39).

BARNEY CHARLON, EXAMINING ATTORNEY

CLASS 25—(Continued).

SN 78-936,526. LOPEZ, NORMA JEAN, DBA: STARS AT NOON, LOS ANGELES, CA. FILED 7-24-2006.

MARY & MAGGIE

THE NAMES MARY AND MAGGIE DOES NOT IDENTIFY A LIVING INDIVIDUAL.

FOR BELTS ; BELTS MADE OF LEATHER; DENIM JACKETS; DENIMS ; DRESSES; JACKETS; JEANS; MEN AND WOMEN JACKETS, COATS, TROUSERS, VESTS; PAJAMAS; SHIRTS; SHORT-SLEEVED OR LONG-SLEEVED T-SHIRTS; SLEEVED OR SLEEVELESS JACKETS (U.S. CLS. 22 AND 39).

LINDA ESTRADA, EXAMINING ATTORNEY

SN 78-942,942. GUGA KUERTEN PARTICIPACOES E EMPREENDIMENTOS LTDA., FLORIANOPOLIS, SC, BRAZIL, FILED 8-2-2006.

G U G A

THE NAME "GUGA" IDENTIFIES A LIVING INDIVIDUAL WHOSE CONSENT IS OF RECORD.

FOR BEACHWEAR, BATHING-TRUNKS, BATHINGSUITS, BATH ROBES, PANTS, TROUSERS, SHIRTS, T-SHIRTS, BELTS, HEADGEAR, NAMELY, HATS, CAPS, BANDANAS, HEADBANDS; GABARDINES, RAINCOATS, WINDBREAKERS, WATERPROOF JACKETS; CLOTHING FOR GYMNASTICS, NAMELY, LEGGINGS, BERMUDA SHORTS, GYM SHORTS, SHIRTS, T-SHIRTS, GYM SUITS, GYM TROUSERS, SWEAT PANTS, JACKETS, JUMPSUITS; SASHES, HOSIERY, SOCKS, PAJAMAS, GAITERS, DRESSING GOWNS, UNDERWEAR, UNDERCLOTHING, SKIRTS; MEN'S, WOMEN'S AND CHILDREN'S FOOTWEAR, NAMELY, TENNIS SHOES, SANDALS, MULES, SHOES, AND SLIPPERS (U.S. CLS. 22 AND 39).

DORITT L. CARROLL, EXAMINING ATTORNEY

SN 78-943,448. 5TH & OCEAN CLOTHING, INC., HIALEAH, FL. FILED 8-2-2006.

Performance Lifestyle

THE MARK CONSISTS OF STANDARD CHARACTERS WITHOUT CLAIM TO ANY PARTICULAR FONT, STYLE, SIZE, OR COLOR.

FOR MENS, WOMENS, AND CHILDRENS SPORTSWEAR AND APPAREL, NAMELY, T-SHIRTS, SHIRTS, SHORTS, DRESSES, SWEATSHIRTS, LONG SLEEVE T-SHIRTS (U.S. CLS. 22 AND 39).

BARBARA RUTLAND, EXAMINING ATTORNEY

CLASS 25—(Continued).

SN 78-959,375. ST. LOUIS RAMS PARTNERSHIP, ST. LOUIS, MO. FILED 8-24-2006.

RAMS

THE MARK CONSISTS OF STANDARD CHARACTERS WITHOUT CLAIM TO ANY PARTICULAR FONT, STYLE, SIZE, OR COLOR.

OWNER OF U.S. REG. NOS. 971,048, 3,052,567 AND OTHERS.

FOR MEN'S, WOMEN'S AND CHILDREN'S CLOTHING, NAMELY, FLEECE TOPS AND BOTTOMS, HEADWEAR, CAPS, KNIT HATS, T-SHIRTS, SWEATSHIRTS, SHORTS, TANK TOPS, SWEATERS, PANTS, JACKETS, GOLF SHIRTS, KNIT SHIRTS, JERSEYS, GLOVES, TIES, CLOTH BIBS, SLEEPWEAR, NAMELY, PAJAMAS, ROBES, APRONS, UNDERWEAR, AND SOCKS (U.S. CLS. 22 AND 39).

FIRST USE 9-0-1990; IN COMMERCE 9-0-1990.
CHRIS WELLS, EXAMINING ATTORNEY

CLASS 25—(Continued).

SN 78-961,462. SOUMAHORO, SOUMAILA, BRONX, NY, AND KALFANE, ABIDILLAH, BRONX, NY. FILED 8-28-2006.



FOR CLOTHING NAMELY CAPRI PANTS, JOGGING PANTS, PANTS, JACKETS, DENIMS, DRESS SHIRTS, HATS, COATS, TROUSERS, VESTS, SHIRTS, BELTS, MEN'S AND WOMEN'S FOOTWEAR, SPORTING APPAREL, NAMELY, SPORTS SHIRTS, SPORTS JERSEYS, SHORTS, SWEAT PANTS, SWEAT SHIRTS, T-SHIRTS, AND TRACK PANTS (U.S. CLS. 22 AND 39).

FIRST USE 1-1-2006; IN COMMERCE 1-1-2006.
VERNA BETH RIRIE, EXAMINING ATTORNEY

SN 78-960,306. ROCK & REPUBLIC ENTERPRISES, INC., CULVER CITY, CA. FILED 8-25-2006.

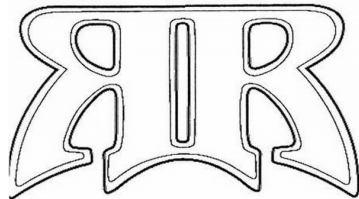

FOR MEN'S AND WOMEN'S CLOTHING AND FOOTWEAR, NAMELY TOPS, SHIRTS, PANTS, BLOUSES, COVER-UPS, SKIRTS, JUMPERS, ROMPERS, SHORTS, JUMPSUITS, JACKETS, LINGERIE, SWIMSUITS, SASHES, SHOES, SNEAKERS, SANDALS, BOOTS, HOSIERY, CLOGS, BELTS AND HEAD WEAR (U.S. CLS. 22 AND 39).

WILLIAM P. SHANAHAN, EXAMINING ATTORNEY

SN 78-964,741. HOHE-MODELLE, MARIA HOHE GMBH & CO. KG, PEGNITZ, FED REP GERMANY, FILED 8-31-2006.

PL.05

THE MARK CONSISTS OF STANDARD CHARACTERS WITHOUT CLAIM TO ANY PARTICULAR FONT, STYLE, SIZE, OR COLOR.

PRIORITY CLAIMED UNDER SEC. 44(D) ON FED REP GERMANY APPLICATION NO. 306463059, FILED 7-24-2006, REG. NO. 30646305, DATED 8-30-2006, EXPIRES 7-31-2016.

FOR CHILDREN'S CLOTHING, NAMELY, COATS, JACKETS, WAIST COATS, TROUSERS, SKIRTS, SHIRTS, BLOUSES, SHORTS, JEANS, JUMP SUITS, JUMP DRESSES, DRESSES, OVERALLS, T-SHIRTS, PULL-OVERS, SWEATERS, VESTS, TRUNKS, PANTYHOSE, SOCKS, GLOVES, NECKERCHIEFS, SCARVES, SHAWLS, BELTS, FOOTWEAR, HEADGEAR, NAMELY, HATS, CAPS, BONNETS, BANDEAUS AND HEAD SCARVES (U.S. CLS. 22 AND 39).

GEORGIA CARTY, EXAMINING ATTORNEY

CLASS 25—(Continued).

SN 78-965,065. CARRANZA, GABRIEL, POMONA, CA.
FILED 8-31-2006.

UZZIEL

THE MARK CONSISTS OF STANDARD CHARACTERS WITHOUT CLAIM TO ANY PARTICULAR FONT, STYLE, SIZE, OR COLOR.

FOR CLOTHING, NAMELY, WARM UP SUITS, JOGGING SUITS, SWEAT SUITS, SWEAT PANTS AND SWEAT SHIRTS, SWIM WEAR, BATHING SUITS, BEACH AND BATHING COVER UPS, SUITS, SLACKS, TROUSERS, PANTS, JEANS, SHORTS, SWEAT SHORTS, GYM SHORTS, TOPS, JACKETS, COATS, SPORT COATS, SHIRTS, SPORT SHIRTS, T-SHIRTS, KNIT SHIRTS, POLO SHIRTS, PULLOVERS, SWEATERS, VESTS, TANK TOPS, BLAZERS, JUMP SUITS, PLAY SUITS, OVERCOATS, PARKAS, WIND RESISTANT JACKETS, LEATHER JACKETS, FOOTWEAR, SHOES, BOOTS, SLIPPERS, ATHLETIC FOOTWEAR, BASKETBALL SHOES, CASUAL FOOTWEAR, SANDALS, HEAD WEAR, HATS, CAPS, VISORS, HOODS, BERETS, HEADBANDS, SWEAT BANDS, WRISTBANDS, EAR MUFFS, NECKWEAR, NECKTIES, NECKERCHIEFS, SCARVES, BANDANNAS, SLEEP WEAR, ROBES, PAJAMAS, NIGHTSHIRTS, GOWNS, CLOTH BIBS, RAIN WEAR, GLOVES, MITTENS, GALOSHES, LOUNGE WEAR, UNDERWEAR, BRIEFS, UNDERPANTS, BOXER SHORTS, UNDERSHIRTS, SUSPENDERS, HOSIERY, SOCKS, BELTS, MASQUERADE AND HALLOWEEN COSTUMES, AND APRONS (U.S. CLS. 22 AND 39).

JAY FLOWERS, EXAMINING ATTORNEY

SN 78-965,460. TOTAL ENTERPRISES, INC., LOS ANGELES,
CA. FILED 8-31-2006.

BECAUSE WE ARE CUTE

THE MARK CONSISTS OF STANDARD CHARACTERS WITHOUT CLAIM TO ANY PARTICULAR FONT, STYLE, SIZE, OR COLOR.

FOR APPAREL, NAMELY, MEN'S, WOMEN'S AND CHILDREN'S HEADWEAR, FOOTWEAR AND OUTERWEAR, NAMELY, COATS, JACKETS, SWEATERS AND VEST; TOPS, BOTTOMS, T-SHIRTS, SHIRTS, PANTS, DRESSES, UNDERWEAR, SWIMWEAR AND SLEEPWEAR (U.S. CLS. 22 AND 39).

STEPHEN AQUILA, EXAMINING ATTORNEY

CLASS 25—(Continued).

SN 78-966,026. KELLY, IAN, FLORISSANT, MO. AND
MARTIN, YOMI, FLORISSANT, MO. FILED 9-1-2006.

REBEL SOCIETY

THE MARK CONSISTS OF STANDARD CHARACTERS WITHOUT CLAIM TO ANY PARTICULAR FONT, STYLE, SIZE, OR COLOR.

FOR CLOTHING, NAMELY, SHOES, SOCKS, SHIRTS, PAJAMAS, BANDANAS, CAPS, HATS, HEADWEAR, SNEAKERS, BATHING SUITS, BATHROBES, COVERUPS, JACKETS, BELTS, SHORTS, GLOVES, BOOTS, PANTS, BOXER SHORTS, UNDERWEAR, VISORS, COATS, COVERALLS, SWEATERS, MITTENS, JERSEYS, SLIPPERS, DRESSES, VESTS, PULLOVERS, FLIP FLOPS, FOOTWEAR, SCARVES, HEADBANDS, INFANT AND TODDLER ONE PIECE CLOTHING, INFANT SLEEPERS, JEANS, JOGGING SUITS, JUMPERS, STOCKINGS, LEOTARDS, LINGERIE, LOUNGEWEAR, SLEEPWEAR, SKIRTS, NECKTIES, NIGHTGOWNS, RAINCOATS, ROBES, ROMPERS, SANDALS, SHORTS, T-SHIRTS, SUITS, SWEATBANDS, SWEAT SUITS, SWIMSUITS, AND UNDERWEAR (U.S. CLS. 22 AND 39).

JAMES LOVELACE, EXAMINING ATTORNEY

SN 78-968,153. YUROSEK, JERMEY J., BAKERSFIELD, CA.
AND COLLIER, COOK, BAKERSFIELD, CA. FILED 9-6-
2006.

NIVIS

THE MARK CONSISTS OF STANDARD CHARACTERS WITHOUT CLAIM TO ANY PARTICULAR FONT, STYLE, SIZE, OR COLOR.

FOR CLOTHING FOR MEN, WOMEN AND CHILDREN, NAMELY, LONG-SLEEVE AND SHORT-SLEEVE SHIRTS, SWEATERS, JACKETS, COATS, SKI APPAREL, SWEATSHIRTS, T-SHIRTS, BELTS, SOCKS, DRESSES, HATS, PANTS, WARM UP SUITS AND LOUNGE WEAR (U.S. CLS. 22 AND 39).

DEIRDRE ROBERTSON, EXAMINING ATTORNEY

CLASS 25—(Continued).

SN 78-971,211. BYONG-JIN, JOO, SEOUL, REPUBLIC OF KOREA, FILED 9-11-2006.



OWNER OF REPUBLIC OF KOREA REG. NO. 0671810, DATED 7-26-2006, EXPIRES 7-26-2016.

THE COLOR(S) RED IS/ARE CLAIMED AS A FEATURE OF THE MARK.

THE MARK CONSISTS OF THE WORDS SEXY COOKIE IN STYLIZED LETTERS, AND AN IMAGE OF A RIBBON, BOTH WORDS AND RIBBON IN THE COLOR RED.

FOR SHOES, SWIMMING SUITS, T-SHIRTS, GLOVES, SOCKS, CAPS, BRACES FOR CLOTHING, LEATHER BELTS, SANDALS, CHILDREN'S PANTS, UNIFORMS FOR SPORTS, BRASSIERES, UNDERCLOTHING, UNDERPANTS, UNDERSHIRTS, NIGHTGOWNS (U.S. CLS. 22 AND 39).

DORITT L. CARROLL, EXAMINING ATTORNEY

CLASS 25—(Continued).

SN 78-971,806. HARTMANN, REBECCA, SAN DIEGO, CA. FILED 9-11-2006.



THE NAME SHOWN IN THE MARK DOES NOT IDENTIFY A PARTICULAR LIVING INDIVIDUAL.

THE MARK CONSISTS OF THE WORDS HOLLYWOOD IN BLOCK LETTERS AND JANE IN SCRIPTED LETTERS WITH THE J IN JANE BEING AN EXTENSION OF THE Y IN HOLLYWOOD.

FOR CLOTHING, NAMELY, SHIRTS, PANTS, BLOUSES, LINGERIE, SKIRTS, TOPS, SWEAT PANTS, SWEAT SHIRTS, T-SHIRTS, DRESSES, SWIMWEAR, BEACHWEAR, SHOES, SANDALS, HATS, BELTS, AND SCARVES (U.S. CLS. 22 AND 39).

ELLEN PERKINS, EXAMINING ATTORNEY

SN 78-972,358. ESCO, LTD., BALTIMORE, MD. FILED 9-12-2006.

THESHOESPACE

THE MARK CONSISTS OF STANDARD CHARACTERS WITHOUT CLAIM TO ANY PARTICULAR FONT, STYLE, SIZE, OR COLOR.

FOR CLOTHING, NAMELY, SHOES AND FOOTWEAR, SHIRTS, JACKETS, PANTS, SHORTS, SKIRTS, DRESSES, HATS, SOCKS, HOSIERY, BELTS, ACCESSORIES, NAMELY, SCARVES AND GLOVES (U.S. CLS. 22 AND 39).

DAVID I, EXAMINING ATTORNEY

SN 78-971,793. BALLY TOTAL FITNESS HOLDING CORPORATION, CHICAGO, IL. FILED 9-11-2006.

BALLY TOTAL FITNESS

THE MARK CONSISTS OF STANDARD CHARACTERS WITHOUT CLAIM TO ANY PARTICULAR FONT, STYLE, SIZE, OR COLOR.

OWNER OF U.S. REG. NOS. 1,992,150, 2,917,971 AND OTHERS.

NO CLAIM IS MADE TO THE EXCLUSIVE RIGHT TO USE "FITNESS", APART FROM THE MARK AS SHOWN.

FOR CLOTHING RELATED TO FITNESS, SPORTS OR ATHLETICS, NAMELY, MEN'S WOMEN'S AND CHILDREN'S POLO SHIRTS, PANTS, VESTS, SOCKS, SHORTS, SPORTS BRAS, TANK TOPS, UNDERWEAR, SWEATPANTS, T-SHIRTS, SWEATSHIRTS, JACKETS, HATS AND BANDANAS (U.S. CLS. 22 AND 39).

FIRST USE 6-15-2006; IN COMMERCE 6-15-2006.
PATRICIA EVANKO, EXAMINING ATTORNEY

SN 78-972,374. ESCO, LTD., BALTIMORE, MD. FILED 9-12-2006.

SHOESPACE

THE MARK CONSISTS OF STANDARD CHARACTERS WITHOUT CLAIM TO ANY PARTICULAR FONT, STYLE, SIZE, OR COLOR.

FOR CLOTHING, NAMELY, SHOES AND FOOTWEAR, SHIRTS, JACKETS, PANTS, SHORTS, SKIRTS, DRESSES, HATS, SOCKS, HOSIERY, BELTS, ACCESSORIES, NAMELY, SCARVES AND GLOVES (U.S. CLS. 22 AND 39).

DAVID I, EXAMINING ATTORNEY

CLASS 25—(Continued).

SN 78-972,389. ESCO, LTD., BALTIMORE, MD. FILED 9-12-2006.

THE SHOE SPACE

THE MARK CONSISTS OF STANDARD CHARACTERS WITHOUT CLAIM TO ANY PARTICULAR FONT, STYLE, SIZE, OR COLOR.

NO CLAIM IS MADE TO THE EXCLUSIVE RIGHT TO USE "SHOE", APART FROM THE MARK AS SHOWN.

FOR CLOTHING, NAMELY, SHOES AND FOOTWEAR, SHIRTS, JACKETS, PANTS, SHORTS, SKIRTS, DRESSES, HATS, SOCKS, HOSIERY, BELTS, ACCESSORIES, NAMELY SCARVES AND GLOVES (U.S. CLS. 22 AND 39).

DAVID I, EXAMINING ATTORNEY

CLASS 25—(Continued).

SN 79-019,932. ZANONE - S.R.L., ITALY, FILED 10-3-2005.

**ZANONE ICE
COTTON**

THE MARK CONSISTS OF STANDARD CHARACTERS WITHOUT CLAIM TO ANY PARTICULAR FONT, STYLE, SIZE, OR COLOR.

PRIORITY DATE OF 5-24-2005 IS CLAIMED.

OWNER OF INTERNATIONAL REGISTRATION 0874192 DATED 10-3-2005, EXPIRES 10-3-2015.

NO CLAIM IS MADE TO THE EXCLUSIVE RIGHT TO USE "COTTON", APART FROM THE MARK AS SHOWN.

FOR SINGLETs, PULLOVERS, GLOVES AND MUFFS FOR CLOTHING, KNITTED SHIRTS, POLOSHIRTS, CARDIGANS, JERSEYS, NECKTIES, NECKERCHIEFS, SCARVES, SWEATERS, JACKETS, JERKINS, SHIRTS, WAISTCOATS, JUMPERS, T-SHIRTS, SUITS AND DRESSES, OVERCOATS, COATS, SASHES FOR WEAR, BELTS FOR CLOTHING, HATS, BERETS, ALL OF THE GOODS MADE OF COTTON AT LEAST IN PART (U.S. CLS. 22 AND 39).

JOHN DALIER, EXAMINING ATTORNEY

SN 78-972,407. ESCO, LTD., BALTIMORE, MD. FILED 9-12-2006.

SHOE SPACE

THE MARK CONSISTS OF STANDARD CHARACTERS WITHOUT CLAIM TO ANY PARTICULAR FONT, STYLE, SIZE, OR COLOR.

NO CLAIM IS MADE TO THE EXCLUSIVE RIGHT TO USE "SHOE", APART FROM THE MARK AS SHOWN.

FOR CLOTHING, NAMELY, SHOES AND FOOTWEAR, SHIRTS, JACKETS, PANTS, SHORTS, SKIRTS, DRESSES, HATS, SOCKS, HOSIERY, BELTS, ACCESSORIES, NAMELY SCARVES AND GLOVES (U.S. CLS. 22 AND 39).

DAVID I, EXAMINING ATTORNEY

SN 79-031,242. WOLFORD AKTIENGESELLSCHAFT, AUSTRIA, FILED 9-1-2006.

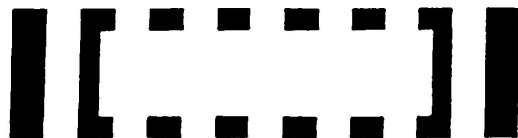

OWNER OF INTERNATIONAL REGISTRATION 0904317 DATED 9-1-2006, EXPIRES 9-1-2016.

FOR CLOTHING, NAMELY, SHIRTS, TOPS, BELTS, JACKETS, BOLEROS, COATS, SCARVES, CARDIGANS, COATS, SKIRTS, PANTS, TROUSERS, PULLOVERS, TUNICS, DRESSES, BODY SUITS, CAPRIS, GARTERS, BRAS, PANTIES, UNDERWEAR; STOCKINGS, HOSIERY, TIGHTS, FOOTWEAR, HEADWEAR, GLOVES (U.S. CLS. 22 AND 39).

CARRIE GENOVESE, EXAMINING ATTORNEY

CLASS 25—(Continued).

SN 79-031,942. DIMENSIONI S.R.L., ITALY, FILED 11-23-2006.



PRIORITY DATE OF 6-1-2006 IS CLAIMED.
OWNER OF INTERNATIONAL REGISTRATION 0901271
DATED 9-14-2006, EXPIRES 9-14-2016.

THE TRADEMARK CONSISTS OF THE FANCY WORD GANESH IN FANCY CHARACTERS, DEPICTED IN A RECTANGLE DIVIDED INTO TWO PARTS, BESIDE A STYLIZED FANCY FIGURE.

FOR CLOTHING FOR MEN, WOMEN AND CHILDREN, NAMELY, SHIRTS, BLOUSES, T-SHIRTS, SKIRTS, TROUSERS, JEANS, JACKETS, SPORT JACKETS, COATS, RAINCOATS, UNDERWEAR, PULLOVERS, WIND-JACKETS, TRACKSUITS, SPORT TROUSERS AND T-SHIRTS; BELTS, SUSPENDERS, NECKTIES, SCARVES, GLOVES, SASHES FOR WEAR; HATS AND FOOTWEAR (U.S. CLS. 22 AND 39).

GISELLE AGOSTO, EXAMINING ATTORNEY

SN 79-032,214. FEIJOO ELZO, MIKEL, E-48300 GUERNICA (VIZCAYA), SPAIN, FILED 5-17-2006.

skunk funk

OWNER OF INTERNATIONAL REGISTRATION 0906785
DATED 5-17-2006, EXPIRES 5-17-2016.

FOR CLOTHING, NAMELY SHIRTS, POLO SHIRTS, PANTS, SCARVES, PULLOVERS, WAISTCOATS, CAPES, TROUSERS, VESTS, PARKAS, SWEATERS, SWEATSHIRTS, BLAZERS, TUNICS, GAITERS, KNITTED SHIRTS AND SWEATERS, LEGGINGS, TIES, BELTS, SUSPENDERS, WRIST BANDS, HEADBANDS, BLOUSES, SKIRTS, DRESSES, CLOAKS, SOCKS, JEANS, TRACK SUITS, SPORTS-SUITS IN GENERAL, EAR MUFFS, BANDANAS, COLLARS, SUN VISORS, JERKINS, SLACKS, SHORTS, MITTENS, TANK TOPS, T-SHIRTS, CARDIGANS, JUMPERS, BRASSIERES, CORSETS, HOSE, PETTICOATS, RAINCOATS, OVERCOATS, ANORAKS, STOCKINGS, PANTYHOSE, SLIPS, BATHING SUITS, BATH ROBES, DRESSING GOWNS, PAJAMAS, BODY SUITS, JOGGING SUITS, JUMPSUITS, GLOVES, COATS, JACKETS, SPORTS JACKETS AND WIND RESISTANT JACKETS, JERSEYS, FOULARDS; FOOTWEAR, NAMELY SHOES, SLIPPERS, BOOTS, SANDALS; HEAD WEAR, NAMELY HATS, SUN-VISORS, BERETS, CAPS, HOODS, PEAKED CAPS, BONNETS (U.S. CLS. 22 AND 39).

CHARISMA HAMPTON, EXAMINING ATTORNEY

CLASS 25—(Continued).

SN 79-032,279. SCOTT MCINERNEY, AUSTRALIA, FILED 10-6-2006.

TIP TOEY JOEY

THE MARK CONSISTS OF STANDARD CHARACTERS WITHOUT CLAIM TO ANY PARTICULAR FONT, STYLE, SIZE, OR COLOR.

PRIORITY DATE OF 5-24-2006 IS CLAIMED.

OWNER OF INTERNATIONAL REGISTRATION 0906911
DATED 10-6-2006, EXPIRES 10-6-2016.

FOR CLOTHING, NAMELY, SHIRTS, PANTS, SKIRTS, DRESSES, BLOUSES, OVERALLS, PAJAMAS; HEADGEAR, NAMELY, HATS, CAPS, VISORS, BEANIES; FOOTWEAR, NAMELY, FOOTWEAR FOR CHILDREN AND BABIES. (U.S. CLS. 22 AND 39).

ERNEST SHOSHO, EXAMINING ATTORNEY

SN 79-033,461. BAYCREW'S CO., LTD., JAPAN, FILED 7-3-2006.

DEUXIÈME CLASSE

PRIORITY DATE OF 2-13-2006 IS CLAIMED.

OWNER OF INTERNATIONAL REGISTRATION 0910012
DATED 7-3-2006, EXPIRES 7-3-2016.

"THE FOREIGN WORDING IN THE MARK TRANSLATES INTO ENGLISH AS SECOND CLASS."

FOR CLOTHING, NAMELY, NON-JAPANESE STYLE DRESSES, EVENING DRESSES, WEDDING DRESSES, SCHOOL UNIFORMS, CHILDREN'S WEAR, NAMELY, JACKETS, SHIRTS, TIES, SOCKS, SHOES, SUITS, SKIRTS, TROUSERS, COATS, CARDIGANS, SWEATERS, PAJAMAS, UNDERWEAR, BELTS, MUFFLERS, HEADWEAR, GLOVES AND BANDANAS, WORKING OVERALLS, JACKETS, JOGGING PANTS, SWEAT PANTS, SUITS, SKIRTS, SKI JACKETS, SKI PANTS, TROUSERS, SMOCKS, TUXEDOS, MORNING COATS, BLAZERS, BLOUSON, JERKINS, KNICKERS, BEACHWEAR, COATS FOR MEN AND WOMEN, OVERCOATS, TOPCOATS, MANTLES, RAINCOATS, GREAT COATS, TRENCH COATS, DUST COATS; SWEATERS AND THE LIKE, NAMELY, CARDIGANS, SWEATERS, VESTS AND WAISTCOATS, TWIN SETS; SHIRTS AND THE LIKE, NAMELY, OPEN-NECKED SHIRTS, CUFFS, COLLARS FOR CLOTHING, SPORT SHIRTS, BLOUSES, POLO SHIRTS, SHIRTS FOR SUITS, T-SHIRTS; NIGHTWEAR, NAMELY, NIGHT GOWNS, NEGLIGÉES, BABY DOLL PAJAMAS, PEIGNOIRS, JAPANESE SLEEPING ROBES (NEMAKI), PAJAMAS, BATH ROBES; UNDERWEAR, NAMELY, CAMISOLES, CORSETS, COMBINATIONS, UNDERSHIRTS, CHEMISES, DRAWERS AND UNDERPANTS, SLIPS, PANTIES, SHORTS AND BRIEFS, BERMUDA SHORTS, BOXER SHORTS, BRASSIERES, PETTICOATS, TANK-TOPS; SWIMWEAR, NAMELY, BATHING SUITS; SWIMMING CAPS; JAPANESE TRADITIONAL CLOTHING, NAMELY, SASH BANDS FOR KIMONO (OBI), BUSTLE HOLDER BANDS FOR OBI (OBIAGE), BUSTLES FOR OBI-KNOTS (OBIAGE-SHIN), WAIST STRINGS FOR KIMONOS (KOSHIHIMO), UNDERSHIRTS FOR KIMONOS (KOSHIMAKI, JUBAN), TIGHTENING-UP STRINGS FOR KIMONOS (DATEJIME), WRAP BELTS FOR KIMONOS (DATEMAKI), FULL-LENGTH KIMONOS (NAGAGI), SHORT OVERCOAT FOR KIMONO (HAORI), STRING FASTENERS FOR HAORI (HAORI-HIMO), PLEATED SKIRTS FOR FORMAL KIMONOS (HAKAMA), DETACHABLE NECKPIECES FOR KIMONOS (HANERI); APRONS; COLLAR PROTECTORS FOR WEAR; SOCKS AND STOCKINGS; ANKLE SOCKS; KNEE-HIGH STOCKINGS; PANTYHOSE; PUTTEES AND GAITERS; FUR STOLE; PAREUS; SHAWLS; SERAPES; SCARVES; JAPANESE STYLE SOCKS (TABI, TABI COVERS); GLOVES AND MITTENS; BABIES' DIAPERS OF TEXTILE; NECKTIES; BOW TIES; NECKERCHIEVES; BANDANAS; WARMTH-KEEPING SUPPORTS, NAMELY, NAMELY, LEG WARMERS; MUFFLERS; EAR MUFFS; HOODS; SEDGE HATS (SUGE-GASA); NIGHTCAPS; HELMETS FOR USE AS

CLASS 25—(Continued).

CLOTHING; HEADWEAR FOR CLOTHING; KNITTED CAPS; CAP VISORS; LEG-WARMERS; ANKLE GARTERS; GARTER BELTS; SOCK SUSPENDERS; SUSPENDERS; WAISTBANDS; BELTS FOR CLOTHING; FOOTWEAR FOR MEN AND WOMEN, NAMELY, SHOES AND BOOTS, RAIN BOOTS, LACE BOOTS, TRAINING SHOES, OVERSHOES, WOODEN SHOES, WORK SHOES AND BOOTS, SANDALS, SHOES, JAPANESE SPLIT-TOED WORK FOOTWEAR (JIKATABI), BEACH FOOTWEAR, ANGLERS' SHOES, BOOTS, HALF-BOOTS, WOMEN'S SHOES, WINTER BOOTS, ANKLE BOOTS, HOSIERY SHOES, CANVAS SHOES, INFANTS' SHOES AND BOOTS, MULES, INNER SOLES FOR SHOES AND BOOTS, HEELPIECES FOR SHOES AND BOOTS, INSOLES FOR SHOES AND BOOTS, WELTS FOR SHOES AND BOOTS, RUBBER SOLES FOR JIKATABI, FOOTWEAR UPPERS, TIPS FOR FOOTWEAR, SHOES SOLES FOR REPAIR; SHOE DOWELS; SHOE PEGS; TONGUE OR PULLSTRAP FOR SHOES AND BOOTS; HOBNAILS; PROTECTIVE METAL MEMBERS FOR SHOES AND BOOTS; JAPANESE STYLE WOODEN CLOGS (GETA), NAMELY, HIGH RAIN CLOGS (ASHIDA), LOW WOODEN CLOGS (KOMAGETA, HIYORI-GETA), SANDAL-CLOGS, METAL FITTINGS FOR JAPANESE STYLE WOODEN CLOGS, WOODEN MAIN BODIES OF JAPANESE STYLE WOODEN CLOGS, WOODEN SUPPORTS OF JAPANESE STYLE WOODEN CLOGS, TOE STRAPS FOR JAPANESE STYLE WOODEN CLOGS; JAPANESE STYLE SANDALS (ZORI), NAMELY, JAPANESE TOE-STRAP SANDALS (ASAURAZORI), JAPANESE STYLE SANDALS OF LEATHER, SLIPPERS, JAPANESE STYLE SANDALS OF FELT, JAPANESE FOOTWEAR OF RICE STRAW (WARAJI), SLIPPER SOLES, UPPERS FOR JAPANESE STYLE SANDALS, SOLES FOR JAPANESE STYLE SANDALS, TOE STRAPS FOR JAPANESE STYLE SANDALS, UPPERS OF WOVEN RATTAN FOR JAPANESE STYLE SANDALS; MASQUERADE COSTUMES; CLOTHES FOR SPORTS, NAMELY, ANORAKS, KARATE SUITS, SPORTS OVER-UNIFORMS, KENDO OUTFITS, JUDO SUITS, SKI SUITS FOR COMPETITION, HEADBANDS, WIND-JACKETS, UNIFORMS AND STOCKINGS FOR SPECIAL SPORTSWEAR, WRISTBANDS; BOOTS FOR SPORTS, NAMELY, GOLF SHOES, SOCCER SHOES, SKI BOOTS, GYMNASIATIC SHOES, TENNIS SHOES, CLIMBING BOOTS FOR USE AS MOUNTAINEERING BOOTS, BASKETBALL SNEAKERS, VOLLEYBALL SHOES, HANDBALL SHOES, BOWLING SHOES, BOXING SHOES, HOCKEY SHOES, BASEBALL SHOES, RUGBY SHOES, BALLET SHOES, FOOTWEAR FOR TRACK AND FIELD ATHLETICS, HORSE-RIDING (U.S. CLS. 22 AND 39).

WILLIAM ROSSMAN, EXAMINING ATTORNEY

CLASS 25—(Continued).

SN 79-034,772. C.I.T. S.P.A. CONFEZIONI ITALIANE; TESSILI COMMERCIO INDUSTRIA TESSUTI, ITALY, FILED 8-30-2006.

BAGUTTINO

OWNER OF INTERNATIONAL REGISTRATION 0573165 DATED 7-16-1991, EXPIRES 7-16-2011.

OWNER OF U.S. REG. NOS. 1,144,253 AND 3,120,964.

FOR UNDERWEAR FOR MEN, WOMEN AND CHILDREN, PANTYHOSE; OUTERWEAR FOR MEN, WOMEN AND CHILDREN, NAMELY, JERSEYS AND SWEATERS; LINEN UNDERWEAR; LINEN OUTERWEAR, NAMELY, JERSEYS AND SWEATERS; UNDERWEAR FOR MEN, WOMEN AND CHILDREN, NAMELY, HOSIERY; OUTERWEAR FOR MEN, WOMEN AND CHILDREN, NAMELY, HOSIERY; SHIRTS FOR MEN AND WOMEN; CHEMISETTES; KNITWEAR FOR MEN, WOMEN AND CHILDREN, NAMELY, COATS, CARDIGANS AND PULLOVERS; JACKETS, MORNING COATS AND SHORT JACKETS, NECKTIES, STOCKINGS AND SOCKS FOR MEN, WOMEN AND CHILDREN; TIGHTS, PAJAMAS; NIGHTGOWNS, NIGHTSHIRTS AND DRESSING GOWNS FOR MEN, WOMEN AND CHILDREN; SPORTS AND CASUAL WEAR, NAMELY, SHIRTS, T-SHIRTS; FOOTWEAR (U.S. CLS. 22 AND 39).

ELI HELLMAN, EXAMINING ATTORNEY

SN 79-036,635. MAROL SNC DI SAGUATTI ROSSANA & C., I-40131 BOLOGNA, ITALY, FILED 2-7-2007.

MAROL

OWNER OF INTERNATIONAL REGISTRATION 0893406 DATED 6-23-2006, EXPIRES 6-23-2016.

OWNER OF U.S. REG. NO. 2,047,889.

FOR CLOTHING ARTICLES, NAMELY, SHIRTS AND BLOUSES (U.S. CLS. 22 AND 39).

BRIAN PINO, EXAMINING ATTORNEY

SN 79-037,214. WENZHO JIAOZU SHOES CO., LTD., CHINA, FILED 3-5-2007.



JIAOZU

OWNER OF INTERNATIONAL REGISTRATION 0920774 DATED 3-5-2007, EXPIRES 3-5-2017.

FOR SHOES (U.S. CLS. 22 AND 39).

COLLEEN KEARNEY, EXAMINING ATTORNEY

CLASS 25—(Continued).

SN 79-039,543. NADA LEDERMANN, SWITZERLAND, FILED 4-13-2007.



OWNER OF INTERNATIONAL REGISTRATION 0926790 DATED 4-13-2007, EXPIRES 4-13-2017. FOR UNDERCLOTHING (U.S. CLS. 22 AND 39). MARTHA FROMM, EXAMINING ATTORNEY

CLASS 26—(Continued).

SN 77-112,131. MIDWAY INTERNATIONAL, INC., CERRITOS, CA. FILED 2-21-2007.



BOBBI BOSS

THE NAME(S), PORTRAIT(S), AND/OR SIGNATURE(S) SHOWN IN THE MARK DOES NOT IDENTIFY A PARTICULAR LIVING INDIVIDUAL.

THE MARK CONSISTS OF THE LETTER "B" IN SCRIPT TO THE RIGHT AND THE MIRROR IMAGE OF THE LETTER TO THE LEFT.

FOR CLAM CLIPS FOR HAIR; HAIR ACCESSORIES, NAMELY, CLAW CLIPS; HAIR ACCESSORIES, NAMELY, JAW CLIPS; HAIR ACCESSORIES, NAMELY, SNAP CLIPS; HAIR ACCESSORIES, NAMELY, TWISTERS; HAIR BANDS; HAIR BOWS; HAIR CLIPS; HAIR CURL CLIPS; HAIR EXTENSIONS; HAIR NETS; HAIR PIECES; HAIR PINS AND GRIPS; HAIR RIBBONS; TAPE FOR FIXING WIGS; TOUPEES; WIGS; WIGS, HAIR-PIECES, AND ADD-IN AND ADD-ON HAIR ACCESSORIES CONSTRUCTED PRIMARILY OF SYNTHETIC AND/OR HUMAN HAIR (U.S. CLS. 37, 39, 40, 42 AND 50).

FIRST USE 12-1-2006; IN COMMERCE 12-1-2006. KATHERINE E. HALMEN, EXAMINING ATTORNEY

CLASS 26—FANCY GOODS

SN 77-037,955. INJECTRON CORPORATION, PLAINFIELD, NJ. FILED 11-6-2006.

EAGLE GOOD TO GO

THE MARK CONSISTS OF STANDARD CHARACTERS WITHOUT CLAIM TO ANY PARTICULAR FONT, STYLE, SIZE, OR COLOR.

FOR DESIGNED AND FITTED SEWING AND QUILTING BAGS FOR HOLDING SEWING AND QUILTING THREAD, NEEDLES, BOBBINS, SCISSORS, FLOSS AND YARN; AND TOTE BAGS AND TOTE BOXES MADE OF POLYPROPYLENE PLASTIC, FOR HOLDING CRAFTS, NEEDLEWORK, KNITTING, QUILTING AND PAINTS (U.S. CLS. 37, 39, 40, 42 AND 50).

FIRST USE 11-0-2005; IN COMMERCE 11-0-2005. EDWARD NELSON, EXAMINING ATTORNEY

SN 77-156,567. MARTINI, SHARON, ANN, PORTLAND, OR. FILED 4-13-2007.

T-Art! Who Says Art Has To Hang On Your Walls? Hang Some On Your Bum!

THE MARK CONSISTS OF STANDARD CHARACTERS WITHOUT CLAIM TO ANY PARTICULAR FONT, STYLE, SIZE, OR COLOR.

FOR ORNAMENTAL CLOTH PATCHES (U.S. CLS. 37, 39, 40, 42 AND 50).

FIRST USE 11-4-2004; IN COMMERCE 11-4-2004. DOMINICK J. SALEMI, EXAMINING ATTORNEY

CLASS 26—(Continued).

SN 77-187,295. MODEL MODEL HAIR FASHION, INC., COLLEGE POINT, NY. FILED 5-22-2007.

TOPCAP

THE MARK CONSISTS OF STANDARD CHARACTERS WITHOUT CLAIM TO ANY PARTICULAR FONT, STYLE, SIZE, OR COLOR.

FOR PONYTAIL HAIR PIECES, HAIR WEAVES, HAIR EXTENSIONS, WIGS AND BRAIDS (U.S. CLS. 37, 39, 40, 42 AND 50).

MICHAEL LEWIS, EXAMINING ATTORNEY

SN 77-187,334. MODEL MODEL HAIR FASHION, INC., COLLEGE POINT, NY. FILED 5-22-2007.

ACCENT COLOR

THE MARK CONSISTS OF STANDARD CHARACTERS WITHOUT CLAIM TO ANY PARTICULAR FONT, STYLE, SIZE, OR COLOR.

NO CLAIM IS MADE TO THE EXCLUSIVE RIGHT TO USE "COLOR", APART FROM THE MARK AS SHOWN.

FOR PONYTAIL HAIR PIECES, HAIR WEAVES, HAIR EXTENSIONS, WIGS AND BRAIDS (U.S. CLS. 37, 39, 40, 42 AND 50).

MICHAEL LEWIS, EXAMINING ATTORNEY

SN 77-223,229. MODEL MODEL HAIR FASHION INC., COLLEGE POINT, NY. FILED 7-6-2007.

LACE TOPCAP

THE MARK CONSISTS OF STANDARD CHARACTERS WITHOUT CLAIM TO ANY PARTICULAR FONT, STYLE, SIZE, OR COLOR.

NO CLAIM IS MADE TO THE EXCLUSIVE RIGHT TO USE "LACE", APART FROM THE MARK AS SHOWN.

FOR HAIR EXTENSIONS, PONYTAILS, HAIR PIECES, HAIR WEAVES, WIGS AND BRAIDS (U.S. CLS. 37, 39, 40, 42 AND 50).

MICHAEL LEWIS, EXAMINING ATTORNEY

CLASS 26—(Continued).

SN 78-962,048. LEISURE ARTS, INC., LITTLE ROCK, AR. FILED 8-28-2006.

CREATE AND UNWIND

THE MARK CONSISTS OF STANDARD CHARACTERS WITHOUT CLAIM TO ANY PARTICULAR FONT, STYLE, SIZE, OR COLOR.

FOR KNITTING NEEDLES, CROCHET HOOKS, KNIT AND CROCHET KITS CONSISTING OF YARN ACCESSORIES, NAMELY, STITCH GAUGES, KNITTING NEEDLE POINT PROTECTORS, BOBBINS AND POM POM MAKERS, GAUGES, TAPE MEASURE, SCISSORS, YARN CUTTER, TAPESTRY NEEDLES, ROW COUNTERS, STITCH MARKERS, CABLE NEEDLES, PATTERN HOLDERS AND YARN (U.S. CLS. 37, 39, 40, 42 AND 50). ELLEN PERKINS, EXAMINING ATTORNEY

CLASS 27—FLOOR COVERINGS

SN 76-675,655. J & J INDUSTRIES, DALTON, GA. FILED 4-18-2007.

XERO

THE MARK CONSISTS OF STANDARD CHARACTERS WITHOUT CLAIM TO ANY PARTICULAR FONT, STYLE, SIZE, OR COLOR.

FOR CARPET PILE BACKING (U.S. CLS. 19, 20, 37, 42 AND 50).

JOHN GARTNER, EXAMINING ATTORNEY

SN 76-678,033. J & J INDUSTRIES, DALTON, GA. FILED 6-11-2007.

eKo

THE MARK CONSISTS OF STANDARD CHARACTERS WITHOUT CLAIM TO ANY PARTICULAR FONT, STYLE, SIZE, OR COLOR.

FOR LIGHTWEIGHT, RECYCLABLE CARPET TILE BACKING (U.S. CLS. 19, 20, 37, 42 AND 50).

JOHN GARTNER, EXAMINING ATTORNEY

CLASS 27—(Continued).

SN 77-133,886. G4 GROUP, INC., JACOBUS, PA. FILED 3-18-2007.

DecoFloor

THE MARK CONSISTS OF STANDARD CHARACTERS WITHOUT CLAIM TO ANY PARTICULAR FONT, STYLE, SIZE, OR COLOR.

FOR HARD SURFACE COVERINGS FOR FLOORS; PROTECTIVE FLOOR COVERINGS; RESILIENT HARD SURFACE COVERING FOR FLOORS, WALLS AND OTHER SURFACES (U.S. CLS. 19, 20, 37, 42 AND 50).

FIRST USE 12-5-2006; IN COMMERCE 2-15-2007.
NAPOLEON SHARMA, EXAMINING ATTORNEY

SN 77-141,572. COLUMBIA INSURANCE COMPANY, OMAHA, NE. FILED 3-27-2007.



NO CLAIM IS MADE TO THE EXCLUSIVE RIGHT TO USE "N6" AND THE INTERNATIONAL RECYCLING SYMBOL, APART FROM THE MARK AS SHOWN.

THE MARK CONSISTS OF N6 IN A STYLIZED FORM WITH THE UNIVERSAL SYMBOL FOR "RECYCLE" ON THE NUMBER 6 AND AN ARROW ABOVE THE LETTER N

FOR CARPETS (U.S. CLS. 19, 20, 37, 42 AND 50).
FIRST USE 11-27-2006; IN COMMERCE 11-27-2006.
WILLIAM ROSSMAN, EXAMINING ATTORNEY

SN 77-177,513. CAPEL, INC., TROY, NC. FILED 5-10-2007.

CAPEL BRAIDS - AMERICAN ORIGINALS

THE MARK CONSISTS OF STANDARD CHARACTERS WITHOUT CLAIM TO ANY PARTICULAR FONT, STYLE, SIZE, OR COLOR.

OWNER OF U.S. REG. NOS. 734,237, 2,085,887 AND OTHERS.

NO CLAIM IS MADE TO THE EXCLUSIVE RIGHT TO USE "BRAIDS - AMERICAN ORIGINALS", APART FROM THE MARK AS SHOWN.

FOR BRAIDED RUGS (U.S. CLS. 19, 20, 37, 42 AND 50).
FIRST USE 3-16-2007; IN COMMERCE 3-16-2007.
CHRISTOPHER OTT, EXAMINING ATTORNEY

CLASS 28—TOYS AND SPORTING GOODS

SN 76-661,937. PLACO CORPORATION LIMITED, KOWLOON, HONG KONG, FILED 6-21-2006.

MY BUBBLING

THE MARK CONSISTS OF STANDARD CHARACTERS WITHOUT CLAIM TO ANY PARTICULAR FONT, STYLE, SIZE, OR COLOR.

NO CLAIM IS MADE TO THE EXCLUSIVE RIGHT TO USE BUBBLING, APART FROM THE MARK AS SHOWN.

FOR BATTERY OPERATED, HAND-HELD BUBBLE TOYS, NAMELY BUBBLE GUNS, BUBBLE MACHINES, BUBBLE WANDS, AND BUBBLE SOLUTION CONTAINERS; AND NON-BATTERY OPERATED, HAND-HELD BUBBLE TOYS, NAMELY BUBBLE GUNS, BUBBLE MACHINES, BUBBLE WANDS, AND BUBBLE SOLUTION CONTAINERS (U.S. CLS. 22, 23, 38 AND 50).

FIRST USE 1-0-2006; IN COMMERCE 1-0-2006.
ANNE MADDEN, EXAMINING ATTORNEY

SN 76-661,938. PLACO CORPORATION LIMITED, KOWLOON, HONG KONG, FILED 6-21-2006.

MY BUBBLING PUPPY

THE MARK CONSISTS OF STANDARD CHARACTERS WITHOUT CLAIM TO ANY PARTICULAR FONT, STYLE, SIZE, OR COLOR.

NO CLAIM IS MADE TO THE EXCLUSIVE RIGHT TO USE BUBBLING PUPPY, APART FROM THE MARK AS SHOWN.

FOR BATTERY OPERATED, HAND-HELD BUBBLE TOYS, NAMELY BUBBLE GUNS, BUBBLE MACHINES, BUBBLE WANDS, AND BUBBLE SOLUTION CONTAINERS; AND NON-BATTERY OPERATED, HAND-HELD BUBBLE TOYS, NAMELY BUBBLE GUNS, BUBBLE MACHINES, BUBBLE WANDS, AND BUBBLE SOLUTION CONTAINERS (U.S. CLS. 22, 23, 38 AND 50).

FIRST USE 1-0-2006; IN COMMERCE 1-0-2006.
ANNE MADDEN, EXAMINING ATTORNEY

SN 76-661,940. PLACO CORPORATION LIMITED, KOWLOON, HONG KONG, FILED 6-21-2006.

MY BUBBLING PONY

THE MARK CONSISTS OF STANDARD CHARACTERS WITHOUT CLAIM TO ANY PARTICULAR FONT, STYLE, SIZE, OR COLOR.

NO CLAIM IS MADE TO THE EXCLUSIVE RIGHT TO USE BUBBLING PONY, APART FROM THE MARK AS SHOWN.

FOR BATTERY OPERATED, HAND-HELD BUBBLE TOYS, NAMELY BUBBLE GUNS, BUBBLE MACHINES, BUBBLE WANDS, AND BUBBLE SOLUTION CONTAINERS; AND NON-BATTERY OPERATED, HAND-HELD BUBBLE TOYS, NAMELY BUBBLE GUNS, BUBBLE MACHINES, BUBBLE WANDS, AND BUBBLE SOLUTION CONTAINERS (U.S. CLS. 22, 23, 38 AND 50).

FIRST USE 1-0-2006; IN COMMERCE 1-0-2006.
ANNE MADDEN, EXAMINING ATTORNEY

CLASS 28—(Continued).

SN 76-661,941. PLACO CORPORATION LIMITED, KOW-
LOON, HONG KONG, FILED 6-21-2006.

MY BUBBLING MOWER

THE MARK CONSISTS OF STANDARD CHARACTERS
WITHOUT CLAIM TO ANY PARTICULAR FONT, STYLE,
SIZE, OR COLOR.

NO CLAIM IS MADE TO THE EXCLUSIVE RIGHT TO
USE BUBBLING MOWER, APART FROM THE MARK AS
SHOWN.

FOR BATTERY OPERATED, HAND-HELD BUBBLE
TOYS, NAMELY BUBBLE GUNS, BUBBLE MACHINES,
BUBBLE WANDS, AND BUBBLE SOLUTION CONTAIN-
ERS; AND NON-BATTERY OPERATED, HAND-HELD
BUBBLE TOYS, NAMELY BUBBLE GUNS, BUBBLE
MACHINES, BUBBLE WANDS, AND BUBBLE SOLU-
TION CONTAINERS (U.S. CLS. 22, 23, 38 AND 50).

FIRST USE 1-0-2006; IN COMMERCE 1-0-2006.
ANNE MADDEN, EXAMINING ATTORNEY

CLASS 28—(Continued).

SN 76-667,430. THECIRCLE.ORG, LLC, CINCINNATI, OH.
FILED 10-12-2006.

THE CIRCLE

THE MARK CONSISTS OF STANDARD CHARACTERS
WITHOUT CLAIM TO ANY PARTICULAR FONT, STYLE,
SIZE, OR COLOR.

FOR GAMES AND PLAY THINGS, NAMELY, BOARD
GAMES (U.S. CLS. 22, 23, 38 AND 50).

PAULA MAYS, EXAMINING ATTORNEY

SN 76-665,062. O GALAXY, LLC, PLANTATION, FL. FILED
8-24-2006.

OGGIES

THE MARK CONSISTS OF STANDARD CHARACTERS
WITHOUT CLAIM TO ANY PARTICULAR FONT, STYLE,
SIZE, OR COLOR.

FOR GAMES, NAMELY A GAME USING COLLECT-
ABLE TRADING CARDS AS GAME IMPLEMENTS (U.S.
CLS. 22, 23, 38 AND 50).

JOHN DALIER, EXAMINING ATTORNEY

SN 76-667,437. THECIRCLE.ORG, LLC, CINCINNATI, OH.
FILED 10-12-2006.

MI CÍRCULO

THE MARK CONSISTS OF STANDARD CHARACTERS
WITHOUT CLAIM TO ANY PARTICULAR FONT, STYLE,
SIZE, OR COLOR.

THE FOREIGN WORDING IN THE MARK TRANSLATES
INTO ENGLISH AS MY CIRCLE.

FOR GAMES AND PLAYTHINGS, NAMELY, BOARD
GAMES (U.S. CLS. 22, 23, 38 AND 50).

PAULA MAYS, EXAMINING ATTORNEY

SN 76-665,167. PAOLINO, LILLIAN, GREAT NECK, NY.
FILED 8-28-2006.

MY FIRST STUFF

THE MARK CONSISTS OF STANDARD CHARACTERS
WITHOUT CLAIM TO ANY PARTICULAR FONT, STYLE,
SIZE, OR COLOR.

OWNER OF U.S. REG. NO. 2,857,481.

FOR TOYS, GAMES AND PLAY THINGS, NAMELY,
EDUCATIONAL GAMES AND PLAY THINGS;
NAMELY, PLUSH TOYS, ACTION FIGURES, SOFT
STUFFED FIGURES, MODEL PLASTIC TOY FIGUR-
INES, WATER PROOF BATH TOYS; BOARD-GAMES,
HANDHELD UNITS FOR PLAYING ELECTRONIC
GAMES, ACTION SKILL GAMES; DOLL COSTUMES,
CHARACTER BASED TOY PLASTIC PLAY TOOLS, JIG-
SAW PUZZLES, PLAY PUZZLES, PLAY MATS CON-
TAINING INFANT TOYS, PUPPETS, COSTUME MASKS,
BALLOONS; NOVELTIES FOR PARTIES, NAMELY
PARTY FAVORS IN THE FORM OF SMALL TOYS;
SPORTING ARTICLES, NAMELY CHILDREN'S PLAY-
GROUND BALLS, TOY AND MODEL BUILDINGS AND
VEHICLES; SOFT SCULPTURE TOYS, MUSIC BOX
TOYS, INFANT TOYS, STUFFED TOY ANIMALS TOYS;
TOY VEHICLES; DOLLS; TOY SCOOTERS; ELECTRIC
PLAY MOTOR CARS; CHECKERS (U.S. CLS. 22, 23, 38
AND 50).

SHARON MEIER, EXAMINING ATTORNEY

SN 76-670,622. MAHAR MANUFACTURING CORP., DBA
FIESTA CONCESSION CORP., VERNON, CA. FILED 12-
20-2006.

TUM-TUMS

THE MARK CONSISTS OF STANDARD CHARACTERS
WITHOUT CLAIM TO ANY PARTICULAR FONT, STYLE,
SIZE, OR COLOR.

FOR STUFFED PLUSH TOYS (U.S. CLS. 22, 23, 38 AND
50).

KATHLEEN LORENZO, EXAMINING ATTORNEY

CLASS 28—(Continued).

SN 76-675,558. MARTIN, DON J, BELLINGHAM, WA. FILED 4-16-2007.

STEERTUBE

THE MARK CONSISTS OF STANDARD CHARACTERS WITHOUT CLAIM TO ANY PARTICULAR FONT, STYLE, SIZE, OR COLOR.

FOR TOWABLE RECREATIONAL DEVICES, NAMELY, INFLATABLE INNER TUBES, KNEE BOARDS, WAKE BOARDS AND PARTS AND ACCESSORIES THEREFOR, NAMELY TOW LINES AND TOW HARNESSSES (U.S. CLS. 22, 23, 38 AND 50).

FIRST USE 1-0-1997; IN COMMERCE 9-0-1998.

STACY WAHLBERG, EXAMINING ATTORNEY

SN 76-677,735. JAY FRANCO & SONS, INC., NEW YORK, NY. FILED 6-4-2007.

JUST PINK ABOUT IT

THE MARK CONSISTS OF STANDARD CHARACTERS WITHOUT CLAIM TO ANY PARTICULAR FONT, STYLE, SIZE, OR COLOR.

FOR STUFFED TOY ANIMALS, STUFFED TOY FIGURES, AND TOY PILLOWS (U.S. CLS. 22, 23, 38 AND 50).

PATRICIA EVANKO, EXAMINING ATTORNEY

SN 76-677,736. JAY FRANCO & SONS, INC., NEW YORK, NY. FILED 6-4-2007.

PINKABLES

THE MARK CONSISTS OF STANDARD CHARACTERS WITHOUT CLAIM TO ANY PARTICULAR FONT, STYLE, SIZE, OR COLOR.

FOR STUFFED TOY ANIMALS, STUFFED TOY FIGURES, AND TOY PILLOWS (U.S. CLS. 22, 23, 38 AND 50).

PATRICIA EVANKO, EXAMINING ATTORNEY

CLASS 28—(Continued).

SN 77-037,575. TROPARIAN CORPORATION, INDIANAPOLIS, IN. FILED 11-6-2006.

WEE BELIEVERS

THE MARK CONSISTS OF STANDARD CHARACTERS WITHOUT CLAIM TO ANY PARTICULAR FONT, STYLE, SIZE, OR COLOR.

FOR TOYS, NAMELY, BABY MULTIPLE ACTIVITY TOYS; BATH TOYS; BATHTUB TOYS; BATTERY OPERATED ACTION TOYS; CHILDREN'S MULTIPLE ACTIVITY TOYS; CHILDREN'S MULTIPLE ACTIVITY TOYS SOLD AS A UNIT WITH PRINTED BOOKS; COLLECTABLE TOY FIGURES; CRIB TOYS; ELECTRIC ACTION TOYS; ELECTRONIC ACTION TOYS; ELECTRONIC LEARNING TOYS; FANTASY CHARACTER TOYS; INFANT ACTION CRIB TOYS; INFANT DEVELOPMENT TOYS; INFANT TOYS; INFLATABLE BATH TOYS; INFLATABLE TOYS; MODELED PLASTIC TOY FIGURINES; MOLDED TOY FIGURES; MUSIC BOX TOYS; MUSICAL TOYS; PLASTIC CHARACTER TOYS; PLAY MATS CONTAINING INFANT TOYS; PLUSH TOYS; POP UP TOYS; POSITIONABLE TOY FIGURES; RUBBER CHARACTER TOYS; SOFT SCULPTURE PLUSH TOYS; SOFT SCULPTURE TOYS; SQUEEZABLE SQUEAKING TOYS; SQUEEZE TOYS; STACKING TOYS; STUFFED TOY ANIMALS; STUFFED TOY BEARS; STUFFED TOYS; TALKING TOYS; TOY ACTION FIGURES; TOY ACTION FIGURES AND ACCESSORIES THEREFORE; TOY ANIMALS AND ACCESSORIES THEREFORE; TOY FIGURES; TOY FURNITURE; TOY HOUSES; TOY MOBILES, TOYS, NAMELY, BATTERY POWERED COMPUTER GAME WITH LCD SCREEN WHICH FEATURES ANIMATION AND SOUND EFFECTS; AND TOYS DESIGNED TO BE ATTACHED TO CAR SEATS, STROLLERS, CRIBS, AND HIGH CHAIRS (U.S. CLS. 22, 23, 38 AND 50).

SETH A. RAPPAPORT, EXAMINING ATTORNEY

SN 77-039,428. T.F.H. PUBLICATIONS, INC., NEPTUNE CITY, NJ. FILED 11-8-2006.

ODDBALLS

THE MARK CONSISTS OF STANDARD CHARACTERS WITHOUT CLAIM TO ANY PARTICULAR FONT, STYLE, SIZE, OR COLOR.

OWNER OF U.S. REG. NO. 1,739,122.
FOR PET TOYS (U.S. CLS. 22, 23, 38 AND 50).

RAUL CORDOVA, EXAMINING ATTORNEY

CLASS 28—(Continued).

SN 77-067,298. MATTEL, INC., EL SEGUNDO, CA. FILED 12-19-2006.

HERO CYCLES

THE MARK CONSISTS OF STANDARD CHARACTERS WITHOUT CLAIM TO ANY PARTICULAR FONT, STYLE, SIZE, OR COLOR.

FOR TOYS, GAMES AND PLAYTHINGS, NAMELY, TOY VEHICLES, TOY VEHICLE PLAYSETS, TOY VEHICLE TRACK SETS, AND ACCESSORIES FOR ALL OF THE FOREGOING (U.S. CLS. 22, 23, 38 AND 50).

LINDA ESTRADA, EXAMINING ATTORNEY

CLASS 28—(Continued).

SN 77-075,468. MATTEL, INC., EL SEGUNDO, CA. FILED 1-3-2007.

SLITHERBITE

THE MARK CONSISTS OF STANDARD CHARACTERS WITHOUT CLAIM TO ANY PARTICULAR FONT, STYLE, SIZE, OR COLOR.

FOR TOYS, GAMES AND PLAYTHINGS, NAMELY, TOY VEHICLES AND ACCESSORIES THEREFOR (U.S. CLS. 22, 23, 38 AND 50).

JOHN DWYER, EXAMINING ATTORNEY

SN 77-075,462. MATTEL, INC., EL SEGUNDO, CA. FILED 1-3-2007.

CROSSERS

THE MARK CONSISTS OF STANDARD CHARACTERS WITHOUT CLAIM TO ANY PARTICULAR FONT, STYLE, SIZE, OR COLOR.

FOR TOYS, GAMES AND PLAYTHINGS, NAMELY, TOY VEHICLES, TOY VEHICLE PLAYSETS, TOY VEHICLE TRACK SETS, TOY FIGURES, AND ACCESSORIES FOR ALL OF THE FOREGOING (U.S. CLS. 22, 23, 38 AND 50).

JOHN DWYER, EXAMINING ATTORNEY

SN 77-075,469. MATTEL, INC., EL SEGUNDO, CA. FILED 1-3-2007.

RINGSLEY

THE MARK CONSISTS OF STANDARD CHARACTERS WITHOUT CLAIM TO ANY PARTICULAR FONT, STYLE, SIZE, OR COLOR.

FOR TOYS, GAMES AND PLAYTHINGS, NAMELY, TOY VEHICLES AND ACCESSORIES THEREFOR (U.S. CLS. 22, 23, 38 AND 50).

JOHN DWYER, EXAMINING ATTORNEY

SN 77-075,465. MATTEL, INC., EL SEGUNDO, CA. FILED 1-3-2007.

JAMMIN' WORLD TOUR

THE MARK CONSISTS OF STANDARD CHARACTERS WITHOUT CLAIM TO ANY PARTICULAR FONT, STYLE, SIZE, OR COLOR.

OWNER OF U.S. REG. NO. 3,131,129.
FOR TOYS, GAMES AND PLAYTHINGS, NAMELY, DOLLS, DOLL CLOTHING AND DOLL ACCESSORIES, TOY FIGURES AND ACCESSORIES THEREFOR (U.S. CLS. 22, 23, 38 AND 50).

FIRST USE 5-25-2007; IN COMMERCE 5-25-2007.

JOHN DWYER, EXAMINING ATTORNEY

SN 77-077,416. MATTEL, INC., EL SEGUNDO, CA. FILED 1-5-2007.

FLIPPIN' FROGS

THE MARK CONSISTS OF STANDARD CHARACTERS WITHOUT CLAIM TO ANY PARTICULAR FONT, STYLE, SIZE, OR COLOR.

NO CLAIM IS MADE TO THE EXCLUSIVE RIGHT TO USE "FROGS", APART FROM THE MARK AS SHOWN.

FOR TOYS, GAMES AND PLAYTHINGS, NAMELY, PARLOR GAMES AND ACCESSORIES THEREFOR (U.S. CLS. 22, 23, 38 AND 50).

FIRST USE 5-22-2007; IN COMMERCE 5-22-2007.

JOHN DWYER, EXAMINING ATTORNEY

CLASS 28—(Continued).

SN 77-077,417. MATTEL, INC., EL SEGUNDO, CA. FILED 1-5-2007.

THUNDERBLADE

THE MARK CONSISTS OF STANDARD CHARACTERS WITHOUT CLAIM TO ANY PARTICULAR FONT, STYLE, SIZE, OR COLOR.
FOR TOYS, GAMES AND PLAYTHINGS, NAMELY, TOY VEHICLES AND ACCESSORIES THEREFOR (U.S. CLS. 22, 23, 38 AND 50).
JOHN DWYER, EXAMINING ATTORNEY

CLASS 28—(Continued).

SN 77-077,421. MATTEL, INC., EL SEGUNDO, CA. FILED 1-5-2007.

ALIEN CROSSER

THE MARK CONSISTS OF STANDARD CHARACTERS WITHOUT CLAIM TO ANY PARTICULAR FONT, STYLE, SIZE, OR COLOR.
FOR TOYS, GAMES AND PLAYTHINGS, NAMELY, TOY VEHICLES, TOY FIGURES, AND ACCESSORIES FOR ALL OF THE FOREGOING (U.S. CLS. 22, 23, 38 AND 50).
JOHN DWYER, EXAMINING ATTORNEY

SN 77-077,419. MATTEL, INC., EL SEGUNDO, CA. FILED 1-5-2007.

RAM SLAMMER

THE MARK CONSISTS OF STANDARD CHARACTERS WITHOUT CLAIM TO ANY PARTICULAR FONT, STYLE, SIZE, OR COLOR.
FOR TOYS, GAMES AND PLAYTHINGS, NAMELY, TOY VEHICLES AND ACCESSORIES THEREFOR (U.S. CLS. 22, 23, 38 AND 50).
JOHN DWYER, EXAMINING ATTORNEY

SN 77-077,422. MATTEL, INC., EL SEGUNDO, CA. FILED 1-5-2007.

JUMPER CROSSERS

THE MARK CONSISTS OF STANDARD CHARACTERS WITHOUT CLAIM TO ANY PARTICULAR FONT, STYLE, SIZE, OR COLOR.
FOR TOYS, GAMES AND PLAYTHINGS, NAMELY, TOY VEHICLES, TOY FIGURES, AND ACCESSORIES FOR ALL OF THE FOREGOING (U.S. CLS. 22, 23, 38 AND 50).
JOHN DWYER, EXAMINING ATTORNEY

SN 77-077,420. MATTEL, INC., EL SEGUNDO, CA. FILED 1-5-2007.

SWAGBLASTER

THE MARK CONSISTS OF STANDARD CHARACTERS WITHOUT CLAIM TO ANY PARTICULAR FONT, STYLE, SIZE, OR COLOR.
FOR TOYS, GAMES AND PLAYTHINGS, NAMELY, TOY VEHICLES AND ACCESSORIES THEREFOR (U.S. CLS. 22, 23, 38 AND 50).
CAROLYN CATALDO, EXAMINING ATTORNEY

SN 77-077,423. MATTEL, INC., EL SEGUNDO, CA. FILED 1-5-2007.

SPEEDER CROSSERS

THE MARK CONSISTS OF STANDARD CHARACTERS WITHOUT CLAIM TO ANY PARTICULAR FONT, STYLE, SIZE, OR COLOR.
FOR TOYS, GAMES AND PLAYTHINGS, NAMELY, TOY VEHICLES, TOY FIGURES, AND ACCESSORIES FOR ALL OF THE FOREGOING (U.S. CLS. 22, 23, 38 AND 50).
JOHN DWYER, EXAMINING ATTORNEY

CLASS 28—(Continued).

SN 77-077,424. MATTEL, INC., EL SEGUNDO, CA. FILED 1-5-2007.

SMASHER CROSSERS

THE MARK CONSISTS OF STANDARD CHARACTERS WITHOUT CLAIM TO ANY PARTICULAR FONT, STYLE, SIZE, OR COLOR.

FOR TOYS, GAMES AND PLAYTHINGS, NAMELY, TOY VEHICLES, TOY FIGURES, AND ACCESSORIES FOR ALL OF THE FOREGOING (U.S. CLS. 22, 23, 38 AND 50).

JOHN DWYER, EXAMINING ATTORNEY

CLASS 28—(Continued).

SN 77-077,429. MATTEL, INC., EL SEGUNDO, CA. FILED 1-5-2007.

ZOOM TAKAZUMI

THE MARK CONSISTS OF STANDARD CHARACTERS WITHOUT CLAIM TO ANY PARTICULAR FONT, STYLE, SIZE, OR COLOR.

FOR TOYS, GAMES AND PLAYTHINGS, NAMELY, TOY FIGURES AND ACCESSORIES THEREFOR (U.S. CLS. 22, 23, 38 AND 50).

CAROLYN CATALDO, EXAMINING ATTORNEY

SN 77-077,427. MATTEL, INC., EL SEGUNDO, CA. FILED 1-5-2007.

RAM HAMMER

THE MARK CONSISTS OF STANDARD CHARACTERS WITHOUT CLAIM TO ANY PARTICULAR FONT, STYLE, SIZE, OR COLOR.

FOR TOYS, GAMES AND PLAYTHINGS, NAMELY, TOY VEHICLES AND ACCESSORIES THEREFOR (U.S. CLS. 22, 23, 38 AND 50).

CAROLYN CATALDO, EXAMINING ATTORNEY

SN 77-077,430. MATTEL, INC., EL SEGUNDO, CA. FILED 1-5-2007.

BB RAMIREZ

THE MARK CONSISTS OF STANDARD CHARACTERS WITHOUT CLAIM TO ANY PARTICULAR FONT, STYLE, SIZE, OR COLOR.

THE NAME(S), PORTRAIT(S), AND/OR SIGNATURE(S) SHOWN IN THE MARK DOES NOT IDENTIFY A PARTICULAR LIVING INDIVIDUAL.

FOR TOYS, GAMES AND PLAYTHINGS, NAMELY, TOY FIGURES AND ACCESSORIES THEREFOR (U.S. CLS. 22, 23, 38 AND 50).

CAROLYN CATALDO, EXAMINING ATTORNEY

SN 77-077,428. MATTEL, INC., EL SEGUNDO, CA. FILED 1-5-2007.

JOHNNY SWAGGER

THE MARK CONSISTS OF STANDARD CHARACTERS WITHOUT CLAIM TO ANY PARTICULAR FONT, STYLE, SIZE, OR COLOR.

THE NAME(S), PORTRAIT(S), AND/OR SIGNATURE(S) SHOWN IN THE MARK DOES NOT IDENTIFY A PARTICULAR LIVING INDIVIDUAL.

FOR TOYS, GAMES AND PLAYTHINGS, NAMELY, TOY FIGURES AND ACCESSORIES THEREFOR (U.S. CLS. 22, 23, 38 AND 50).

CAROLYN CATALDO, EXAMINING ATTORNEY

SN 77-077,431. MATTEL, INC., EL SEGUNDO, CA. FILED 1-5-2007.

LABKO LABKOVITCH

THE MARK CONSISTS OF STANDARD CHARACTERS WITHOUT CLAIM TO ANY PARTICULAR FONT, STYLE, SIZE, OR COLOR.

FOR TOYS, GAMES AND PLAYTHINGS, NAMELY, TOY FIGURES AND ACCESSORIES THEREFOR (U.S. CLS. 22, 23, 38 AND 50).

CAROLYN CATALDO, EXAMINING ATTORNEY

CLASS 28—(Continued).

SN 77-117,093. BRANDON, LARRY, ST LOUIS, MO. FILED 2-27-2007.



NO CLAIM IS MADE TO THE EXCLUSIVE RIGHT TO USE "A WORD GAME OF KNOWLEDGE, VOCABULARY AND STRATEGY", APART FROM THE MARK AS SHOWN. THE MARK CONSISTS OF STYLIZED TEXT. FOR BOARD GAMES (U.S. CLS. 22, 23, 38 AND 50). FIRST USE 6-6-2005; IN COMMERCE 2-12-2007. CHERYL CLAYTON, EXAMINING ATTORNEY

SN 77-120,203. PRETTY UGLY LLC, EDISON, NJ. AND HORVATH, DAVID, EDISON, NJ. AND KIM, SUN-MIN, EDISON, NJ. FILED 3-1-2007.



THE COLOR(S) TURQUOISE, TAN, AND BLACK IS/ARE CLAIMED AS A FEATURE OF THE MARK. THE MARK CONSISTS OF THE DEPICTION OF A UNIQUE CHARACTER WITH A TURQUOISE, TAN EYES AND TEETH, A BLACK MOUTH. SEC. 2(F). FOR STUFFED TOYS (U.S. CLS. 22, 23, 38 AND 50). FIRST USE 9-1-2002; IN COMMERCE 9-1-2002. THEODORE MCBRIDE, EXAMINING ATTORNEY

CLASS 28—(Continued).

SN 77-120,427. CONSOL, CHRISTIAN, OCEANSIDE, CA. FILED 3-1-2007.

Victory Skateboards

THE MARK CONSISTS OF STANDARD CHARACTERS WITHOUT CLAIM TO ANY PARTICULAR FONT, STYLE, SIZE, OR COLOR.

NO CLAIM IS MADE TO THE EXCLUSIVE RIGHT TO USE "SKATEBOARDS", APART FROM THE MARK AS SHOWN.

FOR SKATEBOARD DECKS; SKATEBOARD GRIP TAPES; SKATEBOARD TRUCKS; SKATEBOARD WHEELS (U.S. CLS. 22, 23, 38 AND 50).

FIRST USE 9-1-2006; IN COMMERCE 9-1-2006. JULIE THOMAS, EXAMINING ATTORNEY

SN 77-137,850. TIMOTHY CREEK INC., ROCK CITY, IL. FILED 3-22-2007.

Spin-N-Strut

THE MARK CONSISTS OF STANDARD CHARACTERS WITHOUT CLAIM TO ANY PARTICULAR FONT, STYLE, SIZE, OR COLOR.

FOR TURKEY DECOY FOR HUNTING (U.S. CLS. 22, 23, 38 AND 50).

CHERYL CLAYTON, EXAMINING ATTORNEY

CLASS 28—(Continued).

SN 77-140,442. DISNEY ENTERPRISES, INC., BURBANK, CA. FILED 3-26-2007.

IRIDESSA

THE MARK CONSISTS OF STANDARD CHARACTERS WITHOUT CLAIM TO ANY PARTICULAR FONT, STYLE, SIZE, OR COLOR.

FOR ACTION SKILL GAMES; ACTION FIGURES AND ACCESSORIES THEREFORE; BOARD GAMES; CARD GAMES; CHILDREN'S MULTIPLE ACTIVITY TOYS; BADMINTON SETS; BALLOONS; BASKETBALLS; BATH TOYS; BASEBALLS; BEACH BALLS; BEAN BAGS; BEAN BAG DOLLS; TOY BUILDING BLOCKS; BOWLING BALLS; BUBBLE MAKING WANDS AND SOLUTION SETS; CHESS SETS; CHILDREN'S PLAY COSMETICS; CHRISTMAS STOCKINGS; CHRISTMAS TREE DECORATIONS; COLLECTABLE TOY FIGURES; CRIB MOBILES; CRIB TOYS; DISC TOSS TOYS; DOLLS; DOLL CLOTHING; DOLL ACCESSORIES; DOLL PLAYSETS; ELECTRIC ACTION TOYS; EQUIPMENT SOLD AS A UNIT FOR PLAYING CARD GAMES; FISHING TACKLE; GOLF BALLS; GOLF GLOVES; GOLF BALL MARKERS; HAND HELD UNIT FOR PLAYING ELECTRONIC GAMES; HOCKEY PUCKS; INFLATABLE TOYS; JIGSAW PUZZLES; JUMP ROPES; KITES; MAGIC TRICKS; MARBLES; MANIPULATIVE GAMES; MECHANICAL TOYS; MUSIC BOX TOYS; MUSICAL TOYS; PARLOR GAMES; PARTY FAVORS IN THE NATURE OF SMALL TOYS; PARTY GAMES; PLAYING CARDS; PLUSH TOYS; PUPPETS; ROLLER SKATES; RUBBER BALLS; SKATEBOARDS; SNOW GLOBES; SOCCER BALLS; SPINNING TOPS; SQUEEZE TOYS; STUFFED TOYS; TABLE TENNIS TABLES; TALKING TOYS; TARGET GAMES; TEDDY BEARS; TENNIS BALLS; TOY ACTION FIGURES; TOY BUCKET AND SHOVEL SETS; TOY MOBILES; TOY VEHICLES; TOY SCOOTERS; TOY CARS; TOY MODEL HOBBYCRAFT KITS; TOY FIGURES; TOY BANKS; TOY TRUCKS; TOY WATCHES; WIND-UP TOYS; YO-YOS (U.S. CLS. 22, 23, 38 AND 50).
AMY BROZENIC, EXAMINING ATTORNEY

SN 77-143,473. BRET W. TALBERT, BETHLEHEM, PA. FILED 3-29-2007.



THE COLOR(S) BLACK, WHITE, YELLOW AND RED IS/ARE CLAIMED AS A FEATURE OF THE MARK.

THE MARK CONSISTS OF "J" IN WHITE ON A SQUARE BLACK BACKGROUND, "I" IN RED ON A SQUARE YELLOW BACKGROUND WHICH HAS A BLACK BORDER, "N" IN BLACK ON A SQUARE WHITE BACKGROUND WHICH HAS A BLACK BORDER, AND "G" IN WHITE ON A SQUARE RED BACKGROUND WHICH HAS A BLACK BORDER.

FOR BOARD GAMES (U.S. CLS. 22, 23, 38 AND 50).
JEAN IM, EXAMINING ATTORNEY

CLASS 28—(Continued).

SN 77-145,200. UNIMAX TOYS, LTD., TSIM SHA TSUI, KOWLOON, HONG KONG, FILED 3-30-2007.

BRAVO TEAM

THE MARK CONSISTS OF STANDARD CHARACTERS WITHOUT CLAIM TO ANY PARTICULAR FONT, STYLE, SIZE, OR COLOR.

FOR TOYS, GAMES AND PLAYTHINGS, NAMELY, CHILDREN'S MULTIPLE ACTIVITY TOYS WITH ELECTRONIC LIGHTS, CHILDREN'S MULTIPLE ACTIVITY TOYS WITHOUT ELECTRONIC LIGHTS, CHILDREN'S MULTIPLE ACTIVITY TOYS WITH ELECTRONIC DEVICES THAT PRODUCE SOUND, CHILDREN'S MULTIPLE ACTIVITY TOYS WITHOUT ELECTRONIC DEVICES THAT PRODUCE SOUND, MECHANICALLY-OPERATED, ELECTRICALLY-OPERATED AND BATTERY-OPERATED DIE CAST AND PLASTIC TOY VEHICLES, TOY ACTION FIGURES AND TOY MODEL CARS, TOY MODEL VEHICLES AND RELATED ACCESSORIES SOLD AS UNITS, CHILDREN'S TOY ACTION FIGURES AND PLAY SETS THEREFOR, MUSICAL TOYS, AND RADIO CONTROLLED AND REMOTE CONTROLLED TOY VEHICLES AND STRUCTURAL PARTS AND PLAY SETS THEREFOR (U.S. CLS. 22, 23, 38 AND 50).

RAY THOMAS, EXAMINING ATTORNEY

SN 77-146,888. HERRON, INC., PAOLA, KS. FILED 4-2-2007.



NO CLAIM IS MADE TO THE EXCLUSIVE RIGHT TO USE "TRUCKS", APART FROM THE MARK AS SHOWN.

THE COLOR(S) BLUE AND WHITE IS/ARE CLAIMED AS A FEATURE OF THE MARK.

THE MARK CONSISTS OF THE WORDS HERRON TRUCKS IN BLUE BELOW A BLUE STYLIZED HERON WITH WHITE MARKS IN AND AROUND ITS EYE, FEATHERS AND LEG, ALL ON A BLUE BACKGROUND.

FOR SKATEBOARD TRUCKS; SKATEBOARD WHEELS (U.S. CLS. 22, 23, 38 AND 50).
DAVID YONTEF, EXAMINING ATTORNEY

CLASS 28—(Continued).

SN 77-149,327. MCCARTHY, KEVIN, REDMOND, WA.
FILED 4-5-2007.

SKWIM

THE MARK CONSISTS OF STANDARD CHARACTERS WITHOUT CLAIM TO ANY PARTICULAR FONT, STYLE, SIZE, OR COLOR.

FOR ACTION WATER SPORT GAME FEATURING A THROWING DISC (U.S. CLS. 22, 23, 38 AND 50).
ALYSSA PALADINO, EXAMINING ATTORNEY

CLASS 28—(Continued).

SN 77-151,140. KENT, GARY, CHANDLER, AZ. FILED 4-6-2007.

BOUNCE 'N' STIK

THE MARK CONSISTS OF STANDARD CHARACTERS WITHOUT CLAIM TO ANY PARTICULAR FONT, STYLE, SIZE, OR COLOR.

FOR ACTION SKILL GAME USED FOR COMPETITIVE ENTERTAINMENT, NAMELY, A TOY CONSISTING OF A STICK WITH A BALL AT ONE END AND A SUCTION CUP AT THE OTHER, IN WHICH THE STICK IS USED TO SPIN AND BOUNCE THE BALL SO THAT THE SUCTION CUP WILL STICK ON A HARD SURFACE (U.S. CLS. 22, 23, 38 AND 50).
ROBIN MITTLER, EXAMINING ATTORNEY

SN 77-150,435. FRANCIS A. LONG, UPPER MARLBORO, MD. FILED 4-6-2007.



NO CLAIM IS MADE TO THE EXCLUSIVE RIGHT TO USE "GLOVE", APART FROM THE MARK AS SHOWN.

THE APPLICANT CLAIMS COLOR AS A FEATURE OF THE MARK, NAMELY, YELLOW AND BLACK.

THE MARK CONSISTS OF THE WORDS FISHOFF GLOVE IN YELLOW ON A BLACK OVAL SHAPE.

FOR FISH GRABBING GLOVE USED FOR FISHING (U.S. CLS. 22, 23, 38 AND 50).

FIRST USE 1-1-2007; IN COMMERCE 1-1-2007.
TINA BROWN, EXAMINING ATTORNEY

SN 77-153,487. WALLACE, TRACY D., GRIFFIN, GA. FILED 4-10-2007.

INTRUDER

SN 77-151,122. INTERNATIONAL SURF VENTURES INC., NATIONAL CITY, CA. FILED 4-6-2007.

NO CLAIM IS MADE TO THE EXCLUSIVE RIGHT TO USE "SURFBOARDS", APART FROM THE MARK AS SHOWN.

THE MARK CONSISTS OF THE WORDS ISLE SURFBOARDS IN STYLIZED TEXT.

FOR SURFBOARDS (U.S. CLS. 22, 23, 38 AND 50).
FIRST USE 7-1-2004; IN COMMERCE 7-1-2004.

KATHERINE M. DUBRAY, EXAMINING ATTORNEY

THE MARK CONSISTS OF STANDARD CHARACTERS WITHOUT CLAIM TO ANY PARTICULAR FONT, STYLE, SIZE, OR COLOR.

FOR GOLF CLUBS; GOLF IRONS (U.S. CLS. 22, 23, 38 AND 50).

BENJAMIN OKEKE, EXAMINING ATTORNEY

CLASS 28—(Continued).

SN 77-154,763. HOOK, LINE & SINKER, INC., ROGERS, AR. FILED 4-12-2007.



THE COLOR(S) BLACK, YELLOW, BROWN, WHITE, BLUE, RED AND ORANGE IS/ARE CLAIMED AS A FEATURE OF THE MARK.

THE MARK CONSISTS OF BLOCK LETTERS BASS AND - IN BLACK WITH YELLOW TRIM AROUND EACH FOLLOWED BY A STYLIZED LETTER X IN BLACK, WITH A YELLOW TRIM AND A RED TRIM, OVER BLUE WATER, AND A FISH WITH A BROWN AND BLACK BODY AND A WHITE MOUTH STYLIZED AROUND SS-X, ALL ON AN ORANGE BACKGROUND.

FOR ARTIFICIAL FISHING BAIT; ARTIFICIAL FISHING LURES; ARTIFICIAL FISHING WORMS; BITE INDICATORS; BITE SENSORS; FISH ATTRACTANTS; FISH HOOK REMOVERS; FISHING BUOYS; FISHING CREELS; FISHING EQUIPMENT, NAMELY, CLAMPS FOR SECURING FISHING EQUIPMENT ON BODY; FISHING EQUIPMENT, NAMELY, WINGING MATERIAL FOR FISHING JIGS AND STREAMERS; FISHING FLIES; FISHING FLOATS; FISHING FLY BOXES; FISHING GAFFS; FISHING HOOKS; FISHING LEADERS; FISHING LINES; FISHING LURE BOXES; FISHING LURE PARTS, NAMELY, SWIVELS, HOOKS AND BLADES; FISHING LURES; FISHING LURES, NAMELY, LEECHES; FISHING LURES, NAMELY, PLASTIC WORMS; FISHING LURES, NAMELY, SPOONS; FISHING PLUGS; FISHING POLE HOLDERS WORN ON THE BODY; FISHING REELS; FISHING ROD BLANKS; FISHING ROD CASES; FISHING ROD HANDLES; FISHING ROD HOLDERS; FISHING ROD RACKS; FISHING RODS; FISHING SAFETY HARNESS; FISHING SINKERS; FISHING SPINNERS; FISHING TACKLE; FISHING TACKLE BOXES; FISHING TACKLE CONTAINERS; FISHING WEIGHTS; FLIES FOR USE IN FISHING; HAND-HELD FISHING NETS; HAND-HELD FISHING NETS FOR SPORTSMEN; ICE FISHING STRIKE INDICATOR; INFLATABLE FLOAT TUBES FOR FISHING; LURES FOR HUNTING; PACKAGED FREEZE-DRIED FISHING BAIT; SCENT LURES FOR HUNTING OR FISHING; SPEARS FOR USE IN FISHING; SPORTSMAN'S FISHING BAGS (U.S. CLS. 22, 23, 38 AND 50).
ANDREA SAUNDERS, EXAMINING ATTORNEY

SN 77-156,133. CALINTEN, LLC, HERNDON, VA. FILED 4-13-2007.

TAKEOVER The Business of Tycoons

THE MARK CONSISTS OF STANDARD CHARACTERS WITHOUT CLAIM TO ANY PARTICULAR FONT, STYLE, SIZE, OR COLOR.

FOR BOARD GAMES (U.S. CLS. 22, 23, 38 AND 50).
JEFF DEFORD, EXAMINING ATTORNEY

CLASS 28—(Continued).

SN 77-156,681. GILLIHAN, MICHAEL A., SHERIDAN, IL. FILED 4-13-2007.

JAILED BAIT

THE MARK CONSISTS OF STANDARD CHARACTERS WITHOUT CLAIM TO ANY PARTICULAR FONT, STYLE, SIZE, OR COLOR.

FOR FISHING HOOKS; FISHING AID WHICH SINKS TO THE BOTTOM OF ANY BODY OF WATER IN WHICH IT IS PLACED AND STANDS VERTICALLY FROM THE BOTTOM WITH FISH LINE ATTACHED A FEW INCHES FROM THE HOOK INTENDED TO CATCH THE FISH; FISHING LURE PARTS; FISHING LURES; FISH ATTRACTANTS; LURES FOR FISHING (U.S. CLS. 22, 23, 38 AND 50).

TASNEEM HUSSAIN, EXAMINING ATTORNEY

SN 77-156,895. DENOUL THIERRY J, SAN FRANCISCO, CA. FILED 4-14-2007.

wildomino

THE MARK CONSISTS OF STANDARD CHARACTERS WITHOUT CLAIM TO ANY PARTICULAR FONT, STYLE, SIZE, OR COLOR.

FOR DOMINOES; BOARD GAMES; CARD GAMES; DICE GAMES (U.S. CLS. 22, 23, 38 AND 50).

MICHELE SWAIN, EXAMINING ATTORNEY

SN 77-157,392. STEVEN MENOW, YARDLEY, PA. FILED 4-16-2007.

GOODIE GUSHER

THE MARK CONSISTS OF STANDARD CHARACTERS WITHOUT CLAIM TO ANY PARTICULAR FONT, STYLE, SIZE, OR COLOR.

FOR PINATAS; PARTY GAMES (U.S. CLS. 22, 23, 38 AND 50).

FIRST USE 2-1-2007; IN COMMERCE 2-1-2007.
STEVEN R. FINE, EXAMINING ATTORNEY

CLASS 28—(Continued).

SN 77-157,422. RODRIGUEZ, ROLDAN VINCENT, WEST HILLS, CA. FILED 4-16-2007.

CUTE LITTLE URBAN BUDDIES

THE MARK CONSISTS OF STANDARD CHARACTERS WITHOUT CLAIM TO ANY PARTICULAR FONT, STYLE, SIZE, OR COLOR.

FOR DOLL CASES; DOLL CLOTHING; DOLL COSTUMES; DOLL FURNITURE; DOLLS; DOLLS FOR PLAYING; PAPER DOLLS; PLUSH TOYS; PORCELAIN DOLLS; PUPPETS; RAG DOLLS; SOFT SCULPTURE DOLLS; STUFFED DOLLS AND ANIMALS; BATH TOYS; DOLL HOUSE FURNISHINGS; DOLL HOUSES; FURNITURE FOR DOLL'S HOUSES; PLAY WANDS; TOY AIRPLANES; TOY BANKS; TOY BUILDING BLOCKS; TOY MODEL CARS; TOY MODEL TRAIN SETS; WIND-UP TOYS; DOLLS AND PLAYSETS THEREFOR; BALLOONS; BUBBLE MAKING WAND AND SOLUTION SETS; CARD GAMES; CHILDREN'S PLAY COSMETICS; FLYING DISCS; ICE SKATES; JIGSAW PUZZLES; JUMP ROPES; KITES; MANIPULATIVE PUZZLES; MUSIC BOX TOYS; MUSICAL TOYS; PLAY SWIMMING POOLS; PUZZLES; RIDE-ON TOYS; ROLLER SKATES; TOY MOBILES; BOARD GAMES; IN-LINE SKATES; MECHANICAL ACTION TOYS; PADDLES FOR USE IN PADDLE BALL GAMES; PARLOR GAMES; PARTY GAMES; PLAY HOUSES; PLAY TENTS; PLAYGROUND BALLS; SKATEBOARDS; SPORT BALLS; TALKING TOYS; WATER SQUIRTING TOYS; YO-YOS; DRAWING TOYS; BATTERY OPERATED ACTION TOYS; ELECTRIC ACTION TOYS; ROLE PLAYING GAMES; TOY VEHICLES; PLAYGROUND EQUIPMENT, NAMELY, SWING SETS, JUMP HOUSES AND JUMP STICKS, TEETER TOTTERS; ACTION SKILL GAMES; ARCADE GAMES; CHRISTMAS STOCKINGS; CHRISTMAS TREE ORNAMENTS; CHRISTMAS TREE ORNAMENTS, NAMELY, BELLS; HAND HELD UNIT FOR PLAYING ELECTRONIC GAMES; PARTY FAVORS IN THE NATURE OF CRACKERS AND NOISEMAKERS; TOY HOOP SETS (U.S. CLS. 22, 23, 38 AND 50).

ARETHA SOMERVILLE, EXAMINING ATTORNEY

SN 77-158,001. PRECISION EMBEDDED LLC, ANTELOPE, CA. FILED 4-16-2007.

X10

THE MARK CONSISTS OF STANDARD CHARACTERS WITHOUT CLAIM TO ANY PARTICULAR FONT, STYLE, SIZE, OR COLOR.

FOR EQUIPMENT SOLD AS A UNIT FOR PLAYING CARD GAMES; GAMING TABLES (U.S. CLS. 22, 23, 38 AND 50).

KAREN SEVERSON, EXAMINING ATTORNEY

CLASS 28—(Continued).

SN 77-158,139. DIECE-LISA INDUSTRIES, INC., CLIFFSIDE PARK, NJ. FILED 4-17-2007.

LOTS OF HUGS

THE MARK CONSISTS OF STANDARD CHARACTERS WITHOUT CLAIM TO ANY PARTICULAR FONT, STYLE, SIZE, OR COLOR.

FOR TOYS, NAMELY, PUPPETS (U.S. CLS. 22, 23, 38 AND 50).

FIRST USE 12-2-1995; IN COMMERCE 12-2-1995.

GIANCARLO CASTRO, EXAMINING ATTORNEY

SN 77-158,168. CROWLEYJONES, L.P., AUSTIN, TX. FILED 4-17-2007.

BOOBLES

THE MARK CONSISTS OF STANDARD CHARACTERS WITHOUT CLAIM TO ANY PARTICULAR FONT, STYLE, SIZE, OR COLOR.

FOR TOYS, NAMELY, COLLECTIBLE DOLLS (U.S. CLS. 22, 23, 38 AND 50).

FRANK LATTUCA, EXAMINING ATTORNEY

SN 77-158,331. DARF, INCORPORATED, PORTLAND, OR. FILED 4-17-2007.

Funagle

THE MARK CONSISTS OF STANDARD CHARACTERS WITHOUT CLAIM TO ANY PARTICULAR FONT, STYLE, SIZE, OR COLOR.

FOR BOARD GAMES (U.S. CLS. 22, 23, 38 AND 50).

DEBRA LEE, EXAMINING ATTORNEY

CLASS 28—(Continued).

SN 77-158,332. TRIPLE ONE CO., LTD., TAIPEI, TAIWAN, FILED 4-17-2007.

MINO

THE MARK CONSISTS OF STANDARD CHARACTERS WITHOUT CLAIM TO ANY PARTICULAR FONT, STYLE, SIZE, OR COLOR.

FOR CHILDREN'S MULTIPLE ACTIVITY TOYS; COLLECTABLE TOY FIGURES; ELECTRONIC LEARNING TOYS; ELECTRIC ACTION TOYS; PLUSH TOYS; TALKING TOYS; TOY ANIMALS AND ACCESSORIES THEREFOR (U.S. CLS. 22, 23, 38 AND 50).

CARRIE GENOVESE, EXAMINING ATTORNEY



SN 77-158,495. CP FISHING, PORTLAND, OR. FILED 4-17-2007.

BIOLINE

THE MARK CONSISTS OF STANDARD CHARACTERS WITHOUT CLAIM TO ANY PARTICULAR FONT, STYLE, SIZE, OR COLOR.

FOR FISHING LINES; FISHING HOOKS (U.S. CLS. 22, 23, 38 AND 50).

MATTHEW EINSTEIN, EXAMINING ATTORNEY



SN 77-158,591. CP FISHING, PORTLAND, OR. FILED 4-17-2007.

CP

THE MARK CONSISTS OF STANDARD CHARACTERS WITHOUT CLAIM TO ANY PARTICULAR FONT, STYLE, SIZE, OR COLOR.

FOR FISHING HOOKS; FISHING LINES (U.S. CLS. 22, 23, 38 AND 50).

MATTHEW EINSTEIN, EXAMINING ATTORNEY

CLASS 28—(Continued).

SN 77-158,811. HAMMOND, KIRBY J., OROVILLE, CA. FILED 4-17-2007.

Greenhouse Gas Babies

THE MARK CONSISTS OF STANDARD CHARACTERS WITHOUT CLAIM TO ANY PARTICULAR FONT, STYLE, SIZE, OR COLOR.

FOR STUFFED DOLLS AND ANIMALS (U.S. CLS. 22, 23, 38 AND 50).

DAVID H. STINE, EXAMINING ATTORNEY



SN 77-158,855. CARR SPECIALTY BAITS, INC., ST. AUGUSTINE, FL. FILED 4-17-2007.

T.N.A. The Natural Alternative

THE MARK CONSISTS OF STANDARD CHARACTERS WITHOUT CLAIM TO ANY PARTICULAR FONT, STYLE, SIZE, OR COLOR.

NO CLAIM IS MADE TO THE EXCLUSIVE RIGHT TO USE "NATURAL", APART FROM THE MARK AS SHOWN.

FOR BIOCHEMICALLY ENGINEERED MOLDED SALTWATER AND FRESHWATER ARTIFICIAL FISH BAITS AND LURES TO BE BIODEGRADABLE AND MARINE DEGRADABLE, MADE WITH ALL NATURAL INGREDIENTS (U.S. CLS. 22, 23, 38 AND 50).

AHSEN KHAN, EXAMINING ATTORNEY



SN 77-158,985. WRIGHT, FELIX, DETROIT, MI. FILED 4-17-2007.

Are You Crucified With Christ Trivia Bible Game

THE MARK CONSISTS OF STANDARD CHARACTERS WITHOUT CLAIM TO ANY PARTICULAR FONT, STYLE, SIZE, OR COLOR.

NO CLAIM IS MADE TO THE EXCLUSIVE RIGHT TO USE "TRIVIA BIBLE GAME", APART FROM THE MARK AS SHOWN.

FOR BOARD GAMES (U.S. CLS. 22, 23, 38 AND 50). FIRST USE 1-0-2007; IN COMMERCE 3-27-2007.

JANET LEE, EXAMINING ATTORNEY

CLASS 28—(Continued).

SN 77-159,202. GENESIS INTERNATIONAL, INC., SEOUL, REPUBLIC OF KOREA, FILED 4-18-2007.



The Seventh Element

THE MARK CONSISTS OF THE NUMERAL SEVEN, TWO ANGLED LINES POSITIONED NEAR OR INTERSECTING THE NUMERAL SEVEN, AND THE WORDS "THE SEVENTH ELEMENT".

FOR PAINT BALL GUN ACCESSORIES SOLD AS PARTS THEREFOR, NAMELY, GRIPS, GRIP FRAMES, GRIP MOUNTS, SNATCH GRIPS, FORE GRIPS, WRAP-AROUND GRIPS, WRAPAROUND GRIP PANELS, FRAMES, FRAME COVERS, BARRELS, BARREL ADAPTERS, BARREL SYSTEMS, BARREL PLUGS, TRIGGERS, TRIGGER ASSEMBLIES, BARREL PLUGS, COMPRESSED-GAS PRESSURE REGULATORS, COMPRESSED-GAS REGULATOR ASSEMBLY KITS, VALVES, DROP FORWARDS, FITTINGS FOR CONNECTING PAINT BALL GUN PARTS AND ACCESSORIES, THREAD-SAVING COMPRESSED-GAS CAPS, FILL NIPPLE CAPS, FEED NECKS, BOLTS, SIGHT RAILS, ON-OFF VALVES, EXPANSION CHAMBERS, GAS THRU PAINT BALL GUN GRIPS, COMPRESSED-GAS BOTTOM LINE HOSES, COMPRESSED-GAS BOTTOM LINE ADAPTERS, ASA (AIR SYSTEM ASSEMBLY) RAILS, AIR SYSTEM ADAPTERS, REMOTES BEING A HOSE THAT CONNECTS A PAINT BALL GUN TO A BACKPACK HAVING A COMPRESSED GAS SOURCE, GAS HOSES, BLOW OUT DISCS, BIPEDS (U.S. CLS. 22, 23, 38 AND 50).

REBECCA EISINGER, EXAMINING ATTORNEY

SN 77-159,717. PARKER, BETH ANN, NORTH BERWICK, ME. FILED 4-18-2007.

BILL PLUMMER'S SUPERFROG

THE MARK CONSISTS OF STANDARD CHARACTERS WITHOUT CLAIM TO ANY PARTICULAR FONT, STYLE, SIZE, OR COLOR.

THE NAME(S), PORTRAIT(S), AND/OR SIGNATURE(S) SHOWN IN THE MARK DOES NOT IDENTIFY A PARTICULAR LIVING INDIVIDUAL.

FOR FISHING LURES (U.S. CLS. 22, 23, 38 AND 50).

FIRST USE 12-31-1975; IN COMMERCE 12-31-1975.

LINDA M. KING, EXAMINING ATTORNEY

CLASS 28—(Continued).

SN 77-159,849. MIZUNO USA, INC., NORCROSS, GA. FILED 4-18-2007.

GEO-CUBIX

THE MARK CONSISTS OF STANDARD CHARACTERS WITHOUT CLAIM TO ANY PARTICULAR FONT, STYLE, SIZE, OR COLOR.

FOR GOLF CLUBS (U.S. CLS. 22, 23, 38 AND 50).

JIM RINGLE, EXAMINING ATTORNEY

SN 77-160,082. MAXIM MARKETING CORP., ALISO VIEJO, CA. FILED 4-18-2007.

INCOGNITO

THE MARK CONSISTS OF STANDARD CHARACTERS WITHOUT CLAIM TO ANY PARTICULAR FONT, STYLE, SIZE, OR COLOR.

FOR COSTUME MASKS (U.S. CLS. 22, 23, 38 AND 50).

LEE-ANNE BERNS, EXAMINING ATTORNEY

SN 77-160,490. MATTEL, INC., EL SEGUNDO, CA. FILED 4-19-2007.

MIA

THE MARK CONSISTS OF STANDARD CHARACTERS WITHOUT CLAIM TO ANY PARTICULAR FONT, STYLE, SIZE, OR COLOR.

FOR TOYS, GAMES AND PLAYTHINGS, NAMELY, TOY VEHICLES AND ACCESSORIES THEREFOR (U.S. CLS. 22, 23, 38 AND 50).

MATTHEW PAPPAS, EXAMINING ATTORNEY

CLASS 28—(Continued).

SN 77-160,507. OH, THAT BABY! LTD., DENVER, CO. FILED 4-19-2007.

CLASS 28—(Continued).

SN 77-161,241. GETTOEGRIP, LLC, SAN PEDRO, CA. FILED 4-19-2007.

Toofeze

THE MARK CONSISTS OF STANDARD CHARACTERS WITHOUT CLAIM TO ANY PARTICULAR FONT, STYLE, SIZE, OR COLOR.

FOR BABY MULTIPLE ACTIVITY TOYS; BENDABLE TOYS; INFANT DEVELOPMENT TOYS; INFANT TOYS (U.S. CLS. 22, 23, 38 AND 50).

FIRST USE 1-1-2007; IN COMMERCE 1-1-2007.
GIANCARLO CASTRO, EXAMINING ATTORNEY

Gettoegrip

THE MARK CONSISTS OF STANDARD CHARACTERS WITHOUT CLAIM TO ANY PARTICULAR FONT, STYLE, SIZE, OR COLOR.

FOR SKATEBOARD DECKS; SKATEBOARD GRIP TAPES (U.S. CLS. 22, 23, 38 AND 50).

ALICE BENMAMAN, EXAMINING ATTORNEY

SN 77-160,510. NEW FRONTIER PRODUCTS, LLC, SWISHER, IA. FILED 4-19-2007.

BOWRAK

THE MARK CONSISTS OF STANDARD CHARACTERS WITHOUT CLAIM TO ANY PARTICULAR FONT, STYLE, SIZE, OR COLOR.

FOR ARCHERY EQUIPMENT, NAMELY BOW HOLDERS (U.S. CLS. 22, 23, 38 AND 50).

FIRST USE 11-1-2002; IN COMMERCE 0-0-2003.
GIANCARLO CASTRO, EXAMINING ATTORNEY

SN 77-161,305. LYBARGER, CAROLYN S, CAPISTRANO BEACH, CA. FILED 4-19-2007.

SN 77-160,822. CUDDLY RIGOR MORTIS, LLC, JACKSON, NJ. FILED 4-19-2007.

JOE MOTION

CUDDLY RIGOR MORTIS

THE MARK CONSISTS OF STANDARD CHARACTERS WITHOUT CLAIM TO ANY PARTICULAR FONT, STYLE, SIZE, OR COLOR.

FOR DOLLS; BEAN BAG DOLLS; SOFT SCULPTURE DOLLS; STUFFED DOLLS AND ANIMALS; SOFT SCULPTURE PLUSH TOYS (U.S. CLS. 22, 23, 38 AND 50).

FIRST USE 10-2-2005; IN COMMERCE 10-2-2005.
KIMBERLY FRYE, EXAMINING ATTORNEY

THE MARK CONSISTS OF STANDARD CHARACTERS WITHOUT CLAIM TO ANY PARTICULAR FONT, STYLE, SIZE, OR COLOR.

FOR SURFBOARD FINS (U.S. CLS. 22, 23, 38 AND 50).

FIRST USE 12-6-2006; IN COMMERCE 12-6-2006.
NAAKWAMA ANKRAH, EXAMINING ATTORNEY

CLASS 28—(Continued).

SN 77-161,711. MVL RIGHTS LLC, BEVERLY HILLS, CA.
FILED 4-20-2007.

DOCTOR STRANGE

THE MARK CONSISTS OF STANDARD CHARACTERS WITHOUT CLAIM TO ANY PARTICULAR FONT, STYLE, SIZE, OR COLOR.

OWNER OF U.S. REG. NO. 1,099,497.

THE NAME DOCTOR STRANGE DOES NOT IDENTIFY A LIVING INDIVIDUAL.

FOR TOY ACTION FIGURES AND ACCESSORIES THEREFOR; MECHANICAL ACTION TOYS; PLAYSETS FOR USE WITH TOY ACTION FIGURES AND FOR MAKE-BELIEVE PLAY BATTLE OR ADVENTURE ACTIVITIES; BATTERY OPERATED ACTION TOYS; RADIO CONTROLLED TOY VEHICLES; TOY VEHICLES; PLUSH TOYS; SOFT SCULPTURE TOYS; DOLL ACCESSORIES; DOLLS; BEAN BAG DOLLS; BENDABLE TOYS; STUFFED TOY ANIMALS; SURF BOARDS; SURF FINS; SWIM BOARDS FOR RECREATIONAL USE; SWIM FINS; TARGET GAMES; PUPPETS; ROLE PLAYING GAMES; RUBBER BALLS; BALLOONS; BOARD GAMES; CHESS SETS; WATER SQUIRTING TOYS; YO-YOS; INFLATABLE SWIMMING POOLS; INFLATABLE TOYS; JIGSAW PUZZLES; JUMP ROPES; KITES; KNEE PADS FOR ATHLETIC USE; CARD GAMES; PLAYING CARDS; FLYING DISCS; GAME TABLES; TOY WATCHES; TOY WEAPONS; TOY MODEL HOBBY-CRAFT KITS; HAND HELD UNIT FOR PLAYING VIDEO GAMES; COIN-OPERATED VIDEO GAMES; ARCADE GAMES; PINBALL GAMES; PINBALL-TYPE GAMES; ROLLER SKATES; IN-LINE SKATES; ELBOW PADS FOR ATHLETIC USE; SNOW SLEDS FOR RECREATIONAL USE; CHRISTMAS TREE ORNAMENTS; SNOW BOARDS (U.S. CLS. 22, 23, 38 AND 50).

LYDIA BELZER, EXAMINING ATTORNEY

SN 77-162,031. PROMAXIMA MANUFACTURING, LTD.,
HOUSTON, TX. FILED 4-20-2007.

RAPTOR

THE MARK CONSISTS OF STANDARD CHARACTERS WITHOUT CLAIM TO ANY PARTICULAR FONT, STYLE, SIZE, OR COLOR.

FOR EXERCISING EQUIPMENT, NAMELY WEIGHT LIFTING MACHINES (U.S. CLS. 22, 23, 38 AND 50).

FIRST USE 1-0-2007; IN COMMERCE 1-0-2007.

JASON LOTT, EXAMINING ATTORNEY

CLASS 28—(Continued).

SN 77-162,063. PROMAXIMA MANUFACTURING, LTD.,
HOUSTON, TX. FILED 4-20-2007.

PROMAXIMA

THE MARK CONSISTS OF STANDARD CHARACTERS WITHOUT CLAIM TO ANY PARTICULAR FONT, STYLE, SIZE, OR COLOR.

FOR EXERCISING EQUIPMENT, NAMELY WEIGHT LIFTING MACHINES (U.S. CLS. 22, 23, 38 AND 50).

FIRST USE 1-0-1988; IN COMMERCE 1-0-1988.

JASON LOTT, EXAMINING ATTORNEY

SN 77-162,195. DIFFLEY, BRETT J., BLACK DIAMOND, WA.
FILED 4-20-2007.

FROLICKING FLOATERS

THE MARK CONSISTS OF STANDARD CHARACTERS WITHOUT CLAIM TO ANY PARTICULAR FONT, STYLE, SIZE, OR COLOR.

NO CLAIM IS MADE TO THE EXCLUSIVE RIGHT TO USE "FLOATERS", APART FROM THE MARK AS SHOWN. FOR INFLATABLE WATER TOYS (U.S. CLS. 22, 23, 38 AND 50).

ELLEN B. AWRICH, EXAMINING ATTORNEY

SN 77-164,294. CHRISTOPHER BRYAN TATE, LITTLE
ROCK, AR. FILED 4-24-2007.

Cut-A-Cup

THE MARK CONSISTS OF STANDARD CHARACTERS WITHOUT CLAIM TO ANY PARTICULAR FONT, STYLE, SIZE, OR COLOR.

FOR EQUIPMENT SOLD AS A UNIT FOR PLAYING GOLF TYPE GAMES, NAMELY A DEVICE FOR DIGGING A HOLE IN HARD-PAN SAND ON A BEACH, AT A LAKE, A POND OR AT THE OCEAN FOR PUTTING PURPOSES (U.S. CLS. 22, 23, 38 AND 50).

CAROLINE WOOD, EXAMINING ATTORNEY

CLASS 28—(Continued).

SN 77-164,856. AV8TRIX, LLC, BLOOMFIELD HILLS, MI. FILED 4-25-2007.



NO CLAIM IS MADE TO THE EXCLUSIVE RIGHT TO USE "USA", APART FROM THE MARK AS SHOWN.

THE COLOR(S) GRAY, BLACK, WHITE, RED, AND BLUE IS/ARE CLAIMED AS A FEATURE OF THE MARK.

THE MARK CONSISTS OF A STYLIZED BUST OF A PILOT INSIDE A CIRCULAR BORDER THAT APPEARS IN BLACK, WHITE, AND GRAY. THE CIRCULAR BORDER IS BLACK AND WHITE WITH WINGS EXTENDING OUT FROM THE SIDES. THE AIRPLANES ARE WHITE ON A BLACK BORDER AND THE WORDING "FLY BOY USA" IS IN RED ON THE TOP OF THE CIRCLE. THERE ARE TWO BLUE STARS INSIDE THE OUTER PORTION OF THE CIRCLE.

FOR NOVELTY ITEMS, NAMELY, FAKE TEETH (U.S. CLS. 22, 23, 38 AND 50).

REBECCA SMITH, EXAMINING ATTORNEY

SN 77-169,913. CARLINO, CRISTINA M., PARADISE VALLEY, AZ. FILED 5-1-2007.

FIELD OF DREAMS

THE MARK CONSISTS OF STANDARD CHARACTERS WITHOUT CLAIM TO ANY PARTICULAR FONT, STYLE, SIZE, OR COLOR.

FOR ACTION FIGURES AND ACCESSORIES THEREFOR; BATHTUB TOYS; BATTERY OPERATED ACTION TOYS; BENDABLE TOYS; BOARD GAMES; BUBBLE MAKING WAND AND SOLUTION SETS; CARD GAMES; CHILDREN'S MULTIPLE ACTIVITY TOYS; CHRISTMAS TREE DECORATIONS; CRIB TOYS; DOLLS AND ACCESSORIES THEREFOR; ELECTRONIC LEARNING TOYS; MECHANICAL TOYS; PET TOYS; PUZZLES; STUFFED TOYS; TOY ANIMALS AND ACCESSORIES THEREFOR; TOY BAKEWARE AND COOKWARE; TOY BUILDING BLOCKS (U.S. CLS. 22, 23, 38 AND 50).

JULIE GUTTADAURO, EXAMINING ATTORNEY

CLASS 28—(Continued).

SN 77-184,311. ROBBINS, STEVEN L., FLINT, TX. FILED 5-18-2007.

Bitch Creek

THE MARK CONSISTS OF STANDARD CHARACTERS WITHOUT CLAIM TO ANY PARTICULAR FONT, STYLE, SIZE, OR COLOR.

FOR FISHING TACKLE (U.S. CLS. 22, 23, 38 AND 50).
BRIAN NEVILLE, EXAMINING ATTORNEY

SN 77-188,202. RAPID DISPLAYS, INC., CHICAGO, IL. FILED 5-23-2007.

CREATA-CLINGS

THE MARK CONSISTS OF STANDARD CHARACTERS WITHOUT CLAIM TO ANY PARTICULAR FONT, STYLE, SIZE, OR COLOR.

FOR HOBBY CRAFT KITS COMPRISED OF TOY MOLDS AND MOLDING COMPOUNDS FOR MAKING TOY FIGURES (U.S. CLS. 22, 23, 38 AND 50).

RUSS HERMAN, EXAMINING ATTORNEY

SN 77-190,724. DREAMGEAR, LLC, TORRANCE, CA. FILED 5-25-2007.

SHREDMASTER

THE MARK CONSISTS OF STANDARD CHARACTERS WITHOUT CLAIM TO ANY PARTICULAR FONT, STYLE, SIZE, OR COLOR.

FOR TOY GUITAR FOR USE WITH VIDEO GAMES (U.S. CLS. 22, 23, 38 AND 50).

SANJEEV VOHRA, EXAMINING ATTORNEY

CLASS 28—(Continued).

SN 77-193,271. CP FISHING, PORTLAND, OR. FILED 5-30-2007.

BIOFLY

THE MARK CONSISTS OF STANDARD CHARACTERS WITHOUT CLAIM TO ANY PARTICULAR FONT, STYLE, SIZE, OR COLOR.

FOR FISHING LINES (U.S. CLS. 22, 23, 38 AND 50).
MATTHEW EINSTEIN, EXAMINING ATTORNEY

SN 77-193,290. CP FISHING, PORTLAND, OR. FILED 5-30-2007.

BIOLEADER

THE MARK CONSISTS OF STANDARD CHARACTERS WITHOUT CLAIM TO ANY PARTICULAR FONT, STYLE, SIZE, OR COLOR.

FOR FISHING LINES (U.S. CLS. 22, 23, 38 AND 50).
MATTHEW EINSTEIN, EXAMINING ATTORNEY

SN 77-194,343. BUZZ BEE TOYS, INC., MT. LAUREL, NJ. FILED 5-31-2007.

HYDRO-BLAST

THE MARK CONSISTS OF STANDARD CHARACTERS WITHOUT CLAIM TO ANY PARTICULAR FONT, STYLE, SIZE, OR COLOR.

FOR WATER PISTOLS; WATER SQUIRTING TOYS (U.S. CLS. 22, 23, 38 AND 50).
INGA ERVIN, EXAMINING ATTORNEY

SN 77-194,346. BUZZ BEE TOYS, INC., MT. LAUREL, NJ. FILED 5-31-2007.

HYDRO-PULSE

THE MARK CONSISTS OF STANDARD CHARACTERS WITHOUT CLAIM TO ANY PARTICULAR FONT, STYLE, SIZE, OR COLOR.

FOR WATER PISTOLS; WATER SQUIRTING TOYS (U.S. CLS. 22, 23, 38 AND 50).
INGA ERVIN, EXAMINING ATTORNEY

CLASS 28—(Continued).

SN 77-198,854. TECHNO SOURCE, KOWLOON, HONG KONG, FILED 6-6-2007.

STRIKE IT BIG

THE MARK CONSISTS OF STANDARD CHARACTERS WITHOUT CLAIM TO ANY PARTICULAR FONT, STYLE, SIZE, OR COLOR.

FOR HAND HELD UNIT FOR PLAYING ELECTRONIC GAMES (U.S. CLS. 22, 23, 38 AND 50).
LINDA M. KING, EXAMINING ATTORNEY

SN 77-223,682. RENOSKY, JOSEPH F., INDIANA, PA. FILED 7-6-2007.

Chatter True Truck

THE MARK CONSISTS OF STANDARD CHARACTERS WITHOUT CLAIM TO ANY PARTICULAR FONT, STYLE, SIZE, OR COLOR.

NO CLAIM IS MADE TO THE EXCLUSIVE RIGHT TO USE "CHATTER", APART FROM THE MARK AS SHOWN.
FOR ARTIFICIAL FISHING LURES (U.S. CLS. 22, 23, 38 AND 50).

FIRST USE 7-1-2007; IN COMMERCE 7-1-2007.
ANNE MADDEN, EXAMINING ATTORNEY

SN 78-192,170. UNITED STATES HANDBALL ASSOCIATION, TUCSON, AZ. FILED 12-6-2002.

RED LABEL

FOR HANDBALLS (U.S. CLS. 22, 23, 38 AND 50).
FIRST USE 0-0-2000; IN COMMERCE 0-0-2000.
KAREN K. BUSH, EXAMINING ATTORNEY

SN 78-711,647. WATKINS GLEN INTERNATIONAL, INC., DAYTONA BEACH, FL. FILED 9-13-2005.



OWNER OF U.S. REG. NOS. 1,366,768, 1,862,034 AND OTHERS.

FOR TOYS AND PLAYTHINGS; NAMELY DIE CAST AND PLASTIC MINIATURE CARS AND STUFFED TOY ANIMALS (U.S. CLS. 22, 23, 38 AND 50).

MARY BOAGNI, EXAMINING ATTORNEY

CLASS 28—(Continued).

SN 78-832,135. FULL HOUSE BRANDS LLC, MASON, OH.
FILED 3-8-2006.

Full House

THE MARK CONSISTS OF STANDARD CHARACTERS WITHOUT CLAIM TO ANY PARTICULAR FONT, STYLE, SIZE, OR COLOR.

FOR PLAYING CARDS, POKER CHIPS; AND RELATED POKER AND GAMING SUPPLIES, NAMELY, EQUIPMENT SOLD AS A UNIT FOR PLAYING CARD GAMES. (U.S. CLS. 22, 23, 38 AND 50).

CHRISTOPHER OTT, EXAMINING ATTORNEY

CLASS 28—(Continued).

SN 78-912,642. TANGLE, INC., SOUTH SAN FRANCISCO, CA. FILED 6-20-2006.

BRAIN TOOL

THE MARK CONSISTS OF STANDARD CHARACTERS WITHOUT CLAIM TO ANY PARTICULAR FONT, STYLE, SIZE, OR COLOR.

NO CLAIM IS MADE TO THE EXCLUSIVE RIGHT TO USE "BRAIN", APART FROM THE MARK AS SHOWN.

FOR MOVABLE SCULPTURE TOYS, NAMELY, SCULPTURE MADE OF MOVABLE LINKS (U.S. CLS. 22, 23, 38 AND 50).

KENNETH E. SHARPERSON, EXAMINING ATTORNEY

SN 78-857,767. INFINICS INC., GYEONGI-DO, REPUBLIC OF KOREA, FILED 4-10-2006.



PRIORITY CLAIMED UNDER SEC. 44(D) ON REPUBLIC OF KOREA APPLICATION NO. 0046910/2005, FILED 10-10-2005, REG. NO. 40-0680569, DATED 10-2-2006, EXPIRES 10-2-2016.

FOR GOLF BAGS; GOLF BALLS; GOLF CLUBS; GOLF GLOVES; GOLF BALL MARKERS; GOLF PUTTING TRAINING AIDS IN THE NATURE OF AN ELECTRONIC DEVICE, NAMELY A DIGITAL INSTRUCTION PUTTER WHICH TRACKS IMPACT LOCATION AND MONITORS THE MOTION OF THE PUTTER (U.S. CLS. 22, 23, 38 AND 50).

WENDY GOODMAN, EXAMINING ATTORNEY

SN 78-924,962. TIGERCANDY ARTS, INC., RIVERDALE, NY. FILED 7-7-2006.

SN 78-891,568. LEVITATION ARTS, INC., LOUISVILLE, KY. FILED 5-24-2006.

Levitation Arts

THE MARK CONSISTS OF STANDARD CHARACTERS WITHOUT CLAIM TO ANY PARTICULAR FONT, STYLE, SIZE, OR COLOR.

NO CLAIM IS MADE TO THE EXCLUSIVE RIGHT TO USE "LEVITATION", APART FROM THE MARK AS SHOWN.

FOR ENTERTAINMENT TOYS AND GAMES, NAMELY, COLLECTABLE TOY FIGURES, FANTASY CHARACTER TOYS, PLASTIC CHARACTER TOYS, TOY ACTION FIGURES AND ACTION SKILL GAMES, UTILIZING ELECTROMAGNETIC LEVITATION (U.S. CLS. 22, 23, 38 AND 50).

COLLEEN DOMBROW, EXAMINING ATTORNEY

Sockett

THE MARK CONSISTS OF STANDARD CHARACTERS WITHOUT CLAIM TO ANY PARTICULAR FONT, STYLE, SIZE, OR COLOR.

FOR HAND PUPPETS; MARIONETTE PUPPETS; PUPPETS; STUFFED PUPPETS (U.S. CLS. 22, 23, 38 AND 50). FIRST USE 6-28-2005; IN COMMERCE 6-28-2005.

TANYA AMOS, EXAMINING ATTORNEY

CLASS 28—(Continued).

SN 78-946,802. SANRIO COMPANY, LTD., TOKYO, JAPAN,
FILED 8-7-2006.

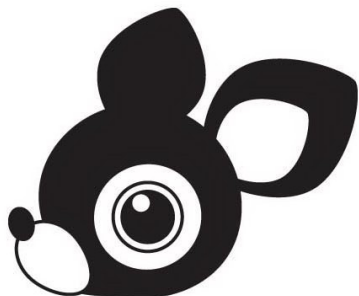

THE MARK CONSISTS OF A STYLIZED PROFILE FACE OF A DEER.

FOR STUFFED TOY ANIMALS, PLUSH TOY ANIMALS, SOFT SCULPTURE TOYS, PUPPETS, TOY FIGURES, TOY VEHICLES, TOY WHISTLES, TOY JEWELRY, CASES FOR TOY ACCESSORIES, CHILDREN'S PLAY COSMETICS, PUZZLES, BALLOONS, HAND HELD ELECTRONIC COMPUTER GAMES, SPORTS BALLS, YO-YOS, JUMP ROPES, SKATEBOARDS, SNOWBOARDS, CHRISTMAS TREE ORNAMENTS; TOY MASKS; PARTY FAVORS IN THE NATURE OF CRACKERS, NOISE MAKERS AND SMALL TOYS; FLIPPERS, POOL RINGS, INFLATABLE TUBES AND ARM FLOATS FOR RECREATIONAL USE; BEACH BALLS; BOARD GAMES; ELBOW AND KNEE GUARDS FOR ATHLETIC USE; KITES; ROLLER SKATES; SNOW GLOBES; PLAYING CARDS, COLLECTIBLE TOY FIGURES, DOLL HOUSE FURNISHINGS, DOLL HOUSES, DOLLS, ELECTRIC ACTION TOYS, MUSICAL TOYS, PAPER DOLLS, PLUSH TOYS, SKETCHING TOYS, TOY BAKEWARE AND COOKWARE, TOY CASH REGISTERS, TOY FOOD, WATER GLOBES, INFLATABLE POOL TOYS, BOWLING BAGS, BOWLING BALLS, BUBBLE MAKING WAND AND SOLUTION SETS, CHECKER SETS, CHESS SETS, CHRISTMAS STOCKINGS, DOMINOES, INFLATABLE POOLS FOR RECREATIONAL USE, INFLATABLE RIDE-ON TOYS, JUMP ROPES INCORPORATING BUBBLE MAKING WANDS, RIDE-ON TOYS, SAND TOYS, BABY MULTIPLE ACTIVITY TOYS, BATH TOYS, CHILDREN'S MULTIPLE ACTIVITY TOYS, CRIB MOBILES, GAME MOBILES, GIFT BASKETS COMPRISED PRIMARILY OF TOYS, AND ALSO COMPRISING STATIONERY ITEMS AND CANDY SOLD AS A UNIT, PET TOYS, PLAY MATS FOR USE WITH TOYS, PLAYGROUND EQUIPMENT, NAMELY, SLIDES, INFLATABLE SLIDES, AND PLAYHOUSES, BABY RATTLES, TOY BUCKETS, TOYS DESIGNED TO BE ATTACHED TO CAR SEATS, STROLLERS, CRIBS, AND HIGH CHAIRS, WATER SQUIRTING TOYS, CLOTHING AND ACCESSORIES FOR DOLLS AND TOY ANIMALS; TOY BAKING OVENS AND RELATED ACCESSORIES SOLD AS A UNIT (U.S. CLS. 22, 23, 38 AND 50).

DOMINIC J. FERRAIUOLO, EXAMINING ATTORNEY

CLASS 28—(Continued).

SN 78-960,490. MARTIN RUSSOCKI, NEW YORK, NY.
FILED 8-25-2006.

SENSEABILITY

THE MARK CONSISTS OF STANDARD CHARACTERS WITHOUT CLAIM TO ANY PARTICULAR FONT, STYLE, SIZE, OR COLOR.

FOR GAMES, NAMELY, DICE GAMES, CARD GAMES, ELECTRONIC DART GAMES; BOARD GAMES, BACKGAMMON GAME SETS AND PIECES SOLD AS A UNIT, EQUIPMENT SOLD AS A UNIT FOR PLAYING BOARD GAMES, CARDS FOR USE IN CONNECTION WITH BOARD GAMES; TOYS, NAMELY, BATH TOYS, CRIB TOYS, DRAWING TOYS; TOY FIGURES, PUZZLE GAMES; BOARD GAMES SOLD TOGETHER AS A UNIT WITH INSTRUCTIONAL BOOKLETS THEREFOR; PUZZLE GAMES SOLD TOGETHER AS A UNIT WITH INSTRUCTIONAL BOOKLETS THEREFOR; BOARD GAMES SOLD TOGETHER AS A UNIT WITH INSTRUCTIONAL DVD'S AND CD ROMS THEREFOR (U.S. CLS. 22, 23, 38 AND 50).

MARY BOAGNI, EXAMINING ATTORNEY

SN 78-962,058. LEISURE ARTS, INC., LITTLE ROCK, AR.
FILED 8-28-2006.

CREATE AND UNWIND

THE MARK CONSISTS OF STANDARD CHARACTERS WITHOUT CLAIM TO ANY PARTICULAR FONT, STYLE, SIZE, OR COLOR.

FOR HOBBY CRAFT KIT COMPRISING KNITTING AND CROCHETING MATERIALS, NAMELY YARN, NEEDLES OR HOOK, PRINTED PATTERNS AND ACCESSORIES, NAMELY PURSE HANDLES, FABRIC LINING, MAGNETIC CLASPS, BUTTONS AND PREMADE TASSELS (U.S. CLS. 22, 23, 38 AND 50).

ELLEN PERKINS, EXAMINING ATTORNEY

CLASS 28—(Continued).

SN 78-966,740. OZISURF-SAFE INTERNATIONAL PTY LTD, CRONULLA NSW, AUSTRALIA, FILED 9-4-2006.

OCEAN VAULT

THE MARK CONSISTS OF STANDARD CHARACTERS WITHOUT CLAIM TO ANY PARTICULAR FONT, STYLE, SIZE, OR COLOR.

NO CLAIM IS MADE TO THE EXCLUSIVE RIGHT TO USE "OCEAN", APART FROM THE MARK AS SHOWN.

FOR BODY BOARDS, SWIM FINS AND ACCESSORIES FOR BODY BOARDS, NAMELY RESTRAINT STRAPS IN THE NATURE OF WRIST ROPES AND BODY BOARD COVERS, WRIST AND LEG ROPES, SECURING LUGS FOR RESTRAINT STRAPS, WATERPROOF VALUABLES PODS FOR BODY BOARDS AND DECK GRIPS (U.S. CLS. 22, 23, 38 AND 50).

MARK PILARO, EXAMINING ATTORNEY

SN 78-967,991. MATTEL, INC., EL SEGUNDO, CA. FILED 9-6-2006.

POWER SQUADRON

THE MARK CONSISTS OF STANDARD CHARACTERS WITHOUT CLAIM TO ANY PARTICULAR FONT, STYLE, SIZE, OR COLOR.

FOR TOYS, GAMES AND PLAYTHINGS, NAMELY, TOY VEHICLES, TOY AIRPLANES, AND ACCESSORIES FOR ALL OF THE FOREGOING (U.S. CLS. 22, 23, 38 AND 50).

SUNG IN, EXAMINING ATTORNEY

SN 78-968,005. MATTEL, INC., EL SEGUNDO, CA. FILED 9-6-2006.

CYBER SQUID

THE MARK CONSISTS OF STANDARD CHARACTERS WITHOUT CLAIM TO ANY PARTICULAR FONT, STYLE, SIZE, OR COLOR.

OWNER OF U.S. REG. NO. 2,849,248.

FOR TOYS, GAMES AND PLAYTHINGS, NAMELY, TOY ACTION FIGURES, TOY FIGURES, AND ACCESSORIES FOR ALL OF THE FOREGOING (U.S. CLS. 22, 23, 38 AND 50).

FIRST USE 2-6-2007; IN COMMERCE 2-6-2007.

SUNG IN, EXAMINING ATTORNEY

CLASS 28—(Continued).

SN 78-968,017. MATTEL, INC., EL SEGUNDO, CA. FILED 9-6-2006.

TRACK LEGENDS

THE MARK CONSISTS OF STANDARD CHARACTERS WITHOUT CLAIM TO ANY PARTICULAR FONT, STYLE, SIZE, OR COLOR.

OWNER OF U.S. REG. NOS. 2,437,585 AND 2,978,347.

FOR TOYS, GAMES AND PLAYTHINGS, NAMELY, TOY VEHICLES AND ACCESSORIES THEREFOR (U.S. CLS. 22, 23, 38 AND 50).

SUNG IN, EXAMINING ATTORNEY

SN 78-968,018. MATTEL, INC., EL SEGUNDO, CA. FILED 9-6-2006.

FIRE FLIGHTER

THE MARK CONSISTS OF STANDARD CHARACTERS WITHOUT CLAIM TO ANY PARTICULAR FONT, STYLE, SIZE, OR COLOR.

FOR TOYS, GAMES AND PLAYTHINGS, NAMELY, TOY VEHICLES AND ACCESSORIES THEREFOR (U.S. CLS. 22, 23, 38 AND 50).

FIRST USE 2-27-2007; IN COMMERCE 2-27-2007.

SUNG IN, EXAMINING ATTORNEY

SN 78-970,380. SPIN MASTER LTD., TORONTO, ONTARIO, CANADA, FILED 9-8-2006.

MOON DOUGH

THE MARK CONSISTS OF STANDARD CHARACTERS WITHOUT CLAIM TO ANY PARTICULAR FONT, STYLE, SIZE, OR COLOR.

PRIORITY CLAIMED UNDER SEC. 44(D) ON CANADA APPLICATION NO. 1,310,490, FILED 7-25-2006.

NO CLAIM IS MADE TO THE EXCLUSIVE RIGHT TO USE "DOUGH", APART FROM THE MARK AS SHOWN.

FOR TOYS AND PLAYTHINGS, NAMELY, MOLDING AND SCULPTING MATERIALS AND PRODUCTS, NAMELY, GRANULAR MOLDABLE SUBSTANCE THAT CAN BE MOLDED, SCULPTED AND FORMED INTO ANY SHAPE; AND VARIOUS SHAPED FORMS TO WHICH THE GRANULAR SUBSTANCE CAN BE APPLIED (U.S. CLS. 22, 23, 38 AND 50).

LINDA POWELL, EXAMINING ATTORNEY

CLASS 28—(Continued).

SN 78-971,456. COLLEGE HILL GAMES, INC., EAST ISLIP, NY. FILED 9-11-2006.

BLITZ BALL

THE MARK CONSISTS OF STANDARD CHARACTERS WITHOUT CLAIM TO ANY PARTICULAR FONT, STYLE, SIZE, OR COLOR.

NO CLAIM IS MADE TO THE EXCLUSIVE RIGHT TO USE "BALL", APART FROM THE MARK AS SHOWN.

FOR PLASTIC BASEBALLS (U.S. CLS. 22, 23, 38 AND 50).

JILL C. ALT, EXAMINING ATTORNEY

CLASS 28—(Continued).

SN 78-974,341. MATTEL, INC., EL SEGUNDO, CA. FILED 9-14-2006.

STOKELY

THE MARK CONSISTS OF STANDARD CHARACTERS WITHOUT CLAIM TO ANY PARTICULAR FONT, STYLE, SIZE, OR COLOR.

FOR TOYS, GAMES AND PLAYTHINGS, NAMELY, TOY FIGURES AND ACCESSORIES THEREFOR (U.S. CLS. 22, 23, 38 AND 50).

FIRST USE 7-25-2007; IN COMMERCE 7-25-2007.

FRED MANDIR, EXAMINING ATTORNEY

SN 78-974,306. MATTEL, INC., EL SEGUNDO, CA. FILED 9-14-2006.

CRASHERS

THE MARK CONSISTS OF STANDARD CHARACTERS WITHOUT CLAIM TO ANY PARTICULAR FONT, STYLE, SIZE, OR COLOR.

FOR TOYS, GAMES AND PLAYTHINGS, NAMELY, TOY VEHICLES, TOY VEHICLE PLAYSETS, TOY VEHICLE TRACK SETS, AND ACCESSORIES FOR ALL OF THE FOREGOING (U.S. CLS. 22, 23, 38 AND 50).

KATHY DE JONGE, EXAMINING ATTORNEY

SN 78-974,345. MATTEL, INC., EL SEGUNDO, CA. FILED 9-14-2006.

EQUADOR

THE MARK CONSISTS OF STANDARD CHARACTERS WITHOUT CLAIM TO ANY PARTICULAR FONT, STYLE, SIZE, OR COLOR.

FOR TOYS, GAMES AND PLAYTHINGS, NAMELY, TOY VEHICLES AND ACCESSORIES THEREFOR (U.S. CLS. 22, 23, 38 AND 50).

FRED MANDIR, EXAMINING ATTORNEY

SN 78-974,334. MATTEL, INC., EL SEGUNDO, CA. FILED 9-14-2006.

SHOXX

THE MARK CONSISTS OF STANDARD CHARACTERS WITHOUT CLAIM TO ANY PARTICULAR FONT, STYLE, SIZE, OR COLOR.

FOR TOYS, GAMES AND PLAYTHINGS, NAMELY, TOY VEHICLES AND ACCESSORIES THEREFOR (U.S. CLS. 22, 23, 38 AND 50).

FRED MANDIR, EXAMINING ATTORNEY

SN 78-974,348. MATTEL, INC., EL SEGUNDO, CA. FILED 9-14-2006.

SWITCHBACK

THE MARK CONSISTS OF STANDARD CHARACTERS WITHOUT CLAIM TO ANY PARTICULAR FONT, STYLE, SIZE, OR COLOR.

FOR TOYS, GAMES AND PLAYTHINGS, NAMELY, TOY VEHICLES AND ACCESSORIES THEREFOR (U.S. CLS. 22, 23, 38 AND 50).

FRED MANDIR, EXAMINING ATTORNEY

CLASS 28—(Continued).

SN 78-974,352. MATTEL, INC., EL SEGUNDO, CA. FILED 9-14-2006.

CLOVER CARS

THE MARK CONSISTS OF STANDARD CHARACTERS WITHOUT CLAIM TO ANY PARTICULAR FONT, STYLE, SIZE, OR COLOR.

NO CLAIM IS MADE TO THE EXCLUSIVE RIGHT TO USE "CARS", APART FROM THE MARK AS SHOWN.

FOR TOYS, GAMES AND PLAYTHINGS, NAMELY, TOY VEHICLES AND ACCESSORIES THEREFOR (U.S. CLS. 22, 23, 38 AND 50).

KATHY DE JONGE, EXAMINING ATTORNEY

CLASS 29—(Continued).

SN 76-675,791. CLOVER-STORNETTA FARMS, INC., PETA-LUMA, CA. FILED 4-20-2007.

FRIARWORKS

THE MARK CONSISTS OF STANDARD CHARACTERS WITHOUT CLAIM TO ANY PARTICULAR FONT, STYLE, SIZE, OR COLOR.

FOR DAIRY PRODUCTS, EXCLUDING ICE CREAM, ICE MILK AND FROZEN YOGURT (U.S. CL. 46).

TONI HICKEY, EXAMINING ATTORNEY

SN 77-014,600. DANA ALEXANDER, INC., MELVILLE, NY. FILED 10-5-2006.

CLASS 29—MEATS AND PROCESSED FOODS

SN 76-617,286. WAKEFERN FOOD CORP., ELIZABETH, NJ. FILED 10-22-2004.

LIVE RIGHT WITH SHOP RITE

OWNER OF U.S. REG. NOS. 1,867,239, 2,467,334 AND OTHERS.

FOR MEATS, FISH, POULTRY, PREPARED, PACKAGED AND FROZEN MEALS CONSISTING PRIMARILY OF MEAT, POULTRY, FISH OR VEGETABLES; EGGS, DAIRY PRODUCTS, (EXCLUDING ICE CREAM, ICE MILK AND FROZEN YOGURT), EDIBLE OILS AND FATS, NONDAIRY CREAMERS, NONDAIRY WHIPPED TOPPING, PEANUT BUTTER, FRUIT PRESERVES, JAMS, JELLIES, PICKLES, APPLESAUCE, CRANBERRY SAUCE, CANNED SOUP, CANNED MILK, POTATO CHIPS; POTATO-BASED, NUT-BASED, FRUIT-BASED AND SOY-BASED SNACK FOODS, FRUIT FILLINGS FOR PIES AND CAKES, VEGETABLE FILLINGS FOR PIES AND CAKES (U.S. CL. 46).

JENNIFER DIXON, EXAMINING ATTORNEY

TERRA CHEFS

THE MARK CONSISTS OF STANDARD CHARACTERS WITHOUT CLAIM TO ANY PARTICULAR FONT, STYLE, SIZE, OR COLOR.

FOR TAPAS, NAMELY, TAPENADES (U.S. CL. 46).

FIRST USE 5-0-2005; IN COMMERCE 5-0-2005.

WILLIAM P. SHANAHAN, EXAMINING ATTORNEY

SN 77-021,310. KELLOGG NORTH AMERICA COMPANY, BATTLE CREEK, MI. FILED 10-14-2006.

SN 76-665,427. CAPITOL WHOLESALE MEATS, INC., CHICAGO, IL. FILED 8-30-2006.

WITH FONTANINI, EVERYBODY LOVES ITALIAN!

THE MARK CONSISTS OF STANDARD CHARACTERS WITHOUT CLAIM TO ANY PARTICULAR FONT, STYLE, SIZE, OR COLOR.

OWNER OF U.S. REG. NO. 1,440,340.

FOR SAUSAGES, MEAT BALLS AND BEEF PIZZA TOPPING (U.S. CL. 46).

FIRST USE 0-0-1999; IN COMMERCE 0-0-1999.

CHARISMA HAMPTON, EXAMINING ATTORNEY

THE MARK CONSISTS OF A STYLIZED FORM OF THE LETTER "V" DEPICTED AS A PLANT STALK WITH LEAVES.

FOR VEGGIE FOOD PRODUCTS, NAMELY, VEGETABLE BASED MEAT SUBSTITUTES, FISH SUBSTITUTES, EGG SUBSTITUTES AND CHEESE SUBSTITUTES; TEXTURED VEGETABLE PROTEIN; FROZEN PACKAGED ENTREES CONSISTING OF VEGETABLE BASED PATIES (U.S. CL. 46).

FIRST USE 1-1-2006; IN COMMERCE 1-1-2006.

BARBARA GAYNOR, EXAMINING ATTORNEY



CLASS 29—(Continued).

SN 77-036,421. SWISS AMERICAN IMPORTING CO., ST. LOUIS, MO. FILED 11-3-2006.

EPICO

THE MARK CONSISTS OF STANDARD CHARACTERS WITHOUT CLAIM TO ANY PARTICULAR FONT, STYLE, SIZE, OR COLOR.

OWNER OF U.S. REG. NO. 2,358,175.
"THE FOREIGN WORDING IN THE MARK TRANSLATES INTO ENGLISH AS EPIC."
FOR CHEESE (U.S. CL. 46).
DARRYL SPRUILL, EXAMINING ATTORNEY

SN 77-037,612. GENERAL MILLS MARKETING, INC., MINNEAPOLIS, MN. FILED 11-6-2006.

GIANT BITES

THE MARK CONSISTS OF STANDARD CHARACTERS WITHOUT CLAIM TO ANY PARTICULAR FONT, STYLE, SIZE, OR COLOR.

NO CLAIM IS MADE TO THE EXCLUSIVE RIGHT TO USE "BITES", APART FROM THE MARK AS SHOWN.
FOR VEGETABLE-BASED SNACK FOOD, NAMELY, NUGGETS MADE PRIMARILY OF PROCESSED VEGETABLES (U.S. CL. 46).
HANNO RITTNER, EXAMINING ATTORNEY

SN 77-058,371. JACK'S AMERICAN BISTRO AND WINE BAR, LLC, OLD SAYBROOK, CT. FILED 12-6-2006.

Jack's Original Lobster Dog

THE MARK CONSISTS OF STANDARD CHARACTERS WITHOUT CLAIM TO ANY PARTICULAR FONT, STYLE, SIZE, OR COLOR.

NO CLAIM IS MADE TO THE EXCLUSIVE RIGHT TO USE "ORIGINAL LOBSTER DOG", APART FROM THE MARK AS SHOWN.
FOR FOOD PRODUCTS, NAMELY, PREPARED LOBSTER IN AN EDIBLE CASING FOR CONSUMPTION ON OR OFF PREMISES (U.S. CL. 46).
PRISCILLA MILTON, EXAMINING ATTORNEY

CLASS 29—(Continued).

SN 77-058,393. JACK'S AMERICAN BISTRO AND WINE BAR, LLC, OLD SAYBROOK, CT. FILED 12-6-2006.

Jack's Original Lobster Hot Dog

THE MARK CONSISTS OF STANDARD CHARACTERS WITHOUT CLAIM TO ANY PARTICULAR FONT, STYLE, SIZE, OR COLOR.

NO CLAIM IS MADE TO THE EXCLUSIVE RIGHT TO USE "ORIGINAL LOBSTER HOT DOG", APART FROM THE MARK AS SHOWN.

FOR FOOD PRODUCTS, NAMELY, PREPARED LOBSTER IN AN EDIBLE CASING FOR CONSUMPTION ON OR OFF PREMISES (U.S. CL. 46).
PRISCILLA MILTON, EXAMINING ATTORNEY

SN 77-086,395. HEALTH VALLEY COMPANY, MELVILLE, NY. FILED 1-19-2007.

HEALTH VALLEY ORGANIC

THE MARK CONSISTS OF STANDARD CHARACTERS WITHOUT CLAIM TO ANY PARTICULAR FONT, STYLE, SIZE, OR COLOR.

OWNER OF U.S. REG. NOS. 1,075,142, 1,285,419 AND 2,459,063.

NO CLAIM IS MADE TO THE EXCLUSIVE RIGHT TO USE "HEALTH" AND "ORGANIC", APART FROM THE MARK AS SHOWN.

FOR CHILI, BAKED BEANS, SOUPS, DRY SOUP CUPS, POTATO CHIPS, PUFFED POTATO SNACKS, MEATS, POULTRY, SOY-BASED FOOD BEVERAGES USED AS A MILK ALTERNATIVE, ALL BEING ORGANIC PRODUCTS (U.S. CL. 46).

MARY BOAGNI, EXAMINING ATTORNEY

CLASS 29—(Continued).

SN 77-086,411. HEALTH VALLEY COMPANY, MELVILLE, NY. FILED 1-19-2007.



OWNER OF U.S. REG. NOS. 1,075,142, 2,459,063 AND OTHERS.

NO CLAIM IS MADE TO THE EXCLUSIVE RIGHT TO USE "HEALTH" AND "ORGANIC", APART FROM THE MARK AS SHOWN.

FOR CHILI, BAKED BEANS, SOUPS, DRY SOUP CUPS, POTATO CHIPS, PUFFED POTATO SNACKS, MEATS, POULTRY, SOY-BASED FOOD BEVERAGES USED AS A MILK ALTERNATIVE, ALL BEING ORGANIC PRODUCTS (U.S. CL. 46).

MARY BOAGNI, EXAMINING ATTORNEY

CLASS 29—(Continued).

SN 77-106,079. NATURAMA FOODS, INC., THOUSAND OAKS, CA. FILED 2-13-2007.

NATURAMA

THE MARK CONSISTS OF STANDARD CHARACTERS WITHOUT CLAIM TO ANY PARTICULAR FONT, STYLE, SIZE, OR COLOR.

FOR PACKAGED, CANNED OR DRIED FOOD, NAMELY RAW OR PROCESSED FISH, BEEF, AND PROCESSED VEGETABLES (U.S. CL. 46).

FIRST USE 10-1-2006; IN COMMERCE 10-1-2006.
GEORGE LORENZO, EXAMINING ATTORNEY

SN 77-127,941. HITE USA, INC., RANCHO DOMINGUEZ, CA. FILED 3-12-2007.

AVOLEO

THE MARK CONSISTS OF STANDARD CHARACTERS WITHOUT CLAIM TO ANY PARTICULAR FONT, STYLE, SIZE, OR COLOR.

FOR FOOD OILS MADE FROM AVOCADOS (U.S. CL. 46).

AMY MCMENAMIN, EXAMINING ATTORNEY

SN 77-090,496. OSEM INVESTMENTS LIMITED, PETACH TIKVA, ISRAEL, FILED 1-24-2007.



NO CLAIM IS MADE TO THE EXCLUSIVE RIGHT TO USE "BEIT HASHITA", APART FROM THE MARK AS SHOWN.

THE MARK CONSISTS OF THE WORDS "BEIT HASHITA" SUPERIMPOSED ON THE IMAGE OF AN OLIVE WITH LEAVES BELOW THE WORD.

THE FOREIGN WORDING IN THE MARK TRANSLATES INTO ENGLISH AS HOUSE OF THE ACACIA TREE.

FOR DRIED VEGETABLES; PICKLES; PRESERVED VEGETABLES IN OIL; PRESERVED, DRIED, COOKED AND GRILLED VEGETABLES; PROCESSED OLIVES; PROCESSED VEGETABLES; VEGETABLES, NAMELY, DRIED AND COOKED (U.S. CL. 46).

FIRST USE 6-1-1982; IN COMMERCE 6-1-1982.
SCOTT BIBB, EXAMINING ATTORNEY

SN 77-130,527. CHERRYDALE MANUFACTURING, L.L.C., ALLENTOWN, PA. FILED 3-14-2007.

BARTONS GOLD

THE MARK CONSISTS OF STANDARD CHARACTERS WITHOUT CLAIM TO ANY PARTICULAR FONT, STYLE, SIZE, OR COLOR.

OWNER OF U.S. REG. NOS. 669,032, 2,971,944 AND OTHERS.

FOR PROTEIN BASED, NUTRIENT-DENSE SNACK BARS; SOY BASED FOOD BARS (U.S. CL. 46).

KEVON CHISOLM, EXAMINING ATTORNEY

CLASS 29—(Continued).

SN 77-135,015. PEPPINO FOODS, INC., ST. PETERSBURG, FL. FILED 3-20-2007.

CICCARELLO'S

THE MARK CONSISTS OF STANDARD CHARACTERS WITHOUT CLAIM TO ANY PARTICULAR FONT, STYLE, SIZE, OR COLOR.

SEC. 2(F).

FOR SAUSAGE AND GROUND PORK (U.S. CL. 46).

FIRST USE 0-0-1970; IN COMMERCE 0-0-1970.

JULIE GUTTADAURO, EXAMINING ATTORNEY

SN 77-135,034. BC-USA, INC., NEW HOLLAND, PA. FILED 3-20-2007.

ALOUETTE RESERVE

THE MARK CONSISTS OF STANDARD CHARACTERS WITHOUT CLAIM TO ANY PARTICULAR FONT, STYLE, SIZE, OR COLOR.

OWNER OF U.S. REG. NOS. 1,239,584, 1,961,049 AND OTHERS.

NO CLAIM IS MADE TO THE EXCLUSIVE RIGHT TO USE "RESERVE", APART FROM THE MARK AS SHOWN.

THE ENGLISH TRANSLATION OF THE WORD "ALOUETTE RESERVE" IN THE MARK IS "LARK".

FOR CHEESE AND CHEESE SPREADS (U.S. CL. 46).

FIRST USE 10-3-2006; IN COMMERCE 10-3-2006.

PAUL CROWLEY, EXAMINING ATTORNEY

SN 77-136,636. BINCO, LLC, CHICAGO, IL. FILED 3-21-2007.

CHI BAO

THE MARK CONSISTS OF STANDARD CHARACTERS WITHOUT CLAIM TO ANY PARTICULAR FONT, STYLE, SIZE, OR COLOR.

THE FOREIGN WORDING IN THE MARK TRANSLATES INTO ENGLISH AS EAT-FULL.

FOR NUTS, NAMELY PRE-PACKAGED PROCESSED PINE NUTS (U.S. CL. 46).

FIRST USE 4-0-2006; IN COMMERCE 4-0-2006.

AMY BROZENIC, EXAMINING ATTORNEY

CLASS 29—(Continued).

SN 77-145,007. BREADFRUIT TRADING COMPANY, PHILADELPHIA, PA. FILED 3-30-2007.

SAVA CHIPS

THE MARK CONSISTS OF STANDARD CHARACTERS WITHOUT CLAIM TO ANY PARTICULAR FONT, STYLE, SIZE, OR COLOR.

NO CLAIM IS MADE TO THE EXCLUSIVE RIGHT TO USE "CHIPS", APART FROM THE MARK AS SHOWN.

FOR VEGETABLE CHIPS (U.S. CL. 46).

LESLEY LAMOTHE, EXAMINING ATTORNEY

SN 77-147,932. SLEEPKO, INC., SAN PEDRO, CA. FILED 4-3-2007.

The Original Relaxation Snacks

THE MARK CONSISTS OF STANDARD CHARACTERS WITHOUT CLAIM TO ANY PARTICULAR FONT, STYLE, SIZE, OR COLOR.

OWNER OF U.S. REG. NO. 2,986,766.

NO CLAIM IS MADE TO THE EXCLUSIVE RIGHT TO USE "THE ORIGINAL" AND "SNACKS", APART FROM THE MARK AS SHOWN.

FOR FRUIT-BASED SNACK FOOD; POTATO-BASED SNACK FOODS; PROCESSED NUTS; POTATO CHIPS; FRUIT CHIPS; BANANA CHIPS (U.S. CL. 46).

MARCIE MILONE, EXAMINING ATTORNEY

SN 77-148,836. AGROINDUSTRIAL DON PABLO LICON, S.P.R. DE R.L., CHIHUAHUA, MEXICO, FILED 4-4-2007.

THE NAME(S), PORTRAIT(S), AND/OR SIGNATURE(S) SHOWN IN THE MARK DOES NOT IDENTIFY A PARTICULAR LIVING INDIVIDUAL.

THE COLOR(S) BLACK, WHITE AND GREEN-GOLD IS/ ARE CLAIMED AS A FEATURE OF THE MARK.

THE MARK CONSISTS OF THE WORDS DON PABLO IN GREEN-GOLD HIGHLIGHTED IN WHITE AROUND THE EDGES AND SHADED WITH BLACK AROUND THE EDGES OF THE WORDING.

FOR EDIBLE OILS, USED FOR COOKING AND NUTRITIONAL PURPOSES (U.S. CL. 46).

FIRST USE 3-1-2004; IN COMMERCE 8-31-2005.

DAWN FELDMAN, EXAMINING ATTORNEY

CLASS 29—(Continued).

SN 77-151,898. HESHE AND SHULEM MANAGEMENT INC.,
BROOKLYN, NY. FILED 4-9-2007.

BETACH

THE MARK CONSISTS OF STANDARD CHARACTERS WITHOUT CLAIM TO ANY PARTICULAR FONT, STYLE, SIZE, OR COLOR.

THE ENGLISH TRANSLATION OF BETACH IS SURELY, SAFELY OR SECURELY.

FOR PRODUCE, NAMELY, VEGETABLES FROZEN AND PROCESSED (U.S. CL. 46).

CHARLOTTE CORWIN, EXAMINING ATTORNEY

SN 77-152,158. JONMOR INVESTMENTS, INC., WILMINGTON, DE. FILED 4-9-2007.



NO CLAIM IS MADE TO THE EXCLUSIVE RIGHT TO USE "WHITE", APART FROM THE MARK AS SHOWN.

THE COLOR(S) BROWN, BEIGE AND GRAYISH-WHITE IS/ARE CLAIMED AS A FEATURE OF THE MARK.

THE MARK CONSISTS OF THE WORD MENDOCINO IN BROWN PRINT ABOVE THE WORD WHITE IN BEIGE PRINT. BESIDE THE WORD WHITE IS A GRAYISH-WHITE FEATHER PARTIALLY COVERING THE "E" IN WHITE.

FOR CHICKEN (U.S. CL. 46).

KEVIN CORWIN, EXAMINING ATTORNEY

SN 77-154,834. CHERRYDALE MANUFACTURING, L.L.C., ALLENTOWN, PA. FILED 4-12-2007.

SINCE 1898



OWNER OF U.S. REG. NOS. 669,032, 2,971,944 AND OTHERS.

NO CLAIM IS MADE TO THE EXCLUSIVE RIGHT TO USE "SINCE 1898", APART FROM THE MARK AS SHOWN.

THE MARK CONSISTS OF THE WORDS "SINCE 1898" APPEARING ABOVE AN OVAL CONTAINING THE WORDS "BARTONS GOLD".

FOR PROTEIN BASED, NUTRIENT-DENSE SNACK BARS; SOY BASED FOOD BARS (U.S. CL. 46).

KEVON CHISOLM, EXAMINING ATTORNEY

CLASS 29—(Continued).

SN 77-155,973. ROSE ACRE FARMS, INC., SEYMOUR, IN.
FILED 4-13-2007.



NO CLAIM IS MADE TO THE EXCLUSIVE RIGHT TO USE "EGGS", APART FROM THE MARK AS SHOWN.

THE MARK CONSISTS OF THE STYLIZED WORDS GREAT EGGS OVER A WHEAT STALK.

SEC. 2(F).

FOR EGGS (U.S. CL. 46).

FIRST USE 5-26-2000; IN COMMERCE 6-1-2000.

DAVID TAYLOR, EXAMINING ATTORNEY

SN 77-156,359. LOURENCO, LINNEA, TALLAHASSEE, FL.
FILED 4-13-2007.

UPcuisine

THE MARK CONSISTS OF STANDARD CHARACTERS WITHOUT CLAIM TO ANY PARTICULAR FONT, STYLE, SIZE, OR COLOR.

FOR PACKAGED UNCOOKED MEALS CONSISTING PRIMARILY OF MEAT, FISH, POULTRY AND/OR VEGETABLES (U.S. CL. 46).

JASON BLAIR, EXAMINING ATTORNEY

SN 77-157,426. SCHREIBER FOODS, INC., GREEN BAY, WI.
FILED 4-16-2007.

CHEDDAMELT

THE MARK CONSISTS OF STANDARD CHARACTERS WITHOUT CLAIM TO ANY PARTICULAR FONT, STYLE, SIZE, OR COLOR.

SEC. 2(F).

FOR CHEESE (U.S. CL. 46).

FIRST USE 9-20-1985; IN COMMERCE 9-20-1985.

ADA HAN, EXAMINING ATTORNEY

CLASS 29—(Continued).

SN 77-157,545. J. R. SIMPLOT COMPANY, BOISE, ID. FILED 4-16-2007.

SIMPLOT GUACAMOLE ESPECIAL

THE MARK CONSISTS OF STANDARD CHARACTERS WITHOUT CLAIM TO ANY PARTICULAR FONT, STYLE, SIZE, OR COLOR.

OWNER OF U.S. REG. NOS. 846,389, 1,805,454 AND OTHERS.

NO CLAIM IS MADE TO THE EXCLUSIVE RIGHT TO USE "GUACAMOLE ESPECIAL", APART FROM THE MARK AS SHOWN.

THE FOREIGN WORDING IN THE MARK TRANSLATES INTO ENGLISH AS SPECIAL.

FOR GUACAMOLE; PROCESSED AVOCADOS (U.S. CL. 46).

FIRST USE 1-0-2004; IN COMMERCE 1-0-2004.
CAROLINE WOOD, EXAMINING ATTORNEY

CLASS 29—(Continued).

SN 77-159,869. HODGSON MILL, INC., EFFINGHAM, IL. FILED 4-18-2007.



The logo for "Travel FLAX" features the word "Travel" in a stylized, italicized font with a horizontal line through it, and the word "FLAX" in a bold, serif font below it.

NO CLAIM IS MADE TO THE EXCLUSIVE RIGHT TO USE "FLAX", APART FROM THE MARK AS SHOWN.

THE MARK CONSISTS OF THE WORDS TRAVEL FLAX IN A STYLIZED MANNER.

FOR MILLED FLAX SEED (U.S. CL. 46).

FIRST USE 4-3-2007; IN COMMERCE 4-3-2007.

CHRISTOPHER BUONGIORNO, EXAMINING ATTORNEY

SN 77-158,472. NUCAL FOODS, INC., RIPON, CA. FILED 4-17-2007.

HAPPY GO CLUCKY

THE MARK CONSISTS OF STANDARD CHARACTERS WITHOUT CLAIM TO ANY PARTICULAR FONT, STYLE, SIZE, OR COLOR.

FOR EGGS (U.S. CL. 46).

FIRST USE 7-25-2005; IN COMMERCE 7-25-2005.

MARY MUNSON, EXAMINING ATTORNEY

SN 77-161,261. BRANDMARK, LLC, LAKELAND, TN. FILED 4-19-2007.

GREEN FACTS

THE MARK CONSISTS OF STANDARD CHARACTERS WITHOUT CLAIM TO ANY PARTICULAR FONT, STYLE, SIZE, OR COLOR.

NO CLAIM IS MADE TO THE EXCLUSIVE RIGHT TO USE "GREEN", APART FROM THE MARK AS SHOWN.

FOR MILK; CHOCOLATE MILK; MILK BEVERAGES WITH HIGH MILK CONTENT; MILK BEVERAGES CONTAINING FRUITS; MILK-BASED BEVERAGES CONTAINING FRUIT JUICE; MILK-BASED BEVERAGES CONTAINING COFFEE; MILK POWDER; DAIRY-BASED AND NON-DAIRY-BASED WHIPPED TOPPINGS; DAIRY-BASED BEVERAGES; DAIRY PRODUCTS EXCLUDING ICE CREAM, ICE MILK AND FROZEN YOGURT; EGGNOG; BUTTERMILK; YOGURT; YOGURT-BASED BEVERAGES; DRINKING YOGURTS; CHICKEN, FISH AND MEAT-BASED MOUSSES; VEGETABLE MOUSSES; CREAM; BUTTER; CHEESE SPREADS; CHEESE; MEAT; FISH; POULTRY; MEAT EXTRACT; PRESERVED, DRIED AND COOKED FRUITS AND VEGETABLES; PROCESSED MUSHROOMS; CANNED OR BOTTLED FRUITS; CANNED OR BOTTLED VEGETABLES; CANNED FISH; CANNED COOKED MEAT; VEGETABLE JUICE FOR COOKING; PICKLES; JELLIES; JAMS; EGGS; EDIBLE OIL; OLIVE OIL; OLIVE PASTES; EDIBLE FATS; COMPOTES; POTATO CHIPS; POTATO CRISPS; VEGETABLE CHIPS; VEGETABLE CRISPS; DRIED FRUIT MIXES; ROASTED NUTS; SHELLED NUTS; SOUPS; FROZEN, PREPARED AND PACKAGES MEALS CONSISTING PRIMARILY OF MEAT, FISH, POULTRY OR VEGETABLES (U.S. CL. 46).

MICHAEL WEBSTER, EXAMINING ATTORNEY

SN 77-158,576. PROSPECT ENTERPRISES, INC., LOS ANGELES, CA. FILED 4-17-2007.



NO CLAIM IS MADE TO THE EXCLUSIVE RIGHT TO USE "KANSAS MEAT AND PROVISIONS", APART FROM THE MARK AS SHOWN.

THE COLOR(S) RED, WHITE, AND BLUE IS/ARE CLAIMED AS A FEATURE OF THE MARK.

THE MARK CONSISTS OF A BLUE HALF CIRCLE ON TOP, A BLUE STRAIGHT LINE BELOW THE HALF CIRCLE, A RED STYLIZED K AND THE WORD KANSAS, WHITE TEXT STATING MEAT & PROVISIONS IN THE BOTTOM PORTION OF THE STYLIZED K.

FOR SEAFOOD; MEAT (U.S. CL. 46).

RENEE SERVANCE, EXAMINING ATTORNEY

CLASS 29—(Continued).

SN 77-162,225. THE JOY OF COOKING TRUST, VONORE, TN. FILED 4-20-2007.



OWNER OF U.S. REG. NOS. 2,115,779, 3,204,703 AND OTHERS.

THE MARK CONSISTS OF THE STYLIZED WORDS JOY OF COOKING ENCLOSED IN A CIRCLE.

FOR FROZEN, PREPARED OR PACKAGED APPETIZERS AND ENTREES CONSISTING PRIMARILY OF MEAT, POULTRY, SEAFOOD, FRUIT OR VEGETABLES (U.S. CL. 46).

EVELYN BRADLEY, EXAMINING ATTORNEY

SN 77-162,302. LESSEREVIL BRAND SNACK CO., TUCK-AHOE, NY. FILED 4-20-2007.

STOP BAD SNACKING

THE MARK CONSISTS OF STANDARD CHARACTERS WITHOUT CLAIM TO ANY PARTICULAR FONT, STYLE, SIZE, OR COLOR.

FOR FRUIT AND SOY BASED SNACK FOOD; FRUIT-BASED SNACK FOOD; POTATO-BASED SNACK FOODS; PROTEIN BASED, NUTRIENT-DENSE SNACK BARS; SNACK MIX CONSISTING PRIMARILY OF PROCESSED FRUITS, PROCESSED NUTS AND/OR RAISINS; SOY-BASED SNACK FOODS; FRUIT CHIPS; FRUIT LEATHERS; FRUIT PEELS; FRUIT RINDS; FRUIT SALADS; FRUIT-BASED SPREADS; SOY-BASED FOOD BEVERAGE USED AS A MILK SUBSTITUTE (U.S. CL. 46).

SARA THOMAS, EXAMINING ATTORNEY

SN 77-163,455. TYSON FOODS, INC., SPRINGDALE, AR. FILED 4-23-2007.

GRANGE AND GRASSLAND

THE MARK CONSISTS OF STANDARD CHARACTERS WITHOUT CLAIM TO ANY PARTICULAR FONT, STYLE, SIZE, OR COLOR.

FOR BEEF; PORK; POULTRY (U.S. CL. 46).

MARILYN IZZI, EXAMINING ATTORNEY

CLASS 29—(Continued).

SN 77-169,278. TYSON FOODS, INC., SPRINGDALE, AR. FILED 4-30-2007.

ANY TIME IS RIGHT FOR ANY'TIZERS

THE MARK CONSISTS OF STANDARD CHARACTERS WITHOUT CLAIM TO ANY PARTICULAR FONT, STYLE, SIZE, OR COLOR.

FOR SNACKS AND APPETIZERS CONSISTING PRIMARILY OF MEAT, ALONG WITH POULTRY, CHEESE, VEGETABLES OR RICE WHICH ARE BREADED, COATED OR DOUGH ENROBED (U.S. CL. 46).

MARILYN IZZI, EXAMINING ATTORNEY

SN 77-169,295. TYSON FOODS, INC., SPRINGDALE, AR. FILED 4-30-2007.

ANY TIME IS RIGHT FOR TYSON ANY'TIZERS

THE MARK CONSISTS OF STANDARD CHARACTERS WITHOUT CLAIM TO ANY PARTICULAR FONT, STYLE, SIZE, OR COLOR.

OWNER OF U.S. REG. NOS. 1,748,683 AND 2,810,231. FOR SNACKS AND APPETIZERS CONSISTING PRIMARILY OF MEAT, ALONG WITH POULTRY, CHEESE, VEGETABLES OR RICE WHICH ARE BREADED, COATED OR DOUGH ENROBED (U.S. CL. 46).

MARILYN IZZI, EXAMINING ATTORNEY

SN 77-170,718. COLEMAN NATURAL FOODS, LLC, GOLDEN, CO. FILED 5-2-2007.

NEVER EVER

THE MARK CONSISTS OF STANDARD CHARACTERS WITHOUT CLAIM TO ANY PARTICULAR FONT, STYLE, SIZE, OR COLOR.

FOR FRESH, PROCESSED, COOKED AND FROZEN POULTRY, BEEF, PORK, LAMB AND BISON; POULTRY, BEEF, PORK, LAMB AND BISON PRODUCTS, NAMELY, PREPACKAGED COOKED AND UNCOOKED MEALS (U.S. CL. 46).

DAVID H. STINE, EXAMINING ATTORNEY

CLASS 29—(Continued).

SN 77-172,394. HITE USA, INC., RANCHO DOMINGUEZ, CA. FILED 5-3-2007.

MI AVOLE

THE MARK CONSISTS OF STANDARD CHARACTERS WITHOUT CLAIM TO ANY PARTICULAR FONT, STYLE, SIZE, OR COLOR.

NO CLAIM IS MADE TO THE EXCLUSIVE RIGHT TO USE "AVOLE", APART FROM THE MARK AS SHOWN.

THE FOREIGN WORDING "MI AVOLE" IN THE MARK TRANSLATES INTO ENGLISH AS "MY AVOCADO OIL." FOR FOOD OILS MADE FROM AVOCADOS (U.S. CL. 46).

AMY MCMENAMIN, EXAMINING ATTORNEY

SN 77-173,258. HESHE AND SHULEM MANAGEMENT INC., BROOKLYN, NY. FILED 5-4-2007.

BATUECH

THE MARK CONSISTS OF STANDARD CHARACTERS WITHOUT CLAIM TO ANY PARTICULAR FONT, STYLE, SIZE, OR COLOR.

THE ENGLISH TRANSLATION OF THE WORD "BATUECH" IS "SAFE", "SECURE" OR "SURE."

FOR PRODUCE, NAMELY, VEGETABLES FROZEN AND PROCESSED (U.S. CL. 46).

CHARLOTTE CORWIN, EXAMINING ATTORNEY

SN 77-173,272. HESHE AND SHULEM MANAGEMENT INC., BROOKLYN, NY. FILED 5-4-2007.

BITACHON

THE MARK CONSISTS OF STANDARD CHARACTERS WITHOUT CLAIM TO ANY PARTICULAR FONT, STYLE, SIZE, OR COLOR.

THE ENGLISH TRANSLATION OF THE WORD "BITACHON" IS "SAFETY" OR "SECURITY."

FOR PRODUCE, NAMELY, VEGETABLES FROZEN AND PROCESSED (U.S. CL. 46).

CHARLOTTE CORWIN, EXAMINING ATTORNEY

CLASS 29—(Continued).

SN 77-184,777. CARAPELLI FIRENZE S.P.A., FIRENZE, ITALY, FILED 5-18-2007.

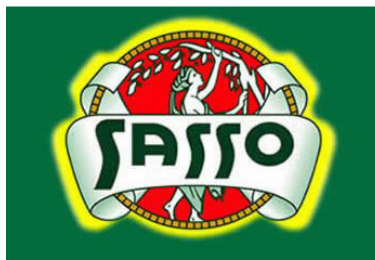

THE COLOR(S) GREEN, YELLOW, RED, WHITE AND ORANGE IS/ARE CLAIMED AS A FEATURE OF THE MARK.

THE COLOR GREEN APPEARS IN THE BACKGROUND OF THE DRAWING AND IN THE TERM SASSO; THE COLOR YELLOW APPEARS IN THE OUTLINE OF THE CIRCULAR DESIGN; THE COLOR RED APPEARS IN THE CIRCULAR DESIGN OF THE DRAWING; THE COLOR WHITE APPEARS IN THE FIGURE OF THE WOMAN AND IN THE TREE BRANCH; THE COLOR ORANGE APPEARS IN THE RING-LIKE SHAPE ENCIRCLING THE WOMAN.

THE FOREIGN WORDING IN THE MARK TRANSLATES INTO ENGLISH AS STONE.

FOR EDIBLE OIL; OLIVE OIL (U.S. CL. 46).

FIRST USE 10-0-1904; IN COMMERCE 10-0-1912.

NORA BUCHANAN WILL, EXAMINING ATTORNEY

SN 77-186,416. TYSON FOODS, INC., SPRINGDALE, AR. FILED 5-21-2007.

SOLO SERVES

THE MARK CONSISTS OF STANDARD CHARACTERS WITHOUT CLAIM TO ANY PARTICULAR FONT, STYLE, SIZE, OR COLOR.

FOR BEEF; PORK; POULTRY (U.S. CL. 46).

MARILYN IZZI, EXAMINING ATTORNEY

SN 77-193,788. COFFIN, KELLY, BOZEMAN, MT. FILED 5-30-2007.

WE CAN'T SAY IT'S CHEESE

THE MARK CONSISTS OF STANDARD CHARACTERS WITHOUT CLAIM TO ANY PARTICULAR FONT, STYLE, SIZE, OR COLOR.

FOR FOOD PRODUCT, NAMELY, VEGETARIAN SUBSTITUTE FOR CHEESE (U.S. CL. 46).

HEATHER THOMPSON, EXAMINING ATTORNEY

CLASS 29—(Continued).

SN 77-195,502. JTM PROVISIONS COMPANY, INC., HARRISON, OH. FILED 6-1-2007.



THE MARK CONSISTS OF THE WORDS STEAMBOAT JACK'S ADJACENT TO STEAMBOAT STACK DESIGNS. FOR PRE-MADE, FULLY COOKED BARBECUE MEATS (U.S. CL. 46).
CHRISTOPHER OTT, EXAMINING ATTORNEY

SN 77-215,741. CLIF BAR & CO., BERKELEY, CA. FILED 6-26-2007.

LEMONZEST

THE MARK CONSISTS OF STANDARD CHARACTERS WITHOUT CLAIM TO ANY PARTICULAR FONT, STYLE, SIZE, OR COLOR.
OWNER OF U.S. REG. NO. 2,491,560.
SEC. 2(F).
FOR SOY-BASED FOOD BARS ALSO CONTAINING GRAIN AND RICE (U.S. CL. 46).
FIRST USE 3-12-1999; IN COMMERCE 3-12-1999.
ALEXANDER L. POWERS, EXAMINING ATTORNEY

SN 77-236,061. KELLOGG NORTH AMERICA COMPANY, BATTLE CREEK, MI. FILED 7-23-2007.

PUNCH A-LICIOUS

THE MARK CONSISTS OF STANDARD CHARACTERS WITHOUT CLAIM TO ANY PARTICULAR FONT, STYLE, SIZE, OR COLOR.
FOR YOGURT COATED DEHYDRATED FRUIT SNACKS; YOGURT COATED FRUIT FLAVORED SNACKS; YOGURT COATED FRUIT JUICE BASED SNACK FOODS (U.S. CL. 46).
FIRST USE 11-0-2006; IN COMMERCE 3-21-2007.
JOHN WILKE, EXAMINING ATTORNEY

CLASS 29—(Continued).

SN 78-762,773. HEB GROCERY COMPANY, L.P., SAN ANTONIO, TX. FILED 11-29-2005.

MI CASITA

THE MARK CONSISTS OF STANDARD CHARACTERS WITHOUT CLAIM TO ANY PARTICULAR FONT, STYLE, SIZE, OR COLOR.
THE ENGLISH TRANSLATION OF THE WORDS MI CASITA IN THE MARK IS MY LITTLE HOUSE.
FOR FAJITA MEAT PRODUCTS, NAMELY, BEEF, PORK, AND CHICKEN (U.S. CL. 46).
EDWARD NELSON, EXAMINING ATTORNEY

SN 78-833,429. THE MOODSTERS COMPANY, MINNEAPOLIS, MN. FILED 3-9-2006.

SUPER YOU FOODS

THE MARK CONSISTS OF STANDARD CHARACTERS WITHOUT CLAIM TO ANY PARTICULAR FONT, STYLE, SIZE, OR COLOR.
NO CLAIM IS MADE TO THE EXCLUSIVE RIGHT TO USE "FOODS", APART FROM THE MARK AS SHOWN.
FOR FOOD PRODUCTS, NAMELY, FRUIT BASED SNACK FOOD, PROCESSED VEGETABLES, PROCESSED FRUITS, SOUP, YOGURT, MILK, CHEESE, CHEESE SNACKS, NAMELY, CHEESE SLICES AND CHEESE STICKS, REFRIGERATED, FROZEN OR SHELF STABLE MEALS CONSISTING PRIMARILY OF MEAT, SEAFOOD, VEGETABLES, AND/OR CHEESE (U.S. CL. 46).
BRENDAN MCCAULEY, EXAMINING ATTORNEY

SN 78-887,729. CAVEMAN JERKY, INC., GRANTS PASS, OR. FILED S.R. 5-19-2006; AM. P.R. 8-13-2007.



NO CLAIM IS MADE TO THE EXCLUSIVE RIGHT TO USE "JERKY" AND "REAL BEEF JERKY", APART FROM THE MARK AS SHOWN.
THE COLOR(S) BROWN, BLACK, RED, ORANGE, TAN AND WHITE ARE CLAIMED AS A FEATURE OF THE MARK.
THE MARK CONSISTS OF A CAVEMAN CHARACTER WITH THE WORDS 'CAVEMAN JERKY' ABOVE HIS HEAD. THE FIRST LETTER, 'C' OF THE WORD 'CAVEMAN JERKY' IS ORANGE, THE REST OF THE WORDS

CLASS 29—(Continued).

ARE BLACK. THE CAVEMAN CHARACTER HAS HAIR THAT IS BROWN IN COLOR, AND IS HOLDING A PIECE OF MEAT IN HIS RIGHT HAND THAT IS BROWN AND HAS A WHITE BONE BASE. THE CAVEMAN'S SKIN COLOR IS TAN, AND HIS LOINCLOTH IS BLACK AND BROWN. THERE IS GRASS BEHIND THE CAVEMAN'S FEET WHICH IS BROWN IN COLOR, THERE IS A ROCK WHICH IS RED IN COLOR TO THE RIGHT OF THE CAVEMAN, BESIDE THE ROCK IS A HAMMERLIKE OBJECT IN THE COLORS BROWN, TAN AND BLACK.

FOR BEEF SLICES; DRIED BEEF SLICES; BEEF JERKY (U.S. CL. 46).

NAAKWAMA ANKRAH, EXAMINING ATTORNEY

SN 78-888,047. CARAPELLI FIRENZE S.P.A., TAVARNELLE VAL DI PESA, ITALY, FILED 5-19-2006.



PRIORITY CLAIMED UNDER SEC. 44(D) ON ITALY APPLICATION NO. MI2006C00304, FILED 3-17-2006, REG. NO. MI2006C00304, DATED 7-18-2007, EXPIRES 3-17-2016.

OWNER OF U.S. REG. NOS. 1,527,151, 2,760,583 AND 2,940,279.

NO CLAIM IS MADE TO THE EXCLUSIVE RIGHT TO USE "DAL 1893" AND "FIRENZE", APART FROM THE MARK AS SHOWN.

THE MARK CONSISTS OF A LABEL OF RECTANGULAR SHAPE CONTAINING THE FOLLOWING ELEMENTS: WORDING "DAL 1893 CARAPELLI FIRENZE" WRITTEN IN THREE LINES, IN FANCIFUL CHARACTERS; RHOMBOIDAL DEVICE WITH DOUBLE BORDERS INCLUDING FOUR LITTLE RHOMBOIDAL DEVICES AND TWELVE LITTLE RECTANGULAR DEVICES PLACED ALONG THE SIDES AND, IN THE MIDDLE, THE REPRESENTATION OF OLIVES AND LEAVES; HORIZONTAL LINE BEGINNING FROM THE ABOVE MENTIONED RHOMBOIDAL DEVICE; WORDING "ORO VERDE" IN SMALL AND FANCIFUL CHARACTERS.

THE ENGLISH TRANSLATION OF DAL 1893 IS SINCE 1893. THE ENGLISH TRANSLATION OF FIRENZE IS FLORENCE. THE ENGLISH TRANSLATION OF ORO VERDE IS GREEN GOLD.

FOR MEAT, FISH, POULTRY AND GAME; MEAT EXTRACT; PRESERVED, DRIED AND COOKED FRUITS AND VEGETABLES; JELLIES, JAMS, COM-POTES; EGGS, MILK; EDIBLE OILS AND FATS (U.S. CL. 46).

SARA THOMAS, EXAMINING ATTORNEY

SN 78-932,861. FINE NUTRA CORPORATION, TORRNACE, CA. FILED 7-19-2006.

SALVAR

THE MARK CONSISTS OF STANDARD CHARACTERS WITHOUT CLAIM TO ANY PARTICULAR FONT, STYLE, SIZE, OR COLOR.

FOR PROCESSED EDIBLE CHIA SEEDS; EDIBLE CHIA SEED OIL; CHIA- SEED-BASED FOOD, NAMELY SNACK BARS (U.S. CL. 46).

NAAKWAMA ANKRAH, EXAMINING ATTORNEY

CLASS 29—(Continued).

SN 78-942,595. SEAFOOD PRODUCERS COOPERATIVE, BELLINGHAM, WA. FILED 8-1-2006.



OWNER OF U.S. REG. NO. 2,737,947.

NO CLAIM IS MADE TO THE EXCLUSIVE RIGHT TO USE "ALASKA", "BRAND" AND "PREMIUM FRESH AND FRESH-FROZEN SEAFOOD PRODUCT OF USA GUARAN-TEED QUALITY SEAFOOD PRODUCERS COOPERATIVE SITKA, ALASKA & BELLINGHAM, WASHINGTON 98225", APART FROM THE MARK AS SHOWN.

FOR SEAFOOD, NAMELY, FISH (U.S. CL. 46).

FIRST USE 10-9-1982; IN COMMERCE 10-9-1982.

NANCY CLARKE, EXAMINING ATTORNEY

SN 78-960,176. DAIRY CREST LIMITED, ESHER, SURREY, UNITED KINGDOM, FILED 8-24-2006.

STURMINSTER

THE MARK CONSISTS OF STANDARD CHARACTERS WITHOUT CLAIM TO ANY PARTICULAR FONT, STYLE, SIZE, OR COLOR.

FOR CHEESE (U.S. CL. 46).

RICHARD WHITE, EXAMINING ATTORNEY

CLASS 29—(Continued).

SN 78-966,995. DAIRY CREST LIMITED, ESHER, SURREY, UNITED KINGDOM, FILED 9-5-2006.



OWNER OF U.S. REG. NO. 1,111,023.
NO CLAIM IS MADE TO THE EXCLUSIVE RIGHT TO USE "DAIRY" AND "IMPORTED ENGLISH CHEESE", APART FROM THE MARK AS SHOWN.

"THE MARK CONSISTS OF AN INCOMPLETE CIRCLE INSIDE OF WHICH APPEAR THE WORDS, 'DAIRY CREST' WITH THE TOP OF A CLOCK TOWER IN FRONT OF A LIGHT BACKGROUND, BELOW WHICH ARE THE WORDS, 'IMPORTED ENGLISH CHEESE' IN THE SHAPE OF A RIBBON AND WITHIN A BORDER IN THE SAME SHAPE."

FOR CHEESE (U.S. CL. 46).
EDWARD FENNESSY, EXAMINING ATTORNEY

CLASS 30—(Continued).

SN 77-020,929. CHERRYDALE MANUFACTURING, L.L.C., ALLENTOWN, PA. FILED 10-13-2006.

THE HEART OF CHOCOLATE

THE MARK CONSISTS OF STANDARD CHARACTERS WITHOUT CLAIM TO ANY PARTICULAR FONT, STYLE, SIZE, OR COLOR.

NO CLAIM IS MADE TO THE EXCLUSIVE RIGHT TO USE "CHOCOLATE", APART FROM THE MARK AS SHOWN.

FOR CHOCOLATE BASED READY-TO-EAT FOOD BARS; GRAIN BASED FOOD BARS; GRANOLA BASED SNACK BARS; READY TO EAT, CEREAL DERIVED FOOD BARS; CHOCOLATE; AND CONFECTIONERY, NAMELY, CANDY (U.S. CL. 46).

HANNO RITTNER, EXAMINING ATTORNEY

SN 77-028,304. COMERCIALIZADORA GONAC, S.A. DE C.V., PUEBLA, PUEBLA, MEXICO, FILED 10-24-2006.

GONAC**CLASS 30—STAPLE FOODS**

SN 76-617,282. WAKEFERN FOOD CORP., ELIZABETH, NJ, FILED 10-22-2004.

LIVE RIGHT WITH SHOP RITE

THE MARK CONSISTS OF STANDARD CHARACTERS WITHOUT CLAIM TO ANY PARTICULAR FONT, STYLE, SIZE, OR COLOR.

OWNER OF U.S. REG. NOS. 1,867,239, 2,467,334 AND OTHERS.

FOR PREPARED, PACKAGED AND FROZEN MEALS CONSISTING PRIMARILY OF RICE OR PASTA; BAKERY GOODS, BREADS, ROLLS, PASTRIES, CAKES, COOKIES, CRACKERS, RICE CAKES, FLOUR, MIXES FOR MAKING BAKERY GOODS, PANCAKE MIX, CUSTARD FILLINGS FOR PIES AND CAKES, CHOCOLATE-BASED FILLINGS FOR PIES AND CAKES, CHOCOLATE CHIPS, COCONUT FLAKES, MARSHMALLOWS, FROSTINGS, CROUTONS, STUFFING MIXES CONTAINING BREAD, BREAD CRUMBS, BREAKFAST CEREALS, OATMEAL, TOASTER PASTRIES, SUGAR, CANDY, SAUCES (EXCLUDING APPLESAUCE AND CRANBERRY SAUCE), GRAVY, HONEY, SPICES, PASTAS, NOODLES, RICE, CONDIMENT RELISHES, MAYONNAISE, TABLE SYRUPS, VINEGAR, ICE CREAM, ICE MILK AND FROZEN YOGURT, PRETZELS, CEREAL-BASED, RICE-BASED, CORN-BASED AND WHEAT-BASED SNACK FOODS, FOOD SEASONINGS; SALAD DRESSINGS, MICRO-WAVE POPCORN; UNPOPPED DRIED POPCORN KERNELS (U.S. CL. 46).

JENNIFER DIXON, EXAMINING ATTORNEY

THE MARK CONSISTS OF STANDARD CHARACTERS WITHOUT CLAIM TO ANY PARTICULAR FONT, STYLE, SIZE, OR COLOR.

FOR CONFECTIONERY, NAMELY, CANDY, CHOCOLATE AND PASTRIES; CEREAL-BASED SNACK FOODS; AND POPCORN (U.S. CL. 46).

BRIAN PINO, EXAMINING ATTORNEY

SN 77-028,860. FRESHIES FOOD CORPORATION, DENVER, CO. FILED 10-25-2006.

FRESH RIMZ

THE MARK CONSISTS OF STANDARD CHARACTERS WITHOUT CLAIM TO ANY PARTICULAR FONT, STYLE, SIZE, OR COLOR.

NO CLAIM IS MADE TO THE EXCLUSIVE RIGHT TO USE "RIMS", APART FROM THE MARK AS SHOWN.

FOR GLASS RIMMER, NAMELY, SALT, SUGAR, FLAVORED SALTS, FLAVORED SUGARS, PROCESSED HERBS AND SPICES FOR APPLYING TO THE RIM OF A GLASS, SOLD IN A TIN CONTAINER AND SHALLOW LID THAT THE GLASS COULD BE TURNED UPSIDE DOWN INTO (U.S. CL. 46).

FLORENTINA BLANDU, EXAMINING ATTORNEY

CLASS 30—(Continued).

SN 77-043,252. NASHVILLE TOFFEE COMPANY, LLC, NASHVILLE, TN. FILED 11-14-2006.



NO CLAIM IS MADE TO THE EXCLUSIVE RIGHT TO USE "TOFFEE COMPANY", APART FROM THE MARK AS SHOWN.

THE COLOR(S) PURPLE, TAN, ORANGE, AND IVORY IS/ ARE CLAIMED AS A FEATURE OF THE MARK.

THE MARK CONSISTS OF THREE CONCENTRIC CIRCLES, WITH THE OUTER CIRCLE IN THE COLOR PURPLE, THE MIDDLE CIRCLE IN THE COLOR TAN, AND THE INNER CIRCLE IN THE COLOR IVORY ARE THE STYLIZED WORDS NASHVILLE TOFFEE COMPANY, STACKED VERTICALLY, AND ORNATE DECORATIVE CRESTS, ACCENTED BY SMALL DOTS AND WITH A DIAMOND-SHAPED FLOWER-LIKE DESIGN. THE CRESTS WITH THE FLOWER-LIKE DESIGN ARE ABOVE AND BELOW THE STYLIZED WORDS AND THE FLOWER-LIKE DESIGNS ARE TO THE LEFT AND RIGHT OF THE STYLIZED WORDS. THE SMALL DOTS FRAME THE WORD TOFFEE TOWARD THE CENTER OF THE MARK.

FOR TOFFEES, MILK AND DARK CHOCOLATE ALMOND TOFFEES, CHOCOLATE BARKS, AND CHOCOLATE AND ALMOND CONFECTIONS IN THE NATURE OF CANDIES (U.S. CL. 46).

FIRST USE 5-15-2006; IN COMMERCE 5-15-2006.
ALEXANDER L. POWERS, EXAMINING ATTORNEY

SN 77-058,883. NO LIMIT, LLC, WESTPORT, CT. FILED 12-7-2006.

NATURAL SALAD MISTERS

THE MARK CONSISTS OF STANDARD CHARACTERS WITHOUT CLAIM TO ANY PARTICULAR FONT, STYLE, SIZE, OR COLOR.

NO CLAIM IS MADE TO THE EXCLUSIVE RIGHT TO USE "NATURAL SALAD", APART FROM THE MARK AS SHOWN.

FOR SALAD DRESSINGS (U.S. CL. 46).
STANLEY I. OSBORNE, EXAMINING ATTORNEY

CLASS 30—(Continued).

SN 77-099,118. HEHIMU, LLC, RARITAN, NJ. FILED 2-5-2007.



NO CLAIM IS MADE TO THE EXCLUSIVE RIGHT TO USE "LLC.", APART FROM THE MARK AS SHOWN. THE MARK CONSISTS OF STYLIZED TEXT IN CONCENTRIC OVALS.

FOR COFFEE (U.S. CL. 46).
BRIAN NEVILLE, EXAMINING ATTORNEY

SN 77-119,591. SOUTHERN VISIONS, LLP, MOBILE, AL. FILED 3-1-2007.



NO CLAIM IS MADE TO THE EXCLUSIVE RIGHT TO USE "JAVA" AND "FRESH BREWED ICED COFFEE", APART FROM THE MARK AS SHOWN.

THE COLOR(S) BROWN, BLUE, WHITE, AND BLACK IS/ ARE CLAIMED AS A FEATURE OF THE MARK.

THE MARK CONSISTS OF JAVA IN WHITE LETTERS ON A BROWN BACKGROUND, CHILL IN WHITE LETTERS ON A BLUE BACKGROUND AND A BLACK BORDER. THE WORDS "FRESH BREWED ICED COFFEE" APPEAR IN BLACK UNDERNEATH THE WORDING "JAVA CHILL." TO THE RIGHT OF THE WORDING IS AN IMAGE OF A COFFEE BEAN OUTLINED IN BLACK.

FOR COFFEE; COFFEE FLAVORED SYRUP USED IN MAKING FOOD BEVERAGES; COFFEE SUBSTITUTES (U.S. CL. 46).

FIRST USE 6-1-2006; IN COMMERCE 6-1-2006.
PAMELA HIRSCHMAN, EXAMINING ATTORNEY

CLASS 30—(Continued).

SN 77-119,835. THE JEL SERT COMPANY, WEST CHICAGO, IL. FILED 3-1-2007.

MR. FREEZE

THE MARK CONSISTS OF STANDARD CHARACTERS WITHOUT CLAIM TO ANY PARTICULAR FONT, STYLE, SIZE, OR COLOR.
FOR FROZEN CONFECTIONS, NAMELY, FREEZER BARS (U.S. CL. 46).
ZHALEH DELANEY, EXAMINING ATTORNEY

SN 77-124,094. SUSTAINABLE AGRICO, L.L.C., SANTA FE, NM. FILED 3-7-2007.

PLAYA DEL COCO

THE MARK CONSISTS OF STANDARD CHARACTERS WITHOUT CLAIM TO ANY PARTICULAR FONT, STYLE, SIZE, OR COLOR.
THE ENGLISH TRANSLATION OF THE WORD PLAYA DEL COCO IN THE MARK IS BEACH OF THE COCONUT. FOR ORGANIC CHOCOLATE (U.S. CL. 46).
LANA PHAM, EXAMINING ATTORNEY

SN 77-124,105. SUSTAINABLE AGRICO, L.L.C., SANTA FE, NM. FILED 3-7-2007.

KATAHDIN

THE MARK CONSISTS OF STANDARD CHARACTERS WITHOUT CLAIM TO ANY PARTICULAR FONT, STYLE, SIZE, OR COLOR.
FOR ORGANIC CHOCOLATE (U.S. CL. 46).
LANA PHAM, EXAMINING ATTORNEY

CLASS 30—(Continued).

SN 77-130,523. CHERRYDALE MANUFACTURING, L.L.C., ALLENTOWN, PA. FILED 3-14-2007.

BARTONS GOLD

THE MARK CONSISTS OF STANDARD CHARACTERS WITHOUT CLAIM TO ANY PARTICULAR FONT, STYLE, SIZE, OR COLOR.
OWNER OF U.S. REG. NOS. 669,032, 2,971,944 AND OTHERS.
FOR CHOCOLATE, CHOCOLATE BARS, CHOCOLATE TRUFFLES, CANDY, CHOCOLATE COVERED PRETZELS, CHOCOLATE COVERED POPCORN, CHOCOLATE COVERED GRAHAM CRACKERS, CHOCOLATE COVERED DRIED FRUITS, LOLLIPOPS, MARSHMALLOWS, CHEWING GUM, BUBBLE GUM, CHOCOLATE BASED READY-TO-EAT FOOD BARS, GRAIN BASED FOOD BARS, GRANOLA BASED SNACK BARS, READY TO EAT, CEREAL DERIVED FOOD BARS, PUFFED RICE AND MARSHMALLOW BARS, AND CHOCOLATE FOOD BEVERAGES NOT BEING DAIRY-BASED (U.S. CL. 46).
KEVON CHISOLM, EXAMINING ATTORNEY

SN 77-135,042. THE JEL SERT COMPANY, WEST CHICAGO, IL. FILED 3-20-2007.

ROYAL

THE MARK CONSISTS OF STANDARD CHARACTERS WITHOUT CLAIM TO ANY PARTICULAR FONT, STYLE, SIZE, OR COLOR.
OWNER OF U.S. REG. NOS. 668,120 AND 669,690.
FOR CUSTARD, GELATIN, PIE FILLING AND PUDDING DESSERT POWDERS; READY TO EAT CUSTARDS, GELATINS, PIE FILLINGS AND PUDDINGS IN CLASS 30 (U.S. CL. 46).
CAROLYN CATALDO, EXAMINING ATTORNEY

SN 77-135,043. THE JEL SERT COMPANY, WEST CHICAGO, IL. FILED 3-20-2007.

MY-T-FINE

THE MARK CONSISTS OF STANDARD CHARACTERS WITHOUT CLAIM TO ANY PARTICULAR FONT, STYLE, SIZE, OR COLOR.
OWNER OF U.S. REG. NO. 359,356.
FOR CUSTARD, GELATIN, PIE FILLING AND PUDDING DESSERT POWDERS; READY TO EAT DESSERTS, NAMELY, CUSTARDS, GELATINS, PIE FILLINGS, AND PUDDINGS IN CLASS 30 (U.S. CL. 46).
CAROLYN CATALDO, EXAMINING ATTORNEY

CLASS 30—(Continued).

SN 77-135,905. ABUNDA FUNCTIONAL FOODS, SANDY, UT. FILED 3-20-2007.

EXPRESSO RUSH

THE MARK CONSISTS OF STANDARD CHARACTERS WITHOUT CLAIM TO ANY PARTICULAR FONT, STYLE, SIZE, OR COLOR.

NO CLAIM IS MADE TO THE EXCLUSIVE RIGHT TO USE "EXPRESSO", APART FROM THE MARK AS SHOWN, FOR BEVERAGES MADE OF COFFEE; PREPARED COFFEE AND COFFEE-BASED BEVERAGES (U.S. CL. 46).

STANLEY I. OSBORNE, EXAMINING ATTORNEY

SN 77-139,536. FABRICA DE CHOCOLATES LA POPULAR, S.A., MONTERREY, MEXICO, FILED 3-24-2007.



"THE NAME(S), PORTRAIT(S), AND/OR SIGNATURE(S) SHOWN IN THE MARK DOES NOT IDENTIFY A PARTICULAR LIVING INDIVIDUAL."

THE COLOR(S) GREY, BROWN, YELLOW, BURGUNDY AND BLUE IS/ARE CLAIMED AS A FEATURE OF THE MARK.

THE MARK CONSISTS OF AN OVAL POSITIONED HORIZONALLY INSIDE OF WHICH APPEARS A WOMAN WALKING NEXT TO A RIVER CARRYING A TRAY WITH THREE HOT CHOCOLATE CUPS WITH SMOKE COMING OUT OF THEM. ON THE RIGHT SIDE OF THE DRAWING THERE APPEAR TWO HOUSES IN THE BACKGROUND. ON THE LEFT SIDE OF THE DRAWING THERE IS A RIVER IN THE BACKGROUND AND FURTHER BACK THERE ARE BUSHES. ABOVE THE OVAL THERE IS A BANNER IN THE SHAPE OF A SEMI-CIRCLE THAT SURROUNDS THE OVAL WITH THE WORD POPULAR IN ITS CENTER. THE COLOR GREY APPEARS IN THE WORD POPULAR, IN THE ARMS, NECK, FACE AND HEADBAND OF THE LADY, AND IN THE SURFACE OVER WHICH THE LADY IS STANDING. THE COLOR BROWN APPEARS IN THE HAIR, SHIRT AND SKIRT OF THE LADY, IN THE HOT CHOCOLATE CUPS, IN THE SMOKE COMING OUT OF THE HOT CHOCOLATE CUPS, IN THE RIVER, IN THE BUSHES, IN THE SURFACE OVER WHICH THE LADY IS STANDING AND IN THE ROOF OF THE HOUSES. THE COLOR YELLOW APPEARS IN THE OUTER BORDER OF THE BANNER, IN THE SMOKE COMING OUT OF THE CHOCOLATE CUPS, IN THE LADY'S SKIRT, IN THE HOUSES AND AROUND THE OVAL. THE COLOR BURGUNDY APPEARS IN THE BANNER AND IN A THIN BORDER OUTSIDE THE YELLOW RING SURROUNDING THE OVAL. THE COLOR BLUE APPEARS IN THE SKY AS WELL AND IN THE RIVER.

THE FOREIGN WORDING IN THE MARK TRANSLATES INTO ENGLISH AS POPULAR.

FOR COCOA MIXES; CHOCOLATE (U.S. CL. 46).
FIRST USE 10-3-1920; IN COMMERCE 9-30-1967.
STEVEN JACKSON, EXAMINING ATTORNEY

CLASS 30—(Continued).

SN 77-142,224. THE JEL SERT COMPANY, WEST CHICAGO, IL. FILED 3-28-2007.

MAKES MILK FUN

THE MARK CONSISTS OF STANDARD CHARACTERS WITHOUT CLAIM TO ANY PARTICULAR FONT, STYLE, SIZE, OR COLOR.

FOR DRINKING STRAW CONTAINING FLAVORING FOR BEVERAGES (U.S. CL. 46).

CAROLYN CATALDO, EXAMINING ATTORNEY

SN 77-142,229. THE JEL SERT COMPANY, WEST CHICAGO, IL. FILED 3-28-2007.

A FUN WAY TO DRINK MILK

THE MARK CONSISTS OF STANDARD CHARACTERS WITHOUT CLAIM TO ANY PARTICULAR FONT, STYLE, SIZE, OR COLOR.

FOR DRINKING STRAW CONTAINING FLAVORING FOR BEVERAGES (U.S. CL. 46).

CAROLYN CATALDO, EXAMINING ATTORNEY

SN 77-147,907. SLEEP CO, INC., SAN PEDRO, CA. FILED 4-3-2007.

The Original Relaxation Gum

THE MARK CONSISTS OF STANDARD CHARACTERS WITHOUT CLAIM TO ANY PARTICULAR FONT, STYLE, SIZE, OR COLOR.

NO CLAIM IS MADE TO THE EXCLUSIVE RIGHT TO USE "THE ORIGINAL" AND "GUM", APART FROM THE MARK AS SHOWN.

FOR CHEWING GUM (U.S. CL. 46).
MARCIE MILONE, EXAMINING ATTORNEY

CLASS 30—(Continued).

SN 77-147,916. SLEEPKO, INC., SAN PEDRO, CA. FILED 4-3-2007.

The Original Relaxation Bar

THE MARK CONSISTS OF STANDARD CHARACTERS WITHOUT CLAIM TO ANY PARTICULAR FONT, STYLE, SIZE, OR COLOR.

OWNER OF U.S. REG. NO. 2,771,355.

NO CLAIM IS MADE TO THE EXCLUSIVE RIGHT TO USE "THE ORIGINAL" AND "BAR", APART FROM THE MARK AS SHOWN.

FOR READY TO EAT, CEREAL DERIVED FOOD BARS (U.S. CL. 46).

MARCIE MILONE, EXAMINING ATTORNEY

SN 77-148,574. HIGHLAND SUGARWORKS, INC., WEBSTERVILLE, VT. FILED 4-4-2007.



THE COLOR(S) ORANGE, YELLOW AND GRAY IS/ARE CLAIMED AS A FEATURE OF THE MARK.

THE MARK CONSISTS OF THE IMAGE OF A MAPLE LEAF, INCLUDING THE STEM OF THE LEAF. THE VEINS OF THE LEAF AND THE LOWER LEFT PORTION OF THE LEAF ARE COLORED YELLOW, WITH THE BALANCE OF THE LEAF COLORED ORANGE. THE LEAF IS DEPICTED RESTING ON A FLAT SURFACE WITH A GRAY SHADOW UNDER IT. WHITE IN THE DRAWING REPRESENTS A TRANSPARENT BACKGROUND.

FOR MAPLE SYRUP (U.S. CL. 46).

FIRST USE 7-9-2006; IN COMMERCE 7-9-2006.

REBECCA EISINGER, EXAMINING ATTORNEY

SN 77-152,804. THE JEL SERT COMPANY, WEST CHICAGO, IL. FILED 4-10-2007.

VITA-SIPS

THE MARK CONSISTS OF STANDARD CHARACTERS WITHOUT CLAIM TO ANY PARTICULAR FONT, STYLE, SIZE, OR COLOR.

FOR DRINKING STRAW CONTAINING FLAVORING FOR BEVERAGES (U.S. CL. 46).

CAROLYN CATALDO, EXAMINING ATTORNEY

CLASS 30—(Continued).

SN 77-152,818. THE JEL SERT COMPANY, WEST CHICAGO, IL. FILED 4-10-2007.

VITA-STRAWS

THE MARK CONSISTS OF STANDARD CHARACTERS WITHOUT CLAIM TO ANY PARTICULAR FONT, STYLE, SIZE, OR COLOR.

FOR DRINKING STRAW CONTAINING FLAVORING FOR BEVERAGES (U.S. CL. 46).

CAROLYN CATALDO, EXAMINING ATTORNEY

SN 77-152,830. THE JEL SERT COMPANY, WEST CHICAGO, IL. FILED 4-10-2007.

POWER-SIPS

THE MARK CONSISTS OF STANDARD CHARACTERS WITHOUT CLAIM TO ANY PARTICULAR FONT, STYLE, SIZE, OR COLOR.

FOR DRINKING STRAW CONTAINING FLAVORING FOR BEVERAGES (U.S. CL. 46).

CAROLYN CATALDO, EXAMINING ATTORNEY

SN 77-152,977. THE JEL SERT COMPANY, WEST CHICAGO, IL. FILED 4-10-2007.

POWER-STRAWS

THE MARK CONSISTS OF STANDARD CHARACTERS WITHOUT CLAIM TO ANY PARTICULAR FONT, STYLE, SIZE, OR COLOR.

FOR DRINKING STRAW CONTAINING FLAVORING FOR BEVERAGES (U.S. CL. 46).

CAROLYN CATALDO, EXAMINING ATTORNEY

CLASS 30—(Continued).

SN 77-152,994. THE JEL SERT COMPANY, WEST CHICAGO, IL. FILED 4-10-2007.

NUTRA-SIPS

THE MARK CONSISTS OF STANDARD CHARACTERS WITHOUT CLAIM TO ANY PARTICULAR FONT, STYLE, SIZE, OR COLOR.

FOR DRINKING STRAW CONTAINING FLAVORING FOR BEVERAGES (U.S. CL. 46).
CAROLYN CATALDO, EXAMINING ATTORNEY

SN 77-153,014. JAZ FOODS, MASSILLON, OH. FILED 4-10-2007.

THE INVISIBLE CHEF

THE MARK CONSISTS OF STANDARD CHARACTERS WITHOUT CLAIM TO ANY PARTICULAR FONT, STYLE, SIZE, OR COLOR.

FOR FROSTING MIXES; ICING MIXES; MIXES FOR BAKERY GOODS; PANCAKE MIXES; SAUCE MIXES; SPICE BLENDS; BARBECUE DRY RUB; BARBECUE SAUCE; SEASONED COATING MIXTURES FOR FOODS (U.S. CL. 46).
ALYSSA PALADINO, EXAMINING ATTORNEY

SN 77-153,090. THE JEL SERT COMPANY, WEST CHICAGO, IL. FILED 4-10-2007.

NUTRI-SIPS

THE MARK CONSISTS OF STANDARD CHARACTERS WITHOUT CLAIM TO ANY PARTICULAR FONT, STYLE, SIZE, OR COLOR.

FOR FLAVORING FOR BEVERAGES CONTAINED IN DRINKING STRAW (U.S. CL. 46).
RUSS HERMAN, EXAMINING ATTORNEY

CLASS 30—(Continued).

SN 77-153,742. PADUANO, GABRIEL A., SAN DIEGO, CA. FILED 4-11-2007.

ACAICCINO

THE MARK CONSISTS OF STANDARD CHARACTERS WITHOUT CLAIM TO ANY PARTICULAR FONT, STYLE, SIZE, OR COLOR.

FOR COFFEE-BASED BEVERAGES, COCOA-BASED BEVERAGES, TEA-BASED BEVERAGES, FROZEN CONFECTIONS, AND CANDY, ALL CONTAINING ACAI (U.S. CL. 46).
B. PARADEWELAI, EXAMINING ATTORNEY

SN 77-153,808. HINOJOSA, TONNI, AUSTIN, TX. AND HINOJOSA, MARLINDA, AUSTIN, TX. FILED 4-11-2007.

HINOSPICES

THE MARK CONSISTS OF STANDARD CHARACTERS WITHOUT CLAIM TO ANY PARTICULAR FONT, STYLE, SIZE, OR COLOR.

FOR SPICE BLENDS (U.S. CL. 46).
MATTHEW PAPPAS, EXAMINING ATTORNEY

SN 77-153,827. HINOJOSA, TONNI, AUSTIN, TX. AND HINOJOSA, MARLINDA, AUSTIN, TX. FILED 4-11-2007.

Spices for the Species

THE MARK CONSISTS OF STANDARD CHARACTERS WITHOUT CLAIM TO ANY PARTICULAR FONT, STYLE, SIZE, OR COLOR.

NO CLAIM IS MADE TO THE EXCLUSIVE RIGHT TO USE "SPICES", APART FROM THE MARK AS SHOWN. FOR SPICE BLENDS (U.S. CL. 46).
MATTHEW PAPPAS, EXAMINING ATTORNEY

CLASS 30—(Continued).

SN 77-154,837. CHERRYDALE MANUFACTURING, L.L.C., ALLENTOWN, PA. FILED 4-12-2007.

SINCE 1898



OWNER OF U.S. REG. NOS. 669,032, 2,971,944 AND OTHERS.

NO CLAIM IS MADE TO THE EXCLUSIVE RIGHT TO USE "SINCE 1898", APART FROM THE MARK AS SHOWN. THE MARK CONSISTS OF THE WORDS "SINCE 1898" APPEARING ABOVE AN OVAL CONTAINING THE WORDS "BARTONS GOLD".

FOR CHOCOLATE, CHOCOLATE BARS, CHOCOLATE TRUFFLES, CANDY, CHOCOLATE COVERED PRETZELS, CHOCOLATE COVERED POPCORN, CHOCOLATE COVERED GRAHAM CRACKERS, CHOCOLATE COVERED DRIED FRUITS, LOLLIPOPS, MARSHMALLOWS, CHEWING GUM, BUBBLE GUM, CHOCOLATE BASED READY-TO-EAT FOOD BARS, GRAIN BASED FOOD BARS, GRANOLA BASED SNACK BARS, READY TO EAT, CEREAL DERIVED FOOD BARS, PUFFED RICE AND MARSHMALLOW BARS, AND CHOCOLATE FOOD BEVERAGES NOT BEING DAIRY-BASED (U.S. CL. 46).

KEVON CHISOLM, EXAMINING ATTORNEY

SN 77-155,365. LOONEY BEAN ROASTING COMPANY, BEND, OR. FILED 4-12-2007.

LOONEY BEAN

THE MARK CONSISTS OF STANDARD CHARACTERS WITHOUT CLAIM TO ANY PARTICULAR FONT, STYLE, SIZE, OR COLOR.

NO CLAIM IS MADE TO THE EXCLUSIVE RIGHT TO USE "BEAN", APART FROM THE MARK AS SHOWN.

FOR COFFEE; COFFEE BEANS; GROUND COFFEE BEANS; ROASTED COFFEE BEANS (U.S. CL. 46).

FIRST USE 7-0-1998; IN COMMERCE 7-0-1998.

KAREN BRACEY, EXAMINING ATTORNEY

SN 77-155,373. FLASHIONABLES, INC., MERCERSBURG, PA. FILED 4-12-2007.

SIZZLIN SISTERS

THE MARK CONSISTS OF STANDARD CHARACTERS WITHOUT CLAIM TO ANY PARTICULAR FONT, STYLE, SIZE, OR COLOR.

FOR TEAS; HERBAL FOOD BEVERAGES (U.S. CL. 46).

KAREN BRACEY, EXAMINING ATTORNEY

CLASS 30—(Continued).

SN 77-155,822. BIG MOE'S, COUNCIL, NC. FILED 4-13-2007.



THE MARK CONSISTS OF THE WORD "BIG MOE'S" WITHOUT ANY CLAIM TO A PARTICULAR FONT, STYLE OR COLOR AND A DESIGN OF A BLACK OVAL WITH TWO PIGS IN WHITE INSIDE THE BLACK OVAL.

FOR SAUCES FOR MEAT (U.S. CL. 46).

FIRST USE 12-1-1998; IN COMMERCE 12-1-1998.

KIMBERLY PERRY, EXAMINING ATTORNEY

SN 77-157,282. USTOV, INC. DBA U.S. TRADING COMPANY, HAYWARD, CA. FILED 4-16-2007.



OWNER OF U.S. REG. NO. 1,798,050.

THE MARK CONSISTS OF A LOTUS FLOWER IN THE MIDDLE OF A DIAMOND IN BETWEEN TWO GEOMETRIC SHAPES AND ALL BELOW THE WORD PHRASE "PINK LOTUS".

FOR SEASONINGS; SAUCES (U.S. CL. 46).

REBECCA GILBERT, EXAMINING ATTORNEY

CLASS 30—(Continued).

SN 77-157,319. IMMACULATE BAKING COMPANY, HENDERSONVILLE, NC. FILED 4-16-2007.

A BETTER COOKIE FOR KIDS!

THE MARK CONSISTS OF STANDARD CHARACTERS WITHOUT CLAIM TO ANY PARTICULAR FONT, STYLE, SIZE, OR COLOR.

NO CLAIM IS MADE TO THE EXCLUSIVE RIGHT TO USE "COOKIE", APART FROM THE MARK AS SHOWN. FOR BAKERY GOODS (U.S. CL. 46). FIRST USE 8-1-2006; IN COMMERCE 8-1-2006. JENNIFER KRIS, EXAMINING ATTORNEY

CLASS 30—(Continued).

SN 77-158,454. KELLOGG NORTH AMERICA COMPANY, BATTLE CREEK, MI. FILED 4-17-2007.

FASTFOUR

THE MARK CONSISTS OF STANDARD CHARACTERS WITHOUT CLAIM TO ANY PARTICULAR FONT, STYLE, SIZE, OR COLOR.

OWNER OF U.S. REG. NO. 3,149,148. FOR CRACKERS, COOKIES, CEREAL-BASED SNACK FOOD BARS, TOASTER PASTRIES, FRUIT PRESERVE FILLED PASTRY (U.S. CL. 46). FIRST USE 2-28-2004; IN COMMERCE 2-28-2004. JOHN WILKE, EXAMINING ATTORNEY

SN 77-158,247. USTOV, INC., DBA U.S. TRADING COMPANY, HAYWARD, CA. FILED 4-17-2007.

ONE LADY

THE MARK CONSISTS OF STANDARD CHARACTERS WITHOUT CLAIM TO ANY PARTICULAR FONT, STYLE, SIZE, OR COLOR.

FOR RICE (U.S. CL. 46). REBECCA GILBERT, EXAMINING ATTORNEY

SN 77-158,759. INTERSTATE GOURMET COFFEE ROASTERS INC., SOUTH EASTON, MA. FILED 4-17-2007.

YOU ARE ABOUT TO BECOME
ONE COOL CUSTOMER

THE MARK CONSISTS OF STANDARD CHARACTERS WITHOUT CLAIM TO ANY PARTICULAR FONT, STYLE, SIZE, OR COLOR.

FOR COFFEE (U.S. CL. 46). MYRIAH HABEEB, EXAMINING ATTORNEY

SN 77-158,268. NORTH AMERICAN BAKING, INC., ONTARIO, CANADA, FILED 4-17-2007.

COMMONWEALTH

THE MARK CONSISTS OF STANDARD CHARACTERS WITHOUT CLAIM TO ANY PARTICULAR FONT, STYLE, SIZE, OR COLOR.

FOR COOKIES AND CRACKERS (U.S. CL. 46). MARGERY A. TIERNEY, EXAMINING ATTORNEY

SN 77-158,829. CORLEY, DONNIE E, SAN DIEGO, CA. FILED 4-17-2007.

Subs 2 Go

THE MARK CONSISTS OF STANDARD CHARACTERS WITHOUT CLAIM TO ANY PARTICULAR FONT, STYLE, SIZE, OR COLOR.

NO CLAIM IS MADE TO THE EXCLUSIVE RIGHT TO USE "SUBS", APART FROM THE MARK AS SHOWN. FOR SANDWICHES (U.S. CL. 46). LEE-ANNE BERNS, EXAMINING ATTORNEY

CLASS 30—(Continued).

SN 77-158,999. HEIRS OF ALEX AND ENGRACIA REYES SR., INC., MALATE, MANILA, PHILIPPINES, FILED 4-17-2007.

ARISTOCRAT BAKESHOP

THE MARK CONSISTS OF STANDARD CHARACTERS WITHOUT CLAIM TO ANY PARTICULAR FONT, STYLE, SIZE, OR COLOR.

NO CLAIM IS MADE TO THE EXCLUSIVE RIGHT TO USE "BAKESHOP", APART FROM THE MARK AS SHOWN. FOR BAKERY PRODUCTS (U.S. CL. 46).
MIDGE BUTLER, EXAMINING ATTORNEY

SN 77-159,513. TIMES GRILL RESTAURANT GROUP, LLC, JACKSONVILLE, FL. FILED 4-18-2007.

ALL JACKED UP!

THE MARK CONSISTS OF STANDARD CHARACTERS WITHOUT CLAIM TO ANY PARTICULAR FONT, STYLE, SIZE, OR COLOR.

FOR SANDWICHES (U.S. CL. 46).
BRIDGETT SMITH, EXAMINING ATTORNEY

SN 77-159,815. ROBIN LEBOWITZ-ROSNER, NEW YORK CITY, NY. AND SMITH, CLAUDIA, NEW YORK, NY. FILED 4-18-2007.

Kitchen Witch Bakery

THE MARK CONSISTS OF STANDARD CHARACTERS WITHOUT CLAIM TO ANY PARTICULAR FONT, STYLE, SIZE, OR COLOR.

NO CLAIM IS MADE TO THE EXCLUSIVE RIGHT TO USE "BAKERY", APART FROM THE MARK AS SHOWN.

FOR BAKERY DESSERTS; BAKERY GOODS; BAKERY PRODUCTS; BAKERY PRODUCTS, NAMELY SWEET BAKERY GOODS; CAKES; CUP CAKES (U.S. CL. 46).
LAURA KOVALSKY, EXAMINING ATTORNEY

CLASS 30—(Continued).

SN 77-160,031. DRINK PRIVATE LABEL LLC, HONOLULU, HI. FILED 4-18-2007.

PLANTATION ICED TEA

THE MARK CONSISTS OF STANDARD CHARACTERS WITHOUT CLAIM TO ANY PARTICULAR FONT, STYLE, SIZE, OR COLOR.

NO CLAIM IS MADE TO THE EXCLUSIVE RIGHT TO USE "ICED TEA", APART FROM THE MARK AS SHOWN. FOR TEA-BASED BEVERAGES WITH FRUIT FLAVORING (U.S. CL. 46).

TARAH HARDY, EXAMINING ATTORNEY

SN 77-160,440. KAIA FOODS, SAN FRANCISCO, CA. FILED 4-19-2007.

completely different.
completely good for you.

THE MARK CONSISTS OF STANDARD CHARACTERS WITHOUT CLAIM TO ANY PARTICULAR FONT, STYLE, SIZE, OR COLOR.

FOR BEVERAGES MADE OF TEA; BREAKFAST CEREALS; CEREAL-BASED SNACK FOODS; CRACKERS; FROZEN DESSERT CONSISTING OF FRUIT AND CREAM OR CREAM SUBSTITUTES; GRANOLA; GRANOLA SNACKS; GRANOLA-BASED SNACK BARS; MUESLI; READY TO EAT, CEREAL DERIVED FOOD BARS; SHERBETS; SNACK MIX CONSISTING PRIMARILY OF CRACKERS, PRETZELS, CANDIED NUTS AND/OR POPPED POPCORN (U.S. CL. 46).

ANDREA SAUNDERS, EXAMINING ATTORNEY

SN 77-161,243. JUST BORN, INC., BETHLEHEM, PA. FILED 4-19-2007.

Chews Your Adventure

THE MARK CONSISTS OF STANDARD CHARACTERS WITHOUT CLAIM TO ANY PARTICULAR FONT, STYLE, SIZE, OR COLOR.

FOR CANDY; CANDY BARS (U.S. CL. 46).
ALICE BENMAMAN, EXAMINING ATTORNEY

CLASS 30—(Continued).

SN 77-162,215. THE JOY OF COOKING TRUST, VONORE, TN. FILED 4-20-2007.



OWNER OF U.S. REG. NOS. 2,115,779, 2,297,423 AND 3,204,703.

THE MARK CONSISTS OF THE STYLIZED WORDS JOY OF COOKING ENCLOSED IN A CIRCLE.

FOR FROZEN PREPARED OR PACKAGED SAUCES AND ENTREES CONSISTING OF PASTA, RICE AND NOODLES (U.S. CL. 46).

EVELYN BRADLEY, EXAMINING ATTORNEY

SN 77-162,313. LESSEREVIL BRAND SNACK CO., TUCK-AHOE, NY. FILED 4-20-2007.

STOP BAD SNACKING

THE MARK CONSISTS OF STANDARD CHARACTERS WITHOUT CLAIM TO ANY PARTICULAR FONT, STYLE, SIZE, OR COLOR.

FOR GRANOLA-BASED SNACK BARS; RICE-BASED SNACK FOODS; SNACK MIX CONSISTING PRIMARILY OF CRACKERS, PRETZELS, CANDIED NUTS AND/OR POPPED POPCORN; WHEAT-BASED SNACK FOODS; CEREAL-BASED SNACK FOODS; READY TO EAT, CEREAL DERIVED FOOD BARS; TEA-BASED BEVERAGES WITH FRUIT FLAVORING; COOKIES; CANDY COATED POPCORN; CARAMEL POPCORN; GLAZED POPCORN; MICROWAVE POPCORN; POPCORN; POPPED POPCORN; PROCESSED POPCORN; PROCESSED UNPOPPED POPCORN; UNPOPPED POPCORN (U.S. CL. 46).

SARA THOMAS, EXAMINING ATTORNEY

CLASS 30—(Continued).

SN 77-164,215. AMERICAN DAIRY QUEEN CORPORATION, EDINA, MN. FILED 4-24-2007.

CHILI MELTDOWN

THE MARK CONSISTS OF STANDARD CHARACTERS WITHOUT CLAIM TO ANY PARTICULAR FONT, STYLE, SIZE, OR COLOR.

NO CLAIM IS MADE TO THE EXCLUSIVE RIGHT TO USE "CHILI", APART FROM THE MARK AS SHOWN.

FOR SANDWICHES (U.S. CL. 46).

FIRST USE 9-1-2006; IN COMMERCE 9-1-2006.

MICHELE SWAIN, EXAMINING ATTORNEY

SN 77-164,221. VALENTINO'S OF AMERICA, INC., LINCOLN, NE. FILED 4-24-2007.

ZZAGOS

THE MARK CONSISTS OF STANDARD CHARACTERS WITHOUT CLAIM TO ANY PARTICULAR FONT, STYLE, SIZE, OR COLOR.

FOR DOUGH-BASED POCKETS WITH FILLING CONSISTING PRIMARILY OF MEAT, CHEESE AND SPICES (U.S. CL. 46).

MICHELE SWAIN, EXAMINING ATTORNEY

SN 77-164,988. SUSTAINABLE AGRICO, L.L.C., SANTA FE, NM. FILED 4-25-2007.

ANATOLIA

THE MARK CONSISTS OF STANDARD CHARACTERS WITHOUT CLAIM TO ANY PARTICULAR FONT, STYLE, SIZE, OR COLOR.

FOR ORGANIC CHOCOLATE (U.S. CL. 46).

LANA PHAM, EXAMINING ATTORNEY

CLASS 30—(Continued).

SN 77-165,391. BC&CC FINANCE SA, WAVRE, BELGIUM, FILED 4-25-2007.

BELGIUM'S BEST

THE MARK CONSISTS OF STANDARD CHARACTERS WITHOUT CLAIM TO ANY PARTICULAR FONT, STYLE, SIZE, OR COLOR.

OWNER OF U.S. REG. NO. 2,430,571.
SEC. 2(F).
FOR CHOCOLATE; CANDY MINTS; CANDY (U.S. CL. 46).

FIRST USE 7-1-1988; IN COMMERCE 1-29-1997.
JULIE THOMAS, EXAMINING ATTORNEY

SN 77-176,166. KELLOGG NORTH AMERICA COMPANY, BATTLE CREEK, MI. FILED 5-9-2007.

PRETZEMS

THE MARK CONSISTS OF STANDARD CHARACTERS WITHOUT CLAIM TO ANY PARTICULAR FONT, STYLE, SIZE, OR COLOR.

FOR CRACKERS (U.S. CL. 46).
JOHN WILKE, EXAMINING ATTORNEY

SN 77-176,766. SCHWAN'S IP, LLC, MARSHALL, MN. FILED 5-9-2007.

FRESCHETTA PIZZAMORE

THE MARK CONSISTS OF STANDARD CHARACTERS WITHOUT CLAIM TO ANY PARTICULAR FONT, STYLE, SIZE, OR COLOR.

OWNER OF U.S. REG. NOS. 2,114,646, 2,173,137 AND OTHERS.
FOR BREAD STICKS (U.S. CL. 46).
GISELLE AGOSTO, EXAMINING ATTORNEY

CLASS 30—(Continued).

SN 77-176,774. SCHWAN'S IP, LLC, MARSHALL, MN. FILED 5-9-2007.

PIZZAMORE

THE MARK CONSISTS OF STANDARD CHARACTERS WITHOUT CLAIM TO ANY PARTICULAR FONT, STYLE, SIZE, OR COLOR.

FOR BREAD STICKS; PIZZA (U.S. CL. 46).
GISELLE AGOSTO, EXAMINING ATTORNEY

SN 77-177,579. BRANDMARK, LLC, LAKELAND, TN. FILED 5-10-2007.

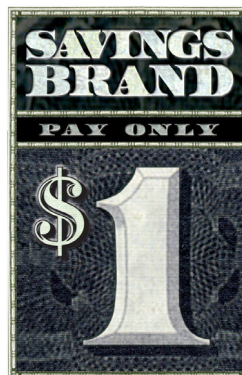

NO CLAIM IS MADE TO THE EXCLUSIVE RIGHT TO USE "BRAND" AND "PAY ONLY \$1", APART FROM THE MARK AS SHOWN.

THE MARK CONSISTS OF THE WORDS "SAVINGS BRAND PAY ONLY \$1" INSIDE OF A RECTANGLE WITH THE WORDS "SAVINGS BRAND" ON TOP, THE WORDS "PAY ONLY" IN THE MIDDLE, AND THE "\$1" UNDERNEATH.

FOR COFFEE; COFFEE BEANS; GROUND COFFEE BEANS; ARTIFICIAL COFFEE OR VEGETABLE PREPARATIONS FOR USE AS COFFEE; GRAIN- OR CHICORY-BASED COFFEE SUBSTITUTES; ESPRESSO; TEA; TEA EXTRACTS; HERBAL TEA FOR FOOD PURPOSES; TEA SUBSTITUTES; FRUIT TEAS; TEA-BASED BEVERAGES; MIXES IN THE NATURE OF CONCENTRATES, SYRUPS OR POWDERS USED IN THE PREPARATION OF TEA-BASED BEVERAGES; COCOA; PREPARED COCOA AND COCOA-BASED BEVERAGES; COCOA MIXES; COCOA EXTRACTS; CHOCOLATE FOOD BEVERAGES NOT BEING DAIRY-BASED OR VEGETABLE-BASED; SUGAR; RICE; HONEY; BAKING POWDER; WHEAT FLOUR; FLOUR; BREAKFAST CEREALS; BREAD; BAKERY PRODUCTS; CAKES; MUFFINS; PUDDINGS; COOKIES; TARTS; PIES; DESSERT MOUSSES; CUSTARDS; ICE CREAM AND FROZEN CONFECTIONS; SALT; KETCHUP; MUSTARD; MAYONNAISE; PICKLE RELISH; SALAD DRESSINGS; PASTA; VINEGAR; SAUCES; MARINADES; SPICES; WAFFLES; FROZEN YOGURT; SHERBET; POPCORN; PASTRIES; BISCUITS; BUTTER BISCUITS; BROWNIES; BUNS; BONBONS; BUBBLE GUM; CANDY; CHOCOLATE AND CHOCOLATE CANDIES; CHOCOLATE FOOD BEVERAGES NOT BEING DAIRY-BASED OR VEGETABLE-BASED; CARAMELS; CANDY WITH COCOA; GRANOLA-BASED SNACK BARS; READY-TO-EAT, CEREAL-DERIVED FOOD BARS (U.S. CL. 46).

MICHAEL WEBSTER, EXAMINING ATTORNEY

CLASS 30—(Continued).

SN 77-181,033. CHOPRA ENTERPRISES, LLC, CARLSBAD, CA. FILED 5-15-2007.

CHOPRA CENTER

THE MARK CONSISTS OF STANDARD CHARACTERS WITHOUT CLAIM TO ANY PARTICULAR FONT, STYLE, SIZE, OR COLOR.

OWNER OF U.S. REG. NOS. 2,202,591, 2,215,788 AND 3,173,576.

FOR TEA; HERBAL TEA; BAKING SPICES; SPICE BLENDS; SPICES; FLAVOURINGS OF TEA (U.S. CL. 46).
LANA PHAM, EXAMINING ATTORNEY

CLASS 30—(Continued).

SN 77-188,026. PIZZA HUT, INC., DALLAS, TX. FILED 5-23-2007.



SN 77-182,413. THE KROGER CO. OF MICHIGAN, LIVONIA, MI. FILED 5-16-2007.

ACTIVE LIFESTYLE

THE MARK CONSISTS OF STANDARD CHARACTERS WITHOUT CLAIM TO ANY PARTICULAR FONT, STYLE, SIZE, OR COLOR.

OWNER OF U.S. REG. NO. 3,234,765.

FOR BREAD (U.S. CL. 46).

CHERYL CLAYTON, EXAMINING ATTORNEY

NO CLAIM IS MADE TO THE EXCLUSIVE RIGHT TO USE "TUSCANI PASTAS", APART FROM THE MARK AS SHOWN.

THE COLOR(S) BLACK, BURGUNDY, RUST, YELLOW, BURNT ORANGE IS/ARE CLAIMED AS A FEATURE OF THE MARK.

THE MARK CONSISTS OF THE WORDS TUSCANI IN BLACK AND PASTAS IN BURGUNDY AND YELLOW, OVER A BLACK WAVY LINE, WHICH IS ALL INSIDE A BURNT ORANGE, YELLOW AND RUST COLORED SUNFLOWER.

FOR PREPARED PASTA ENTREES FOR CONSUMPTION ON AND OFF THE PREMISES (U.S. CL. 46).

TAMARA FRAZIER, EXAMINING ATTORNEY

SN 77-190,363. UNILEVER SUPPLY CHAIN, INC., CLINTON, CT. FILED 5-25-2007.

SN 77-187,323. KELLOGG NORTH AMERICA COMPANY, BATTLE CREEK, MI. FILED 5-22-2007.

FLIPSIDES

THE MARK CONSISTS OF STANDARD CHARACTERS WITHOUT CLAIM TO ANY PARTICULAR FONT, STYLE, SIZE, OR COLOR.

FOR CRACKERS (U.S. CL. 46).

JOHN WILKE, EXAMINING ATTORNEY

HONEY MUSTARD BUZZ

THE MARK CONSISTS OF STANDARD CHARACTERS WITHOUT CLAIM TO ANY PARTICULAR FONT, STYLE, SIZE, OR COLOR.

NO CLAIM IS MADE TO THE EXCLUSIVE RIGHT TO USE "HONEY MUSTARD", APART FROM THE MARK AS SHOWN.

FOR SALAD DRESSINGS (U.S. CL. 46).

WILLIAM P. SHANAHAN, EXAMINING ATTORNEY

CLASS 30—(Continued).

SN 77-193,763. WARNER BROS. ENTERTAINMENT INC., BURBANK, CA. FILED 5-30-2007.

THE WIZARDING WORLD OF
HARRY POTTER

THE MARK CONSISTS OF STANDARD CHARACTERS WITHOUT CLAIM TO ANY PARTICULAR FONT, STYLE, SIZE, OR COLOR.

OWNER OF U.S. REG. NOS. 2,450,788, 2,525,908 AND OTHERS.

FOR COOKIES, BASES FOR MAKING MILKSHAKES, BREAKFAST CEREAL, BUBBLE GUM, CAKE DECORATIONS MADE OF CANDY, CHEWING GUM, FROZEN CONFECTIONS, CRACKERS, FROZEN YOGURT, ICE CREAM, PRETZELS, PEANUT BUTTER CONFECTIONERY CHIPS, MALT FOR FOOD; SOYBEAN MALT; MALT BISCUITS; SUGAR CONFECTIONERY, NAMELY, CANDY, CANDY BARS, CANDY MINTS, CANDY COATED AND CARAMEL POPCORN, AND CANDY DECORATIONS FOR CAKES; EDIBLE DECORATIONS FOR CAKE; RICE CAKES; PASTILLES; PASTRIES; BISCUITS AND BREAD; COCOA BEVERAGES WITH MILK, CHOCOLATE-BASED BEVERAGES, COCOA AND COCOA-BASED BEVERAGES (U.S. CL. 46).

JEFFERY COWARD, EXAMINING ATTORNEY

SN 77-196,483. FUENTE MARKETING LTD., TORTOLA, BR.VIRGIN ISLANDS, FILED 6-4-2007.



OWNER OF U.S. REG. NOS. 2,347,248, 3,146,101 AND OTHERS.

THE MARK CONSISTS OF A LARGE LETTER "O" CONTAINING THE LETTERS "FF" INTERTWINED WITH A LARGE CENTRAL LETTER "X" OVER THE "O".

FOR COFFEE (U.S. CL. 46).
VIVIAN MICZNIK FIRST, EXAMINING ATTORNEY

CLASS 30—(Continued).

SN 77-211,508. TWANG, INC., SAN ANTONIO, TX. FILED 6-21-2007.

KID-TASTIC

THE MARK CONSISTS OF STANDARD CHARACTERS WITHOUT CLAIM TO ANY PARTICULAR FONT, STYLE, SIZE, OR COLOR.

FOR CEREAL-BASED, RICE-BASED AND WHEAT-BASED SNACK FOODS; CANDY, CHEWING GUM, AND BUBBLE GUM (U.S. CL. 46).

NATALIE POLZER, EXAMINING ATTORNEY

SN 78-171,991. SCHWAN'S IP, LLC, MARSHALL, MN. FILED 10-8-2002.

FRESCHETTA BRICK OVEN

OWNER OF U.S. REG. NOS. 2,114,646, 2,173,137 AND 2,307,630.

NO CLAIM IS MADE TO THE EXCLUSIVE RIGHT TO USE "BRICK OVEN", APART FROM THE MARK AS SHOWN.

FOR FROZEN PIZZA (U.S. CL. 46).

FIRST USE 3-8-2003; IN COMMERCE 3-24-2003.

JOHN GARTNER, EXAMINING ATTORNEY

SN 78-329,980. KHEE SAN FOOD INDUSTRIES SDN. BHD., 43300 SELANGOR DARUL EHSAN, MALAYSIA, FILED 11-19-2003.

KEYSONS

THE MARK CONSISTS OF STANDARD CHARACTERS WITHOUT CLAIM TO ANY PARTICULAR FONT, STYLE, SIZE, OR COLOR.

PRIORITY CLAIMED UNDER SEC. 44(D) ON MALAYSIA APPLICATION NO. 2003-06058, FILED 5-23-2003, REG. NO. 03006058, DATED 6-21-2006, EXPIRES 5-23-2013.

FOR CONFECTIONERY, NAMELY, WAFERS, CANDY, CHEWING GUM AND SWEETMEATS (U.S. CL. 46).

CAROLYN CATALDO, EXAMINING ATTORNEY

CLASS 30—(Continued).

SN 78-628,844. KIM SENG COMPANY, CITY OF COMMERCE, CA. FILED 5-12-2005.

SUPER.Q

THE MARK CONSISTS OF STANDARD CHARACTERS WITHOUT CLAIM TO ANY PARTICULAR FONT, STYLE, SIZE, OR COLOR.

FOR SAUCES, SOY SAUCE, VEGETARIAN SOY SAUCE, BEAN SAUCE, VEGETARIAN BEAN SAUCE, FISH SAUCE, VEGETARIAN FISH SAUCE, CHILI SAUCE, SEASONING, VEGETABLE SEASONING (U.S. CL. 46).

FIRST USE 9-15-1994; IN COMMERCE 9-15-1994.
BARBARA RUTLAND, EXAMINING ATTORNEY

SN 78-653,438. NONG SHIM CO., LTD., SEOUL, REPUBLIC OF KOREA, FILED 6-17-2005.



OWNER OF U.S. REG. NOS. 2,025,278, 2,674,488 AND 2,685,792.

NO CLAIM IS MADE TO THE EXCLUSIVE RIGHT TO USE "ANSUNG TANGMYUN" AND THE NON-LATIN CHINESE AND KOREAN CHARACTERS BOTH MEANING ANSUNG NOODLE SOUP, APART FROM THE MARK AS SHOWN.

THE COLOR(S) RED, BLACK, WHITE, YELLOW AND FUCHSIA IS/ARE CLAIMED AS A FEATURE OF THE MARK.

THE MARK CONSISTS OF A RED CIRCULAR SYMBOL CONTAINING A CENTRALLY LOCATED WHITE COLORED TEARDROP, THE WORDS NONG SHIM, TWO SETS OF NON-LATIN CHARACTERS, AND THE WORD ANSUNG TANGMYUN. THE WORDS NONG SHIM ARE IN BLACK PRINT AND APPEAR HORIZONTALLY TO THE RIGHT OF THE RED AND WHITE SYMBOL. BELOW THE SYMBOL AND THE WORDS NONG SHIM IS A YELLOW BORDERED OVAL CONTAINING THE TWO SETS OF

CLASS 30—(Continued).

NON-LATIN CHARACTERS. THE FIRST SET OF NON-LATIN CHARACTERS ARE IN LARGE BLACK PRINT AND HAVE A YELLOW BORDER. THESE CHARACTERS ARE SET ACROSS THE ENTIRE STRETCH OF THE YELLOW BORDERED OVAL. IMMEDIATELY BELOW AND TOWARDS THE CENTRAL RIGHT AREA OF THE OVAL IS A SECOND SET OF SMALL NON-LATIN CHARACTERS APPEARING IN FUCHSIA COLORED PRINT. OUTSIDE AND BELOW THE OVAL YELLOW BORDER IS THE WORD ANSUNG TANGMYUN IN BLACK PRINT.

THE FOREIGN WORDING IN THE MARK, NONG SHIM, TRANSLATES INTO ENGLISH AS AGRICULTURAL ESSENCE. THE FOREIGN WORDING IN THE MARK, ANSUNG TANGMYUN, TRANSLATES INTO ENGLISH AS ANSUNG NOODLE SOUP.

THE NON-LATIN CHINESE CHARACTERS IN THE MARK TRANSLITERATE TO ANSUNG TANGMYUN AND THIS MEANS ANSUNG NOODLE SOUP IN ENGLISH. THE NON-LATIN KOREAN CHARACTERS IN THE MARK TRANSLITERATE TO ANSUNG TANGMYUN AND THIS MEANS ANSUNG NOODLE SOUP IN ENGLISH.

FOR UNCOOKED NOODLES, RAMYUN INSTANT NOODLES, PACKAGED INSTANT NOODLES, PASTA, CHINESE NOODLES, PROCESSED NOODLES, VERMICELLI NOODLES (U.S. CL. 46).

FIRST USE 7-30-2001; IN COMMERCE 7-30-2001.
AMY GEARIN, EXAMINING ATTORNEY

SN 78-696,325. BOULDER HOMEMADE, INC., BOULDER, CO. FILED 8-19-2005.



NO CLAIM IS MADE TO THE EXCLUSIVE RIGHT TO USE "ALL NATURAL" AND "ICE CREAM", APART FROM THE MARK AS SHOWN.

SEC. 2(F) AS TO "BOULDER ICE CREAM".

FOR ICE CREAM, GELATO, SORBETS, SHERBETS, ALL MADE WITH NATURAL INGREDIENTS (U.S. CL. 46).

FIRST USE 6-1-2003; IN COMMERCE 8-1-2003.
PAUL E. FAHRENKOPF, EXAMINING ATTORNEY

SN 78-792,184. HARDEE'S FOOD SYSTEMS, INC., ST. LOUIS, MO. FILED 1-16-2006.

THICKBURGERS

THE MARK CONSISTS OF STANDARD CHARACTERS WITHOUT CLAIM TO ANY PARTICULAR FONT, STYLE, SIZE, OR COLOR.

OWNER OF U.S. REG. NO. 3,026,394.

SEC. 2(F).

FOR HAMBURGER SANDWICHES (U.S. CL. 46).

FIRST USE 9-1-2002; IN COMMERCE 10-24-2002.

BILL DAWE, EXAMINING ATTORNEY

CLASS 30—(Continued).

SN 78-817,070. AB MAURI FOOD INC., SAN FRANCISCO, CA. FILED 2-16-2006.



OWNER OF U.S. REG. NOS. 1,868,501, 2,234,716 AND 2,234,774.

NO CLAIM IS MADE TO THE EXCLUSIVE RIGHT TO USE "YEAST", APART FROM THE MARK AS SHOWN. THE MARK CONSISTS OF THE WORDS "BAKER'S", "FLEISCHMANN'S YEAST" AND "SELECT" AND A "SWOOP" DEVICE INSIDE OF A CIRCLE. SEC. 2(F) AS TO "BAKER'S" AND "SELECT". FOR YEAST (U.S. CL. 46). PAUL CROWLEY, EXAMINING ATTORNEY

CLASS 30—(Continued).

SN 78-941,681. DIAMOND BAKERY COMPANY, LTD., HONOLULU, HI. FILED 7-31-2006.



NO CLAIM IS MADE TO THE EXCLUSIVE RIGHT TO USE "HAWAIIAN ANIMAL COOKIES", APART FROM THE MARK AS SHOWN.

THE MARK CONSISTS OF THE WORDS HAWAIIAN ANIMAL COOKIES FRAMED WITHIN A BANNER HAVING WAVY SIDE EDGES AND DROPLETS PROJECTING FROM EACH SIDE THEREOF.

FOR COOKIES; CRACKERS (U.S. CL. 46). FIRST USE 4-19-2004; IN COMMERCE 4-19-2004. STANLEY I. OSBORNE, EXAMINING ATTORNEY

SN 78-856,986. SOCIEDAD AGRICOLA E INDUSTRIAL SAN CARLOS S.A., GUAYAQUIL, ECUADOR, FILED 4-7-2006.

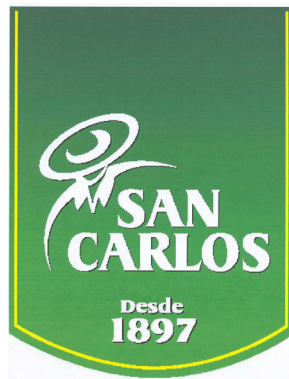

NO CLAIM IS MADE TO THE EXCLUSIVE RIGHT TO USE "DESDE 1897", APART FROM THE MARK AS SHOWN. THE COLOR(S) WHITE, GREEN AND YELLOW IS/ARE CLAIMED AS A FEATURE OF THE MARK.

THE STYLIZED HUMAN FIGURE AND THE WORDING IN THE MARK ARE WHITE, THE BACKGROUND IS GREEN, AND THE LINING INSIDE THE BACKGROUND IS YELLOW.

THE ENGLISH TRANSLATION OF "DESDE" IS "SINCE." FOR SUGAR, POWDERED SUGAR AND CONFECTION SUGAR (U.S. CL. 46). FIRST USE 8-25-1996; IN COMMERCE 8-25-1996. ALICE SUE CARRUTHERS, EXAMINING ATTORNEY

SN 79-020,935. VALORA HOLDING AG, SWITZERLAND, FILED 12-22-2005.

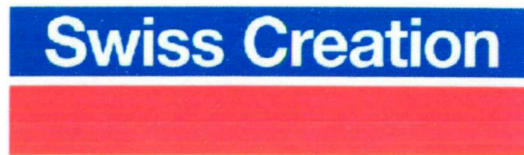

PRIORITY DATE OF 8-19-2005 IS CLAIMED. OWNER OF INTERNATIONAL REGISTRATION 0877067 DATED 12-22-2005, EXPIRES 12-22-2015.

NO CLAIM IS MADE TO THE EXCLUSIVE RIGHT TO USE "SWISS", APART FROM THE MARK AS SHOWN. THE COLOR(S) RED, BLUE, WHITE IS/ARE CLAIMED AS A FEATURE OF THE MARK.

THE MARK CONSISTS OF THE COLOR BLUE APPEARING IN THE UPPERMOST RECTANGLE, THE COLOR RED APPEARING IN THE LOWER MOST RECTANGLE; THE TWO RECTANGLES ARE DIVIDED AND SURROUNDED BY WHITE BORDERS AND THE WORDING IS WHITE.

FOR BREAD, PASTRY AND CONFECTIONERY, NAMELY, SWEET AND SAVORY PUFF PASTRY PRODUCTS, SNACKS MADE PRIMARILY WITH FLOUR, NAMELY, PRETZELS, SALT PRETZEL STICKS; PROCESSED CEREAL, MUESLI, RUSKS, CRISP BREADS, CEREAL-BASED SNACKS, NAMELY, FILLED AND UNFILLED CRACKERS; ALL THE ABOVE PRODUCTS OF SWISS ORIGIN (U.S. CL. 46).

LINDA MICKLEBURGH, EXAMINING ATTORNEY

CLASS 30—(Continued).

SN 79-037,585. SHANGHAI LIANGYOU GROUP CO., LTD., CHINA, FILED 4-10-2007.

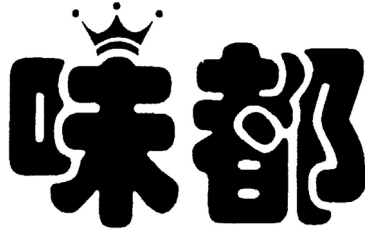

OWNER OF INTERNATIONAL REGISTRATION 0921701 DATED 4-10-2007, EXPIRES 4-10-2017.

THE MARK CONSISTS OF TWO CHINESE CHARACTERS; THERE IS A CROWN OVER THE FIRST CHARACTER.

THE ENGLISH TRANSLATION OF THE FOREIGN WORD(S) IN THE MARK IS: THE TWO WORDS IN THIS MARK MEAN RESPECTIVELY "TASTE" AND "CAPITAL"; AND THE COMBINATION OF THE TWO WORDS HAS NO OTHER ACTUAL MEANING.

THE TRANSLITERATION OF THE NON-LATIN CHARACTERS IN THE MARK IS: WEI DU.

FOR NOODLES; FINE DRIED NOODLES; INSTANT NOODLE; WHEAT FLOUR (U.S. CL. 46).
 MARIAM MAHMOUDI, EXAMINING ATTORNEY

CLASS 31—NATURAL AGRICULTURAL PRODUCTS

SN 77-037,542. SMITH, DENNIS P., FALLBROOK, CA. FILED 11-6-2006.

SILVER SWAN OLIVE

THE MARK CONSISTS OF STANDARD CHARACTERS WITHOUT CLAIM TO ANY PARTICULAR FONT, STYLE, SIZE, OR COLOR.

NO CLAIM IS MADE TO THE EXCLUSIVE RIGHT TO USE "OLIVE", APART FROM THE MARK AS SHOWN.

FOR CONTAINER GROWN OLIVE TREES (U.S. CLS. 1 AND 46).
 INGRID C. EULIN, EXAMINING ATTORNEY

CLASS 31—(Continued).

SN 77-055,967. AOVATECHNOLOGIES, MADISON, WI. FILED 12-3-2006.

BIG BIRD

THE MARK CONSISTS OF STANDARD CHARACTERS WITHOUT CLAIM TO ANY PARTICULAR FONT, STYLE, SIZE, OR COLOR.

NO CLAIM IS MADE TO THE EXCLUSIVE RIGHT TO USE "BIRD", APART FROM THE MARK AS SHOWN.

FOR ANIMAL FEED SUPPLEMENTS FOR AGRICULTURAL USE (U.S. CLS. 1 AND 46).
 ERIN FALK, EXAMINING ATTORNEY

SN 77-055,968. AOVATECHNOLOGIES, MADISON, WI. FILED 12-3-2006.

BIG PIG

THE MARK CONSISTS OF STANDARD CHARACTERS WITHOUT CLAIM TO ANY PARTICULAR FONT, STYLE, SIZE, OR COLOR.

NO CLAIM IS MADE TO THE EXCLUSIVE RIGHT TO USE "PIG", APART FROM THE MARK AS SHOWN.

FOR ANIMAL FEED SUPPLEMENTS FOR AGRICULTURAL USE (U.S. CLS. 1 AND 46).
 ERIN FALK, EXAMINING ATTORNEY

SN 77-055,970. AOVATECHNOLOGIES, MADISON, WI. FILED 12-3-2006.

BIG FISH

THE MARK CONSISTS OF STANDARD CHARACTERS WITHOUT CLAIM TO ANY PARTICULAR FONT, STYLE, SIZE, OR COLOR.

NO CLAIM IS MADE TO THE EXCLUSIVE RIGHT TO USE "FISH", APART FROM THE MARK AS SHOWN.

FOR ANIMAL FEED SUPPLEMENTS FOR AGRICULTURAL USE (U.S. CLS. 1 AND 46).
 ERIN FALK, EXAMINING ATTORNEY

CLASS 31—(Continued).

SN 77-055,972. AOVATECHNOLOGIES, MADISON, WI.
FILED 12-3-2006.

BIG BEEF

THE MARK CONSISTS OF STANDARD CHARACTERS WITHOUT CLAIM TO ANY PARTICULAR FONT, STYLE, SIZE, OR COLOR.

NO CLAIM IS MADE TO THE EXCLUSIVE RIGHT TO USE "BEEF", APART FROM THE MARK AS SHOWN.

FOR ANIMAL FEED SUPPLEMENTS FOR AGRICULTURAL USE (U.S. CLS. 1 AND 46).

ERIN FALK, EXAMINING ATTORNEY

CLASS 31—(Continued).

SN 77-125,510. BLUE RIVER ORGANIC SEEDS, LLC, AMES, IA. FILED 3-8-2007.

BLUE RIVER

THE MARK CONSISTS OF STANDARD CHARACTERS WITHOUT CLAIM TO ANY PARTICULAR FONT, STYLE, SIZE, OR COLOR.

FOR SEEDS FOR AGRICULTURAL PURPOSES, NAMELY, ORGANIC SUNDANGRASS, CORN, SOYBEANS, ALFALFA, RED CLOVER, GRAIN SORGHUM (U.S. CLS. 1 AND 46).

FIRST USE 1-0-2006; IN COMMERCE 2-2-2006.
DAVID ELTON, EXAMINING ATTORNEY

SN 77-076,184. KDW ENTERPRISES, ELK GROVE, CA.
FILED 1-4-2007.



NO CLAIM IS MADE TO THE EXCLUSIVE RIGHT TO USE "HORSE", APART FROM THE MARK AS SHOWN.

THE MARK CONSISTS OF A GRAPHIC IMAGE OF THE HEAD OF A HORSE ALONG WITH THE TERMS "HEALTHY HORSE".

FOR EDIBLE HORSE TREATS; FOOD FOR ANIMALS (U.S. CLS. 1 AND 46).

DAYNA BROWNE, EXAMINING ATTORNEY

SN 77-144,927. POET INVESTMENTS, INC., SIOUX FALLS, SD. FILED 3-30-2007.

Dakota Bran

THE MARK CONSISTS OF STANDARD CHARACTERS WITHOUT CLAIM TO ANY PARTICULAR FONT, STYLE, SIZE, OR COLOR.

OWNER OF U.S. REG. NO. 1,994,116.

NO CLAIM IS MADE TO THE EXCLUSIVE RIGHT TO USE "BRAN", APART FROM THE MARK AS SHOWN.

FOR FEED FOR ANIMALS (U.S. CLS. 1 AND 46).

FIRST USE 4-0-2005; IN COMMERCE 4-0-2005.

PATRICIA EVANKO, EXAMINING ATTORNEY

SN 77-101,912. ARTEMIS PET FOOD CO., INC., NORTH HOLLYWOOD, CA. FILED 2-7-2007.

ARTEMIS

THE MARK CONSISTS OF STANDARD CHARACTERS WITHOUT CLAIM TO ANY PARTICULAR FONT, STYLE, SIZE, OR COLOR.

FOR PET FOOD (U.S. CLS. 1 AND 46).

FIRST USE 8-3-2000; IN COMMERCE 8-3-2000.

DANNEAN HETZEL, EXAMINING ATTORNEY

SN 77-152,014. SADDLEBACK MATERIALS COMPANY INC, LAKE FOREST, CA. FILED 4-9-2007.



OWNER OF U.S. REG. NOS. 2,359,655 AND 2,399,316.
THE COLOR(S) DARK GREEN AND LIGHT GREEN IS/ARE CLAIMED AS A FEATURE OF THE MARK.

THE MARK CONSISTS OF LARGE CASE DARK GREEN 4, CAPITAL LIGHT GREEN LETTERS SOD, DARK GREEN PERIOD, SMALL CASE DARK GREEN COM, ALL LETTERING IS CENTERED ON TOP OF LIGHT AND DARK GREEN GRASS.

FOR SOD (U.S. CLS. 1 AND 46).

CAROLINE WOOD, EXAMINING ATTORNEY

CLASS 31—(Continued).

SN 77-155,008. IFA NURSERIES, INC., CANBY, OR. FILED 4-12-2007.

LEGACY

THE MARK CONSISTS OF STANDARD CHARACTERS WITHOUT CLAIM TO ANY PARTICULAR FONT, STYLE, SIZE, OR COLOR.

FOR SEEDLINGS (U.S. CLS. 1 AND 46).
FIRST USE 10-24-2004; IN COMMERCE 12-17-2004.
MARLENE BELL, EXAMINING ATTORNEY

SN 77-155,649. BARENBRUG USA, INC., TANGENT, OR. FILED 4-12-2007.

PRIMERO FORAGE

THE MARK CONSISTS OF STANDARD CHARACTERS WITHOUT CLAIM TO ANY PARTICULAR FONT, STYLE, SIZE, OR COLOR.

NO CLAIM IS MADE TO THE EXCLUSIVE RIGHT TO USE "FORAGE", APART FROM THE MARK AS SHOWN.

THE FOREIGN WORDING IN THE MARK TRANSLATES INTO ENGLISH AS FIRST.

FOR BERMUDA GRASS SEED BLEND (U.S. CLS. 1 AND 46).
KATHERINE CONNOLLY, EXAMINING ATTORNEY

SN 77-156,349. FOUR B CORP., KANSAS CITY, KS. FILED 4-13-2007.

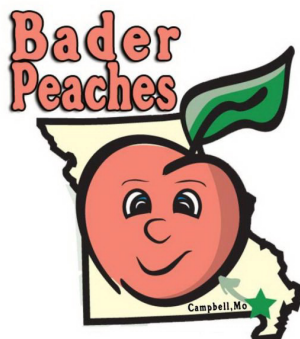

NO CLAIM IS MADE TO THE EXCLUSIVE RIGHT TO USE "PEACHES" AND "CAMPBELL, MO", APART FROM THE MARK AS SHOWN.

THE COLOR(S) ORANGE, BLACK, GREEN, YELLOW, BLUE AND WHITE IS/ARE CLAIMED AS A FEATURE OF THE MARK.

THE COLOR ORANGE APPEARS IN THE PEACH, AND

CLASS 31—(Continued).

IN THE WORDING "BADER PEACHES." THE COLOR GREEN APPEARS IN THE LEAF, STAR, AND ARROW. THE COLOR YELLOW APPEARS IN THE MAP OF MISSOURI. THE COLOR BLUE APPEARS IN THE PEACH'S IRISES. THE COLOR BLACK APPEARS IN THE PEACH'S PUPILS, EYEBROWS, NOSE, MOUTH, AND STEM, AS WELL AS IN THE OUTLINING OF ALL ELEMENTS IN THE MARK, AND IN THE WORDING "CAMPBELL, MO". THE COLOR WHITE APPEARS IN THE SCLERA OF THE PEACH'S EYES.

FOR RAW FRUITS (U.S. CLS. 1 AND 46).
JASON BLAIR, EXAMINING ATTORNEY

SN 77-157,178. AQUASCAPE DESIGNS, INC., ST. CHARLES, IL. FILED 4-16-2007.

KOI BALANCE

THE MARK CONSISTS OF STANDARD CHARACTERS WITHOUT CLAIM TO ANY PARTICULAR FONT, STYLE, SIZE, OR COLOR.

NO CLAIM IS MADE TO THE EXCLUSIVE RIGHT TO USE "KOI", APART FROM THE MARK AS SHOWN.

FOR FISH FOOD (U.S. CLS. 1 AND 46).
FIRST USE 9-15-2005; IN COMMERCE 9-15-2005.
CHRIS WELLS, EXAMINING ATTORNEY

SN 77-158,871. RUFF LIFE, LLC, DALLAS, TX. FILED 4-17-2007.

GURRRLATO

THE MARK CONSISTS OF STANDARD CHARACTERS WITHOUT CLAIM TO ANY PARTICULAR FONT, STYLE, SIZE, OR COLOR.

FOR PET BEVERAGES; PET FOOD; EDIBLE CAT TREATS; EDIBLE DOG TREATS; EDIBLE CHEWS FOR ANIMALS; ANIMAL FOODSTUFFS; CAT FOOD; DOG FOOD; DOG BISCUITS (U.S. CLS. 1 AND 46).

MARY CRAWFORD, EXAMINING ATTORNEY

SN 77-159,141. AGRILIANCE LLC, INVER GROVE HEIGHTS, MN. FILED 4-18-2007.

VOYAGER

THE MARK CONSISTS OF STANDARD CHARACTERS WITHOUT CLAIM TO ANY PARTICULAR FONT, STYLE, SIZE, OR COLOR.

OWNER OF U.S. REG. NO. 2,286,570.
FOR GRASS SEED (U.S. CLS. 1 AND 46).
FIRST USE 9-5-2006; IN COMMERCE 9-5-2006.
RAUL CORDOVA, EXAMINING ATTORNEY

CLASS 31—(Continued).

SN 77-160,289. FINNEY, CARRIE, SOUTH CHARLESTON, OH. FILED 4-19-2007.

GREEN ACRES PET BAKERY

THE MARK CONSISTS OF STANDARD CHARACTERS WITHOUT CLAIM TO ANY PARTICULAR FONT, STYLE, SIZE, OR COLOR.

NO CLAIM IS MADE TO THE EXCLUSIVE RIGHT TO USE "PET BAKERY", APART FROM THE MARK AS SHOWN.

FOR PET FOOD: PET TREATS (U.S. CLS. 1 AND 46).
CARYN GLASSER, EXAMINING ATTORNEY

CLASS 31—(Continued).

SN 77-186,314. KLN ENTERPRISES, INC., PERHAM, MN. FILED 5-21-2007.

NATURAL PLANET

THE MARK CONSISTS OF STANDARD CHARACTERS WITHOUT CLAIM TO ANY PARTICULAR FONT, STYLE, SIZE, OR COLOR.

FOR PET FOOD (U.S. CLS. 1 AND 46).
FIRST USE 5-9-2007; IN COMMERCE 5-9-2007.
FRANK LATTUCA, EXAMINING ATTORNEY

SN 77-162,275. FARMING TURTLES, INC. WARWICK, RI. FILED 4-20-2007.

PET SALAD

THE MARK CONSISTS OF STANDARD CHARACTERS WITHOUT CLAIM TO ANY PARTICULAR FONT, STYLE, SIZE, OR COLOR.

NO CLAIM IS MADE TO THE EXCLUSIVE RIGHT TO USE "PET", APART FROM THE MARK AS SHOWN.

FOR PET TREATS (U.S. CLS. 1 AND 46).
FIRST USE 3-7-2005; IN COMMERCE 4-22-2005.
RENEE SERVANCE, EXAMINING ATTORNEY

SN 77-190,089. MARS, INCORPORATED, MCLEAN, VA. FILED 5-24-2007.

APPLE MEDLEYS

THE MARK CONSISTS OF STANDARD CHARACTERS WITHOUT CLAIM TO ANY PARTICULAR FONT, STYLE, SIZE, OR COLOR.

NO CLAIM IS MADE TO THE EXCLUSIVE RIGHT TO USE "APPLE", APART FROM THE MARK AS SHOWN.

FOR PET TREATS (U.S. CLS. 1 AND 46).
DOMINICK J. SALEMI, EXAMINING ATTORNEY

SN 77-164,235. CHAN, EMILY E., LOS ANGELES, CA. FILED 4-24-2007.



THE MARK CONSISTS OF HUMAN HAND FORMING THE SHAPE OF A DOG'S HEAD.

FOR PET FOOD AND TREATS (U.S. CLS. 1 AND 46).
MARK T. MULLEN, EXAMINING ATTORNEY

SN 77-190,107. MARS, INCORPORATED, MCLEAN, VA. FILED 5-24-2007.

CARROT MEDLEYS

THE MARK CONSISTS OF STANDARD CHARACTERS WITHOUT CLAIM TO ANY PARTICULAR FONT, STYLE, SIZE, OR COLOR.

NO CLAIM IS MADE TO THE EXCLUSIVE RIGHT TO USE "CARROT", APART FROM THE MARK AS SHOWN.

FOR PET TREATS (U.S. CLS. 1 AND 46).
DOMINICK J. SALEMI, EXAMINING ATTORNEY

CLASS 31—(Continued).

SN 77-195,109. SMALL SEED COMPANY, LLC, BATESVILLE, IN. FILED 6-1-2007.

WALHILL FARM

THE MARK CONSISTS OF STANDARD CHARACTERS WITHOUT CLAIM TO ANY PARTICULAR FONT, STYLE, SIZE, OR COLOR.

NO CLAIM IS MADE TO THE EXCLUSIVE RIGHT TO USE "FARM", APART FROM THE MARK AS SHOWN. FOR FRESH VEGETABLES; FRESH FRUITS (U.S. CLS. 1 AND 46).

MELVIN AXILBUND, EXAMINING ATTORNEY

SN 77-202,513. LAFEVER, TED, ST. CHARLES, IL. FILED 6-11-2007.

TASTE OF THE TROPICS

THE MARK CONSISTS OF STANDARD CHARACTERS WITHOUT CLAIM TO ANY PARTICULAR FONT, STYLE, SIZE, OR COLOR.

FOR PET FOOD (U.S. CLS. 1 AND 46).
HEATHER SAPP, EXAMINING ATTORNEY

SN 77-202,517. LAFEVER, TED, ST. CHARLES, IL. FILED 6-11-2007.

BOUNTIFUL HARVEST

THE MARK CONSISTS OF STANDARD CHARACTERS WITHOUT CLAIM TO ANY PARTICULAR FONT, STYLE, SIZE, OR COLOR.

FOR PET FOOD (U.S. CLS. 1 AND 46).
HEATHER SAPP, EXAMINING ATTORNEY

CLASS 31—(Continued).

SN 78-947,177. CHAMBERS, PAUL D, TONOPAH, AZ. FILED 8-8-2006.



NO CLAIM IS MADE TO THE EXCLUSIVE RIGHT TO USE "AUSTRALIAN OUTBACK PLANTS", APART FROM THE MARK AS SHOWN.

THE APPLICANT CLAIMS COLOR AS A FEATURE OF THE MARK, NAMELY, GREEN, LIGHT GREEN, BLUE, GREY, PURPLE, BLACK, WHITE.

THE MARK CONSISTS OF A GREEN MAP OF AUSTRALIA WITH BLUE OUTLINE, A GREY KANGAROO STANDING IN GREEN GRASS OVER THE MAP, A TREE WITH A WHITE TRUNK AND GREEN LEAVES AND BLACK BRANCHES OVER THE MAP, PURPLE MOUNTAINS BEHIND THE BASE OF THE TREE, GREEN LITERAL CONTENT "AUSTRALIAN OUTBACK PLANTS" TO THE RIGHT OF AUSTRALIAN MAP WITH SLIGHT OVERLAP.

FOR LIVE PLANTS; LIVE TREES (U.S. CLS. 1 AND 46).
FIRST USE 9-15-2000; IN COMMERCE 4-30-2004.
GEOFFREY FOSDICK, EXAMINING ATTORNEY

SN 78-960,568. NGUYEN, HOANG HAI, RENTON, WA. FILED 8-25-2006.



NO CLAIM IS MADE TO THE EXCLUSIVE RIGHT TO USE "DOG TREATS", APART FROM THE MARK AS SHOWN.

THE COLOR(S) RED, BLUE, BLACK, YELLOW, CREAM AND WHITE IS/ARE CLAIMED AS A FEATURE OF THE MARK.

THE MARK CONSISTS OF THE LITERAL ELEMENTS "LULU'S DOG TREATS" WITH ASSOCIATED DESIGN ELEMENTS. THE DESIGN IS A FANCIFUL IMAGE OF A DOG HOLDING A BONE IN ITS MOUTH, AND FIVE TRIANGULAR SHAPED DESIGNS APPEAR ABOVE THE DOG'S HEAD. THE DOG'S COAT APPEARS IN THE COLOR RED, HIS EYES AND NOSE APPEAR IN THE COLORS WHITE AND BLACK, AND HIS EYEBROWS APPEAR IN THE COLOR BLACK. THE BONE APPEARS IN THE COLOR YELLOW. THE TRIANGULAR SHAPES APPEAR IN THE COLOR BLUE. THE LITERAL ELEMENT APPEARS BELOW THE DOG DESIGN WITH THE TERM "LULU'S" APPEARING IN THE COLOR RED, BORDERED BY BLACK, AND SHADOWED BY WHITE, AND THE LITERAL ELEMENTS "DOG TREATS" APPEARING IN THE COLOR BLACK. THE MARK IS BORDERED BY A RECTANGULAR CARRIER WITH RUFFLED EDGES APPEARING IN THE COLOR BLACK AND THE BACKGROUND APPEARS IN THE COLOR CREAM.

FOR CONSUMABLE PET CHEWS; DOG BISCUITS; DOG FOOD; DOG TREATS ; PET FOOD; PET TREATS (U.S. CLS. 1 AND 46).

JUDITH HELFMAN, EXAMINING ATTORNEY

CLASS 31—(Continued).

SN 78-963,229. HORTECH, INC., SPRING LAKE, MI. FILED 8-29-2006.

CLASSIC RED BRICK MIX

THE MARK CONSISTS OF STANDARD CHARACTERS WITHOUT CLAIM TO ANY PARTICULAR FONT, STYLE, SIZE, OR COLOR.

NO CLAIM IS MADE TO THE EXCLUSIVE RIGHT TO USE "MIX", APART FROM THE MARK AS SHOWN. FOR LIVING PLANTS (U.S. CLS. 1 AND 46). LINDA ORNDORFF, EXAMINING ATTORNEY

CLASS 32—(Continued).

SN 77-023,508. OS ASSET, INC., TAMPA, FL. FILED 10-18-2006.

PARADISE BEACH ALE

THE MARK CONSISTS OF STANDARD CHARACTERS WITHOUT CLAIM TO ANY PARTICULAR FONT, STYLE, SIZE, OR COLOR.

NO CLAIM IS MADE TO THE EXCLUSIVE RIGHT TO USE "ALE", APART FROM THE MARK AS SHOWN. FOR BEER (U.S. CLS. 45, 46 AND 48). WANDA KAY PRICE, EXAMINING ATTORNEY

SN 77-036,854. ATTUNE FOODS, INC., SAN FRANCISCO, CA. FILED 11-3-2006.

CLASS 32—LIGHT BEVERAGES

SN 77-008,343. BOSCA S.P.A., CANELLI (ASTI), ITALY, FILED 9-27-2006.

SPARKLETINI

THE MARK CONSISTS OF STANDARD CHARACTERS WITHOUT CLAIM TO ANY PARTICULAR FONT, STYLE, SIZE, OR COLOR.

FOR NON-ALCOHOLIC BEVERAGES, NAMELY FRUIT JUICES, MALT BEVERAGES (U.S. CLS. 45, 46 AND 48).

ZACHARY BELLO, EXAMINING ATTORNEY



NO CLAIM IS MADE TO THE EXCLUSIVE RIGHT TO USE "PROBIOTICS", APART FROM THE MARK AS SHOWN.

THE MARK CONSISTS OF "PROBIOTICS GOOD FOR LIFE!" FORMING A HALF CIRCLE OVER A FIGURE OF A HUMAN; A SPIRAL.

FOR CONCENTRATES, SYRUPS OR POWDERS USED IN THE PREPARATION OF SOFT DRINKS (U.S. CLS. 45, 46 AND 48).

ROBERT STRUCK, EXAMINING ATTORNEY

SN 77-009,123. MARIETTA OPHTHALMOLOGY ASSOCIATES, INC., MARIETTA, OH. FILED 9-27-2006.

.COM BRANDS

THE MARK CONSISTS OF STANDARD CHARACTERS WITHOUT CLAIM TO ANY PARTICULAR FONT, STYLE, SIZE, OR COLOR.

NO CLAIM IS MADE TO THE EXCLUSIVE RIGHT TO USE "BRANDS", APART FROM THE MARK AS SHOWN.

FOR SOFT DRINKS, SOFT DRINK MIX, SYRUPS, POWDERS AND CONCENTRATES FOR USE IN THE PREPARATION OF SOFT DRINKS, WATER, ENERGY DRINKS, AND NON-CARBONATED SOFT DRINKS (U.S. CLS. 45, 46 AND 48).

JAMES A. RAUEN, EXAMINING ATTORNEY

SN 77-076,687. NAKED JUICE CO. OF GLENDORA, INC., AZUSA, CA. FILED 1-5-2007.

ORANGE MANGO MOTION

THE MARK CONSISTS OF STANDARD CHARACTERS WITHOUT CLAIM TO ANY PARTICULAR FONT, STYLE, SIZE, OR COLOR.

NO CLAIM IS MADE TO THE EXCLUSIVE RIGHT TO USE "ORANGE MANGO", APART FROM THE MARK AS SHOWN.

FOR FRUIT AND VEGETABLE JUICES, JUICE DRINKS AND FRUIT FLAVORED WATERS (U.S. CLS. 45, 46 AND 48).

FIRST USE 4-1-2006; IN COMMERCE 4-1-2006.

ELI HELLMAN, EXAMINING ATTORNEY

CLASS 32—(Continued).

SN 77-084,542. PRILABS INC., BROOKLYN, NY. FILED 1-17-2007.

MONSOON

THE MARK CONSISTS OF STANDARD CHARACTERS WITHOUT CLAIM TO ANY PARTICULAR FONT, STYLE, SIZE, OR COLOR.

FOR ENERGY DRINKS (U.S. CLS. 45, 46 AND 48).
BARBARA GAYNOR, EXAMINING ATTORNEY

SN 77-088,278. RAYMOND A. GRIESEDIECK, DES PERES, MO. FILED 1-22-2007.

GRIESEDIECK BROS.

THE MARK CONSISTS OF STANDARD CHARACTERS WITHOUT CLAIM TO ANY PARTICULAR FONT, STYLE, SIZE, OR COLOR.

SEC. 2(F).
FOR BEER (U.S. CLS. 45, 46 AND 48).
FIRST USE 6-25-2002; IN COMMERCE 6-25-2002.
HENRY S. ZAK, EXAMINING ATTORNEY

SN 77-105,301. REGGAETON BEVERAGE & DISTRIBUTORS, INC., MIAMI, FL. FILED 2-12-2007.



THE MARK CONSISTS OF A FROG WITH A HAT IN A RUNNING POSITION ON TOP OF THE LETTER "I" IN THE WORD "REDI".

FOR CARBONATED WATER, SODA WATER, SODA POP, FRUIT JUICES, ENERGY DRINKS, SPORTS DRINKS (U.S. CLS. 45, 46 AND 48).

FIRST USE 3-29-2007; IN COMMERCE 3-29-2007.
AMY BROZENIC, EXAMINING ATTORNEY

CLASS 32—(Continued).

SN 77-127,944. HITE USA, INC., RANCHO DOMINGUEZ, CA. FILED 3-12-2007.

MIGAVE

THE MARK CONSISTS OF STANDARD CHARACTERS WITHOUT CLAIM TO ANY PARTICULAR FONT, STYLE, SIZE, OR COLOR.

FOR NON-ALCOHOLIC HONEY BASED BEVERAGES; FRUIT BASED DRINKS AND JUICES; VEGETABLE BASED DRINKS AND JUICES (U.S. CLS. 45, 46 AND 48).
AMY MCMENAMIN, EXAMINING ATTORNEY

SN 77-138,145. NEW GLARUS BREWING COMPANY, NEW GLARUS, WI. FILED 3-22-2007.

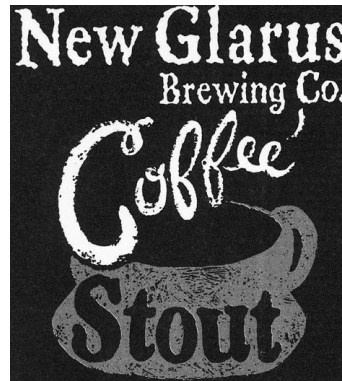

OWNER OF U.S. REG. NOS. 3,226,953, 3,239,035 AND OTHERS.

NO CLAIM IS MADE TO THE EXCLUSIVE RIGHT TO USE "NEW GLARUS BREWING CO.," "COFFEE," AND "STOUT", APART FROM THE MARK AS SHOWN.

THE MARK CONSISTS OF THE WORDS "NEW GLARUS BREWING CO. COFFEE STOUT" AND A COFFEE MUG.

FOR BEER (U.S. CLS. 45, 46 AND 48).
FIRST USE 8-7-1997; IN COMMERCE 4-6-1998.
TONI HICKEY, EXAMINING ATTORNEY

CLASS 32—(Continued).

SN 77-138,543. NEW GLARUS BREWING COMPANY, NEW GLARUS, WI. FILED 3-23-2007.



OWNER OF U.S. REG. NOS. 3,226,953, 3,239,035 AND OTHERS.

NO CLAIM IS MADE TO THE EXCLUSIVE RIGHT TO USE "NEW GLARUS BREWING CO.," "EDEL-PILS," AND "BEER", APART FROM THE MARK AS SHOWN.

THE MARK CONSISTS OF THE WORDS "NEW GLARUS BREWING CO. EDEL-PILS" AND "BEER" AND A PICTURE OF WHEAT, BARLEY, AND HOPS.

THE ENGLISH TRANSLATION OF EDEL-PILS IS NOBLE-PILSNER.

FOR BEER (U.S. CLS. 45, 46 AND 48).
FIRST USE 10-1-1993; IN COMMERCE 1-1-1994.
TONI HICKEY, EXAMINING ATTORNEY

CLASS 32—(Continued).

SN 77-146,134. JEFF GORDON, INC., CHARLOTTE, NC. FILED 4-2-2007.

JEFF GORDON

THE MARK CONSISTS OF STANDARD CHARACTERS WITHOUT CLAIM TO ANY PARTICULAR FONT, STYLE, SIZE, OR COLOR.

OWNER OF U.S. REG. NOS. 1,964,012 AND 3,040,770.

THE NAME(S), PORTRAIT(S), AND/OR SIGNATURE(S) SHOWN IN THE MARK IDENTIFIES JEFF GORDON, WHOSE CONSENT(S) TO REGISTER IS SUBMITTED.

FOR ENERGY DRINKS (U.S. CLS. 45, 46 AND 48).

FIRST USE 4-10-2007; IN COMMERCE 4-10-2007.
ROBERT LAVACHE, EXAMINING ATTORNEY

SN 77-153,837. MARTINELLIE, INC., SAN JOSE, CA. FILED 4-11-2007.

ANTIGRAVITY

THE MARK CONSISTS OF STANDARD CHARACTERS WITHOUT CLAIM TO ANY PARTICULAR FONT, STYLE, SIZE, OR COLOR.

FOR NON-ALCOHOLIC BEVERAGES, NAMELY, CARBONATED BEVERAGES; SPORTS DRINKS (U.S. CLS. 45, 46 AND 48).

MORENO, PAUL, EXAMINING ATTORNEY

SN 77-139,285. NEW GLARUS BREWING COMPANY, NEW GLARUS, WI. FILED 3-23-2007.



SN 77-153,867. MARTINELLIE, INC., SAN JOSE, CA. FILED 4-11-2007.

ANTIGRAVITY BIOHAZARD

OWNER OF U.S. REG. NOS. 3,221,812, 3,236,185 AND OTHERS.

NO CLAIM IS MADE TO THE EXCLUSIVE RIGHT TO USE "NEW GLARUS BREWING CO.," "ZWICKEL," AND "BEER", APART FROM THE MARK AS SHOWN.

THE MARK CONSISTS OF THE WORDS "NEW GLARUS BREWING CO. ZWICKEL BEER" AND A PICTURE OF A BARREL OF BEER AND LEAVES.

THE ENGLISH TRANSLATION OF ZWICKEL IS GUSSET.
FOR BEER (U.S. CLS. 45, 46 AND 48).
FIRST USE 10-27-1993; IN COMMERCE 1-1-1994.
TONI HICKEY, EXAMINING ATTORNEY

THE MARK CONSISTS OF STANDARD CHARACTERS WITHOUT CLAIM TO ANY PARTICULAR FONT, STYLE, SIZE, OR COLOR.

FOR NON-ALCOHOLIC BEVERAGES, NAMELY, CARBONATED BEVERAGES; SPORTS DRINKS (U.S. CLS. 45, 46 AND 48).

MORENO, PAUL, EXAMINING ATTORNEY

CLASS 32—(Continued).

SN 77-153,889. MARTINELLIE, INC., SAN JOSE, CA. FILED 4-11-2007.

ANTIGRAVITY MAGIC DRAGON

THE MARK CONSISTS OF STANDARD CHARACTERS WITHOUT CLAIM TO ANY PARTICULAR FONT, STYLE, SIZE, OR COLOR.

FOR NON-ALCOHOLIC BEVERAGES, NAMELY, CARBONATED BEVERAGES; SPORTS DRINKS (U.S. CLS. 45, 46 AND 48).

MORENO, PAUL, EXAMINING ATTORNEY

SN 77-153,900. MARTINELLIE, INC., SAN JOSE, CA. FILED 4-11-2007.

ANTIGRAVITY MAGIC ANTIVENOM

THE MARK CONSISTS OF STANDARD CHARACTERS WITHOUT CLAIM TO ANY PARTICULAR FONT, STYLE, SIZE, OR COLOR.

FOR NON-ALCOHOLIC BEVERAGES, NAMELY, CARBONATED BEVERAGES; SPORTS DRINKS (U.S. CLS. 45, 46 AND 48).

MORENO, PAUL, EXAMINING ATTORNEY

SN 77-153,912. MARTINELLIE, INC., SAN JOSE, CA. FILED 4-11-2007.

ANTIGRAVITY MAGIC ECSTASY

THE MARK CONSISTS OF STANDARD CHARACTERS WITHOUT CLAIM TO ANY PARTICULAR FONT, STYLE, SIZE, OR COLOR.

FOR NON-ALCOHOLIC BEVERAGES, NAMELY, CARBONATED BEVERAGES; SPORTS DRINKS (U.S. CLS. 45, 46 AND 48).

MORENO, PAUL, EXAMINING ATTORNEY

CLASS 32—(Continued).

SN 77-155,466. MARSICO, ROBERT, LAS VEGAS, NV. AND MARSICO, MARILYN, LAS VEGAS, NV. FILED 4-12-2007.

BRANCH

THE MARK CONSISTS OF STANDARD CHARACTERS WITHOUT CLAIM TO ANY PARTICULAR FONT, STYLE, SIZE, OR COLOR.

FOR DRINKING WATER (U.S. CLS. 45, 46 AND 48).
AMY MCMENAMIN, EXAMINING ATTORNEY

SN 77-155,842. PEPSICO, INC., PURCHASE, NY. FILED 4-13-2007.

THE COLOR(S) BLUE AND GRAY IS/ARE CLAIMED AS A FEATURE OF THE MARK.

THE MARK CONSISTS OF THE WORDS PREMIUM GOOD IN STYLIZED LETTERS. THE WORD PREMIUM IS BLUE; THE WORD GOOD IS GRAY.

FOR SOFT DRINKS (U.S. CLS. 45, 46 AND 48).
BRIAN CALLAGHAN, EXAMINING ATTORNEY

SN 77-156,886. ERICKSON, BEAU GEORGE, SAINT PAUL, MN. FILED 4-14-2007.

Truth Water
& Bottling Co.

THE MARK CONSISTS OF STANDARD CHARACTERS WITHOUT CLAIM TO ANY PARTICULAR FONT, STYLE, SIZE, OR COLOR.

NO CLAIM IS MADE TO THE EXCLUSIVE RIGHT TO USE "WATER & BOTTLING CO.", APART FROM THE MARK AS SHOWN.

FOR BOTTLED WATER (U.S. CLS. 45, 46 AND 48).
JOHN GARTNER, EXAMINING ATTORNEY

CLASS 32—(Continued).

SN 77-156,941. LAURENCE SCOTT FOX, TACOMA, WA. AND SHARON LYNN FOX, TACOMA, WA. FILED 4-14-2007.

Spear

THE MARK CONSISTS OF STANDARD CHARACTERS WITHOUT CLAIM TO ANY PARTICULAR FONT, STYLE, SIZE, OR COLOR.

FOR SPORTS DRINKS, NAMELY, ENERGY DRINKS (U.S. CLS. 45, 46 AND 48).

ANGELA M. MICHELI, EXAMINING ATTORNEY



SN 77-157,143. ZAK IV, ZAN JOHN, HEMET, CA. FILED 4-16-2007.

Zak

THE MARK CONSISTS OF STANDARD CHARACTERS WITHOUT CLAIM TO ANY PARTICULAR FONT, STYLE, SIZE, OR COLOR.

FOR BREWED MALT-BASED ALCOHOLIC BEVERAGE IN THE NATURE OF A BEER (U.S. CLS. 45, 46 AND 48).

ANDREA BUTLER, EXAMINING ATTORNEY



SN 77-157,287. GREEN PLANET, INC., LOS ANGELES, CA. FILED 4-16-2007.

TOP FLIGHT ENERGY DRINK

THE MARK CONSISTS OF STANDARD CHARACTERS WITHOUT CLAIM TO ANY PARTICULAR FONT, STYLE, SIZE, OR COLOR.

NO CLAIM IS MADE TO THE EXCLUSIVE RIGHT TO USE "ENERGY DRINK", APART FROM THE MARK AS SHOWN.

FOR ENERGY DRINKS (U.S. CLS. 45, 46 AND 48).
BRENDAN REGAN, EXAMINING ATTORNEY

CLASS 32—(Continued).

SN 77-157,845. TAYLOR, GERAD DANIEL IRVING, GREY-TOWN, NEW ZEALAND, FILED 4-16-2007.

Aquasip

THE MARK CONSISTS OF STANDARD CHARACTERS WITHOUT CLAIM TO ANY PARTICULAR FONT, STYLE, SIZE, OR COLOR.

FOR AERATED WATER; AERATED WATER; ALOE VERA DRINKS; BOTTLED ARTESIAN WATER; BOTTLED DRINKING WATER; BOTTLED WATER; COCONUT WATER; COFFEE-FLAVORED SOFT DRINK; COLAS; CONCENTRATES, SYRUPS OR POWDERS USED IN THE PREPARATION OF SOFT DRINKS; DISTILLED DRINKING WATER; DRINKING WATER; ENERGY DRINKS; ESSENCES FOR THE PREPARATION OF MINERAL WATERS; ESSENCES FOR USE IN MAKING SOFT DRINKS; FLAVORED WATERS; FLAVOURED WATERS; FRUIT DRINKS; FRUIT FLAVORED SOFT DRINKS; FRUIT-BASED SOFT DRINKS FLAVORED WITH TEA; FRUIT-FLAVORED DRINKS; GLACIAL WATER; GUARANA DRINKS; ISOTONIC DRINKS; LITHIA WATER; MINERAL WATER; POP; QUININE WATER; SCENTED WATER FOR MAKING BEVERAGES; SELTZER WATER; SODA WATER; SOFT DRINKS; SOFT DRINKS FLAVORED WITH TEA; SPARKLING WATER; SPORTS DRINKS; SPRING WATER; STILL WATER; STILL WATERS; TABLE WATER (U.S. CLS. 45, 46 AND 48).

REBECCA SMITH, EXAMINING ATTORNEY



SN 77-158,520. TERRABODY, INC., ALPHARETTA, GA. FILED 4-17-2007.

What's In Your Body?

THE MARK CONSISTS OF STANDARD CHARACTERS WITHOUT CLAIM TO ANY PARTICULAR FONT, STYLE, SIZE, OR COLOR.

FOR NON-ALCOHOLIC BEVERAGES CONTAINING FRUIT JUICES (U.S. CLS. 45, 46 AND 48).

JASON ROTH, EXAMINING ATTORNEY



SN 77-158,528. TERRABODY, INC., ALPHARETTA, GA. FILED 4-17-2007.

Sweat the Details

THE MARK CONSISTS OF STANDARD CHARACTERS WITHOUT CLAIM TO ANY PARTICULAR FONT, STYLE, SIZE, OR COLOR.

FOR NON-ALCOHOLIC BEVERAGES CONTAINING FRUIT JUICES (U.S. CLS. 45, 46 AND 48).

JASON ROTH, EXAMINING ATTORNEY

CLASS 32—(Continued).

SN 77-159,298. SUNKIST GROWERS, INC., SHERMAN OAKS, CA. FILED 4-18-2007.

ORANGE NATION

THE MARK CONSISTS OF STANDARD CHARACTERS WITHOUT CLAIM TO ANY PARTICULAR FONT, STYLE, SIZE, OR COLOR.

NO CLAIM IS MADE TO THE EXCLUSIVE RIGHT TO USE "ORANGE", APART FROM THE MARK AS SHOWN. FOR SOFT DRINKS (U.S. CLS. 45, 46 AND 48). MICHELE SWAIN, EXAMINING ATTORNEY

CLASS 32—(Continued).

SN 77-159,818. COORS GLOBAL PROPERTIES, INC., GOLDEN, CO. FILED 4-18-2007.



SN 77-159,667. BEVERAGE MARKETING USA, INC., WHITE PLAINS, NY. FILED 4-18-2007.

ALL CITY

THE MARK CONSISTS OF STANDARD CHARACTERS WITHOUT CLAIM TO ANY PARTICULAR FONT, STYLE, SIZE, OR COLOR.

FOR ENERGY DRINKS (U.S. CLS. 45, 46 AND 48). CAROLINE WOOD, EXAMINING ATTORNEY

OWNER OF U.S. REG. NO. 3,119,888.
FOR BEER (U.S. CLS. 45, 46 AND 48).
FIRST USE 0-0-1995; IN COMMERCE 0-0-1995.
MIDGE BUTLER, EXAMINING ATTORNEY

SN 77-159,822. COORS GLOBAL PROPERTIES, INC., GOLDEN, CO. FILED 4-18-2007.

SN 77-159,742. ENERGY BRANDS INC., DBA GLACEAU, WHITESTONE, NY. FILED 4-18-2007.

VITAMINENERGY

THE MARK CONSISTS OF STANDARD CHARACTERS WITHOUT CLAIM TO ANY PARTICULAR FONT, STYLE, SIZE, OR COLOR.

FOR ENERGY DRINKS (U.S. CLS. 45, 46 AND 48). SAMUEL E. SHARPER JR., EXAMINING ATTORNEY



OWNER OF U.S. REG. NO. 3,119,888.
FOR BEER (U.S. CLS. 45, 46 AND 48).
FIRST USE 0-0-1995; IN COMMERCE 0-0-1995.
MIDGE BUTLER, EXAMINING ATTORNEY

CLASS 32—(Continued).

SN 77-160,535. COORS GLOBAL PROPERTIES, INC., GOLD-EN, CO. FILED 4-19-2007.

REFRESCA TU MUNDO

THE MARK CONSISTS OF STANDARD CHARACTERS WITHOUT CLAIM TO ANY PARTICULAR FONT, STYLE, SIZE, OR COLOR.

THE FOREIGN WORDING IN THE MARK TRANSLATES INTO ENGLISH AS REFRESH YOUR WORLD. FOR BEER (U.S. CLS. 45, 46 AND 48). FIRST USE 3-20-2007; IN COMMERCE 3-20-2007. MIDGE BUTLER, EXAMINING ATTORNEY

SN 77-160,607. GERIKOURIAN, ANDRE, GLENDALE, CA. FILED 4-19-2007.

GET FRESH

THE MARK CONSISTS OF STANDARD CHARACTERS WITHOUT CLAIM TO ANY PARTICULAR FONT, STYLE, SIZE, OR COLOR.

FOR BOTTLED WATER (U.S. CLS. 45, 46 AND 48). LINDA ESTRADA, EXAMINING ATTORNEY

SN 77-160,776. ENERGY BRANDS INC., DBA GLACEAU, WHITESTONE, NY. FILED 4-19-2007.

THE WATER WITH ALL THE ANSWERS

THE MARK CONSISTS OF STANDARD CHARACTERS WITHOUT CLAIM TO ANY PARTICULAR FONT, STYLE, SIZE, OR COLOR.

FOR BOTTLED WATER (U.S. CLS. 45, 46 AND 48). SAMUEL E. SHARPER JR., EXAMINING ATTORNEY

CLASS 32—(Continued).

SN 77-161,100. FRUITISTIC, PATERSON, NJ. FILED 4-19-2007.

VITANEA

THE MARK CONSISTS OF STANDARD CHARACTERS WITHOUT CLAIM TO ANY PARTICULAR FONT, STYLE, SIZE, OR COLOR.

FOR FRUIT JUICES (U.S. CLS. 45, 46 AND 48). FIRST USE 6-0-2005; IN COMMERCE 1-0-2007. GEORGE LORENZO, EXAMINING ATTORNEY

SN 77-162,203. THE JOY OF COOKING TRUST, VONORE, TN. FILED 4-20-2007.



OWNER OF U.S. REG. NOS. 2,115,779, 3,204,703 AND OTHERS.

THE MARK CONSISTS OF THE STYLIZED WORDS JOY OF COOKING ENCLOSED IN A CIRCLE.

FOR NON-ALCOHOLIC BEVERAGES, NAMELY CARBONATED BEVERAGES, FRUIT JUICES; SOFT DRINKS; AND FRUIT-BASED SOFT DRINKS AND DRINKING WATER (U.S. CLS. 45, 46 AND 48).

EVELYN BRADLEY, EXAMINING ATTORNEY

SN 77-164,245. LEONARD GEORGE HOROWITZ, PAHOA, HI. FILED 4-24-2007.

BREATH OF THE EARTH

THE MARK CONSISTS OF STANDARD CHARACTERS WITHOUT CLAIM TO ANY PARTICULAR FONT, STYLE, SIZE, OR COLOR.

FOR DISTILLED DRINKING WATER (U.S. CLS. 45, 46 AND 48).

FIRST USE 5-30-2004; IN COMMERCE 2-28-2007. SHANNON TWOHIG, EXAMINING ATTORNEY

CLASS 32—(Continued).

SN 77-166,283. CHARITY H2O, LLC, LAS VEGAS, NV. FILED 4-26-2007.

SAVING LIVES ONE BOTTLE AT
A TIME

THE MARK CONSISTS OF STANDARD CHARACTERS WITHOUT CLAIM TO ANY PARTICULAR FONT, STYLE, SIZE, OR COLOR.

FOR BOTTLED DRINKING WATER (U.S. CLS. 45, 46 AND 48).

FIRST USE 11-7-2006; IN COMMERCE 11-7-2006.
JOHN WILKE, EXAMINING ATTORNEY

SN 77-166,434. ENERGY BRANDS INC., DBA GLACEAU, WHITESTONE, NY. FILED 4-26-2007.

HOW SMART IS THAT?

THE MARK CONSISTS OF STANDARD CHARACTERS WITHOUT CLAIM TO ANY PARTICULAR FONT, STYLE, SIZE, OR COLOR.

FOR BOTTLED WATER (U.S. CLS. 45, 46 AND 48).
SAMUEL E. SHARPER JR., EXAMINING ATTORNEY

SN 77-168,632. ROGERS, BRUCE A., PHILADELPHIA, PA. FILED 4-30-2007.

Liquid Whole

THE MARK CONSISTS OF STANDARD CHARACTERS WITHOUT CLAIM TO ANY PARTICULAR FONT, STYLE, SIZE, OR COLOR.

FOR AERATED FRUIT JUICES; FROZEN FRUIT BEVERAGES; FROZEN FRUIT-BASED BEVERAGES; FRUIT BEVERAGES; FRUIT CONCENTRATES AND PUREES USED AS INGREDIENTS OF BEVERAGES; FRUIT DRINKS; FRUIT FLAVORED SOFT DRINKS; FRUIT JUICE BASES; FRUIT JUICE CONCENTRATES; FRUIT JUICES; FRUIT JUICES, NAMELY, THOSE INCLUDING VEGETABLE JUICE; FRUIT NECTARS; FRUIT PUNCH; FRUIT-BASED SOFT DRINKS FLAVORED WITH TEA; FRUIT-FLAVORED BEVERAGES; FRUIT-FLAVORED DRINKS; FRUIT-FLAVOURED BEVERAGES; ICED FRUIT BEVERAGES; NON-ALCOHOLIC BEVERAGES CONTAINING FRUIT JUICES; NON-ALCOHOLIC FRUIT EXTRACTS USED IN THE PREPARATION OF BEVERAGES; NON-ALCOHOLIC FRUIT JUICE BEVERAGES; PREPARATIONS FOR MAKING LIQUID PUREES; SYRUPS FOR MAKING LIQUID PUREES; APPLE JUICE BEVERAGES; BREWED MALT-BASED ALCOHOLIC BEVERAGE IN THE NATURE OF A BEER; CORN-BASED BEVERAGES NOT FOR FOOD PURPOSES (CHICHA MORADA); GRAPE JUICE BEVERAGES; KVASS; MALT SYRUP FOR BEVERAGES; NON-ALCOHOLIC BEVERAGES WITH TEA FLAVOR; NON-ALCOHOLIC BEVERAGES, NAMELY, CARBO-

CLASS 32—(Continued).

NATED BEVERAGES; NON-ALCOHOLIC HONEY-BASED BEVERAGES; NON-ALCOHOLIC MALT BEVERAGE; NON-CARBONATED, NON-ALCOHOLIC FROZEN FLAVORED BEVERAGES; ORANGE JUICE BEVERAGES; PINEAPPLE JUICE BEVERAGES; SARSAPARILLA; SCENTED WATER FOR MAKING BEVERAGES; SHERBETS; SMOOTHIES; SORBETS IN THE FORM OF BEVERAGES; SOY-BASED BEVERAGES NOT BEING MILK SUBSTITUTES; SYRUPS FOR BEVERAGES; SYRUPS FOR MAKING BEVERAGES; SYRUPS FOR MAKING WHEY-BASED BEVERAGES; TOMATO JUICE; TOMATO JUICE BEVERAGES; VEGETABLE JUICE; VEGETABLE JUICES; WHEY BEVERAGES; ALOE VERA JUICES; HERBAL JUICES; JUICE BASE CONCENTRATES; CONCENTRATES, SYRUPS OR POWDERS USED IN THE PREPARATION OF SOFT DRINKS; SYRUP FOR MAKING LEMONADE; SYRUPS FOR MAKING SOFT DRINKS; AERATED WATER; AERATED WATER; BOTTLED ARTESIAN WATER; BOTTLED DRINKING WATER; BOTTLED WATER; COCONUT WATER; DISTILLED DRINKING WATER; DRINKING WATER; ESSENCES FOR THE PREPARATION OF MINERAL WATERS; FLAVORED WATERS; FLAVOURED WATERS; GLACIAL WATER; LITHIA WATER; MINERAL WATER; QUININE WATER; SELTZER WATER; SODA WATER; SPARKLING WATER; SPRING WATER; STILL WATER; STILL WATERS; TABLE WATER; SOFT DRINKS, NAMELY NON-CARBONATED FRUIT AND/OR VEGETABLE BEVERAGES (U.S. CLS. 45, 46 AND 48).

RAUL CORDOVA, EXAMINING ATTORNEY

SN 77-173,550. COORS GLOBAL PROPERTIES, INC., GOLDEN, CO. FILED 5-4-2007.

PALE MOON LIGHT

THE MARK CONSISTS OF STANDARD CHARACTERS WITHOUT CLAIM TO ANY PARTICULAR FONT, STYLE, SIZE, OR COLOR.

NO CLAIM IS MADE TO THE EXCLUSIVE RIGHT TO USE "LIGHT", APART FROM THE MARK AS SHOWN.

FOR BEER (U.S. CLS. 45, 46 AND 48).
MIDGE BUTLER, EXAMINING ATTORNEY

SN 77-173,561. COORS GLOBAL PROPERTIES, INC., GOLDEN, CO. FILED 5-4-2007.

PALE MOON

THE MARK CONSISTS OF STANDARD CHARACTERS WITHOUT CLAIM TO ANY PARTICULAR FONT, STYLE, SIZE, OR COLOR.

FOR BEER (U.S. CLS. 45, 46 AND 48).
MIDGE BUTLER, EXAMINING ATTORNEY

CLASS 32—(Continued).

SN 77-175,424. ENERGY BRANDS INC., DBA GLACEAU, WHITESTONE, NY. FILED 5-8-2007.

CLASS 32—(Continued).

SN 78-340,438. SHASTA BEVERAGES, INC., HAYWARD, CA. FILED 12-12-2003.

EVERY DAY IS GAME DAY

THE MARK CONSISTS OF STANDARD CHARACTERS WITHOUT CLAIM TO ANY PARTICULAR FONT, STYLE, SIZE, OR COLOR.

FOR NON-ALCOHOLIC BEVERAGES, NAMELY, SPORTS DRINKS (U.S. CLS. 45, 46 AND 48).
SAMUEL E. SHARPER JR., EXAMINING ATTORNEY

SHASTA

SN 77-181,397. BRAUEREI BECK GMBH & CO. KG, BREMEN, FED REP GERMANY, FILED 5-15-2007.

BPL

THE MARK CONSISTS OF STANDARD CHARACTERS WITHOUT CLAIM TO ANY PARTICULAR FONT, STYLE, SIZE, OR COLOR.

FOR BEERS (U.S. CLS. 45, 46 AND 48).
BARBARA GAYNOR, EXAMINING ATTORNEY

THE MARK CONSISTS OF STANDARD CHARACTERS WITHOUT CLAIM TO ANY PARTICULAR FONT, STYLE, SIZE, OR COLOR.

OWNER OF U.S. REG. NOS. 210,723, 875,709 AND OTHERS.
FOR NON-ALCOHOLIC BEVERAGES, NAMELY CARBONATED SOFT DRINKS (U.S. CLS. 45, 46 AND 48).
FIRST USE 12-0-1960; IN COMMERCE 12-0-1960.
CYNTHIA SLOAN, EXAMINING ATTORNEY

SN 77-182,175. WATERMARK INNOVATION LLC, SOUTHAMPTON, NY. FILED 5-16-2007.

What's Your Cool?

THE MARK CONSISTS OF STANDARD CHARACTERS WITHOUT CLAIM TO ANY PARTICULAR FONT, STYLE, SIZE, OR COLOR.

FOR CARBONATED AND NON-CARBONATED FLAVORED WATERS (U.S. CLS. 45, 46 AND 48).
REGINA DRUMMOND, EXAMINING ATTORNEY

SN 78-619,413. LEMON-X CORPORATION, HUNTINGTON STATION, NY. FILED 4-28-2005.

SN 77-196,593. COORS GLOBAL PROPERTIES, INC., GOLDEN, CO. FILED 6-4-2007.

SUN VALLEY

ANY GAME. ALL SEASON. YOU CHOOSE.

THE MARK CONSISTS OF STANDARD CHARACTERS WITHOUT CLAIM TO ANY PARTICULAR FONT, STYLE, SIZE, OR COLOR.

FOR BEER (U.S. CLS. 45, 46 AND 48).
MIDGE BUTLER, EXAMINING ATTORNEY

THE MARK CONSISTS OF STANDARD CHARACTERS WITHOUT CLAIM TO ANY PARTICULAR FONT, STYLE, SIZE, OR COLOR.

FOR FRUIT JUICES (U.S. CLS. 45, 46 AND 48).
ANNE FARRELL, EXAMINING ATTORNEY

CLASS 32—(Continued).

SN 78-859,529. ROBERTS GROUP INC., THE, HUNTSVILLE, AL. FILED 4-12-2006.



NO CLAIM IS MADE TO THE EXCLUSIVE RIGHT TO USE "NATURAL SPRING WATER", APART FROM THE MARK AS SHOWN.

FOR DRINKING WATER; DRINKING WATER IN BOTTLES AND TANKS THAT MAY BE DELIVERED TO USERS FOR USE WITH BASE COOLERS (U.S. CLS. 45, 46 AND 48).

FIRST USE 9-1-2003; IN COMMERCE 9-1-2003.
DAVID YONTEF, EXAMINING ATTORNEY

CLASS 32—(Continued).

SN 78-959,717. S.M. JALEEL & COMPANY LIMITED, SOUTH OROPOUCHE, TRINIDAD/TOBAGO, FILED 8-24-2006.

MAAEE

THE MARK CONSISTS OF STANDARD CHARACTERS WITHOUT CLAIM TO ANY PARTICULAR FONT, STYLE, SIZE, OR COLOR.

THE ENGLISH TRANSLATION OF MAAEE IS "MY WATER".

FOR SOFT DRINKS, FRUIT JUICES, BOTTLED DRINKING WATER, SYRUPS AND CONCENTRATES FOR MAKING FRUIT DRINKS AND SOFT DRINKS, AND NON-ALCOHOLIC CARBONATED FRUIT JUICE DRINKS (U.S. CLS. 45, 46 AND 48).

PATRICIA EVANKO, EXAMINING ATTORNEY

SN 78-960,002. BRANDS AND BEVERAGES INTERNATIONAL LIMITED, CHARLESTOWN, ST.CHRIST-NEVIS, FILED 8-24-2006.

CHUBBY THE KID'S SNACK BEVERAGE

SN 78-893,988. LIQUID OM, LLC, CHICAGO, IL. FILED 5-26-2006.

LIQUID OM

THE MARK CONSISTS OF STANDARD CHARACTERS WITHOUT CLAIM TO ANY PARTICULAR FONT, STYLE, SIZE, OR COLOR.

NO CLAIM IS MADE TO THE EXCLUSIVE RIGHT TO USE "LIQUID", APART FROM THE MARK AS SHOWN.

FOR BOTTLED WATER (U.S. CLS. 45, 46 AND 48).
FIRST USE 10-18-2003; IN COMMERCE 10-18-2003.

DAHLIA GEORGE, EXAMINING ATTORNEY

THE MARK CONSISTS OF STANDARD CHARACTERS WITHOUT CLAIM TO ANY PARTICULAR FONT, STYLE, SIZE, OR COLOR.

OWNER OF U.S. REG. NO. 2,656,131.

NO CLAIM IS MADE TO THE EXCLUSIVE RIGHT TO USE "THE KID'S SNACK BEVERAGE", APART FROM THE MARK AS SHOWN.

FOR SOFT DRINKS, FRUIT JUICES, BOTTLED DRINKING WATER, SYRUPS AND CONCENTRATES FOR MAKING FRUIT DRINKS AND SOFT DRINKS, AND NON-ALCOHOLIC CARBONATED FRUIT JUICE DRINKS (U.S. CLS. 45, 46 AND 48).

BRENDAN REGAN, EXAMINING ATTORNEY

CLASS 32—(Continued).

SN 78-963,013. SHARK USA INCORPORATED, TORRANCE, CA. FILED 8-29-2006.



NO CLAIM IS MADE TO THE EXCLUSIVE RIGHT TO USE "SINCE 1965", APART FROM THE MARK AS SHOWN. FOR CARBONATED AND NON-CARBONATED SOFT DRINKS; ENERGY DRINKS, ENHANCED WITH VITAMINS, MINERALS, NUTRIENTS, AMINO ACIDS, OR HERBS AND AERATED WATER (U.S. CLS. 45, 46 AND 48).

FIRST USE 12-31-2005; IN COMMERCE 12-31-2005.
MARGERY A. TIERNEY, EXAMINING ATTORNEY

SN 79-021,362. AYTAC HANDELS GMBH, AUSTRIA, FILED 1-12-2006.

WILD DRAGON

THE MARK CONSISTS OF STANDARD CHARACTERS WITHOUT CLAIM TO ANY PARTICULAR FONT, STYLE, SIZE, OR COLOR.

OWNER OF INTERNATIONAL REGISTRATION 0878170 DATED 1-12-2006, EXPIRES 1-12-2016.

FOR MINERAL AND AERATED WATER, CARBONATED DRINKS AND SPARKLING BEVERAGES, SYRUPS AND ESSENCES FOR MAKING CARBONATED DRINKS AND SPARKLING BEVERAGES (U.S. CLS. 45, 46 AND 48).

STEVEN R. FINE, EXAMINING ATTORNEY

CLASS 32—(Continued).

SN 79-022,393. BADEL 1862 D.D., CROATIA, FILED 11-8-2005.



OWNER OF INTERNATIONAL REGISTRATION 0881046 DATED 11-8-2005, EXPIRES 11-8-2015.

OWNER OF U.S. REG. NO. 2,805,810.

NO CLAIM IS MADE TO THE EXCLUSIVE RIGHT TO USE "PRIRODNA IZVORSKA VODA" AND "NATURAL SPRING WATER", APART FROM THE MARK AS SHOWN.

THE COLOR(S) GREEN, WHITE AND VIOLET IS/ARE CLAIMED AS A FEATURE OF THE MARK.

"THE MARK CONSISTS OF THE TERMS "UN", "QUE" AND "NATURAL SPRING WATER" IN THE COLOR GREEN, AND "I" AND "PRIRODNA IZVORSKA VODA" IN THE COLOR VIOLET, ALL AGAINST A WHITE AND VIOLET BACKGROUND."

"THE FOREIGN WORDING IN THE MARK TRANSLATES INTO ENGLISH AS NATURAL SPRING WATER."

FOR MINERAL AND CARBONATED WATERS (U.S. CLS. 45, 46 AND 48).

SCOTT BALDWIN, EXAMINING ATTORNEY

SN 79-030,679. TAN MUEY HWA, SINGAPORE, FILED 9-14-2006.

ANYTHING

PRIORITY DATE OF 8-29-2006 IS CLAIMED.

OWNER OF INTERNATIONAL REGISTRATION 0902884 DATED 9-14-2006, EXPIRES 9-14-2016.

FOR MINERAL AND AERATED WATERS AND OTHER NON-ALCOHOLIC DRINKS, NAMELY, CARBONATED AND NON-CARBONATED SOFT DRINKS; BEERS; FRUIT DRINKS AND FRUIT JUICES; SYRUPS FOR MAKING BEVERAGES AND PREPARATIONS FOR MAKING FRUIT DRINKS AND SOFT DRINKS; CONCENTRATES FOR USE IN THE PREPARATION OF SOFT DRINKS; ISOTONIC DRINKS NOT FOR MEDICAL PURPOSES (U.S. CLS. 45, 46 AND 48).

WILLIAM VERHOSEK, EXAMINING ATTORNEY

SN 79-038,069. BRAUEREI BECK GMBH & CO. KG, FED REP GERMANY, FILED 4-20-2007.

LIFE IS WHAT YOU CHOOSE

THE MARK CONSISTS OF STANDARD CHARACTERS WITHOUT CLAIM TO ANY PARTICULAR FONT, STYLE, SIZE, OR COLOR.

PRIORITY DATE OF 10-20-2006 IS CLAIMED.

OWNER OF INTERNATIONAL REGISTRATION 0922973 DATED 4-20-2007, EXPIRES 4-20-2017.

FOR BEERS (U.S. CLS. 45, 46 AND 48).

BARBARA GAYNOR, EXAMINING ATTORNEY

CLASS 32—(Continued).

SN 79-039,125. INBEV S.A.; SOCIÉTÉ ANONYME, BELGIUM, FILED 4-17-2007.

PERFECTION HAS ITS PRICE

THE MARK CONSISTS OF STANDARD CHARACTERS WITHOUT CLAIM TO ANY PARTICULAR FONT, STYLE, SIZE, OR COLOR.

PRIORITY DATE OF 4-13-2007 IS CLAIMED.
OWNER OF INTERNATIONAL REGISTRATION 0925745 DATED 4-17-2007, EXPIRES 4-17-2017.
FOR BEERS (U.S. CLS. 45, 46 AND 48).
VERNA BETH RIRIE, EXAMINING ATTORNEY

CLASS 33—(Continued).

SN 77-010,866. ARMSTRONG VINEYARDS, INC., DBA EPOCH ESTATE WINES, DENVER, CO. FILED 9-29-2006.

EPOCH ESTATE

THE MARK CONSISTS OF STANDARD CHARACTERS WITHOUT CLAIM TO ANY PARTICULAR FONT, STYLE, SIZE, OR COLOR.

NO CLAIM IS MADE TO THE EXCLUSIVE RIGHT TO USE "ESTATE", APART FROM THE MARK AS SHOWN.
FOR WINE (U.S. CLS. 47 AND 49).
RONALD MCMORROW, EXAMINING ATTORNEY

CLASS 33—WINES AND SPIRITS

SN 76-668,243. THREE TIER WINE AND SPIRIT CORP, BRIDGEPORT, CT. FILED 10-30-2006.



NO CLAIM IS MADE TO THE EXCLUSIVE RIGHT TO USE "CHILE" AND "PRODUCT OF CHILE", APART FROM THE MARK AS SHOWN.

THE STIPPLING IS A FEATURE OF THE MARK.
THE LIKENESS (OR, "PORTRAIT") IN THE MARK DOES NOT IDENTIFY A LIVING INDIVIDUAL.
FOR WINE (U.S. CLS. 47 AND 49).

RONALD MCMORROW, EXAMINING ATTORNEY

SN 77-027,066. JACK JOHN INVESTMENTS, INC., LAKE-LAND, FL. FILED 10-23-2006.



THE MARK CONSISTS OF THE WORD JADA SUPERIMPOSED OVER THE FANCIFUL DESIGN OF A TALL VERTICAL VINE

FOR WINES (U.S. CLS. 47 AND 49).
BARBARA A. GOLD, EXAMINING ATTORNEY

SN 77-008,316. BOSCA S.P.A., CANELLI (ASTI), ITALY, FILED 9-27-2006.

SPARKLETINI

THE MARK CONSISTS OF STANDARD CHARACTERS WITHOUT CLAIM TO ANY PARTICULAR FONT, STYLE, SIZE, OR COLOR.

FOR ALCOHOLIC BEVERAGES, NAMELY WINES, SPARKLING WINES, FRUIT WINES, APERITIFS WITH A WINE BASE, SWEET WINES (U.S. CLS. 47 AND 49).
FIRST USE 9-10-2004; IN COMMERCE 9-10-2004.
ZACHARY BELLO, EXAMINING ATTORNEY

SN 77-042,534. WINEHAVEN, INC., CHISAGO CITY, MN. FILED 11-13-2006.



THE MARK CONSISTS OF BEE DESIGN.
FOR WINES, EXCLUDING CABERNET SAUVIGNON AND SAUVIGNON BLANC (U.S. CLS. 47 AND 49).
FIRST USE 5-31-2005; IN COMMERCE 9-30-2005.
KEVIN CORWIN, EXAMINING ATTORNEY

CLASS 33—(Continued).

SN 77-045,630. BLAKE FAMILY VINEYARD LIMITED, HASTINGS, NEW ZEALAND, FILED 11-16-2006.

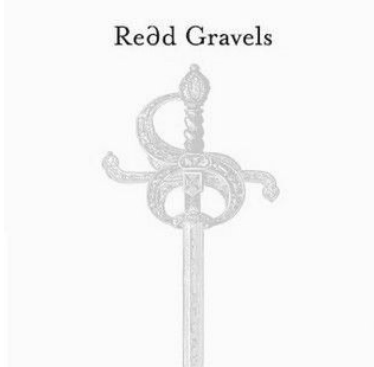

PRIORITY CLAIMED UNDER SEC. 44(D) ON NEW ZEALAND APPLICATION NO. 755696, FILED 9-22-2006, REG. NO. 755696, DATED 9-22-2006, EXPIRES 9-22-2016.

OWNER OF U.S. REG. NO. 3,081,565.
THE MARK CONSISTS OF REDD GRAVELS APPEARING IN DISTINCTIVE TYPEFACE, ABOVE THE DEPICTION OF A HANDLE-END OF A SWORD.
FOR WINE (U.S. CLS. 47 AND 49).
KATHY DE JONGE, EXAMINING ATTORNEY

SN 77-058,474. BACARDI & COMPANY LIMITED, VADUZ, LIECHTENSTEIN, FILED 12-6-2006.



OWNER OF U.S. REG. NOS. 310,654, 3,066,254 AND OTHERS.

NO CLAIM IS MADE TO THE EXCLUSIVE RIGHT TO USE "PEACH RED", APART FROM THE MARK AS SHOWN.

THE APPLICANT CLAIMS COLOR AS A FEATURE OF THE MARK, NAMELY, BLACK, RED, PEACH AND GOLD.
"THE MARK CONSISTS OF THE WORDS BACARDI PEACH RED IN BLACK AND OUTLINED IN PEACH AND GOLD ABOVE CONCENTRIC GOLD, PEACH, GOLD AND RED OVALS IN THE SHAPE OF A STYLIZED PEACH. BENEATH THE STYLIZED PEACH ARE A SERIES OF MEDALS IN THE COLOR GOLD."

FOR ALCOHOLIC BEVERAGES, EXCEPT BEERS, NAMELY PEACH FLAVORED RUM (U.S. CLS. 47 AND 49).

JAMES LOVELACE, EXAMINING ATTORNEY

CLASS 33—(Continued).

SN 77-116,462. CHATEAU DIANA LLC, HEALDSBURG, CA. FILED 2-26-2007.

LE BARON RANCH

THE MARK CONSISTS OF STANDARD CHARACTERS WITHOUT CLAIM TO ANY PARTICULAR FONT, STYLE, SIZE, OR COLOR.

NO CLAIM IS MADE TO THE EXCLUSIVE RIGHT TO USE "RANCH", APART FROM THE MARK AS SHOWN.
FOR WINES (U.S. CLS. 47 AND 49).
TARAH HARDY, EXAMINING ATTORNEY

SN 77-130,502. TARABINI, JOHN, DANVILLE, CA. AND TARABINI, SHAROL, DANVILLE, CA. FILED 3-14-2007.

DAMIAN RAE

THE MARK CONSISTS OF STANDARD CHARACTERS WITHOUT CLAIM TO ANY PARTICULAR FONT, STYLE, SIZE, OR COLOR.

"THE NAME(S), PORTRAIT(S), AND/OR SIGNATURE(S) SHOWN IN THE MARK DOES NOT IDENTIFY A PARTICULAR LIVING INDIVIDUAL."

FOR WINE (U.S. CLS. 47 AND 49).
KEVON CHISOLM, EXAMINING ATTORNEY

SN 77-139,845. MEXCOR, INC., HOUSTON, TX. FILED 3-26-2007.

COME STAI CIAO

THE MARK CONSISTS OF STANDARD CHARACTERS WITHOUT CLAIM TO ANY PARTICULAR FONT, STYLE, SIZE, OR COLOR.

THE FOREIGN WORDING IN THE MARK TRANSLATES INTO ENGLISH AS HELLO HOW ARE YOU.
FOR WINE (U.S. CLS. 47 AND 49).

YAT SYE, LEE, EXAMINING ATTORNEY

CLASS 33—(Continued).

SN 77-142,157. PRINCE MICHEL LLC, LEON, VA. FILED 3-28-2007.

IVY CREEK FARM

THE MARK CONSISTS OF STANDARD CHARACTERS WITHOUT CLAIM TO ANY PARTICULAR FONT, STYLE, SIZE, OR COLOR.
FOR WINE (U.S. CLS. 47 AND 49).
CHRISTINE COOPER, EXAMINING ATTORNEY

SN 77-144,925. WILSON CREEK WINERY & VINEYARDS, INC., TEMECULA, CA. FILED 3-30-2007.

QUALITY WINES QUALITY TIMES

THE MARK CONSISTS OF STANDARD CHARACTERS WITHOUT CLAIM TO ANY PARTICULAR FONT, STYLE, SIZE, OR COLOR.
OWNER OF U.S. REG. NO. 3,111,725.
FOR WINE; CHAMPAGNE (U.S. CLS. 47 AND 49).
FIRST USE 1-0-2002; IN COMMERCE 1-0-2002.
PATRICIA EVANKO, EXAMINING ATTORNEY

SN 77-146,319. LONDON GROUP, LLC, OLD WESTBURY, NY. FILED 4-2-2007.

L'ESPRIT DE PARIS

THE MARK CONSISTS OF STANDARD CHARACTERS WITHOUT CLAIM TO ANY PARTICULAR FONT, STYLE, SIZE, OR COLOR.
THE FOREIGN WORDING IN THE MARK TRANSLATES INTO ENGLISH AS THE SPIRIT OF PARIS.
FOR LIQUEURS (U.S. CLS. 47 AND 49).
AISHA SALEM, EXAMINING ATTORNEY

CLASS 33—(Continued).

SN 77-146,461. JESSUP CELLARS HOLDING COMPANY, LLC, YOUNTVILLE, CA. FILED 4-2-2007.

JESSUP CELLARS

THE MARK CONSISTS OF STANDARD CHARACTERS WITHOUT CLAIM TO ANY PARTICULAR FONT, STYLE, SIZE, OR COLOR.
NO CLAIM IS MADE TO THE EXCLUSIVE RIGHT TO USE "CELLARS", APART FROM THE MARK AS SHOWN.
SEC. 2(F).
FOR WINES (U.S. CLS. 47 AND 49).
FIRST USE 1-1-1996; IN COMMERCE 10-1-1997.
JOHN DWYER, EXAMINING ATTORNEY

SN 77-147,318. STEELBIRD GHETTO PROPERTIES LLC, SONOMA, CA. FILED 4-3-2007.

MOO BUZZ

THE MARK CONSISTS OF STANDARD CHARACTERS WITHOUT CLAIM TO ANY PARTICULAR FONT, STYLE, SIZE, OR COLOR.
FOR WINE (U.S. CLS. 47 AND 49).
B. PARADEWELAI, EXAMINING ATTORNEY

SN 77-148,551. COSENTINO SIGNATURE WINERIES, YOUNTVILLE, CA. FILED 4-4-2007.

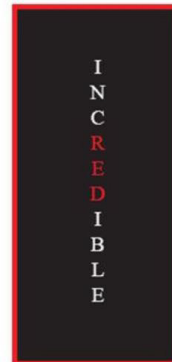

THE COLOR(S) BLACK, WHITE, RED IS/ARE CLAIMED AS A FEATURE OF THE MARK.
THE MARK CONSISTS OF BLACK BACKGROUND WITH A RED BORDER. WHITE BLOCK CAPITAL LETTERS INC IBLE. RED BLOCK CAPITAL LETTERS RED.
FOR RED WINE (U.S. CLS. 47 AND 49).
ALICE BENMAMAN, EXAMINING ATTORNEY

CLASS 33—(Continued).

SN 77-150,834. MCCLAIN, RUDY, SONOMA, CA. FILED 4-6-2007.

MERLOVE

THE MARK CONSISTS OF STANDARD CHARACTERS WITHOUT CLAIM TO ANY PARTICULAR FONT, STYLE, SIZE, OR COLOR.

FOR WINE (U.S. CLS. 47 AND 49).
FIRST USE 2-23-2007; IN COMMERCE 2-23-2007.
YAT SYE, LEE, EXAMINING ATTORNEY

SN 77-153,119. STONINGTON SEAHAWK LLC, NEW YORK, NY. FILED 4-10-2007.

THE SALTWATER FARM

THE MARK CONSISTS OF STANDARD CHARACTERS WITHOUT CLAIM TO ANY PARTICULAR FONT, STYLE, SIZE, OR COLOR.

FOR WINE (U.S. CLS. 47 AND 49).
LA TONIA FISHER, EXAMINING ATTORNEY

SN 77-153,564. MADAULE DE LAGABBE S.A., MENDOZA, ARGENTINA, FILED 4-10-2007.

DENEZA

THE MARK CONSISTS OF STANDARD CHARACTERS WITHOUT CLAIM TO ANY PARTICULAR FONT, STYLE, SIZE, OR COLOR.

FOR WINES (U.S. CLS. 47 AND 49).
FIRST USE 3-16-2007; IN COMMERCE 3-16-2007.
DANIEL RUSSELL, EXAMINING ATTORNEY

SN 77-153,816. ENZO WINES, L.L.C., OAKVILLE, CA. FILED 4-11-2007.

MAGO

THE MARK CONSISTS OF STANDARD CHARACTERS WITHOUT CLAIM TO ANY PARTICULAR FONT, STYLE, SIZE, OR COLOR.

FOR WINES (U.S. CLS. 47 AND 49).
MATTHEW PAPPAS, EXAMINING ATTORNEY

CLASS 33—(Continued).

SN 77-155,277. BADGER MOUNTAIN, INC., KENNEWICK, WA. FILED 4-12-2007.



PURE WHITE

NO CLAIM IS MADE TO THE EXCLUSIVE RIGHT TO USE "PURE WHITE", APART FROM THE MARK AS SHOWN.

THE MARK CONSISTS OF THE WORDS PURE WHITE WITH A HALO ABOVE THE TEXT.
FOR WINES; WHITE WINE; WINE (U.S. CLS. 47 AND 49).

FIRST USE 2-24-2006; IN COMMERCE 2-24-2006.
MARY MUNSON, EXAMINING ATTORNEY

SN 77-155,325. BADGER MOUNTAIN, INC., KENNEWICK, WA. FILED 4-12-2007.



PURE RED

NO CLAIM IS MADE TO THE EXCLUSIVE RIGHT TO USE "PURE RED", APART FROM THE MARK AS SHOWN.
THE MARK CONSISTS OF THE WORDS PURE RED WITH A HALO OVER THE TEXT.

FOR RED WINE; TABLE WINES; WINE (U.S. CLS. 47 AND 49).

FIRST USE 2-24-2006; IN COMMERCE 2-24-2006.
MARY MUNSON, EXAMINING ATTORNEY

SN 77-156,214. KOLEV ,KOLIO, DES PLAINES, IL. FILED 4-13-2007.

AREA 51

THE MARK CONSISTS OF STANDARD CHARACTERS WITHOUT CLAIM TO ANY PARTICULAR FONT, STYLE, SIZE, OR COLOR.

FOR GRAPE WINE (U.S. CLS. 47 AND 49).
DAVID ELTON, EXAMINING ATTORNEY

CLASS 33—(Continued).

SN 77-156,787. TC SPECIALTY BRANDS, LLC., LAS VEGAS, NV. FILED 4-13-2007.

II IV VII III VI V SEX ICE

THE MARK CONSISTS OF STANDARD CHARACTERS WITHOUT CLAIM TO ANY PARTICULAR FONT, STYLE, SIZE, OR COLOR.

FOR DISTILLED SPIRITS; ALCOHOLIC BEVERAGE PRODUCED FROM A BREWED MALT BASE WITH NATURAL FLAVORS; ALCOHOLIC BEVERAGES OF FRUIT; ALCOHOLIC MALT COOLERS; FLAVORED BREWED MALT BEVERAGE (U.S. CLS. 47 AND 49).

ANDREA K. NADELMAN, EXAMINING ATTORNEY

SN 77-157,563. R WINES SARL, BORDEAUX, FRANCE, FILED 4-16-2007.

BLACKBERET

THE MARK CONSISTS OF STANDARD CHARACTERS WITHOUT CLAIM TO ANY PARTICULAR FONT, STYLE, SIZE, OR COLOR.

FOR WINES (U.S. CLS. 47 AND 49).

TEJBIR SINGH, EXAMINING ATTORNEY

SN 77-158,231. ALTAMAR BRANDS, LLC, CORONA DEL MAR, CA. FILED 4-17-2007.

EST UNUS MODUS VERUS

THE MARK CONSISTS OF STANDARD CHARACTERS WITHOUT CLAIM TO ANY PARTICULAR FONT, STYLE, SIZE, OR COLOR.

FOR ALCOHOLIC BEVERAGES, NAMELY, DISTILLED SPIRITS (U.S. CLS. 47 AND 49).

KAELIE KUNG, EXAMINING ATTORNEY

CLASS 33—(Continued).

SN 77-158,304. ORCHID LIQUEURS, LLC, DENVER, CO. FILED 4-17-2007.



THE MARK CONSISTS OF THE WORD "ORCHID" AND A DESIGN OF AN ORCHID.

FOR DISTILLED SPIRITS; LIQUEURS (U.S. CLS. 47 AND 49).

FIRST USE 3-23-2007; IN COMMERCE 3-23-2007.

CHERYL CLAYTON, EXAMINING ATTORNEY

SN 77-158,526. BROWN, THOMAS RIVERS, CALISTOGA, CA. FILED 4-17-2007.

RIVERS-MARIE

THE MARK CONSISTS OF STANDARD CHARACTERS WITHOUT CLAIM TO ANY PARTICULAR FONT, STYLE, SIZE, OR COLOR.

FOR WINE (U.S. CLS. 47 AND 49).

FIRST USE 2-28-2005; IN COMMERCE 2-28-2005.

JASON ROTH, EXAMINING ATTORNEY

SN 77-158,661. SEMELI WINERY S.A., STAMATA, ATTIKI 145 75, GREECE, FILED 4-17-2007.

MOUNTAIN SUN

THE MARK CONSISTS OF STANDARD CHARACTERS WITHOUT CLAIM TO ANY PARTICULAR FONT, STYLE, SIZE, OR COLOR.

FOR WINE (U.S. CLS. 47 AND 49).

FIRST USE 3-28-2007; IN COMMERCE 3-28-2007.

MORGAN WYNNE, EXAMINING ATTORNEY

CLASS 33—(Continued).

SN 77-159,034. MADRONA PROPERTY COMPANY, SAN FRANCISCO, CA. FILED 4-17-2007.

Lone Rock

THE MARK CONSISTS OF STANDARD CHARACTERS WITHOUT CLAIM TO ANY PARTICULAR FONT, STYLE, SIZE, OR COLOR.

FOR WINES (U.S. CLS. 47 AND 49).
DEIRDRE ROBERTSON, EXAMINING ATTORNEY

SN 77-159,378. CHANGYU PIONEER WINE COMPANY LIMITED YANTAI CHINA, YANTAI, CHINA, FILED 4-18-2007.



彩
NOBLE DRAGON
龙

THE MARK CONSISTS OF TWO CHINESE CHARACTERS, ONE ABOVE THE OTHER WITH THE WORDS "NOBLE DRAGON" BETWEEN THEM.

THE NON-LATIN CHARACTER(S) IN THE MARK TRANSLITERATE INTO CAI AND LONG, AND THIS MEANS COLORFUL AND DRAGON IN ENGLISH.

FOR WINE; DISTILLED SPIRITS; ALCOHOLIC BEVERAGES PRODUCED FROM A BREWED MALT BASE WITH NATURAL FLAVORS; POTABLE SPIRITS; ALCOHOLIC FRUIT EXTRACTS; ALCOHOLIC COCKTAIL MIXES; ALCOHOLIC COCKTAILS CONTAINING MILK; PREPARED ALCOHOLIC COCKTAILS; PREPARED WINE COCKTAILS; ALCOHOLIC BEVERAGES OF FRUIT; SAKI; ALCOHOLIC BEVERAGE, NAMELY, RUM; VODKA (U.S. CLS. 47 AND 49).

FIRST USE 12-18-2006; IN COMMERCE 4-15-2007.
ROSELLE HERRERA, EXAMINING ATTORNEY

SN 77-159,594. MERLO RANCH LIMITED PARTNERSHIP, HILLSBORO, OR. FILED 4-18-2007.

SONOMATAGE

THE MARK CONSISTS OF STANDARD CHARACTERS WITHOUT CLAIM TO ANY PARTICULAR FONT, STYLE, SIZE, OR COLOR.

FOR WINE (U.S. CLS. 47 AND 49).
JOHN WILKE, EXAMINING ATTORNEY

CLASS 33—(Continued).

SN 77-159,823. 90 HADDON AVENUE RESTAURANT INCORPORATED, WESTMONT, NJ. FILED 4-18-2007.

ViTini

THE MARK CONSISTS OF STANDARD CHARACTERS WITHOUT CLAIM TO ANY PARTICULAR FONT, STYLE, SIZE, OR COLOR.

FOR PREPARED ALCOHOLIC COCKTAILS (U.S. CLS. 47 AND 49).
KATHERINE CHANG, EXAMINING ATTORNEY

SN 77-160,353. MONTES S.A., HUECHURABA, SANTIAGO, CHILE, FILED 4-19-2007.

NAPA ANGEL

THE MARK CONSISTS OF STANDARD CHARACTERS WITHOUT CLAIM TO ANY PARTICULAR FONT, STYLE, SIZE, OR COLOR.

OWNER OF U.S. REG. NO. 3,100,075.

NO CLAIM IS MADE TO THE EXCLUSIVE RIGHT TO USE "NAPA", APART FROM THE MARK AS SHOWN.

FOR WINE DERIVED FROM GRAPES GROWN IN NAPA COUNTY, CALIFORNIA, LABELED AND ADVERTISED IN COMPLIANCE WITH U.S. LAWS FOR EITHER THE NAPA COUNTY APPELLATION OF ORIGIN OR THE NAPA VALLEY AMERICAN VITICULTURAL AREA APPELLATION OF ORIGIN (U.S. CLS. 47 AND 49).

MICHAEL SOUDERS, EXAMINING ATTORNEY

SN 77-160,694. HESHE AND SHULEM MANAGEMENT INC., BROOKLYN, NY. FILED 4-19-2007.

YAYIN HAMISHMAR

THE MARK CONSISTS OF STANDARD CHARACTERS WITHOUT CLAIM TO ANY PARTICULAR FONT, STYLE, SIZE, OR COLOR.

NO CLAIM IS MADE TO THE EXCLUSIVE RIGHT TO USE "YAYIN", APART FROM THE MARK AS SHOWN.

THE ENGLISH TRANSLATION OF YAYIN HAMISHMAR IS THE GUARD WINE.

FOR WINE (U.S. CLS. 47 AND 49).

CHARLOTTE CORWIN, EXAMINING ATTORNEY

CLASS 33—(Continued).

SN 77-161,092. GET SUM, INC., NEWPORT BEACH, CA.
FILED 4-19-2007.

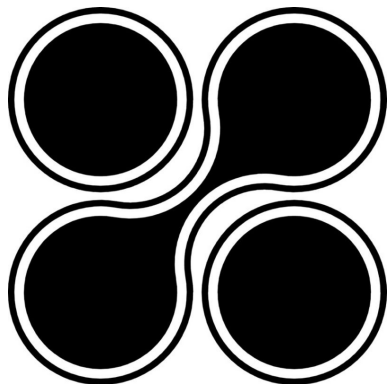

THE MARK CONSISTS OF A STYLIZED CIRCULAR DESIGN.
FOR HARD LIQUOR (U.S. CLS. 47 AND 49).
JAY FLOWERS, EXAMINING ATTORNEY

SN 77-161,196. SURJIT SONI, PASADENA, CA. FILED 4-19-2007.

IN THE MOOD

THE MARK CONSISTS OF STANDARD CHARACTERS WITHOUT CLAIM TO ANY PARTICULAR FONT, STYLE, SIZE, OR COLOR.
FOR WINES (U.S. CLS. 47 AND 49).
GEORGE LORENZO, EXAMINING ATTORNEY

SN 77-161,548. PWG, LLC, SALINAS, CA. FILED 4-20-2007.

PESSAGNO

THE MARK CONSISTS OF STANDARD CHARACTERS WITHOUT CLAIM TO ANY PARTICULAR FONT, STYLE, SIZE, OR COLOR.
OWNER OF U.S. REG. NO. 2,880,518.
SEC. 2(F).
FOR WINE (U.S. CLS. 47 AND 49).
FIRST USE 4-19-2001; IN COMMERCE 4-19-2001.
SKYE YOUNG, EXAMINING ATTORNEY

CLASS 33—(Continued).

SN 77-162,046. ELV HOLDINGS, INC., OCCIDENTAL, CA.
FILED 4-20-2007.

THE EVENING COAST

THE MARK CONSISTS OF STANDARD CHARACTERS WITHOUT CLAIM TO ANY PARTICULAR FONT, STYLE, SIZE, OR COLOR.
FOR WINE (U.S. CLS. 47 AND 49).
KHANH LE, EXAMINING ATTORNEY

SN 77-162,394. KRUSE, KARISSA L., CHICAGO, IL. AND HARMON, JUSTIN JOSEPH, CHICAGO, IL. FILED 4-20-2007.

ARGOT

THE MARK CONSISTS OF STANDARD CHARACTERS WITHOUT CLAIM TO ANY PARTICULAR FONT, STYLE, SIZE, OR COLOR.
FOR WINES (U.S. CLS. 47 AND 49).
MARTHA FROMM, EXAMINING ATTORNEY

SN 77-162,455. CAVE EXTRÊME S.A., BUENOS AIRES, ARGENTINA, FILED 4-21-2007.

SOUTH EXTRÊME

THE MARK CONSISTS OF STANDARD CHARACTERS WITHOUT CLAIM TO ANY PARTICULAR FONT, STYLE, SIZE, OR COLOR.
THE FOREIGN WORDING IN THE MARK TRANSLATES INTO ENGLISH AS EXTREME.
FOR SPARKLING WINE; WINES (U.S. CLS. 47 AND 49).
GEORGIA CARTY, EXAMINING ATTORNEY

CLASS 33—(Continued).

SN 77-162,460. CAVE EXTRÊME S.A., BUENOS AIRES, ARGENTINA, FILED 4-21-2007.

CAVE EXTRÊME

THE MARK CONSISTS OF STANDARD CHARACTERS WITHOUT CLAIM TO ANY PARTICULAR FONT, STYLE, SIZE, OR COLOR.

THE FOREIGN WORDING IN THE MARK TRANSLATES INTO ENGLISH AS EXTREME.
FOR WINES; SPARKLING WINE (U.S. CLS. 47 AND 49).

GEORGIA CARTY, EXAMINING ATTORNEY

CLASS 33—(Continued).

SN 77-165,698. WINERY EXCHANGE, INC., NOVATO, CA, FILED 4-25-2007.

ENOTECA ORSO

THE MARK CONSISTS OF STANDARD CHARACTERS WITHOUT CLAIM TO ANY PARTICULAR FONT, STYLE, SIZE, OR COLOR.

NO CLAIM IS MADE TO THE EXCLUSIVE RIGHT TO USE "ENOTECA", APART FROM THE MARK AS SHOWN.

THE ENGLISH TRANSLATION OF THE FOREIGN WORDING "ENOTECA" IS "WINE CELLAR" AND THE ENGLISH TRANSLATION OF THE FOREIGN WORDING "ORSO" IS "BEAR."

FOR WINES (U.S. CLS. 47 AND 49).

JAY FLOWERS, EXAMINING ATTORNEY

SN 77-164,312. BAMBU IMPORTS LLC, NEW YORK, NY, FILED 4-24-2007.

The Feminine Side of Rum

THE MARK CONSISTS OF STANDARD CHARACTERS WITHOUT CLAIM TO ANY PARTICULAR FONT, STYLE, SIZE, OR COLOR.

NO CLAIM IS MADE TO THE EXCLUSIVE RIGHT TO USE "RUM", APART FROM THE MARK AS SHOWN.

FOR DISTILLED SPIRITS (U.S. CLS. 47 AND 49).

CYNTHIA SLOAN, EXAMINING ATTORNEY

SN 77-168,047. BROWN-FORMAN CORPORATION, LOUISVILLE, KY, FILED 4-27-2007.



OWNER OF U.S. REG. NO. 1,071,921.

THE MARK CONSISTS OF THE REPRESENTATION OF A CROWN.

FOR DISTILLED SPIRITS (U.S. CLS. 47 AND 49).

FIRST USE 12-18-1975; IN COMMERCE 12-18-1975.

TASNEEM HUSSAIN, EXAMINING ATTORNEY

SN 77-165,425. FETZER VINEYARDS, HOPLAND, CA, FILED 4-25-2007.

OFFICIAL WINE OF AWARDS SEASON

THE MARK CONSISTS OF STANDARD CHARACTERS WITHOUT CLAIM TO ANY PARTICULAR FONT, STYLE, SIZE, OR COLOR.

FOR ALCOHOLIC BEVERAGES, NAMELY, WINE (U.S. CLS. 47 AND 49).

MONIQUE MILLER, EXAMINING ATTORNEY

SN 77-172,995. COURVOISIER S.A.S., JARNAC, FRANCE, FILED 5-4-2007.

HOUSE OF COURVOISIER

THE MARK CONSISTS OF STANDARD CHARACTERS WITHOUT CLAIM TO ANY PARTICULAR FONT, STYLE, SIZE, OR COLOR.

OWNER OF U.S. REG. NOS. 311,352, 2,511,043 AND OTHERS.

FOR ALCOHOLIC BEVERAGES, NAMELY, COGNAC (U.S. CLS. 47 AND 49).

JOSETTE BEVERLY, EXAMINING ATTORNEY

CLASS 33—(Continued).

SN 77-181,192. CRICHTON HALL VINEYARD, LLC, NAPA, CA. FILED 5-15-2007.

LINDA'S HILLSIDE VINEYARD

THE MARK CONSISTS OF STANDARD CHARACTERS WITHOUT CLAIM TO ANY PARTICULAR FONT, STYLE, SIZE, OR COLOR.
NO CLAIM IS MADE TO THE EXCLUSIVE RIGHT TO USE "VINEYARD", APART FROM THE MARK AS SHOWN.
FOR WINE (U.S. CLS. 47 AND 49).
MARTHA FROMM, EXAMINING ATTORNEY

SN 77-183,217. FOSTER'S WINE ESTATES AMERICAS COMPANY, NAPA, CA. FILED 5-17-2007.

LANIGER

THE MARK CONSISTS OF STANDARD CHARACTERS WITHOUT CLAIM TO ANY PARTICULAR FONT, STYLE, SIZE, OR COLOR.
FOR WINE (U.S. CLS. 47 AND 49).
KATHY DE JONGE, EXAMINING ATTORNEY

SN 77-185,893. ALTAMAR BRANDS, LLC, CORONA DEL MAR, CA. FILED 5-21-2007.

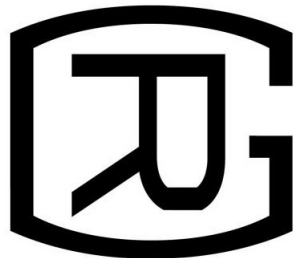

THE MARK CONSISTS OF A ROTATED LETTER R WITHIN A LETTER G.
FOR ALCOHOLIC BEVERAGES, NAMELY, DISTILLED SPIRITS (U.S. CLS. 47 AND 49).
KAELIE KUNG, EXAMINING ATTORNEY

CLASS 33—(Continued).

SN 77-186,095. PHILLIPS PRODUCTS COMPANY, LLC, PRINCETON, MN. FILED 5-21-2007.

LOZANO

THE MARK CONSISTS OF STANDARD CHARACTERS WITHOUT CLAIM TO ANY PARTICULAR FONT, STYLE, SIZE, OR COLOR.
THE FOREIGN WORDING IN THE MARK TRANSLATES INTO ENGLISH AS HEALTHY-LOOKING; LUXURIANT;-BLOOMING.
FOR TEQUILA (U.S. CLS. 47 AND 49).
ARETHA SOMERVILLE, EXAMINING ATTORNEY

SN 77-199,876. GET SUM, INC., NEWPORT BEACH, CA. FILED 6-7-2007.

Not Just Another Brand But
A
Lifestyle

THE MARK CONSISTS OF STANDARD CHARACTERS WITHOUT CLAIM TO ANY PARTICULAR FONT, STYLE, SIZE, OR COLOR.
FOR DISTILLED SPIRITS (U.S. CLS. 47 AND 49).
JAY FLOWERS, EXAMINING ATTORNEY

SN 77-209,078. WINERY EXCHANGE, INC., NOVATO, CA. FILED 6-18-2007.

WISHING WELL

THE MARK CONSISTS OF STANDARD CHARACTERS WITHOUT CLAIM TO ANY PARTICULAR FONT, STYLE, SIZE, OR COLOR.
FOR WINES (U.S. CLS. 47 AND 49).
JAY FLOWERS, EXAMINING ATTORNEY

CLASS 33—(Continued).

SN 78-663,377. VINCOR INTERNATIONAL IBC, INC.,
BRIDGETOWN, BARBADOS, FILED 7-4-2005.

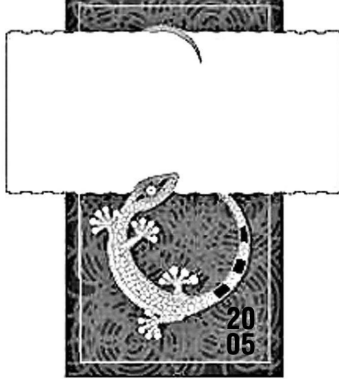

NO CLAIM IS MADE TO THE EXCLUSIVE RIGHT TO
USE "2005", APART FROM THE MARK AS SHOWN.
THE MARK CONSISTS OF GECKO DESIGN.
FOR WINE; TABLE WINE (U.S. CLS. 47 AND 49).
ANNE MADDEN, EXAMINING ATTORNEY

SN 78-774,225. SURCO, LLC, SCARSDALE, NY. FILED 12-15-
2005.

MORICHETTI

THE MARK CONSISTS OF STANDARD CHARACTERS
WITHOUT CLAIM TO ANY PARTICULAR FONT, STYLE,
SIZE, OR COLOR.
SEC. 2(F).
FOR WINE (U.S. CLS. 47 AND 49).
FIRST USE 1-1-1880; IN COMMERCE 1-1-1880.
TONI HICKEY, EXAMINING ATTORNEY

SN 78-934,521. SAZERAC COMPANY, INC., NEW ORLEANS,
LA. FILED 7-21-2006.

THE SPIRIT OF NEW ORLEANS

THE MARK CONSISTS OF STANDARD CHARACTERS
WITHOUT CLAIM TO ANY PARTICULAR FONT, STYLE,
SIZE, OR COLOR.
NO CLAIM IS MADE TO THE EXCLUSIVE RIGHT TO
USE "NEW ORLEANS", APART FROM THE MARK AS
SHOWN.
FOR LIQUEUR PREPARED FROM HERBS AND DIS-
TILLED SPIRITS (U.S. CLS. 47 AND 49).
FIRST USE 2-15-1970; IN COMMERCE 2-15-1970.
ALICE BENMAMAN, EXAMINING ATTORNEY

CLASS 33—(Continued).

SN 78-965,535. SPECIALTY BEER INVESTMENTS, INC.,
DBA AMERICAN BEER & SPIRITS CO., SAUSALITO,
CA. FILED 8-31-2006.

BLACK DOG

THE MARK CONSISTS OF STANDARD CHARACTERS
WITHOUT CLAIM TO ANY PARTICULAR FONT, STYLE,
SIZE, OR COLOR.
FOR ALCOHOLIC BEVERAGES, NAMELY, WHISKEY
(U.S. CLS. 47 AND 49).
ALICE BENMAMAN, EXAMINING ATTORNEY

SN 78-965,538. SPECIALTY BEER INVESTMENTS, INC.,
DBA AMERICAN BEER & SPIRITS CO., SAUSALITO,
CA. FILED 8-31-2006.

ROYAL CHALLENGE

THE MARK CONSISTS OF STANDARD CHARACTERS
WITHOUT CLAIM TO ANY PARTICULAR FONT, STYLE,
SIZE, OR COLOR.
FOR ALCOHOLIC BEVERAGES, NAMELY, WHISKEY
(U.S. CLS. 47 AND 49).
ALICE BENMAMAN, EXAMINING ATTORNEY

SN 78-968,110. VIÑA TARAPACÁ EX ZAVALA S.A., SAN-
TIAGO, CHILE, FILED 9-6-2006.

BE PASSIONATE

THE MARK CONSISTS OF STANDARD CHARACTERS
WITHOUT CLAIM TO ANY PARTICULAR FONT, STYLE,
SIZE, OR COLOR.
FOR WINES (U.S. CLS. 47 AND 49).
FIRST USE 12-0-2004; IN COMMERCE 12-0-2004.
GISELLE AGOSTO, EXAMINING ATTORNEY

CLASS 33—(Continued).

SN 78-969,688. VERGENOEGD WINE ESTATE (PTY) LTD,
FAURE, SOUTH AFRICA, FILED 9-8-2006.

OLD CAPE COLONY

THE MARK CONSISTS OF STANDARD CHARACTERS
WITHOUT CLAIM TO ANY PARTICULAR FONT, STYLE,
SIZE, OR COLOR.

FOR WINE (U.S. CLS. 47 AND 49).
FIRST USE 5-0-2003; IN COMMERCE 12-0-2003.
MICHAEL WEBSTER, EXAMINING ATTORNEY

SN 79-012,791. CHAMPAGNE LOUIS ROEDERER (CLR)
SOCIÉTÉ ANONYME, FRANCE, FILED 6-21-2005.



PRIORITY DATE OF 3-22-2005 IS CLAIMED.
OWNER OF INTERNATIONAL REGISTRATION 0855293
DATED 6-21-2005, EXPIRES 6-21-2015.
OWNER OF U.S. REG. NOS. 96,996, 1,613,179 AND
OTHERS.

NO CLAIM IS MADE TO THE EXCLUSIVE RIGHT TO
USE "CHAMPAGNE" AND THE CONFIGURATION OF THE
RECTANGULAR HINGED BOX, APART FROM THE
MARK AS SHOWN.

THE NAME LOUIS ROEDERER DOES NOT IDENTIFY A
LIVING INDIVIDUAL.

THE COLOR(S) GOLD, DARK GOLD, WHITE, AND
MAROON IS/ARE CLAIMED AS A FEATURE OF THE
MARK.

THE MARK CONSISTS OF A THREE-DIMENSIONAL
CONFIGURATION OF A RECTANGULAR BOX THAT
CAN BE DISPLAYED IN AN OPEN POSITION VIA A
HINGED LID THAT IS USED AS A CONTAINER FOR
THE GOODS. THE BOX IS IN A DARK GOLD COLOR AND
A MEDALLION SHOWING THE LETTERS LR INTER-
LACED AND IN A GOLD COLOR ON A WHITE BACK-
GROUND IS ON THE TOP OF THE CONTAINER. THE TOP
OF THE CONTAINER ALSO CONTAINS A DECORATIVE
STRAIGHT-LINE RECTANGULAR BORDER IN THE COL-
OR GOLD. BELOW THE MEDALLION APPEARS THE
WORDING CRISTAL IN WHITE LETTERING AND A
STYLIZED DESIGN COMPOSED OF CURVED LINES AP-
PEARING IN A WHITE COLOR. ON THE LONG FRONT
SIDE OF THE BOX, THE WORDING LOUIS ROEDERER
CHAMPAGNE APPEARS IN A MAROON COLOR AND THE
INTERLACED LETTERS RL APPEAR IN GOLD, ABOVE
WHICH APPEARS THE WORDING CRISTAL IN WHITE
LETTERING. ON THE NARROW FRONT SIDE OF THE
RECTANGULAR BOX APPEARS A MAROON AND GOLD
CREST COMPOSED OF A DOUBLE-HEADED EAGLE.

SEC. 2(F) AS TO "CRISTAL".

FOR ALCOHOLIC BEVERAGES, NAMELY LI-
QUEURS, SPIRITS, WINE, SPARKLING GRAPE WINES;
FRENCH WINES, NAMELY WINES WITH THE CHAM-
PAGNE PROTECTED LABEL OF ORIGIN (U.S. CLS. 47
AND 49).

ROBERT LAVACHE, EXAMINING ATTORNEY

CLASS 33—(Continued).

SN 79-027,957. BODEGAS LUIS ALEGRE, S.A., SPAIN,
FILED 9-7-2006.

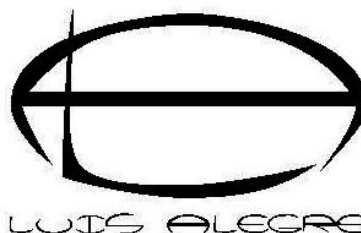

PRIORITY DATE OF 8-4-2006 IS CLAIMED.
OWNER OF INTERNATIONAL REGISTRATION 0896099
DATED 9-7-2006, EXPIRES 9-7-2016.

"THE NAME(S), PORTRAIT(S), AND/OR SIGNATURE(S)
SHOWN IN THE MARK IDENTIFIES LUIS ALEGRE,
WHOSE CONSENT(S) TO REGISTER IS SUBMITTED."

FOR WINES (U.S. CLS. 47 AND 49).
ANTHONY RINKER, EXAMINING ATTORNEY

SN 79-028,943. YUGEN KAISHA KYOYA SHUZO, JAPAN,
FILED 9-6-2006.

甕
雫

OWNER OF INTERNATIONAL REGISTRATION 0898624
DATED 9-6-2006, EXPIRES 9-6-2016.

"THE FOREIGN WORDING IN THE MARK TRANS-
LATES INTO ENGLISH AS INDIVIDUAL CHARACTERS.
THE FIRST CHARACTER TRANSLATES AS "CROCK" AND
THE SECOND CHARACTER AS "DROP," AS IN A DROP OF
LIQUID."

THE TRANSLITERATION OF THE NON-LATIN CHAR-
ACTERS IN THE MARK IS: KAMESHIZUKU.

FOR JAPANESE WHITE LIQUOR (SHOCHU) (U.S.
CLS. 47 AND 49).

ALLISON HOLTZ, EXAMINING ATTORNEY

CLASS 33—(Continued).

SN 79-029,992. YUGEN KAISHA KYOYA SHUZO, JAPAN,
FILED 8-22-2006.

河童の誘い水

OWNER OF INTERNATIONAL REGISTRATION 0901248
DATED 8-22-2006, EXPIRES 8-22-2016.

"THE FOREIGN WORDING IN THE MARK TRANSLATES INTO ENGLISH AS 'KAPPA'S TEMPTING WATER.' 'KAPPA' IS A JAPANESE MYTHICAL CREATURE."

THE TRANSLITERATION OF THE NON-LATIN CHARACTERS IN THE MARK IS: KAPPA NO SASOIMIZU.

FOR JAPANESE WHITE LIQUOR (SHOCHU) (U.S. CLS. 47 AND 49).

ALLISON HOLTZ, EXAMINING ATTORNEY

SN 79-031,881. G'DAY MATE AUSTRALIAN WINE EXPORTS PTY LTD, AUSTRALIA, FILED 11-13-2006.

G'DAY MATE

THE MARK CONSISTS OF STANDARD CHARACTERS WITHOUT CLAIM TO ANY PARTICULAR FONT, STYLE, SIZE, OR COLOR.

OWNER OF INTERNATIONAL REGISTRATION 0905801
DATED 11-13-2006, EXPIRES 11-13-2016.

OWNER OF U.S. REG. NO. 2,981,756.

FOR WINES (U.S. CLS. 47 AND 49).

VERNA BETH RIRIE, EXAMINING ATTORNEY

CLASS 34—SMOKERS' ARTICLES

SN 76-645,672. INTERNATIONAL TOBACCO & CIGARETTE CO. LTD., AMMAN, JORDAN, FILED 4-29-2005.

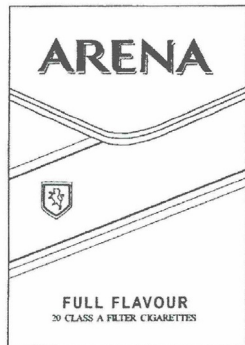

NO CLAIM IS MADE TO THE EXCLUSIVE RIGHT TO USE "FULL FLAVOUR 20 CLASS A FILTER CIGARETTES", APART FROM THE MARK AS SHOWN.

FOR CIGARETTES AND TOBACCO (U.S. CLS. 2, 8, 9 AND 17).

PAMELA HIRSCHMAN, EXAMINING ATTORNEY

CLASS 34—(Continued).

SN 76-667,842. J.C. NEWMAN CIGAR COMPANY, TAMPA, FL. FILED 10-20-2006.

EL BATON

THE MARK CONSISTS OF STANDARD CHARACTERS WITHOUT CLAIM TO ANY PARTICULAR FONT, STYLE, SIZE, OR COLOR.

THE ENGLISH TRANSLATION OF "EL BATON" IN THE MARK IS "THE BATON."

FOR CIGARS, CIGAR HUMIDORS NOT OF PRECIOUS METAL, SMOKERS' ARTICLES, NAMELY, CIGAR CUTTERS, ASHTRAYS NOT OF PRECIOUS METAL, CIGAR POUCHES, AND MATCHES (U.S. CLS. 2, 8, 9 AND 17).

REBECCA SMITH, EXAMINING ATTORNEY

SN 77-122,005. GOODSON INVESTMENTS, INC., MIAMI, FL. FILED 3-5-2007.

BÁRBARO

THE MARK CONSISTS OF STANDARD CHARACTERS WITHOUT CLAIM TO ANY PARTICULAR FONT, STYLE, SIZE, OR COLOR.

THE FOREIGN WORDING IN THE MARK TRANSLATES INTO ENGLISH AS COOL.

FOR CIGARETTES (U.S. CLS. 2, 8, 9 AND 17).

CRAIG D. TAYLOR, EXAMINING ATTORNEY

SN 77-141,378. RONSON CORPORATION, WOODBRIDGE, NJ. FILED 3-27-2007.

WIND LITE

THE MARK CONSISTS OF STANDARD CHARACTERS WITHOUT CLAIM TO ANY PARTICULAR FONT, STYLE, SIZE, OR COLOR.

NO CLAIM IS MADE TO THE EXCLUSIVE RIGHT TO USE "LIGHT", APART FROM THE MARK AS SHOWN.

FOR SMOKER'S ARTICLES, NAMELY, CIGARETTE LIGHTERS NOT OF PRECIOUS METAL (U.S. CLS. 2, 8, 9 AND 17).

JENNIFER HETU, EXAMINING ATTORNEY

CLASS 34—(Continued).

SN 77-157,763. BRECKLAND TRADING LIMITED, LIMASSOL, CYPRUS, FILED 4-16-2007.



NO CLAIM IS MADE TO THE EXCLUSIVE RIGHT TO USE "CIGARETTES", APART FROM THE MARK AS SHOWN.

FOR TOBACCO; SMOKERS' ACCESSORIES, NAMELY CIGARETTE LIGHTERS NOT OF PRECIOUS METAL, CIGARETTE CASES NOT OF PRECIOUS METAL, TOBACCO POUCHES, SMOKING PIPES, TOBACCO PIPES AND CIGARETTE PAPERS (U.S. CLS. 2, 8, 9 AND 17).

ESTHER BELENKER, EXAMINING ATTORNEY

SN 77-160,895. IMPRESS-TECHNOS, S.A. DE C.V., SAN PEDRO GARZA GARCIA, MEXICO, FILED 4-19-2007.

H!TLite

OWNER OF MEXICO REG. NO. 958244, DATED 10-19-2006, EXPIRES 3-18-2015.

FOR LIGHTERS FOR SMOKERS (U.S. CLS. 2, 8, 9 AND 17).

JESSICA FATHY, EXAMINING ATTORNEY

SN 77-183,612. JACOBS, ROSALIE ANN, HOGANSBURG, NY. FILED 5-17-2007.

TURQUOISE

THE MARK CONSISTS OF STANDARD CHARACTERS WITHOUT CLAIM TO ANY PARTICULAR FONT, STYLE, SIZE, OR COLOR.

FOR SMOKING TOBACCO (U.S. CLS. 2, 8, 9 AND 17).

LOURDES AYALA, EXAMINING ATTORNEY

CLASS 34—(Continued).

SN 79-015,213. SOCIÉTÉ CIVILE AGRICOLE CHÂTEAU MARGAUX, SOCIÉTÉ CIVILE, F-33460 MARGAUX, FRANCE, FILED 6-23-2005.

"CHATEAU MARGAUX"

Cigares

OWNER OF INTERNATIONAL REGISTRATION 0479674 DATED 10-4-1983, EXPIRES 10-4-2013.

OWNER OF U.S. REG. NO. 1,343,163.

NO CLAIM IS MADE TO THE EXCLUSIVE RIGHT TO USE "CIGARES", APART FROM THE MARK AS SHOWN. THE ENGLISH TRANSLATION OF CIGARES IS "CIGARS."

FOR RAW AND MANUFACTURED TOBACCO, CIGARS, CIGARETTES; MATCHES (U.S. CLS. 2, 8, 9 AND 17).

BRIDGETT SMITH, EXAMINING ATTORNEY

SERVICE MARKS**CLASS 35—ADVERTISING AND BUSINESS**

SN 76-280,641. GUARDIAN NEWS & MEDIA LIMITED, LONDON, UNITED KINGDOM, FILED 7-5-2001.

THE OBSERVER

PRIORITY CLAIMED UNDER SEC. 44(D) ON UNITED KINGDOM APPLICATION NO. 2257266, FILED 1-5-2001, REG. NO. 2257266, DATED 12-15-2006, EXPIRES 1-5-2011.

FOR BRINGING TOGETHER, FOR THE BENEFIT OF OTHERS, OF A VARIETY OF GOODS AND SERVICES ENABLING CUSTOMERS TO CONVENIENTLY VIEW AND PURCHASE THOSE GOODS AND/OR ORDER SUCH SERVICES; THE BRINGING TOGETHER, FOR THE BENEFIT OF OTHERS, OF A VARIETY OF GOODS AND SERVICES, THROUGH A GENERAL MERCHANDISE INTERNET WEB SITE, A GENERAL MERCHANDISE CATALOGUE, NEWSPAPER, MAGAZINE OR BROCHURE BY MAIL ORDER AND/OR A TELEVISION SHOPPING CHANNEL, ENABLING CUSTOMERS TO CONVENIENTLY VIEW AND PURCHASE THOSE GOODS OR ORDER SUCH SERVICES, BY MEANS OF TELECOMMUNICATIONS, INCLUDING ORDERING SUCH GOODS/SERVICES BY AN INTERNET-ENABLED PHONE (U.S. CLS. 100, 101 AND 102).

MELVIN AXILBUND, EXAMINING ATTORNEY

CLASS 35—(Continued).

SN 76-362,724. FEINSON, MICHAEL, WASHINGTON, DC. FILED 1-25-2002.

ENGAGED STRATEGIES

NO CLAIM IS MADE TO THE EXCLUSIVE RIGHT TO USE "STRATEGIES", APART FROM THE MARK AS SHOWN.

FOR PERSONNEL MANAGEMENT CONSULTATION SERVICES (U.S. CLS. 100, 101 AND 102).
SAMUEL E. SHARPER JR., EXAMINING ATTORNEY

SN 76-649,977. CULLEM, JAMES G., ROWLEY, MA. FILED 11-8-2005.

AURORA NOVA

THE MARK CONSISTS OF STANDARD CHARACTERS WITHOUT CLAIM TO ANY PARTICULAR FONT, STYLE, SIZE, OR COLOR.

FOR BUSINESS CONSULTING SERVICES IN THE FIELD OF INTELLECTUAL PROPERTY, EXCLUDING THE ENERGY INDUSTRY (U.S. CLS. 100, 101 AND 102).
ANGELA M. MICHELI, EXAMINING ATTORNEY

SN 76-652,726. INVENTIA SOLUTIONS, LLC, MURPHY, TX. FILED 1-3-2006.

LANDINGZONE

THE MARK CONSISTS OF STANDARD CHARACTERS WITHOUT CLAIM TO ANY PARTICULAR FONT, STYLE, SIZE, OR COLOR.

FOR ON-LINE SERVICES, NAMELY, SEARCH ENGINE MARKETING SERVICES THAT CREATE DYNAMIC LANDING PAGES FOR DESIGNATED, TARGETED KEY WORD COMBINATIONS IN RESPONSE TO INTERNET SEARCHES (U.S. CLS. 100, 101 AND 102).
MONIQUE MILLER, EXAMINING ATTORNEY

CLASS 35—(Continued).

SN 76-661,881. FLEISHMAN-HILLARD, INC., ST. LOUIS, MO. FILED 6-19-2006.

WATERFRONT STRATEGIES

THE MARK CONSISTS OF STANDARD CHARACTERS WITHOUT CLAIM TO ANY PARTICULAR FONT, STYLE, SIZE, OR COLOR.

NO CLAIM IS MADE TO THE EXCLUSIVE RIGHT TO USE "STRATEGIES", APART FROM THE MARK AS SHOWN.

FOR POLITICAL CONSULTING SERVICES, ADVERTISING AND PROMOTION SERVICES, AND DISSEMINATING PUBLIC INFORMATION CONCERNING POLITICS, LEGISLATION AND REGULATION AND ADVERTISING MATTER VIA INTERNET, PRINT MEDIA, TELEVISION AND RADIO, NOT INVOLVING WATERFRONT PROPERTIES AND/OR AREAS (U.S. CLS. 100, 101 AND 102).
DARRYL SPRUILL, EXAMINING ATTORNEY

SN 76-664,997. THE BAREFOOT CEO, INC., HENDERSON, NV. FILED 8-22-2006.

BAREFOOT AMBASSADOR

THE MARK CONSISTS OF STANDARD CHARACTERS WITHOUT CLAIM TO ANY PARTICULAR FONT, STYLE, SIZE, OR COLOR.

FOR MULTILEVEL MARKETING AND MULTILEVEL MARKETING HOME PARTY PLAN BUSINESS SERVICES IN THE FIELDS OF HEALTH, BEAUTY, NUTRITIONAL CARE AND GENERAL MERCHANDISE; PROVIDING PERSONNEL PLACEMENT AND RECRUITMENT ASSISTANCE TO INDEPENDENT SALES REPRESENTATIVES AND DISTRIBUTORS, NAMELY, AIDING IN THE RECRUITING OF ADDITIONAL INDEPENDENT SALES REPRESENTATIVES AND DISTRIBUTORS FOR MULTILEVEL SALES PROGRAM; PROVIDING TECHNICAL AND PROMOTIONAL ASSISTANCE, NAMELY PROMOTION AND MARKETING SERVICES AND RELATED CONSULTING IN CONNECTION WITH THE IN HOME RETAIL SALES BY INDEPENDENT SALES REPRESENTATIVES AND DISTRIBUTORS OF VARIOUS GOODS, NAMELY, GENERAL MERCHANDISE SUCH AS JEWELRY, WATCHES CLOTHING, DIETARY AND/OR FOOD SUPPLEMENTS, COSMETICS AND TOILETRIES, BOOKS AND PRINTED CARDS, GIFTS, CANDLES, CANDLE HOLDERS, PICTURE FRAMES, GROCERIES AND FOOD, TOYS, MUSIC, ELECTRONICS, AND HOME FURNISHINGS; PROVIDING AND IMPLEMENTING INCENTIVE AND AWARDS PROGRAMS FOR INDEPENDENT SALES REPRESENTATIVES TO PROMOTE THE SALE OF PRODUCTS AND SERVICES TO OTHERS AND TO RECRUIT ADDITIONAL INDEPENDENT SALES REPRESENTATIVES; RECRUITING, AND CAREER NETWORKING SERVICES RELATING TO INDEPENDENT SALES REPRESENTATIVES IN THE FIELDS OF HEALTH, BEAUTY, NUTRITIONAL CARE AND GENERAL MERCHANDISE; INDEPENDENT SALES REPRESENTATIVES IN THE FIELDS OF HEALTH, BEAUTY, NUTRITIONAL CARE AND GENERAL MERCHANDISE (U.S. CLS. 100, 101 AND 102).
LOURDES AYALA, EXAMINING ATTORNEY

CLASS 35—(Continued).

SN 76-668,118. NATIONAL JUNIOR COLLEGE ATHLETIC ASSOCIATION, INC., COLORADO SPRINGS, CO. FILED 10-26-2006.



OWNER OF U.S. REG. NOS. 1,077,641, 1,401,641 AND 1,646,377.

NO CLAIM IS MADE TO THE EXCLUSIVE RIGHT TO USE "ATHLETIC ASSOCIATION", APART FROM THE MARK AS SHOWN.

SEC. 2(F) AS TO "NATIONAL JUNIOR COLLEGE ATHLETIC ASSOCIATION".

FOR ASSOCIATION SERVICES, NAMELY, PROMOTING THE GENERAL INTEREST OF JUNIOR COLLEGE ATHLETES (U.S. CLS. 100, 101 AND 102).

FIRST USE 1-1-2005; IN COMMERCE 1-1-2005.
JEFFERY COWARD, EXAMINING ATTORNEY

SN 76-670,228. DNY INT'L INC., GREAT NECK, NY. FILED 11-28-2006.

Hipster

FOR RETAIL APPAREL STORES SERVICES (U.S. CLS. 100, 101 AND 102).

FIRST USE 8-1-2006; IN COMMERCE 8-1-2006.
DOMINICK J. SALEMI, EXAMINING ATTORNEY

SN 76-672,024. MILLER, DARRELL W., HARTVILLE, OH. FILED 1-30-2007.

VITANET

THE MARK CONSISTS OF STANDARD CHARACTERS WITHOUT CLAIM TO ANY PARTICULAR FONT, STYLE, SIZE, OR COLOR.

FOR RETAIL STORE SERVICES FEATURING VITAMINS (U.S. CLS. 100, 101 AND 102).

FIRST USE 8-17-1995; IN COMMERCE 8-17-1995.
ESTHER A. BORSUK, EXAMINING ATTORNEY

CLASS 35—(Continued).

SN 76-674,728. CALIFORNIA MILK PRODUCERS ADVISORY BOARD, AN INSTRUMENTALITY OF THE STATE OF CALIFORNIA, DEPARTMENT OF FOOD AND AGRICULTURE, SOUTH SAN FRANCISCO, CA. FILED 3-27-2007.

GREAT CHEESE COMES FROM HAPPY COWS - HAPPY COWS COME FROM CALIFORNIA

THE MARK CONSISTS OF STANDARD CHARACTERS WITHOUT CLAIM TO ANY PARTICULAR FONT, STYLE, SIZE, OR COLOR.

FOR PROMOTION AND MARKETING SERVICES, NAMELY PROMOTING THE INTERESTS OF MILK PRODUCERS THROUGH COMMERCIAL ADVERTISEMENTS PROMOTING MILK AND MILK PRODUCTS IN THE FORM OF TELEVISION, RADIO, PRINT AND ELECTRONIC MEDIA, MARKETING PROGRAMS INVOLVING DISTRIBUTION OF PROMOTIONAL MATERIALS; CONSULTING SERVICES CONCERNING PROMOTION AND MARKETING SERVICES FOR MILK PRODUCERS; DISTRIBUTION AND DISSEMINATION OF ADVERTISING MATERIAL IN THE NATURE OF PRINTED MATERIAL (U.S. CLS. 100, 101 AND 102).

FIRST USE 10-16-2000; IN COMMERCE 10-16-2000.

SAMUEL E. SHARPER JR., EXAMINING ATTORNEY

SN 76-675,112. VUZION, INC., PLYMOUTH, MN. FILED 4-5-2007.

NO CLAIM IS MADE TO THE EXCLUSIVE RIGHT TO USE "DENTAL DATA SERVICES", APART FROM THE MARK AS SHOWN.

THE COLOR(S) ORANGE AND WARM GRAY IS/ARE CLAIMED AS A FEATURE OF THE MARK.

THE COLOR ORANGE APPEARS IN THE FIFTH LETTER IN THE NAME "VUZION", A STYLIZED LETTER "OH", AND THE SHAPES INTERLOCKING WITH THE LETTER "OH", AND WARM GRAY APPEARS IN ALL OTHER LETTERS AND WORDS.

THE MARK CONSISTS OF THE WORDING "VUZION DENTAL DATA SERVICES". THE FIFTH LETTER OF THE FIRST WORD, "VUZION" CONSISTS OF A STYLIZED LETTER "OH" WITH TWO SMALLER INTERLOCKING SHAPES, SIMILAR TO THE LETTER "OH", LOCATED AT THE TOP OF THE LETTER "OH", AND EXTENDING WITHIN AND ABOVE THE LETTER AS MORE PARTICULARLY SHOWN IN THE DRAWING BELOW. BELOW "VUZION" ARE THE WORDS "DENTAL DATA SERVICES".

FOR BUSINESS CONSULTING SERVICES, NAMELY FOR DENTAL AND HEALTH CARE RELATED BUSINESS WITH AN EMPHASIS ON INSURANCE AND CLAIMS PROCESSING (U.S. CLS. 100, 101 AND 102).

FIRST USE 7-7-2006; IN COMMERCE 9-1-2006.
ROSELLE HERRERA, EXAMINING ATTORNEY

CLASS 35—(Continued).

SN 76-675,368. ORGHIPCHICK, LIVERMORE, CA. FILED 4-11-2007.

ORGHIPCHICK

THE MARK CONSISTS OF STANDARD CHARACTERS WITHOUT CLAIM TO ANY PARTICULAR FONT, STYLE, SIZE, OR COLOR.

FOR RETAIL AND ONLINE RETAIL STORE SERVICES FEATURING WOMEN'S AND MEN'S CLOTHING (U.S. CLS. 100, 101 AND 102).

FIRST USE 1-1-2004; IN COMMERCE 1-1-2004.

REBECCA POVARCHUK, EXAMINING ATTORNEY

CLASS 35—(Continued).

SN 76-675,678. INTERNATIONAL ASSOCIATION OF BENEFITS, ARLINGTON, TX. FILED 4-17-2007.

I-MEDHEALTH

THE MARK CONSISTS OF STANDARD CHARACTERS WITHOUT CLAIM TO ANY PARTICULAR FONT, STYLE, SIZE, OR COLOR.

FOR PROMOTING A DISCOUNT MEDICAL BENEFITS PLAN OF OTHERS TO MEMBERS OF A NON-PROFIT ORGANIZATION THROUGH SPONSORSHIP ARRANGEMENTS (U.S. CLS. 100, 101 AND 102).

FIRST USE 1-0-2007; IN COMMERCE 1-0-2007.

KARANENDRA S. CHHINA, EXAMINING ATTORNEY

SN 76-675,636. ATLANTIC RENTALS AND SALES, INC., NEPTUNE, NJ. FILED 4-18-2007.

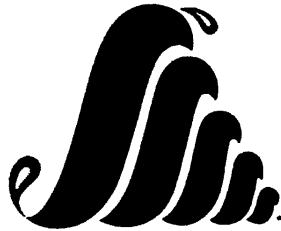

THE MARK IS COMPRISED OF THE DESIGN OF A WAVE IN A TRIANGULAR FORM.

FOR RENTAL OF SHOWCASES AND DISPLAY EQUIPMENT FOR THE MERCHANDISING FIELD (U.S. CLS. 100, 101 AND 102).

FIRST USE 9-1-1996; IN COMMERCE 9-1-1996.

LINDA E. BLOHM, EXAMINING ATTORNEY

SN 77-001,409. PALIK, DAVID ANDREW, BROKEN ARROW, OK. FILED 9-18-2006.

THE ROCKIN'

THE MARK CONSISTS OF STANDARD CHARACTERS WITHOUT CLAIM TO ANY PARTICULAR FONT, STYLE, SIZE, OR COLOR.

FOR BUSINESS DEVELOPMENT SERVICES, NAMELY, PROVIDING START-UP SUPPORT FOR BUSINESSES OF OTHERS (U.S. CLS. 100, 101 AND 102).

JAMES LOVELACE, EXAMINING ATTORNEY

SN 76-675,637. ATLANTIC RENTALS AND SALES, INC., NEPTUNE, NJ. FILED 4-18-2007.

ATLANTIC RENTALS AND SALES

THE MARK CONSISTS OF STANDARD CHARACTERS WITHOUT CLAIM TO ANY PARTICULAR FONT, STYLE, SIZE, OR COLOR.

NO CLAIM IS MADE TO THE EXCLUSIVE RIGHT TO USE "RENTALS AND SALES", APART FROM THE MARK AS SHOWN.

SEC. 2(F).

FOR RENTAL OF SHOWCASES AND DISPLAY EQUIPMENT FOR THE MERCHANDISING FIELD (U.S. CLS. 100, 101 AND 102).

FIRST USE 9-1-1996; IN COMMERCE 9-1-1996.

LINDA E. BLOHM, EXAMINING ATTORNEY

SN 77-001,769. LERNCO, INC., NEW YORK, NY. FILED 9-18-2006.

NEW YORK & COMPANY REWARDS CLUB

THE MARK CONSISTS OF STANDARD CHARACTERS WITHOUT CLAIM TO ANY PARTICULAR FONT, STYLE, SIZE, OR COLOR.

OWNER OF U.S. REG. NOS. 2,507,567, 3,026,644 AND OTHERS.

NO CLAIM IS MADE TO THE EXCLUSIVE RIGHT TO USE "REWARDS CLUB", APART FROM THE MARK AS SHOWN.

SEC. 2(F).

FOR RETAIL SERVICES, NAMELY, A CUSTOMER LOYALTY REWARDS PROGRAM FOR COMMERCIAL, PROMOTIONAL AND ADVERTISING PURPOSES (U.S. CLS. 100, 101 AND 102).

NATALIE POLZER, EXAMINING ATTORNEY

CLASS 35—(Continued).

SN 77-003,873. VALLARTA SUPERMARKETS, INC., SAN FERNANDO, CA. FILED 9-21-2006.

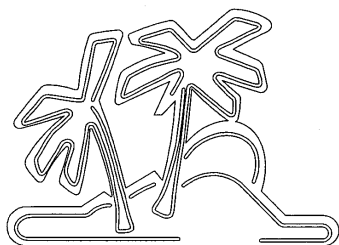

THE MARK CONSISTS OF PALM TREE DESIGN. FOR RETAIL GROCERY STORES (U.S. CLS. 100, 101 AND 102).

FIRST USE 12-0-1995; IN COMMERCE 12-0-1995.
MARY MUNSON, EXAMINING ATTORNEY

SN 77-004,047. SPEEDWEASELS LTD., MILFORD, OH. FILED 9-21-2006.



NO CLAIM IS MADE TO THE EXCLUSIVE RIGHT TO USE "PERFORMANCE WAREHOUSE", APART FROM THE MARK AS SHOWN.

THE MARK CONSISTS OF A DESIGN OF A WEASEL AND THE WORDS SPEEDWEASELS PERFORMANCE WAREHOUSE.

FOR RETAIL AUTOMOBILE PARTS AND ACCESSORIES STORES (U.S. CLS. 100, 101 AND 102).

FIRST USE 5-8-2006; IN COMMERCE 5-8-2006.
JANICE KIM, EXAMINING ATTORNEY

CLASS 35—(Continued).

SN 77-005,860. SHOPPING EPINIONS INTERNATIONAL LIMITED, DUBLIN 15, IRELAND, FILED 9-22-2006.



FOR OPERATING MARKETPLACES ON A GLOBAL COMMUNICATIONS NETWORK TO CONNECT BUYERS WITH SELLERS OF GOODS AND SERVICES; PROVIDING A SEARCHABLE ONLINE ADVERTISING GUIDE FEATURING THE GOODS AND SERVICES OF OTHERS; PROMOTING THE SALE OF GOODS AND SERVICES OF OTHERS AND PROVIDING ACCESS LINKS TO SELLERS THROUGH A GLOBAL COMMUNICATIONS NETWORK; ADVERTISING SERVICES, NAMELY, DISSEMINATION OF ADVERTISING FOR OTHERS VIA A GLOBAL COMMUNICATIONS NETWORK; CONSUMER COMPARISON SHOPPING SERVICES; INFOMEDIARY SERVICES, NAMELY, FACILITATING TRANSACTIONS BETWEEN BUYERS AND SELLERS THROUGH PROVIDING BUYERS WITH INFORMATION ABOUT SELLERS AND THEIR RESPECTIVE GOODS AND SERVICES, CONSUMER PRODUCTS, PRODUCT AVAILABILITY, AND DISCOUNTS AND PROMOTIONS; PROVIDING A WEBSITE FEATURING PRODUCT FEATURES, RATINGS AND REVIEWS OF THE CONSUMER GOODS OF OTHERS IN THE FIELD OF GENERAL CONSUMER GOODS FOR USE BY CONSUMERS; PROVIDING A WEBSITE FEATURING BUSINESS REVIEWS OF THE CONSUMER SERVICES OF OTHERS IN THE FIELD OF GENERAL CONSUMER GOODS; BUSINESS SERVICES, NAMELY, PROVIDING COMPUTER DATABASES RELATING TO CONSUMER PRODUCTS AND MERCHANT BUSINESS DIRECTORY INFORMATION REGARDING THE PURCHASE AND SALE OF A WIDE VARIETY OF PRODUCTS AND SERVICES OF OTHERS (U.S. CLS. 100, 101 AND 102).

TASHIA BUNCH, EXAMINING ATTORNEY

SN 77-007,141. COUPON CHIEF, INC., SAN DIEGO, CA. FILED 9-25-2006.

CouponChief

THE MARK CONSISTS OF STANDARD CHARACTERS WITHOUT CLAIM TO ANY PARTICULAR FONT, STYLE, SIZE, OR COLOR.

FOR PROMOTING, ADVERTISING AND MARKETING OF THE ON-LINE WEBSITES OF OTHERS (U.S. CLS. 100, 101 AND 102).

FIRST USE 1-15-2005; IN COMMERCE 3-26-2005.
TIMOTHY FINNEGAN, EXAMINING ATTORNEY

CLASS 35—(Continued).

SN 77-008,580. CERTAINTeed CORPORATION, VALLEY FORGE, PA. FILED 9-27-2006.

CERTAQUOTE

THE MARK CONSISTS OF STANDARD CHARACTERS WITHOUT CLAIM TO ANY PARTICULAR FONT, STYLE, SIZE, OR COLOR.

FOR INFORMATION SERVICES, NAMELY PROVIDING REAL-TIME PRICE QUOTES FOR BUILDING PRODUCTS, BY MEANS OF DEALER-BASED COMPUTERIZED INFORMATION NETWORK (U.S. CLS. 100, 101 AND 102).

CARYN GLASSER, EXAMINING ATTORNEY

SN 77-009,137. KLINER JR., WESLEY R., MCDONALD, TN. FILED 9-27-2006.

My Little Place

THE MARK CONSISTS OF STANDARD CHARACTERS WITHOUT CLAIM TO ANY PARTICULAR FONT, STYLE, SIZE, OR COLOR.

FOR REAL ESTATE MARKETING SERVICES IN THE FIELD OF HISTORIC AND CONSERVATION LAND TRUST PROPERTY FOR THE PURPOSE OF CHARITABLE FUND RAISING (U.S. CLS. 100, 101 AND 102).

EVELYN BRADLEY, EXAMINING ATTORNEY

SN 77-014,444. D&D COMMUNICATIONS GROUP, LLC, CUMMING, GA. FILED 10-5-2006.



OWNER OF U.S. REG. NOS. 2,871,463, 3,121,734 AND OTHERS.

NO CLAIM IS MADE TO THE EXCLUSIVE RIGHT TO USE "COMMERCIAL CONSTRUCTION SHOW", APART FROM THE MARK AS SHOWN.

THE COLOR(S) DARK BLUE, BLUE-GREEN, YELLOW AND WHITE IS/ARE CLAIMED AS A FEATURE OF THE MARK.

THE MARK CONSISTS OF A BLUE-GREEN BOX ACROSS THE TOP WITH THE CAPITALIZED WORD "COMMERCIAL" WRITTEN IN WHITE WITHIN THE BOX. BELOW THE BLUE-GREEN BOX IS THE WORD "CONSTRUCTION" WRITTEN IN DARK BLUE ON A WHITE BACKGROUND. BELOW THE WORD "CONSTRUCTION" IS A STYLIZED FACSIMILE OF THE WORD "SHOW" ALSO WITH A WHITE BACKGROUND AND WRITTEN IN DARK BLUE LETTERS WHICH ARE APPROXIMATELY THREE TIMES LARGER THAN THE SIZE OF THE WORDS "COMMERCIAL" AND

CLASS 35—(Continued).

"CONSTRUCTION". THE "O" IN THE WORD "SHOW" IS REPLACED BY A DIAGONALLY ORIENTED YELLOW HARD HAT. THE UPPER MOST POINT OF THE HARD HAT BEGINS UNDER THE LETTER "U" IN "CONSTRUCTION" AND THE BILL OF THE HARD HAT DIPS BELOW THE REST OF THE WORD "SHOW". THE LEFT SIDE OF THE HAT OVERLAPS THE LETTER "H" IN THE WORD "SHOW" AND THE RIGHT SIDE OF THE HAT OVERLAPS THE LETTER "W". THE HARD HAT IS GIVEN A THREE DIMENSIONAL APPEARANCE BY SHADOWING WITH A DARKER YELLOW AND A THIN SHADOW BELOW THE HAT OF DARK BLUE.

FOR ARRANGING AND CONDUCTING TRADE SHOW EXHIBITIONS IN THE FIELD OF CONSTRUCTION, NAMELY, TRADE SHOW EXHIBITIONS FEATURING SPECIALIZED MATERIALS, PRODUCTS AND SERVICES FOR CONSTRUCTION, ARCHITECTURAL AND FUNCTIONAL ASPECTS OF HEALTHCARE, RETAIL AND HOSPITALITY DESIGN, BUILDING AND MANAGEMENT (U.S. CLS. 100, 101 AND 102).

FIRST USE 3-20-2006; IN COMMERCE 3-20-2006.

JOHN DALIER, EXAMINING ATTORNEY

SN 77-017,832. SUPER BUY TIRES, INC., BELLFLOWER, CA. FILED 10-10-2006.

SUPER BUY TIRES

THE MARK CONSISTS OF STANDARD CHARACTERS WITHOUT CLAIM TO ANY PARTICULAR FONT, STYLE, SIZE, OR COLOR.

NO CLAIM IS MADE TO THE EXCLUSIVE RIGHT TO USE "TIRES", APART FROM THE MARK AS SHOWN.

SEC. 2(F).

FOR ONLINE RETAIL STORE SERVICES IN THE FIELD OF CUSTOM COORDINATED WHEELS AND TIRES AND FEATURING ONLINE CONSUMER PRODUCT INFORMATION IN THE NATURE OF INTERACTIVE IMAGES OF VARIOUS AUTOMOBILES COORDINATED WITH SELECTED WHEELS AND TIRES (U.S. CLS. 100, 101 AND 102).

FIRST USE 0-0-1995; IN COMMERCE 0-0-1995.

STEVEN PEREZ, EXAMINING ATTORNEY

CLASS 35—(Continued).

SN 77-019,535. PARK AVENUE BUILDING AND ROOFING SUPPLIES, LLC, BROOKLYN, NY. FILED 10-12-2006.



NO CLAIM IS MADE TO THE EXCLUSIVE RIGHT TO USE "BUILDING AND ROOFING SUPPLIES, LLC", APART FROM THE MARK AS SHOWN.

THE MARK CONSISTS OF A ROOF, A CITYSCAPE, AND STYLIZED TEXT OF THE WORDS, "PARK AVENUE BUILDING AND ROOFING SUPPLIES, LLC THE QUALITY BRANDS YOUR PROJECT DEMANDS".

FOR RETAIL STORES FEATURING BRICK, BLOCK, PAINT, SAND, GRAVEL, STEEL, ELECTRICAL SUPPLIES, SCREWS, NAILS, ROOFING, DRYWALL, FLOORING, LUMBER, HARDWARE, PLUMBING, CLEANING SUPPLIES, TOOLS AND INSULATION (U.S. CLS. 100, 101 AND 102).

FIRST USE 1-28-2001; IN COMMERCE 1-28-2001.
ANGELA M. MICHELI, EXAMINING ATTORNEY

CLASS 35—(Continued).

SN 77-022,852. PROTRANS INTERNATIONAL, INC., INDIA-NAPOLIS, IN. FILED 10-17-2006.

PROTRANS LOGISTICS

THE MARK CONSISTS OF STANDARD CHARACTERS WITHOUT CLAIM TO ANY PARTICULAR FONT, STYLE, SIZE, OR COLOR.

OWNER OF U.S. REG. NOS. 2,207,108, 2,218,558 AND 2,544,779.

NO CLAIM IS MADE TO THE EXCLUSIVE RIGHT TO USE "LOGISTICS", APART FROM THE MARK AS SHOWN.

FOR SUPPLY LOGISTICS SERVICES, NAMELY, SCHEDULING SHIPMENTS FOR USERS OF TRANSPORTATION SERVICES; LOGISTICS MANAGEMENT IN THE FIELD OF TRANSPORTATION, NAMELY, ARRANGING THE TRANSPORTATION OF GOODS FOR OTHERS; TRANSPORTATION MANAGEMENT, NAMELY, PLANNING AND COORDINATING TRANSPORTATION OF GOODS FOR OTHERS; INVENTORY MANAGEMENT IN THE FIELD OF TRANSPORTATION (U.S. CLS. 100, 101 AND 102).

EVELYN BRADLEY, EXAMINING ATTORNEY

SN 77-021,391. TOTALLY FURNITURE, INC., SHERMAN OAKS, CA. FILED 10-14-2006.

Totally Furniture

THE MARK CONSISTS OF STANDARD CHARACTERS WITHOUT CLAIM TO ANY PARTICULAR FONT, STYLE, SIZE, OR COLOR.

NO CLAIM IS MADE TO THE EXCLUSIVE RIGHT TO USE "FURNITURE", APART FROM THE MARK AS SHOWN.

FOR ON-LINE RETAIL STORE SERVICES FEATURING FURNITURE; AND RETAIL FURNITURE STORES (U.S. CLS. 100, 101 AND 102).

FIRST USE 11-20-2002; IN COMMERCE 11-20-2002.
BILL DAWE, EXAMINING ATTORNEY

SN 77-022,966. GALLEY, MARK R, WESTPORT, CT. FILED 10-17-2006.

Spitfire Interactive

THE MARK CONSISTS OF STANDARD CHARACTERS WITHOUT CLAIM TO ANY PARTICULAR FONT, STYLE, SIZE, OR COLOR.

NO CLAIM IS MADE TO THE EXCLUSIVE RIGHT TO USE "INTERACTIVE", APART FROM THE MARK AS SHOWN.

FOR ADVERTISING AND ADVERTISEMENT SERVICES; ADVERTISING AND PROMOTION SERVICES AND RELATED CONSULTING (U.S. CLS. 100, 101 AND 102).

CIMMERIAN COLEMAN, EXAMINING ATTORNEY

CLASS 35—(Continued).

SN 77-024,264. SILICON VALLEY ASSOCIATION OF REALTORS, LOS ALTOS, CA. FILED 10-18-2006.

REALTOR SERVICE VOLUNTEER
PROGRAM SPONSORED BY
SILICON VALLEY ASSOCIATION
OF REALTORS

THE MARK CONSISTS OF STANDARD CHARACTERS WITHOUT CLAIM TO ANY PARTICULAR FONT, STYLE, SIZE, OR COLOR.

NO CLAIM IS MADE TO THE EXCLUSIVE RIGHT TO USE "SERVICE VOLUNTEER PROGRAM SPONSORED BY SILICON VALLEY ASSOCIATION", APART FROM THE MARK AS SHOWN.

FOR CHARITABLE SERVICES, NAMELY ORGANIZING AND CONDUCTING VOLUNTEER PROGRAMS AND COMMUNITY SERVICE PROJECTS (U.S. CLS. 100, 101 AND 102).

RICHARD WHITE, EXAMINING ATTORNEY

SN 77-027,673. ASIA ADVERTISING LIMITED, HONG KONG, HONG KONG, FILED 10-24-2006.

MANOUCHE

THE MARK CONSISTS OF STANDARD CHARACTERS WITHOUT CLAIM TO ANY PARTICULAR FONT, STYLE, SIZE, OR COLOR.

OWNER OF U.S. REG. NO. 2,851,630.

THE ENGLISH TRANSLATION OF THE WORD IN THE MARK IS "A TRIBE OF FRENCH GYPSIES".

FOR RETAIL STORE SERVICES IN THE FIELDS OF CLOTHING, FOOTWEAR, HEADGEAR, FASHION ACCESSORIES, JEWELRY AND GOODS MADE OF LEATHER AND LEATHER IMITATIONS (U.S. CLS. 100, 101 AND 102).

FIRST USE 9-25-2006; IN COMMERCE 9-25-2006.
JOANNA DUKOVIC, EXAMINING ATTORNEY

SN 77-029,943. BOUNTYJOBS, INC., NEW YORK, NY. FILED 10-26-2006.

BOUNTYJOBS

THE MARK CONSISTS OF STANDARD CHARACTERS WITHOUT CLAIM TO ANY PARTICULAR FONT, STYLE, SIZE, OR COLOR.

FOR OPERATING ON-LINE MARKETPLACES FOR SELLERS OF GOODS AND/OR SERVICES; OPERATING ON-LINE MARKETPLACES FOR SELLERS OF GOODS AND/OR SERVICES IN THE FIELD OF EMPLOYEE RECRUITING AND PLACEMENT SERVICES; PROVIDING ON-LINE MARKETPLACES FOR SELLERS OF GOODS AND/OR SERVICES; PROVIDING ON-LINE INFORMATION IN THE FIELD OF EMPLOYEE RECRUITING AND PLACEMENT SERVICES (U.S. CLS. 100, 101 AND 102).

EMILY CHUO, EXAMINING ATTORNEY

CLASS 35—(Continued).

SN 77-031,019. SOUTHWIRE COMPANY, CARROLLTON, GA. FILED 10-27-2006.

PROJECT GIFT

THE MARK CONSISTS OF STANDARD CHARACTERS WITHOUT CLAIM TO ANY PARTICULAR FONT, STYLE, SIZE, OR COLOR.

NO CLAIM IS MADE TO THE EXCLUSIVE RIGHT TO USE "PROJECT", APART FROM THE MARK AS SHOWN.

FOR CHARITABLE SERVICES, NAMELY COORDINATION OF THE PROCUREMENT AND DISTRIBUTION OF FOOD DONATIONS FROM MANUFACTURERS, WHOLESALERS, RETAILERS, AND GOVERNMENT AGENCIES TO ORGANIZATIONS PROVIDING FREE FOOD TO NEEDY PEOPLE (U.S. CLS. 100, 101 AND 102).

FIRST USE 11-1-2005; IN COMMERCE 11-1-2005.
CHRISTINA SOBRAL, EXAMINING ATTORNEY

SN 77-034,490. WICKFORD EQUITIES, LLC, MINDEN, NV. FILED 11-1-2006.

HE SAID, SHE SAID

THE MARK CONSISTS OF STANDARD CHARACTERS WITHOUT CLAIM TO ANY PARTICULAR FONT, STYLE, SIZE, OR COLOR.

FOR PROVIDING A WEB SITE WHERE USERS CAN POST RATINGS, REVIEWS AND RECOMMENDATIONS ON PRODUCTS AND SERVICES (U.S. CLS. 100, 101 AND 102).

DORITT L. CARROLL, EXAMINING ATTORNEY

SN 77-034,515. WICKFORD EQUITIES, LLC, MINDEN, NV. FILED 11-1-2006.

HE SAID, HE SAID

THE MARK CONSISTS OF STANDARD CHARACTERS WITHOUT CLAIM TO ANY PARTICULAR FONT, STYLE, SIZE, OR COLOR.

FOR PROVIDING A WEB SITE WHERE USERS CAN POST RATINGS, REVIEWS AND RECOMMENDATIONS ON PRODUCTS AND SERVICES (U.S. CLS. 100, 101 AND 102).

DORITT L. CARROLL, EXAMINING ATTORNEY

CLASS 35—(Continued).

SN 77-034,535. FIDUCIARY ACTION PROGRAMS, LLC, LONG BEACH, CA. FILED 11-1-2006.

Fiduciary Action Fundamentals :
End-to-end Implementation Solutions

NO CLAIM IS MADE TO THE EXCLUSIVE RIGHT TO USE "END-TO-END IMPLEMENTATION SOLUTIONS", APART FROM THE MARK AS SHOWN.

THE COLOR(S) BLACK AND WHITE IS/ARE CLAIMED AS A FEATURE OF THE MARK.

THE MARK CONSISTS OF FIDUCIARY ACTION FUNDAMENTALS FONT IN ADOBE TIMES FONT. END-TO-END IMPLEMENTATIONS SOLUTIONS IS WHITE BOLD ITALIC TIMES FONT WITHIN A BLACK BOX LOCATED BELOW THE PHRASE FIDUCIARY ACTION FUNDAMENTALS.

FOR BUSINESS RECORDS MANAGEMENT (U.S. CLS. 100, 101 AND 102).

FIRST USE 3-3-2005; IN COMMERCE 3-10-2005.
DAVID TAYLOR, EXAMINING ATTORNEY

SN 77-035,017. METRO INTERNATIONAL S.A., L-2449 LUXEMBOURG, LUXEMBOURG, FILED 11-2-2006.



THE MARK CONSISTS OF TWO ADJACENT SHADED RECTANGLES, ONE DARKER AND ONE LIGHTER, WITH THE WORD METRO IN THE DARKER RECTANGLE AND THE WORDS LIFE PANEL IN THE LIGHTER RECTANGLE; THE O IN METRO IS REPRESENTED BY A STYLIZED GLOBE.

FOR CONDUCTING OPINION POLLS; CONDUCTING MARKET SURVEYS AND MARKET RESEARCH (U.S. CLS. 100, 101 AND 102).

FIRST USE 11-0-2005; IN COMMERCE 1-0-2007.
RON FAIRBANKS, EXAMINING ATTORNEY

SN 77-035,381. JACOBS, MICHAEL B., MIAMI BEACH, FL. FILED 11-2-2006.



NO CLAIM IS MADE TO THE EXCLUSIVE RIGHT TO USE "MEDITERASIA CONSULTING", APART FROM THE MARK AS SHOWN.

FOR OFFERING CONSULTATION AND TECHNICAL ASSISTANCE IN THE ESTABLISHMENT AND OPERATION OF TEMPORARY AND PERMANENT FOOD SERVICES (U.S. CLS. 100, 101 AND 102).

FIRST USE 9-0-2002; IN COMMERCE 9-0-2002.
ANDREA BUTLER, EXAMINING ATTORNEY

CLASS 35—(Continued).

SN 77-041,443. AMERICAN HOSPITAL ASSOCIATION, CHICAGO, IL. FILED 11-10-2006.



THE MARK CONSISTS OF A CIRCLE WITH A TREE WITH LEAVES THEREIN.

FOR ASSOCIATION SERVICES, NAMELY, PROMOTING DIVERSITY IN THE FIELD OF HEALTH MANAGEMENT BY SPONSORING AND DEVELOPING PROGRAMS FOR INDIVIDUALS TO AID IN THEIR CAREER DEVELOPMENTS ASSOCIATED WITH THE HEALTHCARE INDUSTRY (U.S. CLS. 100, 101 AND 102).
JOHN KELLY, EXAMINING ATTORNEY

SN 77-044,668. NATIONWIDE REAL ESTATE TAX SERVICE, INC., SANTA ROSA, CA. FILED 11-15-2006.

NATIONWIDE REAL ESTATE TAX
SERVICE

THE MARK CONSISTS OF STANDARD CHARACTERS WITHOUT CLAIM TO ANY PARTICULAR FONT, STYLE, SIZE, OR COLOR.

NO CLAIM IS MADE TO THE EXCLUSIVE RIGHT TO USE "REAL ESTATE TAX SERVICE", APART FROM THE MARK AS SHOWN.

SEC. 2(F).
FOR REAL ESTATE SUPPORT SERVICES NAMELY, PREPARATION OF REPORTS CONTAINING PROPERTY TAX AND FLOOD ZONE INFORMATION (U.S. CLS. 100, 101 AND 102).

FIRST USE 10-0-1987; IN COMMERCE 10-0-1988.
JAMES A. RAUEN, EXAMINING ATTORNEY

CLASS 35—(Continued).

SN 77-048,562. CHURCH, JUDITH L., NEW YORK, NY. FILED 11-21-2006.

MAKE THE BEST, BUILD THE
BEST, BE THE BEST

THE MARK CONSISTS OF STANDARD CHARACTERS WITHOUT CLAIM TO ANY PARTICULAR FONT, STYLE, SIZE, OR COLOR.

FOR ON-LINE RETAIL STORE SERVICES, MAIL ORDER CATALOGUE SERVICES AND RETAIL STORE SERVICES FEATURING PRODUCTS RELATING TO COOKING, HOME FURNISHING AND DESIGN, FOOD, BEVERAGES, CLOTHING, ARTWORK, AND HANDICRAFTS FOR HEALTHY LIVING, THAT ARE NATURAL, ORGANIC OR INCORPORATE SUSTAINABLE PRACTICES (U.S. CLS. 100, 101 AND 102).

KRISTINA MORRIS, EXAMINING ATTORNEY

SN 77-055,343. AFFINITY DIRECT, LLC, ENGLEWOOD CLIFFS, NJ. FILED 12-1-2006.

ED-LOCK

THE MARK CONSISTS OF STANDARD CHARACTERS WITHOUT CLAIM TO ANY PARTICULAR FONT, STYLE, SIZE, OR COLOR.

FOR MATCHING BORROWERS WITH POTENTIAL LENDERS IN THE FIELDS OF STUDENT AND MORTGAGE LENDING; REFERRALS IN THE FIELDS OF STUDENT AND MORTGAGE LENDING (U.S. CLS. 100, 101 AND 102).

JAMES STEIN, EXAMINING ATTORNEY

SN 77-059,009. FLEETCOR TECHNOLOGIES, INC., NORCROSS, GA. FILED 12-7-2006.

GC GASCARD

THE MARK CONSISTS OF STANDARD CHARACTERS WITHOUT CLAIM TO ANY PARTICULAR FONT, STYLE, SIZE, OR COLOR.

NO CLAIM IS MADE TO THE EXCLUSIVE RIGHT TO USE "GASCARD", APART FROM THE MARK AS SHOWN.

FOR DATA PROCESSING AND BILLING SERVICES IN CONNECTION WITH AN AUTOMATED VEHICLE FUEL SYSTEM FOR COMMERCIAL COMPANIES AND INDEPENDENT JOBBERS (U.S. CLS. 100, 101 AND 102).

FIRST USE 1-1-1982; IN COMMERCE 1-1-1982.

REGINA DRUMMOND, EXAMINING ATTORNEY

CLASS 35—(Continued).

SN 77-060,609. TSUI, AUGUSTINE, GLEN ROCK, NJ. FILED 12-8-2006.

小美的店

Small Beauty Shop

NO CLAIM IS MADE TO THE EXCLUSIVE RIGHT TO USE "BEAUTY SHOP" AND THE NON-LATIN CHARACTERS THAT MEAN "BEAUTY SHOP", APART FROM THE MARK AS SHOWN.

"THE NAME(S), PORTRAIT(S), AND/OR SIGNATURE(S) SHOWN IN THE MARK IDENTIFIES AUGUSTINE TSUI, WHOSE CONSENT(S) TO REGISTER IS SUBMITTED."

THE MARK CONSISTS OF STYLIZED TEXT AND CHINESE CHARACTERS.

THE FOREIGN WORDING IN THE MARK TRANSLATES INTO ENGLISH AS SMALL BEAUTY SHOP.

"THE NON-LATIN CHARACTER(S) IN THE MARK TRANSLITERATES INTO SIAO MEI DE DIAN, AND THIS MEANS SMALL BEAUTY SHOP IN ENGLISH."

FOR ON-LINE RETAIL STORE SERVICES FEATURING HEALTH, VITAMINS AND BEAUTY ITEMS (U.S. CLS. 100, 101 AND 102).

FIRST USE 6-19-2006; IN COMMERCE 6-19-2006.

NAKWAMA ANKRAH, EXAMINING ATTORNEY

SN 77-061,819. WYNN RESORTS HOLDINGS, LLC, LAS VEGAS, NV. FILED 12-11-2006.

W Y N N
ESPLANADE

OWNER OF U.S. REG. NOS. 2,983,691 AND 3,085,515.

THE MARK CONSISTS OF A STYLIZED CREST WITH STREAMERS AT ITS BASE, EMBLAZONED WITH LINES SUGGESTIVE OF THE LETTER "W" IN THE UPPER PORTION OF THE MARK, AND THE WORDS "WYNN ESPLANADE" IN THE LOWER PORTION OF THE MARK.

FOR RETAIL STORE SERVICES FEATURING A WIDE VARIETY OF CONSUMER GOODS OF OTHERS (U.S. CLS. 100, 101 AND 102).

KEVIN DINALLO, EXAMINING ATTORNEY

CLASS 35—(Continued).

SN 77-062,442. TES FRANCHISING LLC, SOUTHBURY, CT. FILED 12-12-2006.

FranMatch

THE MARK CONSISTS OF STANDARD CHARACTERS WITHOUT CLAIM TO ANY PARTICULAR FONT, STYLE, SIZE, OR COLOR.

OWNER OF U.S. REG. NO. 2,389,415.

FOR ASSISTANCE IN FRANCHISED COMMERCIAL BUSINESS MANAGEMENT; FRANCHISE SERVICES, NAMELY, OFFERING TECHNICAL AND BUSINESS MANAGEMENT ASSISTANCE IN THE ESTABLISHMENT AND OPERATION OF BUSINESSES THAT MATCH FRANCHISEES AND FRANCHISORS; FRANCHISING, NAMELY CONSULTATION AND ASSISTANCE IN BUSINESS MANAGEMENT, ORGANIZATION AND PROMOTION; FRANCHISING, NAMELY, OFFERING TECHNICAL ASSISTANCE IN THE ESTABLISHMENT AND/OR OPERATION OF BUSINESSES THAT MATCH FRANCHISEES WITH FRANCHISORS (U.S. CLS. 100, 101 AND 102).

FIRST USE 1-1-1998; IN COMMERCE 1-1-1998.
ANTHONY RINKER, EXAMINING ATTORNEY

CLASS 35—(Continued).

SN 77-066,362. CHERRY MARKETING INSTITUTE, INC., LANSING, MI. FILED 12-18-2006.



Cherries

Not just another berry.

NO CLAIM IS MADE TO THE EXCLUSIVE RIGHT TO USE "CHERRIES", APART FROM THE MARK AS SHOWN.

THE MARK CONSISTS OF THE WORDS CHERRIES NOT JUST ANOTHER BERRY AND DESIGN DEPICTING A CHERRY OVER THE WORD CHERRIES.

FOR ASSOCIATION SERVICES PROVIDED TO CHERRY PRODUCERS, NAMELY, ADVERTISING AND PROMOTING THE SALE, USE, AND CONSUMPTION OF CHERRIES (U.S. CLS. 100, 101 AND 102).

ESTHER A. BORSUK, EXAMINING ATTORNEY

SN 77-066,729. CUSTOM LIFESTYLES, LLC, STEWARTSVILLE, NJ. FILED 12-18-2006.

SN 77-065,146. RED PENGUIN, LLC, BRICK, NJ. FILED 12-15-2006.



NO CLAIM IS MADE TO THE EXCLUSIVE RIGHT TO USE "BRANDING", APART FROM THE MARK AS SHOWN. THE COLOR(S) RED, BLACK AND WHITE IS/ARE CLAIMED AS A FEATURE OF THE MARK.

THE MARK APPEAR WITH A LARGE WHITE RECTANGLE OUTLINED IN BLACK AND HAVING A SMALL BLACK RECTANGLE IN THE BOTTOM RIGHT CORNER; THE WORDING RED APPEARS IN RED; THE WORDING PENGUIN APPEARS IN BLACK; THE WORDING BRANDING MACHINES APPEARS IN WHITE; AND THE PENGUIN DESIGN APPEARS IN RED.

FOR ADVERTISING SERVICES; ADVERTISING AND PUBLICITY SERVICES; ADVERTISING SERVICES, NAMELY, PROMOTING THE GOODS AND SERVICES OF OTHERS THROUGH PUBLIC COMMUNICATION MEANS; MOBILE BILLBOARD ADVERTISING; RENTAL OF ADVERTISING SPACE (U.S. CLS. 100, 101 AND 102).

FIRST USE 9-0-2006; IN COMMERCE 9-0-2006.
JOANNA DUKOVIC, EXAMINING ATTORNEY



THE COLOR(S) RED, YELLOW AND BLACK IS/ARE CLAIMED AS A FEATURE OF THE MARK.

THE MARK CONSISTS OF THE WORDING DISPENSE DEPOT IN STYLIZED FORM, INCORPORATING THE DESIGN OF BEVERAGE CONTAINERS AND DISPENSERS. THE COLOR YELLOW APPEARS IN THE BEVERAGE PORTION OF THE DESIGN. THE COLOR RED APPEARS IN THE WORDING DISPENSE DEPOT AND IN THE DESIGN OF THE BEVERAGE DISPENSER, THE COLOR BLACK APPEARS IN THE OUTLINE AND IN THE DESIGN OF THE BEVERAGE CONTAINERS.

FOR ONLINE RETAIL STORE SERVICES AND RETAIL STORE SERVICES FEATURING APPLIANCES, HOUSEWARES, EQUIPMENT AND ACCESSORIES FOR DISPENSING BEER, WINE, SODA AND JUICE; WINE KITS, BEER KITS, PERSONALIZED WINE AND BEER ACCESSORIES AND BOTTLE RACKS (U.S. CLS. 100, 101 AND 102).

DAVID H. STINE, EXAMINING ATTORNEY

CLASS 35—(Continued).

SN 77-068,085. ASSOCIATION OF PHYSICIAN ASSISTANTS IN CARDIOVASCULAR SURGERY, ENGLEWOOD, CO. FILED 12-20-2006.



OWNER OF U.S. REG. NO. 2,331,296.
NO CLAIM IS MADE TO THE EXCLUSIVE RIGHT TO USE "SERVICE", "1981" AND "EDUCATION", APART FROM THE MARK AS SHOWN.

THE MARK CONSISTS OF A CIRCULAR EMBLEM DEPICTING A HEART ORGAN IN AN INNER CIRCLE AND SURROUNDED BY APACVS SERVICE 1981 EDUCATION IN AN OUTER CIRCLE.

FOR ASSOCIATION SERVICES, NAMELY, PROMOTING THE INTERESTS OF PHYSICIAN ASSISTANTS IN CARDIOVASCULAR SURGERY (U.S. CLS. 100, 101 AND 102).

FIRST USE 1-0-1988; IN COMMERCE 1-0-1988.
KATHY DE JONGE, EXAMINING ATTORNEY

CLASS 35—(Continued).

SN 77-070,273. HUMAN FACTORS ASSOCIATES, INCORPORATED, SALINAS, CA. FILED 12-22-2006.

HROES

THE MARK CONSISTS OF STANDARD CHARACTERS WITHOUT CLAIM TO ANY PARTICULAR FONT, STYLE, SIZE, OR COLOR.

FOR CONDUCTING BUSINESS AND MARKET RESEARCH SURVEYS (U.S. CLS. 100, 101 AND 102).

FIRST USE 6-1-2006; IN COMMERCE 6-1-2006.
BONNIE LUKEN, EXAMINING ATTORNEY

SN 77-070,356. TAYLOR GLOBAL, INC., NEW YORK, NY. FILED 12-22-2006.

SN 77-068,333. THE CHATTAHOOCHEE SNAPDRAGON, INC., COLUMBUS, GA. FILED 12-20-2006.

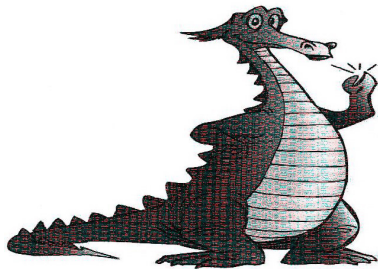

THE MARK CONSISTS OF DRAGON SNAPPING ITS FINGERS.

FOR RETAIL STORE SERVICES FEATURING A WIDE VARIETY OF CONSUMER GOODS OF OTHERS (U.S. CLS. 100, 101 AND 102).

FIRST USE 6-1-2002; IN COMMERCE 6-1-2002.
ROSELLE HERRERA, EXAMINING ATTORNEY

ALAN TAYLOR COMMUNICATIONS

THE MARK CONSISTS OF STANDARD CHARACTERS WITHOUT CLAIM TO ANY PARTICULAR FONT, STYLE, SIZE, OR COLOR.

NO CLAIM IS MADE TO THE EXCLUSIVE RIGHT TO USE COMMUNICATIONS, APART FROM THE MARK AS SHOWN.

THE NAME(S), PORTRAIT(S), AND/OR SIGNATURE(S) SHOWN IN THE MARK IDENTIFIES ALAN TAYLOR, WHOSE CONSENT(S) TO REGISTER IS MADE OF RECORD.

FOR PUBLIC AND MEDIA RELATIONS SERVICES; BUSINESS MARKETING CONSULTING IN THE FIELD OF BRAND DEVELOPMENT AND BRAND IDENTITY; PROMOTING SPORTS COMPETITIONS AND/OR EVENTS OF OTHERS; PROVIDING MARKETING AND PROMOTION OF SPECIAL EVENTS (U.S. CLS. 100, 101 AND 102).

FIRST USE 0-0-1984; IN COMMERCE 0-0-1984.
G. MAYERSCHOFF, EXAMINING ATTORNEY

CLASS 35—(Continued).

SN 77-078,795. THE QUO VADIS AGENCY, LLC, ATLANTA, GA. FILED 1-9-2007.

QUO VADIS

THE MARK CONSISTS OF STANDARD CHARACTERS WITHOUT CLAIM TO ANY PARTICULAR FONT, STYLE, SIZE, OR COLOR.

THE FOREIGN WORDING IN THE MARK TRANSLATES INTO ENGLISH AS WHERE ARE YOU GOING?

FOR ADVERTISING AND PUBLICITY SERVICES, NAMELY, PROMOTING THE GOODS, SERVICES, BRAND IDENTITY, AND COMMERCIAL INFORMATION OF THIRD PARTIES THROUGH PRINT, AUDIO, VIDEO, DIGITAL AND ON-LINE MEDIA; MARKET RESEARCH; CONSULTING SERVICES IN THE AREA OF ADVERTISING; PROVIDING ADVERTISING, MARKETING AND PROMOTIONAL SERVICES, NAMELY, DEVELOPMENT OF ADVERTISING CAMPAIGNS IN ANALOG AND DIGITAL MEDIA (U.S. CLS. 100, 101 AND 102).

JOHN DALIER, EXAMINING ATTORNEY

SN 77-082,478. FAMILY DOLLAR STORES OF MICHIGAN, INC., MATTHEWS, NC. FILED 1-12-2007.

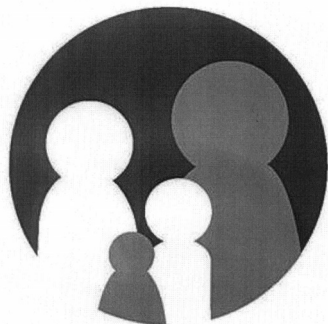

THE MARK CONSISTS OF A CIRCULAR GRAPHIC DESIGN WITH SILHOUETTE OF FOUR INDIVIDUALS INSIDE THE CIRCLE.

FOR RETAIL VARIETY STORE SERVICES (U.S. CLS. 100, 101 AND 102).

CHRISTOPHER BUONGIORNO, EXAMINING ATTORNEY

CLASS 35—(Continued).

SN 77-093,306. MOSQUERA, MARIA TERESA, SHERMAN OAKS, CA. FILED 1-29-2007.

MOSQUERA ENTERPRISES

THE MARK CONSISTS OF STANDARD CHARACTERS WITHOUT CLAIM TO ANY PARTICULAR FONT, STYLE, SIZE, OR COLOR.

NO CLAIM IS MADE TO THE EXCLUSIVE RIGHT TO USE "ENTERPRISES", APART FROM THE MARK AS SHOWN.

FOR TAX PREPARATION (U.S. CLS. 100, 101 AND 102).

FIRST USE 5-5-1995; IN COMMERCE 5-5-1995.
SHAILA SETTLES, EXAMINING ATTORNEY

SN 77-096,117. BEVERAGE SOLUTIONS INC., LAKE FOREST, IL. FILED 1-31-2007.

BEER ACROSS AMERICA

THE MARK CONSISTS OF STANDARD CHARACTERS WITHOUT CLAIM TO ANY PARTICULAR FONT, STYLE, SIZE, OR COLOR.

NO CLAIM IS MADE TO THE EXCLUSIVE RIGHT TO USE "BEER", APART FROM THE MARK AS SHOWN.

FOR MAIL ORDER SERVICES FEATURING BEER (U.S. CLS. 100, 101 AND 102).

FIRST USE 1-1-1991; IN COMMERCE 1-1-1991.
BRIDGETT SMITH, EXAMINING ATTORNEY

SN 77-098,778. ROCKY MOUNTAIN INSTITUTE, SNOWMASS, CO. FILED 2-4-2007.

ROCKY MOUNTAIN INSTITUTE

THE MARK CONSISTS OF STANDARD CHARACTERS WITHOUT CLAIM TO ANY PARTICULAR FONT, STYLE, SIZE, OR COLOR.

NO CLAIM IS MADE TO THE EXCLUSIVE RIGHT TO USE "INSTITUTE", APART FROM THE MARK AS SHOWN. SEC. 2(F).

FOR BUSINESS CONSULTING AND INFORMATION SERVICES, NAMELY, RESOURCE EFFICIENCY BASED CONSULTING AND INFORMATION SERVICES FOR BUSINESSES, COMMUNITIES, INDIVIDUALS, AND GOVERNMENTS TO CREATE MARKET BASED SOLUTIONS AND TO MAXIMIZE WEALTH AND EMPLOYMENT, PROTECT AND ENHANCE NATURAL AND HUMAN CAPITAL, AND INCREASE PROFIT AND COMPETITIVE ADVANTAGES (U.S. CLS. 100, 101 AND 102).

FIRST USE 4-30-1982; IN COMMERCE 4-30-1982.
JENNY PARK, EXAMINING ATTORNEY

CLASS 35—(Continued).

SN 77-102,120. PEAK IMPACT INC., OTTAWA, ONTARIO, CANADA, FILED 2-7-2007.



FOR BUSINESS MARKETING AND CONSULTING SERVICES, NAMELY, PROVIDING LEAD GENERATION SERVICES TO BUSINESSES AND INDIVIDUALS, NAMELY, CREATING AND IMPLEMENTING CUSTOMIZED REFERRAL AND LEAD GENERATION PROGRAMS FOR THIRD PARTIES AND CUSTOMIZED DATABASES FOR SALES, REFERRAL AND LEAD MANAGEMENT; BUSINESS MONITORING SERVICES, NAMELY, ANALYZING ON-LINE DATA CREATED BY WEBSITE TRAFFIC FOR THE PURPOSE OF PROVIDING BUSINESS INTELLIGENCE; BUSINESS CONSULTING SERVICES, NAMELY, CREATING AND IMPLEMENTING PROCESSES FOR OPTIMIZING WEBSITE TRAFFIC, SEARCH ENGINE RESULTS AND RELATED ADVERTISEMENT REVENUE (U.S. CLS. 100, 101 AND 102).

DOMINIC FATHY, EXAMINING ATTORNEY

SN 77-102,219. R. E. MASON ENTERPRISES, INC., FAYETTEVILLE, NC. FILED 2-8-2007.

Simple Gardening

THE MARK CONSISTS OF STANDARD CHARACTERS WITHOUT CLAIM TO ANY PARTICULAR FONT, STYLE, SIZE, OR COLOR.

NO CLAIM IS MADE TO THE EXCLUSIVE RIGHT TO USE "GARDENING", APART FROM THE MARK AS SHOWN.

FOR COMPUTERIZED ON-LINE RETAIL STORE SERVICES IN THE FIELD OF GARDENING PRODUCTS AND GARDEN-RELATED ITEMS (U.S. CLS. 100, 101 AND 102).

FIRST USE 1-1-2000; IN COMMERCE 1-1-2000.

TIMOTHY FINNEGAN, EXAMINING ATTORNEY

CLASS 35—(Continued).

SN 77-105,236. DE NOVO ENTERPRISES, LLC, HILLSBOROUGH, NJ. FILED 2-12-2007.



NO CLAIM IS MADE TO THE EXCLUSIVE RIGHT TO USE "TRAVEL-INSPIRED PRODUCTS" AND LONDON, BANGKOK, COPENHAGEN, VENICE, BUDAPEST, APART FROM THE MARK AS SHOWN.

THE APPLICANT CLAIMS COLOR AS A FEATURE OF THE MARK, NAMELY, BLACK, BLUE AND WHITE ARE CLAIMED AS FEATURES OF THE MARK.

THE MARK CONSISTS OF THE WORDS WANDERFUL PLACES TRAVEL-INSPIRED PRODUCTS RENDERED IN BLACK. THE BACKGROUND BORDER OF THE MARK IS BLUE AND ALSO CONTAINS THE DESIGN OF A SIGNPOST RENDERED IN WHITE AND CONTAINING THE DESTINATIONS, RENDERED IN BLACK, AS FOLLOWS: LONDON 3507 MI, BANGKOK 8681 MI, COPENHAGEN 3884 MI, VENICE 4198 MI, AND BUDAPEST 4412 MI.

FOR ON-LINE RETAIL STORE SERVICES FEATURING APPAREL (U.S. CLS. 100, 101 AND 102).

FIRST USE 12-20-2006; IN COMMERCE 12-20-2006.

TRICIA SONNEBORN, EXAMINING ATTORNEY

SN 77-107,363. AMERICAN INSTITUTE OF CERTIFIED PUBLIC ACCOUNTANTS, NEW YORK, NY. FILED 2-14-2007.



CENTER FOR AUDIT QUALITY

NO CLAIM IS MADE TO THE EXCLUSIVE RIGHT TO USE "CENTER FOR AUDIT QUALITY", APART FROM THE MARK AS SHOWN.

FOR ASSOCIATION SERVICES, NAMELY, PROMOTING THE INTERESTS OF INVESTORS AND AUDITORS IN QUALITY PUBLIC COMPANY AUDITS; PROVIDING INFORMATION TO INVESTORS AND PUBLIC COMPANY AUDITORS IN THE FIELD OF ACCOUNTANCY VIA THE INTERNET; PROMOTING PUBLIC AWARENESS OF PUBLIC COMPANY AUDITING STANDARDS (U.S. CLS. 100, 101 AND 102).

FIRST USE 1-30-2007; IN COMMERCE 1-30-2007.

DAVID MILLER, EXAMINING ATTORNEY

SN 77-109,877. TAYLOR GLOBAL, INC., NEW YORK, NY. FILED 2-16-2007.

Partners in Moving Brands Forward

THE MARK CONSISTS OF STANDARD CHARACTERS WITHOUT CLAIM TO ANY PARTICULAR FONT, STYLE, SIZE, OR COLOR.

FOR PUBLIC AND MEDIA RELATIONS SERVICES; BUSINESS MARKETING CONSULTING IN THE FIELD OF BRAND DEVELOPMENT AND BRAND IDENTITY; PROMOTING SPORTS COMPETITIONS AND/OR EVENTS OF OTHERS; PROVIDING MARKETING AND PROMOTION OF SPECIAL EVENTS (U.S. CLS. 100, 101 AND 102).

G. MAYERSCHOFF, EXAMINING ATTORNEY

CLASS 35—(Continued).

SN 77-114,559. CAMPANELLA, DIANA, SCOTTSDALE, AZ. FILED 2-23-2007.

Universeling

THE MARK CONSISTS OF STANDARD CHARACTERS WITHOUT CLAIM TO ANY PARTICULAR FONT, STYLE, SIZE, OR COLOR.

FOR PROMOTING PUBLIC AWARENESS ABOUT HOW TO ELIMINATE STEREOTYPING WITH NEW LABELING OF PERSONS AND GROUPS (U.S. CLS. 100, 101 AND 102).

JORDAN BAKER, EXAMINING ATTORNEY

SN 77-115,609. CONTREPRENEURS CORPORATION, INC., LOS ANGELES, CA. FILED 2-25-2007.

CONTREPRENEURS

THE MARK CONSISTS OF STANDARD CHARACTERS WITHOUT CLAIM TO ANY PARTICULAR FONT, STYLE, SIZE, OR COLOR.

FOR BUSINESS DEVELOPMENT SERVICES, NAMELY, PROVIDING START-UP SUPPORT FOR BUSINESSES OF OTHERS (U.S. CLS. 100, 101 AND 102).

GRETTA YAO, EXAMINING ATTORNEY

SN 77-118,331. TRANS-NET, INC., ISSAQUAH, WA. FILED 2-28-2007.

TRANS-NET CONCIERGE LOGISTICS

THE MARK CONSISTS OF STANDARD CHARACTERS WITHOUT CLAIM TO ANY PARTICULAR FONT, STYLE, SIZE, OR COLOR.

NO CLAIM IS MADE TO THE EXCLUSIVE RIGHT TO USE "TRANS-NET" AND "LOGISTICS", APART FROM THE MARK AS SHOWN.

FOR TRANSPORTATION LOGISTICS SERVICES, NAMELY, ARRANGING THE TRANSPORTATION OF GOODS FOR OTHERS BY AIR, GROUND, WATER AND RAIL (U.S. CLS. 100, 101 AND 102).

COLLEEN KEARNEY, EXAMINING ATTORNEY

CLASS 35—(Continued).

SN 77-119,675. 2B ADVERTISING, INCORPORATED, DEER-FIELD BEACH, FL. FILED 3-1-2007.



THE COLOR(S) YELLOW-GOLD AND WHITE IS/ARE CLAIMED AS A FEATURE OF THE MARK.

THE MARK CONSISTS OF A CIRCLE WITH AN ARROW AROUND THE RIGHT EDGE, WHERE THE CIRCLE AND ARROWS ARE IN YELLOW-GOLD AND 2B IS IN THE CENTER IN WHITE.

FOR ADVERTISING AGENCIES; ADVERTISING AGENCIES, NAMELY, PROMOTING THE GOODS AND SERVICES OF OTHERS; ADVERTISING AND ADVERTISEMENT SERVICES; ADVERTISING AND BUSINESS SERVICES, NAMELY, SECURING AIRTIME ON ALL FORMS OF MEDIA COMMUNICATIONS STATIONS, SYSTEMS, NETWORKS, AND SERVICES FOR THE PURPOSE OF PROMOTING THE GOODS AND SERVICES OF OTHERS; ADVERTISING AND COMMERCIAL INFORMATION SERVICES, VIA THE INTERNET; ADVERTISING AND MARKETING; ADVERTISING AND PROMOTION SERVICES AND RELATED CONSULTING; ADVERTISING AND PUBLICITY SERVICES; ADVERTISING AND PUBLICITY SERVICES, NAMELY, PROMOTING THE GOODS, SERVICES, BRAND IDENTITY AND COMMERCIAL INFORMATION AND NEWS OF THIRD PARTIES THROUGH PRINT, AUDIO, VIDEO, DIGITAL AND ON-LINE MEDIUM; ADVERTISING CONSULTATION; ADVERTISING PARTICULARLY SERVICES FOR THE PROMOTION OF GOODS; ADVERTISING SERVICES; ADVERTISING SERVICES OF A RADIO AND TELEVISION ADVERTISING AGENCY; ADVERTISING SERVICES, NAMELY, PROVIDING ADVERTISING SPACE IN A PERIODICAL; ADVERTISING SERVICES, NAMELY, CREATING CORPORATE AND BRAND IDENTITY FOR OTHERS; ADVERTISING SERVICES, NAMELY, CREATING CORPORATE LOGOS FOR OTHERS; ADVERTISING SERVICES, NAMELY, PROMOTING AND MARKETING THE GOODS AND SERVICES OF OTHERS THROUGH ALL PUBLIC COMMUNICATION MEANS; ADVERTISING THROUGH ALL PUBLIC COMMUNICATION MEANS; ADVERTISING VIA ELECTRONIC MEDIA AND SPECIFICALLY THE INTERNET; ADVERTISING, MARKETING AND PROMOTION SERVICES; AGENCIES FOR ADVERTISING

CLASS 35—(Continued).

TIME AND SPACE; COOPERATIVE ADVERTISING AND MARKETING; CREATING AND UPDATING ADVERTISING MATERIAL; CREATION OF MARKETING TOOLS DESIGNED TO INCREASE A CLIENT COMPANY'S KNOWLEDGE OF CUSTOMER NEEDS, AND ITS COMPETITORS' PRODUCTS AND SERVICES, PRICING, ADVERTISING STRATEGY AND SALES STRATEGY; CUSTOMER LOYALTY SERVICES AND CUSTOMER CLUB SERVICES, FOR COMMERCIAL, PROMOTIONAL AND/OR ADVERTISING PURPOSES; DESIGN OF ADVERTISING MATERIALS FOR OTHERS; DIRECT MAIL ADVERTISING; DIRECT MARKETING ADVERTISING FOR OTHERS; DISPLAYING ADVERTISEMENTS FOR OTHERS; DISSEMINATION OF ADVERTISEMENTS AND OF ADVERTISING MATERIAL; DISSEMINATION OF ADVERTISING FOR OTHERS VIA AN ON-LINE COMMUNICATIONS NETWORK ON THE INTERNET; DISSEMINATION OF ADVERTISING FOR OTHERS VIA THE INTERNET; DISSEMINATION OF ADVERTISING MATERIAL; DISSEMINATION OF ADVERTISING MATERIAL (U.S. CLS. 100, 101 AND 102).

FIRST USE 1-4-2006; IN COMMERCE 1-4-2006.
KIMBERLY FRYE, EXAMINING ATTORNEY

SN 77-122,321. ECOLOGY ACTION, SANTA CRUZ, CA. FILED 3-5-2007.



NO CLAIM IS MADE TO THE EXCLUSIVE RIGHT TO USE "ENERGY EFFICIENT LIGHTING PROGRAM", APART FROM THE MARK AS SHOWN.

THE COLOR(S) BLACK, BEIGE AND YELLOW IS/ARE CLAIMED AS A FEATURE OF THE MARK.

THE MARK CONSISTS OF THE COLOR BLACK APPEARS IN THE WORD RIGHT, IN THE WORDS ENERGY EFFICIENT LIGHTING PROGRAM AND IN THE OUTLINING OF THE COMPACT FLUORESCENT LIGHT BULB. THE COLOR YELLOW APPEARS IN THE WORD LIGHTS. THE COLOR BEIGE APPEARS IN THE COMPACT FLUORESCENT LIGHT BULB.

FOR ENERGY USAGE MANAGEMENT (U.S. CLS. 100, 101 AND 102).

FIRST USE 9-16-2003; IN COMMERCE 9-21-2003.
KELLEY WELLS, EXAMINING ATTORNEY

SN 77-122,891. PEGASUS RESEARCH, INC., PHOENIX, AZ. FILED 3-6-2007.

INTELEGILITY

THE MARK CONSISTS OF STANDARD CHARACTERS WITHOUT CLAIM TO ANY PARTICULAR FONT, STYLE, SIZE, OR COLOR.

FOR CONDUCTING MARKETING STUDIES; PROVIDING BUSINESS MARKETING AND DEMOGRAPHIC INFORMATION; AND CONDUCTING STATISTICAL EVALUATIONS OF MARKETING DATA (U.S. CLS. 100, 101 AND 102).

RENEE SERVANCE, EXAMINING ATTORNEY

CLASS 35—(Continued).

SN 77-124,819. AMERICAN COLLEGE OF CARDIOLOGY FOUNDATION, WASHINGTON, DC. FILED 3-7-2007.

CATHPCI REGISTRY

THE MARK CONSISTS OF STANDARD CHARACTERS WITHOUT CLAIM TO ANY PARTICULAR FONT, STYLE, SIZE, OR COLOR.

OWNER OF U.S. REG. NO. 3,207,161.

NO CLAIM IS MADE TO THE EXCLUSIVE RIGHT TO USE "REGISTRY", APART FROM THE MARK AS SHOWN.

FOR PROVIDING AN ONLINE REGISTRY FEATURING QUALITY ASSURANCE MEASUREMENT FOR DIAGNOSTIC CARDIAC CATHETERIZATIONS AND PERCUTANEOUS CORONARY INTERVENTION SERVICES FOR DOCTORS, HOSPITALS, AND LABS IN THE FIELD OF CARDIOLOGY AND CARDIOVASCULAR MEDICINE AND HEALTH (U.S. CLS. 100, 101 AND 102).

FIRST USE 6-30-2005; IN COMMERCE 6-30-2005.
PAULA MAHONEY, EXAMINING ATTORNEY

SN 77-126,256. EPLICA, INC, SAN DIEGO, CA. FILED 3-8-2007.



NO CLAIM IS MADE TO THE EXCLUSIVE RIGHT TO USE "VIRTUAL TIME-CAPTURE", APART FROM THE MARK AS SHOWN.

THE COLOR(S) YELLOW-ORANGE, WHITE, BLACK IS/ARE CLAIMED AS A FEATURE OF THE MARK.

THE MARK CONSISTS OF A SHADED YELLOW-ORANGE CAPITAL V IN "VCLOCK.NET". THE WORD "CLOCK" IS WHITE AND IN LOWERCASE. THE WORDING ".NET" IS IN YELLOW AND IN LOWERCASE. THE WORDING "VIRTUAL TIME-CAPTURE" IS IN WHITE AND LOCATED UNDERNEATH THE WORDS "VCLOCK.NET". THE ENTIRE MARK IS ON A BLACK BACKGROUND.

FOR PROVIDING ORGANIZING SERVICES FOR INDIVIDUALS AT HOME, IN HOME OFFICES AND IN BUSINESS OFFICES, THAT PROVIDES HELP WITH TIME AND PAPER MANAGEMENT (U.S. CLS. 100, 101 AND 102).

JESSICA FATHY, EXAMINING ATTORNEY

CLASS 35—(Continued).

SN 77-130,857. HICKS FAMILY TRUST, SAN LUIS OBISPO, CA. FILED 3-14-2007.

THE RIDE COALITION

THE MARK CONSISTS OF STANDARD CHARACTERS WITHOUT CLAIM TO ANY PARTICULAR FONT, STYLE, SIZE, OR COLOR.

NO CLAIM IS MADE TO THE EXCLUSIVE RIGHT TO USE "COALITION", APART FROM THE MARK AS SHOWN.

FOR RETAIL STORE SERVICES, MAIL-ORDER SERVICES AND ONLINE RETAIL STORE SERVICES IN THE FIELD OF SURF AND SKATEBOARD RELATED GOODS, EQUIPMENT, ACCESSORIES, NAMELY, SURFBOARDS, BODY BOARDS, BOOGIE BOARDS, WAKEBOARDS, SKATE DECKS, WHEELS, TRUCKS, PRE-ASSEMBLED DECKS, BEARINGS, HARDWARE, RISERS; RETAIL STORE SERVICES, MAIL-ORDER SERVICES AND ONLINE RETAIL STORE SERVICES FEATURING SURF AND SKATEBOARD RELATED ACCESSORIES, NAMELY, RASH GUARDS, SURFBOARD LEASHES, WET SUITS, COVERS AND PROTECTIVE BAGS FOR SPORTING APPARATUS, CARRY BAGS AND TOTES, SUN CARE PRODUCTS, SUNGLASSES, HELMETS, BANNERS, PATCHES, WAXES, BACKPACKS, WALLETS, VIDEOS, DVDS, CDS, CD-ROMS, AND SOUVENIRS, NOVELTY ITEMS AND GIFTS; RETAIL STORE SERVICES, MAIL-ORDER SERVICES AND ONLINE RETAIL STORE SERVICES FEATURING SURF AND SKATEBOARD RELATED CLOTHING AND APPAREL FOR MEN AND WOMEN, NAMELY, T-SHIRTS, PANTS, SHORTS, SWIMWEAR, SHOES, SANDALS, SWEATERS, DRESSES, SKIRTS, SHIRTS, BELTS (U.S. CLS. 100, 101 AND 102).

JAY BESCH, EXAMINING ATTORNEY

SN 77-133,765. OM DIRECT, SAN FRANCISCO, CA. FILED 3-17-2007.

Om Direct

THE MARK CONSISTS OF STANDARD CHARACTERS WITHOUT CLAIM TO ANY PARTICULAR FONT, STYLE, SIZE, OR COLOR.

NO CLAIM IS MADE TO THE EXCLUSIVE RIGHT TO USE "DIRECT", APART FROM THE MARK AS SHOWN.

FOR BUSINESS SERVICES, NAMELY INVENTORY TRACKING, ORDER PROCESSING, LOGISTICS MANAGEMENT, PREPARING BUSINESS REPORTS AND BUSINESS NETWORKING IN THE FOOD SUPPLY INDUSTRY (U.S. CLS. 100, 101 AND 102).

CAROLYN CATALDO, EXAMINING ATTORNEY

CLASS 35—(Continued).

SN 77-135,445. ONLINE INDICATOR CORP., WESTON, FL. FILED 3-20-2007.



NO CLAIM IS MADE TO THE EXCLUSIVE RIGHT TO USE "AUTO", APART FROM THE MARK AS SHOWN. THE MARK CONSISTS OF AUTOINDICATOR.COM.

FOR CONSULTING SERVICES IN THE FIELD OF AUTOMOTIVE DEALERSHIPS; PROVIDING AN ONLINE SEARCHABLE COMPUTER DATABASE FEATURING TRADE INFORMATION IN THE FIELD OF AUTOMOTIVE DEALERSHIPS (U.S. CLS. 100, 101 AND 102).

WILLIAM BRECKENFELD, EXAMINING ATTORNEY

SN 77-136,145. CAUSEWARE LLC, ISSAQUAH, WA. FILED 3-21-2007.

UberSquare

THE MARK CONSISTS OF STANDARD CHARACTERS WITHOUT CLAIM TO ANY PARTICULAR FONT, STYLE, SIZE, OR COLOR.

FOR PROVIDING A WEB SITE THAT ENABLES BUYERS OF SERVICES TO CONNECT WITH SELLERS OF SERVICES AND RECEIVE MULTIPLE QUOTATIONS; PROVIDING A WEB SITE THAT ENABLES USERS TO POST RATINGS, REVIEWS AND RECOMMENDATIONS ON SERVICES AND SERVICE PROVIDERS (U.S. CLS. 100, 101 AND 102).

FIRST USE 3-20-2007; IN COMMERCE 3-20-2007.

TASHIA BUNCH, EXAMINING ATTORNEY

SN 77-136,295. SOFT-MOC INC., WHITBY, ONTARIO, CANADA, FILED 3-21-2007.

SOFTMOC

THE MARK CONSISTS OF STANDARD CHARACTERS WITHOUT CLAIM TO ANY PARTICULAR FONT, STYLE, SIZE, OR COLOR.

OWNER OF CANADA REG. NO. 554070, DATED 11-20-2001, EXPIRES 11-20-2016.

FOR RETAIL FOOTWEAR STORE SERVICES; ONLINE RETAIL STORE SERVICES FEATURING FOOTWEAR (U.S. CLS. 100, 101 AND 102).

FIRST USE 10-0-1990; IN COMMERCE 6-0-1997.

TASHIA BUNCH, EXAMINING ATTORNEY

CLASS 35—(Continued).

SN 77-136,313. GFC BRANDS, INC., WILMINGTON, DE. FILED 3-21-2007.

CLASS 35—(Continued).

SN 77-137,523. MARTINEZ, JUAN CARLOS, ARLINGTON, VA. FILED 3-22-2007.

comertia

FRESH TREASURES COLLECTION

THE MARK CONSISTS OF STANDARD CHARACTERS WITHOUT CLAIM TO ANY PARTICULAR FONT, STYLE, SIZE, OR COLOR.

NO CLAIM IS MADE TO THE EXCLUSIVE RIGHT TO USE "FRESH" AND "COLLECTION", APART FROM THE MARK AS SHOWN.

FOR RETAIL GROCERY STORE SERVICES; RETAIL STORE SERVICES FEATURING FRESH PRODUCE (U.S. CLS. 100, 101 AND 102).

FIRST USE 2-0-2007; IN COMMERCE 2-0-2007.
ANDREA HACK, EXAMINING ATTORNEY

THE MARK CONSISTS OF STANDARD CHARACTERS WITHOUT CLAIM TO ANY PARTICULAR FONT, STYLE, SIZE, OR COLOR.

FOR COMPUTERIZED ON-LINE ORDERING SERVICES FEATURING GENERAL MERCHANDISE AND GENERAL CONSUMER GOODS AND BUSINESS SUPPLIES; DISSEMINATION OF ADVERTISING OF GOODS AND SERVICES OF OTHERS VIA LOCAL AND GLOBAL COMPUTER NETWORKS; OPERATING ON-LINE MARKETPLACES FOR SELLERS OF GOODS AND/OR SERVICES, NAMELY, A WEB SITE ON A GLOBAL COMPUTER NETWORK BY WHICH THIRD PARTIES CAN OFFER GOODS AND SERVICES; PROVIDING AN ON-LINE COMMERCIAL INFORMATION DIRECTORY ON THE INTERNET, NAMELY, A DIRECTORY OF THIRD PARTY WEB SITES TO FACILITATE BUSINESS TRANSACTIONS; PROVIDING AN ON-LINE COMMERCIAL INFORMATION DIRECTORY ON THE INTERNET (U.S. CLS. 100, 101 AND 102).

FIRST USE 1-17-2002; IN COMMERCE 1-17-2002.
STEVEN PEREZ, EXAMINING ATTORNEY

SN 77-137,190. MAD @ METH INC., ROSEBURG, OR. FILED 3-21-2007.

SN 77-137,869. INFOUSA INC., OMAHA, NE. FILED 3-22-2007.

Mad @ Meth

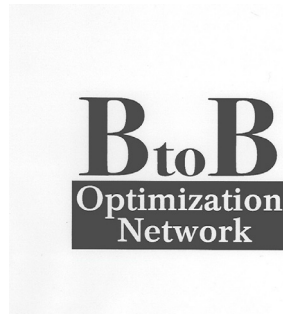

THE MARK CONSISTS OF STANDARD CHARACTERS WITHOUT CLAIM TO ANY PARTICULAR FONT, STYLE, SIZE, OR COLOR.

NO CLAIM IS MADE TO THE EXCLUSIVE RIGHT TO USE "METH", APART FROM THE MARK AS SHOWN.

FOR PROMOTING PUBLIC AWARENESS OF METHAMPHETAMINE USE AND ABUSE IN SOCIETY (U.S. CLS. 100, 101 AND 102).

JULIE THOMAS, EXAMINING ATTORNEY

NO CLAIM IS MADE TO THE EXCLUSIVE RIGHT TO USE "BTOB", APART FROM THE MARK AS SHOWN.

FOR BUSINESS MARKETING SERVICES, NAMELY, ONLINE DIRECT MARKETING SERVICES (U.S. CLS. 100, 101 AND 102).

AISHA CLARKE, EXAMINING ATTORNEY

CLASS 35—(Continued).

SN 77-138,471. WESTERN FARM SERVICE, INC., COLLINSVILLE, IL. FILED 3-23-2007.

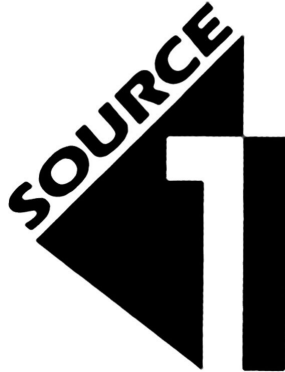

OWNER OF U.S. REG. NO. 1,396,216.
FOR DISTRIBUTORSHIP SERVICES IN THE FIELD OF AGRICULTURAL CHEMICALS, FERTILIZERS, AND INDUSTRIAL CHEMICALS (U.S. CLS. 100, 101 AND 102).
FIRST USE 8-9-1985; IN COMMERCE 8-9-1985.
HANNO RITTNER, EXAMINING ATTORNEY

SN 77-142,149. RESTORE ACQUISITION CORP., COLUMBIA, MD. FILED 3-28-2007.

FLAVORS

THE MARK CONSISTS OF STANDARD CHARACTERS WITHOUT CLAIM TO ANY PARTICULAR FONT, STYLE, SIZE, OR COLOR.
FOR PROMOTING THE SALE OF FOODS BY DISTRIBUTION OF RECIPES FEATURING SELECTED FOODS (U.S. CLS. 100, 101 AND 102).
FIRST USE 2-17-2004; IN COMMERCE 2-17-2004.
RICHARD A. STRASER, EXAMINING ATTORNEY

CLASS 35—(Continued).

SN 77-142,160. RESTORE ACQUISITION CORP., COLUMBIA, MD. FILED 3-28-2007.



NO CLAIM IS MADE TO THE EXCLUSIVE RIGHT TO USE "FOODS", APART FROM THE MARK AS SHOWN.
THE MARK CONSISTS OF THE WORDS FLAVORS BY MONARCH FOODS. A STYLIZED DESIGN OF A PLATE, KNIFE AND FORK TAKES THE PLACE OF THE LETTER "O" IN FLAVORS.
FOR PROMOTING THE SALE OF FOODS BY DISTRIBUTION OF RECIPES FEATURING SELECTED FOODS (U.S. CLS. 100, 101 AND 102).
FIRST USE 2-17-2004; IN COMMERCE 2-17-2004.
RICHARD A. STRASER, EXAMINING ATTORNEY

SN 77-142,273. MY HOME DOCTOR, LLC., MIAMI, FL. FILED 3-28-2007.



myhomedoctor

THE MARK CONSISTS OF A DEPICTION OF A CROSS AND A HOUSE. THE WORDS MYHOMEDOCTOR BELOW FOR APPOINTMENT SCHEDULING SERVICES IN THE FIELD OF HOME HEALTHCARE SERVICES (U.S. CLS. 100, 101 AND 102).
FIRST USE 8-9-2006; IN COMMERCE 9-20-2006.
JANICE L. MCMORROW, EXAMINING ATTORNEY

SN 77-144,999. BOYLAN, STAN, PALMDALE, CA. FILED 3-30-2007.



NO CLAIM IS MADE TO THE EXCLUSIVE RIGHT TO USE "SHIPPING CENTERS", APART FROM THE MARK AS SHOWN.
THE MARK CONSISTS OF A DESIGN AND THE WORDING "ALL AMERICAN SHIPPING CENTERS" AND "YOUR FAST FRIENDLY CONVENIENT SHIPPING CENTER." TWO HORIZONTAL LINES APPEAR BELOW THE WORD-

CLASS 35—(Continued).

ING, "ALL AMERICAN SHIPPING CENTERS." THIRTEEN STARS APPEAR WITHIN THE TWO HORIZONTAL LINES. TO THE RIGHT OF THE WORDING, "ALL AMERICAN SHIPPING CENTERS," APPEARS THREE CONCENTRIC CIRCLES. THE WORDING, "YOUR FAST FRIENDLY CONVENIENT SHIPPING CENTER," APPEARS IN THE FIRST BAND OF THE CONCENTRIC CIRCLES. AN EAGLE APPEARS IN THE MIDDLE OF THE CONCENTRIC CIRCLE, WHICH IS SUPERIMPOSED ON A MAP OF NORTH AND SOUTH AMERICA.

FOR ADVERTISING AND BUSINESS SERVICES, NAMELY BUSINESS MANAGEMENT; FRANCHISING SERVICES, NAMELY OFFERING TECHNICAL ASSISTANCE AND THE ESTABLISHMENT AND/OR OPERATION OF RETAIL MAILING, SHIPPING, PACKAGING, FAXING AND ELECTRONIC COMMUNICATIONS OUTLETS; RETAIL STORE SERVICES OFFERING STAMPS AND OFFICE SUPPLIES; PHOTOCOPY SERVICES AND DOCUMENT REPRODUCTION SERVICES (U.S. CLS. 100, 101 AND 102).

FIRST USE 8-15-2005; IN COMMERCE 8-15-2005.
CHARISMA HAMPTON, EXAMINING ATTORNEY

SN 77-147,795. THE MACERICH PARTNERSHIP, L.P., SANTA MONICA, CA. FILED 4-3-2007.

WE KNOW RETAILERS

THE MARK CONSISTS OF STANDARD CHARACTERS WITHOUT CLAIM TO ANY PARTICULAR FONT, STYLE, SIZE, OR COLOR.

NO CLAIM IS MADE TO THE EXCLUSIVE RIGHT TO USE "RETAILERS", APART FROM THE MARK AS SHOWN.

FOR ADVERTISING AND PUBLICITY SERVICES, NAMELY, PROMOTING THE GOODS, SERVICES, BRAND IDENTITY AND COMMERCIAL INFORMATION AND NEWS OF THIRD PARTIES THROUGH PRINT, AUDIO, VIDEO, DIGITAL AND ON-LINE MEDIUM; ADVERTISING PARTICULARLY SERVICES FOR THE PROMOTION OF GOODS; ADVERTISING, INCLUDING PROMOTION RELATING TO THE SALE OF ARTICLES AND SERVICES FOR THIRD PARTIES BY THE TRANSMISSION OF ADVERTISING MATERIAL AND THE DISSEMINATION OF ADVERTISING MESSAGES ON COMPUTER NETWORKS; ADVERTISING, MARKETING AND PROMOTION SERVICES; ARRANGING AND CONDUCTING OF FAIRS AND EXHIBITIONS FOR BUSINESS AND ADVERTISING PURPOSES; FASHION SHOW EXHIBITIONS FOR COMMERCIAL PURPOSES; LEASING OF SHOPPING MALL SPACE; PROVIDING ON-LINE INFORMATION RELATED TO LEASING OF SHOPPING MALL SPACE; CONDUCTING MARKETING STUDIES AND CONDUCTING MARKET RESEARCH AND PREPARING REPORTS IN CONNECTION THEREWITH; BUSINESS MARKETING CONSULTING SERVICES; PROVIDING BUSINESS MARKETING INFORMATION; BUSINESS CONSULTATION SERVICES IN THE FIELD OF LOCATIONS FOR RETAIL SHOPPING CENTER AND MALL TENANTS; BUSINESS CONSULTATION SERVICES FOR INVESTORS AND TENANTS OF UPSCALE RETAIL PROPERTIES; PROMOTING THE GOODS AND SERVICES OF OTHERS THROUGH MARKETING INITIATIVES FOR RETAIL SHOPPING CENTER AND MALL TENANTS; PUBLIC RELATIONS SERVICES; CUSTOMER SERVICE FOR TENANTS OF RETAIL SHOPPING CENTERS AND MALLS; OPERATION AND MANAGEMENT OF SHOPPING CENTERS AND MALLS FOR OTHERS (U.S. CLS. 100, 101 AND 102).

ESTHER A. BORSUK, EXAMINING ATTORNEY

CLASS 35—(Continued).

SN 77-148,182. TARGETING GROUP LLC, HOUSTON, TX. AND LOZANO, JOSE, HOUSTON, TX. FILED 4-4-2007.

MO7

THE MARK CONSISTS OF STANDARD CHARACTERS WITHOUT CLAIM TO ANY PARTICULAR FONT, STYLE, SIZE, OR COLOR.

FOR MOBILE INTERACTIVE MARKETING SERVICES, NAMELY, PROVIDING DIRECT MARKETING FOR OTHERS VIA TEXT MESSAGING, SHORT-MESSAGING SERVICES (SMS), SURVEYS, POLLS, CONTESTS, AND MULTIMEDIA MESSAGING SERVICES (MMS); ADVERTISING AND INTERACTIVE MARKETING SERVICES; ELECTRONIC COMMERCE SERVICES, NAMELY, PROVIDING INFORMATION PRODUCTS VIA TELECOMMUNICATIONS NETWORKS FOR ADVERTISING AND SALES PURPOSES (U.S. CLS. 100, 101 AND 102).

FIRST USE 2-0-2007; IN COMMERCE 2-0-2007.
HEATHER BIDDULPH, EXAMINING ATTORNEY

SN 77-149,100. RVING SOLUTIONS, LLC, LAKEVIEW, OH. FILED 4-5-2007.



NO CLAIM IS MADE TO THE EXCLUSIVE RIGHT TO USE "RVING SOLUTIONS", APART FROM THE MARK AS SHOWN.

THE COLOR(S) GRAY, WHITE, BLACK AND BLUE IS/ARE CLAIMED AS A FEATURE OF THE MARK.

THE MARK CONSISTS OF THE WORDS RVING SOLUTIONS IN BLACK WITH A GRAY QUADRILATERAL BEHIND IT AND A BLACK PUZZLE PIECE ABOVE A BLUE PUZZLE PIECE.

FOR PROVIDING CONSUMER INFORMATION ABOUT RECREATIONAL VEHICLE PARTS AND ACCESSORIES BY MEANS OF THE INTERNET (U.S. CLS. 100, 101 AND 102).

FIRST USE 1-31-2007; IN COMMERCE 1-31-2007.
CAROLINE WOOD, EXAMINING ATTORNEY

CLASS 35—(Continued).

SN 77-149,154. BFRIEND, INC., CHICAGO, IL. FILED 4-5-2007.

CREATIVE PITCH.ORG DON'T
THROW AWAY YOUR CHANCE TO
HELP

THE MARK CONSISTS OF STANDARD CHARACTERS WITHOUT CLAIM TO ANY PARTICULAR FONT, STYLE, SIZE, OR COLOR.

FOR CHARITABLE SERVICES, NAMELY, COORDINATION OF THE COLLECTION AND DISTRIBUTION OF ART MATERIAL DONATIONS TO ART TEACHERS FOR UNDERSERVED CHILDREN (U.S. CLS. 100, 101 AND 102).

ROBIN MITTLER, EXAMINING ATTORNEY

SN 77-149,157. BFRIEND, INC., CHICAGO, IL. FILED 4-5-2007.



THE MARK CONSISTS OF A GARBAGE CAN WITH THE LID PARTIALLY OPEN TO THE LEFT OF THE WORDS CREATIVE PITCH.ORG DON'T THROW AWAY YOUR CHANCE TO HELP. THE LID OF THE GARBAGE CAN CONTAINS AN ARROW. THE WORD CREATIVE IS TO THE RIGHT OF THE GARBAGE CAN LID. UNDERNEATH CREATIVE IS A LINE, AND UNDER THAT IS THE WORDING PITCH.ORG, WITH THE ORG SITUATED SIDEWAYS. UNDERNEATH PITCH.ORG IS THE WORDING DON'T THROW AWAY YOUR CHANCE TO HELP. ENCLOSED IN A RECTANGULAR BORDER.

FOR CHARITABLE SERVICES, NAMELY, COORDINATION OF THE COLLECTION AND DISTRIBUTION OF ART MATERIAL DONATIONS TO ART TEACHERS FOR UNDERSERVED CHILDREN (U.S. CLS. 100, 101 AND 102).

ROBIN MITTLER, EXAMINING ATTORNEY

SN 77-149,778. SFG GROUP LLC, LAS VEGAS, NV. FILED 4-5-2007.

THE WORLD'S LARGEST GLASS
OF ICED TEA

THE MARK CONSISTS OF STANDARD CHARACTERS WITHOUT CLAIM TO ANY PARTICULAR FONT, STYLE, SIZE, OR COLOR.

FOR PROMOTING AND CONDUCTING TRADE SHOWS AND SPECIAL EVENTS FOR OTHERS IN THE FIELD OF TEA (U.S. CLS. 100, 101 AND 102).

JACLYN KIDWELL, EXAMINING ATTORNEY

CLASS 35—(Continued).

SN 77-150,341. DEFENSE RESEARCH INSTITUTE, INC., CHICAGO, IL. FILED 4-6-2007.



THE MARK CONSISTS OF STYLIZED DRI LETTERS NEXT TO TRIANGULAR BOXES WITH "THE VOICE OF THE DEFENSE BAR" UNDERNEATH.

FOR ASSOCIATION SERVICES, NAMELY, PROMOTING THE INTERESTS OF DEFENSE LAWYERS (U.S. CLS. 100, 101 AND 102).

FIRST USE 8-1-1998; IN COMMERCE 8-1-1998.

DAVID COLLIER, EXAMINING ATTORNEY

SN 77-150,832. FRESH DESIGN CORPORATION, NEW YORK, NY. FILED 4-6-2007.



NO CLAIM IS MADE TO THE EXCLUSIVE RIGHT TO USE "DESIGN", APART FROM THE MARK AS SHOWN.

FOR RETAIL JEWELRY STORE SERVICES, ON-LINE RETAIL JEWELRY STORE SERVICES, WHOLESALE STORES AND DISTRIBUTORSHIPS FEATURING JEWELRY (U.S. CLS. 100, 101 AND 102).

FIRST USE 5-31-2005; IN COMMERCE 5-31-2005.

YAT SYE, LEE, EXAMINING ATTORNEY

SN 77-151,136. COLLECTABLE PARTS INC., ORLANDO, FL. FILED 4-6-2007.

PRO FORCE ELECTRICAL

NO CLAIM IS MADE TO THE EXCLUSIVE RIGHT TO USE "ELECTRICAL", APART FROM THE MARK AS SHOWN.

FOR RETAIL STORE SERVICES FEATURING NEW AND REMANUFACTURED STARTERS, ALTERNATORS AND COMPONENTS (U.S. CLS. 100, 101 AND 102).

JENNY PARK, EXAMINING ATTORNEY

CLASS 35—(Continued).

SN 77-151,781. ROBYN LEVIN, DBA R. LEVIN MARKETING GROUP, SAN FRANCISCO, CA. FILED 4-9-2007.

Cocktail Napkin Plan

THE MARK CONSISTS OF STANDARD CHARACTERS WITHOUT CLAIM TO ANY PARTICULAR FONT, STYLE, SIZE, OR COLOR.

NO CLAIM IS MADE TO THE EXCLUSIVE RIGHT TO USE "PLAN", APART FROM THE MARK AS SHOWN.

FOR BUSINESS MARKETING SERVICES; PROVIDING INFORMATION IN THE FIELD OF MARKETING AND ON-LINE MARKETING MEDIA VIA THE INTERNET (U.S. CLS. 100, 101 AND 102).

FIRST USE 4-1-2004; IN COMMERCE 4-1-2004.
HENRY S. ZAK, EXAMINING ATTORNEY

SN 77-152,796. SCHAEFER, GLENN F., PITTSFORD, NY. FILED 4-10-2007.

Nine Lives Boxing Club

THE MARK CONSISTS OF STANDARD CHARACTERS WITHOUT CLAIM TO ANY PARTICULAR FONT, STYLE, SIZE, OR COLOR.

NO CLAIM IS MADE TO THE EXCLUSIVE RIGHT TO USE "BOXING CLUB", APART FROM THE MARK AS SHOWN.

FOR BOXING AGENCY SERVICES, NAMELY, MANAGEMENT OF AMATEUR AND PROFESSIONAL BOXERS AND PROMOTION OF BOXERS AND BOXING MATCHES (U.S. CLS. 100, 101 AND 102).

SCOTT SISUN, EXAMINING ATTORNEY

SN 77-152,811. ADVERTISING DATABASE, INC., NEW YORK, NY. FILED 4-10-2007.

ADVERTISING DATABASE EXPRESS

THE MARK CONSISTS OF STANDARD CHARACTERS WITHOUT CLAIM TO ANY PARTICULAR FONT, STYLE, SIZE, OR COLOR.

NO CLAIM IS MADE TO THE EXCLUSIVE RIGHT TO USE "ADVERTISING DATABASE", APART FROM THE MARK AS SHOWN.

FOR AN INTERNET-BASED DIRECTORY OF COMMERCIAL INFORMATION ABOUT BRAND AND ADVERTISING AGENCY NAMES AND NEWS, INCLUDING BRAND DEMOGRAPHIC AND GEOGRAPHICAL TARGETS, BUDGETS, PLUS OTHER MEDIA PLANNING CRITERIA, AND ONLINE INSTRUCTIONAL MANUALS, SOLD AS A UNIT (U.S. CLS. 100, 101 AND 102).

STEVEN PEREZ, EXAMINING ATTORNEY

CLASS 35—(Continued).

SN 77-152,908. BROWN, BRIAN, STONE MOUNTAIN, GA. FILED 4-10-2007.

BIEMENS

THE MARK CONSISTS OF STANDARD CHARACTERS WITHOUT CLAIM TO ANY PARTICULAR FONT, STYLE, SIZE, OR COLOR.

FOR ON-LINE RETAIL STORE SERVICES FEATURING HOUSEWARES, ELECTRONICS, DVDS AND CDS (U.S. CLS. 100, 101 AND 102).

LAURA HAMMEL, EXAMINING ATTORNEY

SN 77-152,964. ROUNTREE, ROSS, AUSTIN, TX. FILED 4-10-2007.



The Pawnshopper.Com

NO CLAIM IS MADE TO THE EXCLUSIVE RIGHT TO USE "THE PAWNSHOPPER.COM", APART FROM THE MARK AS SHOWN.

THE MARK CONSISTS OF A LARGE CIRCLE, WITH A BORDER. THERE IS A LARGE UPPER CASE P IN THE MIDDLE OF THE CIRCLE THAT IS THE SAME AS THE BORDER AROUND THE CIRCLE. THIS LOGO IS CENTERED DIRECTLY ABOVE THE WORDS "THE PAWNSHOPPER.COM".

FOR INVENTORY MANAGEMENT IN THE FIELD OF PAWN SHOPS (U.S. CLS. 100, 101 AND 102).

TONJA GASKINS, EXAMINING ATTORNEY

SN 77-153,408. ASTRUM, LLC, LAS VEGAS, NV. FILED 4-10-2007.

ASTRUM RECORDS

THE MARK CONSISTS OF STANDARD CHARACTERS WITHOUT CLAIM TO ANY PARTICULAR FONT, STYLE, SIZE, OR COLOR.

NO CLAIM IS MADE TO THE EXCLUSIVE RIGHT TO USE "RECORDS", APART FROM THE MARK AS SHOWN.

THE ENGLISH TRANSLATION OF ASTRUM IS STAR OR CONSTELLATION.

FOR RETAIL STORE SERVICES FEATURING AUDIO AND VIDEO RECORDINGS, CDS, DVDS, PHONORECORDS AND OPTICAL, MAGNETIC, DIGITAL AND ELECTRONIC DATA CARRIERS, CLOTHING, CLOTHING ACCESSORIES AND GENERAL CONSUMER MERCHANDISE; RETAIL GIFT SHOPS; AND ADVERTISING, MARKETING OF ENTERTAINERS, PERFORMERS, MUSICIANS AND SINGERS, AND PROMOTION SERVICES (U.S. CLS. 100, 101 AND 102).

REBECCA EISINGER, EXAMINING ATTORNEY

CLASS 35—(Continued).

SN 77-153,488. ALLIED INTERNET SOLUTIONS INC., HOUSTON, TX. FILED 4-10-2007.

FindaSeminar

NO CLAIM IS MADE TO THE EXCLUSIVE RIGHT TO USE "FIND A SEMINAR", APART FROM THE MARK AS SHOWN.

THE MARK CONSISTS OF 9 CIRCLES DISPLAYED IN A TIC TAC TOE BOARD SHAPE TO THE LEFT OF THE PHRASE FINDASEMINAR SIMILATE THE BACK OF HEADS IN A SEMINAR.

FOR ADVERTISING AND MARKETING; ADVERTISING THROUGH ALL PUBLIC COMMUNICATION MEANS; PROVIDING AN ONLINE DIRECTORY INFORMATION SERVICE FEATURING INFORMATION REGARDING SEMINARS (U.S. CLS. 100, 101 AND 102).

FIRST USE 4-15-2002; IN COMMERCE 4-15-2002.
BENJAMIN OKEKE, EXAMINING ATTORNEY

SN 77-153,549. ELIE W. ATTAR, PASADENA, CA. FILED 4-10-2007.

electricdepot.com

THE MARK CONSISTS OF STANDARD CHARACTERS WITHOUT CLAIM TO ANY PARTICULAR FONT, STYLE, SIZE, OR COLOR.

FOR COMPUTERIZED ON-LINE RETAIL STORE SERVICES IN THE FIELDS OF APPARATUSES AND INSTRUMENTS FOR CONDUCTING, SWITCHING, TRANSFORMING, ACCUMULATING, REGULATING OR CONTROLLING ELECTRICITY AND APPARATUS FOR LIGHTING; WHOLESALE ORDERING SERVICES IN THE FIELD OF APPARATUSES AND INSTRUMENTS FOR CONDUCTING, SWITCHING, TRANSFORMING, ACCUMULATING, REGULATING OR CONTROLLING ELECTRICITY, APPARATUS FOR LIGHTING (U.S. CLS. 100, 101 AND 102).

BILL DAWE, EXAMINING ATTORNEY

CLASS 35—(Continued).

SN 77-153,552. WHEELHOUSE LEGAL SEARCH, LLC, NEWPORT BEACH, CA. FILED 4-10-2007.

WHEELHOUSE LEGAL SEARCH

THE MARK CONSISTS OF STANDARD CHARACTERS WITHOUT CLAIM TO ANY PARTICULAR FONT, STYLE, SIZE, OR COLOR.

NO CLAIM IS MADE TO THE EXCLUSIVE RIGHT TO USE "LEGAL SEARCH", APART FROM THE MARK AS SHOWN.

FOR LEGAL EMPLOYMENT SEARCH, RECRUITMENT AND PLACEMENT SERVICES (U.S. CLS. 100, 101 AND 102).

FIRST USE 4-10-2007; IN COMMERCE 4-10-2007.
DANIEL RUSSELL, EXAMINING ATTORNEY

SN 77-153,630. ZOËY BLOOM, INC., TAMPA, FL. FILED 4-11-2007.

Zoëy Bloom

THE MARK CONSISTS OF STANDARD CHARACTERS WITHOUT CLAIM TO ANY PARTICULAR FONT, STYLE, SIZE, OR COLOR.

FOR RETAIL STORES FEATURING WOMEN'S ACCESSORIES, FASHION JEWELRY, HAND BAGS, SCARVES, GIFTS AND SHOES (U.S. CLS. 100, 101 AND 102).

RÉGINA DRUMMOND, EXAMINING ATTORNEY

SN 77-153,719. ELJO'S, INCORPORATED, CHARLOTTESVILLE, VA. FILED 4-11-2007.

ELJO'S

THE NAME ELJO IS NOT THE NAME OF A LIVING INDIVIDUAL.

THE MARK CONSISTS OF BLOCK ALL CAPITAL TEXT IN STYLIZED FONT OF THE WORD ELJO'S.

FOR RETAIL CLOTHING STORES; RETAIL APPAREL STORES; RETAIL CLOTHING BOUTIQUES (U.S. CLS. 100, 101 AND 102).

FIRST USE 8-1-1950; IN COMMERCE 9-1-1950.
DAVID C. REIHNER, EXAMINING ATTORNEY

CLASS 35—(Continued).

SN 77-153,721. MCCOMBS HFC LTD, SAN ANTONIO, TX. FILED 4-11-2007.



THE MARK CONSISTS OF A RINGING ALARM CLOCK WITH THE WORDS ONE & DONE. FOR AUTOMOBILE DEALERSHIPS (U.S. CLS. 100, 101 AND 102). WILLIAM P. SHANAHAN, EXAMINING ATTORNEY

SN 77-153,803. HINDMARCH, PHILIP JAMES, SANTA FE, NM. FILED 4-11-2007.

SpaCoach

THE MARK CONSISTS OF STANDARD CHARACTERS WITHOUT CLAIM TO ANY PARTICULAR FONT, STYLE, SIZE, OR COLOR. FOR BUSINESS CONSULTING, MANAGEMENT, PLANNING AND SUPERVISION (U.S. CLS. 100, 101 AND 102). FIRST USE 4-1-2002; IN COMMERCE 4-1-2002. MATTHEW PAPPAS, EXAMINING ATTORNEY

SN 77-153,950. CAVOURE LP, CHICAGO, IL. FILED 4-11-2007.

CAVOURE LP

THE MARK CONSISTS OF STANDARD CHARACTERS WITHOUT CLAIM TO ANY PARTICULAR FONT, STYLE, SIZE, OR COLOR. NO CLAIM IS MADE TO THE EXCLUSIVE RIGHT TO USE "LP", APART FROM THE MARK AS SHOWN. FOR EXECUTIVE SEARCH SERVICES (U.S. CLS. 100, 101 AND 102). ELLEN B. AWRICH, EXAMINING ATTORNEY

CLASS 35—(Continued).

SN 77-154,315. CADBURY ADAMS USA LLC, PARSIPPANY, NJ. FILED 4-11-2007.

SCORE

THE MARK CONSISTS OF STANDARD CHARACTERS WITHOUT CLAIM TO ANY PARTICULAR FONT, STYLE, SIZE, OR COLOR. FOR CONSUMER RESEARCH CONDUCTED IN THE CONFECTIONERY RETAIL MARKET (U.S. CLS. 100, 101 AND 102). KATHERINE M. DUBRAY, EXAMINING ATTORNEY

SN 77-154,318. CADBURY ADAMS USA LLC, PARSIPPANY, NJ. FILED 4-11-2007.



FOR CONSUMER RESEARCH CONDUCTED IN THE CONFECTIONERY RETAIL MARKET (U.S. CLS. 100, 101 AND 102). KATHERINE M. DUBRAY, EXAMINING ATTORNEY

SN 77-154,332. CALIFORNIA RESTAURANT ASSOCIATION, SACRAMENTO, CA. FILED 4-11-2007.



OWNER OF U.S. REG. NOS. 2,666,025 AND 2,666,026. NO CLAIM IS MADE TO THE EXCLUSIVE RIGHT TO USE "RESTAURANT ASSOCIATION", APART FROM THE MARK AS SHOWN. THE MARK CONSISTS OF THE WORDS CALIFORNIA RESTAURANT ASSOCIATION BENEATH THREE CIRCULAR DESIGNS FEATURING A KNIFE, FORK AND SPOON. SEC. 2(F) AS TO "CALIFORNIA RESTAURANT ASSOCIATION". FOR ASSOCIATION SERVICES, NAMELY, PROMOTING THE INTERESTS OF CALIFORNIA RESTAURANT OWNERS AND SUPPLIERS (U.S. CLS. 100, 101 AND 102). CURTIS FRENCH, EXAMINING ATTORNEY

CLASS 35—(Continued).

SN 77-154,342. CALIFORNIA RESTAURANT ASSOCIATION, SACRAMENTO, CA. FILED 4-11-2007.



**CALIFORNIA
RESTAURANT
ASSOCIATION**
**EDUCATIONAL
FOUNDATION**

OWNER OF U.S. REG. NOS. 2,666,025 AND 2,666,026.
NO CLAIM IS MADE TO THE EXCLUSIVE RIGHT TO USE "RESTAURANT ASSOCIATION" AND "EDUCATIONAL FOUNDATION", APART FROM THE MARK AS SHOWN.

THE MARK CONSISTS OF THE WORDS CALIFORNIA RESTAURANT ASSOCIATION EDUCATIONAL FOUNDATION BENEATH THREE CIRCULAR DESIGNS FEATURING A KNIFE, FORK AND SPOON.

SEC. 2(F) AS TO CALIFORNIA RESTAURANT ASSOCIATION.

FOR ASSOCIATION SERVICES, NAMELY, PROMOTING THE INTERESTS OF CALIFORNIA RESTAURANT OWNERS AND SUPPLIERS (U.S. CLS. 100, 101 AND 102).
CURTIS FRENCH, EXAMINING ATTORNEY

SN 77-154,724. DXCG, INC., BOSTON, MA. FILED 4-12-2007.

WHERE INTELLIGENT DECISION
MAKING BEGINS

THE MARK CONSISTS OF STANDARD CHARACTERS WITHOUT CLAIM TO ANY PARTICULAR FONT, STYLE, SIZE, OR COLOR.

FOR PROVIDING BUSINESS MARKETING DATA TO HEALTH CARE BUSINESSES, HEALTH CARE PROVIDERS AND OTHERS IN THE HEALTH CARE MARKET (U.S. CLS. 100, 101 AND 102).
RONALD MCMORROW, EXAMINING ATTORNEY

CLASS 35—(Continued).

SN 77-154,798. TY HICKS, BIRMINGHAM MICHIGAN, MI. FILED 4-12-2007.

MOTORCYCLE MECCA

THE MARK CONSISTS OF STANDARD CHARACTERS WITHOUT CLAIM TO ANY PARTICULAR FONT, STYLE, SIZE, OR COLOR.

NO CLAIM IS MADE TO THE EXCLUSIVE RIGHT TO USE MOTORCYCLE, APART FROM THE MARK AS SHOWN.

FOR ORGANIZING TRADESHOW EXHIBITIONS IN THE FIELD OF CUSTOM MOTORCYCLES, CUSTOM BUILT MOTORCYCLES, FACTORY CUSTOM MOTORCYCLES, FACTORY CRUISER MOTORCYCLES, SPORT MOTORCYCLES, EUROPEAN MOTORCYCLES, AS WELL AS THE LATEST MOTORCYCLE MODELS, PARTS, ACCESSORIES AND SERVICES (U.S. CLS. 100, 101 AND 102).

FIRST USE 8-5-2006; IN COMMERCE 1-5-2007.
LINDA ESTRADA, EXAMINING ATTORNEY

SN 77-154,949. BID RITE LLC, REDLANDS, CA. FILED 4-12-2007.

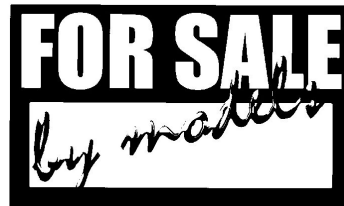

NO CLAIM IS MADE TO THE EXCLUSIVE RIGHT TO USE "FOR SALE", APART FROM THE MARK AS SHOWN.

THE MARK CONSISTS OF THE WORDS "FOR SALE" ARE ON A RECTANGULAR BACKGROUND WITH AN EMPTY RECTANGLE FILLING THE SPACE BELOW THE WORDS "FOR SALE" JUST LIKE A FOR SALE SIGN. THEN DIAGONALLY ACROSS THE RECTANGLE ARE THE WORDS "BY MODELS," AS IF HAND WRITTEN WITH LIPSTICK.

FOR MARKETING AND ADVERTISING (U.S. CLS. 100, 101 AND 102).
JANET LEE, EXAMINING ATTORNEY

CLASS 35—(Continued).

SN 77-154,950. INDEPENDENT COMPETITIVE EATERS, OCEANSIDE, NY. FILED 4-12-2007.



NO CLAIM IS MADE TO THE EXCLUSIVE RIGHT TO USE "ALL PRO EATING PROMOTIONS", APART FROM THE MARK AS SHOWN.

THE MARK CONSISTS OF A STAR WITH A CIRCLE PLATED CENTER, WITH A KNIFE AND FORK CRISS-CROSSING THE PLATE. THE WORDS ALL ARE LOCATED UNDER THE LEFT SECTION OF THE "ARM" OF THE STAR WHILE PRO IS LOCATED DIRECTLY ACCROSS, UNDERNEATH THE "RIGHT ARM". THE WORDS EATING ARE LOCATED BETWEEN THE LEGS OF THE STAR WHILE THE WORDS PROMOTIONS ARE LOCATED UNDERNEATH EATING IN SMALLER FONT.

FOR PUBLICITY AND SALES PROMOTION SERVICES (U.S. CLS. 100, 101 AND 102).

JANET LEE, EXAMINING ATTORNEY

CLASS 35—(Continued).

SN 77-155,554. VINOLUXE, INC., ROLLING HILLS ESTATES, CA. FILED 4-12-2007.

Vinoluxe

THE MARK CONSISTS OF STANDARD CHARACTERS WITHOUT CLAIM TO ANY PARTICULAR FONT, STYLE, SIZE, OR COLOR.

FOR RETAIL STORE SERVICES FEATURING WINE, AUTOMATED WINE TASTING, WINE ACCESSORIES, LIQUOR, BEER AND GIFT ITEMS; ON-LINE RETAIL STORE SERVICES FEATURING WINE, WINE ACCESSORIES, LIQUOR, BEER AND GIFT ITEMS (U.S. CLS. 100, 101 AND 102).

MICHAEL LITZAU, EXAMINING ATTORNEY

SN 77-155,742. CHRISTINE ANNE KIDD, MILTON, FL. FILED 4-12-2007.

KatieBug's Cottage

THE MARK CONSISTS OF STANDARD CHARACTERS WITHOUT CLAIM TO ANY PARTICULAR FONT, STYLE, SIZE, OR COLOR.

FOR RETAIL CLOTHING BOUTIQUES (U.S. CLS. 100, 101 AND 102).

RAUL CORDOVA, EXAMINING ATTORNEY

SN 77-154,951. BID RITE LLC, REDLANDS, CA. FILED 4-12-2007.



SN 77-155,861. SALINA KINNEY, MAKAWAO, HI. FILED 4-13-2007.

Little Pleasures

NO CLAIM IS MADE TO THE EXCLUSIVE RIGHT TO USE "AUTOS", APART FROM THE MARK AS SHOWN.

THE STIPPLING IS A FEATURE OF THE MARK.

THE MARK CONSISTS OF A LOGO THAT IS CIRCULAR WITH THE OUTLINE OF A GAVEL IN THE CENTER.

FOR AUTOMOBILE DEALERSHIPS (U.S. CLS. 100, 101 AND 102).

JANET LEE, EXAMINING ATTORNEY

THE MARK CONSISTS OF STANDARD CHARACTERS WITHOUT CLAIM TO ANY PARTICULAR FONT, STYLE, SIZE, OR COLOR.

FOR RETAIL SHOP-AT-HOME PARTY SERVICES, ONLINE RETAIL STORE SERVICES, AND RETAIL STORE SERVICES IN THE FIELD OF ADULT SEXUAL AIDS (U.S. CLS. 100, 101 AND 102).

FIRST USE 10-1-2006; IN COMMERCE 11-1-2006.

ALEXANDER L. POWERS, EXAMINING ATTORNEY

CLASS 35—(Continued).

SN 77-156,055. PROCLAIM360.COM, RIVERSIDE, NJ. FILED 4-13-2007.

Churchspace

THE MARK CONSISTS OF STANDARD CHARACTERS WITHOUT CLAIM TO ANY PARTICULAR FONT, STYLE, SIZE, OR COLOR.

FOR PROVIDING AN ONLINE DIRECTORY INFORMATION SERVICE FEATURING INFORMATION REGARDING CHURCHES (U.S. CLS. 100, 101 AND 102).

CHARLOTTE CORWIN, EXAMINING ATTORNEY

SN 77-156,061. INSTA-CREDIT AUTO MART, INC., COLLINSVILLE, IL. FILED 4-13-2007.

INSTACREDIT

THE MARK CONSISTS OF STANDARD CHARACTERS WITHOUT CLAIM TO ANY PARTICULAR FONT, STYLE, SIZE, OR COLOR.

OWNER OF U.S. REG. NOS. 3,044,005, 3,187,234 AND 3,205,571.

FOR AUTOMOBILE DEALERSHIPS (U.S. CLS. 100, 101 AND 102).

FIRST USE 0-0-1993; IN COMMERCE 0-0-1993.

MICHELLE DUBOIS, EXAMINING ATTORNEY

SN 77-156,081. STONE CANYON CORP., LOS ANGELES, CA. FILED 4-13-2007.

STONE CANYON

THE MARK CONSISTS OF STANDARD CHARACTERS WITHOUT CLAIM TO ANY PARTICULAR FONT, STYLE, SIZE, OR COLOR.

FOR ADMINISTRATIVE AND BUSINESS MANAGEMENT OF HOTELS FOR OTHERS (U.S. CLS. 100, 101 AND 102).

DAYNA BROWNE, EXAMINING ATTORNEY

CLASS 35—(Continued).

SN 77-156,144. BEGHELLI INC., MIRAMAR, FL. FILED 4-13-2007.

FOR THE PEOPLE, THE BUSINESS AND THE ENVIRONMENT.

THE MARK CONSISTS OF STANDARD CHARACTERS WITHOUT CLAIM TO ANY PARTICULAR FONT, STYLE, SIZE, OR COLOR.

FOR WHOLESALE DISTRIBUTORSHIPS FEATURING EMERGENCY LIGHTING AND SAFETY LIGHTING PRODUCTS; ADVERTISING AND MARKETING SERVICES, NAMELY, PROMOTING THE SERVICES OF AUTHORIZED ELECTRICAL CONTRACTORS TO BUSINESS AND INDUSTRY VIA THE DISTRIBUTION OF ADVERTISEMENTS AND PROMOTIONS; ELECTRICAL CONTRACTOR REFERRAL SERVICES; ON-LINE RETAIL STORE SERVICES FEATURING EMERGENCY LIGHTING AND SAFETY LIGHTING PRODUCTS (U.S. CLS. 100, 101 AND 102).

FIRST USE 3-0-2007; IN COMMERCE 3-0-2007.

JOANNA DUKOVIC, EXAMINING ATTORNEY

SN 77-156,174. ZSMART.COM, INC., SISTERS, OR. FILED 4-13-2007.

INTERVISING.COM

THE MARK CONSISTS OF STANDARD CHARACTERS WITHOUT CLAIM TO ANY PARTICULAR FONT, STYLE, SIZE, OR COLOR.

FOR INTERNET MARKETING AND CONSULTING SERVICES FOR WEBSITE MAXIMIZATION PRODUCTIVITY (U.S. CLS. 100, 101 AND 102).

JEFF DEFORD, EXAMINING ATTORNEY

SN 77-156,488. QUOTATIONS-A FASHION STATEMENT, LLC, LIBERTY, MO. FILED 4-13-2007.

QUOTATIONS - A FASHION STATEMENT

THE MARK CONSISTS OF STANDARD CHARACTERS WITHOUT CLAIM TO ANY PARTICULAR FONT, STYLE, SIZE, OR COLOR.

FOR RETAIL STORES FEATURING CLOTHING AND SHOES (U.S. CLS. 100, 101 AND 102).

FIRST USE 8-1-2005; IN COMMERCE 10-1-2005.

INGA ERVIN, EXAMINING ATTORNEY

CLASS 35—(Continued).

SN 77-156,511. LIPOSONIX, INC., BOTHELL, WA. FILED 4-13-2007.

LIPOSONIX.COM

THE MARK CONSISTS OF STANDARD CHARACTERS WITHOUT CLAIM TO ANY PARTICULAR FONT, STYLE, SIZE, OR COLOR.

OWNER OF U.S. REG. NO. 2,896,037.
FOR RETAIL STORE SERVICES VIA GLOBAL COMPUTER NETWORK FEATURING MEDICAL INSTRUMENTS AND DEVICES (U.S. CLS. 100, 101 AND 102).
CHARLOTTE CORWIN, EXAMINING ATTORNEY



SN 77-156,668. ARTMATTERS, LLC, GAITHERSBURG, MD. FILED 4-13-2007.

ArtMatters

THE MARK CONSISTS OF STANDARD CHARACTERS WITHOUT CLAIM TO ANY PARTICULAR FONT, STYLE, SIZE, OR COLOR.

FOR ART GALLERIES (U.S. CLS. 100, 101 AND 102).
FIRST USE 6-0-2003; IN COMMERCE 6-0-2003.
KATHERINE CHANG, EXAMINING ATTORNEY



SN 77-156,892. JUNG, HELENE S, MARINA, CA. FILED 4-14-2007.

Shailo Box

FOR RETAIL CLOTHING STORES (U.S. CLS. 100, 101 AND 102).
JOHN GARTNER, EXAMINING ATTORNEY

CLASS 35—(Continued).

SN 77-157,035. DARBY, PATRICIA A, BRANDON, FL. FILED 4-15-2007.

PDARBY OF FLORIDA INC

THE MARK CONSISTS OF STANDARD CHARACTERS WITHOUT CLAIM TO ANY PARTICULAR FONT, STYLE, SIZE, OR COLOR.

NO CLAIM IS MADE TO THE EXCLUSIVE RIGHT TO USE "OF FLORIDA INC", APART FROM THE MARK AS SHOWN.

FOR BUSINESS MARKETING SERVICES (U.S. CLS. 100, 101 AND 102).
TONI HICKEY, EXAMINING ATTORNEY



SN 77-157,126. ALL 4 KIDS, LLC, KINGWOOD, TX. FILED 4-15-2007.

All 4 Kids

THE MARK CONSISTS OF STANDARD CHARACTERS WITHOUT CLAIM TO ANY PARTICULAR FONT, STYLE, SIZE, OR COLOR.

FOR BUSINESS CONSULTATION SERVICES TO ASSIST NON-PROFIT ORGANIZATIONS IN PLANNING, MANAGING, AND CONDUCTING FUND RAISING ACTIVITIES VIA A GLOBAL COMPUTER NETWORK; BUSINESS SERVICES FOR FUND RAISING PROGRAMS, NAMELY, DEVELOPING FUND RAISING PROGRAM CATALOGS, BROCHURES, PRICE SHEETS, ORDER FORMS, AND OTHER DOCUMENTS FOR NOT-FOR-PROFIT ORGANIZATIONS; CHARITABLE SERVICES, NAMELY COORDINATION OF THE PROCUREMENT AND DISTRIBUTION OF FOOD DONATIONS FROM MANUFACTURERS, WHOLESALERS, RETAILERS, AND GOVERNMENT AGENCIES TO ORGANIZATIONS PROVIDING FREE FOOD TO NEEDY PEOPLE (U.S. CLS. 100, 101 AND 102).
TARAH HARDY, EXAMINING ATTORNEY

CLASS 35—(Continued).

SN 77-157,171. PAYSERV SYSTEMS, INCORPORATED, ANGOLA, IN. FILED 4-16-2007.

PayServ

THE MARK CONSISTS OF STANDARD CHARACTERS WITHOUT CLAIM TO ANY PARTICULAR FONT, STYLE, SIZE, OR COLOR.

FOR BOOKKEEPING; BUSINESS OPERATION, BUSINESS ADMINISTRATION AND OFFICE FUNCTIONS; EMPLOYMENT HIRING, RECRUITING, PLACEMENT, STAFFING AND CAREER NETWORKING SERVICES; HUMAN RESOURCES CONSULTATION; HUMAN RESOURCES MANAGEMENT; SERVING AS A HUMAN RESOURCES DEPARTMENT FOR OTHERS; ADMINISTRATION OF BUSINESS PAYROLL FOR OTHERS; PAYROLL PREPARATION (U.S. CLS. 100, 101 AND 102).

FIRST USE 7-31-2003; IN COMMERCE 7-31-2003.
ROBERT LAVACHE, EXAMINING ATTORNEY

SN 77-157,194. AGC, INC., CLEVELAND, OH. FILED 4-16-2007.

paper thread

FOR RETAIL STORE SERVICES FEATURING CANDLES, GIFTS, COLLECTIBLES, GREETING CARDS, GIFT WRAP, PARTY ITEMS, ORNAMENTS, AND PLUSH TOYS; COMPUTER SERVICES, NAMELY, PROVIDING ORDERING INFORMATION IN THE FIELD OF CANDLES, GIFTS, COLLECTIBLES, GREETING CARDS, GIFT WRAP, PARTY ITEMS, ORNAMENTS, AND PLUSH TOYS VIA A GLOBAL COMPUTER NETWORK (U.S. CLS. 100, 101 AND 102).

MICHELE SWAIN, EXAMINING ATTORNEY

SN 77-157,217. VISUAL DATA SYSTEMS INC., COLUMBIA, MD. FILED 4-16-2007.

GuestAdvantage

THE MARK CONSISTS OF STANDARD CHARACTERS WITHOUT CLAIM TO ANY PARTICULAR FONT, STYLE, SIZE, OR COLOR.

FOR PROMOTING THE GOODS AND SERVICES OF OTHERS THROUGH ADMINISTRATION OF A LOYALTY REWARDS PROGRAM IN THE FIELD OF PROPERTY RENTAL MANAGEMENT; MANAGEMENT OF PROPERTY RENTAL LOYALTY REWARDS PROGRAMS OF OTHERS; PROVIDING AN INTERACTIVE ON-LINE COMPUTER DATABASE FEATURING INFORMATION IN THE FIELD OF PROPERTY RENTAL LOYALTY AWARDS PROGRAMS (U.S. CLS. 100, 101 AND 102).

FIRST USE 12-16-2004; IN COMMERCE 12-16-2004.
IRENE D. WILLIAMS, EXAMINING ATTORNEY

CLASS 35—(Continued).

SN 77-157,219. VISUAL DATA SYSTEMS INC., COLUMBIA, MD. FILED 4-16-2007.

GuestAdvantage

FOR PROMOTING THE GOODS AND SERVICES OF OTHERS THROUGH ADMINISTRATION OF A LOYALTY REWARDS PROGRAM IN THE FIELD OF PROPERTY RENTAL MANAGEMENT; MANAGEMENT OF PROPERTY RENTAL LOYALTY REWARDS PROGRAMS OF OTHERS; PROVIDING AN INTERACTIVE ON-LINE COMPUTER DATABASE FEATURING INFORMATION IN THE FIELD OF PROPERTY RENTAL LOYALTY AWARDS PROGRAMS (U.S. CLS. 100, 101 AND 102).

FIRST USE 12-16-2004; IN COMMERCE 12-16-2004.
IRENE D. WILLIAMS, EXAMINING ATTORNEY

SN 77-157,220. GETTHEJOB, INC., TINTON FALLS, NJ. FILED 4-16-2007.

GETTHEJOB

THE MARK CONSISTS OF STANDARD CHARACTERS WITHOUT CLAIM TO ANY PARTICULAR FONT, STYLE, SIZE, OR COLOR.

OWNER OF U.S. REG. NO. 3,215,211.

FOR EMPLOYMENT HIRING, RECRUITING, TRACKING, CAREER NETWORKING AND PLACEMENT SERVICES WHICH OFFERS THE EXCHANGE OF INFORMATION; PROVIDING AN ONLINE SEARCHABLE DATABASE EMPLOYMENT OPPORTUNITIES WHEREBY EMPLOYERS CAN RECRUIT PERSONNEL AND REVIEW EMPLOYEE CANDIDATE SUBMISSIONS AND MANAGE THE HIRING AND STAFFING PROCESS AND RECRUITERS AND CANDIDATES CAN SUBMIT RESUMES TO EMPLOYERS CORPORATE WEB SITES (U.S. CLS. 100, 101 AND 102).

FIRST USE 12-12-2005; IN COMMERCE 12-12-2005.
GEORGE LORENZO, EXAMINING ATTORNEY

SN 77-157,231. HARLAN WHEELER, LAPWAI, ID. FILED 4-16-2007.

Frumtha

THE MARK CONSISTS OF STANDARD CHARACTERS WITHOUT CLAIM TO ANY PARTICULAR FONT, STYLE, SIZE, OR COLOR.

FOR RETAIL STORE AND ON-LINE RETAIL STORE SERVICES FEATURING CLOTHING (U.S. CLS. 100, 101 AND 102).

GEORGE LORENZO, EXAMINING ATTORNEY

CLASS 35—(Continued).

SN 77-157,247. MOUNTAIN TREADS, INC., HARRISON-BURG, VA. FILED 4-16-2007.

The Sole Source

THE MARK CONSISTS OF STANDARD CHARACTERS WITHOUT CLAIM TO ANY PARTICULAR FONT, STYLE, SIZE, OR COLOR.

FOR RETAIL STORE SERVICES FEATURING SHOES, SHOE-CARE PRODUCTS, AND SHOE-RELATED ACCESSORIES (U.S. CLS. 100, 101 AND 102).

FIRST USE 12-16-2004; IN COMMERCE 4-15-2005.
DAVID C. REIHNER, EXAMINING ATTORNEY

CLASS 35—(Continued).

SN 77-157,278. BLD INTERNATIONAL, LEESBURG, FL. FILED 4-16-2007.

BLD OFFICE

THE MARK CONSISTS OF STANDARD CHARACTERS WITHOUT CLAIM TO ANY PARTICULAR FONT, STYLE, SIZE, OR COLOR.

NO CLAIM IS MADE TO THE EXCLUSIVE RIGHT TO USE "OFFICE", APART FROM THE MARK AS SHOWN.

FOR RETAIL STORE AND ONLINE RETAIL STORE SERVICES, ALL IN THE FIELD OF OFFICE FURNITURE, OFFICE SUPPLIES, EQUIPMENT AND RELATED PRODUCTS AND ACCESSORIES (U.S. CLS. 100, 101 AND 102).

FIRST USE 1-0-2006; IN COMMERCE 1-0-2006.
JASON BLAIR, EXAMINING ATTORNEY

SN 77-157,252. RSC THE QUALITY MEASUREMENT COMPANY, EVANSVILLE, IN. FILED 4-16-2007.

DEMAND DECISIONS

THE MARK CONSISTS OF STANDARD CHARACTERS WITHOUT CLAIM TO ANY PARTICULAR FONT, STYLE, SIZE, OR COLOR.

FOR BUSINESS MANAGEMENT CONSULTING SERVICES IN THE FIELD OF SUPPLY CHAIN MANAGEMENT, TRACKING, PLANNING AND FORECASTING, AND INVENTORY CONTROL (U.S. CLS. 100, 101 AND 102).

MICHAEL LITZAU, EXAMINING ATTORNEY

SN 77-157,279. BLD INTERNATIONAL, LEESBURG, FL. FILED 4-16-2007.

BLD HOME HEALTH

THE MARK CONSISTS OF STANDARD CHARACTERS WITHOUT CLAIM TO ANY PARTICULAR FONT, STYLE, SIZE, OR COLOR.

NO CLAIM IS MADE TO THE EXCLUSIVE RIGHT TO USE "HOME HEALTH", APART FROM THE MARK AS SHOWN.

FOR RETAIL STORE AND ONLINE RETAIL STORE SERVICES, ALL IN THE FIELD OF MEDICAL EQUIPMENT FOR OUTPATIENT USE (U.S. CLS. 100, 101 AND 102).

JASON BLAIR, EXAMINING ATTORNEY

SN 77-157,277. BLD INTERNATIONAL, LEESBURG, FL. FILED 4-16-2007.

LABSTOCK

THE MARK CONSISTS OF STANDARD CHARACTERS WITHOUT CLAIM TO ANY PARTICULAR FONT, STYLE, SIZE, OR COLOR.

FOR ARRANGING AND CONDUCTING TRADE SHOWS IN THE FIELD OF ANALYTICAL CHEMISTRY AND APPLIED SPECTROSCOPY (U.S. CLS. 100, 101 AND 102).

JASON BLAIR, EXAMINING ATTORNEY

SN 77-157,283. BLD INTERNATIONAL, LEESBURG, FL. FILED 4-16-2007.

BLD SCIENCE

THE MARK CONSISTS OF STANDARD CHARACTERS WITHOUT CLAIM TO ANY PARTICULAR FONT, STYLE, SIZE, OR COLOR.

NO CLAIM IS MADE TO THE EXCLUSIVE RIGHT TO USE "SCIENCE", APART FROM THE MARK AS SHOWN.

FOR RETAIL STORE AND ONLINE RETAIL STORE SERVICES, ALL IN THE FIELD OF LABORATORY EQUIPMENT, SUPPLIES AND RELATED ACCESSORIES (U.S. CLS. 100, 101 AND 102).

JASON BLAIR, EXAMINING ATTORNEY

CLASS 35—(Continued).

SN 77-157,289. BRIGGS, PAUL, EAGLE HEIGHTS, AUSTRALIA, FILED 4-16-2007.

MOBILEWHACK.COM

THE MARK CONSISTS OF STANDARD CHARACTERS WITHOUT CLAIM TO ANY PARTICULAR FONT, STYLE, SIZE, OR COLOR.

FOR PROVIDING CONSUMER INFORMATION IN THE FIELD OF MOBILE ELECTRONICS, CELL PHONES, PDAS, COMPUTERS, CAMERAS, DVD PLAYERS AND STEREO; PROVIDING CONSUMER PRODUCT INFORMATION VIA THE INTERNET; PROVIDING A WEB SITE WHERE USERS CAN POST RATINGS, REVIEWS AND RECOMMENDATIONS ON PRODUCTS AND SERVICES; ON-LINE RETAIL STORE SERVICES FEATURING MOBILE ELECTRONICS, CELL PHONES, PDAS, COMPUTERS, CAMERAS, DVD PLAYERS AND STEREO; MARKETING SERVICES, NAMELY, PROVIDING INFORMATIONAL WEB PAGES DESIGNED TO GENERATE SALES TRAFFIC VIA HYPERLINKS TO OTHER WEB SITES; PROVIDING ON-LINE DIRECTORY INFORMATION SERVICES ALSO FEATURING HYPERLINKS TO OTHER WEB SITES (U.S. CLS. 100, 101 AND 102).

FIRST USE 1-0-2005; IN COMMERCE 1-0-2005.
BRENDAN REGAN, EXAMINING ATTORNEY

SN 77-157,294. BLD INTERNATIONAL, LEESBURG, FL. FILED 4-16-2007.

BLD HEALTHCARE

THE MARK CONSISTS OF STANDARD CHARACTERS WITHOUT CLAIM TO ANY PARTICULAR FONT, STYLE, SIZE, OR COLOR.

NO CLAIM IS MADE TO THE EXCLUSIVE RIGHT TO USE "HEALTHCARE", APART FROM THE MARK AS SHOWN.

FOR RETAIL STORE AND ONLINE RETAIL STORE SERVICES, ALL IN THE FIELD OF HEALTH CARE PRODUCTS (U.S. CLS. 100, 101 AND 102).

JASON BLAIR, EXAMINING ATTORNEY

CLASS 35—(Continued).

SN 77-157,297. BLD INTERNATIONAL, LEESBURG, FL. FILED 4-16-2007.

BLD SAFETY

THE MARK CONSISTS OF STANDARD CHARACTERS WITHOUT CLAIM TO ANY PARTICULAR FONT, STYLE, SIZE, OR COLOR.

NO CLAIM IS MADE TO THE EXCLUSIVE RIGHT TO USE "SAFETY", APART FROM THE MARK AS SHOWN.

FOR RETAIL STORE AND ONLINE RETAIL STORE SERVICES, ALL IN THE FIELD OF SAFETY EQUIPMENT AND ACCESSORIES FOR USE IN LABORATORY SETTINGS (U.S. CLS. 100, 101 AND 102).

JASON BLAIR, EXAMINING ATTORNEY

SN 77-157,335. DIRECT MARKETERS ON CALL, INC., NEW YORK, NY. FILED 4-16-2007.

DIRECT MARKETERS ON CALL

THE MARK CONSISTS OF STANDARD CHARACTERS WITHOUT CLAIM TO ANY PARTICULAR FONT, STYLE, SIZE, OR COLOR.

NO CLAIM IS MADE TO THE EXCLUSIVE RIGHT TO USE "DIRECT MARKETERS", APART FROM THE MARK AS SHOWN.

SEC. 2(F).
FOR JOB AND PERSONNEL PLACEMENT (U.S. CLS. 100, 101 AND 102).

FIRST USE 0-0-1991; IN COMMERCE 0-0-1991.
JOHN GARTNER, EXAMINING ATTORNEY

SN 77-157,435. MORPHEUS MEDIA, LLC, NEW YORK, NY. FILED 4-16-2007.

MORPHEUS MEDIA

THE MARK CONSISTS OF STANDARD CHARACTERS WITHOUT CLAIM TO ANY PARTICULAR FONT, STYLE, SIZE, OR COLOR.

NO CLAIM IS MADE TO THE EXCLUSIVE RIGHT TO USE "MEDIA", APART FROM THE MARK AS SHOWN.

FOR ADVERTISING AGENCIES (U.S. CLS. 100, 101 AND 102).

FIRST USE 2-1-2001; IN COMMERCE 2-1-2001.
CHARLOTTE CORWIN, EXAMINING ATTORNEY

CLASS 35—(Continued).

SN 77-157,476. AMERICAN NURSES FOUNDATION, SILVER SPRING, MD. FILED 4-16-2007.

HONOR A NURSE

THE MARK CONSISTS OF STANDARD CHARACTERS WITHOUT CLAIM TO ANY PARTICULAR FONT, STYLE, SIZE, OR COLOR.

FOR ASSOCIATION SERVICES, NAMELY, PROMOTING THE INTERESTS OF THE NURSING PROFESSION (U.S. CLS. 100, 101 AND 102).

FIRST USE 2-28-2006; IN COMMERCE 2-28-2006.
PAUL E. FAHRENKOPF, EXAMINING ATTORNEY

SN 77-157,495. MORPHEUS MEDIA, LLC, NEW YORK, NY. FILED 4-16-2007.

MEDIA **MORPHEUS** **MEDIA**

NO CLAIM IS MADE TO THE EXCLUSIVE RIGHT TO USE "MEDIA", APART FROM THE MARK AS SHOWN.

THE COLOR(S) BLUE AND GREEN IS/ARE CLAIMED AS A FEATURE OF THE MARK.

THE MARK CONSISTS OF THE WORDS "MORPHEUS MEDIA" WHERE THE FOREGROUND HAS "MORPHEUS" IN GREEN AND "MEDIA" IN BLUE AND WHERE THE BACKGROUND HAS "MORPHEUS" AND "MEDIA" INVERTED, REVERSED, AND IN LIGHTER SHADES OF GREEN AND BLUE RESPECTIVELY.

FOR ADVERTISING AGENCIES (U.S. CLS. 100, 101 AND 102).

FIRST USE 2-1-2001; IN COMMERCE 2-1-2001.
CHARLOTTE CORWIN, EXAMINING ATTORNEY

SN 77-157,790. HELLIGER, AUSTIN A., CHRISTIANSTED, US VIRGIN ISLANDS, FILED 4-16-2007.

SKYLYNE ENTERTAINMENT, LLC

THE MARK CONSISTS OF STANDARD CHARACTERS WITHOUT CLAIM TO ANY PARTICULAR FONT, STYLE, SIZE, OR COLOR.

NO CLAIM IS MADE TO THE EXCLUSIVE RIGHT TO USE "ENTERTAINMENT, LLC", APART FROM THE MARK AS SHOWN.

FOR PROMOTION OF SPECIAL EVENTS (U.S. CLS. 100, 101 AND 102).

MICHAEL ENGEL, EXAMINING ATTORNEY

CLASS 35—(Continued).

SN 77-158,265. CONGRESS FOR THE NEW URBANISM, INC., CHICAGO, IL. FILED 4-17-2007.

CONGRESS FOR THE NEW URBANISM

THE MARK CONSISTS OF STANDARD CHARACTERS WITHOUT CLAIM TO ANY PARTICULAR FONT, STYLE, SIZE, OR COLOR.

NO CLAIM IS MADE TO THE EXCLUSIVE RIGHT TO USE "CONGRESS", APART FROM THE MARK AS SHOWN. SEC. 2(F).

FOR PROMOTING PUBLIC AWARENESS OF THE NEED FOR PUBLIC POLICY AND DEVELOPMENT PRACTICES THAT ENHANCE NEIGHBORHOOD DIVERSITY, DESIGN, LOCAL HISTORY, CLIMATE AND ECOLOGY (U.S. CLS. 100, 101 AND 102).

FIRST USE 10-8-1993; IN COMMERCE 10-8-1993.
MARGERY A. TIERNEY, EXAMINING ATTORNEY

SN 77-158,291. MEET THE NEED MINISTRIES, INC, ODESSA, FL. FILED 4-17-2007.

Meet the Need

THE MARK CONSISTS OF STANDARD CHARACTERS WITHOUT CLAIM TO ANY PARTICULAR FONT, STYLE, SIZE, OR COLOR.

FOR FACILITATING THE EXCHANGE OF NEEDED INFORMATION FOR FINANCIAL COMPENSATION VIA THE INTERNET; ADVERTISING AND COMMERCIAL INFORMATION SERVICES, VIA THE INTERNET; ADVERTISING VIA ELECTRONIC MEDIA AND SPECIFICALLY THE INTERNET; DISSEMINATION OF ADVERTISING FOR OTHERS VIA AN ON-LINE COMMUNICATIONS NETWORK ON THE INTERNET; DISSEMINATION OF ADVERTISING FOR OTHERS VIA THE INTERNET; INFORMATION MANAGEMENT SERVICES, NAMELY, SHIPMENT PROCESSING, PREPARING SHIPPING DOCUMENTS AND INVOICES, TRACKING DOCUMENTS, PACKAGES AND FREIGHT OVER COMPUTER NETWORKS, INTRANETS AND INTERNETS; INFORMATION, ADVISORY AND CONSULTANCY SERVICES RELATING TO BUSINESS AND MANAGEMENT OR BUSINESS ADMINISTRATION, INCLUDING SUCH SERVICES PROVIDED ON LINE OR VIA THE INTERNET; MARKET MANIPULATION, RESEARCH AND ANALYSIS, WHETHER OR NOT VIA THE INTERNET; COMPUTER SERVICES, NAMELY, ADDRESS CHANGE NOTIFICATION SERVICES IN THE NATURE OF POSTING NOTIFICATIONS OF CHANGES OF ADDRESSES FOR BUSINESSES VIA THE INTERNET; PROVIDING A SEARCHABLE ONLINE ADVERTISING GUIDE FEATURING THE GOODS AND SERVICES OF OTHER ON-LINE VENDORS ON THE INTERNET; PROVIDING AN ON-LINE COMMERCIAL INFORMATION DIRECTORY ON THE INTERNET; PROVIDING BUSINESS INFORMATION, ALSO VIA INTERNET, THE CABLE NETWORK OR OTHER FORMS OF DATA TRANSFER (U.S. CLS. 100, 101 AND 102).

LINDA POWELL, EXAMINING ATTORNEY

CLASS 35—(Continued).

SN 77-158,336. 123SOLD, INC., PLANTATION, FL. FILED 4-17-2007.

IT'S TIME TO GET REAL ABOUT REAL ESTATE

THE MARK CONSISTS OF STANDARD CHARACTERS WITHOUT CLAIM TO ANY PARTICULAR FONT, STYLE, SIZE, OR COLOR.

FOR REAL ESTATE AUCTIONS; AND REAL ESTATE ADVERTISING SERVICES (U.S. CLS. 100, 101 AND 102).
LAURA KOVALSKY, EXAMINING ATTORNEY

SN 77-158,342. 123SOLD, INC., PLANTATION, FL. FILED 4-17-2007.

IT'S A BIDDER'S MARKET

THE MARK CONSISTS OF STANDARD CHARACTERS WITHOUT CLAIM TO ANY PARTICULAR FONT, STYLE, SIZE, OR COLOR.

FOR REAL ESTATE AUCTIONS; AND REAL ESTATE ADVERTISING SERVICES (U.S. CLS. 100, 101 AND 102).
LAURA KOVALSKY, EXAMINING ATTORNEY

SN 77-158,345. 123SOLD, INC., PLANTATION, FL. FILED 4-17-2007.

BIDDER BEWARE

THE MARK CONSISTS OF STANDARD CHARACTERS WITHOUT CLAIM TO ANY PARTICULAR FONT, STYLE, SIZE, OR COLOR.

FOR REAL ESTATE AUCTIONS; AND REAL ESTATE ADVERTISING SERVICES (U.S. CLS. 100, 101 AND 102).
LAURA KOVALSKY, EXAMINING ATTORNEY

CLASS 35—(Continued).

SN 77-158,417. SHOPTEXT, INC., NEW YORK, NY. FILED 4-17-2007.

LIVE ON 3

THE MARK CONSISTS OF STANDARD CHARACTERS WITHOUT CLAIM TO ANY PARTICULAR FONT, STYLE, SIZE, OR COLOR.

FOR PROMOTING THE GOODS AND SERVICES OF OTHERS BY MEANS OF OPERATING A SHOPPING SERVICE ACCESSIBLE FROM THREE PLATFORMS, NAMELY, COMPUTER, TELEVISION AND MOBILE PHONE (U.S. CLS. 100, 101 AND 102).
DEZMONA MIZELLE, EXAMINING ATTORNEY

SN 77-158,427. POPULAR, INC., SAN JUAN, PUERTO RICO, FILED 4-17-2007.

T-paga

THE MARK CONSISTS OF STANDARD CHARACTERS WITHOUT CLAIM TO ANY PARTICULAR FONT, STYLE, SIZE, OR COLOR.

THE FOREIGN WORDING IN THE MARK TRANSLATES INTO ENGLISH AS PAYS.

FOR PROMOTING THE SALE OF CREDIT CARD ACCOUNTS THROUGH THE ADMINISTRATION OF INCENTIVE AWARDS PROGRAMS (U.S. CLS. 100, 101 AND 102).

FIRST USE 8-1-2006; IN COMMERCE 2-15-2007.
LINDA ORNDORFF, EXAMINING ATTORNEY

SN 77-158,517. EDF SERVICES, INC., ROME, NY. FILED 4-17-2007.

OOOH-YEAHHH

THE MARK CONSISTS OF STANDARD CHARACTERS WITHOUT CLAIM TO ANY PARTICULAR FONT, STYLE, SIZE, OR COLOR.

FOR RETAIL STORE SERVICES FEATURING FURNITURE (U.S. CLS. 100, 101 AND 102).

FIRST USE 6-1-1997; IN COMMERCE 6-1-1997.
LYDIA BELZER, EXAMINING ATTORNEY

CLASS 35—(Continued).

SN 77-158,608. COLABORATE, LLC, TAMPA, FL. FILED 4-17-2007.

colaborate

THE MARK CONSISTS OF STANDARD CHARACTERS WITHOUT CLAIM TO ANY PARTICULAR FONT, STYLE, SIZE, OR COLOR.

FOR BUSINESS CONSULTING SERVICES IN THE FIELD OF HEALTHCARE LABORATORIES (U.S. CLS. 100, 101 AND 102).

FIRST USE 2-1-2007; IN COMMERCE 2-1-2007.

WILLIAM ROSSMAN, EXAMINING ATTORNEY

SN 77-158,610. BEACHTAILS, LLC, OAK PARK, IL. FILED 4-17-2007.



FOR ACTIVE PETS & THEIR COMPANIONS

NO CLAIM IS MADE TO THE EXCLUSIVE RIGHT TO USE "FOR ACTIVE PETS & THEIR COMPANIONS", APART FROM THE MARK AS SHOWN.

THE MARK CONSISTS OF STYLIZED LETTERS.

FOR RETAIL STORE SERVICES FEATURING PET PRODUCTS AND SUPPLIES (U.S. CLS. 100, 101 AND 102).

REBECCA GILBERT, EXAMINING ATTORNEY

SN 77-158,669. SABOL, ALLAN, CARLSBAD, CA. FILED 4-17-2007.

DAYAK

THE MARK CONSISTS OF STANDARD CHARACTERS WITHOUT CLAIM TO ANY PARTICULAR FONT, STYLE, SIZE, OR COLOR.

FOR CONSULTANCY OF PERSONNEL RECRUITMENT; EMPLOYMENT COUNSELING AND RECRUITING; EMPLOYMENT HIRING, RECRUITING, PLACEMENT, STAFFING AND CAREER NETWORKING SERVICES; PERSONNEL PLACEMENT AND RECRUITMENT (U.S. CLS. 100, 101 AND 102).

ANDREA SAUNDERS, EXAMINING ATTORNEY

CLASS 35—(Continued).

SN 77-158,706. TEVA PHARMACEUTICAL INDUSTRIES LTD., JERUSALEM, ISRAEL, FILED 4-17-2007.



OWNER OF ISRAEL REG. NO. 179310, DATED 8-3-2006, EXPIRES 8-3-2016.

OWNER OF U.S. REG. NOS. 1,567,918, 2,937,656 AND OTHERS.

NO CLAIM IS MADE TO THE EXCLUSIVE RIGHT TO USE "GROUP", APART FROM THE MARK AS SHOWN.

THE ENGLISH TRANSLATION OF THE TERM "TEVA" IS "NATURE."

FOR BUSINESS MANAGEMENT AND BUSINESS MANAGEMENT CONSULTING; PUBLIC RELATIONS; BUSINESS MARKETING CONSULTING; PROMOTION SERVICES, NAMELY, PROMOTING THE GOODS AND SERVICES OF OTHERS THROUGH DISSEMINATION OF ADVERTISING MATERIALS ON THE INTERNET; BUSINESS RESEARCH SERVICES; PROVIDING BUSINESS RESEARCH AND INFORMATION IN THE FIELDS OF PHARMACEUTICALS MARKETING AND CORPORATE COMMUNICATION; ALL SERVICES IN THE FIELD OF PHARMACEUTICALS (U.S. CLS. 100, 101 AND 102).

GEOFFREY FOSDICK, EXAMINING ATTORNEY

SN 77-158,794. IDEASONE, INC., KAMUELA, HI. FILED 4-17-2007.

WHERE THERE'S SCIENCE THERE'S FUN

THE MARK CONSISTS OF STANDARD CHARACTERS WITHOUT CLAIM TO ANY PARTICULAR FONT, STYLE, SIZE, OR COLOR.

FOR GENERAL BUSINESS MERCHANDISING SERVICES, NAMELY, MARKETING OVER A GLOBAL COMPUTER NETWORK (U.S. CLS. 100, 101 AND 102).

AISHA CLARKE, EXAMINING ATTORNEY

CLASS 35—(Continued).

SN 77-158,839. HANNAH COMMUNICATIONS COMPANY, BALTIMORE, MD. FILED 4-17-2007.



NO CLAIM IS MADE TO THE EXCLUSIVE RIGHT TO USE "MEDIA", APART FROM THE MARK AS SHOWN.

THE COLOR(S) GOLD, RED, WHITE AND BLUE IS/ARE CLAIMED AS A FEATURE OF THE MARK.

THE MARK CONSISTS OF GOLD SHINY SHOES IN THE UPPER LEFT HAND CORNER, THE WORDS "WITH THE GOSPEL OF MEDIA" IN RED AT THE BOTTOM, THE WORDS "FEET SHOD" IN RED IN THE MIDDLE OF THE MARK. THE COLOR BLUE APPEARS IN THE SHADOW OUTLINE OF THE SHOES. THE COLOR WHITE APPEARS IN THE ACCENT FEATURE OF THE SHOES.

FOR ADVERTISING SERVICES, NAMELY, PROMOTING AND MARKETING THE GOODS AND SERVICES OF OTHERS THROUGH ALL PUBLIC COMMUNICATION MEANS (U.S. CLS. 100, 101 AND 102).

FIRST USE 3-4-2007; IN COMMERCE 4-2-2007.

PAMELA HIRSCHMAN, EXAMINING ATTORNEY

SN 77-158,919. WAL-MART STORES, INC., BENTONVILLE, AR. FILED 4-17-2007.

**SAVING PEOPLE MONEY SO
THEY CAN LIVE BETTER.**

THE MARK CONSISTS OF STANDARD CHARACTERS WITHOUT CLAIM TO ANY PARTICULAR FONT, STYLE, SIZE, OR COLOR.

FOR ONLINE RETAIL DEPARTMENT STORE SERVICES; RETAIL DEPARTMENT STORE SERVICES (U.S. CLS. 100, 101 AND 102).

SCOTT SISUN, EXAMINING ATTORNEY

SN 77-158,960. TAYLOR, DAVID, IRVING, TX. FILED 4-17-2007.

AVENDIOS

THE MARK CONSISTS OF STANDARD CHARACTERS WITHOUT CLAIM TO ANY PARTICULAR FONT, STYLE, SIZE, OR COLOR.

FOR ADVERTISING, MARKETING AND PROMOTION SERVICES (U.S. CLS. 100, 101 AND 102).

JAY BESCH, EXAMINING ATTORNEY

CLASS 35—(Continued).

SN 77-159,089. ICF INCORPORATED, LLC, FAIRFAX, VA. FILED 4-17-2007.

PULSEPLUS

THE MARK CONSISTS OF STANDARD CHARACTERS WITHOUT CLAIM TO ANY PARTICULAR FONT, STYLE, SIZE, OR COLOR.

FOR BUSINESS MANAGEMENT CONSULTING SERVICES FOR COMMERCIAL, GOVERNMENTAL AND NON-PROFIT CLIENTS USING A PROPRIETARY, WEB-ENABLED SURVEY, ANALYSIS, AND REPORTING TOOL THAT FACILITATES EMPIRICALLY-BASED DECISIONS BY PROVIDING DECISION-MAKERS WITH REAL-TIME AND RELIABLE SURVEY FEEDBACK (U.S. CLS. 100, 101 AND 102).

STEPHEN AQUILA, EXAMINING ATTORNEY

SN 77-159,120. FLANNORY, GERALD, K, NEW YORK, NY. FILED 4-18-2007.

**SHIPPING
SOON.com**

THE MARK CONSISTS OF A LARGE "S" THAT REPRESENTS THE FIRST LETTER OF BOTH THE WORD "SHIPPING" AND "SOON" AS WELL AS INCLUDING ".COM" IN THE LOGO.

FOR ADVERTISING AND PUBLICITY SERVICES, NAMELY, PROMOTING THE GOODS, SERVICES, BRAND IDENTITY AND COMMERCIAL INFORMATION AND NEWS OF THIRD PARTIES THROUGH PRINT, AUDIO, VIDEO, DIGITAL AND ON-LINE MEDIUM (U.S. CLS. 100, 101 AND 102).

PAULA MAHONEY, EXAMINING ATTORNEY

SN 77-159,140. THAT DAMN TOY STORE, INC., HOUSTON, TX. FILED 4-18-2007.

ZIOT

THE MARK CONSISTS OF STANDARD CHARACTERS WITHOUT CLAIM TO ANY PARTICULAR FONT, STYLE, SIZE, OR COLOR.

FOR ONLINE AUCTION SERVICES (U.S. CLS. 100, 101 AND 102).

RAUL CORDOVA, EXAMINING ATTORNEY

CLASS 35—(Continued).

SN 77-159,195. CONNECTICUT ATTORNEYS TITLE INSURANCE COMPANY, ROCKY HILL, CT. FILED 4-18-2007.



OWNER OF U.S. REG. NOS. 2,100,831, 3,099,414 AND OTHERS.

THE MARK CONSISTS OF A BLOCK C DESIGN WITH THE WORDS "CATIC ACCESS TO SUCCESS."

FOR PROMOTING THE GOODS AND SERVICES OF OTHERS BY MEANS OF AN AFFINITY PROGRAM FEATURING DISCOUNTS AND OTHER INCENTIVES FROM SELECTED VENDORS, VIA DIRECT MAIL AND OTHER MEANS; AND PROMOTING THE GOODS AND SERVICES OF OTHERS BY PROVIDING INFORMATION VIA A SPECIAL LOCATION ON WEB SITES FEATURING SELECTED VENDORS AND THEIR PRODUCTS, SERVICES, DISCOUNTS AND OTHER INCENTIVES (U.S. CLS. 100, 101 AND 102).

CHRIS WELLS, EXAMINING ATTORNEY

CLASS 35—(Continued).

SN 77-159,246. ICF INCORPORATED, LLC, FAIRFAX, VA. FILED 4-18-2007.



THE MARK CONSISTS OF THE LETTER P AND A SUPERSCRIP 2 TO THE RIGHT OF THE LETTER P.

FOR BUSINESS MANAGEMENT CONSULTING SERVICES FOR COMMERCIAL, GOVERNMENTAL AND NON-PROFIT CLIENTS USING A PROPRIETARY, WEB-ENABLED SURVEY, ANALYSIS, AND REPORTING TOOL THAT FACILITATES EMPIRICALLY-BASED DECISIONS BY PROVIDING DECISION-MAKERS WITH REAL-TIME AND RELIABLE SURVEY FEEDBACK (U.S. CLS. 100, 101 AND 102).

STEPHEN AQUILA, EXAMINING ATTORNEY

SN 77-159,230. RESOURCE LABELGROUP, LLC, FRANKLIN, TN. FILED 4-18-2007.

O:EI

THE MARK CONSISTS OF STANDARD CHARACTERS WITHOUT CLAIM TO ANY PARTICULAR FONT, STYLE, SIZE, OR COLOR.

FOR CONSULTING SERVICES IN THE AREA OF SUSTAINABLE BUSINESS SOLUTIONS (U.S. CLS. 100, 101 AND 102).

CHRIS WELLS, EXAMINING ATTORNEY

SN 77-159,307. VELOCITY TRADE EXCHANGE, LLC, GREENSBORO, NC. FILED 4-18-2007.



NO CLAIM IS MADE TO THE EXCLUSIVE RIGHT TO USE "TRADE EXCHANGE", APART FROM THE MARK AS SHOWN.

THE COLOR(S) GRAY, BLUE, MAROON AND WHITE IS/ ARE CLAIMED AS A FEATURE OF THE MARK.

THE WORDING IN THE MARK IS GRAY, EXCEPT FOR THE "O" IN "VELOCITY," WHICH IS A MAROON GLOBE WITH WHITE MERIDIANS; THE CHEVRONS ARE VARYING SHADES, RIGHT TO LEFT, OF GRAY, BLUE AND MAROON.

FOR EXCHANGE SERVICES, NAMELY, BARTERING OF GOODS FOR OTHERS (U.S. CLS. 100, 101 AND 102). FIRST USE 12-1-2006; IN COMMERCE 12-1-2006.

ALICE SUE CARRUTHERS, EXAMINING ATTORNEY

CLASS 35—(Continued).

SN 77-159,371. VELOCITY TRADE EXCHANGE, LLC, GREENSBORO, NC. FILED 4-18-2007.



THE COLOR(S) MAROON AND GRAY IS/ARE CLAIMED AS A FEATURE OF THE MARK.

THE WORD "BARTER" IN THE MARK IS MAROON; THE REMAINING WORDING IS GRAY.

FOR EXCHANGE SERVICES, NAMELY, BARTERING OF GOODS FOR OTHERS (U.S. CLS. 100, 101 AND 102). FIRST USE 12-1-2006; IN COMMERCE 12-1-2006.

ALICE SUE CARRUTHERS, EXAMINING ATTORNEY

SN 77-159,382. BALAN BIOMEDICAL, INC., WEST HENRIETTA, NY. FILED 4-18-2007.

Directed Innovation

THE MARK CONSISTS OF STANDARD CHARACTERS WITHOUT CLAIM TO ANY PARTICULAR FONT, STYLE, SIZE, OR COLOR.

FOR MARKET RESEARCH SERVICES; CONSULTATION SERVICES IN THE FIELD OF COMPANY, BUSINESS SECTOR AND INDUSTRY DATA AND RESEARCH; CONSULTING SERVICES IN THE FIELD OF MANAGING INTELLECTUAL PROPERTIES; CONSUMER RESEARCH; BUSINESS RESEARCH CONSULTATION (U.S. CLS. 100, 101 AND 102).

FIRST USE 3-2-2007; IN COMMERCE 3-9-2007.

JOHN E. MICHOS, EXAMINING ATTORNEY

SN 77-159,622. PRACTICAL WHIMSY, INC., MARINA DEL REY, CA. FILED 4-18-2007.

PRACTICAL WHIMSY

THE MARK CONSISTS OF STANDARD CHARACTERS WITHOUT CLAIM TO ANY PARTICULAR FONT, STYLE, SIZE, OR COLOR.

FOR ONLINE RETAIL STORE SERVICES IN THE FIELDS OF CLOTHING AND ACCESSORIES FOR BABIES AND CHILDREN, HOME DECORATING, AND HOUSEHOLD ACCESSORIES (U.S. CLS. 100, 101 AND 102).

FIRST USE 5-31-2005; IN COMMERCE 5-31-2005.

RICHARD WHITE, EXAMINING ATTORNEY

CLASS 35—(Continued).

SN 77-159,767. PARADYSZ MATERA CO., INC., NEW YORK, NY. FILED 4-18-2007.

**RELENTLESS INNOVATION AND
SCIENCE OF CUSTOMER
ACQUISITION**

THE MARK CONSISTS OF STANDARD CHARACTERS WITHOUT CLAIM TO ANY PARTICULAR FONT, STYLE, SIZE, OR COLOR.

NO CLAIM IS MADE TO THE EXCLUSIVE RIGHT TO USE "CUSTOMER ACQUISITION", APART FROM THE MARK AS SHOWN.

FOR BUSINESS ADVERTISING, BUSINESS MARKETING, BUSINESS RESEARCH, BUSINESS CONSULTING, BUSINESS PROFILING FOR THE PURPOSE OF IDENTIFYING POTENTIAL CUSTOMERS, DIRECT MAIL ADVERTISING AND CONSULTING, AND MODELING SERVICES FOR ADVERTISING OR SALES PROMOTION (U.S. CLS. 100, 101 AND 102).

MARY BOAGNI, EXAMINING ATTORNEY

SN 77-159,773. POLAKOVIC, GARY, VENTURA, CA. FILED 4-18-2007.

**Environmental strategies
to make over the world**

THE MARK CONSISTS OF STANDARD CHARACTERS WITHOUT CLAIM TO ANY PARTICULAR FONT, STYLE, SIZE, OR COLOR.

FOR ADVERTISING AND PUBLICITY SERVICES, NAMELY, PROMOTING THE GOODS, SERVICES, BRAND IDENTITY AND COMMERCIAL INFORMATION AND NEWS OF THIRD PARTIES THROUGH PRINT, AUDIO, VIDEO, DIGITAL AND ON-LINE MEDIUM (U.S. CLS. 100, 101 AND 102).

FIRST USE 2-1-2007; IN COMMERCE 2-1-2007.

CHRISTOPHER BUONGIORNO, EXAMINING ATTORNEY

SN 77-159,840. CANON COMMUNICATIONS LLC, LOS ANGELES, CA. FILED 4-18-2007.

PTXI

THE MARK CONSISTS OF STANDARD CHARACTERS WITHOUT CLAIM TO ANY PARTICULAR FONT, STYLE, SIZE, OR COLOR.

FOR ARRANGING AND CONDUCTING TRADE SHOWS IN THE FIELD OF ADVANCED DESIGN AND MANUFACTURING INDUSTRIES (U.S. CLS. 100, 101 AND 102).

TINA KUAN, EXAMINING ATTORNEY

CLASS 35—(Continued).

SN 77-159,968. REED ELSEVIER INC., NEWTON, MA. FILED 4-18-2007.

REED LIFE SCIENCES

THE MARK CONSISTS OF STANDARD CHARACTERS WITHOUT CLAIM TO ANY PARTICULAR FONT, STYLE, SIZE, OR COLOR.

NO CLAIM IS MADE TO THE EXCLUSIVE RIGHT TO USE "LIFE SCIENCES", APART FROM THE MARK AS SHOWN.

FOR ARRANGING AND CONDUCTING BUSINESS CONFERENCES; ARRANGING AND CONDUCTING TRADESHOWS IN THE FIELD OF LIFE SCIENCES (U.S. CLS. 100, 101 AND 102).

FIRST USE 5-0-2006; IN COMMERCE 5-0-2006.
KAREN K. BUSH, EXAMINING ATTORNEY

SN 77-160,099. DYNARAMA CORPORATION, RIVERTON, UT. FILED 4-18-2007.



THE MARK CONSISTS OF THE WORD "DYNARAMA" IN A MODIFIED FONT. THE "D" IS ENCLOSED BY A CIRCLE. THE CIRCLE IS MATCHED WITH THE "YRNAR-AMA".

FOR ON-LINE RETAIL STORE SERVICES FEATURING COMPUTERS, COMPUTER PARTS AND ACCESSORIES; RETAIL STORES FEATURING COMPUTERS, COMPUTER PARTS AND ACCESSORIES; ADVERTISING, INCLUDING PROMOTION RELATING TO THE SALE OF ARTICLES AND SERVICES FOR THIRD PARTIES BY THE TRANSMISSION OF ADVERTISING MATERIAL AND THE DISSEMINATION OF ADVERTISING MESSAGES ON COMPUTER NETWORKS; AUCTION MANAGEMENT SERVICES PROVIDED TO OTHERS OVER AN ON-LINE WEB SITE ACCESSED THROUGH A GLOBAL COMPUTER NETWORK; BUSINESS CONSULTATION SERVICES TO ASSIST NON-PROFIT ORGANIZATIONS IN PLANNING, MANAGING, AND CONDUCTING FUND RAISING ACTIVITIES VIA A GLOBAL COMPUTER NETWORK; BUSINESS SERVICES, NAMELY, PROVIDING COMPUTER DATABASES REGARDING THE PURCHASE AND SALE OF A WIDE VARIETY OF PRODUCTS AND SERVICES OF OTHERS; COMPUTER SERVICES, NAMELY, ADDRESS CHANGE NOTIFICATION SERVICES IN THE NATURE OF POSTING NOTIFICATIONS OF CHANGES OF ADDRESSES FOR BUSINESSES VIA THE INTERNET; COOPERATIVE ADVERTISING AND MARKETING SERVICES BY WAY OF SOLICITATION, CUSTOMER SERVICE AND PROVIDING MARKETING INFORMATION VIA WEBSITES ON A GLOBAL COMPUTER NETWORK; DIRECTING ORDERS FOR SECURITIES TRADES BY MEANS OF COMPUTER SOFTWARE WHICH AUTOMATICALLY DIRECTS TRADES TO THE BEST LOCATION FOR EXECUTING SUCH ORDERS; DISSEMINATION OF ADVERTISING, SCHEDULING AND MANAGING OF TRAINING COURSES AND PROGRAMS FOR OTHERS VIA A GLOBAL COMPUTER NETWORK; INFORMATION MANAGEMENT SERVICES, NAMELY, SHIPMENT PROCESSING, PREPARING SHIPPING DOCUMENTS AND INVOICES, TRACKING DOCUMENTS, PACKAGES AND FREIGHT OVER COMPUTER NETWORKS, INTRANETS AND INTERNETS; INTEGRATED TRACKING AND MANAGEMENT OF COMMERCIAL TRANSACTIONS

CLASS 35—(Continued).

ON A GLOBAL COMPUTER NETWORK; MATCHING CONSUMERS WITH REAL ESTATE PROFESSIONALS IN THE FIELD OF REAL ESTATE SERVICES VIA COMPUTER NETWORK; MATCHING CONSUMERS WITH PROFESSIONALS IN THE FIELD OF RESIDENTIAL AND COMMERCIAL SERVICES VIA COMPUTER NETWORK; ON-LINE ADVERTISING ON COMPUTER COMMUNICATION NETWORKS; OUTSOURCING IN THE FIELD OF SALES AND MARKETING OF COMPUTER SOFTWARE; PREPARATION OF CUSTOM OR NON-CUSTOM ADVERTISING FOR BUSINESSES FOR DISSEMINATION VIA THE WEB, CD OR DVD FOR OPTIONAL UPLOAD OR DOWNLOAD TO A COMPUTER; PREPARING COMPUTER SLIDE TRANSPARENCIES FOR USE BY BUSINESS; PROMOTING THE GOODS AND SERVICES OF OTHERS BY PREPARING AND PLACING ADVERTISEMENTS IN AN ELECTRONIC MAGAZINE ACCESSED THROUGH A GLOBAL COMPUTER NETWORK; PROMOTING THE GOODS AND SERVICES OF OTHERS VIA A GLOBAL COMPUTER NETWORK; PROVIDING A WEB SITE WHICH FEATURES ADVERTISEMENTS FOR THE GOODS AND SERVICES OF OTHERS ON A GLOBAL COMPUTER NETWORK; PROVIDING INFORMATION ABOUT THE GOODS AND SERVICES OF OTHERS VIA THE GLOBAL COMPUTER NETWORK; PROVIDING INFORMATION ON THE TOPIC OF PROMOTING PATIENT, PHYSICIAN AND EMPLOYEE SATISFACTION VIA A GLOBAL COMPUTER NETWORK; PROVIDING INFORMATION ABOUT COMMERCIAL BUSINESS AND COMMERCIAL INFORMATION VIA THE GLOBAL COMPUTER NETWORK (U.S. CLS. 100, 101 AND 102).

FIRST USE 6-1-2006; IN COMMERCE 6-1-2006.
CHRISTINE COOPER, EXAMINING ATTORNEY

SN 77-160,127. WASTE MANAGEMENT, INC., HOUSTON, TX. FILED 4-18-2007.

SUPPLIER DIVERSITY DRIVES BUSINESS

THE MARK CONSISTS OF STANDARD CHARACTERS WITHOUT CLAIM TO ANY PARTICULAR FONT, STYLE, SIZE, OR COLOR.

OWNER OF U.S. REG. NO. 3,270,968.
NO CLAIM IS MADE TO THE EXCLUSIVE RIGHT TO USE "SUPPLIER DIVERSITY", APART FROM THE MARK AS SHOWN.

FOR PROMOTING PUBLIC AWARENESS OF THE NEED FOR SUPPLIER DIVERSITY IN THE WASTE MANAGEMENT INDUSTRY; BUSINESS ASSISTANCE AND ADVICE SERVICES RELATING TO SUPPLIER DIVERSITY IN THE WASTE MANAGEMENT INDUSTRY (U.S. CLS. 100, 101 AND 102).

KIMBERLY FRYE, EXAMINING ATTORNEY

CLASS 35—(Continued).

SN 77-160,167. PYRAMID CONSULTING GROUP, LLC, NEW YORK, NY. FILED 4-18-2007.

WE KNOW FASHION

THE MARK CONSISTS OF STANDARD CHARACTERS WITHOUT CLAIM TO ANY PARTICULAR FONT, STYLE, SIZE, OR COLOR.

NO CLAIM IS MADE TO THE EXCLUSIVE RIGHT TO USE "FASHION", APART FROM THE MARK AS SHOWN.

FOR RECRUITMENT AND PLACEMENT OF TEMPORARY AND PART-TIME EMPLOYEES AND STAFF EXPERIENCED IN THE FIELD OF RETAIL SALE OF GARMENTS AND FASHION PRODUCTS (U.S. CLS. 100, 101 AND 102).

FIRST USE 3-15-2007; IN COMMERCE 4-1-2007.
MICHAEL LEWIS, EXAMINING ATTORNEY

SN 77-160,181. THE LOLLIPOP TREE, INC., MT. PLEASANT, SC. FILED 4-18-2007.



THE
LOLLIPOP TREE

FOR RETAIL AND ONLINE RETAIL STORE SERVICES FEATURING ARTWORK, ARCHITECTURAL ITEMS, CHILDREN'S FURNITURE AND ACCESSORIES, CHILDREN'S BOOKS, CHILDREN'S CLOTHING, CHILDREN'S PLAYHOUSES AND PLAYHOUSE DESIGN PLANS, DOG HOUSES AND DOG HOUSE DESIGN PLANS, CHILDREN'S TOYS, SKIN CARE PRODUCTS, PET ACCESSORIES, STATIONARY ITEMS AND GARDEN ACCESSORIES (U.S. CLS. 100, 101 AND 102).

LAURIE MAYES, EXAMINING ATTORNEY

CLASS 35—(Continued).

SN 77-160,221. COMMON ELEMENTS INC., LOS ANGELES CA 90012, CA. FILED 4-18-2007.



FOR RETAIL STORE SERVICES FEATURING CLOTHING, FOOTWEAR AND HEADGEAR, ORNAMENTS AND FASHION ACCESSORIES FOR MEN, WOMEN AND KIDS, TRAVELING BAGS, LUGGAGE, SHOPPING BAGS, HANDBAGS, PURSES, WALLETS; WHOLESALE STORES FEATURING CLOTHING, FOOTWEAR AND HEADGEAR, ORNAMENTS AND FASHION ACCESSORIES FOR MEN, WOMEN AND KIDS, TRAVELING BAGS, LUGGAGE, SHOPPING BAGS, HANDBAGS, PURSES, WALLETS; DISTRIBUTORSHIPS IN THE FIELD OF CLOTHING, FOOTWEAR AND HEADGEAR, ORNAMENTS AND FASHION ACCESSORIES FOR MEN, WOMEN AND KIDS, TRAVELING BAGS, LUGGAGE, SHOPPING BAGS, HANDBAGS, PURSES, WALLETS; ONLINE RETAIL CONSIGNMENT STORES FEATURING CLOTHING, FOOTWEAR AND HEADGEAR, ORNAMENTS AND FASHION ACCESSORIES FOR MEN, WOMEN AND KIDS, TRAVELING BAGS, LUGGAGE, SHOPPING BAGS, HANDBAGS, PURSES, WALLETS (U.S. CLS. 100, 101 AND 102).

REBECCA GILBERT, EXAMINING ATTORNEY

SN 77-160,224. COMMON ELEMENTS INC., LOS ANGELES CA 90012, CA. FILED 4-18-2007.

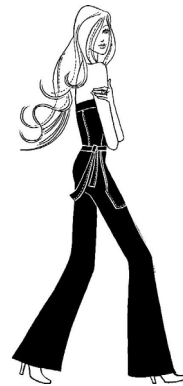

FOR RETAIL STORE SERVICES FEATURING CLOTHING, FOOTWEAR AND HEADGEAR, ORNAMENTS AND FASHION ACCESSORIES FOR MEN, WOMEN AND KIDS, TRAVELING BAGS, LUGGAGE, SHOPPING BAGS, HANDBAGS, PURSES, WALLETS; WHOLESALE STORES FEATURING CLOTHING, FOOTWEAR AND HEADGEAR, ORNAMENTS AND FASHION ACCESSORIES FOR MEN, WOMEN AND KIDS, TRAVELING BAGS, LUGGAGE, SHOPPING BAGS, HANDBAGS, PURSES, WALLETS; DISTRIBUTORSHIPS IN THE FIELD OF CLOTHING, FOOTWEAR AND HEADGEAR, ORNAMENTS AND FASHION ACCESSORIES FOR MEN, WOMEN AND KIDS, TRAVELING BAGS, LUGGAGE, SHOPPING BAGS, HANDBAGS, PURSES, WALLETS; ONLINE RETAIL CONSIGNMENT STORES FEATURING CLOTHING, FOOTWEAR AND HEADGEAR, ORNAMENTS AND FASHION ACCESSORIES FOR MEN, WOMEN AND KIDS, TRAVELING BAGS, LUGGAGE, SHOPPING BAGS, HANDBAGS, PURSES, WALLETS (U.S. CLS. 100, 101 AND 102).

REBECCA GILBERT, EXAMINING ATTORNEY

CLASS 35—(Continued).

SN 77-160,322. PEDIASTAFF, INC., TUPELO, MS. FILED 4-19-2007.



THE MARK CONSISTS OF A LITTLE BOY DOING A CARTWHEEL.
 FOR EMPLOYMENT HIRING, RECRUITING, PLACEMENT, STAFFING AND CAREER NETWORKING SERVICES (U.S. CLS. 100, 101 AND 102).
 FIRST USE 10-1-2004; IN COMMERCE 10-1-2004.
 JEAN IM, EXAMINING ATTORNEY

CLASS 35—(Continued).

SN 77-160,796. COPPER DEVELOPMENT ASSOCIATION, NEW YORK, NY. FILED 4-19-2007.

Clean to the Touch

THE MARK CONSISTS OF STANDARD CHARACTERS WITHOUT CLAIM TO ANY PARTICULAR FONT, STYLE, SIZE, OR COLOR.

NO CLAIM IS MADE TO THE EXCLUSIVE RIGHT TO USE "CLEAN" OR "TOUCH", APART FROM THE MARK AS SHOWN.

FOR ASSOCIATION SERVICES, NAMELY, PROMOTING THE INTERESTS OF COPPER ALLOY MANUFACTURERS BY RAISING PUBLIC AWARENESS OF THE ANTIMICROBIAL PROPERTIES OF COPPER ALLOYS FOR USE IN PRODUCT DESIGN AND BUILDING CONSTRUCTION (U.S. CLS. 100, 101 AND 102).

KATHY DE JONGE, EXAMINING ATTORNEY

SN 77-160,497. JUST CHILL COMPANY, WYNNWOOD, PA. FILED 4-19-2007.

JUST CHILL

THE MARK CONSISTS OF STANDARD CHARACTERS WITHOUT CLAIM TO ANY PARTICULAR FONT, STYLE, SIZE, OR COLOR.

FOR RETAIL STORE SERVICES FEATURING WATER ICE, FROZEN CUSTARD AND OTHER FROZEN CONFECTIONS, FOR CONSUMPTION ON AND OFF THE PREMISES (U.S. CLS. 100, 101 AND 102).

MATTHEW PAPPAS, EXAMINING ATTORNEY

SN 77-160,890. AMEROP SUGAR CORPORATION, MIAMI, FL. FILED 4-19-2007.

SUCDEN

THE MARK CONSISTS OF STANDARD CHARACTERS WITHOUT CLAIM TO ANY PARTICULAR FONT, STYLE, SIZE, OR COLOR.

FOR BUSINESS MANAGEMENT OF FOOD PROCESSING FACILITIES (U.S. CLS. 100, 101 AND 102).

THEODORE MCBRIDE, EXAMINING ATTORNEY

CLASS 35—(Continued).

SN 77-160,993. FLUM, PAUL L., ST. LOUIS, MO. FILED 4-19-2007.

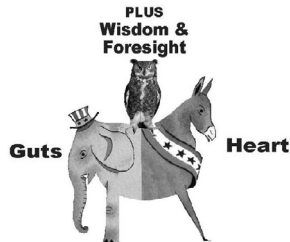

THE MARK CONSISTS OF OWL SITTING ON MYTHOLOGICAL BEAST THAT IS HALF ELEPHANT HALF DONKEY WHEREIN ELEPHANT HAS A TOP HAT WITH STARS AND STRIPES ON IT'S HEAD AND THE DONKEY IS WEARING A SASH WITH STRIPES AND STARS WITH PLUS WISDOM & FORESIGHT ABOVE THE OWL'S HEAD, GUTS TO THE LEFT OF THE ELEPHANT, HEART TO THE RIGHT OF THE DONKEY.

FOR PROMOTING AND ADVOCATING A POLITICAL PHILOSOPHY AND PUBLIC AWARENESS FOR WORLD PEACE, NATIONAL SECURITY, EDUCATION, ECOLOGY, MILITARY AFFAIRS, HUMAN RIGHTS, HEALTH AND NUTRITION, COMMERCE, NATURE AND THE ENVIRONMENT, HUMAN SERVICES, ECONOMICS, POLITICS, BUSINESS, AND JUSTICE FOR ALL (U.S. CLS. 100, 101 AND 102).

JENNIFER MARTIN, EXAMINING ATTORNEY

SN 77-161,043. COOL SCHOOL INCENTIVES, INC., BECKER, MN. FILED 4-19-2007.

Better 4 U

THE MARK CONSISTS OF STANDARD CHARACTERS WITHOUT CLAIM TO ANY PARTICULAR FONT, STYLE, SIZE, OR COLOR.

FOR ADVERTISING, MARKETING AND PROMOTION SERVICES (U.S. CLS. 100, 101 AND 102).

PATRICIA EVANKO, EXAMINING ATTORNEY

CLASS 35—(Continued).

SN 77-161,087. GERMAN AMERICAN CHAMBER OF COMMERCE INC., NEW YORK, NY. FILED 4-19-2007.

AHK USA

THE MARK CONSISTS OF STANDARD CHARACTERS WITHOUT CLAIM TO ANY PARTICULAR FONT, STYLE, SIZE, OR COLOR.

NO CLAIM IS MADE TO THE EXCLUSIVE RIGHT TO USE "USA", APART FROM THE MARK AS SHOWN.

FOR CHAMBER OF COMMERCE SERVICES, NAMELY, PROMOTING AND FOSTERING TRADE RELATIONS BETWEEN THE FEDERAL REPUBLIC OF GERMANY AND THE UNITED STATES, AND DISSEMINATING INFORMATION CONCERNING COMMERCE AND TRADE BETWEEN THESE COUNTRIES (U.S. CLS. 100, 101 AND 102).

CURTIS FRENCH, EXAMINING ATTORNEY

SN 77-161,139. GERMAN AMERICAN CHAMBER OF COMMERCE INC., NEW YORK, NY. FILED 4-19-2007.

GACC USA

THE MARK CONSISTS OF STANDARD CHARACTERS WITHOUT CLAIM TO ANY PARTICULAR FONT, STYLE, SIZE, OR COLOR.

NO CLAIM IS MADE TO THE EXCLUSIVE RIGHT TO USE "USA", APART FROM THE MARK AS SHOWN.

FOR CHAMBER OF COMMERCE SERVICES, NAMELY, PROMOTING AND FOSTERING TRADE RELATIONS BETWEEN THE FEDERAL REPUBLIC OF GERMANY AND THE UNITED STATES, AND DISSEMINATING INFORMATION CONCERNING COMMERCE AND TRADE BETWEEN THESE COUNTRIES (U.S. CLS. 100, 101 AND 102).

CURTIS FRENCH, EXAMINING ATTORNEY

SN 77-161,236. ETRADESHOWMODELS.COM, LLC, LAGUNA NIGUEL, CA. FILED 4-19-2007.

Showtime Models

THE MARK CONSISTS OF STANDARD CHARACTERS WITHOUT CLAIM TO ANY PARTICULAR FONT, STYLE, SIZE, OR COLOR.

NO CLAIM IS MADE TO THE EXCLUSIVE RIGHT TO USE "MODELS", APART FROM THE MARK AS SHOWN.

FOR PROVIDING PERSONNEL STAFFING TO THE ORGANIZED EVENTS AND TRADE SHOW INDUSTRY (U.S. CLS. 100, 101 AND 102).

CURTIS FRENCH, EXAMINING ATTORNEY

CLASS 35—(Continued).

SN 77-161,301. MACLEAN, EDWARD G., BOSTON, MA.
FILED 4-19-2007.

Potted UP

THE MARK CONSISTS OF STANDARD CHARACTERS WITHOUT CLAIM TO ANY PARTICULAR FONT, STYLE, SIZE, OR COLOR.

FOR RETAIL STORE, ON-LINE RETAIL STORE, AND MAIL ORDER SERVICES IN THE FIELDS OF GARDENING SUPPLIES, TOOLS, GARDENING GLOVES, LIVE PLANTS AND FLOWERS, BULBS, SEEDS, FERTILIZERS, GARDEN STRUCTURES, GARDEN ORNAMENTS, PLANT CONTAINERS, WATERING CANS, OUTDOOR FURNITURE, INDOOR FURNITURE, HOME FURNISHINGS, HOUSE WARES, FLOOR COVERINGS AND BOOKS (U.S. CLS. 100, 101 AND 102).

SUSAN LESLIE DUBOIS, EXAMINING ATTORNEY

SN 77-161,312. RUBINO, RENEE, A, RIDGEFIELD, NJ.
FILED 4-19-2007.

NJMS A Legal Solution That YOU Design

THE MARK CONSISTS OF STANDARD CHARACTERS WITHOUT CLAIM TO ANY PARTICULAR FONT, STYLE, SIZE, OR COLOR.

FOR MEDIATION AND CONCLUSION OF COMMERCIAL TRANSACTIONS FOR OTHERS (U.S. CLS. 100, 101 AND 102).

GINA HAYES, EXAMINING ATTORNEY

SN 77-161,364. AMERICAN FREIGHT OF OHIO, INC.,
LEXINGTON, OH. FILED 4-20-2007.

AMERICAN FREIGHT

THE MARK CONSISTS OF STANDARD CHARACTERS WITHOUT CLAIM TO ANY PARTICULAR FONT, STYLE, SIZE, OR COLOR.

NO CLAIM IS MADE TO THE EXCLUSIVE RIGHT TO USE AMERICAN, APART FROM THE MARK AS SHOWN.

FOR RETAIL STORE SERVICES FEATURING MATRESSES, FURNITURE, AND CARPETING (U.S. CLS. 100, 101 AND 102).

FIRST USE 2-0-1994; IN COMMERCE 9-0-1994.

JOANNA DUKOVIC, EXAMINING ATTORNEY

CLASS 35—(Continued).

SN 77-162,173. AL & ED'S CORPORATION, VAN NUYS, CA.
FILED 4-20-2007.

Mr. Mobile

THE MARK CONSISTS OF STANDARD CHARACTERS WITHOUT CLAIM TO ANY PARTICULAR FONT, STYLE, SIZE, OR COLOR.

FOR PROVIDING CONSUMER PRODUCT INFORMATION IN THE FIELD OF PORTABLE ELECTRONICS AND COMMUNICATION EQUIPMENT AND ELECTRONIC AUTO AND MARINE ACCESSORIES NAMELY RADIOS, COMPACT DISKS, TAPE PLAYERS, DVD PLAYERS, AMPLIFIERS, SPEAKERS, SUBWOOFERS, EQUALIZERS AND PROCESSORS, VIDEO SYSTEMS, SATELLITE RADIO SYSTEMS, THEATERS, NAVIGATION AND GLOBAL POSITIONING EQUIPMENT, SECURITY AND ALARM EQUIPMENT, CELLULAR PHONES, PAGERS, RADAR DETECTORS, LOCATING DEVICES, BACKUP SAFETY EQUIPMENT, REMOTE STARTERS AND RELATED ACCESSORIES VIA THE INTERNET (U.S. CLS. 100, 101 AND 102).

GEOFFREY FOSDICK, EXAMINING ATTORNEY

SN 77-162,293. THE KROGER CO. OF MICHIGAN, LIVONIA,
MI. FILED 4-20-2007.

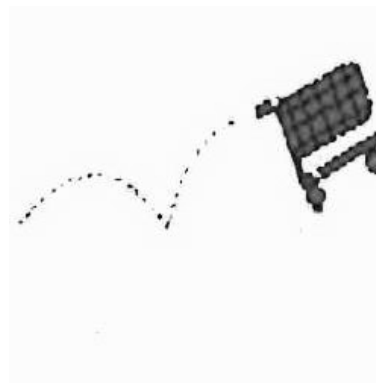

THE MARK CONSISTS OF SHOPPING CART TILTING ON ITS BACK WHEELS WITH ONE AND A HALF ARCS FACING DOWNWARD BEHIND IT, GIVING THE APPEARANCE OF A BOUNCING CART.

FOR RETAIL GROCERY STORE SERVICES FEATURING A CUSTOMER LOYALTY REWARDS PROGRAM FOR SHOPPERS (U.S. CLS. 100, 101 AND 102).

CHERYL CLAYTON, EXAMINING ATTORNEY

CLASS 35—(Continued).

SN 77-162,374. RICHIEDA SPRINGS LLC, PORT ST LUCIE, FL. FILED 4-20-2007.

RICHIEDA SPRINGS

THE MARK CONSISTS OF STANDARD CHARACTERS WITHOUT CLAIM TO ANY PARTICULAR FONT, STYLE, SIZE, OR COLOR.

FOR ON-LINE RETAIL STORE SERVICES FEATURING SKIN CARE TREATMENTS, NUTRITIONAL SUPPLEMENTS, FITNESS DVDS, CDS AND FITNESS EQUIPMENT (U.S. CLS. 100, 101 AND 102).

FIRST USE 6-1-2006; IN COMMERCE 3-7-2007.

RICHARD A. STRASER, EXAMINING ATTORNEY

SN 77-162,420. WILSON, DONALD S, PACIFICA, CA. FILED 4-21-2007.

AskDon

THE MARK CONSISTS OF STANDARD CHARACTERS WITHOUT CLAIM TO ANY PARTICULAR FONT, STYLE, SIZE, OR COLOR.

FOR ADVERTISING AND COMMERCIAL INFORMATION SERVICES, VIA THE INTERNET; ADVERTISING AND MARKETING; ADVERTISING SERVICES, NAMELY, PROMOTING AND MARKETING THE GOODS AND SERVICES OF OTHERS THROUGH ALL PUBLIC COMMUNICATION MEANS; ADVERTISING VIA ELECTRONIC MEDIA AND SPECIFICALLY THE INTERNET; ADVERTISING, MARKETING AND PROMOTION SERVICES; ADVICE IN THE FIELD OF BUSINESS MANAGEMENT AND MARKETING; BUSINESS CONSULTATION AND MANAGEMENT REGARDING MARKETING ACTIVITIES AND LAUNCHING OF NEW PRODUCTS; BUSINESS MARKETING AND DIRECT MAIL CONSULTING SERVICES; DISSEMINATION OF ADVERTISING FOR OTHERS VIA THE INTERNET; INFORMATION OR ENQUIRIES ON BUSINESS AND MARKETING; INFORMATION, ADVISORY AND CONSULTANCY SERVICES RELATING TO BUSINESS AND MANAGEMENT OR BUSINESS ADMINISTRATION, INCLUDING SUCH SERVICES PROVIDED ON LINE OR VIA THE INTERNET; ON-LINE ADVERTISING AND MARKETING SERVICES; PROMOTING, ADVERTISING AND MARKETING OF THE ON-LINE WEBSITES OF OTHERS (U.S. CLS. 100, 101 AND 102).

RONALD MCMORROW, EXAMINING ATTORNEY

CLASS 35—(Continued).

SN 77-162,458. ANGELE HENDRYS, NEW ROCHELLE, NY. FILED 4-21-2007.

SYMBOLTEC

THE MARK CONSISTS OF STANDARD CHARACTERS WITHOUT CLAIM TO ANY PARTICULAR FONT, STYLE, SIZE, OR COLOR.

FOR DEVELOPMENT OF CONCEPTS FOR BUSINESS ECONOMY (U.S. CLS. 100, 101 AND 102).

FIRST USE 7-9-1996; IN COMMERCE 8-23-2001.

GEORGIA CARTY, EXAMINING ATTORNEY

SN 77-162,717. THE CARTOON NETWORK, INC., ATLANTA, GA. FILED 4-23-2007.

GET ANIMATED

THE MARK CONSISTS OF STANDARD CHARACTERS WITHOUT CLAIM TO ANY PARTICULAR FONT, STYLE, SIZE, OR COLOR.

FOR PROVIDING INFORMATION AND NEWS PROMOTING THE PUBLIC AWARENESS OF THE PHYSICAL, SOCIAL AND EMOTIONAL BENEFITS OF PHYSICAL EDUCATION AND PHYSICAL ACTIVITY; PROVIDING A CONTINUING SERIES OF PUBLIC SERVICE CAMPAIGNS PROMOTING PUBLIC AWARENESS OF THE PHYSICAL, SOCIAL AND EMOTIONAL BENEFITS OF PHYSICAL EDUCATION AND PHYSICAL ACTIVITY VIA ALL FORMS OF MEDIA, INCLUDING TELEVISION, LIVE EVENTS, PRINT AND THE INTERNET (U.S. CLS. 100, 101 AND 102).

FIRST USE 2-1-2005; IN COMMERCE 2-1-2005.

RAMONA ORTIGA, EXAMINING ATTORNEY

SN 77-163,420. HELEN OF TROY LIMITED, ST. MICHAEL, BARBADOS, FILED 4-23-2007.

Plug in, Light Up, Rock Out!

THE MARK CONSISTS OF STANDARD CHARACTERS WITHOUT CLAIM TO ANY PARTICULAR FONT, STYLE, SIZE, OR COLOR.

FOR ADVERTISING AND MARKETING; ADVERTISING, MARKETING AND PROMOTION SERVICES (U.S. CLS. 100, 101 AND 102).

LAURA HAMMEL, EXAMINING ATTORNEY

CLASS 35—(Continued).

SN 77-164,201. CREATIVE & RESPONSE RESEARCH SERVICES, INC., CHICAGO, IL. FILED 4-24-2007.

SHOPPEREYES

THE MARK CONSISTS OF STANDARD CHARACTERS WITHOUT CLAIM TO ANY PARTICULAR FONT, STYLE, SIZE, OR COLOR.

FOR MARKETING RESEARCH SERVICES, NAMELY, CONDUCTING RESEARCH SURVEYS AND INTERVIEWS TO OBTAIN AN ASSESSMENT OF PRODUCTS, SERVICES, ADVERTISEMENTS AND PROMOTIONS (U.S. CLS. 100, 101 AND 102).

WILLIAM VERHOSEK, EXAMINING ATTORNEY

SN 77-164,258. DIGITAL IMS, INC., LINCOLN, NE. FILED 4-24-2007.

FIRESPRING

THE MARK CONSISTS OF STANDARD CHARACTERS WITHOUT CLAIM TO ANY PARTICULAR FONT, STYLE, SIZE, OR COLOR.

FOR ADVERTISING SERVICES, NAMELY, CREATING CORPORATE AND BRAND IDENTITY FOR OTHERS; ADVERTISING SERVICES, NAMELY, PROMOTING AND MARKETING THE GOODS AND SERVICES OF OTHERS THROUGH ALL PUBLIC COMMUNICATION MEANS; ADVERTISING, MARKETING AND PROMOTION SERVICES; ADVERTISING AGENCIES, NAMELY, PROMOTING THE GOODS AND SERVICES OF OTHERS; FRANCHISE SERVICES, NAMELY, OFFERING TECHNICAL AND BUSINESS MANAGEMENT ASSISTANCE IN THE ESTABLISHMENT AND OPERATION OF INTERNET BASED ADVERTISING AGENCY AND WEB SITE DEVELOPMENT BUSINESSES (U.S. CLS. 100, 101 AND 102).

VERNA BETH RIRIE, EXAMINING ATTORNEY

CLASS 35—(Continued).

SN 77-164,270. AMERICAN BUSINESS SOLUTIONS, INC., OMAHA, NE. FILED 4-24-2007.

THE UPGRADE PLACE

THE MARK CONSISTS OF STANDARD CHARACTERS WITHOUT CLAIM TO ANY PARTICULAR FONT, STYLE, SIZE, OR COLOR.

NO CLAIM IS MADE TO THE EXCLUSIVE RIGHT TO USE "UPGRADE", APART FROM THE MARK AS SHOWN.

FOR ON-LINE RETAIL STORE SERVICES FEATURING BACKUP DRIVES FOR COMPUTERS, BATTERIES, BATTERY CASES, BATTERY CHARGERS, BATTERY PACKS, BLANK HARD DRIVES FOR COMPUTERS, CELL PHONE ACCESSORIES, COMPUTER DISC DRIVES, COMPUTER MEMORIES, COMPUTER MEMORY HARDWARE, DIGITAL CAMERA MEMORY, DIGITAL CAMERAS, DIGITAL DISC DRIVES, DISC MEMORIES, ELECTRIC STORAGE BATTERIES, ELECTRICAL CELLS AND BATTERIES, ELECTRONIC MEMORIES, EXTERNAL HARD DRIVES, FLASH CARD ADAPTERS, FLASH CARD READERS, FLASH MEMORY CARD, MEMORY BOARDS, COMPUTER HARDWARE IN THE NATURE OF MEMORY CARDS, MEMORY EXPANSION MODULES, MEMORY UPGRADES FOR DESKTOPS, LAPTOPS, LASER PRINTERS AND SERVERS, MOBILE TELEPHONE BATTERIES, OPTICAL DISC DRIVES, PORTABLE HARD DRIVES, RAM (RANDOM ACCESS MEMORY) CARD, RECHARGEABLE ELECTRIC BATTERIES, SEMI-CONDUCTOR MEMORIES, UPS BACK UP BATTERIES, USB (UNIVERSAL SERIAL BUS) HARDWARE, USB (UNIVERSAL SERIAL BUS) OPERATING SOFTWARE, USB CARD READERS, USB FLASH DRIVES, AND COMPUTER STORAGE DEVICES, NAMELY, FLASH DRIVES AND THUMB DRIVES; MAIL ORDER CATALOG SERVICES FEATURING BACKUP DRIVES FOR COMPUTERS, BATTERIES, BATTERY CASES, BATTERY CHARGERS, BATTERY PACKS, BLANK HARD DRIVES FOR COMPUTERS, CELL PHONE ACCESSORIES, COMPUTER DISC DRIVES, COMPUTER MEMORIES, COMPUTER MEMORY HARDWARE, DIGITAL CAMERA MEMORY, DIGITAL CAMERAS, DIGITAL DISC DRIVES, DISC MEMORIES, ELECTRIC STORAGE BATTERIES, ELECTRICAL CELLS AND BATTERIES, ELECTRONIC MEMORIES, EXTERNAL HARD DRIVES, FLASH CARD ADAPTERS, FLASH CARD READERS, FLASH MEMORY CARD, MEMORY BOARDS, COMPUTER HARDWARE IN THE NATURE OF MEMORY CARDS, MEMORY EXPANSION MODULES, MEMORY UPGRADES FOR DESKTOPS, LAPTOPS, LASER PRINTERS AND SERVERS, MOBILE TELEPHONE BATTERIES, OPTICAL DISC DRIVES, PORTABLE HARD DRIVES, RAM (RANDOM ACCESS MEMORY) CARD, RECHARGEABLE ELECTRIC BATTERIES, SEMI-CONDUCTOR MEMORIES, UPS BACK UP BATTERIES, USB (UNIVERSAL SERIAL BUS) HARDWARE, USB (UNIVERSAL SERIAL BUS) OPERATING SOFTWARE, USB CARD READERS, USB FLASH DRIVES, AND COMPUTER STORAGE DEVICES, NAMELY, FLASH DRIVES AND THUMB DRIVES (U.S. CLS. 100, 101 AND 102).

COLLEEN DOMBROW, EXAMINING ATTORNEY

CLASS 35—(Continued).

SN 77-164,295. JUMPFly, INC., ALGONQUIN, IL. FILED 4-24-2007.



THE COLOR(S) PURPLE, BLACK, GRAY AND WHITE IS/ARE CLAIMED AS A FEATURE OF THE MARK.

THE MARK CONSISTS OF A STYLIZED WORD "JUMPFly" IN PURPLE TEXT WITH BLACK SHADOWING ON THE RIGHT SIDE OF THE LETTERS SURROUNDED BY GRAY LINES AND WHITE CURVED LINES WITH BLACK BORDERS CIRCLING "JUMPFly".

FOR ON-LINE ADVERTISING AND MARKETING, NAMELY, PROMOTING THE GOODS AND SERVICES OF OTHERS BY PROVIDING HYPERTEXT PAY-PER-CLICK LINKS TO THE WEB SITES OF OTHERS; ADVERTISING AND BUSINESS MANAGEMENT CONSULTANCY (U.S. CLS. 100, 101 AND 102).

FIRST USE 7-16-2003; IN COMMERCE 8-1-2003.
CAROLINE WOOD, EXAMINING ATTORNEY

CLASS 35—(Continued).

SN 77-164,303. NATIONAL ALLIANCE OF CONCURRENT ENROLLMENT PARTNERSHIPS, INC., SYRACUSE, NY. FILED 4-24-2007.

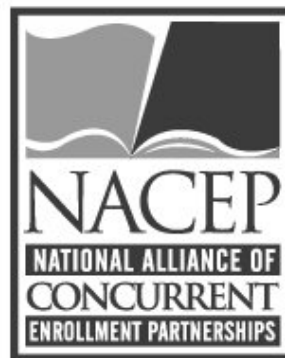

OWNER OF U.S. REG. NOS. 3,015,629 AND 3,017,909.
NO CLAIM IS MADE TO THE EXCLUSIVE RIGHT TO USE "NATIONAL ALLIANCE OF CONCURRENT ENROLLMENT PARTNERSHIPS", APART FROM THE MARK AS SHOWN.

THE MARK CONSISTS IN PART OF A STYLIZED OPEN BOOK.

FOR ASSOCIATION SERVICES, NAMELY, PROMOTING THE INTERESTS OF CONCURRENT ENROLLMENT EDUCATION PROGRAMS (U.S. CLS. 100, 101 AND 102).

FIRST USE 10-30-2006; IN COMMERCE 10-30-2006.
HANNO RITTNER, EXAMINING ATTORNEY

SN 77-164,561. AUTOMATED VENDING TECHNOLOGIES, INC., CORONA, CA. FILED 4-24-2007.

SN 77-164,301. JOBMEDLEY, INC., OAKLAND, CA. FILED 4-24-2007.

JobMedley



THE COLOR(S) WHITE, BLACK AND RED IS/ARE CLAIMED AS A FEATURE OF THE MARK.

THE MARK CONSISTS OF WHITE BACKGROUND, WITH THE LETTERS "TSV" IN A RECTANGLE OUTLINED IN BLACK. THE LETTER "T" IS IN RED AND "SV" IN BLACK. THE LETTERS ALSO HAVE FINGERPRINTS IN THE FONT LETTERS.

FOR VENDING MACHINE SERVICES (U.S. CLS. 100, 101 AND 102).

FIRST USE 1-1-2005; IN COMMERCE 1-1-2005.
JOHN DWYER, EXAMINING ATTORNEY

THE MARK CONSISTS OF STANDARD CHARACTERS WITHOUT CLAIM TO ANY PARTICULAR FONT, STYLE, SIZE, OR COLOR.

FOR PROVIDING AN ON-LINE SEARCHABLE DATABASE FEATURING CLASSIFIED AD LISTINGS AND EMPLOYMENT OPPORTUNITIES (U.S. CLS. 100, 101 AND 102).

JUDITH HELFMAN, EXAMINING ATTORNEY

CLASS 35—(Continued).

SN 77-165,351. DIVINE PHYSICS HOLISTIC LIFESTYLES & REGENERATION INSTITUTE, INC., CENTENNIAL, CO. FILED 4-25-2007.

THE ART OF UNFOLDING THE
SPIRIT WITHIN

THE MARK CONSISTS OF STANDARD CHARACTERS WITHOUT CLAIM TO ANY PARTICULAR FONT, STYLE, SIZE, OR COLOR.

FOR RETAIL STORES FEATURING HEALTH, NUTRITION, WELLNESS AND COSMETIC PREPARATIONS AND PRODUCTS AND PRINTED LITERATURE MATERIALS ON SUCH SUBJECTS, AVAILABLE BOTH ON-LINE AND AT THE STORE LOCATION (U.S. CLS. 100, 101 AND 102).

MORENO, PAUL, EXAMINING ATTORNEY

SN 77-165,399. HENRY KOON, FLUSHING, NY. FILED 4-25-2007.

Super Affiliates Hall Of
Fame

THE MARK CONSISTS OF STANDARD CHARACTERS WITHOUT CLAIM TO ANY PARTICULAR FONT, STYLE, SIZE, OR COLOR.

NO CLAIM IS MADE TO THE EXCLUSIVE RIGHT TO USE "HALL OF FAME", APART FROM THE MARK AS SHOWN.

FOR PROVIDING INFORMATION IN THE FIELD OF MARKETING AND ON-LINE MARKETING MEDIA VIA THE INTERNET (U.S. CLS. 100, 101 AND 102).

JULIE THOMAS, EXAMINING ATTORNEY

SN 77-165,400. BC&CC FINANCE SA, WAVRE, BELGIUM, FILED 4-25-2007.

BELGIUM'S BEST

THE MARK CONSISTS OF STANDARD CHARACTERS WITHOUT CLAIM TO ANY PARTICULAR FONT, STYLE, SIZE, OR COLOR.

OWNER OF U.S. REG. NO. 2,430,571.
SEC. 2(F).

FOR COMPUTERIZED ON-LINE RETAIL STORE SERVICES IN THE FIELD OF CHOCOLATE AND CONFECTIONARIES (U.S. CLS. 100, 101 AND 102).

FIRST USE 7-1-1988; IN COMMERCE 1-29-1997.

JULIE THOMAS, EXAMINING ATTORNEY

CLASS 35—(Continued).

SN 77-165,419. JEFFREY NORTON PUBLISHERS, INC., MADISON, CT. FILED 4-25-2007.

AUDIO-FORUM

THE MARK CONSISTS OF STANDARD CHARACTERS WITHOUT CLAIM TO ANY PARTICULAR FONT, STYLE, SIZE, OR COLOR.

FOR MAIL ORDER AND COMPUTER ON-LINE ORDERING SERVICES IN THE FIELD OF RECORDED SELF-INSTRUCTIONAL EDUCATIONAL AND LANGUAGE COURSES (U.S. CLS. 100, 101 AND 102).

FIRST USE 9-30-1972; IN COMMERCE 9-30-1972.
MONIQUE MILLER, EXAMINING ATTORNEY

SN 77-165,624. DEUTSCHE TELEKOM AG, BONN, FED REP GERMANY, FILED 4-25-2007.

MDA Touch

THE MARK CONSISTS OF STANDARD CHARACTERS WITHOUT CLAIM TO ANY PARTICULAR FONT, STYLE, SIZE, OR COLOR.

OWNER OF U.S. REG. NOS. 2,930,990, 2,942,203 AND OTHERS.

FOR TELEPHONE DIRECTORY ASSISTANCE SERVICES; ADVERTISING SERVICES, NAMELY, PREPARING AND PLACING ADVERTISEMENTS FOR OTHERS PROMOTING THE GOODS AND SERVICES OF OTHERS THROUGH PRINTED ADVERTISING, PRINTED DIRECTORIES, THROUGH ENCODED MEDIA, THROUGH THE DISSEMINATION OF PROMOTIONAL MATERIALS, THROUGH DIRECT MAIL ADVERTISING, THROUGH ELECTRONIC BILLBOARD ADVERTISING, PREPARING AUDIO-VISUAL PRESENTATIONS FOR USE IN ADVERTISING; BUSINESS MANAGEMENT SERVICES, NAMELY, BUSINESS APPRAISALS, BUSINESS AUDITING, PROVIDING BUSINESS INFORMATION, NAMELY, PREPARING BUSINESS REPORTS AND CONDUCTING BUSINESS RESEARCH, ANALYSIS AND SURVEYS, BUSINESS MANAGEMENT PLANNING, BUSINESS MANAGEMENT CONSULTATION, BUSINESS MANAGEMENT SUPERVISION, CONDUCTING BUSINESS NETWORKING FOR OTHERS; BUSINESS MANAGEMENT AND CONSULTING SERVICES, EXCLUDING AGRICULTURAL BUSINESS MANAGEMENT AND CONSULTING SERVICES; PROVIDING INFORMATION VIA THE TELEPHONE AND THE GLOBAL COMMUNICATION NETWORKS IN THE FIELD OF ADVERTISING AND BUSINESS MARKETING; PROFESSIONAL CONSULTANCY IN THE FIELD OF DATA PROCESSING; RENTAL OF AUTOMATIC VENDING MACHINES; RENTAL OF DATA PROCESSING EQUIPMENT; ORGANIZING JOB FAIRS (U.S. CLS. 100, 101 AND 102).

JENNIFER HETU, EXAMINING ATTORNEY

CLASS 35—(Continued).

SN 77-167,773. BASS PRO TRADEMARKS, L.L.C., SPRINGFIELD, MO. FILED 4-27-2007.

CLASS 35—(Continued).

SN 77-174,049. AMERICAN HOSPITAL ASSOCIATION, CHICAGO, IL. FILED 5-7-2007.

YOUR ADVENTURE STARTS HERE

AHCAP

THE MARK CONSISTS OF STANDARD CHARACTERS WITHOUT CLAIM TO ANY PARTICULAR FONT, STYLE, SIZE, OR COLOR.

FOR RETAIL SPORTING GOODS STORE SERVICES (U.S. CLS. 100, 101 AND 102).

FIRST USE 6-9-2004; IN COMMERCE 6-9-2004.

ROBERT C. CLARK JR., EXAMINING ATTORNEY

THE MARK CONSISTS OF STANDARD CHARACTERS WITHOUT CLAIM TO ANY PARTICULAR FONT, STYLE, SIZE, OR COLOR.

FOR ASSOCIATION SERVICES, NAMELY PROMOTING THE INTERESTS OF ADMINISTRATIVE PROFESSIONALS IN THE HEALTHCARE FIELD (U.S. CLS. 100, 101 AND 102).

FIRST USE 5-1-2007; IN COMMERCE 5-1-2007.

ELIZABETH KAJUBI, EXAMINING ATTORNEY

SN 77-171,818. AARP, WASHINGTON, DC. FILED 5-3-2007.

SN 77-179,232. TEAM QUEST STAFFING SERVICES, INC., SANTA ANA, CA. FILED 5-11-2007.

TOGETHER WE CAN DO ANYTHING



THE MARK CONSISTS OF STANDARD CHARACTERS WITHOUT CLAIM TO ANY PARTICULAR FONT, STYLE, SIZE, OR COLOR.

FOR PROVIDING INFORMATION ABOUT POLITICAL ELECTIONS; VOTER ADVOCACY SERVICES, NAMELY, PROVIDING INFORMATION ABOUT POLITICAL ELECTIONS, VOTING, AND POLITICAL OFFICE CANDIDATES; PUBLIC ADVOCACY SERVICES TO PROMOTE THE INTERESTS OF MATURE CITIZENS AND FAMILIES BY INCREASING PUBLIC AND GOVERNMENT INTEREST IN AND AWARENESS OF LEGISLATION, REGULATIONS, POLICIES AND ISSUES AFFECTING CITIZENS AND FAMILIES THROUGH MEETINGS WITH AND WRITTEN AND VERBAL COMMUNICATIONS TO LOCAL, STATE AND FEDERAL LEGISLATORS, GOVERNMENT BODIES, GOVERNMENT OFFICIALS AND MEDIA OUTLETS, SPONSORSHIP OF PUBLIC EVENTS, COORDINATION OF GRASSROOTS VOTER ADVOCACY EFFORTS, AND COLLABORATION WITH OTHER ORGANIZATIONS AND COALITIONS IN SUPPORT OF CIVIL RIGHTS, SENIOR RIGHTS, AND THE WELL BEING OF MATURE CITIZENS AND FAMILIES (U.S. CLS. 100, 101 AND 102).

MONIQUE MILLER, EXAMINING ATTORNEY

THE COLOR(S) RED, YELLOW, AND WHITE IS/ARE CLAIMED AS A FEATURE OF THE MARK.

THE MARK CONSISTS OF RED LOWER CASE LETTER "t", ENCIRCLED WITH A RED CAPITAL LETTER "Q." THE LETTER "Q" IS APPROXIMATELY TWICE THE SIZE OF THE LETTER "t". THERE IS A LIGHT YELLOW SHADOW OF THE LETTER "Q", DEFLECTED TO THE LEFT OF THE LETTER Q. TWO DARK YELLOW OVAL LINES BACKGROUND THE LETTER "Q." PART OF THE OUTER EDGE AND INNER PORTION OF THE LETTER "Q" ARE IN WHITE.

FOR EMPLOYMENT AGENCIES; EMPLOYMENT COUNSELING AND RECRUITING; EMPLOYMENT HIRING, RECRUITING, PLACEMENT, STAFFING AND CAREER NETWORKING SERVICES; TEMPORARY EMPLOYMENT AGENCIES; PERSONNEL PLACEMENT AND RECRUITMENT (U.S. CLS. 100, 101 AND 102).

FIRST USE 1-1-2002; IN COMMERCE 1-1-2002.

EDWARD NELSON, EXAMINING ATTORNEY

CLASS 35—(Continued).

SN 77-183,125. STERK, MARIUS, COLLIERVILLE, TN.
FILED 5-16-2007.



NO CLAIM IS MADE TO THE EXCLUSIVE RIGHT TO USE "GROUP, LLC", APART FROM THE MARK AS SHOWN.

THE COLOR(S) ROYAL BLUE, BLACK AND WHITE IS/ARE CLAIMED AS A FEATURE OF THE MARK.

THE COLOR BLUE APPEARS IN THE WORD LONGBOW AND IN THE DESIGN OF A BOW. THE COLOR WHITE APPEARS IN THE BACKGROUND AND IN THE BODY OF THE DESIGN OF THREE AIRPLANES. THE COLOR BLACK APPEARS IN THE AIRPLANE DESIGN, THE STREAM FOLLOWING THE AIRPLANE, AND THE WORDING THE AND GROUP, LLC.

FOR COMMERCIAL CONSULTANCY (U.S. CLS. 100, 101 AND 102).

FIRST USE 5-24-2006; IN COMMERCE 5-24-2006.
DAVID TAYLOR, EXAMINING ATTORNEY

CLASS 35—(Continued).

SN 77-183,821. RIDE AROUND STUDIOS, DELAND, FL.
FILED 5-17-2007.



NO CLAIM IS MADE TO THE EXCLUSIVE RIGHT TO USE "STUDIOS", APART FROM THE MARK AS SHOWN.

THE COLOR(S) BLACK IS/ARE CLAIMED AS A FEATURE OF THE MARK.

THE MARK CONSISTS OF A BLACK TRICYCLE WITH THE WORDS RIDE AROUND STUDIOS IN BLACK.

FOR BUSINESS CONSULTATION AND MANAGEMENT REGARDING MARKETING ACTIVITIES AND LAUNCHING OF NEW PRODUCTS (U.S. CLS. 100, 101 AND 102).

JENNIFER KRISP, EXAMINING ATTORNEY

SN 77-183,424. R+2 MARKETING, LLC, WESTPORT, CT.
FILED 5-17-2007.

TekTrakker

THE MARK CONSISTS OF STANDARD CHARACTERS WITHOUT CLAIM TO ANY PARTICULAR FONT, STYLE, SIZE, OR COLOR.

FOR PROVIDING CONSUMER INFORMATION, NAMELY QUALITY OF CUSTOMER SERVICE MEASUREMENT AND PRODUCT COMPARISON INFORMATION SERVICES IN THE FIELD OF COMPUTER HARDWARE AND SOFTWARE (U.S. CLS. 100, 101 AND 102).

BRIAN NEVILLE, EXAMINING ATTORNEY

SN 77-186,080. THE DEAL, LLC, NEW YORK, NY. FILED 5-21-2007.

VCDeal

THE MARK CONSISTS OF STANDARD CHARACTERS WITHOUT CLAIM TO ANY PARTICULAR FONT, STYLE, SIZE, OR COLOR.

OWNER OF U.S. REG. NOS. 2,422,734, 3,043,061 AND OTHERS.

FOR PROVIDING A WEBSITE FEATURING BUSINESS NEWS AND INFORMATION; PROVIDING ONLINE DATABASES FEATURING INFORMATION IN THE FIELD OF BUSINESS (U.S. CLS. 100, 101 AND 102).

FIRST USE 5-0-2003; IN COMMERCE 5-0-2003.
JILL C. ALT, EXAMINING ATTORNEY

CLASS 35—(Continued).

SN 77-186,801. RELIABILITY BRANDS, LLC, OSWEGO, IL. FILED 5-22-2007.

KEEP IT SAFE

THE MARK CONSISTS OF STANDARD CHARACTERS WITHOUT CLAIM TO ANY PARTICULAR FONT, STYLE, SIZE, OR COLOR.

FOR ADVISORY SERVICES RELATING TO BUSINESS MANAGEMENT AND BUSINESS OPERATIONS; ASSISTANCE IN MANAGEMENT OF BUSINESS ACTIVITIES; BUSINESS ADVISORY SERVICES, CONSULTANCY AND INFORMATION; BUSINESS CONSULTING SERVICES RELATING TO PRODUCT DISTRIBUTION, OPERATIONS MANAGEMENT SERVICES, LOGISTICS, REVERSE LOGISTICS, SUPPLY CHAIN, AND PRODUCTION SYSTEMS AND DISTRIBUTION SOLUTIONS; BUSINESS INFORMATION MANAGEMENT; BUSINESS MANAGEMENT ASSISTANCE TO INDUSTRIAL OR COMMERCIAL COMPANIES; BUSINESS RECORDS MANAGEMENT; COMMERCIAL AND INDUSTRIAL MANAGEMENT ASSISTANCE; COMMERCIAL ASSISTANCE IN BUSINESS MANAGEMENT; INVENTORY MANAGEMENT IN THE FIELD OF ADVANCED FLUID MANAGEMENT FROM BULK TO POINT OF USE.; LOGISTICS MANAGEMENT IN THE FIELD OF BEST PRACTICE FLUID IDENTIFICATION MANAGEMENT AND SYSTEMS.; MANAGEMENT AND OPERATION ASSISTANCE TO COMMERCIAL BUSINESSES; PRODUCT CONTAINMENT MANAGEMENT OF PARTS AND COMPONENTS FOR MANUFACTURERS AND SUPPLIERS (U.S. CLS. 100, 101 AND 102).
PETER CHENG, EXAMINING ATTORNEY

SN 77-186,891. MASTERCARD INTERNATIONAL INCORPORATED, PURCHASE, NY. FILED 5-22-2007.

MASTERCARD EXCLUSIVES

THE MARK CONSISTS OF STANDARD CHARACTERS WITHOUT CLAIM TO ANY PARTICULAR FONT, STYLE, SIZE, OR COLOR.

OWNER OF U.S. REG. NOS. 2,428,192, 2,428,346 AND 2,804,204.

FOR PROMOTING THE USE OF PAYMENT CARDS FOR THE GOODS AND SERVICES OF OTHERS THROUGH DISCOUNTS, PROMOTIONAL INCENTIVES, AND ELECTRONIC AND PRINTED COUPONS AND DISCOUNT OFFERS (U.S. CLS. 100, 101 AND 102).

FIRST USE 8-0-2006; IN COMMERCE 8-0-2006.

WOODROW HARTZOG, EXAMINING ATTORNEY

CLASS 35—(Continued).

SN 77-189,368. FRESH CHOICE SEAFOOD.COM, INC., NOKOMIS, FL. FILED 5-24-2007.

FRESH CHOICE SEAFOOD

THE MARK CONSISTS OF STANDARD CHARACTERS WITHOUT CLAIM TO ANY PARTICULAR FONT, STYLE, SIZE, OR COLOR.

NO CLAIM IS MADE TO THE EXCLUSIVE RIGHT TO USE "FRESH" AND "SEAFOOD", APART FROM THE MARK AS SHOWN.

FOR ONLINE RETAIL STORES FEATURING SEAFOOD (U.S. CLS. 100, 101 AND 102).

FIRST USE 10-17-2000; IN COMMERCE 1-31-2001.

MELVIN AXILBUND, EXAMINING ATTORNEY

SN 77-189,568. REDCATS USA, L.P., INDIANAPOLIS, IN. FILED 5-24-2007.

ONESTOPPLUS.COM REWARDS

THE MARK CONSISTS OF STANDARD CHARACTERS WITHOUT CLAIM TO ANY PARTICULAR FONT, STYLE, SIZE, OR COLOR.

NO CLAIM IS MADE TO THE EXCLUSIVE RIGHT TO USE "REWARDS", APART FROM THE MARK AS SHOWN.

FOR ON-LINE RETAIL STORE SERVICES FEATURING A BONUS INCENTIVE PROGRAM THROUGH USE OF CREDIT CARDS FOR CUSTOMERS IN THE FIELD OF MEN'S AND WOMEN'S CLOTHING, SHOES, AND ACCESSORIES; MAIL ORDER CATALOG SERVICES FEATURING A BONUS INCENTIVE PROGRAM THROUGH USE OF CREDIT CARDS FOR CUSTOMERS IN THE FIELD OF MEN'S AND WOMEN'S CLOTHING, SHOES, AND ACCESSORIES (U.S. CLS. 100, 101 AND 102).

THOMAS MANOR, EXAMINING ATTORNEY

SN 77-189,834. SUPPLY CHAIN COUNCIL, INC., WASHINGTON, DC. FILED 5-24-2007.

SCOR*mark*

OWNER OF U.S. REG. NO. 2,999,441.

THE COLOR(S) GREY AND BLUE IS/ARE CLAIMED AS A FEATURE OF THE MARK.

THE TERM SCOR IS IN GRAY AND THE TERM MARK IS IN BLUE.

FOR PROVIDING SUPPLY CHAIN DATA AND ANALYSIS TO BE USED AS A BENCHMARK FOR SUPPLY CHAIN ASSESSMENT AND MANAGEMENT (U.S. CLS. 100, 101 AND 102).

FIRST USE 3-19-2007; IN COMMERCE 3-19-2007.

BRIAN NEVILLE, EXAMINING ATTORNEY

CLASS 35—(Continued).

SN 77-192,190. BRIGHTHOUSE, LLC, ATLANTA, GA. FILED 5-29-2007.

BOTH

THE MARK CONSISTS OF STANDARD CHARACTERS WITHOUT CLAIM TO ANY PARTICULAR FONT, STYLE, SIZE, OR COLOR.

FOR PROVIDING OUTSOURCING SERVICES TO BUSINESSES (U.S. CLS. 100, 101 AND 102).
MICHELE SWAIN, EXAMINING ATTORNEY



SN 77-195,421. ULTRA CONCURRENT, INC., APTOS, CA. FILED 6-1-2007.

ONTOCONSTRAINT

THE MARK CONSISTS OF STANDARD CHARACTERS WITHOUT CLAIM TO ANY PARTICULAR FONT, STYLE, SIZE, OR COLOR.

FOR BUSINESS ADVICE AND COMMERCIAL INFORMATION; DISSEMINATION OF ADVERTISING FOR OTHERS VIA THE INTERNET; PROVIDING CONSUMER PRODUCT INFORMATION VIA THE INTERNET; COMPARISON SHOPPING SERVICES; PROVIDING ON-LINE DIRECTORY INFORMATION SERVICES ALSO FEATURING HYPERLINKS TO OTHER WEB SITES; ON-LINE ADVERTISING AND MARKETING SERVICES (U.S. CLS. 100, 101 AND 102).

KELLY BOULTON, EXAMINING ATTORNEY



SN 77-195,427. ULTRA CONCURRENT, INC., APTOS, CA. FILED 6-1-2007.

ONTODEPEND

THE MARK CONSISTS OF STANDARD CHARACTERS WITHOUT CLAIM TO ANY PARTICULAR FONT, STYLE, SIZE, OR COLOR.

FOR BUSINESS ADVICE AND COMMERCIAL INFORMATION; DISSEMINATION OF ADVERTISING FOR OTHERS VIA THE INTERNET; PROVIDING CONSUMER PRODUCT INFORMATION VIA THE INTERNET; COMPARISON SHOPPING SERVICES; PROVIDING ON-LINE DIRECTORY INFORMATION SERVICES ALSO FEATURING HYPERLINKS TO OTHER WEB SITES; ON-LINE ADVERTISING AND MARKETING SERVICES (U.S. CLS. 100, 101 AND 102).

KELLY BOULTON, EXAMINING ATTORNEY

CLASS 35—(Continued).

SN 77-195,435. ULTRA CONCURRENT, INC., APTOS, CA. FILED 6-1-2007.

ONTOGEN

THE MARK CONSISTS OF STANDARD CHARACTERS WITHOUT CLAIM TO ANY PARTICULAR FONT, STYLE, SIZE, OR COLOR.

FOR BUSINESS ADVICE AND COMMERCIAL INFORMATION; DISSEMINATION OF ADVERTISING FOR OTHERS VIA THE INTERNET; PROVIDING CONSUMER PRODUCT INFORMATION VIA THE INTERNET; COMPARISON SHOPPING SERVICES; PROVIDING ON-LINE DIRECTORY INFORMATION SERVICES ALSO FEATURING HYPERLINKS TO OTHER WEB SITES; ON-LINE ADVERTISING AND MARKETING SERVICES (U.S. CLS. 100, 101 AND 102).

KELLY BOULTON, EXAMINING ATTORNEY



SN 77-195,449. ULTRA CONCURRENT, INC., APTOS, CA. FILED 6-1-2007.

ONTOSCHEMA

THE MARK CONSISTS OF STANDARD CHARACTERS WITHOUT CLAIM TO ANY PARTICULAR FONT, STYLE, SIZE, OR COLOR.

FOR BUSINESS ADVICE AND COMMERCIAL INFORMATION; DISSEMINATION OF ADVERTISING FOR OTHERS VIA THE INTERNET; PROVIDING CONSUMER PRODUCT INFORMATION VIA THE INTERNET; COMPARISON SHOPPING SERVICES; PROVIDING ON-LINE DIRECTORY INFORMATION SERVICES ALSO FEATURING HYPERLINKS TO OTHER WEB SITES; ON-LINE ADVERTISING AND MARKETING SERVICES (U.S. CLS. 100, 101 AND 102).

KELLY BOULTON, EXAMINING ATTORNEY



SN 77-195,452. ULTRA CONCURRENT, INC., APTOS, CA. FILED 6-1-2007.

ONTOSPEC

THE MARK CONSISTS OF STANDARD CHARACTERS WITHOUT CLAIM TO ANY PARTICULAR FONT, STYLE, SIZE, OR COLOR.

FOR BUSINESS ADVICE AND COMMERCIAL INFORMATION; DISSEMINATION OF ADVERTISING FOR OTHERS VIA THE INTERNET; PROVIDING CONSUMER PRODUCT INFORMATION VIA THE INTERNET; COMPARISON SHOPPING SERVICES; PROVIDING ON-LINE DIRECTORY INFORMATION SERVICES ALSO FEATURING HYPERLINKS TO OTHER WEB SITES; ON-LINE ADVERTISING AND MARKETING SERVICES (U.S. CLS. 100, 101 AND 102).

KELLY BOULTON, EXAMINING ATTORNEY

CLASS 35—(Continued).

SN 77-195,852. WAL-MART STORES, INC., BENTONVILLE, AR. FILED 6-1-2007.

**IT'S A GREAT DAY TO SAVE
MONEY**

THE MARK CONSISTS OF STANDARD CHARACTERS WITHOUT CLAIM TO ANY PARTICULAR FONT, STYLE, SIZE, OR COLOR.

FOR RETAIL AND ONLINE RETAIL DEPARTMENT STORE SERVICES; RETAIL GROCERY STORE SERVICES (U.S. CLS. 100, 101 AND 102).
SCOTT SISUN, EXAMINING ATTORNEY

SN 77-197,028. PETLAND, INC., CHILLICOTHE, OH. FILED 6-4-2007.

PETLAND SUPERSTORE

THE MARK CONSISTS OF STANDARD CHARACTERS WITHOUT CLAIM TO ANY PARTICULAR FONT, STYLE, SIZE, OR COLOR.

OWNER OF U.S. REG. NOS. 1,060,290, 1,113,136 AND OTHERS.

NO CLAIM IS MADE TO THE EXCLUSIVE RIGHT TO USE "SUPERSTORE", APART FROM THE MARK AS SHOWN.

FOR RETAIL PET STORES; FRANCHISING, NAMELY, CONSULTATION AND ASSISTANCE IN BUSINESS MANAGEMENT, ORGANIZATION AND PROMOTION; FRANCHISING, NAMELY, OFFERING TECHNICAL ASSISTANCE IN THE ESTABLISHMENT AND/OR OPERATION OF A RETAIL PET BUSINESS; PROMOTION OF BUSINESS OPPORTUNITIES; BUSINESS INFORMATION SERVICES IN THE NATURE OF PROVIDING INFORMATION ON BUSINESS OPPORTUNITIES (U.S. CLS. 100, 101 AND 102).
ERIN FALK, EXAMINING ATTORNEY

SN 77-198,818. WAL-MART STORES, INC., BENTONVILLE, AR. FILED 6-6-2007.

**IT'S A GOOD DAY TO SAVE
MONEY**

THE MARK CONSISTS OF STANDARD CHARACTERS WITHOUT CLAIM TO ANY PARTICULAR FONT, STYLE, SIZE, OR COLOR.

FOR RETAIL AND ONLINE RETAIL DEPARTMENT STORE SERVICES; RETAIL GROCERY STORE SERVICES (U.S. CLS. 100, 101 AND 102).
SCOTT SISUN, EXAMINING ATTORNEY

CLASS 35—(Continued).

SN 77-205,724. PREVO'S FAMILY MARKETS, INC., GRAND RAPIDS, MI. FILED 6-14-2007.

CLOSER. FASTER. FRIENDLIER.

THE MARK CONSISTS OF STANDARD CHARACTERS WITHOUT CLAIM TO ANY PARTICULAR FONT, STYLE, SIZE, OR COLOR.

FOR SUPERMARKETS (U.S. CLS. 100, 101 AND 102).
FIRST USE 5-0-2005; IN COMMERCE 5-0-2005.
WON TEAK OH, EXAMINING ATTORNEY

SN 77-205,888. SANGIKYO CORPORATION, IKEBE-CHO TSUZUKI-KU, KANAGAWA, JAPAN, FILED 6-14-2007.

OLD THEORY

THE MARK CONSISTS OF STANDARD CHARACTERS WITHOUT CLAIM TO ANY PARTICULAR FONT, STYLE, SIZE, OR COLOR.

FOR BUSINESS MANAGEMENT AND ORGANIZATION CONSULTANCY; BUSINESS MANAGEMENT ASSISTANCE; BUSINESS MANAGEMENT PLANNING SERVICES; BUSINESS INFORMATION IN THE FIELD OF MANUFACTURING INDUSTRY AND BUSINESS SERVICES (U.S. CLS. 100, 101 AND 102).
EMILY CHUO, EXAMINING ATTORNEY

SN 77-209,306. PREVO'S FAMILY MARKETS, INC., GRAND RAPIDS, MI. FILED 6-19-2007.

FELPAUSCH

THE MARK CONSISTS OF STANDARD CHARACTERS WITHOUT CLAIM TO ANY PARTICULAR FONT, STYLE, SIZE, OR COLOR.

SEC. 2(F).
FOR SUPERMARKETS (U.S. CLS. 100, 101 AND 102).
FIRST USE 0-0-1933; IN COMMERCE 0-0-1933.
WON TEAK OH, EXAMINING ATTORNEY

CLASS 35—(Continued).

SN 77-211,664. LIFETIME ENTERTAINMENT SERVICES, NEW YORK, NY. FILED 6-21-2007.

CLASS 35—(Continued).

SN 77-212,206. BANK OF AMERICA CORPORATION, CHARLOTTE, NC. FILED 6-21-2007.

BE MY STRENGTH

OPPORTUNITY FOR RECOGNITION

THE MARK CONSISTS OF STANDARD CHARACTERS WITHOUT CLAIM TO ANY PARTICULAR FONT, STYLE, SIZE, OR COLOR.

FOR PROMOTING PUBLIC AWARENESS IN THE FIELD OF BREAST CANCER PREVENTION, DIAGNOSIS AND TREATMENT (U.S. CLS. 100, 101 AND 102).
JOHN DWYER, EXAMINING ATTORNEY

THE MARK CONSISTS OF STANDARD CHARACTERS WITHOUT CLAIM TO ANY PARTICULAR FONT, STYLE, SIZE, OR COLOR.

FOR EMPLOYMENT HIRING, RECRUITING, PLACEMENT, STAFFING AND CAREER NETWORKING SERVICES (U.S. CLS. 100, 101 AND 102).
TINA BROWN, EXAMINING ATTORNEY

SN 77-211,666. LIFETIME ENTERTAINMENT SERVICES, NEW YORK, NY. FILED 6-21-2007.

SN 77-212,213. BANK OF AMERICA CORPORATION, CHARLOTTE, NC. FILED 6-21-2007.

BE MY BRA

OPPORTUNITY FOR TEAMWORK

THE MARK CONSISTS OF STANDARD CHARACTERS WITHOUT CLAIM TO ANY PARTICULAR FONT, STYLE, SIZE, OR COLOR.

FOR PROMOTING PUBLIC AWARENESS IN THE FIELD OF BREAST CANCER PREVENTION, DIAGNOSIS AND TREATMENT (U.S. CLS. 100, 101 AND 102).
JOHN DWYER, EXAMINING ATTORNEY

THE MARK CONSISTS OF STANDARD CHARACTERS WITHOUT CLAIM TO ANY PARTICULAR FONT, STYLE, SIZE, OR COLOR.

FOR EMPLOYMENT HIRING, RECRUITING, PLACEMENT, STAFFING AND CAREER NETWORKING SERVICES (U.S. CLS. 100, 101 AND 102).
TINA BROWN, EXAMINING ATTORNEY

SN 77-212,203. BANK OF AMERICA CORPORATION, CHARLOTTE, NC. FILED 6-21-2007.

SN 77-214,870. DELAWARE CAPITAL FORMATION, INC., WILMINGTON, DE. FILED 6-25-2007.

OPPORTUNITY FOR LEADERSHIP



THE MARK CONSISTS OF STANDARD CHARACTERS WITHOUT CLAIM TO ANY PARTICULAR FONT, STYLE, SIZE, OR COLOR.

FOR EMPLOYMENT HIRING, RECRUITING, PLACEMENT, STAFFING AND CAREER NETWORKING SERVICES (U.S. CLS. 100, 101 AND 102).
TINA BROWN, EXAMINING ATTORNEY

OWNER OF U.S. REG. NOS. 2,015,109, 2,895,652 AND OTHERS.

THE MARK CONSISTS OF THREE BARS WITH TRIANGLES APPEARING INSIDE THE BARS ON THE LEFT SIDE OF THE WORD "CHIEF"

FOR CUSTOMER SERVICES IN THE FIELD OF VEHICLE REPAIR (U.S. CLS. 100, 101 AND 102).
FIRST USE 8-0-2005; IN COMMERCE 8-0-2005.
SUSAN LESLIE DUBOIS, EXAMINING ATTORNEY

CLASS 35—(Continued).

SN 77-221,636. DEUTSCHE TELEKOM AG, BONN, FED REP GERMANY, FILED 7-3-2007.

MDA mail

THE MARK CONSISTS OF STANDARD CHARACTERS WITHOUT CLAIM TO ANY PARTICULAR FONT, STYLE, SIZE, OR COLOR.

PRIORITY CLAIMED UNDER SEC. 44(D) ON FED REP GERMANY APPLICATION NO. 30701909838, FILED 1-9-2007, REG. NO. 30701909, DATED 2-22-2007, EXPIRES 1-31-2017.

OWNER OF U.S. REG. NOS. 2,930,993, 2,942,206 AND OTHERS.

NO CLAIM IS MADE TO THE EXCLUSIVE RIGHT TO USE "MAIL", APART FROM THE MARK AS SHOWN.

FOR TELEPHONE DIRECTORY ASSISTANCE SERVICES; ADVERTISING SERVICES, NAMELY, PREPARING AND PLACING ADVERTISEMENTS FOR OTHERS PROMOTING THE GOODS AND SERVICES OF OTHERS THROUGH PRINTED ADVERTISING, PRINTED DIRECTORIES, THROUGH ENCODED MEDIA, THROUGH THE DISSEMINATION OF PROMOTIONAL MATERIALS, THROUGH DIRECT MAIL ADVERTISING, THROUGH ELECTRONIC BILLBOARD ADVERTISING, PREPARING AUDIO-VISUAL PRESENTATIONS FOR USE IN ADVERTISING; BUSINESS MANAGEMENT SERVICES, NAMELY, BUSINESS APPRAISALS, BUSINESS AUDITING, PROVIDING BUSINESS INFORMATION, NAMELY, PREPARING BUSINESS REPORTS AND CONDUCTING BUSINESS RESEARCH, ANALYSIS AND SURVEYS, BUSINESS MANAGEMENT PLANNING, BUSINESS MANAGEMENT CONSULTATION, BUSINESS MANAGEMENT SUPERVISION, CONDUCTING BUSINESS NETWORKING FOR OTHERS; BUSINESS MANAGEMENT AND CONSULTING SERVICES, EXCLUDING AGRICULTURAL BUSINESS MANAGEMENT AND CONSULTING SERVICES; PROVIDING INFORMATION VIA THE TELEPHONE AND THE GLOBAL COMMUNICATION NETWORKS IN THE FIELD OF ADVERTISING AND BUSINESS MARKETING; PROFESSIONAL CONSULTANCY IN THE FIELD OF DATA PROCESSING; RENTAL OF AUTOMATIC VENDING MACHINES; RENTAL OF DATA PROCESSING EQUIPMENT; ORGANIZING JOB FAIRS (U.S. CLS. 100, 101 AND 102).

JENNIFER HETU, EXAMINING ATTORNEY

SN 77-226,971. WAL-MART STORES, INC., BENTONVILLE, AR. FILED 7-11-2007.

LIVE BETTER FOR LESS

THE MARK CONSISTS OF STANDARD CHARACTERS WITHOUT CLAIM TO ANY PARTICULAR FONT, STYLE, SIZE, OR COLOR.

FOR RETAIL STORE SERVICES FEATURING A WIDE VARIETY OF CONSUMER GOODS; ON-LINE RETAIL STORE SERVICES FEATURING A WIDE VARIETY OF CONSUMER GOODS; RETAIL GROCERY STORES (U.S. CLS. 100, 101 AND 102).

SCOTT SISUN, EXAMINING ATTORNEY

CLASS 35—(Continued).

SN 77-233,777. Z SPOKE, LLC, NEW YORK, NY. FILED 7-19-2007.

ZAC POSEN

THE MARK CONSISTS OF STANDARD CHARACTERS WITHOUT CLAIM TO ANY PARTICULAR FONT, STYLE, SIZE, OR COLOR.

OWNER OF U.S. REG. NO. 2,667,345.

THE NAME(S), PORTRAIT(S), AND/OR SIGNATURE(S) SHOWN IN THE MARK IDENTIFIES ZAC POSEN, WHOSE CONSENT(S) TO REGISTER IS MADE OF RECORD.

FOR RETAIL STORE SERVICES IN THE FIELD OF GENERAL MERCHANDISE, NAMELY, CLOTHING, FOOTWEAR, BAGS, JEWELRY, EYEWEAR, FRAGRANCES, COSMETICS AND TABLEWARE, NAMELY, PLATES, BOWLS AND WATER GLASSES (U.S. CLS. 100, 101 AND 102).

KATHERINE E. HALMEN, EXAMINING ATTORNEY

SN 78-231,155. JADE, ROCKFORD, MI. FILED 3-28-2003.

JADE

FOR RETAIL CLOTHING BOUTIQUE (U.S. CLS. 100, 101 AND 102).

FIRST USE 10-18-2002; IN COMMERCE 10-18-2002.

TRACY FLETCHER, EXAMINING ATTORNEY

SN 78-567,909. WASHINGTON, D.C. STYLE MAGAZINE, LLC, PHILADELPHIA, PA. FILED 2-15-2005.

DC STYLE CLUB

THE MARK CONSISTS OF STANDARD CHARACTERS WITHOUT CLAIM TO ANY PARTICULAR FONT, STYLE, SIZE, OR COLOR.

OWNER OF U.S. REG. NOS. 3,059,729 AND 3,061,352.

NO CLAIM IS MADE TO THE EXCLUSIVE RIGHT TO USE "DC" AND "CLUB", APART FROM THE MARK AS SHOWN.

FOR ADMINISTRATION OF A PROGRAM THAT ENABLES PARTICIPANTS TO ATTEND SPECIAL SOCIAL AND ENTERTAINMENT EVENTS; ADMINISTRATION OF A PROGRAM THAT ENABLES PARTICIPANTS TO OBTAIN DISCOUNTS ON GOODS AND SERVICES THROUGH THE USE OF A MEMBERSHIP CARD AT PARTICIPATING RETAILERS, RESTAURANTS, AND SERVICE PROVIDERS; AND ADMINISTRATION OF A PROGRAM THAT ENABLES PARTICIPANTS TO ACCESS ONLINE THE PICTURES TAKEN AT SOCIAL AND ENTERTAINMENT EVENTS (U.S. CLS. 100, 101 AND 102).

DEBRA LEE, EXAMINING ATTORNEY

CLASS 35—(Continued).

SN 78-567,918. WASHINGTON, D.C. STYLE MAGAZINE, LLC, PHILADELPHIA, PA. FILED 2-15-2005.

**WASHINGTON, D.C.
STYLE CLUB**

THE MARK CONSISTS OF STANDARD CHARACTERS WITHOUT CLAIM TO ANY PARTICULAR FONT, STYLE, SIZE, OR COLOR.

OWNER OF U.S. REG. NOS. 3,059,729 AND 3,061,352. NO CLAIM IS MADE TO THE EXCLUSIVE RIGHT TO USE "WASHINGTON DC" AND "CLUB", APART FROM THE MARK AS SHOWN.

FOR ADMINISTRATION OF A PROGRAM THAT ENABLES PARTICIPANTS TO ATTEND SPECIAL SOCIAL AND ENTERTAINMENT EVENTS; ADMINISTRATION OF A PROGRAM THAT ENABLES PARTICIPANTS TO OBTAIN DISCOUNTS ON GOODS AND SERVICES THROUGH THE USE OF A MEMBERSHIP CARD AT PARTICIPATING RETAILERS, RESTAURANTS, AND SERVICE PROVIDERS; AND ADMINISTRATION OF A PROGRAM THAT ENABLES PARTICIPANTS TO ACCESS ONLINE THE PICTURES TAKEN AT SOCIAL AND ENTERTAINMENT EVENTS (U.S. CLS. 100, 101 AND 102).

DEBRA LEE, EXAMINING ATTORNEY

CLASS 35—(Continued).

SN 78-673,702. COPERNIO HOLDING COMPANY, HUNTINGTON BEACH, CA. FILED 7-19-2005.

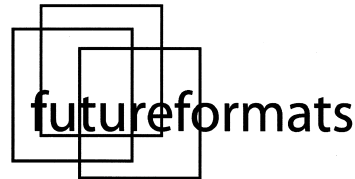

THE MARK CONSISTS OF THREE OVERLAPPING BOXES WITH THE WORDS FUTURE FORMATS SUPERIMPOSED ON TOP, EXTENDING BEYOND THIRD BOX.

FOR ASSISTANCE, ADVISORY SERVICES AND CONSULTANCY WITH REGARD TO BUSINESS PLANNING, BUSINESS ANALYSIS, BUSINESS MANAGEMENT, AND BUSINESS ORGANIZATION (U.S. CLS. 100, 101 AND 102).

FIRST USE 12-26-2003; IN COMMERCE 12-26-2003. MICHAEL WEBSTER, EXAMINING ATTORNEY

SN 78-646,714. AMAZON TECHNOLOGIES, INC., RENO, NV. FILED 6-8-2005.



THE COLOR(S) YELLOW, BLUE, AND WHITE IS/ARE CLAIMED AS A FEATURE OF THE MARK.

THE MARK CONSISTS OF A YELLOW HORIZONTAL BAR WITH A SHOPPING CART IN A BLUE CIRCLE WITH A WHITE TRIM INSERTED IN THE LEFT SIDE OF THE BAR.

FOR HOUSE MARK FOR COMPUTERIZED ONLINE ORDERING SERVICES IN RETAIL AND WHOLESALE DISTRIBUTION OF GENERAL MERCHANDISE AND GENERAL CONSUMER GOODS (U.S. CLS. 100, 101 AND 102).

FIRST USE 2-2-2005; IN COMMERCE 2-2-2005. ANNE FARRELL, EXAMINING ATTORNEY

SN 78-674,597. RUSSIANTOWN, INC., NORCROSS, GA. FILED 7-20-2005.

RussianTown

THE MARK CONSISTS OF STANDARD CHARACTERS WITHOUT CLAIM TO ANY PARTICULAR FONT, STYLE, SIZE, OR COLOR.

FOR MARKETING AND ADVERTISING FOR OTHER BUSINESSES (U.S. CLS. 100, 101 AND 102).

FIRST USE 4-5-2003; IN COMMERCE 6-25-2004. GEOFFREY FOSDICK, EXAMINING ATTORNEY

CLASS 35—(Continued).

SN 78-705,766. BRAIN WAREHOUSE LLC, SAN DIEGO, CA.
FILED 9-1-2005.

CAREERMATCH

THE MARK CONSISTS OF STANDARD CHARACTERS WITHOUT CLAIM TO ANY PARTICULAR FONT, STYLE, SIZE, OR COLOR.

FOR ADVERTISING AGENCIES, NAMELY, PROMOTING THE GOODS AND SERVICES OF OTHERS; ADVERTISING, MARKETING AND PROMOTION SERVICES; DISSEMINATION OF ADVERTISING FOR OTHERS VIA THE INTERNET; MARKETING SERVICES, NAMELY PROVIDING INFORMATIONAL WEB PAGES DESIGNED TO GENERATE SALES TRAFFIC VIA HYPERLINKS TO OTHER WEB SITES; ON-LINE ADVERTISING ON COMPUTER COMMUNICATION NETWORKS; PROMOTING THE GOODS AND SERVICES OF OTHERS THROUGH SEARCH ENGINE REFERRAL TRAFFIC ANALYSIS AND REPORTING; PROVIDING INFORMATION ABOUT THE GOODS AND SERVICES OF OTHERS VIA THE GLOBAL COMPUTER NETWORK; PROVIDING ON-LINE DIRECTORY INFORMATION SERVICES ALSO FEATURING HYPERLINKS TO OTHER WEB SITES (U.S. CLS. 100, 101 AND 102).

FIRST USE 9-1-2005; IN COMMERCE 9-1-2005.
JAMES STEIN, EXAMINING ATTORNEY

SN 78-709,711. DAYTONA BEACH STREET RODS, DAYTONA BEACH, FL. FILED 9-9-2005.

Turkey Run

THE MARK CONSISTS OF STANDARD CHARACTERS WITHOUT CLAIM TO ANY PARTICULAR FONT, STYLE, SIZE, OR COLOR.

FOR PROMOTING AND CONDUCTING TRADE SHOWS IN THE FIELD OF AUTOMOTIVE (U.S. CLS. 100, 101 AND 102).

FIRST USE 11-1-1995; IN COMMERCE 11-1-1995.
FLORENTINA BLANDU, EXAMINING ATTORNEY

CLASS 35—(Continued).

SN 78-711,110. THOMSON, DAVID G., OVERLAND PARK, KS. FILED 9-12-2005.

ESSENTIALS TRIANGLE

THE MARK CONSISTS OF STANDARD CHARACTERS WITHOUT CLAIM TO ANY PARTICULAR FONT, STYLE, SIZE, OR COLOR.

NO CLAIM IS MADE TO THE EXCLUSIVE RIGHT TO USE "TRIANGLE", APART FROM THE MARK AS SHOWN. FOR BUSINESS CONSULTING SERVICES, NAMELY, PROVIDING REVENUE GROWTH AND GENERATION ADVICE AND COUNSEL (U.S. CLS. 100, 101 AND 102).
KATHERINE STOIDES, EXAMINING ATTORNEY

SN 78-741,738. GLOBAL MOBILITY PRODUCTS INC., BURLINGTON, CANADA, FILED 10-27-2005.



PRIORITY CLAIMED UNDER SEC. 44(D) ON CANADA APPLICATION NO. 1256158, FILED 5-2-2005, REG. NO. TMA690492, DATED 6-21-2007, EXPIRES 6-21-2022.

FOR RETAIL STORE SERVICES FEATURING WIRELESS PRODUCTS, NAMELY CELL PHONES, CORDED AND CORDLESS PHONES, FRS RADIOS, PORTABLE CD PLAYERS, DVD PLAYERS AND PORTABLE RADIOS (U.S. CLS. 100, 101 AND 102).

JUSTINE D. PARKER, EXAMINING ATTORNEY

SN 78-760,898. HARBOR RESEARCH INC., BOSTON, MA. FILED 11-25-2005.

SmartSphere

THE MARK CONSISTS OF STANDARD CHARACTERS WITHOUT CLAIM TO ANY PARTICULAR FONT, STYLE, SIZE, OR COLOR.

FOR BUSINESS CONSULTING (U.S. CLS. 100, 101 AND 102).

FIRST USE 6-1-2004; IN COMMERCE 6-1-2004.
ANDREA BUTLER, EXAMINING ATTORNEY

CLASS 35—(Continued).

SN 78-770,433. GEORGIA WILDLIFE FEDERATION, INC., COVINGTON, GA. FILED 12-9-2005.



NO CLAIM IS MADE TO THE EXCLUSIVE RIGHT TO USE "FEDERATION", APART FROM THE MARK AS SHOWN.

THE MARK CONSISTS OF A CIRCLE WITH THE TOP PORTION OF THE CIRCLE BEING FORMED BY THE WORDING "GEORGIA WILDLIFE FEDERATION" AND THE BOTTOM PORTION OF THE CIRCLE BEING FORMED BY A SOLID LINE HAVING THE STYLIZED GRAPHIC REPRESENTATION OF A BUCK, A FOX AND FISH CONTAINED WITHIN THE CIRCLE.

SEC. 2(F) AS TO GEORGIA WILDLIFE FEDERATION. FOR WILDLIFE CONSERVATIONS SERVICES, NAMELY, PROMOTING PUBLIC AWARENESS OF THE NEED FOR WILDLIFE AND HABITAT PROTECTION (U.S. CLS. 100, 101 AND 102).

FIRST USE 0-0-1999; IN COMMERCE 0-0-1999.
WENDY GOODMAN, EXAMINING ATTORNEY

SN 78-782,717. SEARCH INSTITUTE, MINNEAPOLIS, MN. FILED 12-29-2005.

MVParents

THE MARK CONSISTS OF STANDARD CHARACTERS WITHOUT CLAIM TO ANY PARTICULAR FONT, STYLE, SIZE, OR COLOR.

FOR ONLINE RETAIL STORE SERVICES FEATURING EDUCATIONAL MATERIALS ABOUT PARENTING, NAMELY, PARENTING BOOKS, PAMPHLETS, SOFTWARE, MULTIMEDIA PRODUCTS AND RELATED MATERIALS, NAMELY, POSTERS, BUTTONS AND STICKERS (U.S. CLS. 100, 101 AND 102).

FIRST USE 6-29-2005; IN COMMERCE 6-29-2005.
ALEX KEAM, EXAMINING ATTORNEY

CLASS 35—(Continued).

SN 78-812,377. HARRAH, WILLIAM B., CLIFTON, VA. FILED 2-10-2006.

Wolf Run Studio

THE MARK CONSISTS OF STANDARD CHARACTERS WITHOUT CLAIM TO ANY PARTICULAR FONT, STYLE, SIZE, OR COLOR.

NO CLAIM IS MADE TO THE EXCLUSIVE RIGHT TO USE "STUDIO", APART FROM THE MARK AS SHOWN.

FOR ART GALLERIES; RETAIL STORE SERVICES IN THE FIELD OF ART PRINTS AND PICTURES (U.S. CLS. 100, 101 AND 102).

FIRST USE 1-1-1993; IN COMMERCE 1-1-1993.
DAVID H. STINE, EXAMINING ATTORNEY

SN 78-834,840. ARBITRON INC., COLUMBIA, MD. FILED 3-10-2006.

NEXT GENERATION ELECTRONIC RATINGS

THE MARK CONSISTS OF STANDARD CHARACTERS WITHOUT CLAIM TO ANY PARTICULAR FONT, STYLE, SIZE, OR COLOR.

NO CLAIM IS MADE TO THE EXCLUSIVE RIGHT TO USE "ELECTRONIC RATINGS", APART FROM THE MARK AS SHOWN.

FOR CONDUCTING AUDIENCE MEASUREMENT SURVEYS, MEDIA EXPOSURE MEASUREMENT SURVEYS, ADVERTISING EFFECTIVENESS AND ADVERTISEMENT PLACEMENT SURVEYS; BUSINESS RESEARCH AND MARKET RESEARCH; MARKET RESEARCH SERVICES REGARDING AUDIENCE MEASUREMENT AND MEDIA EXPOSURE MEASUREMENT; ADVERTISING EFFECTIVENESS AND ADVERTISEMENT PLACEMENT RESEARCH; PROVIDING BUSINESS RESEARCH AND MARKET RESEARCH INFORMATION TO CUSTOMERS (U.S. CLS. 100, 101 AND 102).

SHANNON TWOHIG, EXAMINING ATTORNEY

CLASS 35—(Continued).

SN 78-859,021. BARB INC., DBA STAGED HOMES, CONCORD, CA. FILED 4-11-2006.



THE MARK CONSISTS OF THE LETTERS ASP WITHIN A STYLIZED HOUSE DESIGN.

FOR ASSOCIATION SERVICES, NAMELY, PROMOTING THE INTERESTS OF MEMBERS AND OTHERS IN THE FIELD OF HOME RENOVATION, DESIGN AND DECORATION (U.S. CLS. 100, 101 AND 102).

FIRST USE 1-31-2000; IN COMMERCE 1-31-2000.
ELLEN B. AWRICH, EXAMINING ATTORNEY

SN 78-910,742. FULL HOUSE BRANDS LLC, CINCINNATI, OH. FILED 6-17-2006.

Full House

THE MARK CONSISTS OF STANDARD CHARACTERS WITHOUT CLAIM TO ANY PARTICULAR FONT, STYLE, SIZE, OR COLOR.

FOR RETAIL STORE SERVICES FEATURING APPAREL AND GAMING AND NOVELTY ITEMS. (U.S. CLS. 100, 101 AND 102).

CHRISTOPHER OTT, EXAMINING ATTORNEY

SN 78-921,115. GENERAL HOLDINGS, LLC, WINNSBORO, SC. FILED 6-30-2006.

POPS

THE MARK CONSISTS OF STANDARD CHARACTERS WITHOUT CLAIM TO ANY PARTICULAR FONT, STYLE, SIZE, OR COLOR.

FOR RETAIL STORE SERVICES FEATURING PETROLEUM PRODUCTS, CONVENIENCE STORE ITEMS, FOOD AND BEVERAGES (U.S. CLS. 100, 101 AND 102).

FIRST USE 11-30-2004; IN COMMERCE 11-30-2005.
LAURIE MAYES, EXAMINING ATTORNEY

CLASS 35—(Continued).

SN 78-931,608. HEALTHCARE BRANDING GROUP, INC., CHICAGO, IL. FILED 7-18-2006.

HEALTHCARE BRANDING GROUP

THE MARK CONSISTS OF STANDARD CHARACTERS WITHOUT CLAIM TO ANY PARTICULAR FONT, STYLE, SIZE, OR COLOR.

NO CLAIM IS MADE TO THE EXCLUSIVE RIGHT TO USE "GROUP", APART FROM THE MARK AS SHOWN. SEC. 2(F).

FOR BUSINESS SERVICES, NAMELY, BRAND CREATION, BRAND SELECTION, AND BRAND STRATEGY CONSULTING FOR OTHERS; BRAND DEVELOPMENT FOR OTHERS; PRODUCT AND SERVICES DEVELOPMENT FOR OTHERS; BUSINESS DEVELOPMENT AND SALES STRATEGY SERVICES FOR OTHERS; ADVERTISING SERVICES; MARKETING CONSULTING AND MARKETING IMPLEMENTATION FOR OTHERS; OBTAINING AND INTERPRETING BUSINESS INTELLIGENCE FOR OTHERS; AND BUSINESS MODEL DEVELOPMENT FOR OTHERS (U.S. CLS. 100, 101 AND 102).

FIRST USE 12-31-2001; IN COMMERCE 12-31-2001.
REGINA DRUMMOND, EXAMINING ATTORNEY

SN 78-938,063. GEORGIA POWER COMPANY, ATLANTA, GA. FILED 7-26-2006.

FLATBILL SELECT

THE MARK CONSISTS OF STANDARD CHARACTERS WITHOUT CLAIM TO ANY PARTICULAR FONT, STYLE, SIZE, OR COLOR.

OWNER OF U.S. REG. NO. 2,568,593.

SEC. 2(F) "FLATBILL".

FOR INVOICING SERVICES (U.S. CLS. 100, 101 AND 102).

FIRST USE 6-1-2006; IN COMMERCE 6-1-2006.
PAULA MAYS, EXAMINING ATTORNEY

SN 78-938,487. HUPMAN, ELIZABETH, LEANDER, TX. FILED 7-26-2006.

pgpsale

THE MARK CONSISTS OF STANDARD CHARACTERS WITHOUT CLAIM TO ANY PARTICULAR FONT, STYLE, SIZE, OR COLOR.

FOR ONLINE CONSIGNMENT SERVICES WHEREBY GOODS ARE RECEIVED ON CONSIGNMENT FOR AUCTION ON AN ONLINE AUCTION SITE (U.S. CLS. 100, 101 AND 102).

JIM RINGLE, EXAMINING ATTORNEY

CLASS 35—(Continued).

SN 78-940,965. HEALTHTRAN, LLC, GREENWOOD VIL-
LAGE, CO. FILED 7-31-2006.

SCRIPTREWARDS

THE MARK CONSISTS OF STANDARD CHARACTERS
WITHOUT CLAIM TO ANY PARTICULAR FONT, STYLE,
SIZE, OR COLOR.

FOR CUSTOMER INCENTIVE PROGRAMS TO PRO-
MOTE CUSTOMER LOYALTY AND THE SALE OF
PRODUCTS AND SERVICES OF OTHERS, WHICH
PROVIDE MEMBERS AND CUSTOMERS WITH BENE-
FITS FOR COST SAVING CHOICES ON PRESCRIPTION
PRODUCTS (U.S. CLS. 100, 101 AND 102).

LYDIA BELZER, EXAMINING ATTORNEY

SN 78-942,106. EAGLE/MARK IV EQUIPMENT & LEASING
INC., MANSFIELD, OH. FILED 8-1-2006.

THE YARD TRUCK SPECIALIST

THE MARK CONSISTS OF STANDARD CHARACTERS
WITHOUT CLAIM TO ANY PARTICULAR FONT, STYLE,
SIZE, OR COLOR.

NO CLAIM IS MADE TO THE EXCLUSIVE RIGHT TO
USE "YARD TRUCK", APART FROM THE MARK AS
SHOWN.

SEC. 2(F).

FOR DEALERSHIPS IN THE FIELD OF YARD
TRUCKS AND PARTS THEREFORE (U.S. CLS. 100, 101
AND 102).

FIRST USE 5-5-1985; IN COMMERCE 5-5-1985.

WILLIAM P. SHANAHAN, EXAMINING ATTORNEY

SN 78-944,528. KELLY PAPER COMPANY, CITY OF IN-
DUSTRY, CA. FILED 8-3-2006.

KELLY PAPER

THE MARK CONSISTS OF STANDARD CHARACTERS
WITHOUT CLAIM TO ANY PARTICULAR FONT, STYLE,
SIZE, OR COLOR.

OWNER OF U.S. REG. NO. 1,508,670.

NO CLAIM IS MADE TO THE EXCLUSIVE RIGHT TO
USE "PAPER", APART FROM THE MARK AS SHOWN.

FOR ON-LINE RETAIL STORE SERVICES, RETAIL
AND WHOLESALE DISTRIBUTORSHIP SERVICES, AND
RETAIL STORE SERVICES IN THE FIELDS OF PAPER,
PACKAGING, OFFICE SUPPLIES, SCREENPRINTING,
JANITORIAL AND INDUSTRIAL SUPPLIES (U.S. CLS.
100, 101 AND 102).

FIRST USE 0-0-1938; IN COMMERCE 0-0-1938.

KENNETH E. SHARPERSON, EXAMINING ATTORNEY

CLASS 35—(Continued).

SN 78-945,168. RETAIL INVESTMENTS, LLC, NORTH CON-
WAY, NH. FILED 8-4-2006.

**you pick the
adventure...we make it
happen.**

THE MARK CONSISTS OF STANDARD CHARACTERS
WITHOUT CLAIM TO ANY PARTICULAR FONT, STYLE,
SIZE, OR COLOR.

FOR ADVERTISING SERVICES (U.S. CLS. 100, 101
AND 102).

SETH A. RAPPAPORT, EXAMINING ATTORNEY

SN 78-948,033. J.B.K. GROUP, INC., DBA EVENT SOURCE,
CLEVELAND, OH. FILED 8-9-2006.

EVENT SOURCE

THE MARK CONSISTS OF STANDARD CHARACTERS
WITHOUT CLAIM TO ANY PARTICULAR FONT, STYLE,
SIZE, OR COLOR.

FOR RETAIL STORE SERVICES FEATURING USED
TENTS, TABLES, CHAIRS, LINENS, AND DISHES FOR
NON-COMMERCIAL USE BY OTHERS NOT PROVID-
ING PRODUCTS OR SERVICES FOR EVENTS IN THE
NATURE OF MEETINGS, CONVENTIONS, AND SPE-
CIAL EVENTS (U.S. CLS. 100, 101 AND 102).

FIRST USE 5-0-1997; IN COMMERCE 5-0-1997.

MARK PILARO, EXAMINING ATTORNEY

SN 78-948,284. ABBOTT OF ENGLAND 1981 LIMITED,
TORONTO, CANADA, FILED 8-9-2006.

WE BRING THE WORLD HOME

THE MARK CONSISTS OF STANDARD CHARACTERS
WITHOUT CLAIM TO ANY PARTICULAR FONT, STYLE,
SIZE, OR COLOR.

PRIORITY CLAIMED UNDER SEC. 44(D) ON CANADA
APPLICATION NO. 1294224, FILED 3-17-2006, REG. NO.
TMA692,377, DATED 7-19-2007, EXPIRES 7-19-2022.

NO CLAIM IS MADE TO THE EXCLUSIVE RIGHT TO
USE "HOME", APART FROM THE MARK AS SHOWN.

FOR BUSINESS MANAGEMENT SERVICES,
NAMELY, OPERATING RETAIL, WHOLESALE AND
COMPUTERIZED ON-LINE RETAIL STORES FEATUR-
ING GIFTWARE, HOUSEWARES AND DECORATIVE
ITEMS FOR THE HOME AND GARDEN (U.S. CLS. 100,
101 AND 102).

EDWARD NELSON, EXAMINING ATTORNEY

CLASS 35—(Continued).

SN 78-949,577. HONG KONG TRADE DEVELOPMENT COUNCIL, WANCHAI, HONG KONG, FILED 8-10-2006.

CLASS 35—(Continued).

SN 78-950,381. CHALDEAN AMERICAN LADIES OF CHARITY, SOUTHFIELD, MI. FILED 8-11-2006.



The logo for 'Premier CONNECT' features the word 'Premier' in a large, elegant, cursive script font. Below it, the word 'CONNECT' is written in a smaller, bold, sans-serif, all-caps font.

CHALDEAN AMERICAN LADIES
OF CHARITY

NO CLAIM IS MADE TO THE EXCLUSIVE RIGHT TO USE "PREMIER CONNECT", APART FROM THE MARK AS SHOWN.

FOR ADVERTISING AND MARKETING; PROMOTIONAL SERVICES, NAMELY, DEVELOPING PROMOTIONAL CAMPAIGNS FOR BUSINESS; DISPLAY SERVICES FOR MERCHANDISE, TRADE FAIRS AND EXHIBITIONS, NAMELY, BUSINESS MERCHANDISING DISPLAY SERVICES; DEMONSTRATION OR DISPLAY OF GOODS FOR PROMOTIONAL PURPOSES; DISSEMINATION OF ADVERTISING MATERIALS; PROVISION OF BUSINESS AND TRADE INFORMATION; BUSINESS MANAGEMENT; BUSINESS ADMINISTRATION; AGENCY SERVICES FOR ARRANGING BUSINESS INTRODUCTION, NAMELY, ARRANGING BUSINESS INTRODUCTIONS VIA BUSINESS NETWORKING AND INTRODUCTION EVENTS; AGENCY SERVICES FOR ORGANIZING BUSINESS VISITS TO INTERNATIONAL MARKETS, NAMELY, PROVIDING BUSINESS AND COMMERCIAL INFORMATION IN THE FIELD OF BUSINESS TRAVEL MANAGEMENT AND THE BUSINESS TRAVEL INDUSTRY; BUSINESS APPRAISAL; BUSINESS MANAGEMENT ASSISTANCE; BUSINESS MANAGEMENT CONSULTANCY; BUSINESS INQUIRIES; BUSINESS INFORMATION; BUSINESS INVESTIGATIONS; BUSINESS ORGANIZATION CONSULTANCY; BUSINESS RESEARCH; COMMERCIAL INFORMATION AGENCIES; COMPILATION OF INFORMATION INTO COMPUTER DATABASES; COMMERCIAL AND INDUSTRIAL MANAGEMENT ASSISTANCE; COMPUTERIZED FILE MANAGEMENT; PUBLIC RELATIONS SERVICES; PUBLICATION OF PUBLICITY TEXTS; PUBLICITY SERVICES; PUBLICITY AGENCIES; SALES PROMOTION FOR OTHERS; PROVIDING STATISTICAL INFORMATION FOR BUSINESS PURPOSES; SYSTEMIZATION OF INFORMATION INTO COMPUTER DATABASES; PROVIDING TELEVISION ADVERTISING FOR OTHERS; PRODUCTION OF TELEVISION COMMERCIALS; DIRECT MAIL ADVERTISING; ECONOMIC FORECASTING; ORGANIZATION OF EXHIBITION FOR COMMERCIAL OR ADVERTISING PURPOSES; CONDUCTING MARKETING STUDIES AND RESEARCH; ORGANIZATION OF TRADE FAIRS FOR COMMERCIAL OR ADVERTISING PURPOSES; PROVISION OF INFORMATION RELATING TO BUSINESS AND TRADE THROUGH A GLOBAL COMPUTER INFORMATION NETWORK; CUSTOMIZED BUSINESS MATCHING SERVICES, NAMELY, MATCHING POTENTIAL BUSINESS PARTNERS TO CLIENTS' BUSINESS NEEDS (U.S. CLS. 100, 101 AND 102).

MATTHEW MCDOWELL, EXAMINING ATTORNEY

THE MARK CONSISTS OF STANDARD CHARACTERS WITHOUT CLAIM TO ANY PARTICULAR FONT, STYLE, SIZE, OR COLOR.

NO CLAIM IS MADE TO THE EXCLUSIVE RIGHT TO USE "CHARITY", APART FROM THE MARK AS SHOWN. SEC. 2(F).

FOR CHARITABLE SERVICES, NAMELY, SETTLEMENT SERVICES IN THE FIELD OF PROVIDING COORDINATION OF THE PROCUREMENT AND DISTRIBUTION OF FOOD DONATIONS FROM MANUFACTURERS, WHOLESALERS, RETAILERS, GOVERNMENT AGENCIES AND INDIVIDUALS TO ORGANIZATIONS PROVIDING FREE FOOD TO NEEDY PEOPLE, COORDINATION OF THE PROCUREMENT AND DISTRIBUTION OF FURNITURE FROM MANUFACTURERS, WHOLESALERS, RETAILERS, GOVERNMENT AGENCIES AND INDIVIDUALS TO NEEDY PEOPLE, COORDINATION OF THE PROCUREMENT AND DISTRIBUTION OF CLOTHING TO NEEDY PEOPLE; ORGANIZING AND CONDUCTING VOLUNTEER PROGRAMS AND COMMUNITY SERVICE PROJECTS IN THE FIELD OF DRUG PREVENTION FOR YOUTHS, CARE TO THE ELDERLY, AND MAINTENANCE OF THE CHALDEAN CULTURE WITHIN THE COMMUNITY; AND BUSINESS NETWORKING IN THE FIELD OF ORGANIZING EFFORTS TO SUPPORT AND EXPAND THE MEMBERSHIP BASE (U.S. CLS. 100, 101 AND 102).

FIRST USE 6-1-1961; IN COMMERCE 6-1-2001.
HENRY S. ZAK, EXAMINING ATTORNEY

CLASS 35—(Continued).

SN 78-956,911. VENDORXPRESS LLC, TROY, MI. FILED 8-21-2006.

VendorXpress

THE MARK CONSISTS OF STANDARD CHARACTERS WITHOUT CLAIM TO ANY PARTICULAR FONT, STYLE, SIZE, OR COLOR.

FOR BUSINESS IDENTIFICATION SERVICES, NAMELY, CREDENTIALING OF SALES REPS AND THIRD PARTY INVITEES; ONSITE BUSINESS MANAGEMENT OF INVITEES; APPOINTMENT SCHEDULING SERVICES FOR THIRD PARTY VENDOR INVITEES; ASSISTANCE IN MANAGEMENT OF BUSINESS ACTIVITIES; ADVISORY SERVICES RELATING TO BUSINESS MANAGEMENT AND BUSINESS OPERATIONS; BUSINESS ADMINISTRATION AND MANAGEMENT; BUSINESS CONSULTING, MANAGEMENT, PLANNING AND SUPERVISION; BUSINESS EVALUATION OF SALES REPS AND OTHER THIRD PARTY INVITEES; BUSINESS MANAGEMENT; DEVELOPMENT OF HOSPITAL MANAGEMENT SYSTEMS; EXPERT EVALUATIONS AND REPORTS RELATING TO BUSINESS MATTERS; HOSPITAL ADMINISTRATION SERVICES; INFORMATION SERVICES RELATING TO BUSINESS MATTERS; MANAGEMENT AND COMPILATION OF COMPUTERISED DATABASES; PROVIDING INFORMATION IN THE FIELD OF TIME MANAGEMENT FOR BUSINESS PURPOSES; PROVIDING STATISTICAL INFORMATION RELATING VENDORS AND SALES PERSONNEL (U.S. CLS. 100, 101 AND 102).

TASHIA BUNCH, EXAMINING ATTORNEY

CLASS 35—(Continued).

SN 78-958,641. THE GALE GROUP, INC., FARMINGTON HILLS, MI. FILED 8-23-2006.

TABLEBASE

THE MARK CONSISTS OF STANDARD CHARACTERS WITHOUT CLAIM TO ANY PARTICULAR FONT, STYLE, SIZE, OR COLOR.

FOR PROVIDING GLOBAL BUSINESS AND CONSUMER INFORMATION IN THE NATURE OF CAPACITY, CAPITAL EXPENDITURES, CONSUMPTION, EXPORTS & IMPORTS, FORECASTS, HEALTH STATISTICS, INDUSTRY-WIDE OR MULTIPLE-COMPANY SALES, MARKET SHARE, MARKET SIZE, NUMBER OF OUTLETS, NUMBER OF USERS & SUBSCRIBERS, OUTPUT & PRODUCTION, RESEARCH & DEVELOPMENT EXPENDITURES, RANKINGS, AND SHIPMENTS IN TABULAR FORM VIA A GLOBAL COMPUTER NETWORK AND FACSIMILE (U.S. CLS. 100, 101 AND 102).

FIRST USE 2-1-1998; IN COMMERCE 2-1-1998.
JULIE GUTTADAURO, EXAMINING ATTORNEY

SN 78-959,580. NATIONAL FOOTBALL LEAGUE PLAYERS, INC, WASHINGTON, DC. FILED 8-24-2006.

SN 78-957,254. PALIK, DAVID ANDREW, BROKEN ARROW, OK. FILED 8-22-2006.

THE ROCKIN HOUSETOUR

THE MARK CONSISTS OF STANDARD CHARACTERS WITHOUT CLAIM TO ANY PARTICULAR FONT, STYLE, SIZE, OR COLOR.

FOR BUSINESS DEVELOPMENT SERVICES, NAMELY, PROVIDING START-UP SUPPORT FOR BUSINESSES OF OTHERS (U.S. CLS. 100, 101 AND 102).

JAMES LOVELACE, EXAMINING ATTORNEY



OWNER OF U.S. REG. NO. 1,931,367.

FOR ASSOCIATION SERVICES, NAMELY TO REPRESENT AND PROMOTE THE INTERESTS OF THE NATIONAL FOOTBALL LEAGUE PLAYERS (U.S. CLS. 100, 101 AND 102).

FIRST USE 12-31-2005; IN COMMERCE 12-31-2005.
DAVID ELTON, EXAMINING ATTORNEY

CLASS 35—(Continued).

SN 78-960,144. AMERICAN MINT, LLC, MECHANICSBURG, PA. FILED 8-24-2006.

AMERICAN MINT

THE MARK CONSISTS OF STANDARD CHARACTERS WITHOUT CLAIM TO ANY PARTICULAR FONT, STYLE, SIZE, OR COLOR.

SEC. 2(F).

FOR MAIL ORDER CATALOG SERVICES AND COMPUTERIZED ONLINE RETAIL STORE SERVICES IN THE FIELD OF JEWELRY, WATCHES, COMMEMORATIVE MONETARY AND NON-MONETARY COINS AND COIN SETS, COLLECTIBLE COINS, KNIVES, MEDALS, MEDALLIONS, BADGES, PLUSH BEARS, DOLLS, HOME DECOR, DIE CAST MODEL VEHICLES; ARRANGING AND CONDUCTING TRADE SHOW EXHIBITIONS IN THE FIELD OF COLLECTIBLE ITEMS, NAMELY, JEWELRY, WATCHES, COMMEMORATIVE MONETARY AND NON-MONETARY COINS AND COIN SETS, COLLECTIBLE COINS, KNIVES, MEDALS, MEDALLIONS, BADGES, PLUSH BEARS, DOLLS, HOME DECOR, DIE CAST MODEL VEHICLES (U.S. CLS. 100, 101 AND 102).

FIRST USE 2-24-1998; IN COMMERCE 2-24-1998.
ADA HAN, EXAMINING ATTORNEY

SN 78-968,204. GMYL, L.P., SAN FRANCISCO, CA. FILED 9-6-2006.

FRANCIS FORD COPPOLA PRESENTS

THE MARK CONSISTS OF STANDARD CHARACTERS WITHOUT CLAIM TO ANY PARTICULAR FONT, STYLE, SIZE, OR COLOR.

OWNER OF U.S. REG. NOS. 2,383,398, 2,721,301 AND OTHERS.

THE NAME(S), PORTRAIT(S), AND/OR SIGNATURE(S) SHOWN IN THE MARK IDENTIFIES FRANCIS FORD COPPOLA, WHOSE CONSENT(S) TO REGISTER IS SUBMITTED.

FOR RETAIL STORE SERVICES AND ONLINE RETAIL STORE SERVICES PROVIDED VIA THE GLOBAL COMPUTER NETWORK IN THE FIELDS OF WINES AND WINE ACCESSORIES, FOODS AND BEVERAGES, KITCHENWARE, DISHWARE, BEVERAGeware, HOUSEWARES, LINENS, CLOTHING, FURNITURE, HOME ACCESSORIES, DECORATIVE ACCESSORIES, CAMERAS, FILM AND PHOTOGRAPHIC SUPPLIES, PRE-RECORDED DVDS, TAPES AND CDS FEATURING MOTION PICTURES AND MUSIC, MOTION PICTURE COLLECTIBLES, CIGARS AND SMOKERS' ARTICLES, LEATHER GOODS, JEWELRY, BOOKS, MAGAZINES, PAPER GOODS AND PRINTED MATTER, STATIONERY ITEMS, POSTERS, COMPUTER ACCESSORIES, WRITING INSTRUMENTS, TOYS, GAMES, AND GIFTWARE; BUYING CLUB SERVICES, NAMELY, PROVIDING TO CLUB MEMBERS REGULAR SHIPMENTS OF WINE, AND DISCOUNTED MAIL-ORDER AND ONLINE ORDERING SERVICES, COMPLIMENTARY TASTINGS, INFORMATION AND INVITATIONS TO MEMBERS-ONLY EVENTS IN THE FIELDS OF FOOD, WINE, TRAVEL AND BEVERAGES (U.S. CLS. 100, 101 AND 102).

DAVID COLLIER, EXAMINING ATTORNEY

CLASS 35—(Continued).

SN 78-968,611. BARBARA KAYE, BRIDGEWATER, MA. FILED 9-6-2006.

EYE CATCHING LOOKS FOR ENTERTAINING COOKS.

THE MARK CONSISTS OF STANDARD CHARACTERS WITHOUT CLAIM TO ANY PARTICULAR FONT, STYLE, SIZE, OR COLOR.

FOR ON-LINE RETAIL STORE SERVICES IN THE FIELD OF STATIONERY, JEWELRY, CALENDARS, CLOCKS, MARBLES, HATS, PARTY FAVORS, PAPER DOLLS, PENNANTS, KITCHEN GOODS, NAMELY, APRONS, TOWELS, TEA COLUMNS, TEA COZIES, SPECIALTY TEAS, TEA TOWELS, AND POT HOLDERS (U.S. CLS. 100, 101 AND 102).

FIRST USE 1-0-2005; IN COMMERCE 1-0-2005.
RAMONA ORTIGA, EXAMINING ATTORNEY

SN 78-971,235. OAK PAPER PRODUCTS CO., INC., LOS ANGELES, CA. FILED 9-11-2006.

BOX PAPER SCISSORS

THE MARK CONSISTS OF STANDARD CHARACTERS WITHOUT CLAIM TO ANY PARTICULAR FONT, STYLE, SIZE, OR COLOR.

FOR RETAIL STORE SERVICES OFFERING PACKAGING AND SHIPPING SUPPLIES (U.S. CLS. 100, 101 AND 102).

PAUL E. FAHRENKOPF, EXAMINING ATTORNEY

SN 78-974,813. LANDRUM HUMAN RESOURCE COMPANIES, INC., PENSACOLA, FL. FILED 9-14-2006.

Landrum Staffing Services

THE MARK CONSISTS OF STANDARD CHARACTERS WITHOUT CLAIM TO ANY PARTICULAR FONT, STYLE, SIZE, OR COLOR.

OWNER OF U.S. REG. NO. 2,353,396.

NO CLAIM IS MADE TO THE EXCLUSIVE RIGHT TO USE "STAFFING SERVICES", APART FROM THE MARK AS SHOWN.

FOR TEMPORARY EMPLOYMENT AGENCIES (U.S. CLS. 100, 101 AND 102).

JOHN GARTNER, EXAMINING ATTORNEY

CLASS 35—(Continued).

SN 78-974,826. NORTHERN SKY RESEARCH, LLC, CAMBRIDGE, MA. FILED 9-14-2006.

BUILDING THE FUTURE WITH
KNOWLEDGE

THE MARK CONSISTS OF STANDARD CHARACTERS WITHOUT CLAIM TO ANY PARTICULAR FONT, STYLE, SIZE, OR COLOR.

FOR MARKET RESEARCH AND MARKET RESEARCH CONSULTING SERVICES IN THE FIELD OF TELECOMMUNICATIONS TECHNOLOGY AND APPLICATION (U.S. CLS. 100, 101 AND 102).

FIRST USE 8-5-2001; IN COMMERCE 8-5-2001.
ELLEN B. AWRICH, EXAMINING ATTORNEY

CLASS 36—(Continued).

SN 76-651,702. CREDITMEDIK, INC., ROCHESTER, NY. FILED 12-9-2005.



THE COLOR(S) BLACK, BLUE AND COPPER IS/ARE CLAIMED AS A FEATURE OF THE MARK.

THE COLOR BLACK APPEARS IN THE GRADUATION CAP; THE COLOR BLUE APPEARS IN THE CAP TASSEL; SHADES OF THE COLOR COPPER APPEAR IN THE IMAGE OF THE PENNY. THE MARK CONSISTS OF AN IMAGE OF ABRAHAM LINCOLN WEARING A GRADUATION CAP EMBLAZONED ON A COIN; A GREEK CROSS WITHIN A CIRCLE IN THE BOTTOM RIGHT PORTION OF THE MARK; THE WORD "LIBERTY" IN THE LEFT PORTION OF THE MARK; AND THE WORDS "IN GOD WE TRUST" PARTIALLY COVERED BY THE GRADUATION CAP.

FOR PERSONAL FINANCIAL ANALYSIS AND CONSULTATION (U.S. CLS. 100, 101 AND 102).
SKYE YOUNG, EXAMINING ATTORNEY

CLASS 36—INSURANCE AND FINANCIAL

SN 76-576,712. GMAC RESIDENTIAL HOLDING LLC, WILMINGTON, DE. FILED 2-23-2004.



SN 76-659,556. JORDAN, STEPHANIE M., DBA INTELLIFINANCIAL GROUP, HUNTSVILLE, AL. FILED 5-4-2006.

INTELLIFINANCIAL

THE MARK CONSISTS OF STANDARD CHARACTERS WITHOUT CLAIM TO ANY PARTICULAR FONT, STYLE, SIZE, OR COLOR.

NO CLAIM IS MADE TO THE EXCLUSIVE RIGHT TO USE "FINANCIAL", APART FROM THE MARK AS SHOWN.

FOR FINANCIAL INFORMATION IN THE AREA OF FINANCE AND SECURITIES PROVIDED BY ELECTRONIC MEANS (U.S. CLS. 100, 101 AND 102).

FIRST USE 3-24-2000; IN COMMERCE 1-4-2002.
SHAILA SETTLES, EXAMINING ATTORNEY

OWNER OF U.S. REG. NO. 3,039,786.
FOR REAL ESTATE BROKERAGE SERVICES (U.S. CLS. 100, 101 AND 102).
FIRST USE 1-2-2002; IN COMMERCE 1-2-2002.
MARLENE BELL, EXAMINING ATTORNEY

CLASS 36—(Continued).

SN 76-666,335. NEA'S MEMBER BENEFITS CORPORATION, GAITHERSBURG, MD. FILED 9-20-2006.

NEA RATESMART

THE MARK CONSISTS OF STANDARD CHARACTERS WITHOUT CLAIM TO ANY PARTICULAR FONT, STYLE, SIZE, OR COLOR.

FOR FINANCIAL SERVICES FOR EDUCATORS, NAMELY, CREDIT CARD SERVICES, MORTGAGE AND EQUITY LENDING SERVICES, PERSONAL, EDUCATION AND VEHICLE LENDING SERVICES, INVESTMENT ADVISORY SERVICES, INVESTMENT PLANNING SERVICES AND CERTIFICATES OF DEPOSIT, MONEY MARKET ACCOUNTS AND OTHER BANKING SERVICES (U.S. CLS. 100, 101 AND 102).

FIRST USE 6-29-2006; IN COMMERCE 6-29-2006.
ANNE MADDEN, EXAMINING ATTORNEY

SN 76-669,453. MERRILL LYNCH & CO., INC., NEW YORK, NY. FILED 11-24-2006.

MLPA

THE MARK CONSISTS OF STANDARD CHARACTERS WITHOUT CLAIM TO ANY PARTICULAR FONT, STYLE, SIZE, OR COLOR.

FOR FINANCIAL INVESTMENT AND BANKING SERVICES, NAMELY, SECURITIES TRADING, PROVIDING FINANCIAL INFORMATION AND RESEARCH, CHECKING ACCOUNT SERVICES, CREDIT AND DEBIT ACCOUNT SERVICES, ONLINE AND PERSONAL INVESTMENT ADVICE, BILL PAYMENT SERVICES, ALL OFFERED TOGETHER IN A FEE-BASED PROGRAM (U.S. CLS. 100, 101 AND 102).

FIRST USE 10-6-2006; IN COMMERCE 10-6-2006.
MATTHEW MCDOWELL, EXAMINING ATTORNEY

SN 76-674,807. CIGNA INTELLECTUAL PROPERTY, INC., CLAYMONT, DE. FILED 3-29-2007.

CIGNAFLEX ADVANTAGE

THE MARK CONSISTS OF STANDARD CHARACTERS WITHOUT CLAIM TO ANY PARTICULAR FONT, STYLE, SIZE, OR COLOR.

OWNER OF U.S. REG. NOS. 1,270,224, 1,926,164 AND OTHERS.

FOR ADMINISTRATION OF A DENTAL INSURANCE PLAN THAT ALLOWS PARTICIPANTS TO SWITCH BETWEEN COVERAGE PLANS (U.S. CLS. 100, 101 AND 102).

FIRST USE 10-8-2004; IN COMMERCE 10-8-2004.
JAMES A. RAUEN, EXAMINING ATTORNEY

CLASS 36—(Continued).

SN 76-675,242. THE HILLS MORTGAGE AND FINANCE COMPANY, L.L.C., MARTINSVILLE, NJ. FILED 4-9-2007.

REAL RATES. REAL SERVICE. REAL SIMPLE.

THE MARK CONSISTS OF STANDARD CHARACTERS WITHOUT CLAIM TO ANY PARTICULAR FONT, STYLE, SIZE, OR COLOR.

FOR MORTGAGE BROKERAGE (U.S. CLS. 100, 101 AND 102).

FIRST USE 1-7-2007; IN COMMERCE 1-7-2007.
BRIAN CALLAGHAN, EXAMINING ATTORNEY

SN 76-675,334. NEW CONSTRUCTION SOURCE, INC., MURRIETA, CA. FILED 4-11-2007.



NEW CONSTRUCTION SOURCE, INC

NO CLAIM IS MADE TO THE EXCLUSIVE RIGHT TO USE "NEW CONSTRUCTION" AND "INC.", APART FROM THE MARK AS SHOWN.

FOR REAL ESTATE BROKERAGE SERVICES (U.S. CLS. 100, 101 AND 102).

FIRST USE 7-13-2005; IN COMMERCE 7-13-2005.
ROSELLE HERRERA, EXAMINING ATTORNEY

SN 76-675,650. NEWFIRST NATIONAL BANK, EL CAMPO, TX. FILED 4-18-2007.

THE BELTWAY BANK

THE MARK CONSISTS OF STANDARD CHARACTERS WITHOUT CLAIM TO ANY PARTICULAR FONT, STYLE, SIZE, OR COLOR.

NO CLAIM IS MADE TO THE EXCLUSIVE RIGHT TO USE "BANK", APART FROM THE MARK AS SHOWN, FOR BANKING SERVICES (U.S. CLS. 100, 101 AND 102).

MARTHA FROMM, EXAMINING ATTORNEY

SN 76-675,940. MAIN STREET AMERICA GROUP, INC., JACKSONVILLE, FL. FILED 4-23-2007.

MASTERS' CLUB

THE MARK CONSISTS OF STANDARD CHARACTERS WITHOUT CLAIM TO ANY PARTICULAR FONT, STYLE, SIZE, OR COLOR.

FOR PROPERTY AND CASUALTY INSURANCE UNDERWRITING SERVICES (U.S. CLS. 100, 101 AND 102).

JESSICA A. POWERS, EXAMINING ATTORNEY

CLASS 36—(Continued).

SN 76-677,962. HSBC FINANCE CORPORATION, PROSPECT HEIGHTS, IL. FILED 6-8-2007.

ACCOUNTSAVER PLUS

THE MARK CONSISTS OF STANDARD CHARACTERS WITHOUT CLAIM TO ANY PARTICULAR FONT, STYLE, SIZE, OR COLOR.

OWNER OF U.S. REG. NO. 2,849,627.

FOR CREDIT CARD SERVICES FEATURING A DEBT CANCELLATION PROGRAM COMPRISED OF AN AGREEMENT BETWEEN A CREDIT CARD HOLDER AND A CREDIT CARD ISSUER SUCH THAT UPON SPECIFIC QUALIFYING EVENTS, THE CREDIT CARD ISSUER WILL CANCEL ALL OR PART OF THE REMAINING DEBT (U.S. CLS. 100, 101 AND 102).

ELISSA GARBER KON, EXAMINING ATTORNEY

SN 77-003,764. INCUBE, INC., MENLO PARK, CA. AND INCUBE, INC., MENLO PARK, CA. FILED 9-20-2006.

InCube

THE MARK CONSISTS OF STANDARD CHARACTERS WITHOUT CLAIM TO ANY PARTICULAR FONT, STYLE, SIZE, OR COLOR.

FOR VENTURE CAPITAL FUNDING SERVICES TO EMERGING AND START-UP COMPANIES (U.S. CLS. 100, 101 AND 102).

FIRST USE 3-1-1995; IN COMMERCE 7-10-1997.

H. M. FISHER, EXAMINING ATTORNEY

SN 77-009,594. HELLOBEACH, LLC, ATLANTA, GA. FILED 9-28-2006.

HelloBeach.com

THE MARK CONSISTS OF STANDARD CHARACTERS WITHOUT CLAIM TO ANY PARTICULAR FONT, STYLE, SIZE, OR COLOR.

FOR REAL ESTATE LISTING (U.S. CLS. 100, 101 AND 102).

FIRST USE 7-4-2006; IN COMMERCE 7-4-2006.

FRANK LATTUCA, EXAMINING ATTORNEY

CLASS 36—(Continued).

SN 77-009,770. FLEX FUND FINANCIAL SERVICES, LLC, MINNETONKA, MN. FILED 9-28-2006.

FUNDAMENTALS FOR FLEXIBLE FINANCING

THE MARK CONSISTS OF STANDARD CHARACTERS WITHOUT CLAIM TO ANY PARTICULAR FONT, STYLE, SIZE, OR COLOR.

NO CLAIM IS MADE TO THE EXCLUSIVE RIGHT TO USE "FINANCING", APART FROM THE MARK AS SHOWN.

FOR FINANCIAL SERVICES, NAMELY, USED CAR INVENTORY FINANCING FOR NEW AND USED CAR DEALERS AND AUCTION SALVAGE BUYERS; PROVIDING AN INTERACTIVE WEBSITE FEATURING FINANCIAL SERVICES, NAMELY, USED CAR INVENTORY FINANCING FOR NEW AND USED CAR DEALERS AND AUCTION SALVAGE BUYERS (U.S. CLS. 100, 101 AND 102).

GINA HAYES, EXAMINING ATTORNEY

SN 77-054,451. COLLEGENET, INC., PORTLAND, OR. FILED 11-30-2006.

IT PAYS TO THINK

THE MARK CONSISTS OF STANDARD CHARACTERS WITHOUT CLAIM TO ANY PARTICULAR FONT, STYLE, SIZE, OR COLOR.

FOR FINANCIAL SERVICES, NAMELY, PROVIDING ACADEMIC SCHOLARSHIPS; PROVIDING ACADEMIC SCHOLARSHIPS VIA AN ONLINE VOTING PROCESS (U.S. CLS. 100, 101 AND 102).

PATRICIA EVANKO, EXAMINING ATTORNEY

SN 77-062,233. WYNN RESORTS HOLDINGS, LLC, LAS VEGAS, NV. FILED 12-12-2006.



OWNER OF U.S. REG. NOS. 2,983,691 AND 3,085,515.

THE MARK CONSISTS OF A STYLIZED CREST WITH STREAMERS AT ITS BASE, EMBLAZONED WITH LINES SUGGESTIVE OF THE LETTER "W" IN THE UPPER PORTION OF THE MARK, AND THE WORDS "WYNN ESPLANADE" IN THE LOWER PORTION OF THE MARK.

FOR SHOPPING CENTER SERVICES, NAMELY, LEASING AND RENTING OF SHOPPING CENTER SPACE (U.S. CLS. 100, 101 AND 102).

KEVIN DINALLO, EXAMINING ATTORNEY

CLASS 36—(Continued).

SN 77-071,671. IGLOBE PARTNERS, INC., SANTA CLARA, CA. FILED 12-27-2006.

iglobe

THE MARK CONSISTS OF STANDARD CHARACTERS WITHOUT CLAIM TO ANY PARTICULAR FONT, STYLE, SIZE, OR COLOR.

FOR INVESTMENT ADVISORY AND MANAGEMENT SERVICES; FUND INVESTMENT CONSULTATION; VENTURE CAPITAL SERVICES, NAMELY, PROVIDING FINANCING TO EMERGING, START-UP AND EXPANSION STAGE COMPANIES (U.S. CLS. 100, 101 AND 102).

FIRST USE 11-0-1999; IN COMMERCE 11-0-1999.
LINDA MICKLEBURGH, EXAMINING ATTORNEY

SN 77-089,425. MORTGAGES, LTD., PHOENIX, AZ. FILED 1-23-2007.

OPPORTUNITY FUNDS

THE MARK CONSISTS OF STANDARD CHARACTERS WITHOUT CLAIM TO ANY PARTICULAR FONT, STYLE, SIZE, OR COLOR.

NO CLAIM IS MADE TO THE EXCLUSIVE RIGHT TO USE "FUNDS", APART FROM THE MARK AS SHOWN.

FOR MORTGAGE BANKING; MORTGAGE BROKERAGE; MORTGAGE LENDING (U.S. CLS. 100, 101 AND 102).

FIRST USE 6-30-2006; IN COMMERCE 6-30-2006.
RICHARD A. STRASER, EXAMINING ATTORNEY

SN 77-095,890. FORT STEUBEN IMPROVEMENTS, LLC, TARRYTOWN, NY. FILED 1-31-2007.

FORT STEUBEN MALL

THE MARK CONSISTS OF STANDARD CHARACTERS WITHOUT CLAIM TO ANY PARTICULAR FONT, STYLE, SIZE, OR COLOR.

NO CLAIM IS MADE TO THE EXCLUSIVE RIGHT TO USE "MALL", APART FROM THE MARK AS SHOWN.

FOR BUILDING MANAGEMENT SERVICES, NAMELY, SHOPPING MALL MANAGEMENT SERVICES; LEASING OF SHOPPING MALL SPACE (U.S. CLS. 100, 101 AND 102).

FIRST USE 3-5-1974; IN COMMERCE 3-5-1974.
DEBRA LEE, EXAMINING ATTORNEY

CLASS 36—(Continued).

SN 77-095,919. HARRIS N.A., CHICAGO, IL. FILED 1-31-2007.

HARRIS LIFESTYLE BENEFITS

THE MARK CONSISTS OF STANDARD CHARACTERS WITHOUT CLAIM TO ANY PARTICULAR FONT, STYLE, SIZE, OR COLOR.

OWNER OF U.S. REG. NOS. 1,008,229, 1,343,279 AND OTHERS.

NO CLAIM IS MADE TO THE EXCLUSIVE RIGHT TO USE "BENEFITS", APART FROM THE MARK AS SHOWN. FOR PROVISION OF BANKING SERVICES, FEATURING A BONUS AWARD OR INCENTIVE PROGRAM FOR CUSTOMERS INVOLVING VARIOUS GOODS (U.S. CLS. 100, 101 AND 102).

FIRST USE 5-31-2007; IN COMMERCE 5-31-2007.
BRIAN NEVILLE, EXAMINING ATTORNEY

SN 77-096,153. PACIFIC WEALTH MANAGEMENT, LLC, SAN DIEGO, CA. FILED 1-31-2007.



NO CLAIM IS MADE TO THE EXCLUSIVE RIGHT TO USE "WEALTH MANAGEMENT", APART FROM THE MARK AS SHOWN.

THE MARK CONSISTS OF THE WORDS PACIFIC WEALTH MANAGEMENT AND A PARTIAL COMPASS.

FOR INVESTMENT ADVICE, FINANCIAL CONSULTATION AND FINANCIAL PLANNING (U.S. CLS. 100, 101 AND 102).

FIRST USE 10-1-2001; IN COMMERCE 10-1-2001.
MICHELLE DUBOIS, EXAMINING ATTORNEY

CLASS 36—(Continued).

SN 77-103,912. WESTSHORE CAPITAL MANAGEMENT, L.P., TAMPA, FL. FILED 2-9-2007.



NO CLAIM IS MADE TO THE EXCLUSIVE RIGHT TO USE "CAPITAL PARTNERS", APART FROM THE MARK AS SHOWN.

"THE COLOR(S) WHITE, ORANGE AND BLUE IS/ARE CLAIMED AS A FEATURE OF THE MARK."

"THE MARK CONSISTS OF THE COLOR BLUE APPEARING IN THE STYLIZED WORDING WESTSHORE, IN THE HORIZONTAL LINE BELOW THE WORDING WESTSHORE AND IN THE BOTTOM HALF OF A RECTANGLE BISECTED BY A WAVY LINE; THE COLOR ORANGE APPEARING IN THE STYLIZED WORDING CAPITAL PARTNERS AND IN THE TOP HALF OF A RECTANGLE BISECTED BY A WAVY LINE; AND THE COLOR WHITE APPEARING IN THE DESIGN OF A WAVY LINE BISECTING A RECTANGLE."

FOR FINANCIAL AND INVESTMENT MANAGEMENT SERVICES; INVESTMENT OF FUNDS FOR OTHERS AND MANAGEMENT OF CAPITAL INVESTMENT FUNDS; CONSULTATION SERVICES IN THE FIELD OF INVESTMENT AND INVESTMENT MANAGEMENT; VENTURE CAPITAL SERVICES, NAMELY, VENTURE CAPITAL FUNDING SERVICES TO EMERGING AND START-UP COMPANIES, PROVIDING FINANCING TO EMERGING AND START-UP COMPANIES (U.S. CLS. 100, 101 AND 102).

FIRST USE 9-25-2006; IN COMMERCE 9-25-2006.
JAY BESCH, EXAMINING ATTORNEY

SN 77-106,863. COVENANT CHILDREN, INC., WEEHAWKEN, NJ. FILED 2-13-2007.

Campaign for Change

THE MARK CONSISTS OF STANDARD CHARACTERS WITHOUT CLAIM TO ANY PARTICULAR FONT, STYLE, SIZE, OR COLOR.

NO CLAIM IS MADE TO THE EXCLUSIVE RIGHT TO USE "CAMPAIGN", APART FROM THE MARK AS SHOWN. FOR CHARITABLE FUND RAISING (U.S. CLS. 100, 101 AND 102).

LINDA MICKLEBURGH, EXAMINING ATTORNEY

CLASS 36—(Continued).

SN 77-108,926. LOHFERT, DENNIS, GERLINGEN, FED REP GERMANY, FILED 2-15-2007.

ASSET ARCHITECTURE

THE MARK CONSISTS OF STANDARD CHARACTERS WITHOUT CLAIM TO ANY PARTICULAR FONT, STYLE, SIZE, OR COLOR.

NO CLAIM IS MADE TO THE EXCLUSIVE RIGHT TO USE "ASSET", APART FROM THE MARK AS SHOWN.

FOR INVESTMENT MANAGEMENT AND ASSET MANAGEMENT SERVICES, NAMELY, HEDGE FUND INVESTMENT SERVICES AND MANAGEMENT OF CAPITAL INVESTMENT FUNDS (U.S. CLS. 100, 101 AND 102).

ANDREW RHIM, EXAMINING ATTORNEY

SN 77-113,774. LAFOREST, STEVEN S, GREELEY, CO. FILED 2-22-2007.



THE MARK CONSISTS OF THE WORD STRONGBUCKS WITH STRONG IN BLACK AND BUCKS IN WHITE AND A BLACK RECTANGLE WITH CONCAVE VERTICAL SIDES AROUND THE WORD BUCKS.

FOR CREDIT AND FINANCIAL CONSULTATION (U.S. CLS. 100, 101 AND 102).

FIRST USE 1-15-2007; IN COMMERCE 1-15-2007.
TINA L. SNAPP, EXAMINING ATTORNEY

SN 77-115,818. SAFE NOW PROJECT, INC., HUMPHREYS, MO. FILED 2-26-2007.

TAKE FIVE: SAFER STEPS TO BE SAFE NOW

THE MARK CONSISTS OF STANDARD CHARACTERS WITHOUT CLAIM TO ANY PARTICULAR FONT, STYLE, SIZE, OR COLOR.

FOR CHARITABLE FUNDRAISING AND ACCEPTING AND ADMINISTERING MONETARY CHARITABLE CONTRIBUTIONS FOR EDUCATIONAL PROGRAMS TO TEACH YOUNG CHILDREN ESSENTIAL SKILLS FOR LIVING A SAFE LIFE AND AVOIDING RISKY AND DANGEROUS SITUATIONS (U.S. CLS. 100, 101 AND 102).

FIRST USE 8-3-2005; IN COMMERCE 8-3-2005.
MARY CRAWFORD, EXAMINING ATTORNEY

CLASS 36—(Continued).

SN 77-118,692. GENERATION MORTGAGE COMPANY, SACRAMENTO, CA. FILED 2-28-2007.

GENERATION MINI

THE MARK CONSISTS OF STANDARD CHARACTERS WITHOUT CLAIM TO ANY PARTICULAR FONT, STYLE, SIZE, OR COLOR.

NO CLAIM IS MADE TO THE EXCLUSIVE RIGHT TO USE "MINI", APART FROM THE MARK AS SHOWN.

FOR REVERSE MORTGAGE LENDING SERVICES, MORTGAGE LOAN BROKERAGE SERVICES, MORTGAGE BANKING SERVICES, REAL ESTATE LENDING (U.S. CLS. 100, 101 AND 102).

DAVID C. REIHNER, EXAMINING ATTORNEY

CLASS 36—(Continued).

SN 77-134,291. FAIRWAY FINANCIAL SOLUTIONS, LLC, IRVING, TX. FILED 3-19-2007.



NO CLAIM IS MADE TO THE EXCLUSIVE RIGHT TO USE "FINANCIAL SOLUTIONS", APART FROM THE MARK AS SHOWN.

THE COLOR(S) BURNT ORANGE, BLACK, WHITE AND GREY IS/ARE CLAIMED AS A FEATURE OF THE MARK.

THE MARK CONSISTS OF A SPHERE THAT IS HALF ORANGE ON THE RIGHT HALF AND BLACK AND GRAY ON THE LEFT HALF. THE SPHERE IS DARKER ON THE BOTTOM AND LIGHTER TOWARDS THE TOP. IN THE MIDDLE OF THE SPHERE IS A LARGE WHITE F. A THICK WHITE CIRCLE OUTLINES THE INSIDE OF THE SPHERE. A GRAY STRIPED ARROW CIRCLES COUNTER-CLOCKWISE AROUND THE SPHERE.

FOR FINANCIAL INVESTMENT IN THE FIELD OF NONPERFORMING CONSUMER DEBT; FINANCIAL MANAGEMENT (U.S. CLS. 100, 101 AND 102).

KEVON CHISOLM, EXAMINING ATTORNEY

SN 77-131,146. USAVISION, INC., DEWEY, OK. FILED 3-14-2007.



NO CLAIM IS MADE TO THE EXCLUSIVE RIGHT TO USE "USA VISION", APART FROM THE MARK AS SHOWN.

THE MARK CONSISTS OF THE SHAPE OF AN EYE WITH A FIVE-POINTED STAR WITHIN THE EYE AND WITH LASHES EXTENDING OUT FROM THE RIGHT SIDE. THE WORDS "USAVISION" APPEAR BELOW THE EYE.

FOR INSURANCE AGENCIES IN THE FIELD OF VISION AND DENTAL; INSURANCE BROKERAGE IN THE FIELD OF VISION AND DENTAL; INSURANCE UNDERWRITING IN THE FIELD OF VISION AND DENTAL (U.S. CLS. 100, 101 AND 102).

FIRST USE 3-0-2004; IN COMMERCE 3-0-2004. ROBERT STRUCK, EXAMINING ATTORNEY

SN 77-135,569. CHURCH GREEN INSURANCE AGENCY, LLC, TAUNTON, MA. FILED 3-20-2007.



THE MARK CONSISTS OF A WIZARD WITH WAND AND STAR ON IT AND STAR NECKLACE.

FOR INSURANCE AGENCIES IN THE FIELD OF AUTO, HOMEOWNER AND BUSINESS (U.S. CLS. 100, 101 AND 102).

FIRST USE 1-1-2000; IN COMMERCE 1-1-2000. MICHAEL LITZAU, EXAMINING ATTORNEY

CLASS 36—(Continued).

SN 77-137,191. PAPERJAM RECORDS, INC., WESTFIELD, NJ. FILED 3-21-2007.

Rock for Dreams

THE MARK CONSISTS OF STANDARD CHARACTERS WITHOUT CLAIM TO ANY PARTICULAR FONT, STYLE, SIZE, OR COLOR.

FOR CHARITABLE FUND RAISING SERVICES BY MEANS OF MUSICAL CONCERTS (U.S. CLS. 100, 101 AND 102).

FIRST USE 2-6-2007; IN COMMERCE 2-6-2007.
JULIE THOMAS, EXAMINING ATTORNEY

SN 77-137,676. FOX, PATRICK, ROSWELL, GA. FILED 3-22-2007.

RightAway Rewards

THE MARK CONSISTS OF STANDARD CHARACTERS WITHOUT CLAIM TO ANY PARTICULAR FONT, STYLE, SIZE, OR COLOR.

NO CLAIM IS MADE TO THE EXCLUSIVE RIGHT TO USE "REWARDS", APART FROM THE MARK AS SHOWN. FOR CREDIT CARD SERVICES (U.S. CLS. 100, 101 AND 102).

KELLEY WELLS, EXAMINING ATTORNEY

SN 77-137,693. FULTON FINANCIAL CORPORATION, LANCASTER, PA. FILED 3-22-2007.

TEAM ADVANTAGE BANKING

THE MARK CONSISTS OF STANDARD CHARACTERS WITHOUT CLAIM TO ANY PARTICULAR FONT, STYLE, SIZE, OR COLOR.

NO CLAIM IS MADE TO THE EXCLUSIVE RIGHT TO USE "BANKING", APART FROM THE MARK AS SHOWN. FOR BANKING SERVICES (U.S. CLS. 100, 101 AND 102).

KELLEY WELLS, EXAMINING ATTORNEY

CLASS 36—(Continued).

SN 77-138,301. PAULSON REAL ESTATE, INC, WILSONVILLE, OR. FILED 3-22-2007.

THE CHARBONNEAU SPECIALIST

THE MARK CONSISTS OF STANDARD CHARACTERS WITHOUT CLAIM TO ANY PARTICULAR FONT, STYLE, SIZE, OR COLOR.

SEC. 2(F).
FOR REAL ESTATE BROKERAGE (U.S. CLS. 100, 101 AND 102).

FIRST USE 0-0-1999; IN COMMERCE 0-0-1999.
BARBARA BROWN, EXAMINING ATTORNEY

SN 77-147,153. MORTGAGE DATA MANAGEMENT CORPORATION, SUSSEX, WI. FILED 4-3-2007.

MDMC

THE MARK CONSISTS OF STANDARD CHARACTERS WITHOUT CLAIM TO ANY PARTICULAR FONT, STYLE, SIZE, OR COLOR.

FOR FINANCIAL DUE DILIGENCE SERVICES, MORTGAGE BANKING SERVICES, NAMELY, ORIGINATION, ACQUISITION, SERVICING, SECURITIZATION AND PROVIDING FINANCIAL DUE DILIGENCE OF MORTGAGE LOANS FOR OTHERS (U.S. CLS. 100, 101 AND 102).

FIRST USE 6-8-1992; IN COMMERCE 6-8-1992.
EDWARD NELSON, EXAMINING ATTORNEY

SN 77-147,310. THE COMMUNITY STATE BANK, POTEAU, OK. FILED 4-3-2007.



NO CLAIM IS MADE TO THE EXCLUSIVE RIGHT TO USE "COMMUNITY STATE BANK" AND "BANKING", APART FROM THE MARK AS SHOWN.

THE MARK CONSISTS OF THE TERMS "THE COMMUNITY" ARE STYLIZED WITH THE BASE OF THE "C"

CLASS 36—(Continued).

UNDERLINING THE REMAINDER OF THE TERM "COMMUNITY" IN AN ARC. "THE" IS ABOVE THE "OM" IN "COMMUNITY" THE TERMS "STATE BANK" ARE IN BLOCK LIKE LETTERS. THE TERMS "COMMON SENSE BANKING" ARE IN AN ITALICS STYLE. THE TERMS "COMMUNITY STATE BANK" ARE IN CAPITAL LETTERS. THE "T" ON "THE", "C" ON "COMMON", "S" ON "SENSE" AND "B" ON "BANKING" ARE CAPITALIZED. THERE IS AN INVERTED HORIZONTAL COMMA BENEATH THE "OM" IN "COMMUNITY".

FOR BANKING (U.S. CLS. 100, 101 AND 102).
FIRST USE 3-1-1991; IN COMMERCE 3-1-1991.
ELISSA GARBER KON, EXAMINING ATTORNEY

CLASS 36—(Continued).

SN 77-149,665. HEMISPHERE NATIONAL BANK, MIAMI, FL. FILED 4-5-2007.



SN 77-147,647. NATIONAL ALOPECIA AREATA FOUNDATION, SAN RAFAEL, CA. FILED 4-3-2007.

TORTOISE & HAIR

THE MARK CONSISTS OF STANDARD CHARACTERS WITHOUT CLAIM TO ANY PARTICULAR FONT, STYLE, SIZE, OR COLOR.

FOR CHARITABLE FUND RAISING SERVICES (U.S. CLS. 100, 101 AND 102).
FIRST USE 11-1-2006; IN COMMERCE 11-1-2006.
AMY BROZENIC, EXAMINING ATTORNEY

OWNER OF U.S. REG. NO. 2,885,479.
NO CLAIM IS MADE TO THE EXCLUSIVE RIGHT TO USE "FEDERAL", APART FROM THE MARK AS SHOWN. THE COLOR(S) BLACK AND RED IS/ARE CLAIMED AS A FEATURE OF THE MARK.

THE MARK CONSISTS OF THE WORDING REPUBLIC IN BLACK, WITH A RED STRIPE EXTENDING BELOW THE LETTER R. UNDER THE WORDING REPUBLIC AND TO THE RIGHT OF THE RED STRIPE IS THE WORDING FEDERAL IN BLACK.

FOR BANKING SERVICES (U.S. CLS. 100, 101 AND 102).
FIRST USE 2-0-2007; IN COMMERCE 2-0-2007.
PETER CHENG, EXAMINING ATTORNEY

SN 77-149,591. PENSON WORLDWIDE, DALLAS, TX. FILED 4-5-2007.

**THE FLEXIBLE CHOICE IN
GLOBAL FINANCIAL SERVICES**

THE MARK CONSISTS OF STANDARD CHARACTERS WITHOUT CLAIM TO ANY PARTICULAR FONT, STYLE, SIZE, OR COLOR.

OWNER OF U.S. REG. NO. 3,191,364.
NO CLAIM IS MADE TO THE EXCLUSIVE RIGHT TO USE "GLOBAL FINANCIAL SERVICES", APART FROM THE MARK AS SHOWN.

FOR FINANCIAL SERVICES, NAMELY, FINANCIAL CLEARING HOUSES, FINANCIAL INFORMATION PROCESSING, INVESTMENT FUND TRANSFER AND TRANSACTION SERVICES, FINANCING SERVICES, INVESTMENT BROKERAGE, AND CURRENCY EXCHANGE (U.S. CLS. 100, 101 AND 102).

FIRST USE 11-0-2006; IN COMMERCE 11-0-2006.
ALYSSA PALADINO, EXAMINING ATTORNEY

SN 77-149,693. HEMISPHERE NATIONAL BANK, MIAMI, FL. FILED 4-5-2007.

Republic Federal

OWNER OF U.S. REG. NO. 2,885,479.
NO CLAIM IS MADE TO THE EXCLUSIVE RIGHT TO USE "FEDERAL", APART FROM THE MARK AS SHOWN. THE COLOR(S) BLACK AND RED IS/ARE CLAIMED AS A FEATURE OF THE MARK.

THE MARK CONSISTS OF THE WORDING REPUBLIC IN BLACK, WITH A RED STRIPE EXTENDING BELOW THE LETTER R. IMMEDIATELY TO THE RIGHT OF THE WORDING REPUBLIC IS THE WORDING FEDERAL IN BLACK.

FOR BANKING SERVICES (U.S. CLS. 100, 101 AND 102).
FIRST USE 2-0-2007; IN COMMERCE 2-0-2007.
PETER CHENG, EXAMINING ATTORNEY

CLASS 36—(Continued).

SN 77-150,721. CLARK MATERIAL HANDLING COMPANY, LEXINGTON, KY. FILED 4-6-2007.



**Material Handling
FINANCIAL SERVICES**

NO CLAIM IS MADE TO THE EXCLUSIVE RIGHT TO USE "MATERIAL HANDLING FINANCIAL SERVICES", APART FROM THE MARK AS SHOWN.

THE MARK CONSISTS OF THE WORD CLARK IN UPPER CASE STYLIZED LETTERS SURROUNDED BY A BORDER AND ABOVE THE WORDS "MATERIAL HANDLING" IN INITIAL CAPITAL LETTERS WITH THE WORDS FINANCIAL SERVICES BELOW IN CAPITAL LETTERS.

FOR FINANCIAL SERVICES, NAMELY, LOAN SERVICES; FINANCIAL SERVICES, NAMELY, WHOLESALE, RETAIL AND OTHER LOAN SERVICES; FINANCIAL SERVICES, NAMELY, PROVIDING FINANCING FOR THE PURCHASE, LEASE OR RENTAL OF MATERIAL HANDLING EQUIPMENT, FORKLIFTS, OFF-ROAD VEHICLES, OVER-THE-ROAD TRUCKS AND MOTOR VEHICLES, AND PARTS, SERVICE AND INSURANCE THEREFOR; FINANCIAL SERVICES, NAMELY, PROVIDING WHOLESALE, RETAIL AND OTHER FINANCING FOR THE PURCHASE, LEASE OR RENTAL OF MATERIAL HANDLING EQUIPMENT, FORKLIFTS, OFF-ROAD VEHICLES, OVER-THE-ROAD TRUCKS AND MOTOR VEHICLES, AND PARTS, SERVICE AND INSURANCE THEREFOR (U.S. CLS. 100, 101 AND 102).

GINA HAYES, EXAMINING ATTORNEY

SN 77-152,355. THE SAN DIEGO FOUNDATION, SAN DIEGO, CA. FILED 4-9-2007.

ENDOW ESCONDIDO

THE MARK CONSISTS OF STANDARD CHARACTERS WITHOUT CLAIM TO ANY PARTICULAR FONT, STYLE, SIZE, OR COLOR.

"THE FOREIGN WORDING IN THE MARK TRANSLATES INTO ENGLISH AS HIDDEN."

FOR CHARITABLE SERVICES, NAMELY, ACCEPTING AND ADMINISTERING MONETARY CHARITABLE CONTRIBUTIONS; PROVIDING INFORMATION ABOUT MONETARY CHARITABLE CONTRIBUTIONS AND COMMUNITY NEEDS RELATED THERETO; PHILANTHROPIC PLANNING SERVICES CONCERNING MONETARY DONATIONS (U.S. CLS. 100, 101 AND 102).

NAAKWAMA ANKRAH, EXAMINING ATTORNEY

CLASS 36—(Continued).

SN 77-152,450. URBAN UPKEEP, INC., BRONX, NY. FILED 4-10-2007.

URBAN UPKEEP

THE MARK CONSISTS OF STANDARD CHARACTERS WITHOUT CLAIM TO ANY PARTICULAR FONT, STYLE, SIZE, OR COLOR.

NO CLAIM IS MADE TO THE EXCLUSIVE RIGHT TO USE "URBAN", APART FROM THE MARK AS SHOWN.

FOR REAL ESTATE MANAGEMENT (U.S. CLS. 100, 101 AND 102).

FIRST USE 3-0-2006; IN COMMERCE 3-0-2006.

CHRISTOPHER OTT, EXAMINING ATTORNEY

SN 77-153,340. THE CLUB AT SPANISH PEAKS, LLC, BIG SKY, MT. FILED 4-10-2007.

BEST OF THE WEST

THE MARK CONSISTS OF STANDARD CHARACTERS WITHOUT CLAIM TO ANY PARTICULAR FONT, STYLE, SIZE, OR COLOR.

FOR LEASING OF REAL ESTATE; REAL ESTATE BROKERAGE; REAL ESTATE LISTING; REAL ESTATE MANAGEMENT (U.S. CLS. 100, 101 AND 102).

KATHERINE CHANG, EXAMINING ATTORNEY

SN 77-153,443. THE OUTREACH CENTER, BROOKLYN, NY. FILED 4-10-2007.

**TURN YOUR OLD LEMON INTO
LEMONADE**

THE MARK CONSISTS OF STANDARD CHARACTERS WITHOUT CLAIM TO ANY PARTICULAR FONT, STYLE, SIZE, OR COLOR.

FOR CHARITABLE FUND RAISING SERVICES IN THE NATURE OF A CAR DONATION PROGRAM TO RAISE AND COLLECT CHARITABLE MONETARY DONATIONS (U.S. CLS. 100, 101 AND 102).

JEAN IM, EXAMINING ATTORNEY

CLASS 36—(Continued).

SN 77-153,458. G & MM SERVICES, INC, BROOKLYN, NY. FILED 4-10-2007.



NO CLAIM IS MADE TO THE EXCLUSIVE RIGHT TO USE "MYBROOKLYNAPARTMENT.COM", APART FROM THE MARK AS SHOWN.

THE MARK CONSISTS OF THE FOLLOWING WORDS AND FORMAT: MYBROOKLYNAPARTMENT.COM THE NAME OF THE COMPANY SPELLED EXACTLY AS REPRESENTED ABOVE - THE TAG LINE: 'HAVE YOU' IS PLACED ABOVE THE ARCHED (UPWARD - SMILING SHAPE) COMPANY NAME AND IS IN AN OVAL CAPTION.

FOR REAL ESTATE LISTING (U.S. CLS. 100, 101 AND 102).

TINA KUAN, EXAMINING ATTORNEY

CLASS 36—(Continued).

SN 77-153,795. NYSE GROUP, INC., NEW YORK, NY. FILED 4-11-2007.

VolumeTrac

THE MARK CONSISTS OF STANDARD CHARACTERS WITHOUT CLAIM TO ANY PARTICULAR FONT, STYLE, SIZE, OR COLOR.

FOR PROVIDING SECURITIES EXCHANGE RELATED SERVICES AND FINANCIAL DATA VIA COMPUTER NETWORK TO OTHERS, NAMELY, DISSEMINATING DATA REGARDING PURCHASES AND SALES OF SECURITIES AND EXECUTED VOLUME IN SECURITIES OF EXCHANGE-LISTED COMPANIES DURING VARIOUS TIME PERIODS (U.S. CLS. 100, 101 AND 102).

KHANH LE, EXAMINING ATTORNEY

SN 77-153,547. ALLIED INSURANCE BROKERS, INC., PITTSBURGH, PA. FILED 4-10-2007.



FOR INSURANCE BROKERAGE AND INSURANCE UNDERWRITING SERVICES FOR ALL TYPES OF INSURANCE (U.S. CLS. 100, 101 AND 102).

FIRST USE 2-26-2007; IN COMMERCE 2-26-2007. DANIEL RUSSELL, EXAMINING ATTORNEY

SN 77-154,204. VOLUNTARY.COM LLC, LANCASTER, PA. FILED 4-11-2007.



SN 77-153,554. ALLIED INSURANCE BROKERS, INC., PITTSBURGH, PA. FILED 4-10-2007.

EXCELLENCE DRIVES OUR POLICY

THE MARK CONSISTS OF STANDARD CHARACTERS WITHOUT CLAIM TO ANY PARTICULAR FONT, STYLE, SIZE, OR COLOR.

FOR INSURANCE BROKERAGE AND INSURANCE UNDERWRITING SERVICES FOR ALL TYPES OF INSURANCE (U.S. CLS. 100, 101 AND 102).

FIRST USE 2-26-2007; IN COMMERCE 2-26-2007. DANIEL RUSSELL, EXAMINING ATTORNEY

THE COLOR(S) RED AND WHITE IS/ARE CLAIMED AS A FEATURE OF THE MARK.

THE MARK CONSISTS OF A RED CHECKMARK INSIDE OF A RED CIRCLE, ALL ON A WHITE BACKGROUND.

FOR INSURANCE BROKERAGE SERVICES; PROVIDING ONLINE INFORMATION IN THE FIELD OF VOLUNTARY EMPLOYEE BENEFITS INFORMATION; PROVIDING ONLINE INFORMATION IN THE FIELD OF INSURANCE AND EMPLOYEE BENEFITS (U.S. CLS. 100, 101 AND 102).

FIRST USE 11-1-2006; IN COMMERCE 11-1-2006. JOHN DALIER, EXAMINING ATTORNEY

CLASS 36—(Continued).

SN 77-154,761. ARLINGTON RICHFIELD, INC., BIRMINGHAM, MI. FILED 4-12-2007.

ARLINGTON RICHFIELD

THE MARK CONSISTS OF STANDARD CHARACTERS WITHOUT CLAIM TO ANY PARTICULAR FONT, STYLE, SIZE, OR COLOR.

FOR FINANCIAL LOAN CONSULTATION, FINANCIAL PLANNING CONSULTATION, FINANCIAL SERVICES, NAMELY, ASSISTING OTHERS WITH FINANCIAL TRANSACTIONS (U.S. CLS. 100, 101 AND 102).

FIRST USE 2-0-2006; IN COMMERCE 8-0-2006.
REGINA DRUMMOND, EXAMINING ATTORNEY

CLASS 36—(Continued).

SN 77-154,970. BLOAN.COM, LLC, LONG ISLAND CITY, NY. FILED 4-12-2007.



THE MARK CONSISTS OF A B SLANTED UPWARD INSIDE A CIRCLE. THE LETTERS L O A AND N NEXT TO THE CIRCLE.

FOR FACILITATING AND ARRANGING FOR THE FINANCING OF RECEIVABLES AND EQUIPMENT; FINANCIAL LOAN CONSULTATION (U.S. CLS. 100, 101 AND 102).

FIRST USE 2-21-2007; IN COMMERCE 2-21-2007.
MORENO, PAUL, EXAMINING ATTORNEY

SN 77-155,181. SEAHAVEN PROPERTIES, INC., PANAMA CITY BEACH, FL. FILED 4-12-2007.

Towne of Seahaven

SN 77-154,930. MCKISSACK GROUP, INC., DENTON, TX. FILED 4-12-2007.



NO CLAIM IS MADE TO THE EXCLUSIVE RIGHT TO USE "REALTY GROUP", APART FROM THE MARK AS SHOWN.

THE MARK CONSISTS OF THE WORD MCKISSACK WITH THE ROOF OF A HOUSE OVER THE MC. THE WORDING REALTY GROUP APPEARS IN A RECTANGLE BELOW THE WORD MCKISSACK.

SEC. 2(F) AS TO MCKISSACK.
FOR REAL ESTATE AGENCIES; REAL ESTATE BROKERAGE; REAL ESTATE CONSULTANCY; REAL ESTATE CONSULTATION; REAL ESTATE LISTING (U.S. CLS. 100, 101 AND 102).

FIRST USE 6-15-1999; IN COMMERCE 6-15-1999.
TINA BROWN, EXAMINING ATTORNEY

THE MARK CONSISTS OF STANDARD CHARACTERS WITHOUT CLAIM TO ANY PARTICULAR FONT, STYLE, SIZE, OR COLOR.

NO CLAIM IS MADE TO THE EXCLUSIVE RIGHT TO USE "TOWNE", APART FROM THE MARK AS SHOWN.

FOR REAL ESTATE MANAGEMENT, NAMELY, THE OPERATION AND MANAGEMENT OF COMMUNITY FACILITIES FOR PLANNED RESIDENTIAL, COMMERCIAL, CONDOMINIUM, MIXED USE AND RESORT PROPERTIES (U.S. CLS. 100, 101 AND 102).

MIDGE BUTLER, EXAMINING ATTORNEY

SN 77-155,250. SEAHAVEN PROPERTIES, INC., PANAMA CITY BEACH, FL. FILED 4-12-2007.

Seahaven

THE MARK CONSISTS OF STANDARD CHARACTERS WITHOUT CLAIM TO ANY PARTICULAR FONT, STYLE, SIZE, OR COLOR.

FOR REAL ESTATE MANAGEMENT, NAMELY, THE OPERATION AND MANAGEMENT OF COMMUNITY FACILITIES FOR PLANNED RESIDENTIAL, COMMERCIAL, CONDOMINIUM, MIXED USE AND RESORT PROPERTIES (U.S. CLS. 100, 101 AND 102).

MIDGE BUTLER, EXAMINING ATTORNEY

CLASS 36—(Continued).

SN 77-155,266. SEAHAVEN PROPERTIES, INC., PANAMA CITY BEACH, FL. FILED 4-12-2007.

Seahaven Beach

THE MARK CONSISTS OF STANDARD CHARACTERS WITHOUT CLAIM TO ANY PARTICULAR FONT, STYLE, SIZE, OR COLOR.

NO CLAIM IS MADE TO THE EXCLUSIVE RIGHT TO USE "BEACH", APART FROM THE MARK AS SHOWN.

FOR REAL ESTATE MANAGEMENT, NAMELY, THE OPERATION AND MANAGEMENT OF COMMUNITY FACILITIES FOR PLANNED RESIDENTIAL, COMMERCIAL, CONDOMINIUM, MIXED USE AND RESORT PROPERTIES (U.S. CLS. 100, 101 AND 102).

MIDGE BUTLER, EXAMINING ATTORNEY

CLASS 36—(Continued).

SN 77-156,118. MIZUHO FINANCIAL GROUP, INC., TOKYO, JAPAN, FILED 4-13-2007.



OWNER OF U.S. REG. NO. 2,785,276.

THE MARK CONSISTS OF THE LETTERS MHTB APPEARING WITHIN A SOLID RECTANGLE.

FOR INSURANCE ADMINISTRATION, BROKERAGE, CLAIMS PROCESSING AND CONSULTATION; ACCIDENT, FIRE, LIFE, MARINE AND MEDICAL INSURANCE UNDERWRITING; FINANCIAL AFFAIRS, NAMELY, FINANCIAL RESEARCH, FORECASTING, EXCHANGE, PLANNING, MANAGEMENT, ANALYSIS AND CONSULTATION; FINANCIAL SERVICES IN THE NATURE OF AN INVESTMENT SECURITY; FINANCIAL VALUATION OF PERSONAL PROPERTY AND REAL ESTATE; FINANCIAL INFORMATION IN THE NATURE OF RATES OF EXCHANGE; FINANCIAL GUARANTEE AND SURETY; FINANCIAL SERVICES, NAMELY, DEBIT AND CREDIT CARD SERVICES, BANKING, SAVINGS BANKS, ELECTRONIC FUNDS TRANSFER, SAFETY DEPOSIT BOX SERVICES, TRAVELER'S CHECK ISSUANCE, SURETY SERVICES, FACTORING AGENCIES, CAPITAL INVESTMENT CONSULTATION, FISCAL ASSESSMENT EVALUATION, CHECK VERIFICATION, ACTUARIAL SERVICES, FINANCIAL GUARANTEE AND SURETY, MUTUAL FUND BROKERAGE, DISTRIBUTION AND INVESTMENT, LEASE-PURCHASE LOANS, AND BAIL BONDING; MONETARY AFFAIRS, NAMELY, MONETARY EXCHANGE AND PHILANTHROPIC SERVICES CONCERNING MONETARY DONATIONS; REAL ESTATE AFFAIRS, NAMELY, REAL ESTATE AGENCIES, LISTING, APPRAISAL, MANAGEMENT, INVESTMENT, BROKERAGE, SYNDICATION AND ESCROW SERVICES; REAL ESTATE TIME-SHARING SERVICES; LEASING OF REAL PROPERTY, APARTMENTS AND OFFICE SPACE (U.S. CLS. 100, 101 AND 102).

TRICIA SONNEBORN, EXAMINING ATTORNEY

SN 77-156,103. BUXTON, BRAD, SALT LAKE CITY, UT. FILED 4-13-2007.

LUXURYQUEST

THE MARK CONSISTS OF STANDARD CHARACTERS WITHOUT CLAIM TO ANY PARTICULAR FONT, STYLE, SIZE, OR COLOR.

FOR REAL ESTATE RENTAL MANAGEMENT SERVICES AND VACATION RENTAL SERVICES, NAMELY, RENTAL OF VACATION HOMES (U.S. CLS. 100, 101 AND 102).

TINA BROWN, EXAMINING ATTORNEY

CLASS 36—(Continued).

SN 77-156,305. MIZUHO FINANCIAL GROUP, INC., TOKYO, JAPAN, FILED 4-13-2007.

CLASS 36—(Continued).

SN 77-156,352. MIZUHO FINANCIAL GROUP, INC., TOKYO, JAPAN, FILED 4-13-2007.



OWNER OF U.S. REG. NO. 2,676,075.
THE MARK CONSISTS OF THE LETTERS MHFG APPEARING WITHIN A SOLID RECTANGLE.

FOR INSURANCE ADMINISTRATION, BROKERAGE, CLAIMS PROCESSING AND CONSULTATION; ACCIDENT, FIRE, LIFE, MARINE AND MEDICAL INSURANCE UNDERWRITING; FINANCIAL AFFAIRS, NAMELY, FINANCIAL RESEARCH, FORECASTING, EXCHANGE, PLANNING, MANAGEMENT, ANALYSIS AND CONSULTATION; FINANCIAL SERVICES IN THE NATURE OF AN INVESTMENT SECURITY; FINANCIAL VALUATION OF PERSONAL PROPERTY AND REAL ESTATE; FINANCIAL INFORMATION IN THE NATURE OF RATES OF EXCHANGE; FINANCIAL GUARANTEE AND SURETY; FINANCIAL SERVICES, NAMELY, DEBIT AND CREDIT CARD SERVICES, BANKING, SAVINGS BANKS, ELECTRONIC FUNDS TRANSFER, SAFETY DEPOSIT BOX SERVICES, TRAVELER'S CHECK ISSUANCE, SURETY SERVICES, FACTORING AGENCIES, CAPITAL INVESTMENT CONSULTATION, FISCAL ASSESSMENT EVALUATION, CHECK VERIFICATION, ACTUARIAL SERVICES, FINANCIAL GUARANTEE AND SURETY, MUTUAL FUND BROKERAGE, DISTRIBUTION AND INVESTMENT, LEASE-PURCHASE LOANS, AND BAIL BONDING; MONETARY AFFAIRS, NAMELY, MONETARY EXCHANGE AND PHILANTHROPIC SERVICES CONCERNING MONETARY DONATIONS; REAL ESTATE AFFAIRS, NAMELY, REAL ESTATE AGENCIES, LISTING, APPRAISAL, MANAGEMENT, INVESTMENT, BROKERAGE, SYNDICATION AND ESCROW SERVICES; REAL ESTATE TIME-SHARING SERVICES; LEASING OF REAL PROPERTY, APARTMENTS AND OFFICE SPACE (U.S. CLS. 100, 101 AND 102).

TRICIA SONNEBORN, EXAMINING ATTORNEY

OWNER OF U.S. REG. NO. 2,754,844.
THE MARK CONSISTS OF THE LETTERS MHCB APPEARING WITHIN A SOLID RECTANGLE.

FOR INSURANCE ADMINISTRATION, BROKERAGE, CLAIMS PROCESSING AND CONSULTATION; ACCIDENT, FIRE, LIFE, MARINE AND MEDICAL INSURANCE UNDERWRITING; FINANCIAL AFFAIRS, NAMELY, FINANCIAL RESEARCH, FORECASTING, EXCHANGE, PLANNING, MANAGEMENT, ANALYSIS AND CONSULTATION; FINANCIAL SERVICES IN THE NATURE OF AN INVESTMENT SECURITY; FINANCIAL VALUATION OF PERSONAL PROPERTY AND REAL ESTATE; FINANCIAL INFORMATION IN THE NATURE OF RATES OF EXCHANGE; FINANCIAL GUARANTEE AND SURETY; FINANCIAL SERVICES, NAMELY, DEBIT AND CREDIT CARD SERVICES, BANKING, SAVINGS BANKS, ELECTRONIC FUNDS TRANSFER, SAFETY DEPOSIT BOX SERVICES, TRAVELER'S CHECK ISSUANCE, SURETY SERVICES, FACTORING AGENCIES, CAPITAL INVESTMENT CONSULTATION, FISCAL ASSESSMENT EVALUATION, CHECK VERIFICATION, ACTUARIAL SERVICES, FINANCIAL GUARANTEE AND SURETY, MUTUAL FUND BROKERAGE, DISTRIBUTION AND INVESTMENT, LEASE-PURCHASE LOANS, AND BAIL BONDING; MONETARY AFFAIRS, NAMELY, MONETARY EXCHANGE AND PHILANTHROPIC SERVICES CONCERNING MONETARY DONATIONS; REAL ESTATE AFFAIRS, NAMELY, REAL ESTATE AGENCIES, LISTING, APPRAISAL, MANAGEMENT, INVESTMENT, BROKERAGE, SYNDICATION AND ESCROW SERVICES; REAL ESTATE TIME-SHARING SERVICES; LEASING OF REAL PROPERTY, APARTMENTS AND OFFICE SPACE (U.S. CLS. 100, 101 AND 102).

TRICIA SONNEBORN, EXAMINING ATTORNEY

CLASS 36—(Continued).

SN 77-156,366. MIZUHO FINANCIAL GROUP, INC., TOKYO, JAPAN, FILED 4-13-2007.



OWNER OF U.S. REG. NO. 2,766,045.

THE MARK CONSISTS OF THE LETTERS MHBK APPEARING WITHIN A SOLID RECTANGLE.

FOR INSURANCE ADMINISTRATION, BROKERAGE, CLAIMS PROCESSING AND CONSULTATION; ACCIDENT, FIRE, LIFE, MARINE AND MEDICAL INSURANCE UNDERWRITING; FINANCIAL AFFAIRS, NAMELY, FINANCIAL RESEARCH, FORECASTING, EXCHANGE, PLANNING, MANAGEMENT, ANALYSIS AND CONSULTATION; FINANCIAL SERVICES IN THE NATURE OF AN INVESTMENT SECURITY; FINANCIAL VALUATION OF PERSONAL PROPERTY AND REAL ESTATE; FINANCIAL INFORMATION IN THE NATURE OF RATES OF EXCHANGE; FINANCIAL GUARANTEE AND SURETY; FINANCIAL SERVICES, NAMELY, DEBIT AND CREDIT CARD SERVICES, BANKING, SAVINGS BANKS, ELECTRONIC FUNDS TRANSFER, SAFETY DEPOSIT BOX SERVICES, TRAVELER'S CHECK ISSUANCE, SURETY SERVICES, FACTORING AGENCIES, CAPITAL INVESTMENT CONSULTATION, FISCAL ASSESSMENT EVALUATION, CHECK VERIFICATION, ACTUARIAL SERVICES, FINANCIAL GUARANTEE AND SURETY, MUTUAL FUND BROKERAGE, DISTRIBUTION AND INVESTMENT, LEASE-PURCHASE LOANS, AND BAIL BONDING; MONETARY AFFAIRS, NAMELY, MONETARY EXCHANGE AND PHILANTHROPIC SERVICES CONCERNING MONETARY DONATIONS; REAL ESTATE AFFAIRS, NAMELY REAL ESTATE AGENCIES, LISTING, APPRAISAL, MANAGEMENT, INVESTMENT, BROKERAGE, SYNDICATION AND ESCROW SERVICES; REAL ESTATE TIME-SHARING SERVICES; LEASING OF REAL PROPERTY, APARTMENTS AND OFFICE SPACE (U.S. CLS. 100, 101 AND 102).

TRICIA SONNEBORN, EXAMINING ATTORNEY

CLASS 36—(Continued).

SN 77-156,377. MIZUHO FINANCIAL GROUP, INC., TOKYO, JAPAN, FILED 4-13-2007.



OWNER OF U.S. REG. NO. 2,785,275.

THE MARK CONSISTS OF THE LETTERS MHSC APPEARING WITHIN A SOLID RECTANGLE.

FOR INSURANCE ADMINISTRATION, BROKERAGE, CLAIMS PROCESSING AND CONSULTATION; ACCIDENT, FIRE, LIFE, MARINE AND MEDICAL INSURANCE UNDERWRITING; FINANCIAL AFFAIRS, NAMELY, FINANCIAL RESEARCH, FORECASTING, EXCHANGE, PLANNING, MANAGEMENT, ANALYSIS AND CONSULTATION; FINANCIAL SERVICES IN THE NATURE OF AN INVESTMENT SECURITY; FINANCIAL VALUATION OF PERSONAL PROPERTY AND REAL ESTATE; FINANCIAL INFORMATION IN THE NATURE OF RATES OF EXCHANGE; FINANCIAL GUARANTEE AND SURETY; FINANCIAL SERVICES, NAMELY, DEBIT AND CREDIT CARD SERVICES, BANKING, SAVING BANKS, ELECTRONIC FUNDS TRANSFER, SAFETY DEPOSIT BOX SERVICES, TRAVELER'S CHECK ISSUANCE, SURETY SERVICES, FACTORING AGENCIES, CAPITAL INVESTMENT CONSULTATION, FISCAL ASSESSMENT EVALUATION, CHECK VERIFICATION, ACTUARIAL SERVICES, FINANCIAL GUARANTEE AND SURETY, MUTUAL FUND BROKERAGE, DISTRIBUTION AND INVESTMENT, LEASE-PURCHASE LOANS, AND BAIL BONDING; MONETARY AFFAIRS, NAMELY, MONETARY EXCHANGE AND PHILANTHROPIC SERVICES CONCERNING MONETARY DONATIONS; REAL ESTATE AFFAIRS, NAMELY REAL ESTATE AGENCIES, LISTING, APPRAISAL, MANAGEMENT, INVESTMENT, BROKERAGE, SYNDICATION AND ESCROW SERVICES; REAL ESTATE TIME-SHARING SERVICES; LEASING OF REAL PROPERTY, APARTMENTS AND OFFICE SPACE (U.S. CLS. 100, 101 AND 102).

TRICIA SONNEBORN, EXAMINING ATTORNEY

SN 77-156,696. RENTERS LEGAL LIABILITY, LLC, SALT LAKE CITY, UT. FILED 4-13-2007.

RENTERS SATISFACTION

THE MARK CONSISTS OF STANDARD CHARACTERS WITHOUT CLAIM TO ANY PARTICULAR FONT, STYLE, SIZE, OR COLOR.

FOR INSURANCE ADMINISTRATION IN THE FIELD OF BUILDING INSURANCE PROTECTING LANDLORDS' REAL AND PERSONAL PROPERTY AND TENANTS' PERSONAL PROPERTY FROM FIRE, SMOKE, EXPLOSIONS, ACCIDENTAL WATER OVERFLOW OR DISCHARGE, AND OTHER HAZARDS (U.S. CLS. 100, 101 AND 102).

FIRST USE 4-13-2007; IN COMMERCE 4-13-2007.

MICHAEL LITZAU, EXAMINING ATTORNEY

CLASS 36—(Continued).

SN 77-156,839. GLOBAL DENVER, INC., NORTH PLATTE, NE. FILED 4-14-2007.

μCuba

THE MARK CONSISTS OF STANDARD CHARACTERS WITHOUT CLAIM TO ANY PARTICULAR FONT, STYLE, SIZE, OR COLOR.

NO CLAIM IS MADE TO THE EXCLUSIVE RIGHT TO USE "CUBA", APART FROM THE MARK AS SHOWN.

FOR PROVIDING TEMPORARY LOANS (U.S. CLS. 100, 101 AND 102).

FIRST USE 4-14-2007; IN COMMERCE 4-14-2007.
SOPHIA S. KIM, EXAMINING ATTORNEY

CLASS 36—(Continued).

SN 77-157,225. AXA EQUITABLE LIFE INSURANCE COMPANY, NEW YORK, NY. FILED 4-16-2007.

EMBLEM

THE MARK CONSISTS OF STANDARD CHARACTERS WITHOUT CLAIM TO ANY PARTICULAR FONT, STYLE, SIZE, OR COLOR.

FOR INVESTMENT MANAGEMENT AND DISTRIBUTION OF VARIABLE ANNUITIES; ISSUANCE AND ADMINISTRATION OF ANNUITIES (U.S. CLS. 100, 101 AND 102).

KRISTIN DAHLING, EXAMINING ATTORNEY

SN 77-156,848. SOUTHERN INDIANA CREDIT CORPORATION, LAWRENCEBURG, IN. FILED 4-14-2007.

CREDIT TIL PAYDAY

THE MARK CONSISTS OF STANDARD CHARACTERS WITHOUT CLAIM TO ANY PARTICULAR FONT, STYLE, SIZE, OR COLOR.

OWNER OF U.S. REG. NO. 3,022,157.
SEC. 2(F).

FOR TEMPORARY LOANS (U.S. CLS. 100, 101 AND 102).

FIRST USE 4-28-1998; IN COMMERCE 4-28-1998.
SOPHIA S. KIM, EXAMINING ATTORNEY

SN 77-157,259. KENTUCKY HIGHER EDUCATION STUDENT LOAN CORPORATION, DBA THE STUDENT LOAN PEOPLE, LOUISVILLE, KY. FILED 4-16-2007.



THE COLOR(S) WHITE, NAVY BLUE, AND GOLD IS/ARE CLAIMED AS A FEATURE OF THE MARK.

THE COLOR NAVY BLUE APPEARS IN THE WORDING BESTSTART AND IN THE DESIGNS OF A MORTAR BOARD AND A CURVED BAR. THE COLOR GOLD APPEARS IN A SHADED CIRCLE. THE COLOR WHITE APPEARS IN THE CURVED BAR IN THE TOP PART OF THE CIRCLE.

FOR STUDENT LOAN SERVICES (U.S. CLS. 100, 101 AND 102).

FIRST USE 0-0-2003; IN COMMERCE 0-0-2003.
TINA KUAN, EXAMINING ATTORNEY

SN 77-156,963. HORSTICK, LORI G, FREDERICKSBURG, VA. FILED 4-14-2007.



NO CLAIM IS MADE TO THE EXCLUSIVE RIGHT TO USE "THE SUPERIOR HOME SELLING TEAM & ASSOCIATES", APART FROM THE MARK AS SHOWN.

THE COLOR(S) RED, BLACK AND GRAY IS/ARE CLAIMED AS A FEATURE OF THE MARK.

THE COLOR RED APPEARS IN THE OUTLINE OF THE HOME AND THE WORDING "THE" AND "HOME SELLING TEAM & ASSOCIATES"; THE COLOR BLACK APPEARS AS BACKGROUND COLOR; AND THE TERM "SUPERIOR" IS IN THE COLOR GRAY.

FOR REAL ESTATE AGENCIES (U.S. CLS. 100, 101 AND 102).

CHRISTOPHER BUONGIORNO, EXAMINING ATTORNEY

SN 77-157,531. JOHN M. YONAN III, TRACY, CA. FILED 4-16-2007.

minuteman

THE MARK CONSISTS OF STANDARD CHARACTERS WITHOUT CLAIM TO ANY PARTICULAR FONT, STYLE, SIZE, OR COLOR.

FOR BAIL BONDING (U.S. CLS. 100, 101 AND 102).
ROBIN CHOSID, EXAMINING ATTORNEY

CLASS 36—(Continued).

SN 77-157,664. GLENRISK CONSULTING LLC, HOUSTON, TX. FILED 4-16-2007.

GLENRISK

THE MARK CONSISTS OF STANDARD CHARACTERS WITHOUT CLAIM TO ANY PARTICULAR FONT, STYLE, SIZE, OR COLOR.

FOR RISK MANAGEMENT CONSULTATION (U.S. CLS. 100, 101 AND 102).

LINDA E. BLOHM, EXAMINING ATTORNEY

SN 77-157,689. AMERICAN INTERNATIONAL GROUP, INC., NEW YORK, NY. FILED 4-16-2007.

SRO NAPA

THE MARK CONSISTS OF STANDARD CHARACTERS WITHOUT CLAIM TO ANY PARTICULAR FONT, STYLE, SIZE, OR COLOR.

NO CLAIM IS MADE TO THE EXCLUSIVE RIGHT TO USE "NAPA", APART FROM THE MARK AS SHOWN.

FOR INSURANCE UNDERWRITING IN THE FIELD OF PROPERTY AND CASUALTY (U.S. CLS. 100, 101 AND 102).

FIRST USE 2-1-1997; IN COMMERCE 2-1-1997.
BRIDGETT SMITH, EXAMINING ATTORNEY

CLASS 36—(Continued).

SN 77-157,731. GLENRISK CONSULTING LLC, HOUSTON, TX. FILED 4-16-2007.



THE COLOR(S) LIGHT BLUE, MEDIUM BLUE, DARK BLUE, BLACK, GRAY AND WHITE IS/ARE CLAIMED AS A FEATURE OF THE MARK.

THE MARK CONSISTS OF A GLOBE DESIGN THAT IS SHOWN IN GRADES OF BLUE, SPECIFICALLY, LIGHT BLUE TO MEDIUM BLUE TO DARK BLUE, WITH A GRAY RECTANGULAR GRID SUPERIMPOSED OVER THE GLOBE AND A BLACK RING AND ARROW DESIGN, OUTLINED IN WHITE, AROUND THE GLOBE. THE BACKGROUND BEHIND THE GRID IS ALSO WHITE.

FOR RISK MANAGEMENT CONSULTATION (U.S. CLS. 100, 101 AND 102).

LINDA E. BLOHM, EXAMINING ATTORNEY

SN 77-157,781. MINNESOTA CENTER FOR PHOTOGRAPHY, MINNEAPOLIS, MN. FILED 4-16-2007.

MUSICAPOLIS

THE MARK CONSISTS OF STANDARD CHARACTERS WITHOUT CLAIM TO ANY PARTICULAR FONT, STYLE, SIZE, OR COLOR.

FOR CHARITABLE FUND RAISING SERVICES BY MEANS OF MUSICAL CONCERTS (U.S. CLS. 100, 101 AND 102).

FIRST USE 1-1-2004; IN COMMERCE 2-1-2005.
DANIEL CAPSHAW, EXAMINING ATTORNEY

CLASS 36—(Continued).

SN 77-157,853. BRIDGER COMMERCIAL FUNDING LLC, MILL VALLEY, CA. FILED 4-16-2007.

BRIDGER UNIVERSITY

THE MARK CONSISTS OF STANDARD CHARACTERS WITHOUT CLAIM TO ANY PARTICULAR FONT, STYLE, SIZE, OR COLOR.

FOR PROVIDING AN ONLINE INFORMATION AND KNOWLEDGE DATABASE FEATURING INFORMATION IN THE FIELD OF COMMERCIAL REAL ESTATE LENDING (U.S. CLS. 100, 101 AND 102).

FIRST USE 11-30-2000; IN COMMERCE 11-30-2000.
CHRISTINA SOBRAL, EXAMINING ATTORNEY

SN 77-157,855. TRANSCO CLAIMS OF FLORIDA, INC., TAMPA, FL. FILED 4-16-2007.

Transco Claims

THE MARK CONSISTS OF STANDARD CHARACTERS WITHOUT CLAIM TO ANY PARTICULAR FONT, STYLE, SIZE, OR COLOR.

NO CLAIM IS MADE TO THE EXCLUSIVE RIGHT TO USE "CLAIMS", APART FROM THE MARK AS SHOWN.

FOR CLAIMS ADJUSTMENT IN THE FIELD OF INSURANCE (U.S. CLS. 100, 101 AND 102).

FIRST USE 1-1-2004; IN COMMERCE 1-1-2004.
DANIEL BRODY, EXAMINING ATTORNEY

SN 77-157,903. KELLER WILLIAMS REALTY, INC., AUSTIN, TX. FILED 4-16-2007.

KELLER WILLIAMS LUXURY HOMES

THE MARK CONSISTS OF STANDARD CHARACTERS WITHOUT CLAIM TO ANY PARTICULAR FONT, STYLE, SIZE, OR COLOR.

NO CLAIM IS MADE TO THE EXCLUSIVE RIGHT TO USE "LUXURY HOMES", APART FROM THE MARK AS SHOWN.

FOR REAL ESTATE BROKERAGE SERVICES (U.S. CLS. 100, 101 AND 102).

HEATHER SAPP, EXAMINING ATTORNEY

CLASS 36—(Continued).

SN 77-158,216. ROCK THE EARTH, DENVER, CO. FILED 4-17-2007.

Rock the Earth

THE MARK CONSISTS OF STANDARD CHARACTERS WITHOUT CLAIM TO ANY PARTICULAR FONT, STYLE, SIZE, OR COLOR.

OWNER OF U.S. REG. NOS. 2,813,125 AND 2,957,131.

FOR CHARITABLE FUND RAISING SERVICES BY MEANS OF MUSICAL CONCERTS; CHARITABLE FUND RAISING; ACCEPTING AND ADMINISTERING MONETARY CHARITABLE CONTRIBUTIONS (U.S. CLS. 100, 101 AND 102).

FIRST USE 3-5-2004; IN COMMERCE 3-5-2004.
FRANK LATTUCA, EXAMINING ATTORNEY

SN 77-158,258. VERGE LIVING CORPORATION, CARSON CITY, NV. FILED 4-17-2007.

KNOW WHEN TO SAY YES

THE MARK CONSISTS OF STANDARD CHARACTERS WITHOUT CLAIM TO ANY PARTICULAR FONT, STYLE, SIZE, OR COLOR.

FOR REAL ESTATE BROKERAGE (U.S. CLS. 100, 101 AND 102).

JUDITH HELFMAN, EXAMINING ATTORNEY

SN 77-158,936. ATTORNEYS' TITLE GUARANTY FUND, INC., CHAMPAIGN, IL. FILED 4-17-2007.



OWNER OF U.S. REG. NOS. 1,611,540, 2,125,322 AND 2,186,405.

THE MARK CONSISTS OF A HOUSE WITH A SECOND ROOF FLOATING ABOVE THE FIRST ROOF.

FOR PROVIDING INFORMATION IN THE FIELD OF REAL ESTATE (U.S. CLS. 100, 101 AND 102).

FIRST USE 2-1-2004; IN COMMERCE 2-1-2004.

MICHAEL WEBSTER, EXAMINING ATTORNEY

CLASS 36—(Continued).

SN 77-159,047. SAVANT INNOVATIONS, AJAX, CANADA, FILED 4-17-2007.

**WALL STREET HAS COME TO
YOUR STREET**

THE MARK CONSISTS OF STANDARD CHARACTERS WITHOUT CLAIM TO ANY PARTICULAR FONT, STYLE, SIZE, OR COLOR.

FOR BANKING; AGENCIES OR BROKERAGE FOR TRADING OF SECURITIES, SECURITIES INDEX FUTURES, SECURITIES OPTIONS, AND OVERSEAS MARKET SECURITIES FUTURES; ADMINISTRATION OF SAVINGS ACCOUNTS; ADVICE RELATING TO INVESTMENTS; AGENCIES FOR BROKERAGE OF SECURITIES TRADING IN OVERSEAS SECURITIES MARKETS AND OF TRANSACTIONS ON COMMISSION OF OVERSEAS MARKET SECURITIES FUTURES; AGENCIES IN THE FIELD OF BONDS AND OTHER SECURITIES; BROKERAGE OF SHARES AND OTHER SECURITIES; BROKERAGE OF SHARES OR STOCKS AND OTHER SECURITIES; BUSINESS, STOCK OPTION AND PENSION VALUATION SERVICES; CHECKING ACCOUNT SERVICES; CREDIT CARD SERVICES; DEBIT CARD SERVICES; ELECTRONIC FUNDS TRANSFER; EQUITY CAPITAL INVESTMENT; ESTATE PLANNING; FINANCIAL ADMINISTRATION OF RETIREMENT PLANS; FINANCIAL ANALYSIS AND CONSULTATION; FINANCIAL CONSULTATION; FINANCIAL PLANNING; FINANCIAL PLANNING CONSULTATION; FINANCIAL PLANNING FOR RETIREMENT; FINANCIAL PLANNING, NAMELY THE CREATION OF PERSONALIZED STRATEGIES TO ACHIEVE FINANCIAL INDEPENDENCE; FINANCIAL PORTFOLIO MANAGEMENT; FINANCIAL SERVICES, NAMELY ASSISTING OTHERS WITH THE COMPLETION OF FINANCIAL TRANSACTIONS FOR STOCKS, BONDS, SECURITIES AND EQUITIES; FINANCIAL SERVICES, NAMELY ESTATE SETTLEMENT SERVICES; FINANCIAL SERVICES, NAMELY MONEY LENDING; FINANCIAL SERVICES, NAMELY A TOTAL PORTFOLIO OFFERING FOR HIGH NET WORTH CLIENTS CONSISTING OF BOTH SEPARATE ACCOUNTS AND MUTUAL FUNDS FOR EQUITY AND FIXED INCOME INVESTMENTS; FINANCIAL TRUST OPERATIONS; FUND INVESTMENT CONSULTATION; FUNDS INVESTMENT; INSURANCE AGENCY AND BROKERAGE; INSURANCE CONSULTATION; INVESTMENT ADVICE; INVESTMENT ADVISORY SERVICES; INVESTMENT BANKING SERVICES; INVESTMENT BROKERAGE; INVESTMENT CLUBS; INVESTMENT CONSULTATION; INVESTMENT OF FUNDS FOR OTHERS; ISSUING CREDIT CARDS; LOAN FINANCING; MANAGEMENT OF PORTFOLIOS COMPRISING SECURITIES; MUTUAL FUND BROKERAGE; MUTUAL FUND DISTRIBUTION; MUTUAL FUND INVESTMENT; PROVIDING STOCK MARKET INFORMATION; PROVIDING STOCK/SECURITIES MARKET INFORMATION; SAVINGS ACCOUNT SERVICES; SAVINGS BANK SERVICES; STOCK BROKERAGE; TRUST SERVICES, NAMELY, INVESTMENT AND TRUST COMPANY SERVICES; VACATION REAL ESTATE TIME-SHARE SERVICES; TRUST MANAGEMENT ACCOUNTS (U.S. CLS. 100, 101 AND 102).

ALLISON HOLTZ, EXAMINING ATTORNEY

CLASS 36—(Continued).

SN 77-159,165. THE PHILADELPHIA FOUNDATION, PHILADELPHIA, PA. FILED 4-18-2007.

**THE POWER OF ENDLESS
POSSIBILITIES**

THE MARK CONSISTS OF STANDARD CHARACTERS WITHOUT CLAIM TO ANY PARTICULAR FONT, STYLE, SIZE, OR COLOR.

FOR PHILANTHROPIC SERVICES CONCERNING MONETARY DONATIONS, GRANTS, FUNDS, TRUSTS AND ENDOWMENTS (U.S. CLS. 100, 101 AND 102).
FIRST USE 4-4-2007; IN COMMERCE 4-4-2007.
RAY THOMAS, EXAMINING ATTORNEY

SN 77-159,214. CONNECTICUT ATTORNEYS TITLE INSURANCE COMPANY, ROCKY HILL, CT. FILED 4-18-2007.



OWNER OF U.S. REG. NOS. 2,100,831, 3,099,414 AND OTHERS.

THE MARK CONSISTS OF A BLOCK C DESIGN WITH THE WORDS "CATIC ACCESS TO SUCCESS."

FOR TITLE INSURANCE, NAMELY, THE ISSUANCE OF POLICIES; PROVIDING MORTGAGE INFORMATION, ALSO VIA ELECTRONIC MEANS, TELEPHONE OR OTHER FORMS OF DATA TRANSFER; MORTGAGE RELEASE AND DISCHARGE TRACKING SERVICES; OBTAINING AND RECORDING MORTGAGE RELEASES; GENERATING AND RECORDING AFFIDAVIT OF RELEASE DOCUMENTS IN THE FIELD OF MORTGAGES; PROVIDING AN ONLINE DATABASE OF MORTGAGE STATUS INFORMATION (U.S. CLS. 100, 101 AND 102).

CHRIS WELLS, EXAMINING ATTORNEY

SN 77-159,233. COLOSO, JOHN J, NASHOTAH, WI. FILED 4-18-2007.

The right way to retire

THE MARK CONSISTS OF STANDARD CHARACTERS WITHOUT CLAIM TO ANY PARTICULAR FONT, STYLE, SIZE, OR COLOR.

FOR FINANCIAL PLANNING FOR RETIREMENT (U.S. CLS. 100, 101 AND 102).
FIRST USE 1-1-2004; IN COMMERCE 1-1-2004.
FRED MANDIR, EXAMINING ATTORNEY

CLASS 36—(Continued).

SN 77-159,359. BOARD OF PENSIONS OF THE EVANGELICAL LUTHERAN CHURCH IN AMERICA, MINNEAPOLIS, MN. FILED 4-18-2007.

Social Purpose 40e Balanced Fund

THE MARK CONSISTS OF STANDARD CHARACTERS WITHOUT CLAIM TO ANY PARTICULAR FONT, STYLE, SIZE, OR COLOR.

OWNER OF U.S. REG. NOS. 3,041,593, 3,041,609 AND OTHERS.

NO CLAIM IS MADE TO THE EXCLUSIVE RIGHT TO USE "BALANCED FUND", APART FROM THE MARK AS SHOWN.

FOR FINANCIAL SERVICES, NAMELY, FUNDS INVESTMENT SERVICES (U.S. CLS. 100, 101 AND 102).

FIRST USE 1-1-2006; IN COMMERCE 1-1-2006.
ELIZABETH KAJUBI, EXAMINING ATTORNEY

CLASS 36—(Continued).

SN 77-159,414. BOARD OF PENSIONS EVANGELICAL LUTHERAN CHURCH OF AMERICA, MINNEAPOLIS, MN. FILED 4-18-2007.

ELCA Social Purpose 40e Balanced Fund

THE MARK CONSISTS OF STANDARD CHARACTERS WITHOUT CLAIM TO ANY PARTICULAR FONT, STYLE, SIZE, OR COLOR.

OWNER OF U.S. REG. NOS. 3,041,595, 3,041,609 AND OTHERS.

NO CLAIM IS MADE TO THE EXCLUSIVE RIGHT TO USE "BALANCED FUND", APART FROM THE MARK AS SHOWN.

FOR FINANCIAL SERVICES, NAMELY, FUNDS INVESTMENT SERVICES (U.S. CLS. 100, 101 AND 102).

FIRST USE 1-1-2006; IN COMMERCE 1-1-2006.
IRA J. GOODSaid, EXAMINING ATTORNEY

SN 77-159,364. BOARD OF PENSIONS OF THE EVANGELICAL LUTHERAN CHURCH IN AMERICA, MINNEAPOLIS, MN. FILED 4-18-2007.

Social Purpose 60e Balanced Fund

THE MARK CONSISTS OF STANDARD CHARACTERS WITHOUT CLAIM TO ANY PARTICULAR FONT, STYLE, SIZE, OR COLOR.

OWNER OF U.S. REG. NOS. 3,041,593, 3,041,609 AND OTHERS.

NO CLAIM IS MADE TO THE EXCLUSIVE RIGHT TO USE "BALANCED FUND", APART FROM THE MARK AS SHOWN.

FOR FINANCIAL SERVICES, NAMELY, FUNDS INVESTMENT SERVICES (U.S. CLS. 100, 101 AND 102).

FIRST USE 1-1-2006; IN COMMERCE 1-1-2006.
ELIZABETH KAJUBI, EXAMINING ATTORNEY

SN 77-159,417. BOARD OF PENSIONS EVANGELICAL LUTHERAN CHURCH OF AMERICA, MINNEAPOLIS, MN. FILED 4-18-2007.

ELCA Social Purpose 60e Balanced Fund

THE MARK CONSISTS OF STANDARD CHARACTERS WITHOUT CLAIM TO ANY PARTICULAR FONT, STYLE, SIZE, OR COLOR.

OWNER OF U.S. REG. NOS. 3,041,595, 3,041,609 AND OTHERS.

NO CLAIM IS MADE TO THE EXCLUSIVE RIGHT TO USE "BALANCED FUND", APART FROM THE MARK AS SHOWN.

FOR FINANCIAL SERVICES, NAMELY, FUNDS INVESTMENT SERVICES (U.S. CLS. 100, 101 AND 102).

FIRST USE 1-1-2006; IN COMMERCE 1-1-2006.
IRA J. GOODSaid, EXAMINING ATTORNEY

SN 77-159,368. BOARD OF PENSIONS OF THE EVANGELICAL LUTHERAN CHURCH IN AMERICA, MINNEAPOLIS, MN. FILED 4-18-2007.

Social Purpose 80e Balanced Fund

THE MARK CONSISTS OF STANDARD CHARACTERS WITHOUT CLAIM TO ANY PARTICULAR FONT, STYLE, SIZE, OR COLOR.

OWNER OF U.S. REG. NOS. 3,041,593, 3,041,609 AND OTHERS.

NO CLAIM IS MADE TO THE EXCLUSIVE RIGHT TO USE "BALANCED FUND", APART FROM THE MARK AS SHOWN.

FOR FINANCIAL SERVICES, NAMELY, FUNDS INVESTMENT SERVICES (U.S. CLS. 100, 101 AND 102).

FIRST USE 1-1-2006; IN COMMERCE 1-1-2006.
ELIZABETH KAJUBI, EXAMINING ATTORNEY

SN 77-159,421. BOARD OF PENSIONS EVANGELICAL LUTHERAN CHURCH OF AMERICA, MINNEAPOLIS, MN. FILED 4-18-2007.

ELCA Social Purpose 80e Balanced Fund

THE MARK CONSISTS OF STANDARD CHARACTERS WITHOUT CLAIM TO ANY PARTICULAR FONT, STYLE, SIZE, OR COLOR.

OWNER OF U.S. REG. NOS. 3,041,595, 3,041,608 AND 3,041,609.

NO CLAIM IS MADE TO THE EXCLUSIVE RIGHT TO USE "BALANCED FUND", APART FROM THE MARK AS SHOWN.

FOR FINANCIAL SERVICES, NAMELY, FUNDS INVESTMENT SERVICES (U.S. CLS. 100, 101 AND 102).

FIRST USE 1-1-2006; IN COMMERCE 1-1-2006.
IRA J. GOODSaid, EXAMINING ATTORNEY

CLASS 36—(Continued).

SN 77-159,437. O'BRIEN FAMILY VINEYARD LLC, NAPA, CA. FILED 4-18-2007.

WINE FOR HOPE

THE MARK CONSISTS OF STANDARD CHARACTERS WITHOUT CLAIM TO ANY PARTICULAR FONT, STYLE, SIZE, OR COLOR.

FOR FINANCIAL SERVICES, NAMELY, PROVIDING FUNDRAISING SERVICES TO NON-PROFIT AND PHILANTHROPIC ORGANIZATIONS BY DONATING A PORTION OF PROCEEDS FROM THE SALE OF WINES TO SUCH ORGANIZATIONS (U.S. CLS. 100, 101 AND 102).

FIRST USE 4-10-2007; IN COMMERCE 4-10-2007.
LINDA ESTRADA, EXAMINING ATTORNEY

SN 77-159,458. OAKLAND COUNTY CREDIT UNION, WATERFORD, MI. FILED 4-18-2007.

We Succeed Together

THE MARK CONSISTS OF STANDARD CHARACTERS WITHOUT CLAIM TO ANY PARTICULAR FONT, STYLE, SIZE, OR COLOR.

FOR CREDIT UNIONS (U.S. CLS. 100, 101 AND 102).
FIRST USE 10-1-2006; IN COMMERCE 10-1-2006.
AMY BROZENIC, EXAMINING ATTORNEY

SN 77-159,688. HEATHCOTE BOTANICAL GARDENS, INC., FT PIERCE, FL. FILED 4-18-2007.

Royal Palm Society

THE MARK CONSISTS OF STANDARD CHARACTERS WITHOUT CLAIM TO ANY PARTICULAR FONT, STYLE, SIZE, OR COLOR.

NO CLAIM IS MADE TO THE EXCLUSIVE RIGHT TO USE "SOCIETY", APART FROM THE MARK AS SHOWN.

FOR ACCEPTING AND ADMINISTERING MONETARY CHARITABLE CONTRIBUTIONS (U.S. CLS. 100, 101 AND 102).

FIRST USE 4-12-2006; IN COMMERCE 4-12-2006.
DANIEL CAPSHAW, EXAMINING ATTORNEY

CLASS 36—(Continued).

SN 77-159,865. PRESBYTERIAN HEALTHCARE SERVICES, ALBUQUERQUE, NM. FILED 4-18-2007.

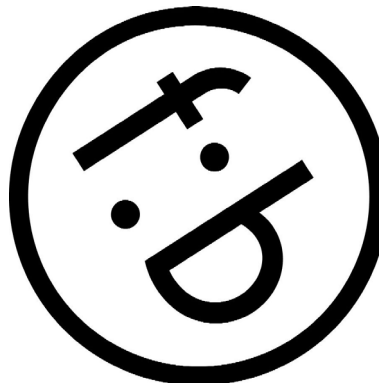

THE MARK CONSISTS OF THE CHARACTER SET "F:B" IN A CIRCLE ORIENTED TO REPRESENT A SMILEY FACE.

FOR HEALTH INSURANCE UNDERWRITING AND ADMINISTRATION SERVICES (U.S. CLS. 100, 101 AND 102).

KAREN BRACEY, EXAMINING ATTORNEY

SN 77-159,866. ORAL ROBERTS EVANGELISTIC ASSOCIATION, INC., TULSA, OK. FILED 4-18-2007.

HUNGER NEEDS A VOICE

THE MARK CONSISTS OF STANDARD CHARACTERS WITHOUT CLAIM TO ANY PARTICULAR FONT, STYLE, SIZE, OR COLOR.

FOR CHARITABLE FUND RAISING (U.S. CLS. 100, 101 AND 102).

STEVEN PÉREZ, EXAMINING ATTORNEY

SN 77-160,320. THE JOYCE THEATER FOUNDATION, INC., NEW YORK, NY. FILED 4-19-2007.

JOYCE

THE MARK CONSISTS OF STANDARD CHARACTERS WITHOUT CLAIM TO ANY PARTICULAR FONT, STYLE, SIZE, OR COLOR.

FOR CHARITABLE FUND RAISING (U.S. CLS. 100, 101 AND 102).

FIRST USE 2-28-1982; IN COMMERCE 2-28-1982.
JEAN IM, EXAMINING ATTORNEY

CLASS 36—(Continued).

SN 77-160,899. AMEROP SUGAR CORPORATION, MIAMI, FL. FILED 4-19-2007.

SUCDEN

THE MARK CONSISTS OF STANDARD CHARACTERS WITHOUT CLAIM TO ANY PARTICULAR FONT, STYLE, SIZE, OR COLOR.

FOR FINANCIAL SERVICES, NAMELY, COMMODITY TRADING FOR OTHERS, COMMODITY CONSULTATION SERVICES, INVESTMENT OF FUNDS FOR OTHERS, INVESTMENT CONSULTATION SERVICES, INVESTMENT MANAGEMENT SERVICES (U.S. CLS. 100, 101 AND 102).

THEODORE MCBRIDE, EXAMINING ATTORNEY

CLASS 36—(Continued).

SN 77-161,289. INFINITY INSURANCE CO., BIRMINGHAM, AL. FILED 4-19-2007.

HILLSTAR

THE MARK CONSISTS OF STANDARD CHARACTERS WITHOUT CLAIM TO ANY PARTICULAR FONT, STYLE, SIZE, OR COLOR.

FOR PROPERTY AND CASUALTY INSURANCE UNDERWRITING SERVICES (U.S. CLS. 100, 101 AND 102).

LINDA ORNDORFF, EXAMINING ATTORNEY

SN 77-161,359. ALPHASTREAM PORTFOLIOS, INC., MADISON, GA. FILED 4-20-2007.

ALPHASTREAM

THE MARK CONSISTS OF STANDARD CHARACTERS WITHOUT CLAIM TO ANY PARTICULAR FONT, STYLE, SIZE, OR COLOR.

FOR FINANCIAL PORTFOLIO MANAGEMENT; MANAGING PRIVATE EQUITY, MUTUAL FUNDS, HEDGE FUNDS, AND SEPARATELY MANAGED ACCOUNTS; FUNDS INVESTMENT (U.S. CLS. 100, 101 AND 102).

KYLE PEETE, EXAMINING ATTORNEY

SN 77-160,971. CROWN BANKSHARES, INC., EDINA, MN. FILED 4-19-2007.

THE PLACE TO DO BUSINESS

THE MARK CONSISTS OF STANDARD CHARACTERS WITHOUT CLAIM TO ANY PARTICULAR FONT, STYLE, SIZE, OR COLOR.

FOR BANKING SERVICES (U.S. CLS. 100, 101 AND 102).

FIRST USE 9-0-2000; IN COMMERCE 9-0-2000.

JASON ROTH, EXAMINING ATTORNEY

SN 77-161,053. RLS TRANSACTIONS LLC, WOODCLIFF LAKE, NJ. FILED 4-19-2007.

The Settlement of Your Life

THE MARK CONSISTS OF STANDARD CHARACTERS WITHOUT CLAIM TO ANY PARTICULAR FONT, STYLE, SIZE, OR COLOR.

FOR VIATICAL SETTLEMENT SERVICES; INSURANCE AGENCY AND BROKERAGE (U.S. CLS. 100, 101 AND 102).

TINA KUAN, EXAMINING ATTORNEY

SN 77-161,629. NATIONAL PENN BANCSHARES, INC., BOYERTOWN, PA. FILED 4-20-2007.

LET'S DO SOMETHING SPECIAL

THE MARK CONSISTS OF STANDARD CHARACTERS WITHOUT CLAIM TO ANY PARTICULAR FONT, STYLE, SIZE, OR COLOR.

FOR BANKING SERVICES (U.S. CLS. 100, 101 AND 102).

FIRST USE 1-25-2007; IN COMMERCE 2-7-2007.

JOHN DWYER, EXAMINING ATTORNEY

CLASS 36—(Continued).

SN 77-162,099. INDEPENDENCE BLUE CROSS, PHILADELPHIA, PA. FILED 4-20-2007.

INTELLIQUEUE

THE MARK CONSISTS OF STANDARD CHARACTERS WITHOUT CLAIM TO ANY PARTICULAR FONT, STYLE, SIZE, OR COLOR.

FOR INSURANCE CLAIMS ADMINISTRATION AND PROCESSING SERVICES (U.S. CLS. 100, 101 AND 102).
FRED MANDIR, EXAMINING ATTORNEY

SN 77-162,103. ONECALIFORNIA BANK FSB, SAN FRANCISCO, CA. FILED 4-20-2007.

BUSINESSVIEW

THE MARK CONSISTS OF STANDARD CHARACTERS WITHOUT CLAIM TO ANY PARTICULAR FONT, STYLE, SIZE, OR COLOR.

FOR ON-LINE BANKING SERVICES (U.S. CLS. 100, 101 AND 102).
KEVIN DINALLO, EXAMINING ATTORNEY

SN 77-162,204. CIRCLE K STORES INC., TEMPE, AZ. FILED 4-20-2007.

GREEN NETWORK

THE MARK CONSISTS OF STANDARD CHARACTERS WITHOUT CLAIM TO ANY PARTICULAR FONT, STYLE, SIZE, OR COLOR.

FOR AUTOMATED TELLER MACHINE SERVICES; CHECK CASHING; CHECK PROCESSING; MONEY ORDER SERVICES (U.S. CLS. 100, 101 AND 102).
FIRST USE 3-15-2007; IN COMMERCE 3-15-2007.
KEVIN DINALLO, EXAMINING ATTORNEY

CLASS 36—(Continued).

SN 77-162,224. CIRCLE K STORES INC., TEMPE, AZ. FILED 4-20-2007.



THE MARK CONSISTS OF THE LETTERS GN IN A DOT. FOR AUTOMATED TELLER MACHINE SERVICES; CHECK CASHING; CHECK PROCESSING; MONEY ORDER SERVICES (U.S. CLS. 100, 101 AND 102).

FIRST USE 3-15-2007; IN COMMERCE 3-15-2007.
KEVIN DINALLO, EXAMINING ATTORNEY

SN 77-162,321. INVESTCORP RETIREMENT SPECIALISTS, INC., GAITHERSBURG, MD. FILED 4-20-2007.

YOUR ONE RETIREMENT SOURCE

THE MARK CONSISTS OF STANDARD CHARACTERS WITHOUT CLAIM TO ANY PARTICULAR FONT, STYLE, SIZE, OR COLOR.

FOR FINANCIAL PLANNING; FINANCIAL PLANNING FOR RETIREMENT; FINANCIAL PLANNING CONSULTATION; INVESTMENT ADVICE; INSURANCE AGENCIES; INSURANCE CONSULTATION (U.S. CLS. 100, 101 AND 102).

JENNIFER MARTIN, EXAMINING ATTORNEY

SN 77-162,480. ALLSTATE BANCORP, INC., LOS ANGELES, CA. FILED 4-21-2007.

RENEGOTIATION CENTER

THE MARK CONSISTS OF STANDARD CHARACTERS WITHOUT CLAIM TO ANY PARTICULAR FONT, STYLE, SIZE, OR COLOR.

FOR MORTGAGE BROKERAGE; MORTGAGE LENDING (U.S. CLS. 100, 101 AND 102).
FIRST USE 8-15-2005; IN COMMERCE 8-15-2005.
CHERYL CLAYTON, EXAMINING ATTORNEY

CLASS 36—(Continued).

SN 77-163,529. THE SAN DIEGO FOUNDATION, SAN DIEGO, CA. FILED 4-23-2007.

ENDOW POWAY

THE MARK CONSISTS OF STANDARD CHARACTERS WITHOUT CLAIM TO ANY PARTICULAR FONT, STYLE, SIZE, OR COLOR.

NO CLAIM IS MADE TO THE EXCLUSIVE RIGHT TO USE "POWAY", APART FROM THE MARK AS SHOWN.

FOR CHARITABLE SERVICES, NAMELY, ACCEPTING AND ADMINISTERING MONETARY CHARITABLE CONTRIBUTIONS; PROVIDING INFORMATION ABOUT MONETARY CHARITABLE CONTRIBUTIONS AND COMMUNITY NEEDS RELATED THERETO; PHILANTHROPIC PLANNING SERVICES CONCERNING MONETARY DONATIONS (U.S. CLS. 100, 101 AND 102).
NAAKWAMA ANKRAH, EXAMINING ATTORNEY

SN 77-164,291. AMERICAN DIABETES ASSOCIATION, INC., ALEXANDRIA, VA. FILED 4-24-2007.



NO CLAIM IS MADE TO THE EXCLUSIVE RIGHT TO USE "DIABETES", APART FROM THE MARK AS SHOWN. THE MARK CONSISTS OF STEP UP TO FIGHT DIABETES AND DESIGN.

FOR CHARITABLE FUND RAISING (U.S. CLS. 100, 101 AND 102).

FIRST USE 4-2-2007; IN COMMERCE 4-2-2007.
CAROLINE WOOD, EXAMINING ATTORNEY

SN 77-165,414. PREMIER FEDERAL CREDIT UNION, GREENSBORO, NC. FILED 4-25-2007.

**THE PREMIER DIFFERENCE . .
. EXPERIENCE IT**

THE MARK CONSISTS OF STANDARD CHARACTERS WITHOUT CLAIM TO ANY PARTICULAR FONT, STYLE, SIZE, OR COLOR.

FOR CREDIT UNION SERVICES (U.S. CLS. 100, 101 AND 102).

MELVIN AXILBUND, EXAMINING ATTORNEY

CLASS 36—(Continued).

SN 77-166,772. VLOAN, LLC, STRONGSVILLE, OH. FILED 4-26-2007.

VLOAN

THE MARK CONSISTS OF STANDARD CHARACTERS WITHOUT CLAIM TO ANY PARTICULAR FONT, STYLE, SIZE, OR COLOR.

FOR MORTGAGE SERVICES, NAMELY, LOAN ORIGINATION SERVICES; HOME FINANCING SERVICES (U.S. CLS. 100, 101 AND 102).

FIRST USE 1-31-2005; IN COMMERCE 4-23-2007.

HEATHER BIDDULPH, EXAMINING ATTORNEY

SN 77-176,633. AMERICAN EXPRESS MARKETING & DEVELOPMENT CORP., NEW YORK, NY. FILED 5-9-2007.

LIFE IS WORTH SAVING FOR

THE MARK CONSISTS OF STANDARD CHARACTERS WITHOUT CLAIM TO ANY PARTICULAR FONT, STYLE, SIZE, OR COLOR.

FOR CREDIT CARD SERVICES (U.S. CLS. 100, 101 AND 102).

DORITT L. CARROLL, EXAMINING ATTORNEY

SN 77-177,582. THE PATY GROUP, INC., CLEARWATER, FL. FILED 5-10-2007.



NO CLAIM IS MADE TO THE EXCLUSIVE RIGHT TO USE "GROUP", APART FROM THE MARK AS SHOWN.

FOR DEBT COUNSELING SERVICES; CONSUMER CREDIT CONSULTATION; CREDIT AND FINANCIAL CONSULTATION; CREDIT CONSULTATION; CREDIT INQUIRY AND CONSULTATION; DEBT MANAGEMENT CONSULTATION; FINANCIAL ANALYSIS AND CONSULTATION (U.S. CLS. 100, 101 AND 102).

FIRST USE 1-2-2006; IN COMMERCE 1-2-2006.

NICHOLAS ALTREE, EXAMINING ATTORNEY

CLASS 36—(Continued).

SN 77-177,918. FARMERS GROUP, INC., LOS ANGELES, CA. FILED 5-10-2007.

CHOICES

THE MARK CONSISTS OF STANDARD CHARACTERS WITHOUT CLAIM TO ANY PARTICULAR FONT, STYLE, SIZE, OR COLOR.

FOR INSURANCE SERVICES, NAMELY, UNDERWRITING, INSURANCE ADMINISTRATION, CLAIMS ADMINISTRATION, AND AGENCY SERVICES; AND PROVIDING INFORMATION ABOUT INSURANCE AND UNDERWRITING SERVICES VIA THE INTERNET (U.S. CLS. 100, 101 AND 102).

REGINA DRUMMOND, EXAMINING ATTORNEY

SN 77-179,324. ECHELON RESORTS CORPORATION, LAS VEGAS, NV. FILED 5-11-2007.

HIGH STREET

THE MARK CONSISTS OF STANDARD CHARACTERS WITHOUT CLAIM TO ANY PARTICULAR FONT, STYLE, SIZE, OR COLOR.

FOR BUILDING MANAGEMENT; LEASING OF SHOPPING MALL SPACE; REAL ESTATE MANAGEMENT (U.S. CLS. 100, 101 AND 102).

KATHLEEN M. VANSTON, EXAMINING ATTORNEY

SN 77-179,818. LIVE GREEN, LIVE SMART, LLC, WAYZATA, MN. FILED 5-14-2007.

Carbon Karma

THE MARK CONSISTS OF STANDARD CHARACTERS WITHOUT CLAIM TO ANY PARTICULAR FONT, STYLE, SIZE, OR COLOR.

NO CLAIM IS MADE TO THE EXCLUSIVE RIGHT TO USE "CARBON", APART FROM THE MARK AS SHOWN.

FOR COMMODITY EXCHANGE SERVICES, NAMELY, EXCHANGE OF CARBON CREDITS FOR THE PURPOSES OF REDUCING CARBON EMISSIONS (U.S. CLS. 100, 101 AND 102).

FIRST USE 4-22-2007; IN COMMERCE 4-22-2007.
ANTHONY RINKER, EXAMINING ATTORNEY

CLASS 36—(Continued).

SN 77-181,942. CREAATIVE OUTSOURCE SOLUTIONS, INC., ROSEVILLE, CA. FILED 5-15-2007.



NO CLAIM IS MADE TO THE EXCLUSIVE RIGHT TO USE "OUTSOURCE SOLUTIONS, INC.", APART FROM THE MARK AS SHOWN.

THE COLOR(S) GREEN, DARK GREEN, BLUE, DARK BLUE, BLACK AND WHITE IS/ARE CLAIMED AS A FEATURE OF THE MARK.

THE MARK CONSISTS OF FIVE LINKED RINGS IN THE COLORS GREEN, DARK GREEN, BLACK, BLUE, AND DARK BLUE. THE RINGS ARE LINED IN BLACK AND THE LINKS CONNECT IN THE COLOR WHITE. THE COLOR BLACK APPEARS ON THE WORDING "CREATIVE OUTSOURCE SOLUTIONS, INC".

FOR FINANCIAL CONSULTATION IN THE FIELD OF INSURANCE; FINANCIAL EVALUATION FOR INSURANCE PURPOSES; INSURANCE ADMINISTRATION IN THE FIELD OF COMMERCIAL INSURANCE (U.S. CLS. 100, 101 AND 102).

FIRST USE 5-1-2007; IN COMMERCE 5-1-2007.
SANDRA MANIOS, EXAMINING ATTORNEY

SN 77-184,719. AMERICAN INTERNATIONAL GROUP, INC., NEW YORK, NY. FILED 5-18-2007.

AIG VALIC PREMIERE 5

THE MARK CONSISTS OF STANDARD CHARACTERS WITHOUT CLAIM TO ANY PARTICULAR FONT, STYLE, SIZE, OR COLOR.

OWNER OF U.S. REG. NOS. 3,083,895, 3,105,289 AND OTHERS.

FOR ANNUITY UNDERWRITING; ISSUANCE AND ADMINISTRATION OF ANNUITIES (U.S. CLS. 100, 101 AND 102).

FIRST USE 2-1-2006; IN COMMERCE 2-1-2006.
BRIDGETT SMITH, EXAMINING ATTORNEY

SN 77-184,734. AMERICAN INTERNATIONAL GROUP, INC., NEW YORK, NY. FILED 5-18-2007.

AIG VALIC PREMIERE 7

THE MARK CONSISTS OF STANDARD CHARACTERS WITHOUT CLAIM TO ANY PARTICULAR FONT, STYLE, SIZE, OR COLOR.

OWNER OF U.S. REG. NOS. 3,083,895, 3,105,289 AND OTHERS.

FOR ANNUITY UNDERWRITING; ISSUANCE AND ADMINISTRATION OF ANNUITIES (U.S. CLS. 100, 101 AND 102).

FIRST USE 5-1-2006; IN COMMERCE 5-1-2006.
BRIDGETT SMITH, EXAMINING ATTORNEY

CLASS 36—(Continued).

SN 77-185,174. GRANITE CREEK PARTNERS, L.L.C., CHICAGO, IL. FILED 5-18-2007.

GRANITE CREEK

THE MARK CONSISTS OF STANDARD CHARACTERS WITHOUT CLAIM TO ANY PARTICULAR FONT, STYLE, SIZE, OR COLOR.

FOR FINANCIAL INVESTMENT IN THE FIELD OF CONTROL EQUITY INVESTMENTS, MINORITY EQUITY INVESTMENTS, MEZZANINE DEBT, SENIOR SECURED DEBT AND EQUITY DERIVATIVES; MANAGEMENT OF PRIVATE EQUITY FUNDS; PRIVATE EQUITY FUND INVESTMENT SERVICES (U.S. CLS. 100, 101 AND 102).

FIRST USE 3-2-2006; IN COMMERCE 3-2-2006.
ALEXANDER L. POWERS, EXAMINING ATTORNEY

SN 77-186,096. PERSPECTA TRUST LLC, HAMPTON, NH. FILED 5-21-2007.

NEW HAMPSHIRE ADVANTAGE

THE MARK CONSISTS OF STANDARD CHARACTERS WITHOUT CLAIM TO ANY PARTICULAR FONT, STYLE, SIZE, OR COLOR.

NO CLAIM IS MADE TO THE EXCLUSIVE RIGHT TO USE "NEW HAMPSHIRE", APART FROM THE MARK AS SHOWN.

FOR TRUST SERVICES, NAMELY, INVESTMENT AND TRUST COMPANY SERVICES; FINANCIAL TRUST OPERATIONS; TRUST MANAGEMENT ACCOUNTS; WEALTH MANAGEMENT ADVISORY SERVICES; INVESTMENT MANAGEMENT SERVICES; TRUST AND ESTATE PLANNING; FINANCIAL PLANNING; FAMILY FIDUCIARY SERVICES ADMINISTRATION; AND TRUST MANAGEMENT STRATEGY SERVICES (U.S. CLS. 100, 101 AND 102).

KATHERINE CHANG, EXAMINING ATTORNEY

SN 77-187,044. NORTH AMERICAN COMPANY FOR LIFE AND HEALTH INSURANCE, CHICAGO, IL. FILED 5-22-2007.

BUILDER IUL

THE MARK CONSISTS OF STANDARD CHARACTERS WITHOUT CLAIM TO ANY PARTICULAR FONT, STYLE, SIZE, OR COLOR.

OWNER OF U.S. REG. NOS. 2,739,122 AND 2,881,462.

NO CLAIM IS MADE TO THE EXCLUSIVE RIGHT TO USE "IUL", APART FROM THE MARK AS SHOWN.

FOR LIFE INSURANCE UNDERWRITING (U.S. CLS. 100, 101 AND 102).

FIRST USE 7-16-2007; IN COMMERCE 7-16-2007.
LA TONIA FISHER, EXAMINING ATTORNEY

CLASS 36—(Continued).

SN 77-187,224. NATIONAL MULTIPLE SCLEROSIS SOCIETY, NEW YORK, NY. FILED 5-22-2007.

MS FLY

THE MARK CONSISTS OF STANDARD CHARACTERS WITHOUT CLAIM TO ANY PARTICULAR FONT, STYLE, SIZE, OR COLOR.

NO CLAIM IS MADE TO THE EXCLUSIVE RIGHT TO USE "MS", APART FROM THE MARK AS SHOWN.

FOR CHARITABLE FUND RAISING SERVICES (U.S. CLS. 100, 101 AND 102).

FIRST USE 4-18-2007; IN COMMERCE 4-22-2007.
CARRIE GENOVESE, EXAMINING ATTORNEY

SN 77-188,557. CARMAX BUSINESS SERVICES, LLC, RICHMOND, VA. FILED 5-23-2007.

CARMAX CARES

THE MARK CONSISTS OF STANDARD CHARACTERS WITHOUT CLAIM TO ANY PARTICULAR FONT, STYLE, SIZE, OR COLOR.

OWNER OF U.S. REG. NOS. 3,082,847, 3,087,576 AND OTHERS.

FOR CHARITABLE FUNDRAISING AND CHARITABLE SERVICES, NAMELY, PROVIDING GRANTS AND DONATIONS TO NON-PROFIT ORGANIZATIONS (U.S. CLS. 100, 101 AND 102).

FIRST USE 10-0-2004; IN COMMERCE 10-0-2004.
CAROLYN CATALDO, EXAMINING ATTORNEY

SN 77-190,784. BRIDGER COMMERCIAL FUNDING LLC, MILL VALLEY, CA. FILED 5-25-2007.

BRIDGERDOCS

THE MARK CONSISTS OF STANDARD CHARACTERS WITHOUT CLAIM TO ANY PARTICULAR FONT, STYLE, SIZE, OR COLOR.

FOR PROVIDING AN ONLINE DATABASE OF COMMERCIAL REAL ESTATE TRANSACTION AND LOAN DOCUMENTS AND TEMPLATES (U.S. CLS. 100, 101 AND 102).

FIRST USE 11-30-2000; IN COMMERCE 11-30-2000.
CHRISTINA SOBRAL, EXAMINING ATTORNEY

CLASS 36—(Continued).

SN 77-196,528. AMERICAN INTERNATIONAL GROUP, INC., NEW YORK, NY. FILED 6-4-2007.

VISIONMAXIMIZER

THE MARK CONSISTS OF STANDARD CHARACTERS WITHOUT CLAIM TO ANY PARTICULAR FONT, STYLE, SIZE, OR COLOR.

FOR ANNUITY UNDERWRITING; ISSUANCE AND ADMINISTRATION OF ANNUITIES (U.S. CLS. 100, 101 AND 102).

BRIDGETT SMITH, EXAMINING ATTORNEY

CLASS 36—(Continued).

SN 77-198,229. CLAYMORE SECURITIES, INC., LISLE, IL. FILED 6-5-2007.

ACCESS TO INNOVATION

THE MARK CONSISTS OF STANDARD CHARACTERS WITHOUT CLAIM TO ANY PARTICULAR FONT, STYLE, SIZE, OR COLOR.

FOR INVESTMENT ADVISORY SERVICES; SECURITIES BROKERAGE SERVICES; EXCHANGE-TRADED FUND BROKERAGE, DISTRIBUTION AND INVESTMENT SERVICES; RESEARCH SERVICES IN THE FIELD OF INVESTMENTS (U.S. CLS. 100, 101 AND 102).
WILLIAM VERHOSEK, EXAMINING ATTORNEY

SN 77-196,535. AMERICAN INTERNATIONAL GROUP, INC., NEW YORK, NY. FILED 6-4-2007.

VISIONENHANCER

THE MARK CONSISTS OF STANDARD CHARACTERS WITHOUT CLAIM TO ANY PARTICULAR FONT, STYLE, SIZE, OR COLOR.

FOR ANNUITY UNDERWRITING; ISSUANCE AND ADMINISTRATION OF ANNUITIES (U.S. CLS. 100, 101 AND 102).

BRIDGETT SMITH, EXAMINING ATTORNEY

SN 77-206,484. MORGAN STANLEY, NEW YORK, NY. FILED 6-14-2007.

SARV

THE MARK CONSISTS OF STANDARD CHARACTERS WITHOUT CLAIM TO ANY PARTICULAR FONT, STYLE, SIZE, OR COLOR.

FOR FINANCIAL SERVICES IN THE NATURE OF TRADING, BROKERING, AND STRUCTURING INVESTMENT SECURITIES, AND ADVISORY SERVICES RELATING THERETO (U.S. CLS. 100, 101 AND 102).

MICHELLE DUBOIS, EXAMINING ATTORNEY

SN 77-196,824. AXA EQUITABLE LIFE INSURANCE COMPANY, NEW YORK, NY. FILED 6-4-2007.

STYLUS

THE MARK CONSISTS OF STANDARD CHARACTERS WITHOUT CLAIM TO ANY PARTICULAR FONT, STYLE, SIZE, OR COLOR.

FOR ADMINISTRATION OF INDIVIDUAL DEFERRED VARIABLE ANNUITIES (U.S. CLS. 100, 101 AND 102).

FIRST USE 3-5-2007; IN COMMERCE 3-5-2007.
KRISTIN DAHLING, EXAMINING ATTORNEY

SN 77-209,086. APOLLO GROUP, INC., PHOENIX, AZ. FILED 6-18-2007.

FIRST CHANCE

THE MARK CONSISTS OF STANDARD CHARACTERS WITHOUT CLAIM TO ANY PARTICULAR FONT, STYLE, SIZE, OR COLOR.

FOR FINANCIAL SERVICES, NAMELY, PROVIDING EDUCATIONAL SCHOLARSHIPS AT THE POST-SECONDARY LEVEL (U.S. CLS. 100, 101 AND 102).

FIRST USE 10-25-2006; IN COMMERCE 10-25-2006.
PRISCILLA MILTON, EXAMINING ATTORNEY

CLASS 36—(Continued).

SN 77-211,189. ONECALIFORNIA BANK FSB, SAN FRANCISCO, CA. FILED 6-20-2007.

BUSINESSVIEW

THE MARK CONSISTS OF STANDARD CHARACTERS WITHOUT CLAIM TO ANY PARTICULAR FONT, STYLE, SIZE, OR COLOR.

FOR BANKING SERVICES CONSISTING OF A SYSTEM OF CHECK PROCESSING ENABLING CUSTOMERS TO DEPOSIT CHECKS INTO THE BANK ELECTRONICALLY AS IMAGED FILES (U.S. CLS. 100, 101 AND 102).

KEVIN DINALLO, EXAMINING ATTORNEY

SN 77-216,410. SMITH, DAMON E., FLATTS, BERMUDA, FILED 6-27-2007.



THE MARK CONSISTS OF LETTERS D, E AND S WITH A SWOOSH THROUGH THE CENTER OF THE MARK.

FOR ELECTRONIC PAYMENT, NAMELY, ELECTRONIC PROCESSING AND TRANSMISSION OF BILL PAYMENT DATA; PRE-PAID PURCHASE CARD SERVICES, NAMELY, PROCESSING ELECTRONIC PAYMENTS MADE THROUGH PREPAID CARDS; PRE-PAID PURCHASE CARD SERVICES, NAMELY, PROCESSING ELECTRONIC PAYMENTS THROUGH PRE-PAID CARDS; PROVIDING ELECTRONIC PROCESSING OF CREDIT CARD TRANSACTIONS AND ELECTRONIC PAYMENTS VIA A GLOBAL COMPUTER NETWORK; TRAVELERS' CHECK ISSUANCE (U.S. CLS. 100, 101 AND 102).

RONALD AIKENS, EXAMINING ATTORNEY

SN 77-221,344. CITY NATIONAL BANK, BEVERLY HILLS, CA. FILED 7-3-2007.

READING IS THE WAY UP

THE MARK CONSISTS OF STANDARD CHARACTERS WITHOUT CLAIM TO ANY PARTICULAR FONT, STYLE, SIZE, OR COLOR.

OWNER OF U.S. REG. NO. 2,207,701.
FOR CHARITABLE FUNDRAISING (U.S. CLS. 100, 101 AND 102).

FIRST USE 0-0-2002; IN COMMERCE 0-0-2002.
BRENDAN REGAN, EXAMINING ATTORNEY

CLASS 36—(Continued).

SN 77-239,675. AMERICAN INTERNATIONAL GROUP, INC., NEW YORK, NY. FILED 7-26-2007.

AIG VISIONENHANCER

THE MARK CONSISTS OF STANDARD CHARACTERS WITHOUT CLAIM TO ANY PARTICULAR FONT, STYLE, SIZE, OR COLOR.

OWNER OF U.S. REG. NOS. 1,151,229, 1,273,845 AND OTHERS.

FOR ANNUITY UNDERWRITING; ISSUANCE AND ADMINISTRATION OF ANNUITIES (U.S. CLS. 100, 101 AND 102).

BRIDGETT SMITH, EXAMINING ATTORNEY

SN 77-239,691. AMERICAN INTERNATIONAL GROUP, INC., NEW YORK, NY. FILED 7-26-2007.

AIG VISIONMAXIMIZER

THE MARK CONSISTS OF STANDARD CHARACTERS WITHOUT CLAIM TO ANY PARTICULAR FONT, STYLE, SIZE, OR COLOR.

OWNER OF U.S. REG. NOS. 1,151,229, 1,273,845 AND OTHERS.

FOR ANNUITY UNDERWRITING; ISSUANCE AND ADMINISTRATION OF ANNUITIES (U.S. CLS. 100, 101 AND 102).

BRIDGETT SMITH, EXAMINING ATTORNEY

SN 78-043,508. FMR CORP., BOSTON, MA. FILED 1-17-2001.

FIDELITY ANYWHERE

OWNER OF U.S. REG. NOS. 1,277,373, 1,278,300 AND OTHERS.

FOR FINANCIAL SERVICES, NAMELY, PROVIDING PERSONALIZED INVESTMENT INFORMATION, ACCOUNT MANAGEMENT AND SECURITIES BROKERAGE SERVICES, ALL BY MEANS OF WIRELESS COMMUNICATION DEVICES (U.S. CLS. 100, 101 AND 102).

IRENE D. WILLIAMS, EXAMINING ATTORNEY

CLASS 36—(Continued).

SN 78-213,737. FMR CORP., BOSTON, MA. FILED 2-12-2003.

**FIDELITY CAPITAL
INVESTORS**

OWNER OF U.S. REG. NOS. 1,277,373, 1,481,037 AND OTHERS.

NO CLAIM IS MADE TO THE EXCLUSIVE RIGHT TO USE "CAPITAL INVESTORS", APART FROM THE MARK AS SHOWN.

FOR FINANCIAL SERVICES, NAMELY, FINANCIAL ADVISORY SERVICES IN THE FIELD OF LEVERAGED BUYOUTS; LEVERAGED BUYOUT STRUCTURING AND FINANCING; MANAGEMENT OF INVESTMENT FUNDS IN THE FIELD OF LEVERAGED BUYOUTS; INVESTMENT MANAGEMENT; PRIVATE EQUITY INVESTMENT (U.S. CLS. 100, 101 AND 102).

ELISSA GARBER KON, EXAMINING ATTORNEY

SN 78-630,521. CREDEXX CORPORATION, IRVINE, CA. FILED 5-16-2005.

CREDEXX

THE MARK CONSISTS OF STANDARD CHARACTERS WITHOUT CLAIM TO ANY PARTICULAR FONT, STYLE, SIZE, OR COLOR.

FOR ADVISING LENDERS WITH REGARD TO A CREDIT CARD INTEREST RATE EXCHANGE AND REDUCTION PROGRAM TO BE OFFERED TO HOLDERS OF RELATIVELY HIGH CREDIT CARD DEBT (U.S. CLS. 100, 101 AND 102).

CURTIS FRENCH, EXAMINING ATTORNEY

SN 78-632,138. OCMP, INC., BROOKLINE, MA. FILED 5-18-2005.

OCMP Off-Campus Meal Plan

THE MARK CONSISTS OF STANDARD CHARACTERS WITHOUT CLAIM TO ANY PARTICULAR FONT, STYLE, SIZE, OR COLOR.

NO CLAIM IS MADE TO THE EXCLUSIVE RIGHT TO USE "OFF-CAMPUS MEAL PLAN", APART FROM THE MARK AS SHOWN.

FOR FINANCIAL SERVICES, NAMELY, PROVIDING DECLINING BALANCE CARD SERVICES USED IN CONNECTION WITH MEAL SERVICES, PROVIDING PROCESSING SERVICES USED IN CONNECTION WITH PREPAID CARDS AND TRANSACTIONS, PROVIDING TRANSACTION AUTHORIZATION AND SETTLEMENT SERVICES, AND PROVIDING ADVISORY SERVICES RELATED TO THE AFORESAID SERVICES (U.S. CLS. 100, 101 AND 102).

FIRST USE 9-30-1995; IN COMMERCE 5-30-2000.
DOMINICK J. SALEMI, EXAMINING ATTORNEY**CLASS 36—(Continued).**

SN 78-669,169. FIRST FREEDOM BANK, LEBANON, TN. FILED 7-13-2005.



NO CLAIM IS MADE TO THE EXCLUSIVE RIGHT TO USE "TRUST", APART FROM THE MARK AS SHOWN.

THE COLOR(S) RED, BLUE AND WHITE IS/ARE CLAIMED AS A FEATURE OF THE MARK

THE MARK CONSISTS OF THE WORDS "FIRST FREEDOM TRUST" IN BLUE, WITH A BLUE STAR ON THE RIGHT SIDE OF THE WORD "FIRST". RED AND WHITE STRIPES BESIDE THE STAR RESEMBLING A STYLIZED WAVING FLAG, AND A RED LINE UNDER A PORTION OF THE WORD "FREEDOM".

FOR BANKING; FINANCIAL SERVICES, NAMELY, CREDIT AND FINANCIAL CONSULTATION, FINANCIAL DUE DILIGENCE, FINANCIAL EVALUATION FOR INSURANCE PURPOSES, FINANCIAL EXCHANGE, FINANCIAL GUARANTEE AND SURETY, PROVIDING FINANCIAL INFORMATION IN THE NATURE OF RATES OF EXCHANGE, FINANCIAL SERVICES FOR THE PURCHASE OF SAVINGS BONDS, FINANCIAL ANALYSIS AND CONSULTATION, FINANCIAL INFORMATION PROVIDED BY ELECTRONIC MEANS, FINANCIAL LOAN CONSULTATION, FINANCIAL MANAGEMENT, FINANCIAL PLANNING, FINANCIAL PORTFOLIO MANAGEMENT, FINANCIAL SERVICES IN THE FIELD OF MONEY-LENDING, PROVIDING ON-LINE STORED VALUE ACCOUNTS IN AN ELECTRONIC ENVIRONMENT, INVESTMENT FUND TRANSFER AND TRANSACTION SERVICES, ASSISTING OTHERS WITH THE COMPLETION OF FINANCIAL TRANSACTIONS FOR STOCKS, BONDS, SECURITIES AND EQUITIES, SAVINGS PROGRAMS FOR YOUTHS, A TOTAL PORTFOLIO OFFERING FOR HIGH NET WORTH CLIENTS CONSISTING OF BOTH SEPARATE ACCOUNTS AND MUTUAL FUNDS FOR EQUITY AND FIXED INCOME INVESTMENTS, THE PURCHASE OF RESIDENTIAL MORTGAGES ON BEHALF OF OTHERS AND THE ISSUANCE OF MORTGAGE-BACKED SECURITIES, FINANCIAL SPONSORSHIP OF VARIOUS CHARITABLE AND NON-PROFIT COMMUNITY EVENTS AND ACTIVITIES, FINANCIAL TRUST OPERATIONS, AND PROVIDING ON-LINE FINANCIAL CALCULATORS (U.S. CLS. 100, 101 AND 102).

JORDAN BAKER, EXAMINING ATTORNEY

SN 78-707,505. PAY RENT, BUILD CREDIT, INC., ANNAPO- LIS, MD. FILED 9-6-2005.

Bill Payment Score

THE MARK CONSISTS OF STANDARD CHARACTERS WITHOUT CLAIM TO ANY PARTICULAR FONT, STYLE, SIZE, OR COLOR.

NO CLAIM IS MADE TO THE EXCLUSIVE RIGHT TO USE "SCORE", APART FROM THE MARK AS SHOWN.

FOR CREDIT BUREAUS (U.S. CLS. 100, 101 AND 102).
FIRST USE 6-2-2004; IN COMMERCE 6-2-2004.
STEPHANIE ALI, EXAMINING ATTORNEY

CLASS 36—(Continued).

SN 78-715,087. BATON ROUGE AREA FOUNDATION, BATON ROUGE, LA. FILED 9-16-2005.

BRAF

THE MARK CONSISTS OF STANDARD CHARACTERS WITHOUT CLAIM TO ANY PARTICULAR FONT, STYLE, SIZE, OR COLOR.

FOR ACCEPTING AND ADMINISTERING MONETARY CHARITABLE CONTRIBUTIONS; CHARITABLE FUNDRAISING; CHARITABLE FUNDRAISING RELATING TO COMMUNITY DEVELOPMENT, ARTS AND HUMANITIES, EDUCATION, THE ENVIRONMENT, HUMAN SERVICES, MEDICAL AND HEALTH NEEDS AND RELIGION (U.S. CLS. 100, 101 AND 102).

FIRST USE 9-13-1998; IN COMMERCE 9-13-1998.
DEZMONA MIZELLE, EXAMINING ATTORNEY

SN 78-757,378. CAPITAL ACCESS NETWORK, INC., SCARSDALE, NY. FILED 11-18-2005.

AMI MERCHANT SOLUTIONS

THE MARK CONSISTS OF STANDARD CHARACTERS WITHOUT CLAIM TO ANY PARTICULAR FONT, STYLE, SIZE, OR COLOR.

NO CLAIM IS MADE TO THE EXCLUSIVE RIGHT TO USE "MERCHANT SOLUTIONS", APART FROM THE MARK AS SHOWN.

FOR CREDIT CARD PROCESSING SERVICES; PROVIDING WORKING CAPITAL FOR BUSINESSES (U.S. CLS. 100, 101 AND 102).

CIMMERIAN COLEMAN, EXAMINING ATTORNEY

SN 78-793,015. VIANT HOLDINGS, INC., NAPERVILLE, IL. FILED 1-17-2006.

WHITE SPACE MANAGEMENT

THE MARK CONSISTS OF STANDARD CHARACTERS WITHOUT CLAIM TO ANY PARTICULAR FONT, STYLE, SIZE, OR COLOR.

NO CLAIM IS MADE TO THE EXCLUSIVE RIGHT TO USE "MANAGEMENT", APART FROM THE MARK AS SHOWN.

FOR INSURANCE CLAIMS PROCESSING (U.S. CLS. 100, 101 AND 102).

DAHLIA GEORGE, EXAMINING ATTORNEY

CLASS 36—(Continued).

SN 78-827,810. METROPOLITAN LIFE INSURANCE COMPANY, LONG ISLAND CITY, NY. FILED 3-2-2006.

METLIFE 2045

THE MARK CONSISTS OF STANDARD CHARACTERS WITHOUT CLAIM TO ANY PARTICULAR FONT, STYLE, SIZE, OR COLOR.

NO CLAIM IS MADE TO THE EXCLUSIVE RIGHT TO USE "2045", APART FROM THE MARK AS SHOWN.

FOR INSURANCE UNDERWRITING, BROKERAGE AND ADMINISTRATION SERVICES FOR RETIREMENT PLANS, INVESTMENT MANAGEMENT SERVICES AND DEFINED CONTRIBUTION PLANS. (U.S. CLS. 100, 101 AND 102).

CAROLYN GRAY, EXAMINING ATTORNEY

SN 78-854,097. NATIONAL CANCER COALITION, INC., NEW ORLEANS, LA. FILED 4-5-2006.

NCC Angel Grants

THE MARK CONSISTS OF STANDARD CHARACTERS WITHOUT CLAIM TO ANY PARTICULAR FONT, STYLE, SIZE, OR COLOR.

NO CLAIM IS MADE TO THE EXCLUSIVE RIGHT TO USE "GRANTS", APART FROM THE MARK AS SHOWN.

FOR CHARITABLE FUNDRAISING SERVICES AND ACCEPTING AND ADMINISTERING MONETARY CHARITABLE CONTRIBUTIONS FOR PEDIATRIC CANCER RESEARCH AND TREATMENT (U.S. CLS. 100, 101 AND 102).

FIRST USE 12-1-2001; IN COMMERCE 12-1-2001.

DOMINIC J. FERRAIUOLO, EXAMINING ATTORNEY

SN 78-854,106. NATIONAL CANCER COALITION, INC., NEW ORLEANS, LA. FILED 4-5-2006.

Angel Grants

THE MARK CONSISTS OF STANDARD CHARACTERS WITHOUT CLAIM TO ANY PARTICULAR FONT, STYLE, SIZE, OR COLOR.

NO CLAIM IS MADE TO THE EXCLUSIVE RIGHT TO USE "GRANTS", APART FROM THE MARK AS SHOWN.

FOR CHARITABLE FUNDRAISING SERVICES AND ACCEPTING AND ADMINISTERING MONETARY CHARITABLE CONTRIBUTIONS FOR PEDIATRIC CANCER RESEARCH AND TREATMENT (U.S. CLS. 100, 101 AND 102).

FIRST USE 12-1-2001; IN COMMERCE 12-1-2001.

DOMINIC J. FERRAIUOLO, EXAMINING ATTORNEY

CLASS 36—(Continued).

SN 78-865,098. BLOOMBERG L.P., NEW YORK, NY. FILED 4-19-2006.

BLOCK HUNTER

THE MARK CONSISTS OF STANDARD CHARACTERS WITHOUT CLAIM TO ANY PARTICULAR FONT, STYLE, SIZE, OR COLOR.

NO CLAIM IS MADE TO THE EXCLUSIVE RIGHT TO USE "BLOCK", APART FROM THE MARK AS SHOWN.

FOR FINANCIAL SERVICES IN THE NATURE OF PROVIDING A SECURITIES TRADING SYSTEM; ELECTRONICALLY PROVIDING THE SERVICES OF A SECURITIES TRADING BROKER; OBJECTIVELY RATING SECURITIES; FINANCIAL SERVICES IN THE NATURE OF PROVIDING AN ALGORITHMIC TRADING STRATEGY; INFORMATION SERVICES RELATING TO FINANCE AND FINANCIAL NEWS (U.S. CLS. 100, 101 AND 102).

JOHN DALIER, EXAMINING ATTORNEY

SN 78-872,359. SULLIVAN, MARGIE, NEW YORK, NY. FILED 4-28-2006.

Maggie Sky Foundation

THE MARK CONSISTS OF STANDARD CHARACTERS WITHOUT CLAIM TO ANY PARTICULAR FONT, STYLE, SIZE, OR COLOR.

NO CLAIM IS MADE TO THE EXCLUSIVE RIGHT TO USE "FOUNDATION", APART FROM THE MARK AS SHOWN.

FOR CHARITABLE FUND RAISING (U.S. CLS. 100, 101 AND 102).

G. MAYERSCHOFF, EXAMINING ATTORNEY

CLASS 36—(Continued).

SN 78-890,401. THE COMMERCIAL CAPITAL CORPORATION, TORONTO, ONTARIO, CANADA, FILED 5-23-2006.



OWNER OF CANADA REG. NO. TMA687393, DATED 5-9-2007, EXPIRES 5-9-2022.

FOR FINANCIAL SERVICES, NAMELY, COMMERCIAL LENDING SERVICES, INVESTMENT BANKING SERVICES AND EQUITY CAPITAL INVESTMENT SERVICES; FINANCIAL CONSULTATION; INVESTMENT CONSULTATION (U.S. CLS. 100, 101 AND 102).

JULIE GUTTADAURO, EXAMINING ATTORNEY

SN 78-896,596. NATIONAL CHRISTIAN CHARITABLE FOUNDATION, INC., ATLANTA, GA. FILED 5-31-2006.

THE NATIONAL CHRISTIAN FOUNDATION

THE MARK CONSISTS OF STANDARD CHARACTERS WITHOUT CLAIM TO ANY PARTICULAR FONT, STYLE, SIZE, OR COLOR.

NO CLAIM IS MADE TO THE EXCLUSIVE RIGHT TO USE "FOUNDATION", APART FROM THE MARK AS SHOWN.

SEC. 2(F).

FOR CHARITABLE FUND RAISING SERVICES; DONOR-ADVISED INVESTMENT OF FUNDS FOR CHARITABLE PURPOSES; CHARITABLE FUND MANAGEMENT, NAMELY, ACCEPTING AND ADMINISTERING MONETARY CHARITABLE CONTRIBUTIONS; RAISING AND DISTRIBUTING CHARITABLE FUNDS; MANAGING DONOR-ADVISED FUNDS FOR CHARITABLE PURPOSES; MANAGING ENDOWMENT FUNDS FOR CHARITABLE PURPOSES; ADMINISTRATION OF PRIVATE FOUNDATIONS IN CONNECTION WITH PHILANTHROPIC CONTRIBUTIONS FOR CHARITABLE PURPOSES; FINANCIAL CONSULTATION, NAMELY, INVESTMENT CONSULTING IN THE FIELD OF DONOR-ADVISED FUNDS AND PHILANTHROPIC CONTRIBUTIONS FOR CHARITABLE PURPOSES; PROVIDING INFORMATION IN THE FIELDS OF DONOR-ADVISED FUNDS FOR CHARITABLE PURPOSES, PHILANTHROPIC CONTRIBUTIONS FOR CHARITABLE PURPOSES, AND CHARITABLE FUND MANAGEMENT, NAMELY, ACCEPTING AND ADMINISTERING MONETARY CHARITABLE CONTRIBUTIONS (U.S. CLS. 100, 101 AND 102).

FIRST USE 7-0-2001; IN COMMERCE 7-0-2001.

WILLIAM ROSSMAN, EXAMINING ATTORNEY

CLASS 36—(Continued).

SN 78-896,613. NATIONAL CHRISTIAN CHARITABLE FOUNDATION, INC., ATLANTA, GA. FILED 5-31-2006.



FOR CHARITABLE FUND RAISING SERVICES; DONOR-ADVISED INVESTMENT OF FUNDS FOR CHARITABLE PURPOSES; CHARITABLE FUND MANAGEMENT, NAMELY, ACCEPTING AND ADMINISTERING MONETARY CHARITABLE CONTRIBUTIONS; RAISING AND DISTRIBUTING CHARITABLE FUNDS; MANAGING DONOR-ADVISED FUNDS FOR CHARITABLE PURPOSES; MANAGING ENDOWMENT FUNDS FOR CHARITABLE PURPOSES; PROVIDING ADMINISTRATIVE SERVICES FOR PRIVATE FOUNDATIONS IN CONNECTION WITH PHILANTHROPIC CONTRIBUTIONS FOR CHARITABLE PURPOSES; FINANCIAL CONSULTATION, NAMELY, INVESTMENT CONSULTING IN THE FIELD OF DONOR-ADVISED FUNDS AND PHILANTHROPIC CONTRIBUTIONS FOR CHARITABLE PURPOSES; PROVIDING INFORMATION IN THE FIELDS OF DONOR-ADVISED FUNDS FOR CHARITABLE PURPOSES, PHILANTHROPIC CONTRIBUTIONS FOR CHARITABLE PURPOSES, AND CHARITABLE FUND MANAGEMENT, NAMELY, ACCEPTING AND ADMINISTERING MONETARY CHARITABLE CONTRIBUTIONS (U.S. CLS. 100, 101 AND 102).

FIRST USE 7-0-2001; IN COMMERCE 7-0-2001.
WILLIAM ROSSMAN, EXAMINING ATTORNEY

SN 78-912,437. INTERNATIONAL FINANCIAL GROUP, INC., HARTFORD, CT. FILED 6-20-2006.



NO CLAIM IS MADE TO THE EXCLUSIVE RIGHT TO USE "WEB MANUAL", APART FROM THE MARK AS SHOWN.

FOR WEB-BASED PROPERTY INSURANCE INFORMATION SERVICES FOR INSURANCE AGENTS AND BROKERS AND OTHER INSURANCE PROFESSIONALS; INSURANCE SERVICES, NAMELY, BROKERAGE, UNDERWRITING, AGENCY, AND ADMINISTRATION IN THE FIELDS OF PRIMARY GENERAL LIABILITY, PRODUCT LIABILITY, UMBRELLA AND EXCESS LIABILITY, MISCELLANEOUS PROFESSIONAL LIABILITY, REAL ESTATE PROFESSIONAL LIABILITY, EMPLOYMENT PRACTICES LIABILITY, COMMERCIAL GENERAL LIABILITY, TRUCKERS' LIABILITY, GARAGE LIABILITY, SPECIAL EVENTS COVERAGE, FARM LIABILITY, LIQUOR LIABILITY, PACKAGE PROPERTY COVERAGE, AND INLAND MARINE FOR INSURANCE AGENTS AND BROKERS AND OTHER INSURANCE PROFESSIONALS (U.S. CLS. 100, 101 AND 102).

GEOFFREY FOSDICK, EXAMINING ATTORNEY

CLASS 36—(Continued).

SN 78-917,186. JOSEPH NIOSI, JR., UPPER MARLBORO, MD. FILED 6-26-2006.



NO CLAIM IS MADE TO THE EXCLUSIVE RIGHT TO USE "LLC", APART FROM THE MARK AS SHOWN.

THE COLOR(S) RED, WHITE AND BLUE IS/ARE CLAIMED AS A FEATURE OF THE MARK.

THE MARK CONSISTS OF RED GLOBE WITH A DRAWING OF CONTINENTS ON GLOBE THERE ARE BLUE LINES ON PORTIONS OF THE GLOBE THE LETTER "A" IN AMERINET IS RED, THE LETTER "F" IN FINANCIAL IS IN RED THE LETTERS "MERINET" ARE IN BLUE AND THE LETTERS "INANCIAL, LLC" ARE IN BLUE THERE ARE THIN RED LINES BEHIND THE GLOBE AND LETTERING THAT ARE DARKER AT THE TOP AND LIGHTER AT THE BOTTOM.

FOR FINANCIAL SERVICES, NAMELY, THE PURCHASE OF RESIDENTIAL MORTGAGES ON BEHALF OF OTHERS AND THE ISSUANCE OF MORTGAGE-BACKED SECURITIES, MORTGAGE BROKERAGE, MORTGAGE LENDING, MORTGAGE PROCUREMENT FOR OTHERS, MORTGAGES SERVICES, NAMELY, BUYER PRE-QUALIFICATION OF MORTGAGES FOR MORTGAGE BROKERS AND BANKS (U.S. CLS. 100, 101 AND 102).

FIRST USE 2-1-2003; IN COMMERCE 2-1-2003.
CHRISTINA SOBRAL, EXAMINING ATTORNEY

SN 78-930,608. VARSITY GOLD, INC., GILBERT, AZ. FILED 7-17-2006.



THE COLOR(S) RED, WHITE, AND BLUE IS/ARE CLAIMED AS A FEATURE OF THE MARK.

THE COLOR RED APPEARS IN THE TERM "VG2;" THE COLOR WHITE APPEARS AS BORDER AROUND THE TERM "VG2;" AND THE COLOR BLUE APPEARS IN THE OVAL DESIGN.

FOR PROVIDING REBATES AT PARTICIPATING ESTABLISHMENTS OF OTHERS THROUGH USE OF MEMBERSHIP CARDS (U.S. CLS. 100, 101 AND 102).

FIRST USE 1-1-2002; IN COMMERCE 1-1-2002.
LINDA M. KING, EXAMINING ATTORNEY

CLASS 36—(Continued).

SN 78-933,296. BLUESKY MARKETING GROUP, INC., SAN RAMON, CA. FILED 7-19-2006.

BLUESKY AUTO FINANCE

THE MARK CONSISTS OF STANDARD CHARACTERS WITHOUT CLAIM TO ANY PARTICULAR FONT, STYLE, SIZE, OR COLOR.

NO CLAIM IS MADE TO THE EXCLUSIVE RIGHT TO USE "AUTO FINANCE", APART FROM THE MARK AS SHOWN.

FOR FINANCIAL SERVICES, NAMELY, BUSINESS FINANCE PROCUREMENT SERVICES (U.S. CLS. 100, 101 AND 102).

FIRST USE 10-0-2004; IN COMMERCE 4-0-2005.
JAMES LOVELACE, EXAMINING ATTORNEY

SN 78-938,088. WELLINGTON TECHNOLOGY, INC., CROWN, PA. FILED 7-26-2006.

FROM MAIN STREET TO WALL STREET

THE MARK CONSISTS OF STANDARD CHARACTERS WITHOUT CLAIM TO ANY PARTICULAR FONT, STYLE, SIZE, OR COLOR.

FOR LOAN ORIGINATION SERVICES PROVIDED VIA A GLOBAL COMPUTER NETWORK; FINANCIAL CONSULTING SERVICES ASSOCIATED WITH LOAN ORIGINATION SERVICES PROVIDED VIA A GLOBAL NETWORK; PROVIDING FINANCIAL INFORMATION PROVIDED BY ELECTRONIC MEANS TO BROKERS AND END USERS OF THEIR RIGHTS, OBLIGATIONS AND CHOICES REGARDING LOANS (U.S. CLS. 100, 101 AND 102).

ASMAT KHAN, EXAMINING ATTORNEY

SN 78-940,923. DENKMANN SOUTHWEST, L.L.C., ARGYLE, TX. FILED 7-31-2006.

**BARTONVILLE
TOWN CENTER**

NO CLAIM IS MADE TO THE EXCLUSIVE RIGHT TO USE "BARTONVILLE TOWN CENTER", APART FROM THE MARK AS SHOWN.

FOR ASSESSMENT AND MANAGEMENT OF REAL ESTATE; LEASING OF REAL ESTATE; REAL ESTATE ACQUISITION SERVICES; REAL ESTATE BROKERAGE; REAL ESTATE MANAGEMENT (U.S. CLS. 100, 101 AND 102).

FIRST USE 1-1-2003; IN COMMERCE 1-1-2003.
KELLY CHOE, EXAMINING ATTORNEY

CLASS 36—(Continued).

SN 78-953,562. REAL ESTATE CAPITAL PARTNERS, LP, NEW YORK, NY. FILED 8-16-2006.

**Real Estate Capital Partners**

NO CLAIM IS MADE TO THE EXCLUSIVE RIGHT TO USE "REAL ESTATE", APART FROM THE MARK AS SHOWN.

THE MARK CONSISTS OF FOUR SILHOUETTES OF BUILDINGS, TWO ON TWO, WITH HALF OF EACH BUILDING DARK AND THE OTHER LIGHT, ALL WITHIN TWO CONCENTRIC SQUARES, AND THE WORDS REAL ESTATE CAPITAL PARTNERS APPEARING BESIDE THE DESIGN.

SEC. 2(F) AS TO "REAL ESTATE CAPITAL PARTNERS".
FOR ASSESSMENT AND MANAGEMENT OF REAL ESTATE; FINANCIAL INVESTMENT IN THE FIELD OF REAL ESTATE; REAL ESTATE ACQUISITION SERVICES; REAL ESTATE CONSULTATION; REAL ESTATE EQUITY SHARING, NAMELY, MANAGING AND ARRANGING FOR CO-OWNERSHIP OF REAL ESTATE; REAL ESTATE PROCUREMENT FOR OTHERS; REAL ESTATE TRUSTEE SERVICES (U.S. CLS. 100, 101 AND 102).

FIRST USE 3-1-1994; IN COMMERCE 3-1-1994.
NAAKWAMA ANKRAH, EXAMINING ATTORNEY

SN 78-955,532. THE NAVIGATORS GROUP, INC., NEW YORK, NY. FILED 8-18-2006.

IPO InNAVation

THE MARK CONSISTS OF STANDARD CHARACTERS WITHOUT CLAIM TO ANY PARTICULAR FONT, STYLE, SIZE, OR COLOR.

NO CLAIM IS MADE TO THE EXCLUSIVE RIGHT TO USE "IPO", APART FROM THE MARK AS SHOWN.

FOR INSURANCE UNDERWRITING IN THE FIELD OF INITIAL PUBLIC OFFERING INSURANCE (U.S. CLS. 100, 101 AND 102).

FIRST USE 5-23-2006; IN COMMERCE 5-23-2006.
MARILYN IZZI, EXAMINING ATTORNEY

SN 78-957,647. NABERS, JEFFREY, MYRTLE BEACH, SC. FILED 8-22-2006.

IRAAA

THE MARK CONSISTS OF STANDARD CHARACTERS WITHOUT CLAIM TO ANY PARTICULAR FONT, STYLE, SIZE, OR COLOR.

FOR FINANCIAL SERVICES, NAMELY PLANNING, MANAGEMENT, AND CONSULTATION OF RETIREMENT PLANS (U.S. CLS. 100, 101 AND 102).

TARAH HARDY, EXAMINING ATTORNEY

CLASS 36—(Continued).

SN 78-957,968. HARRIS NATIONAL ASSOCIATION, CHICAGO, IL. FILED 8-22-2006.

HARRIS - WE'RE HERE TO HELP

THE MARK CONSISTS OF STANDARD CHARACTERS WITHOUT CLAIM TO ANY PARTICULAR FONT, STYLE, SIZE, OR COLOR.

FOR BANKING (U.S. CLS. 100, 101 AND 102).
DAVID TAYLOR, EXAMINING ATTORNEY

CLASS 36—(Continued).

SN 78-961,583. GIVE SOMETHING BACK FOUNDATION, INC., PRINCETON, NJ. FILED 8-28-2006.

GIVE SOMETHING BACK FOUNDATION

THE MARK CONSISTS OF STANDARD CHARACTERS WITHOUT CLAIM TO ANY PARTICULAR FONT, STYLE, SIZE, OR COLOR.

NO CLAIM IS MADE TO THE EXCLUSIVE RIGHT TO USE "FOUNDATION", APART FROM THE MARK AS SHOWN.

FOR CHARITABLE MONETARY SERVICES, NAMELY, PROVIDING MONETARY EDUCATIONAL AWARDS, GIFTS, DONATIONS, GRANTS, ENDOWMENTS AND SCHOLARSHIPS (U.S. CLS. 100, 101 AND 102).

FIRST USE 3-29-2006; IN COMMERCE 3-29-2006.
TINA KUAN, EXAMINING ATTORNEY

SN 78-961,812. MOUNTAINS EDGE, LLC, LAS VEGAS, NV. FILED 8-28-2006.

HOME SEARCH CAFE

THE MARK CONSISTS OF STANDARD CHARACTERS WITHOUT CLAIM TO ANY PARTICULAR FONT, STYLE, SIZE, OR COLOR.

NO CLAIM IS MADE TO THE EXCLUSIVE RIGHT TO USE "HOME SEARCH", APART FROM THE MARK AS SHOWN.

FOR REAL ESTATE AGENCY, REAL ESTATE LISTINGS, LEASING AND BROKERAGE SERVICES (U.S. CLS. 100, 101 AND 102).

FIRST USE 10-31-2003; IN COMMERCE 10-31-2003.
RUSS HERMAN, EXAMINING ATTORNEY

SN 78-963,956. PRIMEQUITY, LLC, TAMPA, FL. FILED 8-30-2006.

PRIMEQUITY

THE MARK CONSISTS OF STANDARD CHARACTERS WITHOUT CLAIM TO ANY PARTICULAR FONT, STYLE, SIZE, OR COLOR.

SEC. 2(F).

FOR MORTGAGE BANKING SERVICES, NAMELY, ORIGINATION, ACQUISITION, SERVICING, SECURITIZATION AND BROKERAGE OF MORTGAGE LOANS (U.S. CLS. 100, 101 AND 102).

FIRST USE 3-30-2001; IN COMMERCE 3-30-2001.
ELIZABETH KAJUBI, EXAMINING ATTORNEY

NO CLAIM IS MADE TO THE EXCLUSIVE RIGHT TO USE "FOUNDATION", APART FROM THE MARK AS SHOWN.

FOR CHARITABLE MONETARY SERVICES, NAMELY, PROVIDING MONETARY EDUCATIONAL AWARDS, GIFTS, DONATIONS, GRANTS, ENDOWMENTS AND SCHOLARSHIPS (U.S. CLS. 100, 101 AND 102).

FIRST USE 3-29-2006; IN COMMERCE 3-29-2006.
TINA KUAN, EXAMINING ATTORNEY



CLASS 36—(Continued).

SN 78-967,530. GLENMONT MDC EASTERN HILLS, LLC, CLIFTON, NJ. FILED 9-5-2006.

Eastern Hills Mall

THE MARK CONSISTS OF STANDARD CHARACTERS WITHOUT CLAIM TO ANY PARTICULAR FONT, STYLE, SIZE, OR COLOR.

NO CLAIM IS MADE TO THE EXCLUSIVE RIGHT TO USE "MALL", APART FROM THE MARK AS SHOWN.

FOR LEASING OF SPACE IN A SHOPPING CENTER AND RETAIL SHOPPING CENTER SERVICES, NAMELY, RENTAL OF SHOPPING CENTER SPACE (U.S. CLS. 100, 101 AND 102).

FIRST USE 0-0-1971; IN COMMERCE 0-0-1971.

JAY BESCH, EXAMINING ATTORNEY

SN 78-969,038. FEDERATED INVESTORS, INC., PITTSBURGH, PA. FILED 9-7-2006.

FORT DUQUESNE

THE MARK CONSISTS OF STANDARD CHARACTERS WITHOUT CLAIM TO ANY PARTICULAR FONT, STYLE, SIZE, OR COLOR.

FOR FINANCIAL ADVISORY SERVICES IN THE FIELD OF COLLATERALIZED DEBT OBLIGATIONS (U.S. CLS. 100, 101 AND 102).

FIRST USE 8-6-2006; IN COMMERCE 8-6-2006.

TARAH HARDY, EXAMINING ATTORNEY

SN 78-969,849. HEINZ, ANDRE, PITTSBURGH, PA. FILED 9-8-2006.

BOMBADIL

THE MARK CONSISTS OF STANDARD CHARACTERS WITHOUT CLAIM TO ANY PARTICULAR FONT, STYLE, SIZE, OR COLOR.

FOR INVESTMENT SERVICES, NAMELY, ASSET ACQUISITION, REAL ESTATE ACQUISITION, CONSULTATION, DEVELOPMENT AND MANAGEMENT SERVICES, NAMELY, INVESTING IN COMPANIES THAT PROVIDE ENVIRONMENTALLY FRIENDLY PRODUCTS AND SERVICES (U.S. CLS. 100, 101 AND 102).

NAPOLEON SHARMA, EXAMINING ATTORNEY

CLASS 36—(Continued).

SN 78-970,079. SYMP, LLC., LOS ANGELES, CA. FILED 9-8-2006.



THE COLOR(S) BLUE AND GREEN IS/ARE CLAIMED AS A FEATURE OF THE MARK.

THE MARK CONSISTS OF THE COLORS BLUE AND GREEN. THE COLOR BLUE IS USED FOR THE ENTIRE BODY OF THE FROG AND THE UNDERSIDE OF THE FROG IS GREEN.

FOR PROVIDING TEXT AND PHOTOGRAPHIC INFORMATION OVER THE INTERNET CONCERNING THE AVAILABILITY, PRICE, LOCATION, AND DESCRIPTION OF RESIDENTIAL REAL PROPERTY OF OTHERS TO PROSPECTIVE RENTERS (U.S. CLS. 100, 101 AND 102).

FIRST USE 7-0-2006; IN COMMERCE 7-0-2006.

KEVON CHISOLM, EXAMINING ATTORNEY

SN 78-971,158. FLEX FUND FINANCIAL SERVICES, LLC, MINNETONKA, MN. FILED 9-11-2006.

FLEXFUND

THE MARK CONSISTS OF STANDARD CHARACTERS WITHOUT CLAIM TO ANY PARTICULAR FONT, STYLE, SIZE, OR COLOR.

FOR FINANCIAL SERVICES, NAMELY, USED CAR INVENTORY FINANCING FOR NEW AND USED CAR DEALERS AND AUCTION SALVAGE BUYERS; PROVIDING AN INTERACTIVE WEBSITE FEATURING FINANCIAL SERVICES, NAMELY, USED CAR INVENTORY FINANCING FOR NEW AND USED CAR DEALERS AND AUCTION SALVAGE BUYERS (U.S. CLS. 100, 101 AND 102).

GINA HAYES, EXAMINING ATTORNEY

CLASS 36—(Continued).

SN 78-972,941. GOLDEN ARROW REALTY INC, CHICAGO, IL. FILED 9-12-2006.

CLASS 36—(Continued).

SN 78-973,048. ABSOLUTE PLUS MANAGEMENT LLC, NEW YORK, NY. FILED 9-13-2006.

APM

GOLDEN ARROW REALTY

THE MARK CONSISTS OF STANDARD CHARACTERS WITHOUT CLAIM TO ANY PARTICULAR FONT, STYLE, SIZE, OR COLOR.

NO CLAIM IS MADE TO THE EXCLUSIVE RIGHT TO USE "REALTY", APART FROM THE MARK AS SHOWN.

FOR APARTMENT LOCATING SERVICES FOR OTHERS; APPRAISAL OF REAL ESTATE; APPRAISALS FOR INSURANCE CLAIMS OF REAL ESTATE; ASSESSMENT AND MANAGEMENT OF REAL ESTATE; BUSINESS FINANCE PROCUREMENT SERVICES; BUSINESS LIQUIDATION SERVICES; ESTATE PLANNING; EVALUATION OF REAL PROPERTY; FINANCIAL INVESTMENT IN THE FIELD OF REAL ESTATE; FINANCING SERVICES; HOME APPRAISAL SERVICES; INVESTMENT SERVICES, NAMELY ASSET ACQUISITION, CONSULTATION, DEVELOPMENT AND MANAGEMENT SERVICES; LEASING OF REAL ESTATE; LEASING OF REAL PROPERTY; MORTGAGE SERVICES, NAMELY, BUYER PRE-QUALIFICATION OF MORTGAGES FOR MORTGAGE BROKERS AND BANKS; OPERATING MARKETPLACES FOR SELLERS OF GOODS AND/OR SERVICES; PROVIDING INFORMATION IN THE FIELD OF REAL ESTATE BY MEANS OF LINKING THE WEB SITE TO OTHER WEB SITES FEATURING REAL ESTATE INFORMATION; REAL ESTATE ACQUISITION SERVICES; REAL ESTATE AGENCIES; REAL ESTATE APPRAISAL; REAL ESTATE BROKERAGE; REAL ESTATE CONSULTANCY; REAL ESTATE CONSULTATION; REAL ESTATE EQUITY SHARING, NAMELY, MANAGING AND ARRANGING FOR CO-OWNERSHIP OF REAL ESTATE; REAL ESTATE ESCROW SERVICES; REAL ESTATE INVESTMENT; REAL ESTATE LISTING; REAL ESTATE MANAGEMENT; REAL ESTATE MANAGEMENT CONSULTATION; REAL ESTATE MULTIPLE LISTING SERVICES; REAL ESTATE PROCUREMENT FOR OTHERS; REAL ESTATE SERVICES, NAMELY, RENTAL OF VACATION HOMES, CONDOMINIUMS, CABINS, AND VILLAS USING PAY PER CLICK ADVERTISING ON A GLOBAL COMPUTER NETWORK; REAL ESTATE SYNDICATION; REAL ESTATE TIME-SHARING; REAL ESTATE TRUSTEE SERVICES; REAL ESTATE VALUATION SERVICES; REAL ESTATE VALUATIONS; SHOPPING CENTER SERVICES, NAMELY, RENTAL OF SHOPPING CENTER SPACE; VACATION REAL ESTATE TIME SHARE EXCHANGE SERVICES; VACATION REAL ESTATE TIME-SHARING (U.S. CLS. 100, 101 AND 102).

FIRST USE 1-2-2004; IN COMMERCE 1-2-2004. CIMMERIAN COLEMAN, EXAMINING ATTORNEY

THE MARK CONSISTS OF STANDARD CHARACTERS WITHOUT CLAIM TO ANY PARTICULAR FONT, STYLE, SIZE, OR COLOR.

FOR INVESTMENT ADVISORY AND MANAGEMENT SERVICES FOR SUBSCRIPTION BY PRIVATE INVESTORS FEATURING A SYSTEMATIC PRICE-BASED STRATEGY BASED ON PROPRIETARY METHODOLOGIES TO CAPTURE MARKET BEHAVIOR (U.S. CLS. 100, 101 AND 102).

SUE LAWRENCE, EXAMINING ATTORNEY

SN 78-973,457. TECOMATE WILDLIFE SYSTEMS, LTD., SAN ANTONIO, TX. FILED 9-13-2006.

TECOMATE PROPERTIES

THE MARK CONSISTS OF STANDARD CHARACTERS WITHOUT CLAIM TO ANY PARTICULAR FONT, STYLE, SIZE, OR COLOR.

NO CLAIM IS MADE TO THE EXCLUSIVE RIGHT TO USE "PROPERTIES", APART FROM THE MARK AS SHOWN.

FOR REAL ESTATE BROKERAGE (U.S. CLS. 100, 101 AND 102).

ELISSA GARBER KON, EXAMINING ATTORNEY

CLASS 36—(Continued).

SN 78-973,922. PENKY LLC, WILMINGTON, DE. FILED 9-13-2006.

INVENTION SCIENCE

THE MARK CONSISTS OF STANDARD CHARACTERS WITHOUT CLAIM TO ANY PARTICULAR FONT, STYLE, SIZE, OR COLOR.

NO CLAIM IS MADE TO THE EXCLUSIVE RIGHT TO USE "INVENTION", APART FROM THE MARK AS SHOWN.

FOR FACILITATING AND ARRANGING FOR THE INVESTMENT AND FINANCING BY OTHERS IN INVENTIONS, TECHNOLOGIES, PRODUCTS, METHODS, PROCESSES, IDEAS, AND DISCOVERIES; PROVIDING FUNDING FOR INVENTORS, UNIVERSITIES, RESEARCH INSTITUTIONS, GOVERNMENTS AND COMMERCIAL AND NON-PROFIT ENTITIES TO FACILITATE THE CREATION AND DEVELOPMENT OF INVENTIONS, TECHNOLOGIES, PRODUCTS, METHODS, PROCESSES, IDEAS, DISCOVERIES, INTELLECTUAL PROPERTY, PATENTS, PATENT APPLICATIONS, TRADEMARKS, COPYRIGHTS AND TRADE SECRETS; PROVIDING FUNDRAISING SERVICES FOR OTHERS IN THE FIELDS OF INVENTIONS, TECHNOLOGIES, PRODUCTS, METHODS, PROCESSES, IDEAS, DISCOVERIES, INTELLECTUAL PROPERTY, PATENTS, PATENT APPLICATIONS, TRADEMARKS, COPYRIGHTS AND TRADE SECRETS; VENTURE CAPITAL FUNDING SERVICES TO EMERGING AND START-UP COMPANIES, INVENTORS, UNIVERSITIES, RESEARCH INSTITUTIONS, GOVERNMENTS AND COMMERCIAL AND NON-PROFIT ENTITIES; FINANCIAL INVESTMENT FOR THE BENEFIT OF OTHERS IN INVENTORS, INVENTIONS, TECHNOLOGIES, PRODUCTS, METHODS, PROCESSES, IDEAS, DISCOVERIES, INTELLECTUAL PROPERTY, PATENTS, PATENT APPLICATIONS, TRADEMARKS, COPYRIGHTS AND TRADE SECRETS; FINANCIAL SERVICES, NAMELY, PROVIDING FUNDING FOR INVENTIONS, TECHNOLOGIES, PRODUCTS, METHODS, PROCESSES, IDEAS AND DISCOVERIES OF OTHERS (U.S. CLS. 100, 101 AND 102).

ELLEN BURNS, EXAMINING ATTORNEY

CLASS 36—(Continued).

SN 78-973,927. PENKY LLC, WILMINGTON, DE. FILED 9-13-2006.

INTELLECTUAL VENTURES

THE MARK CONSISTS OF STANDARD CHARACTERS WITHOUT CLAIM TO ANY PARTICULAR FONT, STYLE, SIZE, OR COLOR.

FOR FACILITATING AND ARRANGING FOR THE INVESTMENT AND FINANCING BY OTHERS IN INVENTIONS, TECHNOLOGIES, PRODUCTS, METHODS, PROCESSES, IDEAS, AND DISCOVERIES; PROVIDING FUNDING FOR INVENTORS, UNIVERSITIES, RESEARCH INSTITUTIONS, GOVERNMENTS AND COMMERCIAL AND NON-PROFIT ENTITIES TO FACILITATE THE CREATION AND DEVELOPMENT OF INVENTIONS, TECHNOLOGIES, PRODUCTS, METHODS, PROCESSES, IDEAS, DISCOVERIES, INTELLECTUAL PROPERTY, PATENTS, PATENT APPLICATIONS, TRADEMARKS, COPYRIGHTS AND TRADE SECRETS; PROVIDING FUNDRAISING SERVICES FOR OTHERS IN THE FIELDS OF INVENTIONS, TECHNOLOGIES, PRODUCTS, METHODS, PROCESSES, IDEAS, DISCOVERIES, INTELLECTUAL PROPERTY, PATENTS, PATENT APPLICATIONS, TRADEMARKS, COPYRIGHTS AND TRADE SECRETS; VENTURE CAPITAL FUNDING SERVICES TO EMERGING AND START-UP COMPANIES, INVENTORS, UNIVERSITIES, RESEARCH INSTITUTIONS, GOVERNMENTS AND COMMERCIAL AND NON-PROFIT ENTITIES; FINANCIAL INVESTMENT FOR THE BENEFIT OF OTHERS IN INVENTORS, INVENTIONS, TECHNOLOGIES, PRODUCTS, METHODS, PROCESSES, IDEAS, DISCOVERIES, INTELLECTUAL PROPERTY, PATENTS, PATENT APPLICATIONS, TRADEMARKS, COPYRIGHTS AND TRADE SECRETS; FINANCIAL SERVICES, NAMELY, PROVIDING FUNDING FOR INVENTIONS, TECHNOLOGIES, PRODUCTS, METHODS, PROCESSES, IDEAS AND DISCOVERIES OF OTHERS (U.S. CLS. 100, 101 AND 102).

ELLEN BURNS, EXAMINING ATTORNEY

SN 79-034,883. INVESTEC ASSET; MANAGEMENT LIMITED, UNITED KINGDOM, FILED 12-11-2006.



PRIORITY DATE OF 9-13-2006 IS CLAIMED. OWNER OF INTERNATIONAL REGISTRATION 0914521 DATED 12-11-2006, EXPIRES 12-11-2016.

FOR PROVIDING INVESTMENT MANAGEMENT SERVICES TO OTHERS (U.S. CLS. 100, 101 AND 102). RENEE SERVANCE, EXAMINING ATTORNEY

CLASS 37—CONSTRUCTION AND REPAIR

SN 76-665,283. REMODELING SERVICES UNLIMITED, INC., MURFREESBORO, TN. FILED 8-29-2006.



NO CLAIM IS MADE TO THE EXCLUSIVE RIGHT TO USE "REMODELING SERVICES UNLIMITED, INC.", APART FROM THE MARK AS SHOWN.

FOR REMODELING, CONSTRUCTION, PAINTING AND GENERAL REPAIR WORK OF RESIDENTIAL AND COMMERCIAL DWELLINGS, NAMELY, LIVING AREAS, BATHROOMS, KITCHENS, OUTDOOR LIVING AREAS, GARAGES, DECKS, OFFICE SPACE; INSTALLATION OF APPLIANCES, ELECTRICAL SYSTEMS, PLUMBING, HEATING/AIR CONDITIONING SYSTEMS AND CARPENTRY (U.S. CLS. 100, 103 AND 106).

FIRST USE 9-1-2001; IN COMMERCE 9-1-2001.
NANCY CLARKE, EXAMINING ATTORNEY

SN 76-665,698. WHITE CASTLE MANAGEMENT CO., COLUMBUS, OH. FILED 9-5-2006.

RINSE 'N ROLL

THE MARK CONSISTS OF STANDARD CHARACTERS WITHOUT CLAIM TO ANY PARTICULAR FONT, STYLE, SIZE, OR COLOR.

NO CLAIM IS MADE TO THE EXCLUSIVE RIGHT TO USE "RINSE", APART FROM THE MARK AS SHOWN.

FOR CAR WASHING (U.S. CLS. 100, 103 AND 106).
WANDA KAY PRICE, EXAMINING ATTORNEY

SN 76-675,522. FLOWERS, MICHAEL, MURRELLS INLET, SC. FILED 4-16-2007.

SIR FLUSH -A-LOT

THE MARK CONSISTS OF STANDARD CHARACTERS WITHOUT CLAIM TO ANY PARTICULAR FONT, STYLE, SIZE, OR COLOR.

FOR PLUMBING AND DRAIN CLEANING SERVICES (U.S. CLS. 100, 103 AND 106).

JAMES LOVELACE, EXAMINING ATTORNEY

CLASS 37—(Continued).

SN 76-675,523. FLOWERS, MICHAEL, MURRELLS INLET, SC. FILED 4-16-2007.



FOR PLUMBING AND DRAIN CLEANING SERVICES (U.S. CLS. 100, 103 AND 106).

JAMES LOVELACE, EXAMINING ATTORNEY

SN 77-000,559. LONG FENCE AND HOME, LLLP, BELTSVILLE, MD. FILED 9-15-2006.

LONG BASEMENTS

THE MARK CONSISTS OF STANDARD CHARACTERS WITHOUT CLAIM TO ANY PARTICULAR FONT, STYLE, SIZE, OR COLOR.

OWNER OF U.S. REG. NOS. 2,577,699, 2,638,446 AND OTHERS.

NO CLAIM IS MADE TO THE EXCLUSIVE RIGHT TO USE "BASEMENTS", APART FROM THE MARK AS SHOWN.

FOR INSTALLATION AND REMODELING OF RESIDENTIAL AND COMMERCIAL BASEMENTS (U.S. CLS. 100, 103 AND 106).

FIRST USE 6-28-2006; IN COMMERCE 6-28-2006.
DAVID COLLIER, EXAMINING ATTORNEY

CLASS 37—(Continued).

SN 77-070,888. MANGRUM, TERRY, CLEBURNE, TX.
FILED 12-22-2006.

**CURLY'S PLUMBING & BIG
BLADE SEWER SERVICE INC.**

THE MARK CONSISTS OF STANDARD CHARACTERS WITHOUT CLAIM TO ANY PARTICULAR FONT, STYLE, SIZE, OR COLOR.

NO CLAIM IS MADE TO THE EXCLUSIVE RIGHT TO USE "PLUMBING & BIG BLADE SEWER SERVICE INC.", APART FROM THE MARK AS SHOWN.

THE NAME(S), PORTRAIT(S), AND/OR SIGNATURE(S) SHOWN IN THE MARK DOES NOT IDENTIFY A PARTICULAR LIVING INDIVIDUAL.

FOR PLUMBING AND SEWER SERVICES, NAMELY, PLUMBING AND SEWER CLEANING (U.S. CLS. 100, 103 AND 106).

FIRST USE 2-1-1997; IN COMMERCE 2-1-1997.
SHARON MEIER, EXAMINING ATTORNEY

SN 77-107,237. HAIL GUARD NETWORK INC., ATLANTA, GA. FILED 2-14-2007.

HAIL SHIELD

THE MARK CONSISTS OF STANDARD CHARACTERS WITHOUT CLAIM TO ANY PARTICULAR FONT, STYLE, SIZE, OR COLOR.

NO CLAIM IS MADE TO THE EXCLUSIVE RIGHT TO USE HAIL, APART FROM THE MARK AS SHOWN.

FOR SERVICE REPAIR OF CUSTOMER VEHICLES DENTED BY HAILSTONES (U.S. CLS. 100, 103 AND 106).
SOPHIA S. KIM, EXAMINING ATTORNEY

SN 77-109,526. TRADEMARK PROPERTIES, LLC., WASHINGTON, DC. FILED 2-16-2007.

Trademark Properties

THE MARK CONSISTS OF STANDARD CHARACTERS WITHOUT CLAIM TO ANY PARTICULAR FONT, STYLE, SIZE, OR COLOR.

NO CLAIM IS MADE TO THE EXCLUSIVE RIGHT TO USE "PROPERTIES", APART FROM THE MARK AS SHOWN.

FOR REAL ESTATE DEVELOPMENT (U.S. CLS. 100, 103 AND 106).

FIRST USE 2-22-2001; IN COMMERCE 2-22-2001.
DOMINIC J. FERRAIUOLO, EXAMINING ATTORNEY

CLASS 37—(Continued).

SN 77-117,619. BLOIS CONSTRUCTION, INC., OXNARD, CA.
FILED 2-27-2007.

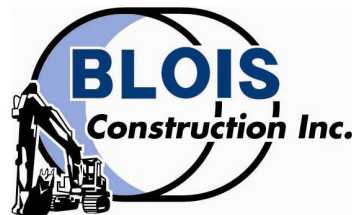

NO CLAIM IS MADE TO THE EXCLUSIVE RIGHT TO USE "CONSTRUCTION INC.", APART FROM THE MARK AS SHOWN.

"THE COLOR(S) WHITE, BLACK, DARK BLUE AND LIGHT BLUE IS/ARE CLAIMED AS A FEATURE OF THE MARK."

"THE MARK CONSISTS OF THE WORDS "BLOIS CONSTRUCTION INC." BESIDE AN IMAGE OF A PIPE AND EXCAVATOR. THE BACKGROUND IS WHITE, THE CIRCLE DESIGNS, PIPE AND EXCAVATOR DESIGN AND THE WORDING CONSTRUCTION INC. ARE BLACK, THE TERM BLOIS IS DARK BLUE, AND THE CENTER PORTION OF THE INNER CIRCLE DESIGN IS LIGHT BLUE."

SEC. 2(F).
FOR PIPELINE INSTALLATION AND REPAIR (U.S. CLS. 100, 103 AND 106).

FIRST USE 1-1-1985; IN COMMERCE 1-1-1985.
MICHELE SWAIN, EXAMINING ATTORNEY

SN 77-123,088. DANIEL CORPORATION, BIRMINGHAM, AL. FILED 3-6-2007.



DANIEL
CORPORATION

NO CLAIM IS MADE TO THE EXCLUSIVE RIGHT TO USE "CORPORATION", APART FROM THE MARK AS SHOWN.

THE MARK CONSISTS OF AN INTERLOCKING "D" AND "C" SYMBOL CENTERED ABOVE THE WORD "DANIEL" WHICH IS CENTERED ABOVE THE WORD "CORPORATION"

FOR REAL ESTATE DEVELOPMENT (U.S. CLS. 100, 103 AND 106).

FIRST USE 1-1-1988; IN COMMERCE 6-1-1988.
CARYN GLASSER, EXAMINING ATTORNEY

CLASS 37—(Continued).

SN 77-129,158. PRATT INDUSTRIES, (USA) INC., CONYERS, GA. FILED 3-13-2007.

HARVESTING THE URBAN FOREST

THE MARK CONSISTS OF STANDARD CHARACTERS WITHOUT CLAIM TO ANY PARTICULAR FONT, STYLE, SIZE, OR COLOR.

NO CLAIM IS MADE TO THE EXCLUSIVE RIGHT TO USE "URBAN FOREST", APART FROM THE MARK AS SHOWN.

FOR RECYCLING SERVICES (U.S. CLS. 100, 103 AND 106).

FIRST USE 1-31-1997; IN COMMERCE 1-31-1997.
STANLEY I. OSBORNE, EXAMINING ATTORNEY

CLASS 37—(Continued).

SN 77-147,015. MESSER CONSTRUCTION CO., CINCINNATI, OH. FILED 4-3-2007.

VALUEPATH

THE MARK CONSISTS OF STANDARD CHARACTERS WITHOUT CLAIM TO ANY PARTICULAR FONT, STYLE, SIZE, OR COLOR.

FOR REAL ESTATE CONSTRUCTION SERVICES, NAMELY, RESIDENTIAL AND COMMERCIAL BUILDING CONSTRUCTION (U.S. CLS. 100, 103 AND 106).

FIRST USE 1-18-2006; IN COMMERCE 1-18-2006.

BERNICE MIDDLETON, EXAMINING ATTORNEY

SN 77-149,422. SAMUEL JONES S, GREENWOOD, IN. FILED 4-5-2007.

Janitorial Options

THE MARK CONSISTS OF STANDARD CHARACTERS WITHOUT CLAIM TO ANY PARTICULAR FONT, STYLE, SIZE, OR COLOR.

NO CLAIM IS MADE TO THE EXCLUSIVE RIGHT TO USE "JANITORIAL", APART FROM THE MARK AS SHOWN.

FOR JANITORIAL SERVICES (U.S. CLS. 100, 103 AND 106).

FIRST USE 1-1-1974; IN COMMERCE 1-1-1974.

MICHELLE DUBOIS, EXAMINING ATTORNEY

SN 77-151,331. THE BROOKFIELD GROUP, LLC, CARMEL, IN. FILED 4-7-2007.

SN 77-136,757. BAYMARK CONSTRUCTION CORPORATION, VIRGINIA BEACH, VA. FILED 3-21-2007.



OWNER OF U.S. REG. NOS. 2,912,968, 3,062,624 AND OTHERS.

NO CLAIM IS MADE TO THE EXCLUSIVE RIGHT TO USE "RESORT & CLUB", APART FROM THE MARK AS SHOWN.

THE MARK CONSISTS OF THE STYLIZED LETTERS "BAY CREEK RESORT & CLUB" BENEATH THE OUTLINE OF A GULL, WAVES AND CATTAILS.

FOR REAL ESTATE DEVELOPMENT (U.S. CLS. 100, 103 AND 106).

FIRST USE 3-23-2000; IN COMMERCE 3-23-2000.
CHERYL CLAYTON, EXAMINING ATTORNEY



NO CLAIM IS MADE TO THE EXCLUSIVE RIGHT TO USE "GROUP" AND "TECHNOLOGY", APART FROM THE MARK AS SHOWN.

THE MARK CONSISTS OF A LOWER CASE LETTER "B" LOCATED INSIDE A SQUARE WITH THE LEFT HAND SIDE OF THE OF THE "B" FORMING A PART OF THE LEFT HAND SIDE OF THE SQUARE. TO THE RIGHT OF THE SQUARE ARE THE WORDS "THE BROOKFIELD GROUP" PRINTED ON ABOVE THE WORDS "NEXT LEVEL TECHNOLOGY".

FOR MAINTENANCE AND REPAIR OF COMPUTER HARDWARE; INSTALLATION OF COMPUTER NETWORKS; MAINTENANCE AND REPAIR OF COMPUTER NETWORKS; INSTALLATION OF COMPUTER SYSTEMS (U.S. CLS. 100, 103 AND 106).

FIRST USE 1-1-2003; IN COMMERCE 1-1-2003.

GEORGIA CARTY, EXAMINING ATTORNEY

CLASS 37—(Continued).

SN 77-154,097. ECO-PAN, INC., DENVER, CO. FILED 4-11-2007.



NO CLAIM IS MADE TO THE EXCLUSIVE RIGHT TO USE THE RECYCLING SYMBOL, APART FROM THE MARK AS SHOWN.

THE APPLICANT CLAIMS COLOR AS A FEATURE OF THE MARK, NAMELY, GREEN AND BLUE.

THE COLOR BLUE APPEARS IN THE WORDING AND IN THE WATER. THE COLOR GREEN APPEARS IN THE LAND, THE RECYCLE SYMBOL, AND IN THE OUTLINING. THE COLOR WHITE APPEARING IN THE PAN REPRESENTS A TRANSPARENT AREA AND IS NOT PART OF THE MARK.

FOR CONSTRUCTION WASTE AND DEBRIS CONTAINMENT AND DISPOSAL SERVICES (U.S. CLS. 100, 103 AND 106).

FIRST USE 8-1-2003; IN COMMERCE 8-1-2003.
AMEETA JORDAN, EXAMINING ATTORNEY

SN 77-154,821. PEACOCK PROPERTY LLC, JACKSON, WY. FILED 4-12-2007.

MOUNTAIN LEGENDS RANCH

THE MARK CONSISTS OF STANDARD CHARACTERS WITHOUT CLAIM TO ANY PARTICULAR FONT, STYLE, SIZE, OR COLOR.

NO CLAIM IS MADE TO THE EXCLUSIVE RIGHT TO USE "RANCH", APART FROM THE MARK AS SHOWN.

FOR REAL ESTATE DEVELOPMENT (U.S. CLS. 100, 103 AND 106).

ANTHONY RINKER, EXAMINING ATTORNEY

CLASS 37—(Continued).

SN 77-155,201. SEAHAVEN PROPERTIES, INC., PANAMA CITY BEACH, FL. FILED 4-12-2007.

Towne of Seahaven

THE MARK CONSISTS OF STANDARD CHARACTERS WITHOUT CLAIM TO ANY PARTICULAR FONT, STYLE, SIZE, OR COLOR.

NO CLAIM IS MADE TO THE EXCLUSIVE RIGHT TO USE "TOWNE", APART FROM THE MARK AS SHOWN.

FOR REAL ESTATE DEVELOPMENT, PLANNING AND CONSTRUCTION SERVICES, NAMELY, DEVELOPMENT, PLANNING, LAYING OUT AND CONSTRUCTION OF RESIDENTIAL, COMMERCIAL, CONDOMINIUM, MIXED USE AND RESORT PROPERTIES AND THE RECREATIONAL FACILITIES ASSOCIATED THEREWITH (U.S. CLS. 100, 103 AND 106).

MIDGE BUTLER, EXAMINING ATTORNEY

SN 77-155,259. SEAHAVEN PROPERTIES, INC., PANAMA CITY BEACH, FL. FILED 4-12-2007.

Seahaven

THE MARK CONSISTS OF STANDARD CHARACTERS WITHOUT CLAIM TO ANY PARTICULAR FONT, STYLE, SIZE, OR COLOR.

FOR REAL ESTATE DEVELOPMENT, PLANNING AND CONSTRUCTION SERVICES, NAMELY, DEVELOPMENT, PLANNING, LAYING OUT AND CONSTRUCTION OF RESIDENTIAL, COMMERCIAL, CONDOMINIUM, MIXED USE AND RESORT PROPERTIES AND THE RECREATIONAL FACILITIES ASSOCIATED THEREWITH (U.S. CLS. 100, 103 AND 106).

MIDGE BUTLER, EXAMINING ATTORNEY

SN 77-155,299. SEAHAVEN PROPERTIES, INC., PANAMA CITY BEACH, FL. FILED 4-12-2007.

Village of Seahaven

THE MARK CONSISTS OF STANDARD CHARACTERS WITHOUT CLAIM TO ANY PARTICULAR FONT, STYLE, SIZE, OR COLOR.

NO CLAIM IS MADE TO THE EXCLUSIVE RIGHT TO USE "VILLAGE", APART FROM THE MARK AS SHOWN.

FOR REAL ESTATE DEVELOPMENT, PLANNING AND CONSTRUCTION SERVICES, NAMELY, DEVELOPMENT, PLANNING, LAYING OUT AND CONSTRUCTION OF COMMERCIAL AND CONDOMINIUM PROPERTIES (U.S. CLS. 100, 103 AND 106).

MIDGE BUTLER, EXAMINING ATTORNEY

CLASS 37—(Continued).

SN 77-155,567. SIROIS, EDWARD, FERN PARK, FL. FILED 4-12-2007.

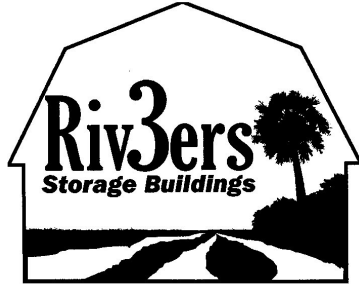

NO CLAIM IS MADE TO THE EXCLUSIVE RIGHT TO USE "STORAGE BUILDINGS", APART FROM THE MARK AS SHOWN.

THE MARK CONSISTS IN PART OF AN OUTLINE OF A BARN-TYPE STRUCTURE WITH A SCENE OF A PALM TREE AND THREE RIVERS FLOWING FROM THE HORIZON TO THE FOREGROUND.

FOR ON SITE CONSTRUCTION OF SMALL STORAGE BUILDINGS (U.S. CLS. 100, 103 AND 106).

G. MAYERSCHOFF, EXAMINING ATTORNEY

SN 77-155,624. PRIORITY PEST CONTROL, NEWPORT NEWS, VA. FILED 4-12-2007.

PRIORITY

THE MARK CONSISTS OF STANDARD CHARACTERS WITHOUT CLAIM TO ANY PARTICULAR FONT, STYLE, SIZE, OR COLOR.

FOR TERMITE AND PEST CONTROL; PEST CONTROL (U.S. CLS. 100, 103 AND 106).

FIRST USE 4-1-2001; IN COMMERCE 4-1-2001.

MICHELE SWAIN, EXAMINING ATTORNEY

SN 77-157,071. ALIN R. CHEIE, PARK RIDGE, IL. FILED 4-15-2007.

BLUESTONE

THE MARK CONSISTS OF STANDARD CHARACTERS WITHOUT CLAIM TO ANY PARTICULAR FONT, STYLE, SIZE, OR COLOR.

FOR CONSTRUCTION AND RENOVATION OF BUILDINGS; CONSTRUCTION SERVICES, NAMELY, PLANNING, LAYING OUT AND CUSTOM CONSTRUCTION OF RESIDENTIAL AND COMMERCIAL COMMUNITIES; CUSTOM CONSTRUCTION AND BUILDING RENOVATION; CUSTOM CONSTRUCTION OF HOMES; GENERAL CONSTRUCTION CONTRACTING; RESIDENTIAL AND COMMERCIAL BUILDING CONSTRUCTION (U.S. CLS. 100, 103 AND 106).

CHRISTINA SOBRAL, EXAMINING ATTORNEY

CLASS 37—(Continued).

SN 77-157,187. MARBLEBLUE, INC., DOBBS FERRY, NY. FILED 4-16-2007.

MARBLEBLUE

THE MARK CONSISTS OF STANDARD CHARACTERS WITHOUT CLAIM TO ANY PARTICULAR FONT, STYLE, SIZE, OR COLOR.

FOR RESTORATION IN THE FIELD OF MARBLE AND STONE (U.S. CLS. 100, 103 AND 106).

FIRST USE 11-1-2006; IN COMMERCE 11-1-2006.

CHRIS WELLS, EXAMINING ATTORNEY

SN 77-157,262. FOSTER, CHARLES P. AND FOSTER, JOYCE C., TAMPA, FL. FILED 4-16-2007.

ISLAND TIME ...IT'S JUST A SPLASH AWAY

THE MARK CONSISTS OF STANDARD CHARACTERS WITHOUT CLAIM TO ANY PARTICULAR FONT, STYLE, SIZE, OR COLOR.

OWNER OF U.S. REG. NO. 1,659,122.
FOR SWIMMING POOL CONSTRUCTION AND INSTALLATION SERVICES (U.S. CLS. 100, 103 AND 106).

FIRST USE 4-5-2007; IN COMMERCE 4-5-2007.

STEVEN R. FINE, EXAMINING ATTORNEY

CLASS 37—(Continued).

SN 77-157,441. GUY MARESH L, AURORA, OR. FILED 4-16-2007.

OneServNet

THE MARK CONSISTS OF STANDARD CHARACTERS WITHOUT CLAIM TO ANY PARTICULAR FONT, STYLE, SIZE, OR COLOR.

FOR VEHICLE MAINTENANCE CONSULTATION; VEHICLE REPAIR AND MAINTENANCE; VEHICLE SERVICE STATIONS; REPAIR OR MAINTENANCE OF COMPUTERS; AIRCRAFT MAINTENANCE OR REPAIR; AIRCRAFT REPAIR AND MAINTENANCE; AUTOMOBILE REPAIR AND MAINTENANCE; AUTOMOTIVE MAINTENANCE AND REPAIR; CAR REPAIR AND MAINTENANCE; INFORMATION WITH RELATION TO AIRCRAFT CONSTRUCTION, REPAIR AND MAINTENANCE; MAINTENANCE AND REPAIR OF COMPUTER HARDWARE; MAINTENANCE AND REPAIR OF COMPUTER NETWORKS; MAINTENANCE AND REPAIR OF TELECOMMUNICATIONS NETWORKS; APPARATUS, AND INSTRUMENTS; MAINTENANCE AND SERVICING OF MEDICAL IMAGING APPARATUS USED IN MEDICAL IMAGING CENTERS; MAINTENANCE OF COMPUTER HARDWARE; MAINTENANCE OF MEDICAL APPARATUS AND INSTRUMENTS; REPAIR AND MAINTENANCE OF AIRCRAFT; REPAIR OR MAINTENANCE OF AUTOMOBILES; REPAIR OR MAINTENANCE OF MEDICAL MACHINES AND APPARATUS (U.S. CLS. 100, 103 AND 106).

HEATHER SAPP, EXAMINING ATTORNEY

SN 77-157,504. POWERHOUSE, INC., TALLAHASSEE, FL. FILED 4-16-2007.

Welaunee

THE MARK CONSISTS OF STANDARD CHARACTERS WITHOUT CLAIM TO ANY PARTICULAR FONT, STYLE, SIZE, OR COLOR.

FOR REAL ESTATE DEVELOPMENT; REAL ESTATE SITE SELECTION (U.S. CLS. 100, 103 AND 106).
FIRST USE 11-25-2002; IN COMMERCE 11-25-2002.
LANA PHAM, EXAMINING ATTORNEY

CLASS 37—(Continued).

SN 77-157,632. AL HARRIS PEST CONTROL, INC., SARASOTA, FL. FILED 4-16-2007.

WE DO IT ALL
BATS TO RATS AND BEES TO
FLEAS
TERMITES & PROTECTION
POLICY
ANIMAL TRAPPING

THE MARK CONSISTS OF STANDARD CHARACTERS WITHOUT CLAIM TO ANY PARTICULAR FONT, STYLE, SIZE, OR COLOR.

NO CLAIM IS MADE TO THE EXCLUSIVE RIGHT TO USE "TERMITES & PROTECTION POLICY ANIMAL TRAPPING", APART FROM THE MARK AS SHOWN.

FOR PEST AND TERMITE CONTROL (U.S. CLS. 100, 103 AND 106).

FIRST USE 1-31-2002; IN COMMERCE 1-31-2002.
CYNTHIA SLOAN, EXAMINING ATTORNEY

SN 77-159,002. PROPCARE, INC., COLUMBIA, SC. FILED 4-17-2007.

GREENOVATION

THE MARK CONSISTS OF STANDARD CHARACTERS WITHOUT CLAIM TO ANY PARTICULAR FONT, STYLE, SIZE, OR COLOR.

FOR RENOVATION IN THE FIELD OF HOMES (U.S. CLS. 100, 103 AND 106).

FIRST USE 1-1-2007; IN COMMERCE 3-1-2007.
KIMBERLY FRYE, EXAMINING ATTORNEY

SN 77-159,476. KB HOME, LOS ANGELES, CA. FILED 4-18-2007.

BUILT
TO ORDER

NO CLAIM IS MADE TO THE EXCLUSIVE RIGHT TO USE "BUILT TO ORDER", APART FROM THE MARK AS SHOWN.

FOR CONSTRUCTION SERVICES, NAMELY, PLANNING, LAYING OUT AND CONSTRUCTION OF RESIDENTIAL COMMUNITIES; CONSTRUCTION OF SINGLE FAMILY AND MULTIPLE FAMILY DWELLING UNITS; REAL ESTATE DEVELOPMENT (U.S. CLS. 100, 103 AND 106).

FIRST USE 11-0-2006; IN COMMERCE 11-0-2006.
GEOFFREY FOSDICK, EXAMINING ATTORNEY

CLASS 37—(Continued).

SN 77-159,480. KB HOME, LOS ANGELES, CA. FILED 4-18-2007.



NO CLAIM IS MADE TO THE EXCLUSIVE RIGHT TO USE "BUILT TO ORDER", APART FROM THE MARK AS SHOWN.

THE COLOR(S) GRAY, BROWN, WHITE, GRAYISH-BLUE, BLACK, BLUE, TEAL AND TAN IS/ARE CLAIMED AS A FEATURE OF THE MARK.

THE MARK CONSISTS OF A BROWN SQUARE WITH A WHITE LETTER B IN THE CENTER WITH A WHITE CIRCLE ABOVE THE LETTER B. A GRAYISH-BLUE SQUARE WITH A WHITE LETTER U IN THE CENTER WITH A WHITE CIRCLE ABOVE THE LETTER U. A BLUE SQUARE WITH A WHITE LETTER I IN THE CENTER WITH A WHITE CIRCLE ABOVE THE LETTER I. A TEAL SQUARE WITH A WHITE LETTER L IN THE CENTER WITH A WHITE CIRCLE ABOVE THE LETTER L. A TAN SQUARE WITH A WHITE LETTER T IN THE CENTER WITH A WHITE CIRCLE ABOVE THE LETTER T. THE WORDS TO ORDER ARE IN BLACK LETTERS INSIDE OF A WHITE RECTANGLE THAT IS OUTLINED IN GRAY.

FOR CONSTRUCTION SERVICES, NAMELY, PLANNING, LAYING OUT AND CONSTRUCTION OF RESIDENTIAL COMMUNITIES; CONSTRUCTION OF SINGLE FAMILY AND MULTIPLE FAMILY DWELLING UNITS; REAL ESTATE DEVELOPMENT (U.S. CLS. 100, 103 AND 106).

FIRST USE 11-0-2006; IN COMMERCE 11-0-2006.
GEOFFREY FOSDICK, EXAMINING ATTORNEY

SN 77-159,735. MARK STEVEN RUZICKA, LUBBOCK, TX. FILED 4-18-2007.

Hard Tops

THE MARK CONSISTS OF STANDARD CHARACTERS WITHOUT CLAIM TO ANY PARTICULAR FONT, STYLE, SIZE, OR COLOR.

FOR REFINISHING OF BATHTUBS, COUNTERTOPS, TILE (U.S. CLS. 100, 103 AND 106).

FIRST USE 4-15-1990; IN COMMERCE 4-15-1990.
ANDREW RHIM, EXAMINING ATTORNEY

CLASS 37—(Continued).

SN 77-160,047. FELDCO FACTORY DIRECT, LLC, NORRIDGE, IL. FILED 4-18-2007.

FELDCO

THE MARK CONSISTS OF STANDARD CHARACTERS WITHOUT CLAIM TO ANY PARTICULAR FONT, STYLE, SIZE, OR COLOR.

FOR INSTALLATION, REPAIR AND MAINTENANCE OF VINYL SIDING, WINDOWS, SOFFITS, GUTTERS AND TRIM, NON-METAL DOORS, SCREEN DOORS, STORM DOORS, SECURITY DOORS, PATIO DOORS, NON-METAL WINDOW SCREENS AND RELATED ACCESSORIES (U.S. CLS. 100, 103 AND 106).

FIRST USE 12-1-1993; IN COMMERCE 12-1-1993.
TASNEEM HUSSAIN, EXAMINING ATTORNEY

SN 77-160,058. NAP TOOLS LLC, JASPER, IN. FILED 4-18-2007.

NAP GLADU

THE MARK CONSISTS OF STANDARD CHARACTERS WITHOUT CLAIM TO ANY PARTICULAR FONT, STYLE, SIZE, OR COLOR.

OWNER OF U.S. REG. NO. 3,023,357.
FOR MAINTENANCE AND REPAIR OF CUTTING TOOLS FOR OTHERS (U.S. CLS. 100, 103 AND 106).

FIRST USE 3-23-2007; IN COMMERCE 3-23-2007.
ELLEN B. AWRICH, EXAMINING ATTORNEY

SN 77-160,078. NAP TOOLS LLC, JASPER, IN. FILED 4-18-2007.

OWNER OF U.S. REG. NO. 3,023,357.
FOR MAINTENANCE AND REPAIR OF CUTTING TOOLS FOR OTHERS (U.S. CLS. 100, 103 AND 106).

FIRST USE 3-23-2007; IN COMMERCE 3-23-2007.
ELLEN B. AWRICH, EXAMINING ATTORNEY

CLASS 37—(Continued).

SN 77-160,107. MCHANDY SERVICES LLC, ASHBURN, VA. FILED 4-18-2007.



FOR BUILDING CONSTRUCTION AND REPAIR (U.S. CLS. 100, 103 AND 106).
CHRISTINE COOPER, EXAMINING ATTORNEY

SN 77-160,295. PROFESSIONAL CARPET SYSTEMS, INC., RALEIGH, NC. FILED 4-19-2007.



THE MARK CONSISTS OF DOG HAVING SPOTS REMOVED BY CLEANING TOOL.
FOR CARPET AND RUG CLEANING (U.S. CLS. 100, 103 AND 106).
FIRST USE 4-7-2000; IN COMMERCE 5-5-2000.
ERNEST SHOSHO, EXAMINING ATTORNEY

SN 77-160,518. PHOENIX SCALE COMPANY, GLENDALE, AZ. FILED 4-19-2007.

LAUNDRY-TRAK

THE MARK CONSISTS OF STANDARD CHARACTERS WITHOUT CLAIM TO ANY PARTICULAR FONT, STYLE, SIZE, OR COLOR.
FOR LAUNDRY SERVICES (U.S. CLS. 100, 103 AND 106).
GIANCARLO CASTRO, EXAMINING ATTORNEY

CLASS 37—(Continued).

SN 77-160,728. PROFESSIONAL CARPET SYSTEMS, INC., RALEIGH, NC. FILED 4-19-2007.

Professional Carpet Systems

THE MARK CONSISTS OF STANDARD CHARACTERS WITHOUT CLAIM TO ANY PARTICULAR FONT, STYLE, SIZE, OR COLOR.
OWNER OF U.S. REG. NOS. 1,539,649 AND 2,442,880. SEC. 2(F).
FOR CARPET AND RUG CLEANING (U.S. CLS. 100, 103 AND 106).
FIRST USE 12-10-1977; IN COMMERCE 12-10-1977.
ERNEST SHOSHO, EXAMINING ATTORNEY

SN 77-160,732. EVERBLAK INC., ROCHESTER, NY. FILED 4-19-2007.

EVERBLAK

THE MARK CONSISTS OF STANDARD CHARACTERS WITHOUT CLAIM TO ANY PARTICULAR FONT, STYLE, SIZE, OR COLOR.
FOR PAVING CONTRACTOR SERVICES (U.S. CLS. 100, 103 AND 106).
FIRST USE 4-30-2006; IN COMMERCE 4-30-2006.
GEORGE LORENZO, EXAMINING ATTORNEY

SN 77-160,850. MARTIN, TODD E., KENOSHA, WI. FILED 4-19-2007.

Dog of All Trades



OWNER OF U.S. REG. NOS. 2,910,881 AND 3,055,123.
THE MARK CONSISTS OF A DOG WITH VARIOUS TOOLS.
FOR BUILDING CONSTRUCTION SERVICES (U.S. CLS. 100, 103 AND 106).
FIRST USE 4-1-2007; IN COMMERCE 4-1-2007.
JOHN DWYER, EXAMINING ATTORNEY

CLASS 37—(Continued).

SN 77-162,342. BASILIO, AUGUSTO, SAN FRANCISCO, CA. FILED 4-20-2007.

Got A Plumber?

THE MARK CONSISTS OF STANDARD CHARACTERS WITHOUT CLAIM TO ANY PARTICULAR FONT, STYLE, SIZE, OR COLOR.
FOR PLUMBING SERVICES (U.S. CLS. 100, 103 AND 106).
BRIDGETT SMITH, EXAMINING ATTORNEY

SN 77-166,407. LANDOLFI, JOSEPH, NORTH LAS VEGAS, NV. FILED 4-26-2007.

LEVELING THE COMPETITION

THE MARK CONSISTS OF STANDARD CHARACTERS WITHOUT CLAIM TO ANY PARTICULAR FONT, STYLE, SIZE, OR COLOR.
FOR CONSTRUCTION AND RENOVATION OF BUILDINGS (U.S. CLS. 100, 103 AND 106).
FIRST USE 2-28-2007; IN COMMERCE 2-28-2007.
VERNA BETH RIRIE, EXAMINING ATTORNEY

SN 77-166,432. LANDOLFI, JOSEPH, NORTH LAS VEGAS, NV. FILED 4-26-2007.

HOW DOES YOUR CONTRACTOR MEASURE UP?

THE MARK CONSISTS OF STANDARD CHARACTERS WITHOUT CLAIM TO ANY PARTICULAR FONT, STYLE, SIZE, OR COLOR.
FOR CONSTRUCTION AND RENOVATION OF BUILDINGS (U.S. CLS. 100, 103 AND 106).
FIRST USE 2-28-2007; IN COMMERCE 2-28-2007.
VERNA BETH RIRIE, EXAMINING ATTORNEY

CLASS 37—(Continued).

SN 77-191,641. TETZLOFF, JAY E., DBA FLEETWHEEL, BLOOMINGTON, MN. FILED 5-29-2007.

TRU-FLANGE

THE MARK CONSISTS OF STANDARD CHARACTERS WITHOUT CLAIM TO ANY PARTICULAR FONT, STYLE, SIZE, OR COLOR.
FOR CLEANING AND POLISHING OF VEHICLE WHEELS (U.S. CLS. 100, 103 AND 106).
FIRST USE 5-31-2007; IN COMMERCE 5-31-2007.
SHAUNIA CARLYLE, EXAMINING ATTORNEY

SN 77-214,818. DELAWARE CAPITAL FORMATION, INC., WILMINGTON, DE. FILED 6-25-2007.



OWNER OF U.S. REG. NOS. 2,015,109, 2,895,652 AND OTHERS.

THE MARK CONSISTS OF THREE BARS WITH TRIANGLES APPEARING INSIDE THE BARS ON THE LEFT SIDE OF THE WORD "CHIEF".

FOR PROVIDING VEHICLE SPECIFICATION INFORMATION FOR USE IN THE DIAGNOSIS, MAINTENANCE AND REPAIR OF VEHICLES, VEHICLE SYSTEMS AND PARTS THEREOF (U.S. CLS. 100, 103 AND 106).

FIRST USE 8-0-2005; IN COMMERCE 8-0-2005.

SUSAN LESLIE DUBOIS, EXAMINING ATTORNEY

SN 78-970,419. PS DEL GRANO II, CHICAGO, IL. FILED 9-8-2006.

PRIVADO

THE MARK CONSISTS OF STANDARD CHARACTERS WITHOUT CLAIM TO ANY PARTICULAR FONT, STYLE, SIZE, OR COLOR.

THE FOREIGN WORDING IN THE MARK TRANSLATES INTO ENGLISH AS PRIVATE.

FOR REAL ESTATE DEVELOPMENT OF RESIDENTIAL AND COMMERCIAL PROPERTY (U.S. CLS. 100, 103 AND 106).

WILLIAM P. SHANAHAN, EXAMINING ATTORNEY

CLASS 37—(Continued).

SN 78-971,095. ALL PRO PEST SERVICES, INC., MARIETTA, GA. FILED 9-11-2006.

The logo features the words "IPM PROPLAN" in a bold, stylized font. The letter "O" in "PROPLAN" is replaced by a target symbol. Above the word "PROPLAN" is the text "HOME PROTECTOR" in a smaller, sans-serif font.

NO CLAIM IS MADE TO THE EXCLUSIVE RIGHT TO USE "IPM" AND "HOME PROTECTOR", APART FROM THE MARK AS SHOWN.

THE MARK CONSISTS OF THE TERMS IPM PROPLAN HOME PROTECTOR WITH THE LETTER O IN THE TERM PROPLAN STYLIZED AS A TARGET.

FOR RESIDENTIAL PEST CONTROL AND TERMITE EXTERMINATION SERVICES (U.S. CLS. 100, 103 AND 106).

FIRST USE 12-31-1992; IN COMMERCE 12-31-1992.
DAHLIA GEORGE, EXAMINING ATTORNEY

SN 78-971,339. ALL PRO PEST SERVICES, INC., MARIETTA, GA. FILED 9-11-2006.

COMMERCIAL P+US

THE MARK CONSISTS OF STANDARD CHARACTERS WITHOUT CLAIM TO ANY PARTICULAR FONT, STYLE, SIZE, OR COLOR.

NO CLAIM IS MADE TO THE EXCLUSIVE RIGHT TO USE "COMMERCIAL", APART FROM THE MARK AS SHOWN.

FOR COMMERCIAL PEST CONTROL AND TERMITE EXTERMINATION SERVICES (U.S. CLS. 100, 103 AND 106).

FIRST USE 12-31-2003; IN COMMERCE 12-31-2003.
BARBARA RUTLAND, EXAMINING ATTORNEY

SN 78-974,326. THERMA-SHIELD SOLAR CONTROL WINDOW FILMS, LLC, CHATTAROY, WA. FILED 9-14-2006.

The logo features a stylized sun with rays above the word "Therma-Shield" in a bold, italicized font. Below this, the words "SOLAR CONTROL WINDOW FILMS, LLC" are written in a smaller, sans-serif font.

NO CLAIM IS MADE TO THE EXCLUSIVE RIGHT TO USE "SOLAR CONTROL WINDOW FILMS, LLC", APART FROM THE MARK AS SHOWN.

THE MARK CONSISTS OF A SUN, A SHIELD AND STYLIZED TEXT OF THE WORDS, "THERMA-SHIELD SOLAR CONTROL WINDOW FILMS, LLC".

FOR INSTALLATION OF SOLAR REFLECTIVE FILMS AND TINTS TO EXISTING COMMERCIAL AND RESIDENTIAL WINDOWS (U.S. CLS. 100, 103 AND 106).

FIRST USE 4-0-1994; IN COMMERCE 4-0-1994.
JENNY PARK, EXAMINING ATTORNEY

CLASS 38—COMMUNICATION

SN 76-673,080. GONOGGING, INC., MARLBORO, NY. FILED 2-23-2007.

GONOGGING

THE MARK CONSISTS OF STANDARD CHARACTERS WITHOUT CLAIM TO ANY PARTICULAR FONT, STYLE, SIZE, OR COLOR.

FOR TRANSMISSION OF MESSAGES OVER ELECTRONIC MEDIA (U.S. CLS. 100, 101 AND 104).
INGA ERVIN, EXAMINING ATTORNEY

SN 77-054,461. COLLEGENET, INC., PORTLAND, OR. FILED 11-30-2006.

IT PAYS TO THINK

THE MARK CONSISTS OF STANDARD CHARACTERS WITHOUT CLAIM TO ANY PARTICULAR FONT, STYLE, SIZE, OR COLOR.

FOR COMMUNICATION SERVICES, NAMELY, PROVIDING ON-LINE FORUMS FOR TRANSMISSION OF MESSAGES AMONG COMPUTER USERS FOR EARNING STUDENT SCHOLARSHIPS (U.S. CLS. 100, 101 AND 104).

PATRICIA EVANKO, EXAMINING ATTORNEY

SN 77-070,605. KARSTEN MANUFACTURING CORPORATION, PHOENIX, AZ. FILED 12-22-2006.

PING

THE MARK CONSISTS OF STANDARD CHARACTERS WITHOUT CLAIM TO ANY PARTICULAR FONT, STYLE, SIZE, OR COLOR.

OWNER OF U.S. REG. NOS. 1,637,647, 2,909,188 AND 3,171,974.

FOR CONSUMER TELECOMMUNICATION SERVICES, NAMELY, COMMUNICATIONS SERVICES FOR ELECTRONICALLY EXCHANGING DATA AND GRAPHICS VIA TELECOMMUNICATION NETWORKS, INCLUDING MOBILE AND WIRELESS NETWORKS (U.S. CLS. 100, 101 AND 104).

RAY THOMAS, EXAMINING ATTORNEY

CLASS 38—(Continued).

SN 77-092,870. MESSAGE NOVA, LLC, DENVER, CO. FILED 1-27-2007.

MESSAGENOVA

THE MARK CONSISTS OF STANDARD CHARACTERS WITHOUT CLAIM TO ANY PARTICULAR FONT, STYLE, SIZE, OR COLOR.

FOR ELECTRONIC TRANSMISSION OF MESSAGES VIA EMAIL, VOICEMAIL, INSTANT MESSAGING, AND TEXT MESSAGING, ACCESSIBLE VIA THE INTERNET, IN THE FIELD OF GLOBAL INFORMATION NETWORKS AND ONLINE INFORMATION SERVICES (U.S. CLS. 100, 101 AND 104).

TRACY WHITTAKER-BROWN, EXAMINING ATTORNEY

CLASS 38—(Continued).

SN 77-095,480. UNIVERSITY CORPORATION FOR ADVANCED INTERNET DEVELOPMENT, WASHINGTON, DC. FILED 1-31-2007.

MANHATTAN LANDING

THE MARK CONSISTS OF STANDARD CHARACTERS WITHOUT CLAIM TO ANY PARTICULAR FONT, STYLE, SIZE, OR COLOR.

NO CLAIM IS MADE TO THE EXCLUSIVE RIGHT TO USE "MANHATTAN", APART FROM THE MARK AS SHOWN.

FOR NETWORK INTERCONNECTION SERVICES, NAMELY, OPTICAL, ETHERNET AND INTERNET DATA TRANSMISSION SERVICES; PROVIDING ACCESS TO DATA OR DOCUMENTS STORED ELECTRONICALLY IN CENTRAL FILES FOR REMOTE CONSULTATION; PROVIDING MULTIPLE USER ACCESS TO A GLOBAL COMPUTER INFORMATION NETWORK (U.S. CLS. 100, 101 AND 104).

FIRST USE 3-0-2003; IN COMMERCE 5-0-2003.
ELLEN PERKINS, EXAMINING ATTORNEY

SN 77-095,473. UNIVERSITY CORPORATION FOR ADVANCED INTERNET DEVELOPMENT, WASHINGTON, DC. FILED 1-31-2007.

MAN LAN

THE MARK CONSISTS OF STANDARD CHARACTERS WITHOUT CLAIM TO ANY PARTICULAR FONT, STYLE, SIZE, OR COLOR.

NO CLAIM IS MADE TO THE EXCLUSIVE RIGHT TO USE "LAN", APART FROM THE MARK AS SHOWN.

FOR NETWORK INTERCONNECTION SERVICES, NAMELY, OPTICAL, ETHERNET AND INTERNET DATA TRANSMISSION SERVICES; PROVIDING ACCESS TO DATA OR DOCUMENTS STORED ELECTRONICALLY IN CENTRAL FILES FOR REMOTE CONSULTATION; PROVIDING MULTIPLE USER ACCESS TO A GLOBAL COMPUTER INFORMATION NETWORK (U.S. CLS. 100, 101 AND 104).

FIRST USE 3-0-2003; IN COMMERCE 5-0-2003.
ELLEN PERKINS, EXAMINING ATTORNEY

SN 77-131,177. FULL SERVICE NETWORK LP, FORT LAUDERDALE, FL. FILED 3-14-2007.

**Full Service
Network**

NO CLAIM IS MADE TO THE EXCLUSIVE RIGHT TO USE "FULL SERVICE NETWORK", APART FROM THE MARK AS SHOWN.

THE MARK CONSISTS OF THE LITERAL ELEMENT FULL SERVICE NETWORK AND A SERIES OF RECTANGLES.

FOR TELECOMMUNICATIONS SERVICES IN THE NATURE OF ELECTRONIC TRANSMISSION OF VOICE, DATA AND VIDEO IMAGES (U.S. CLS. 100, 101 AND 104).

FIRST USE 8-0-1990; IN COMMERCE 8-0-1990.
PATRICIA EVANKO, EXAMINING ATTORNEY

CLASS 38—(Continued).

SN 77-157,158. GOTTFURCHT, GRANT E., PACIFIC PALISADES, CA. FILED 4-16-2007.

America's Greatest Asset

THE MARK CONSISTS OF STANDARD CHARACTERS WITHOUT CLAIM TO ANY PARTICULAR FONT, STYLE, SIZE, OR COLOR.

FOR BROADCAST OF CABLE TELEVISION PROGRAMMES; CABLE TELEVISION BROADCASTING; CABLE TELEVISION TRANSMISSION; COMMUNICATION VIA RADIO, TELEGRAPH, TELEPHONE AND TELEVISION TRANSMISSIONS; COMMUNICATIONS BY TELEVISION FOR MEETING; COMMUNICATIONS SERVICES, NAMELY, TRANSMITTING STREAMED SOUND AND AUDIO-VISUAL RECORDINGS VIA THE INTERNET; ELECTRONIC TRANSMISSION OF VOICE, DATA AND IMAGES BY TELEVISION AND VIDEO BROADCASTING; MOBILE MEDIA SERVICES IN THE NATURE OF ELECTRONIC TRANSMISSION OF ENTERTAINMENT MEDIA CONTENT; PAY-PER-VIEW TELEVISION TRANSMISSION SERVICES; RENTAL OF SET-TOP BOXES FOR USE WITH TELEVISIONS; SATELLITE TELEVISION BROADCASTING; SUBSCRIPTION TELEVISION BROADCASTING; TELEVISION AND RADIO BROADCASTING SERVICES; TELEVISION BROADCASTING; TELEVISION BROADCASTING CONSULTATION; TELEVISION BROADCASTING INFORMATION; TELEVISION PROGRAMME BROADCASTING VIA CABLE; TELEVISION TRANSMISSION SERVICES (U.S. CLS. 100, 101 AND 104).

TONI HICKEY, EXAMINING ATTORNEY

SN 77-157,191. AURIS TECHNOLOGY, DORAL, FL. FILED 4-16-2007.

Mobilexpert

THE MARK CONSISTS OF STANDARD CHARACTERS WITHOUT CLAIM TO ANY PARTICULAR FONT, STYLE, SIZE, OR COLOR.

FOR WIRELESS TELEPHONE TELECOMMUNICATIONS SERVICES, NAMELY, WIRELESS MOBILE TELEPHONE CALLING PLANS (U.S. CLS. 100, 101 AND 104).

CHRIS WELLS, EXAMINING ATTORNEY

CLASS 38—(Continued).

SN 77-157,992. GLOBAL COMMUNICATIONS, INC., BEAUMONT, TX. FILED 4-16-2007.

VUTP

THE MARK CONSISTS OF STANDARD CHARACTERS WITHOUT CLAIM TO ANY PARTICULAR FONT, STYLE, SIZE, OR COLOR.

FOR BROADCASTING PROGRAMS VIA A GLOBAL COMPUTER NETWORK; BROADCASTING SERVICES AND PROVISION OF TELECOMMUNICATION ACCESS TO VIDEO AND AUDIO CONTENT PROVIDED VIA A VIDEO-ON-DEMAND SERVICE; PROVIDING A HIGH SPEED ACCESS TO AREA NETWORKS AND A GLOBAL COMPUTER INFORMATION NETWORK; PROVIDING PRIVATE AND SECURE REAL TIME ELECTRONIC COMMUNICATION OVER A COMPUTER NETWORK; VIDEO-ON-DEMAND TRANSMISSION SERVICES; BROADCASTING INTERACTIVE PROGRAMS VIA A GLOBAL COMPUTER NETWORK (U.S. CLS. 100, 101 AND 104).

HEATHER THOMPSON, EXAMINING ATTORNEY

SN 77-157,997. GLOBAL COMMUNICATIONS, INC., BEAUMONT, TX. FILED 4-16-2007.



THE MARK CONSISTS OF THE TEXT "V.U.T.P." SUPERIMPOSED OVER TWO SPHERES WHERE U.T.P. IS OVER A FIRST LARGER SPHERE AND V. IS OVER A SECOND SMALLER SPHERE WITH ALL TEXT AND SPHERE ELEMENTS WITHIN A CIRCLE.

FOR BROADCASTING PROGRAMS VIA A GLOBAL COMPUTER NETWORK; BROADCASTING SERVICES AND PROVISION OF TELECOMMUNICATION ACCESS TO VIDEO AND AUDIO CONTENT PROVIDED VIA A VIDEO-ON-DEMAND SERVICE; PROVIDING A HIGH SPEED ACCESS TO AREA NETWORKS AND A GLOBAL COMPUTER INFORMATION NETWORK; PROVIDING PRIVATE AND SECURE REAL TIME ELECTRONIC COMMUNICATION OVER A COMPUTER NETWORK; VIDEO-ON-DEMAND TRANSMISSION SERVICES; BROADCASTING INTERACTIVE PROGRAMS VIA A GLOBAL COMPUTER NETWORK (U.S. CLS. 100, 101 AND 104).

HEATHER THOMPSON, EXAMINING ATTORNEY

CLASS 38—(Continued).

SN 77-158,000. GLOBAL COMMUNICATIONS, INC., BEAUMONT, TX. FILED 4-16-2007.

VUTP BROADCAST SPECTRUM

THE MARK CONSISTS OF STANDARD CHARACTERS WITHOUT CLAIM TO ANY PARTICULAR FONT, STYLE, SIZE, OR COLOR.

NO CLAIM IS MADE TO THE EXCLUSIVE RIGHT TO USE "BROADCAST SPECTRUM", APART FROM THE MARK AS SHOWN.

FOR BROADCASTING PROGRAMS VIA A GLOBAL COMPUTER NETWORK; BROADCASTING SERVICES AND PROVISION OF TELECOMMUNICATION ACCESS TO VIDEO AND AUDIO CONTENT PROVIDED VIA A VIDEO-ON-DEMAND SERVICE; PROVIDING A HIGH SPEED ACCESS TO AREA NETWORKS AND A GLOBAL COMPUTER INFORMATION NETWORK; PROVIDING PRIVATE AND SECURE REAL TIME ELECTRONIC COMMUNICATION OVER A COMPUTER NETWORK; VIDEO-ON-DEMAND TRANSMISSION SERVICES; BROADCASTING INTERACTIVE PROGRAMS VIA A GLOBAL COMPUTER NETWORK (U.S. CLS. 100, 101 AND 104).

HEATHER THOMPSON, EXAMINING ATTORNEY

CLASS 38—(Continued).

SN 77-158,225. SMARTSYNCH, INC., JACKSON, MS. FILED 4-17-2007.

Get Enabled

THE MARK CONSISTS OF STANDARD CHARACTERS WITHOUT CLAIM TO ANY PARTICULAR FONT, STYLE, SIZE, OR COLOR.

FOR WIRELESS TRANSMISSION OF UTILITY METER DATA BETWEEN A DATA COMPUTING NETWORK AND REMOTE COMMUNICATION DEVICES (U.S. CLS. 100, 101 AND 104).

FIRST USE 3-0-2006; IN COMMERCE 3-0-2006.

KALIE KUNG, EXAMINING ATTORNEY

SN 77-158,229. SMARTSYNCH, INC., JACKSON, MS. FILED 4-17-2007.

Embrace the Power of Information

THE MARK CONSISTS OF STANDARD CHARACTERS WITHOUT CLAIM TO ANY PARTICULAR FONT, STYLE, SIZE, OR COLOR.

FOR WIRELESS TRANSMISSION OF UTILITY METER DATA BETWEEN A DATA COMPUTING NETWORK AND REMOTE COMMUNICATION DEVICES (U.S. CLS. 100, 101 AND 104).

FIRST USE 1-1-2007; IN COMMERCE 1-1-2007.

KALIE KUNG, EXAMINING ATTORNEY

SN 77-158,006. GLOBAL COMMUNICATIONS, INC., BEAUMONT, TX. FILED 4-16-2007.

VUTP ARCHITECTURE

THE MARK CONSISTS OF STANDARD CHARACTERS WITHOUT CLAIM TO ANY PARTICULAR FONT, STYLE, SIZE, OR COLOR.

NO CLAIM IS MADE TO THE EXCLUSIVE RIGHT TO USE "ARCHITECTURE", APART FROM THE MARK AS SHOWN.

FOR BROADCASTING PROGRAMS VIA A GLOBAL COMPUTER NETWORK; BROADCASTING SERVICES AND PROVISION OF TELECOMMUNICATION ACCESS TO VIDEO AND AUDIO CONTENT PROVIDED VIA A VIDEO-ON-DEMAND SERVICE; PROVIDING A HIGH SPEED ACCESS TO AREA NETWORKS AND A GLOBAL COMPUTER INFORMATION NETWORK; PROVIDING PRIVATE AND SECURE REAL TIME ELECTRONIC COMMUNICATION OVER A COMPUTER NETWORK; VIDEO-ON-DEMAND TRANSMISSION SERVICES; BROADCASTING INTERACTIVE PROGRAMS VIA A GLOBAL COMPUTER NETWORK (U.S. CLS. 100, 101 AND 104).

HEATHER THOMPSON, EXAMINING ATTORNEY

SN 77-158,252. SMARTSYNCH, INC., JACKSON, MS. FILED 4-17-2007.

Power through Innovation

THE MARK CONSISTS OF STANDARD CHARACTERS WITHOUT CLAIM TO ANY PARTICULAR FONT, STYLE, SIZE, OR COLOR.

FOR WIRELESS TRANSMISSION OF UTILITY METER DATA BETWEEN A DATA COMPUTING NETWORK AND REMOTE COMMUNICATION DEVICES (U.S. CLS. 100, 101 AND 104).

KALIE KUNG, EXAMINING ATTORNEY

CLASS 38—(Continued).

SN 77-158,880. SPIKESOURCE, INC., MENLO PARK, CA. FILED 4-17-2007.

SUITETWO

THE MARK CONSISTS OF STANDARD CHARACTERS WITHOUT CLAIM TO ANY PARTICULAR FONT, STYLE, SIZE, OR COLOR.

FOR PROVIDING ON-LINE FORUMS FOR TRANSMISSION OF MESSAGES AMONG COMPUTER USERS CONCERNING SOFTWARE AND INTERNET APPLICATIONS AND TECHNOLOGY (U.S. CLS. 100, 101 AND 104).

PETER CHENG, EXAMINING ATTORNEY

SN 77-159,460. ONE WORLD TELECOMMUNICATIONS HOLDINGS LTD, CENTRAL, HONG KONG, FILED 4-18-2007.

OWTALK IN

THE MARK CONSISTS OF STANDARD CHARACTERS WITHOUT CLAIM TO ANY PARTICULAR FONT, STYLE, SIZE, OR COLOR.

FOR TELECOMMUNICATIONS RESELLER SERVICES, NAMELY, PROVIDING LONG DISTANCE TELECOMMUNICATION SERVICES (U.S. CLS. 100, 101 AND 104).

LAURA KOVALSKY, EXAMINING ATTORNEY

SN 77-160,933. AUSTIN MUSIC PARTNERS, LLC, AUSTIN, TX. FILED 4-19-2007.

M*E

THE MARK CONSISTS OF STANDARD CHARACTERS WITHOUT CLAIM TO ANY PARTICULAR FONT, STYLE, SIZE, OR COLOR.

FOR CABLE TELEVISION BROADCASTING; TELEVISION BROADCASTING (U.S. CLS. 100, 101 AND 104).

ROSELLE HERRERA, EXAMINING ATTORNEY

CLASS 38—(Continued).

SN 77-160,961. AUSTIN MUSIC PARTNERS, LLC, AUSTIN, TX. FILED 4-19-2007.

M&E

THE MARK CONSISTS OF STANDARD CHARACTERS WITHOUT CLAIM TO ANY PARTICULAR FONT, STYLE, SIZE, OR COLOR.

FOR CABLE TELEVISION BROADCASTING; TELEVISION BROADCASTING (U.S. CLS. 100, 101 AND 104).

ROSELLE HERRERA, EXAMINING ATTORNEY

SN 77-160,979. AUSTIN MUSIC PARTNERS, LLC, AUSTIN, TX. FILED 4-19-2007.

MESTAR

THE MARK CONSISTS OF STANDARD CHARACTERS WITHOUT CLAIM TO ANY PARTICULAR FONT, STYLE, SIZE, OR COLOR.

FOR CABLE TELEVISION BROADCASTING; TELEVISION BROADCASTING (U.S. CLS. 100, 101 AND 104).

ROSELLE HERRERA, EXAMINING ATTORNEY

SN 77-161,748. OBERGOENNER, DAVID, CAPE GIRARDEAU, MO. FILED 4-20-2007.

HIS MESSAGE IN YOUR MUSIC

THE MARK CONSISTS OF STANDARD CHARACTERS WITHOUT CLAIM TO ANY PARTICULAR FONT, STYLE, SIZE, OR COLOR.

FOR RADIO BROADCASTING; STREAMING OF AUDIO MATERIAL ON THE INTERNET (U.S. CLS. 100, 101 AND 104).

FIRST USE 3-25-2007; IN COMMERCE 3-25-2007.

BARBARA GAYNOR, EXAMINING ATTORNEY

CLASS 38—(Continued).

SN 77-165,430. FM IDAHO CO., LLC, TWIN FALLS, ID. FILED 4-25-2007.

The Man

THE MARK CONSISTS OF STANDARD CHARACTERS WITHOUT CLAIM TO ANY PARTICULAR FONT, STYLE, SIZE, OR COLOR.

FOR RADIO BROADCASTING SERVICES (U.S. CLS. 100, 101 AND 104).

FRANK LATTUCA, EXAMINING ATTORNEY

SN 77-166,041. LESEA BROADCASTING CORPORATION, SOUTH BEND, IN. FILED 4-26-2007.

FETV

THE MARK CONSISTS OF STANDARD CHARACTERS WITHOUT CLAIM TO ANY PARTICULAR FONT, STYLE, SIZE, OR COLOR.

FOR TELEVISION TRANSMISSION AND BROADCASTING SERVICES (U.S. CLS. 100, 101 AND 104).

FIRST USE 5-15-2003; IN COMMERCE 5-15-2003.
JASON BLAIR, EXAMINING ATTORNEY

SN 77-182,446. B2 NETWORKS, INC., DALLAS, TX. FILED 5-16-2007.

WOWEE TV

THE MARK CONSISTS OF STANDARD CHARACTERS WITHOUT CLAIM TO ANY PARTICULAR FONT, STYLE, SIZE, OR COLOR.

NO CLAIM IS MADE TO THE EXCLUSIVE RIGHT TO USE "TV", APART FROM THE MARK AS SHOWN.

FOR BROADCASTING PROGRAMS VIA A GLOBAL COMPUTER NETWORK, BROADBAND, WIRED AND WIRELESS NETWORKS; INTERNET, TELEVISION, VIDEO AND AUDIO BROADCASTING SERVICES; BROADCASTING SERVICES AND PROVISION OF TELECOMMUNICATION ACCESS TO VIDEO AND AUDIO CONTENT, FILMS AND TV PROGRAMS, PROVIDED VIA A VIDEO-ON-DEMAND SERVICE VIA THE INTERNET; AUDIO AND VIDEO BROADCASTING SERVICES OVER THE INTERNET; BROADCASTING SERVICES AND PROVISION OF BROADBAND ACCESS TO LIVE AND DELAYED PROGRAMS VIA PAY-PER-VIEW, SUBSCRIPTION OR FREE VIA BROADBAND ENABLED FIXED OR MOBILE, WIRED OR WIRELESS VIDEO DISPLAY DEVICES; CABLE AND SATELLITE TELEVISION BROADCASTING; SUBSCRIPTION TELEVISION BROADCASTING (U.S. CLS. 100, 101 AND 104).

CHERYL CLAYTON, EXAMINING ATTORNEY

CLASS 38—(Continued).

SN 77-182,491. B2 NETWORKS, INC., DALLAS, TX. FILED 5-16-2007.



NO CLAIM IS MADE TO THE EXCLUSIVE RIGHT TO USE "INTERACTIVE", APART FROM THE MARK AS SHOWN.

THE COLOR(S) BLUE, GREY, BLACK IS/ARE CLAIMED AS A FEATURE OF THE MARK.

THE MARK CONSISTS OF "B2" WRITTEN IN BLUE AND OUTLINED IN GREY, ABOVE THE WORD "INTERACTIVE" WRITTEN IN BLACK, SUPERIMPOSED ON A LIGHT GREY PYRAMID WITH DARK GREY OUTLINING.

FOR BROADCASTING PROGRAMS VIA A GLOBAL COMPUTER NETWORK, BROADBAND, WIRED AND WIRELESS NETWORKS; INTERNET, TELEVISION, VIDEO AND AUDIO BROADCASTING SERVICES; BROADCASTING SERVICES AND PROVISION OF TELECOMMUNICATION ACCESS TO VIDEO AND AUDIO CONTENT, FILMS AND TV PROGRAMS, PROVIDED VIA A VIDEO-ON-DEMAND SERVICE VIA THE INTERNET; AUDIO AND VIDEO BROADCASTING SERVICES OVER THE INTERNET; BROADCASTING SERVICES AND PROVISION OF BROADBAND ACCESS TO LIVE AND DELAYED PROGRAMS VIA PAY-PER-VIEW, SUBSCRIPTION OR FREE VIA BROADBAND ENABLED FIXED OR MOBILE, WIRED OR WIRELESS VIDEO DISPLAY DEVICES; CABLE AND SATELLITE TELEVISION BROADCASTING; SUBSCRIPTION TELEVISION BROADCASTING (U.S. CLS. 100, 101 AND 104).

CHERYL CLAYTON, EXAMINING ATTORNEY

SN 77-182,565. B2 NETWORKS, INC., DALLAS, TX. FILED 5-16-2007.

B2 FAITH

THE MARK CONSISTS OF STANDARD CHARACTERS WITHOUT CLAIM TO ANY PARTICULAR FONT, STYLE, SIZE, OR COLOR.

NO CLAIM IS MADE TO THE EXCLUSIVE RIGHT TO USE "FAITH", APART FROM THE MARK AS SHOWN.

FOR BROADCASTING PROGRAMS VIA A GLOBAL COMPUTER NETWORK, BROADBAND, WIRED AND WIRELESS NETWORKS; INTERNET, TELEVISION, VIDEO AND AUDIO BROADCASTING SERVICES; BROADCASTING SERVICES AND PROVISION OF TELECOMMUNICATION ACCESS TO VIDEO AND AUDIO CONTENT, FILMS AND TV PROGRAMS, PROVIDED VIA A VIDEO-ON-DEMAND SERVICE VIA THE INTERNET; AUDIO AND VIDEO BROADCASTING SERVICES OVER THE INTERNET; BROADCASTING SERVICES AND PROVISION OF BROADBAND ACCESS TO LIVE AND DELAYED PROGRAMS VIA PAY-PER-VIEW, SUBSCRIPTION OR FREE VIA BROADBAND ENABLED FIXED OR MOBILE, WIRED OR WIRELESS VIDEO DISPLAY DEVICES; CABLE AND SATELLITE TELEVISION BROADCASTING; SUBSCRIPTION TELEVISION BROADCASTING (U.S. CLS. 100, 101 AND 104).

FIRST USE 2-1-2007; IN COMMERCE 2-1-2007.
CHERYL CLAYTON, EXAMINING ATTORNEY

CLASS 38—(Continued).

SN 77-182,629. B2 NETWORKS, INC., DALLAS, TX. FILED 5-16-2007.

B2 TELEVISION

THE MARK CONSISTS OF STANDARD CHARACTERS WITHOUT CLAIM TO ANY PARTICULAR FONT, STYLE, SIZE, OR COLOR.

NO CLAIM IS MADE TO THE EXCLUSIVE RIGHT TO USE TELEVISION, APART FROM THE MARK AS SHOWN.

FOR BROADCASTING PROGRAMS VIA A GLOBAL COMPUTER NETWORK, BROADBAND, WIRED AND WIRELESS NETWORKS; INTERNET, TELEVISION, VIDEO AND AUDIO BROADCASTING SERVICES; BROADCASTING SERVICES AND PROVISION OF TELECOMMUNICATION ACCESS TO VIDEO AND AUDIO CONTENT, FILMS AND TV PROGRAMS, PROVIDED VIA A VIDEO-ON-DEMAND SERVICE VIA THE INTERNET; AUDIO AND VIDEO BROADCASTING SERVICES OVER THE INTERNET; BROADCASTING SERVICES AND PROVISION OF BROADBAND ACCESS TO LIVE AND DELAYED PROGRAMS VIA PAY-PER-VIEW, SUBSCRIPTION OR FREE VIA BROADBAND ENABLED FIXED OR MOBILE, WIRED OR WIRELESS VIDEO DISPLAY DEVICES; CABLE AND SATELLITE TELEVISION BROADCASTING; SUBSCRIPTION TELEVISION BROADCASTING (U.S. CLS. 100, 101 AND 104).

FIRST USE 2-1-2007; IN COMMERCE 2-1-2007.
CHERYL CLAYTON, EXAMINING ATTORNEY

SN 77-182,681. B2 NETWORKS, INC., DALLAS, TX. FILED 5-16-2007.

B2 NETWORKS

THE MARK CONSISTS OF STANDARD CHARACTERS WITHOUT CLAIM TO ANY PARTICULAR FONT, STYLE, SIZE, OR COLOR.

NO CLAIM IS MADE TO THE EXCLUSIVE RIGHT TO USE "NETWORKS", APART FROM THE MARK AS SHOWN.

FOR BROADCASTING PROGRAMS VIA A GLOBAL COMPUTER NETWORK, BROADBAND, WIRED AND WIRELESS NETWORKS; INTERNET, TELEVISION, VIDEO AND AUDIO BROADCASTING SERVICES; BROADCASTING SERVICES AND PROVISION OF TELECOMMUNICATION ACCESS TO VIDEO AND AUDIO CONTENT, FILMS AND TV PROGRAMS, PROVIDED VIA A VIDEO-ON-DEMAND SERVICE VIA THE INTERNET; AUDIO AND VIDEO BROADCASTING SERVICES OVER THE INTERNET; BROADCASTING SERVICES AND PROVISION OF BROADBAND ACCESS TO LIVE AND DELAYED PROGRAMS VIA PAY-PER-VIEW, SUBSCRIPTION OR FREE VIA BROADBAND ENABLED FIXED OR MOBILE, WIRED OR WIRELESS VIDEO DISPLAY DEVICES; CABLE AND SATELLITE TELEVISION BROADCASTING; SUBSCRIPTION TELEVISION BROADCASTING (U.S. CLS. 100, 101 AND 104).

FIRST USE 2-1-2003; IN COMMERCE 2-1-2003.
CHERYL CLAYTON, EXAMINING ATTORNEY

CLASS 38—(Continued).

SN 77-184,957. IKWUEZE, LAWRENCE CHUDI, REGO PARK, NY. FILED 5-18-2007.

CLIMENTORS

THE MARK CONSISTS OF STANDARD CHARACTERS WITHOUT CLAIM TO ANY PARTICULAR FONT, STYLE, SIZE, OR COLOR.

FOR PROVIDING ON-LINE FORUMS FOR TRANSMISSION OF MESSAGES AMONG COMPUTER USERS CONCERNING MENTORING SERVICES RELATING TO FAMILY, PERSONAL RELATIONSHIPS, HEALTH, FOOD, HOUSING, CAREER, RACE AND PETS MATTERS WHEREIN SUBSCRIBERS POST THEIR CHALLENGING LIFE CIRCUMSTANCES/EXPERIENCES AND OTHERS POST TO MENTOR/ADVISE IN RESPONSE TO POSTINGS (U.S. CLS. 100, 101 AND 104).

ANDREA K. NADELMAN, EXAMINING ATTORNEY

SN 77-186,660. RECORDCUP INC., HOUSTON, TX. FILED 5-22-2007.



THE COLOR(S) LIGHT RED, DARK RED, WHITE, SILVER, AND GOLD IS/ARE CLAIMED AS A FEATURE OF THE MARK.

THE COLOR WHITE APPEARS ON THE STYLIZED LETTERS R AND C; THE COLOR DARK RED APPEARS ON THE OUTER EDGE OF THE SHADED CIRCLE; THE COLORS LIGHT RED, DARK RED AND GOLD APPEAR ON THE BACKGROUND OF THE SHADED CIRCLE; THE COLOR DARK RED APPEARS ON THE CIRCLE FORMING THE INSIDE OF THE LETTER R; THE COLOR SILVER APPEARS ON THE WORD RECORD; THE COLOR DARK RED APPEARS ON TWO CIRCLES ABOVE THE LETTER O REPRESENTING EYES; THE COLOR GOLD APPEARS ON THE WORD CUP.

FOR COMMUNICATIONS SERVICES, NAMELY, TRANSMITTING STREAMED SOUND AND AUDIO-VISUAL RECORDINGS VIA THE INTERNET; STREAMING OF AUDIO MATERIAL ON THE INTERNET; STREAMING OF VIDEO MATERIAL ON THE INTERNET (U.S. CLS. 100, 101 AND 104).

FIRST USE 5-21-2007; IN COMMERCE 5-21-2007.
COLLEEN DOMBROW, EXAMINING ATTORNEY

CLASS 38—(Continued).

SN 77-187,220. T-MOBILE USA, INC., BELLEVUE, WA.
FILED 5-22-2007.

CLASS 38—(Continued).

SN 77-221,642. DEUTSCHE TELEKOM AG, BONN, FED REP
GERMANY, FILED 7-3-2007.

SIDEKICK SLIDE

THE MARK CONSISTS OF STANDARD CHARACTERS WITHOUT CLAIM TO ANY PARTICULAR FONT, STYLE, SIZE, OR COLOR.

OWNER OF U.S. REG. NOS. 3,012,845, 3,152,740 AND OTHERS.

FOR TELECOMMUNICATIONS SERVICES, NAMELY, WIRELESS VOICE AND DATA TRANSMISSION, TWO WAY WIRELESS TRANSMISSION OF EMAIL AND TEXT BETWEEN WIRELESS TELECOMMUNICATIONS TERMINALS AND COMPUTERS, AND PROVIDING MULTIPLE-USER ACCESS TO A GLOBAL COMPUTER NETWORK (U.S. CLS. 100, 101 AND 104).

JENNIFER KRISP, EXAMINING ATTORNEY

MDA mail

THE MARK CONSISTS OF STANDARD CHARACTERS WITHOUT CLAIM TO ANY PARTICULAR FONT, STYLE, SIZE, OR COLOR.

PRIORITY CLAIMED UNDER SEC. 44(D) ON FED REP GERMANY APPLICATION NO. 30701909838, FILED 1-9-2007, REG. NO. 30701909, DATED 2-22-2007, EXPIRES 1-31-2017.

OWNER OF U.S. REG. NOS. 2,930,993, 2,942,206 AND OTHERS.

NO CLAIM IS MADE TO THE EXCLUSIVE RIGHT TO USE "MAIL", APART FROM THE MARK AS SHOWN.

FOR TELECOMMUNICATION AND INFORMATION TECHNOLOGY SERVICES, NAMELY, ELECTRIC, DIGITAL, CELLULAR AND WIRELESS TRANSMISSION OF VOICE, DATA, INFORMATION IMAGES, SIGNALS AND MESSAGES AND TRANSMISSION OF VOICE, DATA, IMAGES, AUDIO, VIDEO AND INFORMATION VIA TELEPHONE, TELEVISION AND GLOBAL COMMUNICATION NETWORKS; PROVIDING TELECOMMUNICATIONS CONNECTIONS OVER A GLOBAL COMMUNICATIONS NETWORK, ELECTRONIC STORE-AND-FORWARD MESSAGING; RENTAL OF TELECOMMUNICATIONS EQUIPMENT, NAMELY, EQUIPMENT FOR ELECTRONIC ACCESS TO GLOBAL TELECOMMUNICATIONS NETWORK, EQUIPMENT FOR TRANSMITTING, RECEIVING, RECORDING AND MONITORING VOICE, DATA, INFORMATION IMAGES, SIGNALS, MESSAGES COMPRISED OF DATA AND WORD PROCESSORS, AND TELECOMMUNICATIONS HARDWARE COMPONENTS AND PERIPHERALS THEREOF FOR USE IN THE TELECOMMUNICATIONS INDUSTRY, AND RENTAL OF EQUIPMENT FOR TRANSMITTING, RECEIVING, RECORDING AND MONITORING COMPUTER PROGRAMS FOR USE IN OPERATING AND ACCESSING TELECOMMUNICATIONS SYSTEMS; AUDIO AND VIDEO BROADCASTING; PROVIDING MULTIPLE-USER DIAL-UP AND DEDICATED ACCESS TO THE INTERNET; PERSONAL COMMUNICATIONS SERVICES; PAGER SERVICES; TRANSMISSION AND BROADCAST OF AUDIO AND VIDEO PROGRAMMING; LEASING OF TELECOMMUNICATIONS EQUIPMENT, COMPONENTS AND SYSTEMS; PROVIDING INFORMATION VIA THE TELEPHONE AND THE GLOBAL COMMUNICATION NETWORKS IN THE FIELD OF TELECOMMUNICATIONS; CONSULTING IN THE FIELD OF TELECOMMUNICATIONS (U.S. CLS. 100, 101 AND 104).

JENNIFER HETU, EXAMINING ATTORNEY

SN 77-194,205. AOL LLC, DULLES, VA. FILED 5-31-2007.

BUDDYBULLETIN

THE MARK CONSISTS OF STANDARD CHARACTERS WITHOUT CLAIM TO ANY PARTICULAR FONT, STYLE, SIZE, OR COLOR.

FOR TELECOMMUNICATIONS SERVICES, NAMELY, ELECTRONIC TRANSMISSION OF DATA, IMAGES, DOCUMENTS, MESSAGES, SOUND, GRAPHICS, PHOTOS, AND FILES VIA COMPUTER NETWORKS; PROVIDING ONLINE COMPUTER NETWORK FACILITIES FOR REAL TIME INTERACTION AND COMMUNICATION WITH OTHER COMPUTER USERS (U.S. CLS. 100, 101 AND 104).

PAMELA HIRSCHMAN, EXAMINING ATTORNEY

CLASS 38—(Continued).

SN 77-223,364. DOTSYNTAX, LLC, ROCHESTER, NY. FILED 7-6-2007.

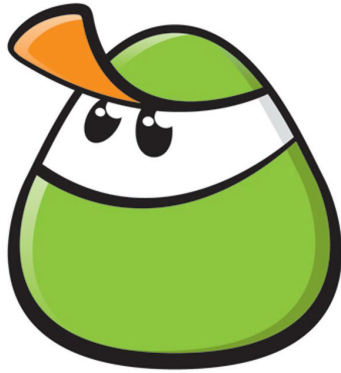

THE COLOR(S) GREEN, ORANGE, WHITE AND BLACK IS/ARE CLAIMED AS A FEATURE OF THE MARK.

THE MARK CONSISTS OF A GREEN EGG-SHAPED CHARACTER, OUTLINED IN BLACK, WEARING A GREEN HAT WITH ORANGE BRIM. THE EYE REGION UNDER THE HAT IS WHITE WITH BLACK OVAL EYEBALLS AND WHITE CIRCLES WITHIN THE EYEBALLS DEPICTING A REFLECTION OF GLARE.

FOR INSTANT MESSAGING SERVICES (U.S. CLS. 100, 101 AND 104).

FIRST USE 3-1-2007; IN COMMERCE 3-1-2007.
JASON LOTT, EXAMINING ATTORNEY

CLASS 38—(Continued).

SN 78-817,058. TOTAL CALL INTERNATIONAL, INC., LOS ANGELES, CA. FILED 2-16-2006.

TIPID PINOY

THE MARK CONSISTS OF STANDARD CHARACTERS WITHOUT CLAIM TO ANY PARTICULAR FONT, STYLE, SIZE, OR COLOR.

THE FOREIGN WORDING IN THE MARK TRANSLATES INTO ENGLISH AS DISCOUNT FOR FILIPINOS.

SEC. 2(F).

FOR TELECOMMUNICATION SERVICES PROVIDED VIA PREPAID TELEPHONE CALLING CARDS (U.S. CLS. 100, 101 AND 104).

PAULA MAHONEY, EXAMINING ATTORNEY

SN 78-949,045. FONIX CORPORATION, SANDY, UT. FILED 8-10-2006.

FREEDOM OF SPEECH

THE MARK CONSISTS OF STANDARD CHARACTERS WITHOUT CLAIM TO ANY PARTICULAR FONT, STYLE, SIZE, OR COLOR.

FOR TELECOMMUNICATIONS SERVICES, NAMELY, THE ELECTRONIC TRANSMISSION OF VOICE, DATA AND INFORMATION; LOCAL, LONG DISTANCE, INTERNATIONAL AND TOLL FREE TELEPHONE SERVICES; VOICE PROCESSING SERVICES, NAMELY, TELECONFERENCING, VOICEMAIL, AND TELEPHONE VOICE MESSAGING SERVICES; CALL ROUTING SERVICES; PRIVATE LINE SERVICES; FRAME RELAY SERVICES; ASYNCHRONOUS TRANSFER MODE (ATM) SERVICES; VOICE OVER INTERNET PROTOCOL (VOIP) TELEPHONY SERVICES; ISDN SERVICES; DSL TRANSMISSION SERVICES; TELECOMMUNICATIONS CONNECTIONS TO THE INTERNET; ELECTRONIC-MAIL SERVICES; FAX TRANSMISSION SERVICES; VOICE, FAX, PAGING AND E-MAIL MESSAGING SERVICES; VOICE COMMUNICATIONS SERVICES, NAMELY, PROVIDING TELEPHONE USERS WITH ACCESS TO INFORMATION AND DATA USING INTERACTIVE RESPONSE, SPEECH RECOGNITION, VOICE COMMAND, AND TEXT-TO-SPEECH SERVICES, AUDIOCONFERENCING SERVICES; VIDEOCONFERENCING SERVICES AND GLOBAL COMPUTER CONFERENCING SERVICES; INTERNET SERVICE PROVIDER SERVICES; BROADBAND OVER POWERLINE (BPL) TELECOMMUNICATIONS SERVICES, NAMELY, PROVIDING HIGH-SPEED ACCESS TO THE INTERNET VIA ELECTRICAL POWER LINES (U.S. CLS. 100, 101 AND 104).

FIRST USE 8-17-2004; IN COMMERCE 8-17-2004.

INGA ERVIN, EXAMINING ATTORNEY

SN 78-810,477. 5280 NETWORKS LLC, DENVER, CO. FILED 2-8-2006.



NO CLAIM IS MADE TO THE EXCLUSIVE RIGHT TO USE "NETWORKS", APART FROM THE MARK AS SHOWN.

FOR TELECOMMUNICATIONS SERVICES, NAMELY, VOICE OVER INTERNET PROTOCOL SERVICES, LOCAL TELEPHONE SERVICE PROVIDER, AND LONG DISTANCE TELEPHONE SERVICE PROVIDER (U.S. CLS. 100, 101 AND 104).

FIRST USE 6-15-2005; IN COMMERCE 6-15-2005.

RAY THOMAS, EXAMINING ATTORNEY

CLASS 38—(Continued).

SN 78-967,723. CEQUEL III, LLC, ST. LOUIS, MO. FILED 9-6-2006.

CEQUEL

THE MARK CONSISTS OF STANDARD CHARACTERS WITHOUT CLAIM TO ANY PARTICULAR FONT, STYLE, SIZE, OR COLOR.

OWNER OF U.S. REG. NO. 3,055,830.
FOR COMMUNICATIONS AND TELECOMMUNICATIONS SERVICES, NAMELY CABLE TELEVISION TRANSMISSION AND PROVIDING HIGH SPEED INTERNET ACCESS SERVICES AND TELEPHONE SERVICES (U.S. CLS. 100, 101 AND 104).

REBECCA EISINGER, EXAMINING ATTORNEY

SN 78-968,247. BUSINESS 2.0 MEDIA, INC., SAN FRANCISCO, CA. FILED 9-6-2006.

BUSINESS 2.0

THE MARK CONSISTS OF STANDARD CHARACTERS WITHOUT CLAIM TO ANY PARTICULAR FONT, STYLE, SIZE, OR COLOR.

OWNER OF U.S. REG. NO. 2,615,623.
NO CLAIM IS MADE TO THE EXCLUSIVE RIGHT TO USE "BUSINESS", APART FROM THE MARK AS SHOWN.

FOR AUDIO BROADCASTING; CELLULAR TELEPHONE SERVICES; COMMUNICATION SERVICES, NAMELY, ELECTRONIC TRANSMISSION OF DATA AND DOCUMENTS AMONG USERS OF COMPUTERS; COMMUNICATIONS BY MOBILE PHONES; COMMUNICATIONS SERVICES, NAMELY, TRANSMITTING STREAMED SOUND AND AUDIO-VISUAL RECORDINGS VIA THE INTERNET; ELECTRONIC, ELECTRIC, AND DIGITAL TRANSMISSION OF VOICE, DATA, IMAGES, SIGNALS, AND MESSAGES; MOBILE RADIO COMMUNICATION; RADIO BROADCASTING; TELEVISION BROADCASTING; TEXT AND NUMERIC WIRELESS DIGITAL MESSAGING SERVICES; TRANSMISSION OF INFORMATION BY ELECTRONIC COMMUNICATIONS NETWORKS; VIDEO BROADCASTING; WIRELESS BROADBAND COMMUNICATION SERVICES; WIRELESS COMMUNICATIONS SERVICES, NAMELY, TRANSMISSION OF GRAPHICS TO MOBILE TELEPHONES; WIRELESS ELECTRONIC TRANSMISSION OF VOICE SIGNALS, DATA, FACSIMILES, IMAGES AND INFORMATIONS (U.S. CLS. 100, 101 AND 104).

MICHAEL LITZAU, EXAMINING ATTORNEY

CLASS 38—(Continued).

SN 78-968,423. CEQUEL III, LLC, ST. LOUIS, MO. FILED 9-6-2006.

CEQUEL COMMUNICATIONS

THE MARK CONSISTS OF STANDARD CHARACTERS WITHOUT CLAIM TO ANY PARTICULAR FONT, STYLE, SIZE, OR COLOR.

OWNER OF U.S. REG. NO. 3,055,830.
NO CLAIM IS MADE TO THE EXCLUSIVE RIGHT TO USE "COMMUNICATIONS", APART FROM THE MARK AS SHOWN.

FOR COMMUNICATIONS AND TELECOMMUNICATIONS SERVICES, NAMELY CABLE TELEVISION TRANSMISSION AND PROVIDING HIGH SPEED INTERNET ACCESS SERVICES AND TELEPHONE SERVICES (U.S. CLS. 100, 101 AND 104).

REBECCA EISINGER, EXAMINING ATTORNEY

CLASS 39—TRANSPORTATION AND STORAGE

SN 76-674,472. TRANSPORTE MEDRANO INC., HEMPSTEAD, NY. FILED 3-23-2007.



NO CLAIM IS MADE TO THE EXCLUSIVE RIGHT TO USE "EXPRESS", APART FROM THE MARK AS SHOWN.

THE COLOR(S) BLUE, WHITE, RED AND BLACK IS/ARE CLAIMED AS A FEATURE OF THE MARK.

MEDRANO AND THE CIRCLE ARE IN BLUE AND THE CIRCLE HAS 3 WHITE LINES RUNNING THROUGH IT. THE WORDING EXPRESS AND THE LINES FORMING THE LETTER "E" ARE IN RED AND THE OUTER EDGES OF THE LETTERING FOR EXPRESS ARE IN BLACK.

FOR FREIGHT FORWARDING SERVICES (U.S. CLS. 100 AND 105).

FIRST USE 0-0-2002; IN COMMERCE 0-0-2002.
EDWARD NELSON, EXAMINING ATTORNEY

CLASS 39—(Continued).

SN 76-676,389. HILLWOOD DEVELOPMENT COMPANY, L.L.C., DALLAS, TX. FILED 5-4-2007.

ALLIANCE CALIFORNIA

THE MARK CONSISTS OF STANDARD CHARACTERS WITHOUT CLAIM TO ANY PARTICULAR FONT, STYLE, SIZE, OR COLOR.

OWNER OF U.S. REG. NOS. 2,627,922, 2,812,655 AND OTHERS.

NO CLAIM IS MADE TO THE EXCLUSIVE RIGHT TO USE "CALIFORNIA", APART FROM THE MARK AS SHOWN.

FOR AIRPORT SERVICES (U.S. CLS. 100 AND 105).
AMY ALFIERI, EXAMINING ATTORNEY

CLASS 39—(Continued).

SN 77-132,684. TAMPA BAY WATER, CLEARWATER, FL. FILED 3-16-2007.



NO CLAIM IS MADE TO THE EXCLUSIVE RIGHT TO USE "WATER", APART FROM THE MARK AS SHOWN.

THE MARK CONSISTS OF THE WORDS "TAMPA BAY WATER" BESIDE AN OVAL WITH THREE WAVES.

SEC. 2(F).
FOR WATER SUPPLY AND DISTRIBUTION SERVICES (U.S. CLS. 100 AND 105).

FIRST USE 6-10-1998; IN COMMERCE 6-10-1998.
MARTHA SANTOMARTINO, EXAMINING ATTORNEY

SN 77-002,302. OWOW FOOD AND BEVERAGE, INC., ELGIN, IL. FILED 9-19-2006.

OWOW

THE MARK CONSISTS OF STANDARD CHARACTERS WITHOUT CLAIM TO ANY PARTICULAR FONT, STYLE, SIZE, OR COLOR.

FOR DISTRIBUTION SERVICES, NAMELY, DELIVERY OF BEVERAGES (U.S. CLS. 100 AND 105).
INGA ERVIN, EXAMINING ATTORNEY

SN 77-149,440. CARDINAL DISTRIBUTING LLC, BOZEMAN, MT. FILED 4-5-2007.



SN 77-076,046. GEOJOEY INC., ISSAQUAH, WA. FILED 1-4-2007.

GEOJOEY

THE MARK CONSISTS OF STANDARD CHARACTERS WITHOUT CLAIM TO ANY PARTICULAR FONT, STYLE, SIZE, OR COLOR.

FOR PROVIDING A WEBSITE FEATURING AN INTERACTIVE MAP OF THE GLOBE CONTAINING WORLD LANDMARKS, USER-DEFINED DESCRIPTIONS AND DRAWINGS, AND INFORMATION ABOUT LOCATIONS AND WEBSITE LINKS TO GEOGRAPHIC INFORMATION, MAP IMAGES, AND TRIP ROUTING VIA A GLOBAL COMPUTER NETWORK (U.S. CLS. 100 AND 105).

FIRST USE 8-12-2006; IN COMMERCE 9-12-2006.
SCOTT SISUN, EXAMINING ATTORNEY

THE MARK CONSISTS OF A CARDINAL BIRD PERCHED ON A TREE BRANCH. ENCLOSED IN AN OVAL. FOR DISTRIBUTION SERVICES, NAMELY, DELIVERY OF ALCOHOLIC AND NON-ALCOHOLIC BEVERAGES, SODAS, JUICES AND WATER (U.S. CLS. 100 AND 105).

FIRST USE 2-15-1987; IN COMMERCE 3-1-1987.
MYRIAH HABEEB, EXAMINING ATTORNEY

CLASS 39—(Continued).

SN 77-150,854. ERA HELICOPTERS, L.L.C., LAKE CHARLES, LA. FILED 4-6-2007.



OWNER OF U.S. REG. NOS. 1,565,042, 2,305,559 AND OTHERS.

NO CLAIM IS MADE TO THE EXCLUSIVE RIGHT TO USE "LLC", APART FROM THE MARK AS SHOWN.

THE MARK CONSISTS OF A CIRCULAR CUT-OUT OF A HEART MONITOR SCREEN DEPICTING TWO PULSES LOCATED BETWEEN THE STYLIZED WORDING ERA AND MED.

FOR HELICOPTER AMBULANCE TRANSPORT (U.S. CLS. 100 AND 105).

FIRST USE 1-10-2007; IN COMMERCE 1-10-2007.
JULIE GUTTADAURO, EXAMINING ATTORNEY

SN 77-150,908. CURRENT CARRIER CORP., PAWTUCKET, RI. FILED 4-6-2007.

NOW DELIVERY

THE MARK CONSISTS OF STANDARD CHARACTERS WITHOUT CLAIM TO ANY PARTICULAR FONT, STYLE, SIZE, OR COLOR.

NO CLAIM IS MADE TO THE EXCLUSIVE RIGHT TO USE "DELIVERY", APART FROM THE MARK AS SHOWN. FOR PARCEL AND COURIER DELIVERY SERVICES; MESSENGER SERVICES; AND AIR FREIGHT DELIVERY SERVICES (U.S. CLS. 100 AND 105).

FIRST USE 1-28-2007; IN COMMERCE 1-28-2007.
NELSON SNYDER, EXAMINING ATTORNEY

SN 77-151,928. UNITED LAUNCH ALLIANCE, LITTLETON, CO. FILED 4-9-2007.



NO CLAIM IS MADE TO THE EXCLUSIVE RIGHT TO USE "LAUNCH SERVICES", APART FROM THE MARK AS SHOWN.

THE MARK CONSISTS OF THE LETTERS ULS ABOVE A CURVED LINE AND THE WORDS UNITED LAUNCH ALLIANCE BELOW THE CURVED LINE.

FOR LAUNCH AND PLACEMENT IN PRESCRIBED ORBIT OF SATELLITES OF OTHERS (U.S. CLS. 100 AND 105).

JAY FLOWERS, EXAMINING ATTORNEY

CLASS 39—(Continued).

SN 77-156,988. HO FENG, INC., MOORESVILLE, NC. FILED 4-15-2007.

RICE FUN

THE MARK CONSISTS OF STANDARD CHARACTERS WITHOUT CLAIM TO ANY PARTICULAR FONT, STYLE, SIZE, OR COLOR.

NO CLAIM IS MADE TO THE EXCLUSIVE RIGHT TO USE "RICE", APART FROM THE MARK AS SHOWN.

FOR DELIVERY OF FOOD BY RESTAURANTS (U.S. CLS. 100 AND 105).

FIRST USE 3-2-2005; IN COMMERCE 3-2-2005.

RICHARD A. STRASER, EXAMINING ATTORNEY

SN 77-158,734. ALLIANZ, LLC, SALT LAKE CITY, UT. FILED 4-17-2007.

MOVE 4 LESS

THE MARK CONSISTS OF STANDARD CHARACTERS WITHOUT CLAIM TO ANY PARTICULAR FONT, STYLE, SIZE, OR COLOR.

NO CLAIM IS MADE TO THE EXCLUSIVE RIGHT TO USE "MOVE", APART FROM THE MARK AS SHOWN.

FOR FURNITURE MOVING; MOVING VAN SERVICES (U.S. CLS. 100 AND 105).

FIRST USE 1-9-2003; IN COMMERCE 1-9-2003.

LINDA MICKLEBURGH, EXAMINING ATTORNEY

SN 77-158,857. 1800BOOKING, LLC, NORTH CHARLESTON, SC. FILED 4-17-2007.

1800BOOKING

THE MARK CONSISTS OF STANDARD CHARACTERS WITHOUT CLAIM TO ANY PARTICULAR FONT, STYLE, SIZE, OR COLOR.

FOR ORGANIZATION, BOOKING AND ARRANGEMENT OF EXCURSIONS, DAY TRIPS AND SIGHTSEEING TOURS; TRAVEL AND TOUR TICKET RESERVATION SERVICE; TRAVEL AGENCY SERVICES, NAMELY, MAKING RESERVATIONS AND BOOKINGS FOR TRANSPORTATION; TRAVEL AND TOUR INFORMATION SERVICE; TRAVEL BOOKING AGENCIES (U.S. CLS. 100 AND 105).

RICHARD A. STRASER, EXAMINING ATTORNEY

CLASS 39—(Continued).

SN 77-159,148. CARLSON TRAVEL GROUP, INC., MINNEAPOLIS, MN. FILED 4-18-2007.

TRAVEL SINGLE, NEVER ALONE!

THE MARK CONSISTS OF STANDARD CHARACTERS WITHOUT CLAIM TO ANY PARTICULAR FONT, STYLE, SIZE, OR COLOR.

FOR TRAVEL AGENCY SERVICES, NAMELY, MAKING RESERVATIONS AND BOOKINGS FOR TRANSPORTATION; MAKING CRUISE RESERVATIONS FOR INDIVIDUALS AND GROUPS VIA A WORLDWIDE INTERNET SYSTEM (U.S. CLS. 100 AND 105).

FIRST USE 8-8-2006; IN COMMERCE 8-8-2006.
SIMON TENG, EXAMINING ATTORNEY

SN 77-159,615. SKYDINI, LLC, LEBANON, TN. FILED 4-18-2007.

SKYDINI

THE MARK CONSISTS OF STANDARD CHARACTERS WITHOUT CLAIM TO ANY PARTICULAR FONT, STYLE, SIZE, OR COLOR.

FOR TRAVEL INFORMATION SERVICES AND TRAVEL AGENCY SERVICES, NAMELY, MAKING RESERVATIONS AND BOOKINGS FOR TRANSPORTATION (U.S. CLS. 100 AND 105).

JENNIFER MARTIN, EXAMINING ATTORNEY

SN 77-161,109. BLUE STAR JETS, NEW YORK, NY. FILED 4-19-2007.

OWN YOUR LIFE NOT A FRACTION

THE MARK CONSISTS OF STANDARD CHARACTERS WITHOUT CLAIM TO ANY PARTICULAR FONT, STYLE, SIZE, OR COLOR.

FOR AIRPLANE CHARTERING (U.S. CLS. 100 AND 105).

DARRYL SPRUILL, EXAMINING ATTORNEY

CLASS 39—(Continued).

SN 77-164,274. LEXINGTON-FAYETTE URBAN COUNTY AIRPORT BOARD, LEXINGTON, KY. FILED 4-24-2007.

BLUE GRASS AIRPORT

THE MARK CONSISTS OF STANDARD CHARACTERS WITHOUT CLAIM TO ANY PARTICULAR FONT, STYLE, SIZE, OR COLOR.

OWNER OF U.S. REG. NO. 1,064,659.
NO CLAIM IS MADE TO THE EXCLUSIVE RIGHT TO USE "AIRPORT", APART FROM THE MARK AS SHOWN.
FOR AIRPORT SERVICES (U.S. CLS. 100 AND 105).
FIRST USE 0-0-1976; IN COMMERCE 0-0-1976.
JUDITH HELFMAN, EXAMINING ATTORNEY

SN 77-195,707. UNITED LAUNCH ALLIANCE, CENTENNIAL, CO. FILED 6-1-2007.

PERFECT PRODUCT DELIVERY

THE MARK CONSISTS OF STANDARD CHARACTERS WITHOUT CLAIM TO ANY PARTICULAR FONT, STYLE, SIZE, OR COLOR.

NO CLAIM IS MADE TO THE EXCLUSIVE RIGHT TO USE "PRODUCT DELIVERY", APART FROM THE MARK AS SHOWN.

FOR LAUNCH AND PLACEMENT IN PRESCRIBED ORBIT OF SATELLITES OF OTHERS (U.S. CLS. 100 AND 105).

JAY FLOWERS, EXAMINING ATTORNEY

SN 78-798,272. DETROIT TRANSPORTATION CORPORATION, DETROIT, MI. FILED 1-24-2006.

THE PEOPLE MOVER 

OWNER OF U.S. REG. NO. 1,522,115.

THE MARK CONSISTS OF THE WORDS "THE PEOPLE MOVER" WITH AN END VIEW OF A SIMULATED VEHICLE UPON AN ELEVATED TRACK WITH A LINE BORDERING THREE SIDES OF MARK. THE WORD "THE" IS WRITTEN IN VERTICAL FASHION WITH THE WORDS "PEOPLE MOVER" WRITTEN HORIZONTALLY.

FOR PUBLIC TRANSPORTATION SERVICES, NAMELY, RAIL TRANSIT SYSTEM SERVICES (U.S. CLS. 100 AND 105).

FIRST USE 7-1-2005; IN COMMERCE 7-1-2005.

AMY BROZENIC, EXAMINING ATTORNEY

CLASS 39—(Continued).

SN 79-025,616. GEOPOST, FRANCE, FILED 4-21-2006.

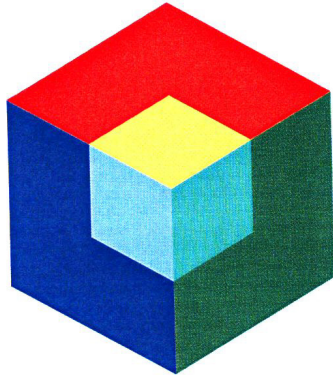

PRIORITY DATE OF 10-28-2005 IS CLAIMED.
OWNER OF INTERNATIONAL REGISTRATION 0889661
DATED 4-21-2006, EXPIRES 4-21-2016.

"THE COLOR(S) RED, YELLOW, BLUE, LIGHT BLUE,
DARK GREEN AND TURQUOISE IS/ARE CLAIMED AS A
FEATURE OF THE MARK."

"THE MARK CONSISTS OF A CUBE WITHIN A CUBE,
WITH EACH CUBE SHOWING THREE FACES, EACH OF A
DIFFERENT COLOR; WHEREIN THE INNER CUBE FACES
ARE COLORED LIGHT BLUE, TURQUOISE AND YELLOW,
RESPECTIVELY AND THE OUTER CUBE FACES ARE
COLORED RED, BLUE AND DARK GREEN, RESPEC-
TIVELY."

FOR TRANSPORT, IN PARTICULAR TRANSPORT BY
LAND, SEA AND AIR OF DOCUMENTS, GOODS AND
PACKAGES; PACKAGING ARTICLES FOR TRANSPORT-
ATION AND STORAGE OF GOODS, NAMELY
PACKAGES, PARCELS, LETTERS, DOCUMENTS, PAL-
LETS; TRANSPORT INFORMATION SERVICES;
FREIGHT BROKERAGE SERVICES; COLLECTION OF
GOODS, PRODUCTS, PACKAGES, AND MAIL FOR
TRANSPORTATION; STORAGE OF GOODS NAMELY
PACKAGES, PARCELS, LETTERS, DOCUMENTS, PAL-
LETS; UNLOADING CARGO; PROVIDING STORAGE
INFORMATION; COURIER SERVICES; LOGISTIC CON-
SULTING, NAMELY PROVIDING CONSULTING IN
THE AREAS OF INVENTORY MANAGEMENT,
FREIGHT TRANSPORTATION MANAGEMENT, PRO-
DUCT DISTRIBUTION OPERATIONS MANAGEMENT
AND DESIGNING AND MANAGING LOGISTICS SYS-
TEMS FOR OTHERS; LOGISTIC SERVICES IN THE
TRANSPORT SECTOR NAMELY MANAGEMENT OF
THE ROUTE, THE MEANS OF TRANSPORT, THE
MEANS OF STORAGE, TIME AND THE EXPENDITURE;
COLLECTION, TRANSPORT AND DELIVERY OF
GOODS, IN PARTICULAR DOCUMENTS, PACKAGES,
PARCELS, LETTERS AND PALLETS; FREIGHTING,
NAMELY FREIGHT TRANSPORTATION BY TRAIN,
TRUCK, AIR AND SEA; ACCEPTANCE OF GOODS
FOR FURTHER TRANSPORT AND DISPATCHING
DATA RELATIVE TO GOODS RECEIVED FOR
FURTHER TRANSPORT AND FRANKING OF ADMIN-
ISTRATIVE AND CUSTOM PAPERWORKS RELATED
TO THE CUSTOM PROCEDURES; FOLLOW-UP SER-
VICES, NAMELY, ELECTRONIC TRACKING OF GOODS
AND ARTICLES, IN PARTICULAR TRACKING AND
TRACING OF DOCUMENTS, PACKAGES, PARCELS,

CLASS 39—(Continued).

LETTERS AND PALLETS; MANAGEMENT OF RE-
TURNS, NAMELY ORGANIZING AND HANDLING OF
RETURNED DELIVERIES OF PACKAGES AND DOCU-
MENTS; RENTAL OF STORAGE CONTAINERS; EX-
PRESS MAIL DELIVERIES SERVICES, FREIGHT
TRANSPORTATION BY TRAIN, TRUCK, AIR AND
SEA, TRANSPORT OF GOODS AND PACKAGES;
HANDLING AND EXECUTION OF DISPATCHES,
NAMELY CONSIGNMENT PREPARATION AND SHIP-
MENT OF PACKAGES, PARCELS, LETTERS, DOCU-
MENTS, PALLETS; PROVIDING INFORMATION IN
THE NATURE OF DESTINATIONS, FACT SHEETS,
DATE OF DELIVERY AND RELATED DATA VIA AN
ONLINE DATABASE AND/OR THE INTERNET, IN
PARTICULAR IN THE FIELD OF MAIL, PACKAGES
AND EXPRESS TRANSPORT SERVICES, THE DISTRI-
BUTION OF NEWSPAPERS AND MAGAZINES, POSTAL
DISPATCHING AND DELIVERY, PROCESSING AND
FRANKING MAIL DELIVERY SERVICES; WAREHOUS-
ING SERVICES; DISPATCH, BROKERAGE AND TRAN-
SPORTATION OF CARGO. (U.S. CLS. 100 AND 105).

DARRYL SPRUILL, EXAMINING ATTORNEY

CLASS 40—MATERIAL TREATMENTSN 76-641,057. TALON CONSTRUCTION SERVICES, L.P.,
AUSTIN, TX. FILED 6-20-2005.**CLEARVIEW**

THE MARK CONSISTS OF STANDARD CHARACTERS
WITHOUT CLAIM TO ANY PARTICULAR FONT, STYLE,
SIZE, OR COLOR.

FOR RESIDENTIAL AND COMMERCIAL GLASS
WINDOW TINTING (U.S. CLS. 100, 103 AND 106).

FIRST USE 5-4-2005; IN COMMERCE 5-4-2005.

MICHAEL GAFFAR, EXAMINING ATTORNEY

SN 77-063,969. APOGEE ENTERPRISES, INC., BLOOMING-
TON, MN. FILED 12-14-2006.**THE LEADER IN GLASS
FABRICATION**

THE MARK CONSISTS OF STANDARD CHARACTERS
WITHOUT CLAIM TO ANY PARTICULAR FONT, STYLE,
SIZE, OR COLOR.

NO CLAIM IS MADE TO THE EXCLUSIVE RIGHT TO
USE "GLASS FABRICATION", APART FROM THE MARK
AS SHOWN.

FOR FABRICATION OF GLASS AND GLAZING PRO-
DUCTS FOR OTHERS (U.S. CLS. 100, 103 AND 106).

FIRST USE 12-31-1987; IN COMMERCE 12-31-1987.

HENRY S. ZAK, EXAMINING ATTORNEY

CLASS 40—(Continued).

SN 77-087,844. SHAUN GLENNON M, MIAMI BEACH, FL.
FILED 1-22-2007.



THE COLOR(S) RED, WHITE, BLUE AND BLACK IS/ARE CLAIMED AS A FEATURE OF THE MARK.

THE MARK CONSISTS OF A BLUE AND WHITE YIN-YANG DESIGN SURROUNDED BY RED-COLORED RINGS. A BLUE SLIT APPEARS INSIDE THE WHITE HALF OF THE YIN-YANG AND A WHITE SLIT APPEARS IN THE BLUE HALF. THE MARK IS OUTLINED IN BLACK. THE WORDING YINYANK IS OUTLINED IN BLACK.

FOR IMPRINTING MESSAGES ON T-SHIRTS (U.S. CLS. 100, 103 AND 106).

FIRST USE 1-10-2007; IN COMMERCE 1-10-2007.
YAT SYE, LEE, EXAMINING ATTORNEY

CLASS 40—(Continued).

SN 77-150,682. DUNCAN GALVANIZING CORPORATION,
EVERETT, MA. FILED 4-6-2007.

COLORGALV THERMOSET III

THE MARK CONSISTS OF STANDARD CHARACTERS WITHOUT CLAIM TO ANY PARTICULAR FONT, STYLE, SIZE, OR COLOR.

OWNER OF U.S. REG. NO. 1,085,702.

NO CLAIM IS MADE TO THE EXCLUSIVE RIGHT TO USE "THERMOSET", APART FROM THE MARK AS SHOWN.

FOR APPLYING PROTECTIVE COATINGS TO METALS (U.S. CLS. 100, 103 AND 106).

DEZMONA MIZELLE, EXAMINING ATTORNEY

SN 77-125,120. TEKNOLOGICA LLC, SAUSALITO, CA.
FILED 3-7-2007.

Laser Cryojet

THE MARK CONSISTS OF STANDARD CHARACTERS WITHOUT CLAIM TO ANY PARTICULAR FONT, STYLE, SIZE, OR COLOR.

NO CLAIM IS MADE TO THE EXCLUSIVE RIGHT TO USE "LASER", APART FROM THE MARK AS SHOWN.

FOR TREATMENT OF MATERIALS BY LASER BEAM (U.S. CLS. 100, 103 AND 106).

SAMUEL E. SHARPER JR., EXAMINING ATTORNEY

SN 77-151,255. HARRIS, THOMAS AKLIN, PHOENIX, AZ.
FILED 4-7-2007.

Magic Tint

THE MARK CONSISTS OF STANDARD CHARACTERS WITHOUT CLAIM TO ANY PARTICULAR FONT, STYLE, SIZE, OR COLOR.

NO CLAIM IS MADE TO THE EXCLUSIVE RIGHT TO USE "TINT", APART FROM THE MARK AS SHOWN.

FOR GLASS TINTING (U.S. CLS. 100, 103 AND 106).

FIRST USE 4-6-2007; IN COMMERCE 4-6-2007.
SONYA STEPHENS, EXAMINING ATTORNEY

SN 77-150,665. DUNCAN GALVANIZING CORPORATION,
EVERETT, MA. FILED 4-6-2007.

COLORGALV THERMOSET II

THE MARK CONSISTS OF STANDARD CHARACTERS WITHOUT CLAIM TO ANY PARTICULAR FONT, STYLE, SIZE, OR COLOR.

OWNER OF U.S. REG. NO. 1,085,702.

NO CLAIM IS MADE TO THE EXCLUSIVE RIGHT TO USE "THERMOSET", APART FROM THE MARK AS SHOWN.

FOR APPLYING PROTECTIVE COATINGS TO METALS (U.S. CLS. 100, 103 AND 106).

DEZMONA MIZELLE, EXAMINING ATTORNEY

SN 77-153,957. INFILCO DEGREMONT, INC., RICHMOND,
VA. FILED 4-11-2007.

METEOR

THE MARK CONSISTS OF STANDARD CHARACTERS WITHOUT CLAIM TO ANY PARTICULAR FONT, STYLE, SIZE, OR COLOR.

FOR BIOLOGICAL TREATMENT OF WATER AND WASTEWATER (U.S. CLS. 100, 103 AND 106).

DAVID H. STINE, EXAMINING ATTORNEY

CLASS 40—(Continued).

SN 77-153,984. RWH PRODUCTS LLC, HUNTINGDON, PA. FILED 4-11-2007.



NO CLAIM IS MADE TO THE EXCLUSIVE RIGHT TO USE "PODIUM" OR "PRODUCTS, LLC", APART FROM THE MARK AS SHOWN.

THE MARK CONSISTS OF THE WORDING "MR. PODIUM BY RWH PRODUCTS, LLC" AND DESIGNS. THE DESIGN ELEMENTS CONSIST OF A VERTICAL LINE RUNNING THROUGH THE INSIDE OF THE "O" IN "PODIUM" AND A HORIZONTAL LINE RUNNING THROUGH THE LETTERS "ODIUM".

FOR CUSTOM MANUFACTURE OF FURNITURE (U.S. CLS. 100, 103 AND 106).

FIRST USE 3-24-2004; IN COMMERCE 3-24-2004.
CORY BOONE, EXAMINING ATTORNEY

CLASS 40—(Continued).

SN 77-156,882. HONEY, RICHARD O.H., AUSTIN, TX. FILED 4-14-2007.

**American Growth through
Global Manufacturing**

THE MARK CONSISTS OF STANDARD CHARACTERS WITHOUT CLAIM TO ANY PARTICULAR FONT, STYLE, SIZE, OR COLOR.

FOR CONTRACT MANUFACTURING IN THE FIELD OF CONSUMER PRODUCTS AND PRODUCTS FOR USE IN INDUSTRY; CUSTOM MANUFACTURE OF MOLDS FOR USE IN INDUSTRY; MANUFACTURE OF GENERAL PRODUCT LINES IN THE FIELD OF PLASTIC INJECTION MOLDED PRODUCTS, PLASTIC EXTRUDED PRODUCTS, METAL EXTRUDED PRODUCTS AND METAL DIE CAST PRODUCTS FOR USE IN INDUSTRY TO THE ORDER AND SPECIFICATION OF OTHERS; MANUFACTURE OF MOLDED PLASTIC PARTS, METAL DIE-CAST PARTS, PLASTIC EXTRUSIONS, METAL EXTRUSIONS, STAMPINGS, THERMOFORMED PARTS, METAL CASTINGS, METAL FORGINGS, PROTOTYPE PARTS AND ELECTRONIC PARTS TO ORDER AND/OR SPECIFICATION OF OTHERS; MANUFACTURING SERVICES FOR OTHERS IN THE FIELD OF PLASTIC MOLDING, METAL DIE CASTING, METAL STAMPING, ELECTRONICS ASSEMBLY AND EXTRUSION; CUSTOM MANUFACTURE OF OUTDOOR FURNITURE, SPORTING GOODS, HOME DECORATION PRODUCTS, LAWN SIGNS, SAFETY PRODUCTS, CUSTOM COMPUTER HOUSINGS AND GARDEN PRODUCTS (U.S. CLS. 100, 103 AND 106).

ESTHER A. BORSUK, EXAMINING ATTORNEY

SN 77-156,203. INTEGRATED TEST CORPORATION, DALLAS, TX. FILED 4-13-2007.

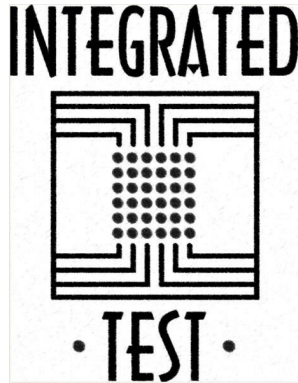

NO CLAIM IS MADE TO THE EXCLUSIVE RIGHT TO USE "INTEGRATED TEST", APART FROM THE MARK AS SHOWN.

THE MARK CONSISTS OF A STYLIZED SQUARE PRINTED CIRCUIT BOARD WITH THE WORD "INTEGRATED" PRINTED IN ARCHITECTURA FONT AND CENTERED ABOVE THE TOP OF THE BOARD, AND THE WORD "TEST" PRINTED IN ARCHITECTURA FONT AND CENTERED BELOW THE BOTTOM OF THE BOARD. A ROUND DOT APPEARS TO THE LEFT AND TO THE RIGHT OF THE WORD "TEST" AT THE WORD'S MIDLINE.

FOR CUSTOM MANUFACTURE OF SEMICONDUCTOR TEST DEVICES FOR WAFER AND PACKAGE TESTING, INCLUDING CUSTOM MANUFACTURE OF PRINTED CIRCUIT BOARDS AND INTERFACE HARDWARE (U.S. CLS. 100, 103 AND 106).

ZHALEH DELANEY, EXAMINING ATTORNEY

SN 77-157,131. ADVANCED ASSEMBLY, L.L.C., AURORA, CO. FILED 4-15-2007.

AAPCB ASSEMBLY

THE MARK CONSISTS OF STANDARD CHARACTERS WITHOUT CLAIM TO ANY PARTICULAR FONT, STYLE, SIZE, OR COLOR.

NO CLAIM IS MADE TO THE EXCLUSIVE RIGHT TO USE "ASSEMBLY", APART FROM THE MARK AS SHOWN.

FOR MANUFACTURING SERVICES FOR OTHERS IN THE FIELD OF CIRCUIT BOARDS (U.S. CLS. 100, 103 AND 106).

ALYSSA PALADINO, EXAMINING ATTORNEY

CLASS 40—(Continued).

SN 77-157,138. ADVANCED ASSEMBLY, L.L.C., AURORA, CO. FILED 4-16-2007.



NO CLAIM IS MADE TO THE EXCLUSIVE RIGHT TO USE "ASSEMBLY", APART FROM THE MARK AS SHOWN. THE COLOR(S) ORANGE, GREEN AND BLACK IS/ARE CLAIMED AS A FEATURE OF THE MARK.

THE MARK CONSISTS OF A GREEN AND BLACK "A" WITH AN ORANGE A NESTED WITHIN THE GREEN AND BLACK "A," WHEREIN BOTH THE GREEN A AND THE ORANGE A ARE TO THE LEFT AND ABOVE THE WORDS ADVANCED ASSEMBLY, WHICH ARE WRITTEN IN BLACK. THERE IS ALSO A SOLID BLACK CIRCLE TO THE LEFT OF THE GREEN AND BLACK "A" AND ANOTHER SOLID BLACK CIRCLE AT THE BOTTOM RIGHT OF THE GREEN AND BLACK "A".

FOR MANUFACTURING SERVICES FOR OTHERS IN THE FIELD OF CIRCUIT BOARDS (U.S. CLS. 100, 103 AND 106).

ALYSSA PALADINO, EXAMINING ATTORNEY

SN 77-157,146. STUFFED ANIMALS.COM, INC., PLAIN-FIELD, IL. FILED 4-16-2007.

Stufftomize

THE MARK CONSISTS OF STANDARD CHARACTERS WITHOUT CLAIM TO ANY PARTICULAR FONT, STYLE, SIZE, OR COLOR.

FOR CUSTOM MANUFACTURE OF TOYS (U.S. CLS. 100, 103 AND 106).

ANDREA BUTLER, EXAMINING ATTORNEY

SN 77-157,229. GREENBERG, GARY H., BOCA RATON, FL. FILED 4-16-2007.

Cosmic Cafe

THE MARK CONSISTS OF STANDARD CHARACTERS WITHOUT CLAIM TO ANY PARTICULAR FONT, STYLE, SIZE, OR COLOR.

FOR IMPRINTING MESSAGES ON WEARING APPAREL, ACCESSORIES AND MUGS (U.S. CLS. 100, 103 AND 106).

ANDREA SAUNDERS, EXAMINING ATTORNEY

CLASS 40—(Continued).

SN 77-157,293. CIELO WIND POWER, L.L.C., AUSTIN, TX. FILED 4-16-2007.

WINDOLOGY

THE MARK CONSISTS OF STANDARD CHARACTERS WITHOUT CLAIM TO ANY PARTICULAR FONT, STYLE, SIZE, OR COLOR.

FOR GENERATION OF WIND GENERATED ELECTRICITY (U.S. CLS. 100, 103 AND 106).

BRENDAN REGAN, EXAMINING ATTORNEY

SN 77-158,532. LONERIDER BREWING COMPANY, FUQUAY VARINA, NC. FILED 4-17-2007.

LONERIDER

THE MARK CONSISTS OF STANDARD CHARACTERS WITHOUT CLAIM TO ANY PARTICULAR FONT, STYLE, SIZE, OR COLOR.

FOR BREWERY SERVICES (U.S. CLS. 100, 103 AND 106).

JASON ROTH, EXAMINING ATTORNEY

SN 77-158,710. SERVPRO INTELLECTUAL PROPERTY, INC., GALLATIN, TN. FILED 4-17-2007.

SERVPRO

THE MARK CONSISTS OF STANDARD CHARACTERS WITHOUT CLAIM TO ANY PARTICULAR FONT, STYLE, SIZE, OR COLOR.

OWNER OF U.S. REG. NOS. 1,707,245 AND 1,845,906. FOR MOLD REMEDIATION SERVICES (U.S. CLS. 100, 103 AND 106).

FIRST USE 1-1-1969; IN COMMERCE 1-1-1969.

GEOFFREY FOSDICK, EXAMINING ATTORNEY

CLASS 40—(Continued).

SN 77-158,962. RADIN, DOREEN M., DBA CAPTION ADVANTAGE, SYRACUSE, NY. FILED 4-17-2007.

CAPTION ADVANTAGE

THE MARK CONSISTS OF STANDARD CHARACTERS WITHOUT CLAIM TO ANY PARTICULAR FONT, STYLE, SIZE, OR COLOR.

NO CLAIM IS MADE TO THE EXCLUSIVE RIGHT TO USE "CAPTION", APART FROM THE MARK AS SHOWN.

FOR REAL-TIME AND POST PRODUCTION CLOSED CAPTIONING SERVICES FOR BROADCAST AND NON-BROADCAST FILMS, TELEVISION PROGRAMS, WEB CASTS, EVENTS, VIDEOS, AND GOVERNMENTAL PROCEEDINGS (U.S. CLS. 100, 103 AND 106).

FIRST USE 10-8-1996; IN COMMERCE 10-8-1996.
CARYN GLASSER, EXAMINING ATTORNEY

SN 77-159,441. MIGHTYAUTHORS.COM, LLC, PROVO, UT. FILED 4-18-2007.

MIGHTYAUTHORS.COM

THE MARK CONSISTS OF STANDARD CHARACTERS WITHOUT CLAIM TO ANY PARTICULAR FONT, STYLE, SIZE, OR COLOR.

FOR BOOKBINDING SERVICES FOR BOOKS AND KEPSAKE COLLECTIONS OF MATERIALS; ON-DEMAND PRINTING SERVICES OF BOOKS, CARDS, POSTERS AND OTHER DOCUMENTS; AND CONVERSION OF PHOTOGRAPHIC IMAGES TO HARDCOPY OR ELECTRONIC MEDIA (U.S. CLS. 100, 103 AND 106).

LINDA ESTRADA, EXAMINING ATTORNEY

SN 77-159,721. ORBITFORM GROUP, JACKSON, MI. FILED 4-18-2007.

RPAS

THE MARK CONSISTS OF STANDARD CHARACTERS WITHOUT CLAIM TO ANY PARTICULAR FONT, STYLE, SIZE, OR COLOR.

FOR WELDING (U.S. CLS. 100, 103 AND 106).
TASHIA BUNCH, EXAMINING ATTORNEY

CLASS 40—(Continued).

SN 77-159,731. ORBITFORM GROUP, JACKSON, MI. FILED 4-18-2007.

APAS

THE MARK CONSISTS OF STANDARD CHARACTERS WITHOUT CLAIM TO ANY PARTICULAR FONT, STYLE, SIZE, OR COLOR.

FOR WELDING (U.S. CLS. 100, 103 AND 106).
TASHIA BUNCH, EXAMINING ATTORNEY

SN 77-160,055. KLABIN DESIGN, INC., CEDAR GROVE, NJ. FILED 4-18-2007.



63-NORTH.COM

THE MARK CONSISTS OF THE NUMBER "63" WITH THE "3" SET BELOW THE BASELINE OF THE "6" WITH A STYLIZED CAPITAL "N" THAT REPRESENTS A NORTH ARROW IMMEDIATELY TO THE RIGHT OF THE "3", THE TOP OF THE "N" MERGES WITH THE RIGHT SIDE TERMINATION OF THE OUTLINE OF A MOUNTAIN PEAK WHICH HANGS OVER "63N". AT THE BOTTOM OF THE MARK IS THE DOMAIN ADDRESS "63-NORTH.COM" IN CAPITAL LETTERS, THE MEANING OF THE MARK REPRESENTS "63 DEGREES NORTH LATITUDE" WHICH IS THE LATITUDE OF MOUNT MCKINLEY IN ALASKA.

FOR IMPRINTING MESSAGES ON T-SHIRTS; IMPRINTING MESSAGES ON WEARING APPAREL, ACCESSORIES AND MUGS (U.S. CLS. 100, 103 AND 106).
CHRISTINA SOBRAL, EXAMINING ATTORNEY

SN 77-160,146. COVIDIEN AG, NEUHAUSEN AM RHEINFALL, SWITZERLAND, FILED 4-18-2007.

COVIDIEN

THE MARK CONSISTS OF STANDARD CHARACTERS WITHOUT CLAIM TO ANY PARTICULAR FONT, STYLE, SIZE, OR COLOR.

FOR CUSTOM CHEMICAL AND PHARMACEUTICAL MANUFACTURING SERVICES (U.S. CLS. 100, 103 AND 106).

STEVEN R. FINE, EXAMINING ATTORNEY

CLASS 40—(Continued).

SN 77-160,538. GEOSIEVE, INC., HOUSTON, TX. FILED 4-19-2007.

GeoSieve

THE MARK CONSISTS OF STANDARD CHARACTERS WITHOUT CLAIM TO ANY PARTICULAR FONT, STYLE, SIZE, OR COLOR.
FOR OIL AND GAS WELL TREATMENT (U.S. CLS. 100, 103 AND 106).
FIRST USE 5-1-2002; IN COMMERCE 5-1-2002.
ANDREA K. NADELMAN, EXAMINING ATTORNEY

CLASS 40—(Continued).

SN 77-177,337. HAWKS VIEW VINEYARDS, LLC, ST. PAUL, MN. FILED 5-10-2007.

SEVEN HAWKS VINEYARDS

THE MARK CONSISTS OF STANDARD CHARACTERS WITHOUT CLAIM TO ANY PARTICULAR FONT, STYLE, SIZE, OR COLOR.
NO CLAIM IS MADE TO THE EXCLUSIVE RIGHT TO USE "VINEYARDS", APART FROM THE MARK AS SHOWN.
FOR WINERY SERVICES (U.S. CLS. 100, 103 AND 106).
CYNTHIA SLOAN, EXAMINING ATTORNEY

SN 77-161,290. KLABIN DESIGN, INC., CEDAR GROVE, NJ. FILED 4-19-2007.

PLAY HARD LIVE GREEN

THE MARK CONSISTS OF STANDARD CHARACTERS WITHOUT CLAIM TO ANY PARTICULAR FONT, STYLE, SIZE, OR COLOR.
FOR IMPRINTING MESSAGES ON T-SHIRTS; IMPRINTING MESSAGES ON WEARING APPAREL, ACCESSORIES AND MUGS (U.S. CLS. 100, 103 AND 106).
CHRISTINA SOBRAL, EXAMINING ATTORNEY

SN 77-161,602. PWG, LLC, SALINAS, CA. FILED 4-20-2007.

PESSAGNO

THE MARK CONSISTS OF STANDARD CHARACTERS WITHOUT CLAIM TO ANY PARTICULAR FONT, STYLE, SIZE, OR COLOR.
OWNER OF U.S. REG. NO. 2,880,518.
FOR WINERY SERVICES (U.S. CLS. 100, 103 AND 106).
FIRST USE 4-19-2001; IN COMMERCE 4-19-2001.
SKYE YOUNG, EXAMINING ATTORNEY

SN 77-198,777. RIDGWAYS, LTD, HOUSTON, TX. FILED 6-6-2007.

Color IT Plus

THE MARK CONSISTS OF STANDARD CHARACTERS WITHOUT CLAIM TO ANY PARTICULAR FONT, STYLE, SIZE, OR COLOR.
NO CLAIM IS MADE TO THE EXCLUSIVE RIGHT TO USE "COLOR IT", APART FROM THE MARK AS SHOWN.
FOR PRINTING SERVICES (U.S. CLS. 100, 103 AND 106).
JUSTINE D. PARKER, EXAMINING ATTORNEY

SN 78-202,713. SPENCER, HOMER, CALGARY, ALBERTA. FILED 1-13-2003.

CAPS

PRIORITY CLAIMED UNDER SEC. 44(D) ON CANADA APPLICATION NO. 1147301, FILED 7-17-2002, REG. NO. TMA691,865, DATED 7-12-2007, EXPIRES 7-12-2022.
FOR OIL AND GAS WELL TREATMENT SERVICES, NAMELY, SEALING ANNULUSES IN OIL AND GAS WELLS (U.S. CLS. 100, 103 AND 106).
DAVID TAYLOR, EXAMINING ATTORNEY

CLASS 40—(Continued).

SN 78-833,555. STRIKE INVESTMENTS, LLC, LOVELAND, OH. FILED 3-9-2006.

FIBRIQ

THE MARK CONSISTS OF STANDARD CHARACTERS WITHOUT CLAIM TO ANY PARTICULAR FONT, STYLE, SIZE, OR COLOR.

FOR TREATMENT OF MATERIALS, NAMELY, TEXTILE TREATMENT IN THE NATURE OF PROVIDING A PERMANENT DURABLE PRESS FINISH TO NATURAL FABRICS THROUGH THE APPLICATION OF CHEMICALS, UNPROCESSED ARTIFICIAL RESINS AND/OR UNPROCESSED PLASTICS IN ORDER TO PROVIDE ANTI-WRINKLING, ANTI-SHRINKING, ANTI-PILLING AND ANTI-FADING BENEFITS; AND FINISHING TREATMENT FOR TEXTILES, NAMELY, PERMANENT DURABLE PRESS FINISHING PROVIDED TO NATURAL FABRICS THROUGH THE APPLICATION OF CHEMICALS, UNPROCESSED ARTIFICIAL RESINS AND/OR UNPROCESSED PLASTICS IN ORDER TO PROVIDE ANTI-WRINKLING, ANTI-SHRINKING, ANTI-PILLING AND ANTI-FADING BENEFITS (U.S. CLS. 100, 103 AND 106).

AMY MCMENAMIN, EXAMINING ATTORNEY

SN 78-934,721. SANFORD DENTURE CLINIC, LLC, LYMAN, ME. FILED 7-21-2006.



THE NAME(S), PORTRAIT(S), AND/OR SIGNATURE(S) SHOWN IN THE MARK IDENTIFIES GARETH COWARD, WHOSE CONSENT(S) TO REGISTER IS SUBMITTED.

FOR DENTAL LABORATORY SERVICES, NAMELY, CUSTOM MANUFACTURE OF DENTURES; DENTAL TECHNICIAN SERVICES, NAMELY, CUSTOM MANUFACTURE OF DENTURES (U.S. CLS. 100, 103 AND 106).

FIRST USE 5-30-2005; IN COMMERCE 5-30-2005.
ESTHER BELENKER, EXAMINING ATTORNEY

CLASS 41—EDUCATION AND ENTERTAINMENT

SN 76-184,896. BRICKS & CLICKS LLC, CLEVELAND, OH. FILED 12-22-2000.

BRICKS & CLICKS THE NEW ECONOMY

NO CLAIM IS MADE TO THE EXCLUSIVE RIGHT TO USE "ECONOMY", APART FROM THE MARK AS SHOWN. FOR PUBLICATION OF MAGAZINES (U.S. CLS. 100, 101 AND 107).

SUE LAWRENCE, EXAMINING ATTORNEY

SN 76-597,679. XM SATELLITE RADIO INC., WASHINGTON, DC. FILED 6-16-2004.

XM PUBLIC RADIO

NO CLAIM IS MADE TO THE EXCLUSIVE RIGHT TO USE "PUBLIC" AND "RADIO", APART FROM THE MARK AS SHOWN.

FOR ENTERTAINMENT SERVICES, NAMELY PROVIDING AUDIO PROGRAMS FEATURING MUSIC, SPORTS, TALK, NEWS AND DATA VIA SATELLITE AND VIA A GLOBAL COMMUNICATION NETWORK (U.S. CLS. 100, 101 AND 107).

FIRST USE 10-0-2004; IN COMMERCE 10-0-2004.
JEFF DEFORD, EXAMINING ATTORNEY

SN 76-669,805. MATHERS, CHRISTINA LEE, MOUNT CROGHAN, SC. FILED 12-1-2006.

NAGELMODEL

THE MARK CONSISTS OF STANDARD CHARACTERS WITHOUT CLAIM TO ANY PARTICULAR FONT, STYLE, SIZE, OR COLOR.

FOR ENTERTAINMENT IN THE NATURE OF DANCE PERFORMANCES (U.S. CLS. 100, 101 AND 107).

KATHY DE JONGE, EXAMINING ATTORNEY

CLASS 41—(Continued).

SN 76-671,651. COLUMBIA ASSOCIATION, INC., COLUMBIA, MD. FILED 1-22-2007.

WINN [When If Not Now]

THE MARK CONSISTS OF STANDARD CHARACTERS WITHOUT CLAIM TO ANY PARTICULAR FONT, STYLE, SIZE, OR COLOR.

OWNER OF U.S. REG. NO. 2,330,949.

FOR EDUCATIONAL SERVICES, NAMELY, CONDUCTING MULTI-WEEK PROGRAM IN THE NATURE OF CLASSES, SEMINARS, AND WORKSHOPS, IN THE FIELD OF HEALTH AND FITNESS (U.S. CLS. 100, 101 AND 107).

FIRST USE 2-0-1997; IN COMMERCE 2-0-1997.
JAMES STEIN, EXAMINING ATTORNEY

CLASS 41—(Continued).

SN 76-672,504. EVA'S HEROES, INC., SAN ANTONIO, TX. FILED 2-9-2007.



SN 76-672,432. EVA'S HEROES, INC., SAN ANTONIO, TX. FILED 2-8-2007.

EVA'S HEROES

THE MARK CONSISTS OF STANDARD CHARACTERS WITHOUT CLAIM TO ANY PARTICULAR FONT, STYLE, SIZE, OR COLOR.

EVA IDENTIFIES A LIVING INDIVIDUAL WHOSE CONSENT IS OF RECORD

FOR EDUCATIONAL AND ENTERTAINMENT SERVICES, NAMELY, PROVIDING CLASSES AND WORKSHOPS IN THE AREAS OF GROOMING, HYGIENE, ARTS AND CRAFTS, AND COOKING FOR CHILDREN WITH DISABILITIES AND THEIR TYPICALLY DEVELOPING PEERS; ENTERTAINMENT SERVICES, NAMELY, PROVIDING RECREATIONAL ACTIVITIES IN THE NATURE OF ARTS AND CRAFTS FOR CHILDREN WITH DISABILITIES AND THEIR TYPICALLY DEVELOPING PEERS (U.S. CLS. 100, 101 AND 107).

PAUL F. GAST, EXAMINING ATTORNEY

EVA IDENTIFIES A LIVING INDIVIDUAL WHOSE CONSENT IS OF RECORD

FOR EDUCATIONAL AND ENTERTAINMENT SERVICES, NAMELY PROVIDING CLASSES AND WORKSHOPS IN THE AREAS OF GROOMING, HYGIENE, ARTS AND CRAFTS, AND COOKING FOR CHILDREN WITH DISABILITIES AND THEIR TYPICALLY DEVELOPING PEERS; ENTERTAINMENT SERVICES, NAMELY, PROVIDING RECREATIONAL ACTIVITIES IN THE NATURE OF ARTS AND CRAFTS FOR CHILDREN WITH DISABILITIES AND THEIR TYPICALLY DEVELOPING PEERS (U.S. CLS. 100, 101 AND 107).

PAUL F. GAST, EXAMINING ATTORNEY

SN 76-675,669. ESSEX MUSIC, INC., NEW YORK, NY. FILED 4-18-2007.

SN 76-672,450. JOHNSON, IVEY JUSTMAN JR., MANTEO, NC. FILED 2-8-2007.

GLIDE WARS

THE MARK CONSISTS OF STANDARD CHARACTERS WITHOUT CLAIM TO ANY PARTICULAR FONT, STYLE, SIZE, OR COLOR.

FOR ENTERTAINMENT IN THE NATURE OF AUTOMOBILE DRAG WAY RACES WHETHER A SINGLE EVENT OR A SERIES OF RACES (U.S. CLS. 100, 101 AND 107).

FIRST USE 9-0-2006; IN COMMERCE 9-0-2006.
TEJBIR SINGH, EXAMINING ATTORNEY

NIGHTS IN WHITE SATIN THE TRIP

THE MARK CONSISTS OF STANDARD CHARACTERS WITHOUT CLAIM TO ANY PARTICULAR FONT, STYLE, SIZE, OR COLOR.

FOR ENTERTAINMENT SERVICES, NAMELY, AN AMUSEMENT PARK RIDE (U.S. CLS. 100, 101 AND 107).
GIANCARLO CASTRO, EXAMINING ATTORNEY

CLASS 41—(Continued).

SN 76-675,671. THE ZIG ZIGLAR CORPORATION, ADDISON, TX. FILED 4-18-2007.

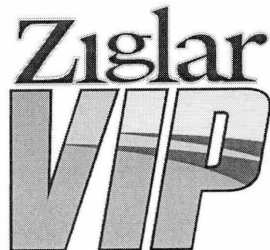

OWNER OF U.S. REG. NOS. 2,189,490, 3,121,921 AND OTHERS.

FOR BUSINESS PERFORMANCE TRAINING SERVICES WHICH INTEGRATES CLASSROOM AND ONLINE LEARNING, FOCUSING ON ACCOUNTABILITY, REINFORCEMENT AND RETENTION MEASUREMENT THROUGH REAL-TIME REPORTING (U.S. CLS. 100, 101 AND 107).

FIRST USE 7-1-2006; IN COMMERCE 7-1-2006.
H. M. FISHER, EXAMINING ATTORNEY

CLASS 41—(Continued).

SN 76-678,613. RADIO ONE, INC., LANHAM, MD. FILED 6-22-2007.

BLACK FACES IN HIGH PLACES

THE MARK CONSISTS OF STANDARD CHARACTERS WITHOUT CLAIM TO ANY PARTICULAR FONT, STYLE, SIZE, OR COLOR.

FOR CONDUCTING TELEVISION AND RADIO AWARD SHOWS RELATED TO THE ACHIEVEMENTS OF AFRICAN AMERICANS; PRODUCTION AND DISTRIBUTION OF RADIO PROGRAMS; ORGANIZING AND CONDUCTING EDUCATIONAL EXHIBITIONS FEATURING PROMINENT AFRICAN AMERICANS; EDUCATIONAL AND ENTERTAINMENT SERVICES FEATURING MOTIVATIONAL AND EDUCATIONAL SPEAKERS (U.S. CLS. 100, 101 AND 107).
AHSEN KHAN, EXAMINING ATTORNEY

SN 76-675,672. PICTORIA STUDIOS USA, INC., ORLANDO, FL. FILED 4-18-2007.

PICTORIA

THE MARK CONSISTS OF STANDARD CHARACTERS WITHOUT CLAIM TO ANY PARTICULAR FONT, STYLE, SIZE, OR COLOR.

FOR PROVIDING MOTION PICTURE FILM PRODUCTION SERVICES (U.S. CLS. 100, 101 AND 107).

FIRST USE 1-1-2007; IN COMMERCE 1-1-2007.
MARGERY A. TIERNEY, EXAMINING ATTORNEY

SN 77-002,893. VERYCKE EDWARD J., CAPE MAY COURT HOUSE, NJ. FILED 9-20-2006.

U.S.A.G.A.

SN 76-675,674. PICTORIA STUDIOS USA, INC., ORLANDO, FL. FILED 4-18-2007.

WE MAKE THE "UNREAL" REAL

THE MARK CONSISTS OF STANDARD CHARACTERS WITHOUT CLAIM TO ANY PARTICULAR FONT, STYLE, SIZE, OR COLOR.

FOR PROVIDING MOTION PICTURE FILM PRODUCTION SERVICES (U.S. CLS. 100, 101 AND 107).

FIRST USE 1-1-2007; IN COMMERCE 1-1-2007.
MARGERY A. TIERNEY, EXAMINING ATTORNEY

THE MARK CONSISTS OF STANDARD CHARACTERS WITHOUT CLAIM TO ANY PARTICULAR FONT, STYLE, SIZE, OR COLOR.

FOR KARATE CLUB (U.S. CLS. 100, 101 AND 107).
FIRST USE 9-20-2006; IN COMMERCE 9-20-2006.
SANDRA MANIOS, EXAMINING ATTORNEY

CLASS 41—(Continued).

SN 77-003,112. LANGUAGE DYNAMICS INC, DANVILLE, IL. FILED 9-20-2006.

LANGUAGE DYNAMICS

THE MARK CONSISTS OF STANDARD CHARACTERS WITHOUT CLAIM TO ANY PARTICULAR FONT, STYLE, SIZE, OR COLOR.

OWNER OF U.S. REG. NO. 2,435,205.

NO CLAIM IS MADE TO THE EXCLUSIVE RIGHT TO USE "LANGUAGE", APART FROM THE MARK AS SHOWN.

FOR EDUCATION SERVICES NAMELY, MENTORING IN THE FIELD OF LANGUAGES; EDUCATION SERVICES NAMELY, ONE-ON-ONE MENTORING IN THE FIELD OF LANGUAGES; EDUCATION SERVICES, NAMELY, PROVIDING TUTORIAL SESSIONS IN THE FIELD OF LANGUAGES; EDUCATION SERVICES, NAMELY, PROVIDING TUTORING IN THE FIELD OF LANGUAGES; EDUCATION SERVICES, NAMELY, PROVIDING CLASSES, SEMINARS AND WORKSHOPS, IN THE FIELD OF LANGUAGES, AND DISTRIBUTING COURSE MATERIALS, NAMELY, BOOKS, MANUALS, CDS, VIDEO TAPES, AUDIO TAPES AND DVDS, IN CONNECTION THEREWITH; EDUCATIONAL SERVICES IN THE NATURE OF LANGUAGE SCHOOLS; EDUCATIONAL SERVICES NAMELY, CONDUCTING PROGRAMS IN THE FIELD OF LANGUAGES; EDUCATIONAL SERVICES, NAMELY, CONDUCTING INFORMAL PROGRAMS IN THE FIELD OF LANGUAGES, USING ON-LINE ACTIVITIES AND INTERACTIVE EXHIBITS, AND PRINTABLE MATERIALS DISTRIBUTED IN CONNECTION THEREWITH; LANGUAGE INSTRUCTION; LANGUAGE SCHOOLS FEATURING ARABIC, MANDARIN, CHINESE, ENGLISH, ENGLISH FOR SPANISH SPEAKERS, FRENCH, GERMAN, ITALIAN, JAPANESE, PORTUGUESE, RUSSIAN, AND SPANISH (U.S. CLS. 100, 101 AND 107).

FIRST USE 7-1-1982; IN COMMERCE 7-1-1982.

EVELYN BRADLEY, EXAMINING ATTORNEY

SN 77-004,248. INFLUENCE AT WORK, L.L.C., TEMPE, AZ. FILED 9-21-2006.

POP WORKSHOP

THE MARK CONSISTS OF STANDARD CHARACTERS WITHOUT CLAIM TO ANY PARTICULAR FONT, STYLE, SIZE, OR COLOR.

NO CLAIM IS MADE TO THE EXCLUSIVE RIGHT TO USE "WORKSHOP", APART FROM THE MARK AS SHOWN.

FOR TRAINING SERVICES AND TRAINING PROGRAMS IN THE FIELDS OF THE APPLIED SCIENCE AND THE PSYCHOLOGY OF INFLUENCE AND PERSUASION, AND DISTRIBUTING TRAINING MATERIALS IN CONNECTION THEREWITH (U.S. CLS. 100, 101 AND 107).

ANNE E. GUSTASON, EXAMINING ATTORNEY

CLASS 41—(Continued).

SN 77-005,016. COURTROOM TELEVISION NETWORK LLC, NEW YORK, NY. FILED 9-22-2006.

MURDER BY THE BOOK

THE MARK CONSISTS OF STANDARD CHARACTERS WITHOUT CLAIM TO ANY PARTICULAR FONT, STYLE, SIZE, OR COLOR.

FOR ENTERTAINMENT SERVICES, NAMELY, A CONTINUING TELEVISION PROGRAM SERIES FEATURING CRIME, CRIMINAL JUSTICE, LAW ENFORCEMENT AND CRIMINAL INVESTIGATIONS; PROVIDING ENTERTAINMENT SERVICES OVER THE INTERNET, NAMELY, ENTERTAINMENT INFORMATION FEATURING CRIME, CRIMINAL JUSTICE, LAW ENFORCEMENT AND CRIMINAL INVESTIGATIONS (U.S. CLS. 100, 101 AND 107).

MARY MUNSON, EXAMINING ATTORNEY

SN 77-005,101. SOCIÉTÉ DES HÔTELS MÉRIDIEEN, PARIS, FRANCE, FILED 9-22-2006.

ONE NIGHT

THE MARK CONSISTS OF STANDARD CHARACTERS WITHOUT CLAIM TO ANY PARTICULAR FONT, STYLE, SIZE, OR COLOR.

FOR ENTERTAINMENT SERVICES, NAMELY CONDUCTING ART EXHIBITIONS (U.S. CLS. 100, 101 AND 107).

PAUL E. FAHRENKOPF, EXAMINING ATTORNEY

CLASS 41—(Continued).

SN 77-005,669. BR CONSULTING, INC., SEDONA, AZ. FILED 9-22-2006.



OWNER OF U.S. REG. NO. 3,141,495.

NO CLAIM IS MADE TO THE EXCLUSIVE RIGHT TO USE "WORLD" AND "ASSOCIATION", APART FROM THE MARK AS SHOWN.

THE FOREIGN WORDING IN THE MARK TRANSLATES INTO ENGLISH AS DAHN MEANS RED OR ENERGY, MU MEANS MARTIAL ART OR NOTHING, DO MEANS THE WAY.

FOR EDUCATIONAL SERVICES, NAMELY, CONDUCTING CLASSES IN THE FIELD OF MARTIAL ARTS TECHNIQUE USING SPECIALIZED BREATHING, MIND CONCENTRATION AND MIND-BODY COORDINATION (U.S. CLS. 100, 101 AND 107).

FIRST USE 11-15-2005; IN COMMERCE 11-15-2005.
SHANNON TWOHIG, EXAMINING ATTORNEY

SN 77-008,459. RED RIVER REVEL ARTS FESTIVAL, SHREVEPORT, LA. FILED 9-27-2006.



OWNER OF U.S. REG. NO. 1,268,241.

THE HORIZONTAL LINE BELOW THE DESIGN ELEMENT STYLIZING THE WORD "CORK" IS PART OF THE MARK.

FOR ENTERTAINMENT SERVICES, NAMELY, CONDUCTING ART FESTIVALS AND WINE TASTING EVENTS (U.S. CLS. 100, 101 AND 107).

REBECCA EISINGER, EXAMINING ATTORNEY

CLASS 41—(Continued).

SN 77-009,018. UNIVERSITY OF SOUTH CAROLINA, COLUMBIA, SC. FILED 9-27-2006.

INSTITUTE FOR HIV PREVENTION LEADERSHIP

THE MARK CONSISTS OF STANDARD CHARACTERS WITHOUT CLAIM TO ANY PARTICULAR FONT, STYLE, SIZE, OR COLOR.

SEC. 2(F).

FOR EDUCATIONAL SERVICES, NAMELY, CONDUCTING ON-SITE AND ONLINE CLASSES, SEMINARS, AND WORKSHOPS IN THE FIELD OF HIV PREVENTION AND PUBLIC HEALTH STRATEGIC PLANNING AND MANAGEMENT; AND DISTRIBUTING COURSE MATERIALS THEREWITH (U.S. CLS. 100, 101 AND 107).

FIRST USE 1-0-2000; IN COMMERCE 1-0-2000.
BERNICE MIDDLETON, EXAMINING ATTORNEY

SN 77-012,190. MEDIA WEST -GSI, INC., RENO, NV. FILED 10-3-2006.

USA TODAY

THE MARK CONSISTS OF STANDARD CHARACTERS WITHOUT CLAIM TO ANY PARTICULAR FONT, STYLE, SIZE, OR COLOR.

NO CLAIM IS MADE TO THE EXCLUSIVE RIGHT TO USE "USA", APART FROM THE MARK AS SHOWN.

FOR PROVIDING NEWS, CURRENT EVENTS AND GENERAL INTEREST INFORMATION VIA THE INTERNET (U.S. CLS. 100, 101 AND 107).

FIRST USE 4-17-1995; IN COMMERCE 4-17-1995.
ELLEN PERKINS, EXAMINING ATTORNEY

SN 77-012,834. TEXAS TRANSPORTATION INSTITUTE, COLLEGE STATION, TX. FILED 10-3-2006.

UNIVERSITY TRANSPORTATION CENTER FOR MOBILITY

THE MARK CONSISTS OF STANDARD CHARACTERS WITHOUT CLAIM TO ANY PARTICULAR FONT, STYLE, SIZE, OR COLOR.

NO CLAIM IS MADE TO THE EXCLUSIVE RIGHT TO USE "UNIVERSITY TRANSPORTATION CENTER", APART FROM THE MARK AS SHOWN.

FOR EDUCATIONAL RESEARCH; EDUCATIONAL SERVICES, NAMELY, PROVIDING COURSES OF INSTRUCTION AT THE COLLEGE LEVEL IN THE FIELD OF TRANSPORTATION; EDUCATIONAL SERVICES, NAMELY, CONDUCTING EDUCATIONAL CONFERENCES AND SEMINARS IN THE FIELD OF TRANSPORTATION (U.S. CLS. 100, 101 AND 107).

CAROLYN CATALDO, EXAMINING ATTORNEY

CLASS 41—(Continued).

SN 77-013,482. HANSMIRE, JAMES KENNETH, DALLAS, TX. FILED 10-4-2006.



NO CLAIM IS MADE TO THE EXCLUSIVE RIGHT TO USE "TEXAS", APART FROM THE MARK AS SHOWN.

THE COLOR(S) RED, WHITE, BLUE, BROWN AND BLACK IS/ARE CLAIMED AS A FEATURE OF THE MARK.

THE MARK CONSISTS OF BACKGROUND OF THE UNITED STATES IN BLUE WITH THE STATE OF TEXAS ENLARGED IN THE CENTER IN BLACK, WHITE AND RED WITH A BROWN FOOTBALL "FLYING" AT THE END OF A RED FLIGHT ARC OUT OF A WHITE STAR FROM THE ENLARGED STATE OF TEXAS, WITH THE WORDS "TEXAS VS. THE NATION" WITH THE WORDS TEXAS AND NATION IN WHITE, OUTLINED IN RED; THE WORD "VS." IN WHITE AND THE WORD "THE" IN BLUE POSITIONED ACROSS THE ENTIRE PICTURE THE BACKGROUND OF THE BLUE NATION.

FOR ENTERTAINMENT SERVICES IN THE NATURE OF ORGANIZING AND CONDUCTING A COLLEGIATE FOOTBALL GAME AND RELATED SPORTING ACTIVITIES; ENTERTAINMENT SERVICES IN THE NATURE OF LIVE PERFORMANCES BY SINGERS, DANCERS, CHEERLEADERS, AND MARCHING BANDS (U.S. CLS. 100, 101 AND 107).

ANTHONY RINKER, EXAMINING ATTORNEY

SN 77-014,084. FREMANTLEMEDIA NORTH AMERICA, INC., BURBANK, CA. FILED 10-4-2006.

FARMER WANTS A WIFE

THE MARK CONSISTS OF STANDARD CHARACTERS WITHOUT CLAIM TO ANY PARTICULAR FONT, STYLE, SIZE, OR COLOR.

FOR ENTERTAINMENT SERVICES IN THE NATURE OF PRODUCTION AND DISTRIBUTION OF A REALITY TELEVISION SERIES; ENTERTAINMENT SERVICES, NAMELY, PROVIDING AN ON-LINE COMPUTER GAME; ENTERTAINMENT SERVICES, NAMELY, PROVIDING A WEBSITE CONTAINING CONTENT RELATING TO A REALITY TELEVISION SERIES (U.S. CLS. 100, 101 AND 107).

JEFF DEFORD, EXAMINING ATTORNEY

CLASS 41—(Continued).

SN 77-015,917. GITOMER, JEFFREY H., CHARLOTTE, NC. FILED 10-6-2006.

YES! ATTITUDE

THE MARK CONSISTS OF STANDARD CHARACTERS WITHOUT CLAIM TO ANY PARTICULAR FONT, STYLE, SIZE, OR COLOR.

FOR EDUCATIONAL SERVICES, NAMELY, SEMINARS, WORKSHOPS AND TRAINING PROGRAMS ON THE SUBJECT OF RETAIL SALES AND BUSINESS PROMOTION AND DEVELOPMENT (U.S. CLS. 100, 101 AND 107).

FIRST USE 12-14-2006; IN COMMERCE 12-14-2006.

JASON LOTT, EXAMINING ATTORNEY

SN 77-016,179. MARTIN, MOROCCO, TACOMA, WA. FILED 10-6-2006.

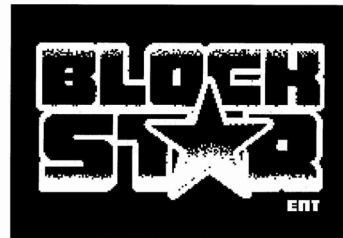

NO CLAIM IS MADE TO THE EXCLUSIVE RIGHT TO USE "ENT", APART FROM THE MARK AS SHOWN.

THE STIPPLING IS FOR SHADING PURPOSES.

THE MARK CONSISTS OF STYLIZED TEXT OF THE WORDING "BLOCK STAR ENT" WITH A STAR REPRESENTING THE LETTER "A" IN "STAR."

FOR ENTERTAINMENT, NAMELY, LIVE PERFORMANCES BY A MUSICAL BAND; MUSIC COMPOSITION AND TRANSCRIPTION FOR OTHERS; MUSIC PRODUCTION SERVICES; SONG WRITING SERVICES (U.S. CLS. 100, 101 AND 107).

FIRST USE 11-2-2002; IN COMMERCE 9-0-2003.

JENNIFER DIXON, EXAMINING ATTORNEY

SN 77-017,275. JMBP, INC., LOS ANGELES, CA. FILED 10-9-2006.

CHARADER

THE MARK CONSISTS OF STANDARD CHARACTERS WITHOUT CLAIM TO ANY PARTICULAR FONT, STYLE, SIZE, OR COLOR.

FOR ENTERTAINMENT IN THE NATURE OF THEATRICAL PERFORMANCES; ENTERTAINMENT SERVICES, NAMELY, PROVIDING ON-LINE COMPUTER GAMES (U.S. CLS. 100, 101 AND 107).

REBECCA EISINGER, EXAMINING ATTORNEY

CLASS 41—(Continued).

SN 77-021,465. DE JESUS, KARIBELMAS, FORT LEE, NJ. AND DE JESUS, SARAH, FORT LEE, NJ. FILED 10-15-2006.

Kari Bel

THE MARK CONSISTS OF STANDARD CHARACTERS WITHOUT CLAIM TO ANY PARTICULAR FONT, STYLE, SIZE, OR COLOR.

KARI BEL IDENTIFIES A LIVING INDIVIDUAL WHOSE CONSENT IS OF RECORD.

FOR ENTERTAINMENT IN THE NATURE OF VISUAL AND AUDIO PERFORMANCES AND LIVE MUSICAL SHOWS (U.S. CLS. 100, 101 AND 107).

FIRST USE 9-5-2004; IN COMMERCE 4-1-2006.
SHANNON TWOHIG, EXAMINING ATTORNEY

SN 77-024,360. INTERCOACH, INC., VERONA, NJ. FILED 10-18-2006.

NOW WHAT?

THE MARK CONSISTS OF STANDARD CHARACTERS WITHOUT CLAIM TO ANY PARTICULAR FONT, STYLE, SIZE, OR COLOR.

FOR EDUCATION SERVICES, NAMELY, PROVIDING SEMINARS IN THE FIELD OF CAREER AND LIFE DIRECTION (U.S. CLS. 100, 101 AND 107).

FIRST USE 1-1-2004; IN COMMERCE 3-1-2004.
TAMARA FRAZIER, EXAMINING ATTORNEY

SN 77-027,720. STEVE JORDAN, PENSACOLA, FL. FILED 10-24-2006.

Retire Rich in Ten Years or Less

THE MARK CONSISTS OF STANDARD CHARACTERS WITHOUT CLAIM TO ANY PARTICULAR FONT, STYLE, SIZE, OR COLOR.

FOR EDUCATIONAL SERVICES, NAMELY, CONDUCTING WORKSHOPS IN THE FIELD OF REAL ESTATE INVESTMENT AND DISTRIBUTION OF COURSE MATERIAL IN CONNECTION THEREWITH (U.S. CLS. 100, 101 AND 107).

FIRST USE 1-1-2004; IN COMMERCE 1-1-2004.
JERI J. FICKES, EXAMINING ATTORNEY

CLASS 41—(Continued).

SN 77-031,126. DANIEL YANES, MIAMI, FL. FILED 10-27-2006.



NO CLAIM IS MADE TO THE EXCLUSIVE RIGHT TO USE "TUTORING", APART FROM THE MARK AS SHOWN. FOR EDUCATION SERVICES, NAMELY, PROVIDING TUTORING IN THE FIELD OF READING, MATHEMATICS, SCIENCE, AND TEST PREPARATION (U.S. CLS. 100, 101 AND 107).

FIRST USE 10-4-2004; IN COMMERCE 10-4-2004.
MONIQUE MILLER, EXAMINING ATTORNEY

SN 77-036,255. MOLINA HEALTHCARE, INC., LONG BEACH, CA. FILED 11-3-2006.

BOOK BUDDIES

THE MARK CONSISTS OF STANDARD CHARACTERS WITHOUT CLAIM TO ANY PARTICULAR FONT, STYLE, SIZE, OR COLOR.

NO CLAIM IS MADE TO THE EXCLUSIVE RIGHT TO USE "BOOK", APART FROM THE MARK AS SHOWN.

FOR ELEEMOSYNARY SERVICES, NAMELY, THE SOLICITATION, COLLECTION AND PROVISION OF DONATED BOOKS FOR CHILDREN AND SCHOOLS (U.S. CLS. 100, 101 AND 107).

FIRST USE 11-0-2002; IN COMMERCE 11-0-2002.
JULIE GUTTADAURO, EXAMINING ATTORNEY

SN 77-038,848. RESORTS INTERNATIONAL HOLDINGS, LLC, NEW YORK, NY. FILED 11-7-2006.

DESTINY DOLLARS

THE MARK CONSISTS OF STANDARD CHARACTERS WITHOUT CLAIM TO ANY PARTICULAR FONT, STYLE, SIZE, OR COLOR.

FOR ENTERTAINMENT, NAMELY CASINO SERVICES, IN CONNECTION WITH CASINO PLAYER REWARDS PROGRAM (U.S. CLS. 100, 101 AND 107).

FIRST USE 6-12-2006; IN COMMERCE 6-12-2006.
JENNIFER KRISP, EXAMINING ATTORNEY

CLASS 41—(Continued).

SN 77-039,942. HEARTIGNITED, L.L.C., MERCER ISLAND, WA. FILED 11-8-2006.

CLASS 41—(Continued).

SN 77-045,136. CHUANG, SHERRY, PLEASANTON, CA. FILED 11-15-2006.

Essence Statement

THE MARK CONSISTS OF STANDARD CHARACTERS WITHOUT CLAIM TO ANY PARTICULAR FONT, STYLE, SIZE, OR COLOR.

FOR PERSONAL COACHING SERVICES IN THE FIELD OF LIFE AND CAREER BUILDING AND MANAGEMENT (U.S. CLS. 100, 101 AND 107).

FIRST USE 8-1-2003; IN COMMERCE 8-1-2003.
TOBY BULLOFF, EXAMINING ATTORNEY

SN 77-041,798. COMEDY NEWS VENTURES, INC., NEW YORK, NY. FILED 11-10-2006.

THE MARK CONSISTS OF STANDARD CHARACTERS WITHOUT CLAIM TO ANY PARTICULAR FONT, STYLE, SIZE, OR COLOR.

FOR COMPOSITION OF MUSIC FOR OTHERS; ENTERTAINMENT IN THE NATURE OF VISUAL AND AUDIO PERFORMANCES; AND MUSICAL, VARIETY, NEWS AND COMEDY SHOWS; ENTERTAINMENT IN THE NATURE OF VISUAL AND AUDIO PERFORMANCES, NAMELY, MUSICAL BAND, ROCK GROUP, GYMNASTIC, DANCE, AND BALLET PERFORMANCES; ENTERTAINMENT NAMELY, LIVE PERFORMANCES BY A MUSICAL BAND; ENTERTAINMENT SERVICES, NAMELY, PROVIDING A WEB SITE FEATURING MUSICAL PERFORMANCES, MUSICAL VIDEOS, RELATED FILM CLIPS, PHOTOGRAPHS, AND OTHER MULTIMEDIA MATERIALS; ENTERTAINMENT SERVICES, NAMELY, PROVIDING ON-LINE REVIEWS OF MUSIC; ENTERTAINMENT SERVICES, NAMELY, PROVIDING PRERECORDED MUSIC, INFORMATION IN THE FIELD OF MUSIC, AND COMMENTARY AND ARTICLES ABOUT MUSIC, ALL ON-LINE VIA A GLOBAL COMPUTER NETWORK; ENTERTAINMENT, NAMELY LIVE MUSIC CONCERTS; ENTERTAINMENT, NAMELY LIVE PERFORMANCES BY MUSICAL BANDS; MUSIC COMPOSITION AND TRANSCRIPTION FOR OTHERS; MUSIC COMPOSITION FOR OTHERS; MUSIC PRODUCTION SERVICES; MUSIC PUBLISHING SERVICES; MUSIC TRANSCRIPTION FOR OTHERS; PLANNING ARRANGEMENT OF SHOWING MOVIES, SHOWS, PLAYS OR MUSICAL PERFORMANCES; PRESENTATION OF MUSICAL PERFORMANCE; PRODUCTION OF SOUND AND MUSIC VIDEO RECORDINGS; PUBLICATION OF MUSICAL TEXTS (U.S. CLS. 100, 101 AND 107).

FIRST USE 1-1-2006; IN COMMERCE 9-30-2006.
DANIEL RUSSELL, EXAMINING ATTORNEY

SN 77-046,970. CONSOLIDATED RESORTS, INC., LAS VEGAS, NV. FILED 11-17-2006.

23/6

SECOND HONEYMOON A MILLION
DOLLAR LOVE AFFAIR

THE MARK CONSISTS OF STANDARD CHARACTERS WITHOUT CLAIM TO ANY PARTICULAR FONT, STYLE, SIZE, OR COLOR.

FOR PROVIDING WEBSITES IN THE FIELD OF HUMOR, NEWS, SATIRE, GOSSIP, PARODY, AND ENTERTAINMENT NAMELY, ARTICLES, QUOTES, BLOGS, VIDEO CLIPS, AUDIO CLIPS, PICTURES, AND SLIDE SHOWS (U.S. CLS. 100, 101 AND 107).

DANNEAN HETZEL, EXAMINING ATTORNEY

THE MARK CONSISTS OF STANDARD CHARACTERS WITHOUT CLAIM TO ANY PARTICULAR FONT, STYLE, SIZE, OR COLOR.

OWNER OF U.S. REG. NO. 3,057,758.

NO CLAIM IS MADE TO THE EXCLUSIVE RIGHT TO USE "SECOND HONEYMOON", APART FROM THE MARK AS SHOWN.

FOR ENTERTAINMENT SERVICES, NAMELY, CONDUCTING CONTESTS FEATURING MARRIED AND DATING COUPLES IN LIVE EVENTS AND TELEVISION SHOWS; ON-GOING TELEVISION GAME SHOWS (U.S. CLS. 100, 101 AND 107).

FIRST USE 2-12-2005; IN COMMERCE 2-12-2005.
MICHAEL SOUDERS, EXAMINING ATTORNEY

CLASS 41—(Continued).

SN 77-047,796. GLASS SIDEWALK PRODUCTIONS LLC, SANTA MONICA, CA. FILED 11-20-2006.

GLASS SIDEWALK

THE MARK CONSISTS OF STANDARD CHARACTERS WITHOUT CLAIM TO ANY PARTICULAR FONT, STYLE, SIZE, OR COLOR.

FOR MULTIMEDIA ENTERTAINMENT SERVICES IN THE NATURE OF RECORDING, PRODUCTION AND POST-PRODUCTION SERVICES IN THE FIELDS OF MUSIC, VIDEO, AND FILMS (U.S. CLS. 100, 101 AND 107).

REBECCA SMITH, EXAMINING ATTORNEY

SN 77-050,815. L.R.LAX, INC., ITHACA, NY. FILED 11-27-2006.

LAXIFIED

THE MARK CONSISTS OF STANDARD CHARACTERS WITHOUT CLAIM TO ANY PARTICULAR FONT, STYLE, SIZE, OR COLOR.

FOR PROVIDING A WEBSITE WHICH ALLOWS USERS TO ACCESS AND POST INFORMATION REGARDING LACROSSE AND LACROSSE TOURNAMENTS (U.S. CLS. 100, 101 AND 107).

FIRST USE 1-31-2006; IN COMMERCE 1-31-2006.
PAM WILLIS, EXAMINING ATTORNEY

SN 77-051,858. HESS, KIM, MIAMI BEACH, FL. FILED 11-28-2006.



NO CLAIM IS MADE TO THE EXCLUSIVE RIGHT TO USE "YOGA ONBOARD", APART FROM THE MARK AS SHOWN.

THE MARK CONSISTS OF STYLIZED TEXT AND AN ABSTRACT IMAGE OF A PERSON DOING YOGA.

FOR YOGA INSTRUCTION (U.S. CLS. 100, 101 AND 107).

FIRST USE 9-0-2005; IN COMMERCE 1-0-2006.
CHARLES L. JENKINS, EXAMINING ATTORNEY

CLASS 41—(Continued).

SN 77-052,421. XTASIS MUSIC LLC, COCONUT GROVE, FL. FILED 11-28-2006.

**XTASIS MUSIC**

NO CLAIM IS MADE TO THE EXCLUSIVE RIGHT TO USE "MUSIC", APART FROM THE MARK AS SHOWN.

FOR MUSIC PRODUCTION SERVICES (U.S. CLS. 100, 101 AND 107).

FIRST USE 9-13-2005; IN COMMERCE 9-13-2005.
FRED CARL, EXAMINING ATTORNEY

SN 77-054,532. COLLEGENET, INC., PORTLAND, OR. FILED 11-30-2006.

IT PAYS TO THINK

THE MARK CONSISTS OF STANDARD CHARACTERS WITHOUT CLAIM TO ANY PARTICULAR FONT, STYLE, SIZE, OR COLOR.

FOR EDUCATION AND ENTERTAINMENT SERVICES, NAMELY, ARRANGING OF CONTESTS; CONTESTS AND COMPETITION PROGRAMS FOR SCHOLARSHIP AWARDS; CONTESTS AND COMPETITIONS IN WHICH INDIVIDUALS COMPETE FOR SCHOLARSHIPS BY PARTICIPATING IN AN ON-LINE DISCUSSION FORUM; CONTESTS AND COMPETITIONS IN WHICH SCHOLARSHIPS ARE AWARDED VIA AN ONLINE VOTING PROCESS; EDUCATIONAL SERVICES, NAMELY, CONTESTS AND COMPETITIONS AMONG SCHOLARSHIP APPLICANTS IN THE FIELDS OF CURRENT AFFAIRS AND GENERAL KNOWLEDGE (U.S. CLS. 100, 101 AND 107).

PATRICIA EVANKO, EXAMINING ATTORNEY

SN 77-063,712. THE RACING EXPERIENCE, INC., LONGVIEW, TX. FILED 12-13-2006.

CHAMPIONSHIP RACING EXPERIENCE

THE MARK CONSISTS OF STANDARD CHARACTERS WITHOUT CLAIM TO ANY PARTICULAR FONT, STYLE, SIZE, OR COLOR.

NO CLAIM IS MADE TO THE EXCLUSIVE RIGHT TO USE "RACING", APART FROM THE MARK AS SHOWN.

FOR ENTERTAINMENT IN THE NATURE OF PROVIDING RIDES IN HIGH PERFORMANCE RACE CARS (U.S. CLS. 100, 101 AND 107).

FIRST USE 4-30-2006; IN COMMERCE 4-30-2006.
HANNO RITTNER, EXAMINING ATTORNEY

CLASS 41—(Continued).

SN 77-064,982. CUYAHOGA COMMUNITY COLLEGE DISTRICT, CLEVELAND, OH. FILED 12-15-2006.

TRI-C

THE MARK CONSISTS OF STANDARD CHARACTERS WITHOUT CLAIM TO ANY PARTICULAR FONT, STYLE, SIZE, OR COLOR.

FOR EDUCATIONAL SERVICES, NAMELY, CONDUCTING COURSES OF INSTRUCTION AT THE COMMUNITY COLLEGE LEVEL; CONDUCTING CLASSES IN THE FIELD OF WORKFORCE TRAINING, COMPUTER CERTIFICATION, CUSTOMER SERVICE TRAINING, AND MANAGEMENT AND LEADERSHIP DEVELOPMENT; ARRANGING EDUCATIONAL CONFERENCES, EXHIBITIONS, MEETINGS, AND SEMINARS; CONDUCTING EDUCATIONAL CONFERENCES, EXHIBITIONS, MEETINGS, AND SEMINARS IN THE FIELD OF BUSINESS AND EDUCATION (U.S. CLS. 100, 101 AND 107).

FIRST USE 5-1-1972; IN COMMERCE 5-1-1972.
TONI HICKEY, EXAMINING ATTORNEY

SN 77-090,522. THE CARTOON NETWORK, INC., ATLANTA, GA. FILED 1-24-2007.

BOOMEROYALTY

THE MARK CONSISTS OF STANDARD CHARACTERS WITHOUT CLAIM TO ANY PARTICULAR FONT, STYLE, SIZE, OR COLOR.

FOR ENTERTAINMENT SERVICES IN THE NATURE OF AN ON-GOING ANIMATED PROGRAM SERIES PROVIDED THROUGH CABLE TELEVISION, BROADCAST TELEVISION, INTERNET, VIDEO-ON-DEMAND, AND THROUGH OTHER DISTRIBUTION PLATFORMS. (U.S. CLS. 100, 101 AND 107).

KENNETH E. SHARPERSON, EXAMINING ATTORNEY

SN 77-090,529. THE CARTOON NETWORK, INC., ATLANTA, GA. FILED 1-24-2007.

FRIED DYNAMITE

THE MARK CONSISTS OF STANDARD CHARACTERS WITHOUT CLAIM TO ANY PARTICULAR FONT, STYLE, SIZE, OR COLOR.

FOR ENTERTAINMENT SERVICES IN THE NATURE OF AN ON-GOING ANIMATED AND LIVE ACTION PROGRAM SERIES PROVIDED THROUGH CABLE TELEVISION, BROADCAST TELEVISION, INTERNET, VIDEO-ON-DEMAND, AND THROUGH OTHER DISTRIBUTION PLATFORMS. (U.S. CLS. 100, 101 AND 107).

KENNETH E. SHARPERSON, EXAMINING ATTORNEY

CLASS 41—(Continued).

SN 77-095,782. FORD, DAVID, NEW BERLIN, WI. FILED 1-31-2007.

Dave Ford Ministries

THE MARK CONSISTS OF STANDARD CHARACTERS WITHOUT CLAIM TO ANY PARTICULAR FONT, STYLE, SIZE, OR COLOR.

NO CLAIM IS MADE TO THE EXCLUSIVE RIGHT TO USE "MINISTRIES", APART FROM THE MARK AS SHOWN.

FOR RELIGIOUS INSTRUCTION SERVICES (U.S. CLS. 100, 101 AND 107).

GEORGIA CARTY, EXAMINING ATTORNEY

SN 77-100,858. VAYNBERG, DANA MILLER, WEST SACRAMENTO, CA. FILED S.R. 2-6-2007; AM. P.R. 8-30-2007.



FOR CHILDREN'S ENTERTAINMENT AND AMUSEMENT CENTERS, NAMELY, INTERACTIVE PLAY AREAS INDOOR INFLATABLE FUN CENTER FOR PARTIES, CLASSES AND PLAY-SESSIONS (U.S. CLS. 100, 101 AND 107).

FIRST USE 2-1-2007; IN COMMERCE 2-1-2007.

SHAUNIA CARLYLE, EXAMINING ATTORNEY

SN 77-102,197. THE CARTOON NETWORK, INC., ATLANTA, GA. FILED 2-8-2007.



THE MARK CONSISTS OF A STYLIZED CREST CONTAINING A STYLIZED B.

FOR ENTERTAINMENT SERVICES IN THE NATURE OF AN ON-GOING ANIMATED PROGRAM SERIES PROVIDED THROUGH CABLE TELEVISION, BROADCAST TELEVISION, INTERNET, VIDEO-ON-DEMAND, AND THROUGH OTHER DISTRIBUTION PLATFORMS (U.S. CLS. 100, 101 AND 107).

KENNETH E. SHARPERSON, EXAMINING ATTORNEY

CLASS 41—(Continued).

SN 77-108,021. MILLER, MICHAEL C., EDMOND, OK.
FILED 2-15-2007.



THE MARK CONSISTS OF THE WORD PHOTOGRAPHY IS IN FUTURA MEDIUM FONT AND IS DIVIDED BY A LARGE STYLIZED LETTER P, IN TIME NEW ROMAN FONT. THERE IS A NUMERAL 3 WHICH IS SUPERSCRIPTED (RAISED) AND PLACED TO THE RIGHT OF THE LARGE LETTER P.

FOR PHOTOGRAPHY SERVICES (U.S. CLS. 100, 101 AND 107).

FIRST USE 4-20-2002; IN COMMERCE 4-20-2002.
GRETTA YAO, EXAMINING ATTORNEY

SN 77-108,739. THE NEW RELEASE, LOS ANGELES, CA.
FILED 2-15-2007.

MOVIECUBE

THE MARK CONSISTS OF STANDARD CHARACTERS WITHOUT CLAIM TO ANY PARTICULAR FONT, STYLE, SIZE, OR COLOR.

FOR RENTAL OF DVDS, VIDEOTAPES AND MOTION PICTURES (U.S. CLS. 100, 101 AND 107).

AHSEN KHAN, EXAMINING ATTORNEY

SN 77-110,952. REAL COOKING, INC., SANTA MONICA, CA.
FILED 2-19-2007.

Real Cooking

THE MARK CONSISTS OF STANDARD CHARACTERS WITHOUT CLAIM TO ANY PARTICULAR FONT, STYLE, SIZE, OR COLOR.

NO CLAIM IS MADE TO THE EXCLUSIVE RIGHT TO USE "COOKING", APART FROM THE MARK AS SHOWN.

FOR EDUCATION SERVICES, NAMELY, PROVIDING CLASSES AND COACHING IN THE FIELD OF COOKING AND NUTRITION (U.S. CLS. 100, 101 AND 107).

FIRST USE 11-20-2004; IN COMMERCE 11-20-2004.
MICHAEL SOUDERS, EXAMINING ATTORNEY

CLASS 41—(Continued).

SN 77-110,953. REAL COOKING, INC., SANTA MONICA, CA.
FILED 2-19-2007.

NO CLAIM IS MADE TO THE EXCLUSIVE RIGHT TO USE "COOKING", APART FROM THE MARK AS SHOWN. THE MARK CONSISTS OF THE WORDS "REAL" AND "COOKING" SEPARATED BY A STYLIZED IMAGE OF A LEAF.

FOR EDUCATION SERVICES, NAMELY, PROVIDING CLASSES AND COACHING IN THE FIELD OF COOKING AND NUTRITION (U.S. CLS. 100, 101 AND 107).

FIRST USE 11-20-2004; IN COMMERCE 11-20-2004.
MICHAEL SOUDERS, EXAMINING ATTORNEY

SN 77-110,955. REAL COOKING, INC., SANTA MONICA, CA.
FILED 2-19-2007.



NO CLAIM IS MADE TO THE EXCLUSIVE RIGHT TO USE "COOKING", APART FROM THE MARK AS SHOWN.

THE MARK CONSISTS OF THE WORDS "REAL COOKING", AN IMAGE OF TWO LEAVES BELOW A STEW POT FROM WHICH KITCHEN IMPLEMENTS AND GRAIN STALKS ARE PROTRUDING, TOGETHER WITH ADDITIONAL WORDS: "NOURISHING TOOLS FOR VIBRANT HEALTH".

FOR EDUCATION SERVICES, NAMELY, PROVIDING CLASSES AND COACHING IN THE FIELD OF COOKING AND NUTRITION (U.S. CLS. 100, 101 AND 107).

FIRST USE 11-20-2004; IN COMMERCE 11-20-2004.
MICHAEL SOUDERS, EXAMINING ATTORNEY

SN 77-112,264. FORD, DAVID, NEW BERLIN, WI. FILED 2-21-2007.

Roots of Christianity

THE MARK CONSISTS OF STANDARD CHARACTERS WITHOUT CLAIM TO ANY PARTICULAR FONT, STYLE, SIZE, OR COLOR.

NO CLAIM IS MADE TO THE EXCLUSIVE RIGHT TO USE "CHRISTIANITY", APART FROM THE MARK AS SHOWN.

FOR RELIGIOUS INSTRUCTION SERVICES (U.S. CLS. 100, 101 AND 107).

GEORGIA CARTY, EXAMINING ATTORNEY

CLASS 41—(Continued).

SN 77-113,926. ILLUMINATE INCORPORATED, BOSTON, MA. FILED 2-22-2007.

Courageous Selling

THE MARK CONSISTS OF STANDARD CHARACTERS WITHOUT CLAIM TO ANY PARTICULAR FONT, STYLE, SIZE, OR COLOR.

NO CLAIM IS MADE TO THE EXCLUSIVE RIGHT TO USE "SELLING", APART FROM THE MARK AS SHOWN.

FOR EDUCATIONAL SERVICES, NAMELY, SEMINARS, PROGRAMS, CLASSES AND WORKSHOPS ON SALES TECHNIQUES AND BUSINESS PERFORMANCE, AND DISTRIBUTING COURSE MATERIALS IN CONNECTION THEREWITH (U.S. CLS. 100, 101 AND 107).

RAMONA ORTIGA, EXAMINING ATTORNEY

SN 77-114,909. BAUM, JEFFREY, NEW YORK, NY. FILED 2-23-2007.

CENTRAL VILLAGE

THE MARK CONSISTS OF STANDARD CHARACTERS WITHOUT CLAIM TO ANY PARTICULAR FONT, STYLE, SIZE, OR COLOR.

FOR NEWS, INFORMATION AND COMMENTARY ON CULTURAL MATTERS, NAMELY MUSIC, TELEVISION, MOTION PICTURES, SPORTS AND VIDEO-GAMES, IRRESPECTIVE OF GEOGRAPHIC LOCATION RENDERED OVER THE INTERNET (U.S. CLS. 100, 101 AND 107).

FIRST USE 5-25-2004; IN COMMERCE 5-25-2004.

KAREN K. BUSH, EXAMINING ATTORNEY

SN 77-117,452. TELEMUNDO NETWORK GROUP LLC, HIELEAH, FL. FILED 2-27-2007.

CINE MILLONARIO

THE MARK CONSISTS OF STANDARD CHARACTERS WITHOUT CLAIM TO ANY PARTICULAR FONT, STYLE, SIZE, OR COLOR.

NO CLAIM IS MADE TO THE EXCLUSIVE RIGHT TO USE "CINE", APART FROM THE MARK AS SHOWN.

THE FOREIGN WORDING IN THE MARK TRANSLATES INTO ENGLISH AS MILLIONAIRE MOVIE.

FOR ENTERTAINMENT SERVICES, NAMELY, AN ON-GOING SERIES FEATURING SPANISH-LANGUAGE MOTION PICTURES AND SPANISH-LANGUAGE TELEVISION PROGRAMMING PROVIDED THROUGH BROADCAST, CABLE AND SATELLITE TELEVISION (U.S. CLS. 100, 101 AND 107).

FIRST USE 2-11-2007; IN COMMERCE 2-11-2007.

STANLEY I. OSBORNE, EXAMINING ATTORNEY

CLASS 41—(Continued).

SN 77-121,767. LEWIS MARTINEE, MIAMI, FL. FILED 3-4-2007.

EXPOSE'

THE MARK CONSISTS OF STANDARD CHARACTERS WITHOUT CLAIM TO ANY PARTICULAR FONT, STYLE, SIZE, OR COLOR.

FOR ENTERTAINMENT SERVICES, NAMELY LIVE PERFORMANCES BY A VOCAL AND INSTRUMENTAL GROUP (U.S. CLS. 100, 101 AND 107).

FIRST USE 1-1-1986; IN COMMERCE 1-1-1986.

MICHAEL TANNER, EXAMINING ATTORNEY

SN 77-126,076. GREEN DOOR COMMUNICATIONS, LLC, GLEN ELLYN, IL. FILED 3-8-2007.



Green
Door

THE COLOR(S) GREEN AND BRONZE IS/ARE CLAIMED AS A FEATURE OF THE MARK.

THE COLOR GREEN APPEARS IN THE DOOR AND THE WORDING GREEN DOOR; THE COLOR BRONZE APPEARS IN THE HANDLE AND LOCK ON THE DOOR.

FOR CONSULTING SERVICES IN THE FIELD OF LEADERSHIP TRAINING (U.S. CLS. 100, 101 AND 107).

FIRST USE 9-1-2006; IN COMMERCE 9-1-2006.

GEORGIA CARTY, EXAMINING ATTORNEY

CLASS 41—(Continued).

SN 77-129,069. CHEYENNE MOUNTAIN ENTERTAINMENT, INC., MESA, AZ. FILED 3-12-2007.

DEADLANDS

THE MARK CONSISTS OF STANDARD CHARACTERS WITHOUT CLAIM TO ANY PARTICULAR FONT, STYLE, SIZE, OR COLOR.

FOR ENTERTAINMENT SERVICES, NAMELY, PROVIDING AN ON-LINE COMPUTER GAME FOR OTHERS OVER GLOBAL AND LOCAL AREA COMPUTER NETWORKS; PROVIDING AND HOSTING ONLINE COMPUTER GAME COMPETITIONS FOR OTHERS OVER GLOBAL AND LOCAL AREA COMPUTER NETWORKS (U.S. CLS. 100, 101 AND 107).

JAMES A. RAUEN, EXAMINING ATTORNEY

CLASS 41—(Continued).

SN 77-133,652. OSM MEDIA, LLC, EL SEGUNDO, CA. FILED 3-17-2007.

ENERGYTREK

THE MARK CONSISTS OF STANDARD CHARACTERS WITHOUT CLAIM TO ANY PARTICULAR FONT, STYLE, SIZE, OR COLOR.

FOR ONLINE JOURNALS, NAMELY, WEBLOGS FEATURING PODCASTS, ARTICLES, VIDEOS, COMMENTARIES, OPINIONS AND ORIGINAL REPORTING IN THE FIELD OF ENERGY CONSERVATION (U.S. CLS. 100, 101 AND 107).

HANNO RITTNER, EXAMINING ATTORNEY

SN 77-131,828. DAVIDSON AND MICHAELS, LLC, MARLTON, NJ. FILED 3-15-2007.

Canine Dimensions

THE MARK CONSISTS OF STANDARD CHARACTERS WITHOUT CLAIM TO ANY PARTICULAR FONT, STYLE, SIZE, OR COLOR.

NO CLAIM IS MADE TO THE EXCLUSIVE RIGHT TO USE "CANINE", APART FROM THE MARK AS SHOWN. FOR DOG TRAINING (U.S. CLS. 100, 101 AND 107). FIRST USE 1-1-2006; IN COMMERCE 1-1-2006. INGRID C. EULIN, EXAMINING ATTORNEY

SN 77-132,523. CILLUFFO, SCOTT LEE, LEXINGTON, NC. FILED 3-15-2007.

Me Against Me Squared

THE MARK CONSISTS OF STANDARD CHARACTERS WITHOUT CLAIM TO ANY PARTICULAR FONT, STYLE, SIZE, OR COLOR.

FOR ENTERTAINMENT IN THE NATURE OF VISUAL AND AUDIO PERFORMANCES, NAMELY, MUSICAL BAND, ROCK GROUP, GYMNASTIC, DANCE, AND BALLET PERFORMANCES (U.S. CLS. 100, 101 AND 107). DOMINIC J. FERRAIUOLO, EXAMINING ATTORNEY

SN 77-133,871. HACKETT, ZANNAH, ENCINITAS, CA. AND HACKETT, DAVID, ENCINITAS, CA. FILED 3-18-2007.

Y.O.U.

THE MARK CONSISTS OF STANDARD CHARACTERS WITHOUT CLAIM TO ANY PARTICULAR FONT, STYLE, SIZE, OR COLOR.

FOR WORKSHOPS, SEMINARS AND TRAVEL SEMINARS IN THE FIELD OF SELF IMPROVEMENT, INTENDED TO MOTIVATE; EDUCATIONAL SERVICES NAMELY CONDUCTING CERTIFICATE PROGRAMS IN THE FIELD OF SELF IMPROVEMENT, INTENDING TO MOTIVATE; EDUCATION AND ENTERTAINMENT SERVICES, NAMELY, LECTURES IN THE FIELD OF SELF IMPROVEMENT, INTENDED TO MOTIVATE, PRODUCTION OF TELEVISION PROGRAMS, RADIO PROGRAMS, CINEMATOGRAPHIC FILMS, AND THEATRE SHOWS FEATURING MUSIC AND DOCUMENTARIES, DRAMAS, COMEDIES, AND CARTOONS IN THE FIELD OF SELF IMPROVEMENT, INTENDED TO MOTIVATE; PRODUCTION OF TELEVISION, RADIO, SATELLITE TELEVISION, CABLE TELEVISION, SUBSCRIPTION TELEVISION, AND PAY-PER-VIEW TELEVISION PROGRAMS, MOBILE TELEPHONE VIDEO PROGRAMS, AND INTERNET VIDEO PROGRAMS; PRODUCTION OF VIDEO TAPES AND VIDEO DISCS FEATURING MUSIC AND DOCUMENTARIES, DRAMAS, COMEDIES, AND CARTOONS IN THE FIELD OF SELF IMPROVEMENT, INTENDED TO MOTIVATE; INTERACTIVE ENTERTAINMENT SERVICES FOR USE WITH A MOBILE PHONE, NAMELY, PRE-RECORDED VOICEMAIL MESSAGES, TEXT MESSAGES AND EMAILS IN THE FIELD OF SELF IMPROVEMENT, INTENDED TO MOTIVATE; PROVIDING ON-LINE SERVICES, NAMELY COMPUTER-BASED GAMES IN THE FIELD OF SELF IMPROVEMENT, INTENDED TO MOTIVATE (U.S. CLS. 100, 101 AND 107).

FIRST USE 10-8-2003; IN COMMERCE 10-8-2003.

KEVIN DINALLO, EXAMINING ATTORNEY

CLASS 41—(Continued).

SN 77-133,899. PETTERSON, SCOTT V, JEFFERSON, OR.
FILED 3-18-2007.



NO CLAIM IS MADE TO THE EXCLUSIVE RIGHT TO USE "PORTLAND", APART FROM THE MARK AS SHOWN. THE COLOR(S) RED, WHITE AND BLACK IS/ARE CLAIMED AS A FEATURE OF THE MARK.

THE MARK CONSISTS OF A COWBOY RIDING A HORSE AND THE WORDS "PORTLAND BUCKAROOS"; THE COWBOY IS WEARING A RED AND WHITE SHIRT, BLACK PANTS, AND RED AND WHITE ICE SKATES; THE COWBOY IS HOLDING A BLACK LASSO IN ONE HAND AND A BLACK HOCKEY STICK IN THE OTHER; THE COWBOY'S FACE AND HANDS ARE THE COLOR WHITE; THE HORSE IS RED WITH WHITE EYES AND TEETH; THE HORSE IS WEARING TWO RED AND WHITE ICE SKATES, AND TWO BLACK ICE SKATES; THE HORSE'S TAIL AND MANE ARE BLACK; THE FEATURES OF THE COWBOY AND HORSE ARE OUTLINED IN BLACK; THE LETTERS IN THE WORDS "PORTLAND BUCKAROOS" ARE BLACK WITH RED OUTLINING.

FOR ENTERTAINMENT IN THE NATURE OF HOCKEY GAMES; PROVIDING A WEBSITE FEATURING SPORTING INFORMATION; PROVIDING A WEBSITE THAT PROVIDES SPORTS LEAGUE PLAYER STATISTICS (U.S. CLS. 100, 101 AND 107).

FIRST USE 6-30-1998; IN COMMERCE 6-30-1998.
RICHARD A. STRASER, EXAMINING ATTORNEY

SN 77-136,323. LIGONIER MINISTRIES, INC., LAKE MARY, FL. FILED 3-21-2007.

RENEWING YOUR MIND

THE MARK CONSISTS OF STANDARD CHARACTERS WITHOUT CLAIM TO ANY PARTICULAR FONT, STYLE, SIZE, OR COLOR.

FOR EDUCATIONAL SERVICES, NAMELY, LECTURES GIVEN ONLINE VIA LIVE AND PRERECORDED SESSIONS AND IN CLASSES, SEMINARS, AND WORKSHOPS IN THE FIELD OF RELIGION AND CHRISTIAN EDUCATION; PROVIDING RELIGIOUS PROGRAMS OVER BROADCAST MEDIA, NAMELY, PROVIDING ONGOING PROGRAM IN THE FIELD OF RELIGION ACCESSIBLE BY RADIO, TELEVISION, DIGITAL VIDEO BROADCAST, STREAMING AUDIO AND VIDEO BROADCASTS ON THE INTERNET (U.S. CLS. 100, 101 AND 107).

FIRST USE 12-1-1994; IN COMMERCE 12-1-1994.
TASHIA BUNCH, EXAMINING ATTORNEY

CLASS 41—(Continued).

SN 77-136,349. THE BAR METHOD, INC., SAN FRANCISCO, CA. FILED 3-21-2007.

THE BAR METHOD

THE MARK CONSISTS OF STANDARD CHARACTERS WITHOUT CLAIM TO ANY PARTICULAR FONT, STYLE, SIZE, OR COLOR.

OWNER OF U.S. REG. NO. 2,679,225.

NO CLAIM IS MADE TO THE EXCLUSIVE RIGHT TO USE "METHOD", APART FROM THE MARK AS SHOWN. SEC. 2(F).

FOR EXERCISE INSTRUCTION (U.S. CLS. 100, 101 AND 107).

FIRST USE 11-6-2000; IN COMMERCE 11-6-2000.
SARA THOMAS, EXAMINING ATTORNEY

SN 77-137,756. SKI-PAL, LLC, ROCHESTER, NY. FILED 3-22-2007.

SKI-PAL

THE MARK CONSISTS OF STANDARD CHARACTERS WITHOUT CLAIM TO ANY PARTICULAR FONT, STYLE, SIZE, OR COLOR.

FOR SKI INSTRUCTION (U.S. CLS. 100, 101 AND 107).

FIRST USE 1-5-2006; IN COMMERCE 9-15-2006.
LA TONIA FISHER, EXAMINING ATTORNEY

SN 77-138,029. DRUMTALK39 ENTERTAINMENT, KENSINGTON, MD. FILED S.R. 3-22-2007; AM. P.R. 7-11-2007.



NO CLAIM IS MADE TO THE EXCLUSIVE RIGHT TO USE "RECORDING", APART FROM THE MARK AS SHOWN.

THE COLOR(S) DARK BLUE, LIGHT BLUE, GREEN, YELLOW, BROWN, ORANGE, WHITE, DARK ORANGE, BLACK AND PINK IS/ARE CLAIMED AS A FEATURE OF THE MARK.

THE MARK CONSISTS OF THE WORDING TRUSOUNDS IN BLACK WITH GREEN OUTLINE, DIRECTLY ABOVE A HORIZONTAL LINE AND THE WORDING RECORDING IN BLACK; ABOVE THE WORDING IN THE MARK IS A DESIGN ELEMENT CONSISTING OF FOUR ADJACENT RECTANGLES; FROM LEFT TO RIGHT, THE FIRST RECTANGLE CONTAINS A BLANK FACE WEARING HEADPHONES IN PINK WITH A SUNSET BACKGROUND IN BLACK, ORANGE, BROWN AND YELLOW; THE SECOND RECTANGLE CONTAINS A BLANK FACE WEAR-

CLASS 41—(Continued).

ING HEAD PHONES IN VARYING SHADES OF LIGHT BLUE TO THE LEFT OF A WHITE LIGHTNING BOLT AGAINST A DARK BLUE SKY BACKGROUND; THE THIRD RECTANGLE CONTAINS A BLANK FACE WEARING HEADPHONES IN ORANGE AGAINST A LIGHT BLUE AND DARK BLUE SKY BACKGROUND WITH DARK BLUE RAIN DROPS; THE FOURTH RECTANGLE CONTAINS A BLANK FACE WEARING HEADPHONES IN DARK ORANGE AGAINST A BACKGROUND OF GREEN LEAVES.

FOR PROFESSIONAL COACHING IN THE FIELD OF AUDIO AND VIDEO RECORDING IN THE ENTERTAINMENT INDUSTRY (U.S. CLS. 100, 101 AND 107).

FIRST USE 0-0-2000; IN COMMERCE 0-0-2000.
NICHOLAS ALTREE, EXAMINING ATTORNEY

CLASS 41—(Continued).

SN 77-142,458. RESPECT DA GAME MULTIMEDIA ENTERTAINMENT LLC, DISTRICT HEIGHTS, MD. FILED 3-28-2007.



SN 77-139,107. THE WILHELM KARL MAYBACH FOUNDATION, SAN FRANCISCO, CA. FILED 3-23-2007.



"THE MARK CONSISTS OF THREE PENGUINS AND RDG AND RESPECT DA GAME IN TEXT."

FOR MUSIC PRODUCTION SERVICES; POST-PRODUCTION EDITING SERVICES IN THE FIELD OF MUSIC, VIDEOS AND FILMS; PRODUCTION OF SOUND AND MUSIC VIDEO RECORDINGS (U.S. CLS. 100, 101 AND 107).

FIRST USE 10-1-2005; IN COMMERCE 10-1-2005.
LINDA POWELL, EXAMINING ATTORNEY

THE MARK CONSISTS OF COAT OF ARMS. FOR CHARITABLE SERVICES, NAMELY, MENTORING OF YOUNG ADULTS IN THE FIELDS OF EDUCATION, BUSINESS AND THE ARTS (U.S. CLS. 100, 101 AND 107).

FIRST USE 11-1-2005; IN COMMERCE 11-1-2005.
CHERYL CLAYTON, EXAMINING ATTORNEY

SN 77-143,303. SAFAKHOO, MARCO M., PENSACOLA, FL. FILED 3-29-2007.

SN 77-141,291. EASTERBROOK, AARON, LOS ANGELES, CA. FILED 3-27-2007.

Schoolamazoo

THE MARK CONSISTS OF STANDARD CHARACTERS WITHOUT CLAIM TO ANY PARTICULAR FONT, STYLE, SIZE, OR COLOR.

FOR EDUCATIONAL SERVICES, NAMELY, PRODUCTION, DISTRIBUTION AND CONDUCTING OF EDUCATIONAL GAME SHOWS FOR STUDENTS IN THE FIELD OF MATH, SCIENCE, SOCIAL SCIENCE, ART, AND ENGLISH LANGUAGE SKILLS; PRESENTATION OF LIVE SHOW PERFORMANCES (U.S. CLS. 100, 101 AND 107).

PETER CHENG, EXAMINING ATTORNEY



THE MARK CONSISTS OF A WARRIOR SILHOUETTE HOLDING A SWORD IN A COMBATIVE STANCE.

FOR MARTIAL ARTS INSTRUCTION; OPERATING OF MARTIAL ARTS' SCHOOLS (U.S. CLS. 100, 101 AND 107).

FIRST USE 4-27-1983; IN COMMERCE 4-27-1983.
BILL DAWE, EXAMINING ATTORNEY

CLASS 41—(Continued).

SN 77-144,031. THE NEW RELEASE, LOS ANGELES, CA.
FILED 3-29-2007.



NO CLAIM IS MADE TO THE EXCLUSIVE RIGHT TO USE "MOVIE", APART FROM THE MARK AS SHOWN.

THE MARK CONSISTS OF WORD MOVIE WITH A THREE DIMENSIONAL CUBE AS THE LETTER O ABOVE THE WORD CUBE.

FOR RENTAL OF DVDS, VIDEOTAPES AND MOTION PICTURES (U.S. CLS. 100, 101 AND 107).
AHSEN KHAN, EXAMINING ATTORNEY

SN 77-144,044. THE NEW RELEASE, LOS ANGELES, CA.
FILED 3-29-2007.



THE MARK CONSISTS OF WORD MOVIE WITH A THREE DIMENSIONAL CUBE AS THE LETTER O NEXT TO THE WORD CUBE.

FOR RENTAL OF DVDS, VIDEOTAPES AND MOTION PICTURES (U.S. CLS. 100, 101 AND 107).
AHSEN KHAN, EXAMINING ATTORNEY

SN 77-145,903. JUSTINIANO, VICTOR, ORANGE PARK, FL.
FILED 4-2-2007.

APOCALYPSIS

THE MARK CONSISTS OF STANDARD CHARACTERS WITHOUT CLAIM TO ANY PARTICULAR FONT, STYLE, SIZE, OR COLOR.

FOR ENTERTAINMENT IN THE NATURE OF LIVE PERFORMANCES BY A MUSICAL ARTIST (U.S. CLS. 100, 101 AND 107).
LAURA HAMMEL, EXAMINING ATTORNEY

CLASS 41—(Continued).

SN 77-146,860. KNOCKOUT PRODUCTIONS, LEXINGTON, KY. FILED 4-2-2007.



NO CLAIM IS MADE TO THE EXCLUSIVE RIGHT TO USE "AMERICAN FIGHT LEAGUE", APART FROM THE MARK AS SHOWN.

THE MARK CONSISTS OF THE LETTERS "AFL", FILLED WITH STARS AND STRIPES PATTERNED AFTER THE AMERICAN FLAG. THE EFFECT GIVEN IS THAT OF THE AMERICAN FLAG WAVING "THROUGH" THE LETTERS "AFL". THE WORDS AMERICAN FIGHT LEAGUE ARE UNDERNEATH THE LETTERS "AFL".

FOR ENTERTAINMENT SERVICES IN THE NATURE OF MIXED MARTIAL ARTS COMPETITIONS (U.S. CLS. 100, 101 AND 107).

FIRST USE 2-24-2007; IN COMMERCE 2-24-2007.
JOHN E. MICHOS, EXAMINING ATTORNEY

SN 77-147,864. PELINSKI, JUDANNE, LAKE IN THE HILLS, IL. FILED 4-3-2007.

TURNING YOUR PASSION INTO
A PROFESSION

THE MARK CONSISTS OF STANDARD CHARACTERS WITHOUT CLAIM TO ANY PARTICULAR FONT, STYLE, SIZE, OR COLOR.

FOR TRAINING SERVICES, NAMELY, INSTRUCTION OF REDESIGN OF INTERIOR DECORATING FOR RESIDENCES AND BUSINESSES, AND OF STAGING INTERIOR DECORATING IN PREPARATION FOR THE SALE OF RESIDENCES (U.S. CLS. 100, 101 AND 107).

FIRST USE 1-1-2006; IN COMMERCE 1-1-2006.
DAVID COLLIER, EXAMINING ATTORNEY

SN 77-148,196. DOMINION RESOURCES, INC., RICHMOND, VA. FILED 4-4-2007.

PROJECT
PLANT IT!

FOR EDUCATION SERVICES, NAMELY, PROVIDING CLASSES AND FIELD TRIPS IN THE FIELDS OF ECOLOGY AND CONSERVATION AND REPLENISHMENT OF NATURAL RESOURCES (U.S. CLS. 100, 101 AND 107).

FIRST USE 3-26-2007; IN COMMERCE 3-26-2007.
ALYSSA PALADINO, EXAMINING ATTORNEY

CLASS 41—(Continued).

SN 77-149,046. N2ITIVE1 INNOVATIONS, LLC, COLORADO SPRINGS, CO. FILED 4-4-2007.

GUARDIAN ANGEL

THE MARK CONSISTS OF STANDARD CHARACTERS WITHOUT CLAIM TO ANY PARTICULAR FONT, STYLE, SIZE, OR COLOR.

FOR EDUCATIONAL SERVICES, NAMELY, PROVIDING CLASSES, SEMINARS, AND WORKSHOPS IN THE FIELDS OF SUBSTANCE ABUSE AND LEADING A HEALTHY LIFESTYLE (U.S. CLS. 100, 101 AND 107).
JACLYN KIDWELL, EXAMINING ATTORNEY

SN 77-149,137. KITCHEN, ERIC, BOONSBORO, MD. FILED 4-5-2007.



THE COLOR(S) WHITE, GREY, RED, AND BLACK IS/ ARE CLAIMED AS A FEATURE OF THE MARK.

THE MARK CONSISTS OF THE PHRASE REAL RACE CARS HAVE A CLUTCH ARCHING AROUND A STYLIZED WHITE, BLACK, AND GRAY GEAR SHIFT DESIGN. THE WORD CLUTCH APPEARS IN RED AND THE WORDS REAL RACE CARS HAVE A APPEAR IN BLACK.

FOR ENTERTAINMENT IN THE NATURE OF DRAG RACES (U.S. CLS. 100, 101 AND 107).

FIRST USE 0-0-1996; IN COMMERCE 0-0-1996.
JACLYN KIDWELL, EXAMINING ATTORNEY

CLASS 41—(Continued).

SN 77-149,149. FORTIS FITNESS, LLC, BERNARDSVILLE, NJ. FILED 4-5-2007.



NO CLAIM IS MADE TO THE EXCLUSIVE RIGHT TO USE "FITNESS", APART FROM THE MARK AS SHOWN. THE MARK CONSISTS OF TWO ARC SHAPES POSITIONED BETWEEN THE WORDS FORTIS AND FITNESS.

FOR PERSONAL TRAINING SERVICES, NAMELY, STRENGTH AND CONDITIONING TRAINING; PROVIDING INFORMATION IN THE FIELD OF EXERCISE TRAINING; PROVIDING FITNESS AND EXERCISE FACILITIES (U.S. CLS. 100, 101 AND 107).

FIRST USE 4-1-2006; IN COMMERCE 4-1-2006.
JACLYN KIDWELL, EXAMINING ATTORNEY

SN 77-149,754. MCLAUGHLIN, CHARLENE, MANALAPAN, NJ. FILED 4-5-2007.

CHALLENGER CHEERLEADERS

THE MARK CONSISTS OF STANDARD CHARACTERS WITHOUT CLAIM TO ANY PARTICULAR FONT, STYLE, SIZE, OR COLOR.

NO CLAIM IS MADE TO THE EXCLUSIVE RIGHT TO USE "CHEERLEADERS", APART FROM THE MARK AS SHOWN.

FOR EDUCATION SERVICES, NAMELY, ONE-ON-ONE MENTORING IN THE FIELD OF ATHLETIC ACHIEVEMENT, ENTERTAINMENT AND SOCIAL INTERACTION FOR CHILDREN WITH DISABILITIES (U.S. CLS. 100, 101 AND 107).

FIRST USE 1-18-2006; IN COMMERCE 1-18-2006.
ERIN FALK, EXAMINING ATTORNEY

SN 77-149,933. LAMS PRODUCTIONS, INC., NEW YORK, NY. FILED 4-5-2007.

LAMS Productions

THE MARK CONSISTS OF STANDARD CHARACTERS WITHOUT CLAIM TO ANY PARTICULAR FONT, STYLE, SIZE, OR COLOR.

NO CLAIM IS MADE TO THE EXCLUSIVE RIGHT TO USE "PRODUCTIONS", APART FROM THE MARK AS SHOWN.

FOR ENTERTAINMENT IN THE NATURE OF THEATER PRODUCTIONS (U.S. CLS. 100, 101 AND 107).

FIRST USE 0-0-1999; IN COMMERCE 0-0-1999.
JASON BLAIR, EXAMINING ATTORNEY

CLASS 41—(Continued).

SN 77-150,128. COX, MICHAEL D., QUEEN CREEK, AZ. FILED 4-5-2007.



NO CLAIM IS MADE TO THE EXCLUSIVE RIGHT TO USE "KOI", APART FROM THE MARK AS SHOWN.
 THE MARK CONSISTS OF THE WORD KOI IN ALL CAPS WITH THE WORD NATIONS TOWARD THE BOTTOM HALF OF THE WORD KOI. UNDERNEATH IS THE WORDS IN CAPS, NORTH, SOUTH, EAST, WEST WITH A SQUARE BULLET POINT BETWEEN EACH ONE.
 FOR MAGAZINE PUBLISHING (U.S. CLS. 100, 101 AND 107).
 ROBIN MITTLER, EXAMINING ATTORNEY

CLASS 41—(Continued).

SN 77-150,263. PRESBYTERIAN CONFERENCE ASSOCIATION, INC., HOLMES, NY. FILED 4-5-2007.



NO CLAIM IS MADE TO THE EXCLUSIVE RIGHT TO USE "PRESBYTERIAN CAMP & CONFERENCE CENTER", APART FROM THE MARK AS SHOWN.
 THE MARK CONSISTS OF AN IMAGE OF A TREE AMIDST THE LANDSCAPE OF A FIELD AND A LAKE, WITH MOUNTAINOUS TERRAIN IN THE BACKGROUND, ALL APPEARING ABOVE THE STYLIZED WORDS HOLMES PRESBYTERIAN CAMP & CONFERENCE CENTER.
 FOR RECREATIONAL CAMPS (U.S. CLS. 100, 101 AND 107).
 AMY BROZENIC, EXAMINING ATTORNEY

SN 77-150,264. BLB, INC., LOS ANGELES, CA. FILED 4-5-2007.

LUNCH BUNCH

SN 77-150,261. PRESBYTERIAN CONFERENCE ASSOCIATION, INC., HOLMES, NY. FILED 4-5-2007.

THERE'S NO PLACE LIKE HOLMES!

THE MARK CONSISTS OF STANDARD CHARACTERS WITHOUT CLAIM TO ANY PARTICULAR FONT, STYLE, SIZE, OR COLOR.
 FOR RECREATIONAL CAMPS (U.S. CLS. 100, 101 AND 107).
 FIRST USE 0-0-1998; IN COMMERCE 0-0-1998.
 AMY BROZENIC, EXAMINING ATTORNEY

THE MARK CONSISTS OF STANDARD CHARACTERS WITHOUT CLAIM TO ANY PARTICULAR FONT, STYLE, SIZE, OR COLOR.
 FOR MOBILE MEDIA AND ENTERTAINMENT SERVICES IN THE NATURE OF CONTENT PREPARATION; ENTERTAINMENT SERVICES, NAMELY, PROVIDING A RADIO PROGRAM IN THE FIELD OF VARIETY SHOWS VIA A GLOBAL COMPUTER NETWORK; ENTERTAINMENT SERVICES, NAMELY, PROVIDING A TELEVISION PROGRAM IN THE FIELD OF VARIETY SHOWS VIA A GLOBAL COMPUTER NETWORK; ENTERTAINMENT SERVICES IN THE NATURE OF ON-GOING TELEVISION PROGRAMS IN THE FIELD OF CHILDREN'S ENTERTAINMENT; ENTERTAINMENT IN THE NATURE OF LIVE PERFORMANCES BY ACTORS, MUSICIANS, CELEBRITY ENTERTAINERS, MODELS, COMEDIANS AND / OR ARTISTS; ENTERTAINMENT IN THE NATURE OF ON-GOING TELEVISION PROGRAMS IN THE FIELD OF VARIETY SHOWS; ENTERTAINMENT IN THE NATURE OF VISUAL AND AUDIO PERFORMANCES, NAMELY, MUSICAL BAND, ROCK GROUP, GYMNASIAC, DANCE, AND BALLET PERFORMANCES; ENTERTAINMENT NAMELY, PRODUCTION OF MOVIES, THEATRE, RADIO PROGRAMS, TELEVISION PROGRAMS, AND INTERNET PROGRAMS (U.S. CLS. 100, 101 AND 107).
 AMY BROZENIC, EXAMINING ATTORNEY

CLASS 41—(Continued).

SN 77-150,679. PORTILLO, RODOLFO, BLOOMINGTON, CA. AND HERRERA, ROSARIO, BLOOMINGTON, CA. FILED 4-6-2007.

EL GUERO ELIZALDE

THE MARK CONSISTS OF STANDARD CHARACTERS WITHOUT CLAIM TO ANY PARTICULAR FONT, STYLE, SIZE, OR COLOR.

THE NAME(S), PORTRAIT(S), AND/OR SIGNATURE(S) SHOWN IN THE MARK DOES NOT IDENTIFY A PARTICULAR LIVING INDIVIDUAL.

THE FOREIGN WORDING IN THE MARK TRANSLATES INTO ENGLISH AS THE BLOND ONE ELIZALDE.

FOR ENTERTAINMENT IN THE NATURE OF LIVE PERFORMANCES BY A MUSICAL ARTIST AND ENTERTAINER (U.S. CLS. 100, 101 AND 107).

BILL DAWE, EXAMINING ATTORNEY

CLASS 41—(Continued).

SN 77-150,747. AOL LLC, DULLES, VA. FILED 4-6-2007.

POCKETBROWSE

THE MARK CONSISTS OF STANDARD CHARACTERS WITHOUT CLAIM TO ANY PARTICULAR FONT, STYLE, SIZE, OR COLOR.

FOR PROVIDING INFORMATION VIA COMPUTER NETWORKS IN THE FIELD OF ENTERTAINMENT, MUSIC, SPORTS, AND NEWS IN THE NATURE OF CURRENT EVENTS REPORTING; ENTERTAINMENT SERVICES, NAMELY, NON-DOWNLOADABLE GRAPHICS AND TEXT IN THE FIELDS OF ENTERTAINMENT, MUSIC, SPORTS AND NEWS PRESENTED TO MOBILE COMMUNICATIONS DEVICES, PERSONAL DIGITAL ASSISTANTS, AND WIRELESS COMMUNICATIONS DEVICES VIA A GLOBAL COMPUTER NETWORK AND WIRELESS NETWORKS (U.S. CLS. 100, 101 AND 107).

DANIEL RUSSELL, EXAMINING ATTORNEY

SN 77-150,764. EARLY DEVELOPMENT OF GLOBAL EDUCATION, LLC, CUTLER BAY, FL. FILED 4-6-2007.

SN 77-150,738. AOL LLC, DULLES, VA. FILED 4-6-2007.

POCKETBROWSE.COM



The Early Development of Global Education

NO CLAIM IS MADE TO THE EXCLUSIVE RIGHT TO USE "GLOBAL EDUCATION", APART FROM THE MARK AS SHOWN.

THE COLOR(S) BLUE, GREEN, AND BROWN IS/ARE CLAIMED AS A FEATURE OF THE MARK.

THE MARK CONSISTS OF ONE HORIZONTALLY LAID GRADIENT GREEN LEAF WITH A BLUE VEIN, PARTIALLY CONCEALING A BROWN AND BLUE EARTH GLOBE GRAPHIC. THE ACRONYM E.D.G.E. IS UPPER ARCHED DIRECTLY ABOVE THE EARTH GLOBE GRAPHIC IN GREEN AND THE WORDS "THE EARLY DEVELOPMENT OF GLOBAL EDUCATION" APPEAR IN GREEN BELOW THE LEAF.

FOR EDUCATIONAL SERVICES, NAMELY, CONDUCTING PROGRAMS IN THE FIELD OF THE ENVIRONMENT; EDUCATIONAL SERVICES, NAMELY, DEVELOPING CURRICULUM FOR OTHERS IN THE FIELD OF THE ENVIRONMENT (U.S. CLS. 100, 101 AND 107).

JANICE KIM, EXAMINING ATTORNEY

THE MARK CONSISTS OF STANDARD CHARACTERS WITHOUT CLAIM TO ANY PARTICULAR FONT, STYLE, SIZE, OR COLOR.

FOR PROVIDING INFORMATION VIA COMPUTER NETWORKS IN THE FIELD OF ENTERTAINMENT, MUSIC, SPORTS, AND NEWS IN THE NATURE OF CURRENT EVENTS REPORTING; ENTERTAINMENT SERVICES, NAMELY, NON-DOWNLOADABLE GRAPHICS AND TEXT IN THE FIELDS OF ENTERTAINMENT, MUSIC, SPORTS AND NEWS PRESENTED TO MOBILE COMMUNICATIONS DEVICES, PERSONAL DIGITAL ASSISTANTS, AND WIRELESS COMMUNICATIONS DEVICES VIA A GLOBAL COMPUTER NETWORK AND WIRELESS NETWORKS (U.S. CLS. 100, 101 AND 107).

DANIEL RUSSELL, EXAMINING ATTORNEY

CLASS 41—(Continued).

SN 77-150,864. BROYLES, PAMELA S, SAN JOSE, CA. AND KOHLSCHMIDT, TAMMY M, NEW YORK, NY. AND BELLER, ERIN LEE, CARO, MI. FILED 4-6-2007.

be Dance be Charmed

THE MARK CONSISTS OF STANDARD CHARACTERS WITHOUT CLAIM TO ANY PARTICULAR FONT, STYLE, SIZE, OR COLOR.

FOR TEACHING IN THE FIELD OF DANCE, YOGA, PHYSICAL FITNESS, MEDITATION, CHANTING, NUTRITION, AND CREATIVE MOVEMENT; ENTERTAINMENT IN THE NATURE OF BALLET PERFORMANCES; ENTERTAINMENT IN THE NATURE OF DANCE PERFORMANCES; ENTERTAINMENT IN THE NATURE OF GYMNASTIC PERFORMANCES; ENTERTAINMENT IN THE NATURE OF LIVE PERFORMANCES BY DANCE AND CREATIVE MOVEMENT; ENTERTAINMENT IN THE NATURE OF VISUAL AND AUDIO PERFORMANCES, AND MUSICAL, VARIETY, NEWS AND COMEDY SHOWS; ENTERTAINMENT IN THE NATURE OF VISUAL AND AUDIO PERFORMANCES, NAMELY, MUSICAL BAND, ROCK GROUP, GYMNASTIC, DANCE, AND BALLET PERFORMANCES; ENTERTAINMENT SERVICES, NAMELY, PROVIDING A WEB SITE FEATURING MUSICAL PERFORMANCES, MUSICAL VIDEOS, RELATED FILM CLIPS, PHOTOGRAPHS, AND OTHER MULTIMEDIA MATERIALS; PLANNING ARRANGEMENT OF SHOWING MOVIES, SHOWS, PLAYS OR MUSICAL PERFORMANCES; PRESENTATION OF LIVE SHOW PERFORMANCES (U.S. CLS. 100, 101 AND 107).

FIRST USE 9-8-2006; IN COMMERCE 9-8-2006.
LINDA MICKLEBURGH, EXAMINING ATTORNEY

CLASS 41—(Continued).

SN 77-151,320. VINCE PAUL ABBOTT, NEW YORK, NY. FILED 4-7-2007.

HEAVY METAL HAUNTED HOUSE

THE MARK CONSISTS OF STANDARD CHARACTERS WITHOUT CLAIM TO ANY PARTICULAR FONT, STYLE, SIZE, OR COLOR.

NO CLAIM IS MADE TO THE EXCLUSIVE RIGHT TO USE "HEAVY METAL", APART FROM THE MARK AS SHOWN.

FOR ENTERTAINMENT, NAMELY, LIVE MUSIC CONCERTS, INCLUDING LIVE PERFORMANCES BY A MUSICAL ARTIST AND MUSICAL BAND; ENTERTAINMENT, NAMELY, PERSONAL APPEARANCES BY A MUSICIAN AND MUSICAL BAND; ENTERTAINMENT SERVICES, NAMELY, PROVIDING A WEB SITE FEATURING MUSICAL PERFORMANCES, MUSICAL VIDEOS, RELATED FILM CLIPS, AND PHOTOGRAPHS; ENTERTAINMENT SERVICES, NAMELY, PROVIDING PRERECORDED MUSIC, INFORMATION IN THE FIELD OF MUSIC, COMMENTARY AND ARTICLES ABOUT MUSIC, SCHEDULES OF RELEASES OF SOUND RECORDINGS, SCHEDULES OF RELEASES OF VIDEO RECORDINGS, SCHEDULES OF RELEASES OF LASER AND DIGITAL RECORDINGS, SCHEDULES OF RELEASES OF MULTI-MEDIA SOFTWARE, SCHEDULES OF RELEASES OF COLLECTIBLES, FASHION, APPAREL, JEWELRY AND PRINTED MATTER MERCHANDISE, SCHEDULES OF TOURS, SCHEDULES OF TRAVEL, SCHEDULES OF LIVE AND PRERECORDED MUSICAL PERFORMANCES, SCHEDULES OF LIVE AND PERSONAL APPEARANCES, ALL ONLINE VIA A GLOBAL COMPUTER NETWORK; PRODUCTION OF RADIO AND TELEVISION PROGRAMS; PRODUCTION OF MUSIC VIDEOS AND MUSIC PRODUCTION SERVICES; AUDIO RECORDING AND PRODUCTION; SOUND RECORDING STUDIOS; COMPOSITION OF MUSIC FOR OTHERS AND ORGANIZING EXHIBITIONS FOR MUSICAL ENTERTAINMENT (U.S. CLS. 100, 101 AND 107).

LESLEY LAMOTHE, EXAMINING ATTORNEY

SN 77-151,309. SKARLEE, LLC, WASHOE VALLEY, NV. FILED 4-7-2007.

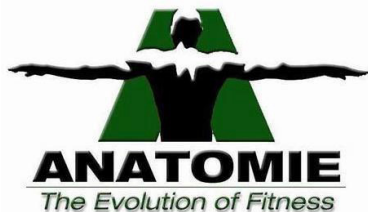

THE COLOR(S) GREEN, WHITE AND BLACK. IS/ARE CLAIMED AS A FEATURE OF THE MARK.

THE COLOR BLACK APPEARS IN THE WORDING ANATOMIE, IN THE LINE UNDERLINING THE WORD ANATOMIE, THE WORDING THE EVOLUTION OF FITNESS AND IN THE DESIGN OF THE BACK UPPER TORSO OF A MALE FIGURE. THE COLOR GREEN APPEARS IN THE STYLIZED LETTER "A" AND IN THE SHADOW OF THE WORDING THE EVOLUTION OF FITNESS. THE COLOR WHITE APPEARS IN THE HIGHLIGHTS OF THE MAN'S BODY.

FOR PHYSICAL FITNESS CONDITIONING CLASSES (U.S. CLS. 100, 101 AND 107).

FIRST USE 3-1-2007; IN COMMERCE 3-1-2007.
CAROL SPILS, EXAMINING ATTORNEY

SN 77-151,635. EAKINS, CARRIE, CHICAGO, IL. FILED 4-9-2007.

DRUMS ALIVE

THE MARK CONSISTS OF STANDARD CHARACTERS WITHOUT CLAIM TO ANY PARTICULAR FONT, STYLE, SIZE, OR COLOR.

FOR EDUCATIONAL SERVICES, NAMELY, CONDUCTING CLASSES AND WORKSHOPS FOR FITNESS TRAINERS AND INSTRUCTORS, MEDICAL FITNESS TRAINERS AND INSTRUCTORS, AND HEALTH CARE PROVIDERS, ALL IN THE FIELDS OF FITNESS, MEDICAL FITNESS AND HEALTH CARE; PROVIDING TRAINING AND COURSES IN THE FIELDS OF FITNESS, MEDICAL FITNESS AND HEALTH CARE; PROVIDING INSTRUCTION IN THE FIELDS OF FITNESS, MEDICAL FITNESS AND HEALTH CARE (U.S. CLS. 100, 101 AND 107).

FIRST USE 12-31-2002; IN COMMERCE 7-10-2004.
JAMES MACFARLANE, EXAMINING ATTORNEY

CLASS 41—(Continued).

SN 77-151,803. FAST FORWARD VENTURES, LAS VEGAS, NV. FILED 4-9-2007.

The Masters of the Grill

THE MARK CONSISTS OF STANDARD CHARACTERS WITHOUT CLAIM TO ANY PARTICULAR FONT, STYLE, SIZE, OR COLOR.

FOR CONDUCTING ENTERTAINMENT EXHIBITIONS IN THE NATURE OF FOOD AND WINE FESTIVALS (U.S. CLS. 100, 101 AND 107).

KATHRYN COWARD, EXAMINING ATTORNEY

SN 77-151,973. JAKE BRENNAN, SOMERVILLE, MA. FILED 4-9-2007.

PopEd

THE MARK CONSISTS OF STANDARD CHARACTERS WITHOUT CLAIM TO ANY PARTICULAR FONT, STYLE, SIZE, OR COLOR.

FOR ENTERTAINMENT SERVICES, NAMELY, PROVIDING PRERECORDED MUSIC, INFORMATION IN THE FIELD OF MUSIC, AND COMMENTARY AND ARTICLES ABOUT MUSIC, ALL ON-LINE VIA A GLOBAL COMPUTER NETWORK; MUSIC PUBLISHING SERVICES; SONG WRITING SERVICES; PRODUCTION OF SOUND AND MUSIC VIDEO RECORDINGS; ENTERTAINMENT SERVICES, NAMELY, PROVIDING A WEB SITE FEATURING MUSICAL PERFORMANCES, MUSICAL VIDEOS, RELATED FILM CLIPS, PHOTOGRAPHS, AND OTHER MULTIMEDIA MATERIALS (U.S. CLS. 100, 101 AND 107).

MATTHEW EINSTEIN, EXAMINING ATTORNEY

SN 77-152,453. ADIBI FITNESS ENTERPRISES, LLC, CHARLOTTE, NC. FILED 4-10-2007.

PEKidz
Fit for Life

THE COLOR(S) BLACK, ORANGE, AND WHITE IS/ARE CLAIMED AS A FEATURE OF THE MARK.

THE MARK CONSISTS OF THE WORD PEKIDZ, WITH PE IN BLACK AND KIDZ IN ORANGE, OVER THE WORDS FIT FOR LIFE, ALSO IN BLACK, WITH A WHITE BACKGROUND.

FOR HEALTH CLUB SERVICES, NAMELY, PROVIDING INSTRUCTION AND EQUIPMENT IN THE FIELD OF PHYSICAL EXERCISE (U.S. CLS. 100, 101 AND 107).

MARY MUNSON, EXAMINING ATTORNEY

CLASS 41—(Continued).

SN 77-153,182. THE NEW RELEASE, LOS ANGELES, CA. FILED 4-10-2007.

WHAT'S IN IT FOR YOU?

THE MARK CONSISTS OF STANDARD CHARACTERS WITHOUT CLAIM TO ANY PARTICULAR FONT, STYLE, SIZE, OR COLOR.

FOR RENTAL OF DVDS, VIDEOTAPES AND MOTION PICTURES (U.S. CLS. 100, 101 AND 107).

AHSEN KHAN, EXAMINING ATTORNEY

SN 77-153,519. WALTROUS, SEAN L., NEW YORK, NY. FILED 4-10-2007.

shutterlove
digital

NO CLAIM IS MADE TO THE EXCLUSIVE RIGHT TO USE "DIGITAL", APART FROM THE MARK AS SHOWN.

THE COLOR(S) PURPLE AND BLACK IS/ARE CLAIMED AS A FEATURE OF THE MARK.

THE MARK CONSISTS OF THE WORD "SHUTTERLOVE" IN A PURPLE (RGB VALUES RED 127, GREEN 94, AND BLUE 94) CENTURY GOTHIC FONT AND THE WORD "DIGITAL" IN A BLACK ZAFFINO FONT. "SHUTTERLOVE" IS THE LARGER WORD AT A RATIO OF 8:3 IN FONT SIZE.

FOR PHOTOGRAPHY SERVICES (U.S. CLS. 100, 101 AND 107).

JAMES MACFARLANE, EXAMINING ATTORNEY

SN 77-153,761. XCELERATION, INC., ATLANTA, GA. FILED 4-11-2007.

RewardStation

THE MARK CONSISTS OF STANDARD CHARACTERS WITHOUT CLAIM TO ANY PARTICULAR FONT, STYLE, SIZE, OR COLOR.

FOR PROVIDING RECOGNITION AND INCENTIVES BY THE WAY OF AWARDS TO DEMONSTRATE EXCELLENCE IN THE FIELD OF SALES, MARKETING, FINANCE, AND ADMINISTRATION (U.S. CLS. 100, 101 AND 107).

FIRST USE 3-1-2000; IN COMMERCE 3-1-2000.

B. PARADEWELAI, EXAMINING ATTORNEY

CLASS 41—(Continued).

SN 77-153,817. HUETT, LORI A., VENTURA, CA. FILED 4-11-2007.

TRANZENDANCE

THE MARK CONSISTS OF STANDARD CHARACTERS WITHOUT CLAIM TO ANY PARTICULAR FONT, STYLE, SIZE, OR COLOR.

FOR DANCE EVENTS; DANCE INSTRUCTION; DANCE SCHOOLS; DANCE STUDIOS; ENTERTAINMENT IN THE NATURE OF DANCE PERFORMANCES; ORGANIZATION OF DANCING EVENTS (U.S. CLS. 100, 101 AND 107).

FIRST USE 2-7-2007; IN COMMERCE 3-21-2007.
MATTHEW PAPPAS, EXAMINING ATTORNEY

SN 77-154,578. JANET L. JOHNSON, LAWRENCE, KS. FILED 4-11-2007.

Piano Detectives

THE MARK CONSISTS OF STANDARD CHARACTERS WITHOUT CLAIM TO ANY PARTICULAR FONT, STYLE, SIZE, OR COLOR.

NO CLAIM IS MADE TO THE EXCLUSIVE RIGHT TO USE "PIANO", APART FROM THE MARK AS SHOWN.

FOR EDUCATIONAL SERVICES, NAMELY, CONDUCTING CLASSES AND PRIVATE LESSONS IN THE FIELD OF MUSIC AND DISTRIBUTION OF COURSE MATERIAL IN CONNECTION THEREWITH; EDUCATIONAL SERVICES, NAMELY, DEVELOPING CURRICULUM FOR OTHERS IN THE FIELD OF MUSIC (U.S. CLS. 100, 101 AND 107).

FIRST USE 6-1-2001; IN COMMERCE 6-1-2001.
CURTIS FRENCH, EXAMINING ATTORNEY

CLASS 41—(Continued).

SN 77-154,722. GUTSTV, AMITYVILLE, NY. FILED 4-12-2007.

**Gum Under The Shoe
Television**

THE MARK CONSISTS OF STANDARD CHARACTERS WITHOUT CLAIM TO ANY PARTICULAR FONT, STYLE, SIZE, OR COLOR.

NO CLAIM IS MADE TO THE EXCLUSIVE RIGHT TO USE "TELEVISION", APART FROM THE MARK AS SHOWN.

FOR ENTERTAINMENT SERVICES, NAMELY, PROVIDING AN INTERNET WEBSITE THAT FEATURES INFORMATION ON PARTIES AND ENTERTAINMENT EVENTS THAT OCCUR AROUND THE WORLD; ENTERTAINMENT SERVICES, NAMELY, PROVIDING AN INTERNET WEBSITE FEATURING WEBCAST INTERNET TELEVISION PROGRAMS GEARED TOWARDS MUSIC VIDEOS IN THE FIELD OF ENTERTAINMENT (U.S. CLS. 100, 101 AND 107).

FIRST USE 3-10-2005; IN COMMERCE 11-1-2005.
RONALD MCMORROW, EXAMINING ATTORNEY

SN 77-154,800. CRYSTAL SPRINGS DEVELOPMENT SERVICES, INC., MARYLAND HEIGHTS, MO. FILED 4-12-2007.



THE MARK CONSISTS OF THE STYLIZED LETTERS Q AND S WITH A GOLF BALL.

FOR GOLF CLUB SERVICES (U.S. CLS. 100, 101 AND 107).

FIRST USE 1-17-2006; IN COMMERCE 1-17-2006.
LINDA ESTRADA, EXAMINING ATTORNEY

SN 77-154,807. TWO LITTLE HANDS PRODUCTIONS, LLC, SALT LAKE CITY, UT. FILED 4-12-2007.

THE TREESCHOOLERS

THE MARK CONSISTS OF STANDARD CHARACTERS WITHOUT CLAIM TO ANY PARTICULAR FONT, STYLE, SIZE, OR COLOR.

FOR ENTERTAINMENT SERVICES IN THE NATURE OF A TELEVISION SERIES IN THE FIELD OF CHILDREN'S ENTERTAINMENT (U.S. CLS. 100, 101 AND 107).

MORENO, PAUL, EXAMINING ATTORNEY

CLASS 41—(Continued).

SN 77-154,838. MY TOWER PRODUCTIONS, LAS VEGAS, NV. FILED 4-12-2007.

My Tower Productions

THE MARK CONSISTS OF STANDARD CHARACTERS WITHOUT CLAIM TO ANY PARTICULAR FONT, STYLE, SIZE, OR COLOR.

NO CLAIM IS MADE TO THE EXCLUSIVE RIGHT TO USE "PRODUCTIONS", APART FROM THE MARK AS SHOWN.

FOR MOTION PICTURE FILM PRODUCTION; FILM EDITING (U.S. CLS. 100, 101 AND 107).

BRIAN PINO, EXAMINING ATTORNEY

CLASS 41—(Continued).

SN 77-155,859. TANASKOVIC, SANDRA, BRONX, NY. FILED 4-13-2007.

THE LESBIAN MAFIA

THE MARK CONSISTS OF STANDARD CHARACTERS WITHOUT CLAIM TO ANY PARTICULAR FONT, STYLE, SIZE, OR COLOR.

NO CLAIM IS MADE TO THE EXCLUSIVE RIGHT TO USE "LESBIAN", APART FROM THE MARK AS SHOWN.

FOR ENTERTAINMENT SERVICES, NAMELY, PROVIDING A WEBSITE FEATURING, PHOTOGRAPHIC, AUDIO, VIDEO AND PROSE PRESENTATIONS FEATURING WOMEN (U.S. CLS. 100, 101 AND 107).

FIRST USE 2-6-2007; IN COMMERCE 2-6-2007.

ZACHARY BELLO, EXAMINING ATTORNEY

SN 77-155,358. GRADE RESULTS, INC., CARROLLTON, TX. FILED 4-12-2007.

GRADE RESULTS

THE MARK CONSISTS OF STANDARD CHARACTERS WITHOUT CLAIM TO ANY PARTICULAR FONT, STYLE, SIZE, OR COLOR.

FOR EDUCATIONAL SERVICES, NAMELY, ONLINE TUTORING IN THE FIELDS OF MATH, READING, LANGUAGE ARTS, SCIENCE, FOREIGN LANGUAGES, ENGLISH AS A SECOND LANGUAGE "ESL", WRITING AND EXAM AND STANDARDIZED TEST PREPARATION (U.S. CLS. 100, 101 AND 107).

FIRST USE 4-30-2006; IN COMMERCE 4-30-2006.

KATHERINE CONNOLLY, EXAMINING ATTORNEY

SN 77-156,216. SANDLER SYSTEMS, INC., STEVENSON, MD. FILED 4-13-2007.

180° From Traditional Sales Training

THE MARK CONSISTS OF STANDARD CHARACTERS WITHOUT CLAIM TO ANY PARTICULAR FONT, STYLE, SIZE, OR COLOR.

OWNER OF U.S. REG. NOS. 2,663,420 AND 2,943,833. FOR EDUCATIONAL SERVICES, NAMELY, CONDUCTING TRAINING THROUGH SEMINARS, MEETINGS, WORKSHOPS AND ON-LINE PRESENTATIONS IN THE FIELD OF SALES OR SALES MANAGEMENT AND DISTRIBUTION OF COURSE MATERIAL IN CONNECTION THEREWITH (U.S. CLS. 100, 101 AND 107).

FIRST USE 1-25-2002; IN COMMERCE 1-25-2002.

KYLE PEETE, EXAMINING ATTORNEY

SN 77-155,678. BURNS, DAVID, LONG BEACH, CA. FILED 4-12-2007.

SLIGO RAGS

THE MARK CONSISTS OF STANDARD CHARACTERS WITHOUT CLAIM TO ANY PARTICULAR FONT, STYLE, SIZE, OR COLOR.

FOR ENTERTAINMENT, NAMELY, PRODUCTION OF LIVE PERFORMANCES BY A MUSICAL BAND, PRODUCTION OF SOUND AND MUSIC VIDEO RECORDINGS, AUDIO RECORDING AND PRODUCTION (U.S. CLS. 100, 101 AND 107).

CHRISTINE COOPER, EXAMINING ATTORNEY

SN 77-156,261. RUBINO, JOSEPH M., SAINT AUGUSTINE, FL. FILED 4-13-2007.

Taxicab 101

THE MARK CONSISTS OF STANDARD CHARACTERS WITHOUT CLAIM TO ANY PARTICULAR FONT, STYLE, SIZE, OR COLOR.

NO CLAIM IS MADE TO THE EXCLUSIVE RIGHT TO USE "TAXICAB", APART FROM THE MARK AS SHOWN.

FOR BUSINESS TRAINING; TRAINING SERVICES IN THE FIELD OF THE TAXICAB INDUSTRY (U.S. CLS. 100, 101 AND 107).

KELLY MCCOY, EXAMINING ATTORNEY

CLASS 41—(Continued).

SN 77-156,478. 183 RIO RESTAURANT CORP. LLC, DBA SMALLS JAZZ CLUB, NEW YORK, NY. FILED 4-13-2007.

smalls

THE MARK CONSISTS OF STANDARD CHARACTERS WITHOUT CLAIM TO ANY PARTICULAR FONT, STYLE, SIZE, OR COLOR.

FOR ENTERTAINMENT SERVICES, NAMELY, PRESENTING LIVE MUSIC PERFORMANCES BY INDIVIDUALS AND GROUPS, PROVIDING FACILITIES FOR LIVE MUSICAL PERFORMANCES; CABARET AND NIGHT CLUB (U.S. CLS. 100, 101 AND 107).

FIRST USE 0-0-1994; IN COMMERCE 0-0-1994.
KAREN K. BUSH, EXAMINING ATTORNEY

SN 77-156,493. BARTON-MANNI PARTNERS, NEW HOPE, PA. FILED 4-13-2007.

SECOND SUNRISE

THE MARK CONSISTS OF STANDARD CHARACTERS WITHOUT CLAIM TO ANY PARTICULAR FONT, STYLE, SIZE, OR COLOR.

FOR CAREER COUNSELING (U.S. CLS. 100, 101 AND 107).

INGA ERVIN, EXAMINING ATTORNEY

SN 77-156,499. SILVER STATE CLASSIC CHALLENGE, INC., ELY, NV. FILED 4-13-2007.

SILVER STATE CLASSIC CHALLENGE

THE MARK CONSISTS OF STANDARD CHARACTERS WITHOUT CLAIM TO ANY PARTICULAR FONT, STYLE, SIZE, OR COLOR.

OWNER OF U.S. REG. NO. 2,456,754.

SEC. 2(F).

FOR ARRANGING AND CONDUCTING OPEN ROAD AUTOMOTIVE RACING EVENTS (U.S. CLS. 100, 101 AND 107).

FIRST USE 9-1-1988; IN COMMERCE 9-1-1988.

KATHERINE E. HALMEN, EXAMINING ATTORNEY

CLASS 41—(Continued).

SN 77-156,600. THE AMERICAN ACADEMY OF DRAMATIC ARTS, NEW YORK, NY. FILED 4-13-2007.

THE AMERICAN ACADEMY OF DRAMATIC ARTS

THE MARK CONSISTS OF STANDARD CHARACTERS WITHOUT CLAIM TO ANY PARTICULAR FONT, STYLE, SIZE, OR COLOR.

NO CLAIM IS MADE TO THE EXCLUSIVE RIGHT TO USE "ACADEMY OF DRAMATIC ARTS", APART FROM THE MARK AS SHOWN.

SEC. 2(F).

FOR PROVIDING COURSES OF INSTRUCTION AND CONDUCTING CLASSES, SEMINARS AND WORKSHOPS IN THE FIELD OF ACTING (U.S. CLS. 100, 101 AND 107).

FIRST USE 0-0-1900; IN COMMERCE 0-0-1900.

ALICE SUE CARRUTHERS, EXAMINING ATTORNEY

SN 77-156,697. WEBSTER, STEVEN ROBERT, SHAWNEE, KS. AND CUMMINS, DAVID THOMAS, KANSAS CITY, MO. FILED 4-13-2007.

blackvan

THE MARK CONSISTS OF STANDARD CHARACTERS WITHOUT CLAIM TO ANY PARTICULAR FONT, STYLE, SIZE, OR COLOR.

FOR ENTERTAINMENT IN THE NATURE OF VISUAL AND AUDIO PERFORMANCES, NAMELY, MUSICAL BAND, ROCK GROUP, GYMNASTIC, DANCE, AND BALLET PERFORMANCES (U.S. CLS. 100, 101 AND 107).

GENE MACIOL, EXAMINING ATTORNEY

SN 77-156,794. MUDIMBU, REGINALD M, HERNDON, VA. FILED 4-13-2007.



NO CLAIM IS MADE TO THE EXCLUSIVE RIGHT TO USE "TUNESNVIDS", APART FROM THE MARK AS SHOWN.

THE COLOR(S) RED, YELLOW, BLUE, BLACK AND GRAY IS/ARE CLAIMED AS A FEATURE OF THE MARK.
THE MARK CONSISTS OF A BLACK MUSIC SYMBOL

CLASS 41—(Continued).

APPEARING BEHIND THE WORD "TUNES," WITH A FILM REEL TO THE RIGHT WITH THE FRONT REEL APPEARING IN GRAY AND THE BACK REEL APPEARING IN BLUE; WITH BLACK FILM ON THE FILM REEL AND ROLLING OFF THE REEL; THE WORD TUNES IS IN RED OVER THE BLACK MUSIC SYMBOL ON THE LEFT, THE LETTER "N" IS IN YELLOW FOLLOWED BY THE WORD VIDS IN BLUE; THE PHRASE "THE WORLD IS WATCHING" IS IN BLACK AT THE BASE OF THE FILM REEL BELOW "TUNESVIDS."

FOR ARRANGING FOR TICKET RESERVATIONS FOR SHOWS AND OTHER ENTERTAINMENT EVENTS, NOT INCLUDING SPORTS OR SPORTS-RELATED EVENTS; BOOKING OF ENTERTAINMENT HALLS FOR MUSIC-RELATED AND THEATRICAL EVENTS AND VARIETY SHOWS; CONDUCTING ENTERTAINMENT EXHIBITIONS IN THE NATURE OF ONLINE PRESENTATIONS FOR ARTISTS AND PERFORMERS; ENTERTAINMENT SERVICES, NAMELY, PROVIDING A WEBSITE FEATURING, PHOTOGRAPHIC, AUDIO, VIDEO AND PROSE PRESENTATIONS FEATURING UNSIGNED PERFORMERS, ARTISTS AND BANDS; ENTERTAINMENT IN THE NATURE OF DANCE PERFORMANCES; ENTERTAINMENT IN THE NATURE OF FASHION SHOWS; ENTERTAINMENT IN THE NATURE OF LIVE PERFORMANCES BY MUSICIANS AND PERFORMANCE ARTISTS VIA ONLINE VIDEO STREAMS; ENTERTAINMENT IN THE NATURE OF THEATER PRODUCTIONS; ENTERTAINMENT IN THE NATURE OF VISUAL AND AUDIO PERFORMANCES BY MUSICIANS AND PERFORMANCE ARTISTS, AND MUSICAL, VARIETY, MUSIC ENTERTAINMENT NEWS AND COMEDY SHOWS; ENTERTAINMENT IN THE NATURE OF VISUAL AND AUDIO PERFORMANCES, NAMELY, MUSICAL BANDS, ROCK GROUPS, DANCE AND BALLET PERFORMANCES; ENTERTAINMENT IN THE NATURE OF MUSIC CONCERTS AND THEATER PERFORMANCES; ENTERTAINMENT, NAMELY, LIVE PERFORMANCES BY A MUSICAL BAND; ENTERTAINMENT SERVICES, NAMELY, LIVE, TELEVISED AND MOVIE APPEARANCES BY A PROFESSIONAL MUSIC OR THEATER ENTERTAINER; ENTERTAINMENT SERVICES, NAMELY, AN ONLINE ACTIVITY WHERE YOU CREATE YOUR OWN MUSIC VIDEOS; ENTERTAINMENT SERVICES, NAMELY, ARRANGING AND CONDUCTING OF COMPETITIONS FOR PERFORMANCE ARTISTS AND MUSIC PERFORMERS ONLINE; ENTERTAINMENT SERVICES, NAMELY, NON-DOWNLOADABLE RINGTONES, PRE-RECORDED MUSIC, MUSIC-RELATED VIDEO AND GRAPHICS PRESENTED TO MOBILE COMMUNICATIONS DEVICES VIA A GLOBAL COMPUTER NETWORK AND WIRELESS NETWORKS; ENTERTAINMENT SERVICES, NAMELY, PROVIDING A RADIO PROGRAM IN THE FIELD OF ENTERTAINMENT FOR FILM, THEATER AND MUSIC VIA A GLOBAL COMPUTER NETWORK; ENTERTAINMENT SERVICES, NAMELY, PROVIDING A TELEVISION PROGRAM IN THE FIELDS OF FICTION, DRAMA, HORROR, COMEDY, ACTION, ROMANCE AND DOCUMENTARIES, NOT INCLUDING SPORTS OR SPORTS-RELATED ENTERTAINMENT, VIA A GLOBAL COMPUTER NETWORK; ENTERTAINMENT SERVICES, NAMELY, PROVIDING A WEB SITE FEATURING MUSICAL PERFORMANCES, MUSICAL VIDEOS, AND MUSIC-RELATED FILM CLIPS, PHOTOGRAPHS, AND MULTIMEDIA MATERIALS; ENTERTAINMENT SERVICES, NAMELY, PROVIDING ON-LINE REVIEWS OF FILMS, BOOKS, MOVIES, VIDEOS, SONGS, AND MUSIC COMPOSITIONS; ENTERTAINMENT SERVICES, NAMELY, PROVIDING PRERECORDED MUSIC, INFORMATION IN THE FIELD OF MUSIC, AND COMMENTARY AND ARTICLES ABOUT MUSIC, ALL ONLINE VIA A GLOBAL COMPUTER NETWORK; ENTERTAINMENT, NAMELY, CONTINUING PRE-RECORDED AND LIVE PERFORMANCES OF MULTI-GENRE AUDIO AND VIDEO SHOWS IN THE FIELDS OF MUSIC, PERFORMING ARTS AND FILM BROADCAST OVER TELEVISION, SATELLITE, AUDIO, AND VIDEO MEDIA; ENTERTAINMENT, NAMELY, LIVE MUSIC CONCERTS; ENTERTAINMENT, NAMELY, LIVE PERFORMANCES BY MUSICAL BANDS; ENTERTAINMENT, NAMELY, LIVE PERFORMANCES BY ROCK GROUPS; MOBILE MEDIA AND ENTERTAINMENT SERVICES IN THE NATURE OF CONTENT PREPARATION IN THE FIELDS OF MUSIC VIDEOS, THEATER AND FILM; MOBILE MEDIA AND ENTERTAINMENT SERVICES IN THE NATURE OF CONTENT PREPARA-

CLASS 41—(Continued).

TION, POST-PRODUCTION, IN THE FIELDS OF MUSIC VIDEOS, THEATER AND FILM; MULTIMEDIA ENTERTAINMENT SERVICES IN THE NATURE OF RECORDING, PRODUCTION AND POST-PRODUCTION SERVICES IN THE FIELDS OF MUSIC, VIDEOS, AND FILMS; MULTIMEDIA ENTERTAINMENT SOFTWARE PRODUCTION SERVICES; PROVIDING A WEB SITE WHERE USERS CAN POST RATINGS, REVIEWS AND RECOMMENDATIONS ON MUSIC, FILM AND THEATER EVENTS AND ACTIVITIES IN THE FIELDS OF ENTERTAINMENT AND EDUCATION; RADIO ENTERTAINMENT PRODUCTION; RADIO ENTERTAINMENT SERVICES, NAMELY, RADIO PROGRAMS FEATURING PERFORMANCES BY A PERFORMANCE GROUP OR INDIVIDUAL ARTIST OR PERFORMER REGISTERED WITH THE WEB SITE (U.S. CLS. 100, 101 AND 107).
SHAILA SETTLES, EXAMINING ATTORNEY

SN 77-157,002. EYE-METRIX HOLDINGS, LLC, SAN ANTONIO, TX. FILED 4-15-2007.

See Your Way to Better Performance

THE MARK CONSISTS OF STANDARD CHARACTERS WITHOUT CLAIM TO ANY PARTICULAR FONT, STYLE, SIZE, OR COLOR.

FOR ATHLETIC PERFORMANCE ENHANCEMENT SERVICE, NAMELY, TRAINING SERVICES PROVIDED TO ATHLETES IN THE AREA OF VISUAL MOTOR LEARNING SKILLS TO IMPROVE THEIR EYE-HAND COORDINATION, REACTION SPEED, ANTICIPATORY RESPONSE AND VISUAL CONCENTRATION (U.S. CLS. 100, 101 AND 107).

FIRST USE 11-1-2003; IN COMMERCE 11-1-2003.
B. PARADEWELAI, EXAMINING ATTORNEY

SN 77-157,026. AIA HOUSTON, HOUSTON, TX. FILED 4-15-2007.



THE MARK CONSISTS OF THE LETTER G SURROUNDED BY ROUNDED LINES.

FOR EDUCATIONAL SERVICES, NAMELY, CONDUCTING CONFERENCES IN THE FIELD OF ENVIRONMENTALLY FRIENDLY BUILDING DESIGN AND STRATEGIES (U.S. CLS. 100, 101 AND 107).

FIRST USE 4-1-2005; IN COMMERCE 4-1-2005.
MARK T. MULLEN, EXAMINING ATTORNEY

CLASS 41—(Continued).

SN 77-157,124. ALL 4 KIDS, LLC, KINGWOOD, TX. FILED 4-15-2007.

Chefs 2 Be

THE MARK CONSISTS OF STANDARD CHARACTERS WITHOUT CLAIM TO ANY PARTICULAR FONT, STYLE, SIZE, OR COLOR.

FOR EDUCATIONAL SERVICES, NAMELY, CONDUCTING CLASSES IN THE FIELD OF COOKING AND DISTRIBUTION OF COURSE MATERIAL IN CONNECTION THEREWITH; EDUCATIONAL SERVICES, NAMELY, DEVELOPING, ARRANGING, AND CONDUCTING EDUCATIONAL CONFERENCES AND PROGRAMS AND PROVIDING COURSES OF INSTRUCTION IN THE FIELD OF COOKING; EDUCATIONAL SERVICES, NAMELY, CONDUCTING CLASSES IN THE FIELD OF COOKING; INSTRUCTION IN THE FIELD OF COOKING; PROVIDING A WEBSITE THAT FEATURES INFORMAL INSTRUCTION ON COOKING (U.S. CLS. 100, 101 AND 107).

TARAH HARDY, EXAMINING ATTORNEY

SN 77-157,197. FLOWHARD RECORDS, LLC, ARLINGTON, TN. FILED 4-16-2007.

FLOWHARD RECORDS

THE MARK CONSISTS OF STANDARD CHARACTERS WITHOUT CLAIM TO ANY PARTICULAR FONT, STYLE, SIZE, OR COLOR.

NO CLAIM IS MADE TO THE EXCLUSIVE RIGHT TO USE "RECORDS", APART FROM THE MARK AS SHOWN, FOR MUSIC PRODUCTION SERVICES; RECORDING STUDIOS (U.S. CLS. 100, 101 AND 107).

FIRST USE 1-1-2007; IN COMMERCE 1-1-2007.

RICHARD A. STRASER, EXAMINING ATTORNEY

SN 77-157,230. ARGUELLO, JOE, SEATAC, WA. AND ARGUELLO, MIKE, SEATAC, WA. FILED 4-16-2007.

NINTH GATE

THE MARK CONSISTS OF STANDARD CHARACTERS WITHOUT CLAIM TO ANY PARTICULAR FONT, STYLE, SIZE, OR COLOR.

FOR ENTERTAINMENT NAMELY, LIVE PERFORMANCES BY A MUSICAL BAND (U.S. CLS. 100, 101 AND 107).

FIRST USE 6-1-2003; IN COMMERCE 6-1-2003.

DORITT L. CARROLL, EXAMINING ATTORNEY

CLASS 41—(Continued).

SN 77-157,433. ALLEN & HALBERG PUBLISHING, INC., CUSTER, WA. FILED 4-16-2007.



THE MARK CONSISTS OF A CIRCLE WITH A GEAR AND A LARGE "G". A GUITAR CABLE WITH PLUG SURROUNDING THE WORKS "GUITARGEARHEADS.COM - GEAR UP YOUR SOUND".

FOR PROVIDING ONLINE PUBLICATIONS IN THE NATURE OF MAGAZINES IN THE FIELD OF GUITARS (U.S. CLS. 100, 101 AND 107).

FIRST USE 1-1-2005; IN COMMERCE 1-1-2005.

LINDA POWELL, EXAMINING ATTORNEY

SN 77-157,517. MARGARET REICHARDT, BROOKLYN, NY. AND KURT HOFFMAN, BROOKLYN, NY. FILED 4-16-2007.

LES CHAUDS LAPINS

THE MARK CONSISTS OF STANDARD CHARACTERS WITHOUT CLAIM TO ANY PARTICULAR FONT, STYLE, SIZE, OR COLOR.

THE FOREIGN WORDING IN THE MARK TRANSLATES INTO ENGLISH AS THE HOT RABBITS.

FOR ENTERTAINMENT, NAMELY, LIVE PERFORMANCES BY A MUSICAL BAND (U.S. CLS. 100, 101 AND 107).

FIRST USE 7-30-2005; IN COMMERCE 7-30-2005.

MICHAEL GAFFAR, EXAMINING ATTORNEY

SN 77-157,726. MONSTER PRODUCTIONS LLC, LITTLETON, CO. FILED 4-16-2007.

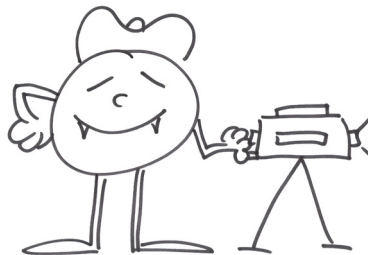

THE MARK CONSISTS OF SMILING FACE FIGURE STICK FIGURE WITH FANGS, WEARING HAT, AND STANDING AT FILM CAMERA.

FOR MOTION PICTURE FILM PRODUCTION (U.S. CLS. 100, 101 AND 107).

JAMES LOVELACE, EXAMINING ATTORNEY

CLASS 41—(Continued).

SN 77-157,826. SUPERNATURAL 23, LLC, ABINGDON, MD. FILED 4-16-2007.

BOOMERANG THEORY

THE MARK CONSISTS OF STANDARD CHARACTERS WITHOUT CLAIM TO ANY PARTICULAR FONT, STYLE, SIZE, OR COLOR.

FOR EDUCATIONAL AND ENTERTAINMENT SERVICES, NAMELY, PROVIDING MOTIVATIONAL AND EDUCATIONAL SPEAKERS WHO ADDRESS THE BENEFITS OF POSITIVE BEHAVIOR ON ONE'S LIFE; PROVIDING NEWSLETTERS IN THE FIELD OF PHYSICAL, MENTAL AND SPIRITUAL HEALTH AND WELLNESS; PRODUCTION AND DISTRIBUTION OF DOCUMENTARY MOVIES CONCERNING PHYSICAL, MENTAL AND SPIRITUAL HEALTH AND WELLNESS (U.S. CLS. 100, 101 AND 107).

FIRST USE 10-18-2006; IN COMMERCE 10-18-2006. IRA J. GOODSAD, EXAMINING ATTORNEY

CLASS 41—(Continued).

SN 77-158,012. HARRIS, JILL B, SAN FRANCISCO, CA. FILED 4-16-2007.

Informed Body

THE MARK CONSISTS OF STANDARD CHARACTERS WITHOUT CLAIM TO ANY PARTICULAR FONT, STYLE, SIZE, OR COLOR.

FOR PERSONAL TRAINING SERVICES, NAMELY, STRENGTH AND CONDITIONING TRAINING (U.S. CLS. 100, 101 AND 107).

HEATHER THOMPSON, EXAMINING ATTORNEY

SN 77-158,020. FRIEDMAN, SHERI, SHORT HILLS, NJ. FILED 4-16-2007.

COLORKITZ

THE MARK CONSISTS OF STANDARD CHARACTERS WITHOUT CLAIM TO ANY PARTICULAR FONT, STYLE, SIZE, OR COLOR.

FOR EDUCATION SERVICES, NAMELY, PROVIDING CLASSES AND WORKSHOPS IN THE FIELD OF COLOR AWARENESS (U.S. CLS. 100, 101 AND 107).

HEATHER SAPP, EXAMINING ATTORNEY

SN 77-157,898. AOL LLC, DULLES, VA. FILED 4-16-2007.



SN 77-158,085. WILLIE MOORE, ROCKFORD, IL. FILED 4-16-2007.

**"Just Threes"
The Area Wide 3 Point
Shoot-Out**

FOR ENTERTAINMENT SERVICES, NAMELY, PROVIDING PRERECORDED MUSIC, PRERECORDED MUSIC VIDEOS, INFORMATION IN THE FIELD OF MUSIC, AND COMMENTARY AND ARTICLES ABOUT MUSIC, ALL VIA COMPUTER NETWORKS; PROVIDING A WEB SITE FEATURING MUSICAL PERFORMANCES, MUSICAL VIDEOS, RELATED FILM CLIPS, PHOTOGRAPHS, AND OTHER MULTIMEDIA MATERIALS; BLOGS FEATURING MUSIC (U.S. CLS. 100, 101 AND 107).

FIRST USE 3-13-2007; IN COMMERCE 3-13-2007. PAMELA HIRSCHMAN, EXAMINING ATTORNEY

THE MARK CONSISTS OF STANDARD CHARACTERS WITHOUT CLAIM TO ANY PARTICULAR FONT, STYLE, SIZE, OR COLOR.

NO CLAIM IS MADE TO THE EXCLUSIVE RIGHT TO USE "3 POINT SHOOT-OUT", APART FROM THE MARK AS SHOWN.

FOR ENTERTAINMENT IN THE NATURE OF BASKETBALL GAMES (U.S. CLS. 100, 101 AND 107).

TRACY WHITTAKER-BROWN, EXAMINING ATTORNEY

CLASS 41—(Continued).

SN 77-158,091. SMITH, JOSEPH CORDELL, MABLETON, GA.
FILED 4-17-2007.

THE KINGDOM

THE MARK CONSISTS OF STANDARD CHARACTERS
WITHOUT CLAIM TO ANY PARTICULAR FONT, STYLE,
SIZE, OR COLOR.

SEC. 2(F).
FOR AMUSEMENT PARKS (U.S. CLS. 100, 101 AND
107).

ARETHA SOMERVILLE, EXAMINING ATTORNEY

SN 77-158,189. SUSAN MINTZ-BELLO, NEW YORK, NY.
FILED 4-17-2007.

I.A.M.I

THE MARK CONSISTS OF STANDARD CHARACTERS
WITHOUT CLAIM TO ANY PARTICULAR FONT, STYLE,
SIZE, OR COLOR.

FOR CONDUCTING WORKSHOPS AND SEMINARS
USING ART TECHNIQUES TO PROMOTE SELF
AWARENESS, EXPRESSIVE THERAPY AND SPIRITUAL
DEVELOPMENT (U.S. CLS. 100, 101 AND 107).

FRANK LATTUCA, EXAMINING ATTORNEY

SN 77-158,246. JAMES, SARA, BROOKLYN, NY. FILED 4-17-
2007.

Choose Your Destiny

THE MARK CONSISTS OF STANDARD CHARACTERS
WITHOUT CLAIM TO ANY PARTICULAR FONT, STYLE,
SIZE, OR COLOR.

FOR PRODUCTION OF DVDS, VIDEOTAPES AND
TELEVISION PROGRAMS FEATURING INTERACTIVE
NARRATIVES FOR A YOUNG ADULT AUDIENCE (U.S.
CLS. 100, 101 AND 107).

MARGERÝ A. TIERNEY, EXAMINING ATTORNEY

CLASS 41—(Continued).

SN 77-158,296. CONNOLLY-MAIN, KELLY A., RENO, NV.
FILED 4-17-2007.

Armed & Safe

THE MARK CONSISTS OF STANDARD CHARACTERS
WITHOUT CLAIM TO ANY PARTICULAR FONT, STYLE,
SIZE, OR COLOR.

FOR EDUCATIONAL SERVICES, NAMELY PROVID-
ING CLASSES IN THE FIELDS OF FIREARMS SAFETY
AND SELF-DEFENSE (U.S. CLS. 100, 101 AND 107).

FIRST USE 8-10-1997; IN COMMERCE 8-10-1997.
LINDA POWELL, EXAMINING ATTORNEY

SN 77-158,390. HUZAR, DIANE, CLEVELAND, OH. FILED 4-
17-2007.

TENSTARSOCCER

THE MARK CONSISTS OF STANDARD CHARACTERS
WITHOUT CLAIM TO ANY PARTICULAR FONT, STYLE,
SIZE, OR COLOR.

FOR SOCCER CAMPS AND SOCCER INSTRUCTION
(U.S. CLS. 100, 101 AND 107).

SETH A. RAPPAPORT, EXAMINING ATTORNEY

SN 77-158,395. WILLISTON, JEDIDIAH A., SHERMAN
OAKS, CA. FILED 4-17-2007.

eat me, drink me

THE MARK CONSISTS OF STANDARD CHARACTERS
WITHOUT CLAIM TO ANY PARTICULAR FONT, STYLE,
SIZE, OR COLOR.

FOR MAGAZINE PUBLISHING (U.S. CLS. 100, 101
AND 107).

KAREN BRACEY, EXAMINING ATTORNEY

CLASS 41—(Continued).

SN 77-158,410. CANCER FOUNDATION FOR LIFE, TYLER, TX. FILED 4-17-2007.

Cancer Foundation For Life

THE MARK CONSISTS OF STANDARD CHARACTERS WITHOUT CLAIM TO ANY PARTICULAR FONT, STYLE, SIZE, OR COLOR.

NO CLAIM IS MADE TO THE EXCLUSIVE RIGHT TO USE "CANCER FOUNDATION", APART FROM THE MARK AS SHOWN.

FOR PROVIDING INFORMATION IN THE FIELD OF EXERCISE TRAINING; PROVIDING FITNESS AND EXERCISE FACILITIES (U.S. CLS. 100, 101 AND 107).

FIRST USE 7-1-2001; IN COMMERCE 7-1-2001.
BERYL GARDNER, EXAMINING ATTORNEY

SN 77-158,516. HANCI, KEREM I, LOS ANGELES, CA. FILED 4-17-2007.



NO CLAIM IS MADE TO THE EXCLUSIVE RIGHT TO USE "PHOTOGRAPHY", APART FROM THE MARK AS SHOWN.

THE COLOR(S) ORANGE, PERSIAN RED, RED, WHITE, BLACK, AND LIGHT BROWN IS/ARE CLAIMED AS A FEATURE OF THE MARK.

THE MARK CONSISTS OF A WHITE RECTANGLE BEHIND A HORIZONTAL ROUNDED RECTANGLE WITH TOP TWO-THIRDS SAFETY ORANGE AND BOTTOM THIRD PERSIAN RED, CASTING A SHADOW ON THE WHITE RECTANGLE. THE STYLIZED WORD "SHOOT" WITH TWO BLACK VERTICAL LENS VIEW FINDER TARGETS FORMING THE LETTERS "OO" AND THE STYLIZED LETTERS S, H, AND T IN LIGHT BROWN, ON TOP OF THE SAFETY ORANGE PORTION OF THE ROUNDED RECTANGLE. THE BLACK STYLIZED WORD "THE" AND RED STYLIZED WORD "HEAD" UNDER THE WORD "SHOOT" AND ON TOP OF THE ROUNDED RECTANGLE. THE BLACK STYLIZED WORD "PHOTOGRAPHY" CENTERED UNDER THE ROUNDED RECTANGLE AND ON TOP OF THE WHITE RECTANGLE.

FOR PHOTOGRAPHY SERVICES (U.S. CLS. 100, 101 AND 107).

FIRST USE 8-15-2006; IN COMMERCE 1-10-2007.
SHANNON TWOHIG, EXAMINING ATTORNEY

CLASS 41—(Continued).

SN 77-158,781. TRANSFORMING, EDUCATING & EMPOWERING CHILDREN AND HUMANITY, CHICAGO, IL. FILED 4-17-2007.

TRANSFORMING, EDUCATING & EMPOWERING CHILDREN AND HUMANITY

THE MARK CONSISTS OF STANDARD CHARACTERS WITHOUT CLAIM TO ANY PARTICULAR FONT, STYLE, SIZE, OR COLOR.

FOR EDUCATIONAL SERVICES, NAMELY, CONDUCTING PROGRAMS IN THE FIELD OF ACADEMIC TUTORING, YOUTH EMPOWERMENT, DANCE, ACTING, MUSIC, PROFESSIONAL DEVELOPMENT, PARENTING SKILLS, EMPLOYMENT SKILLS, CONFLICT RESOLUTION, STRESS MANAGEMENT, TEAM BUILDING, CULTURAL DIVERSITY, COMPUTER TRAINING AND COMPUTER REPAIR TRAINING (U.S. CLS. 100, 101 AND 107).

FIRST USE 11-19-2002; IN COMMERCE 11-19-2002.
CHRISTINA SOBRAL, EXAMINING ATTORNEY

SN 77-158,824. MCCLATCHY MANAGEMENT SERVICES, INC., SACRAMENTO, CA. FILED 4-17-2007.

BUZZIES

THE MARK CONSISTS OF STANDARD CHARACTERS WITHOUT CLAIM TO ANY PARTICULAR FONT, STYLE, SIZE, OR COLOR.

FOR ENTERTAINMENT SERVICES, NAMELY, CONDUCTING AWARDS PROGRAMS HONORING INDIVIDUALS AND BUSINESSES THAT HAVE DEMONSTRATED EXCELLENCE IN THEIR FIELDS, IN THE QUALITY OF THEIR PRODUCTS AND SERVICES AND IN CUSTOMER SERVICE (U.S. CLS. 100, 101 AND 107).

FIRST USE 5-26-1999; IN COMMERCE 5-26-1999.
ERIN FALK, EXAMINING ATTORNEY

CLASS 41—(Continued).

SN 77-158,828. TRANSFORMING, EDUCATING & EMPOWERING CHILDREN AND HUMANITY, CHICAGO, IL. FILED 4-17-2007.



NO CLAIM IS MADE TO THE EXCLUSIVE RIGHT TO USE "TEACH", APART FROM THE MARK AS SHOWN.

THE COLOR(S) RED, BLACK, WHITE, GRAY IS/ARE CLAIMED AS A FEATURE OF THE MARK.

THE MARK CONSISTS OF THE WORDS "TRANSFORMING EDUCATING & EMPOWERING CHILDREN AND HUMANITY" IN WHITE WITHIN A REPRESENTATION OF TWO RED MEETING STAIRCASES OUTLINED IN BLACK AND THE WORD "TEECH" IN WHITE WITH GRAY OUTLINING WITH A BLACK HORIZONTAL BAR UNDERNEATH IT.

FOR EDUCATIONAL SERVICES NAMELY CONDUCTING PROGRAMS IN THE FIELD OF ACADEMIC TUTORING, YOUTH EMPOWERMENT, DANCE, ACTING, MUSIC, PROFESSIONAL DEVELOPMENT, PARENTING SKILLS, EMPLOYMENT SKILLS, CONFLICT RESOLUTION, STRESS MANAGEMENT, TEAM BUILDING, CULTURAL DIVERSITY, COMPUTER TRAINING AND COMPUTER REPAIR TRAINING (U.S. CLS. 100, 101 AND 107).

FIRST USE 11-19-2002; IN COMMERCE 11-19-2002.
CHRISTINA SOBRAL, EXAMINING ATTORNEY

SN 77-158,833. MICHAEL GALANES, HOLLYWOOD, FL. FILED 4-17-2007.

America's Perfect Teen

THE MARK CONSISTS OF STANDARD CHARACTERS WITHOUT CLAIM TO ANY PARTICULAR FONT, STYLE, SIZE, OR COLOR.

NO CLAIM IS MADE TO THE EXCLUSIVE RIGHT TO USE AMERICA'S AND TEEN, APART FROM THE MARK AS SHOWN.

FOR ENTERTAINMENT IN THE NATURE OF BEAUTY PAGEANTS (U.S. CLS. 100, 101 AND 107).

FIRST USE 4-12-2007; IN COMMERCE 4-17-2007.
RAY THOMAS, EXAMINING ATTORNEY

CLASS 41—(Continued).

SN 77-158,867. CHO, ANGIE E., LOS ANGELES, CA. FILED 4-17-2007.



NO CLAIM IS MADE TO THE EXCLUSIVE RIGHT TO USE "ART & DESIGN PORTFOLIO SCHOOL", APART FROM THE MARK AS SHOWN.

THE COLOR(S) LIGHT BLUE, DARK BLUE AND PURPLE IS/ARE CLAIMED AS A FEATURE OF THE MARK.

THE MARK CONSISTS OF THE COLOR LIGHT BLUE APPEARS IN THE LETTERS "VISI" AND "N" IN THE WORDING VISION. THE COLOR DARK BLUE APPEARS IN THE NUMBER "21" AND THE WORDING "ART & DESIGN PORTFOLIO SCHOOL." THE COLOR PURPLE APPEARS IN THE STYLIZED LETTER "O" IN THE WORD "VISION."

FOR EDUCATION SERVICES, NAMELY, PROVIDING TUTORIAL SESSIONS IN THE FIELD(S) OF ART AND DESIGN (U.S. CLS. 100, 101 AND 107).

FIRST USE 6-1-2003; IN COMMERCE 6-1-2003.
JENNIFER MARTIN, EXAMINING ATTORNEY

SN 77-158,878. SOURENA VASSEGI, AGOURA HILLS, CA. FILED 4-17-2007.

LOVE YOUR LIFE

THE MARK CONSISTS OF STANDARD CHARACTERS WITHOUT CLAIM TO ANY PARTICULAR FONT, STYLE, SIZE, OR COLOR.

FOR EDUCATIONAL AND ENTERTAINMENT SERVICES, NAMELY, PROVIDING MOTIVATIONAL AND EDUCATIONAL SPEAKERS; CONDUCTING WORKSHOPS AND SEMINARS IN PERSONAL AWARENESS (U.S. CLS. 100, 101 AND 107).

FIRST USE 1-1-2005; IN COMMERCE 2-1-2006.
JENNIFER DIXON, EXAMINING ATTORNEY

CLASS 41—(Continued).

SN 77-158,883. LEAPFROG STRATEGIES, INC., WHITE BEAR LAKE, MN. FILED 4-17-2007.

THE BIG SHEBANG

THE MARK CONSISTS OF STANDARD CHARACTERS WITHOUT CLAIM TO ANY PARTICULAR FONT, STYLE, SIZE, OR COLOR.

FOR ARRANGING PROFESSIONAL WORKSHOP AND TRAINING COURSES; BUSINESS TRAINING; EDUCATIONAL SERVICES, NAMELY, DEVELOPING, ARRANGING, AND CONDUCTING EDUCATIONAL CONFERENCES AND PROGRAMS AND PROVIDING COURSES OF INSTRUCTION IN THE FIELD OF SALES AND MARKETING; PROVIDING ON-LINE TRAINING COURSES, SEMINARS AND WORKSHOPS IN THE FIELD OF SALES AND MARKETING (U.S. CLS. 100, 101 AND 107).

PETER CHENG, EXAMINING ATTORNEY

CLASS 41—(Continued).

SN 77-158,950. STROUBE, WILLIAM, DALLAS, TX. FILED 4-17-2007.

**WORLD DIVERSITY CUP**

THE MARK CONSISTS OF A SOCCER BALL SURROUNDED BY STYLIZED CHILDREN HOLDING HANDS, WITH STYLIZED TEXT.

FOR ENTERTAINMENT IN THE NATURE OF SOCCER GAMES; ENTERTAINMENT IN THE NATURE OF COMPETITIONS IN THE FIELD OF SOCCER (U.S. CLS. 100, 101 AND 107).

JENNIFER MARTIN, EXAMINING ATTORNEY

SN 77-159,007. FITMINDER PUBLISHING, RANCHO CORDOVA, CA. FILED 4-17-2007.

THE MARK CONSISTS OF THE LETTERS FITMINDER WITH CAPITAL STYLIZED F AND CAPITAL STYLIZED M WITH ALL LETTERS CONNECTED WITH A COMMON BASELINE.

FOR MULTIMEDIA PUBLISHING OF BOOKS, MAGAZINES, JOURNALS, SOFTWARE, GAMES, MUSIC, AND ELECTRONIC PUBLICATIONS (U.S. CLS. 100, 101 AND 107).

KIMBERLY FRYE, EXAMINING ATTORNEY

SN 77-158,949. VENGEL CONSULTING, INC., DANVILLE, CA. AND LASH ASSOCIATES, INC., PLEASANT HILL, CA. FILED 4-17-2007.

THE INFLUENCE EDGE

THE MARK CONSISTS OF STANDARD CHARACTERS WITHOUT CLAIM TO ANY PARTICULAR FONT, STYLE, SIZE, OR COLOR.

NO CLAIM IS MADE TO THE EXCLUSIVE RIGHT TO USE "INFLUENCE", APART FROM THE MARK AS SHOWN.

FOR EDUCATION SERVICES, NAMELY, PROVIDING CLASSES, SEMINARS, CONFERENCES AND WORKSHOPS IN THE FIELDS OF INFLUENCE AND NEGOTIATION TRAINING FOR BUSINESS AND DISTRIBUTING COURSE MATERIALS IN CONNECTION THEREWITH (U.S. CLS. 100, 101 AND 107).

FIRST USE 1-15-1998; IN COMMERCE 3-5-1998.
JASON ROTH, EXAMINING ATTORNEY

SN 77-159,093. IMPRESSSIONS IN TIME PHOTOGRAPHY, INC., ORLANDO, DC. FILED 4-17-2007.

PhotograBee

THE MARK CONSISTS OF STANDARD CHARACTERS WITHOUT CLAIM TO ANY PARTICULAR FONT, STYLE, SIZE, OR COLOR.

FOR PHOTOGRAPHY SERVICES (U.S. CLS. 100, 101 AND 107).

FIRST USE 4-16-2007; IN COMMERCE 4-16-2007.
STEPHEN AQUILA, EXAMINING ATTORNEY

CLASS 41—(Continued).

SN 77-159,106. DESIREE DOUBROX, WESTLAKE VILLAGE, CA. FILED 4-17-2007.

AN EMPOWERED WOMAN

THE MARK CONSISTS OF STANDARD CHARACTERS WITHOUT CLAIM TO ANY PARTICULAR FONT, STYLE, SIZE, OR COLOR.

FOR EDUCATIONAL SERVICES, NAMELY PROVIDING CLASSES, RETREATS, SEMINARS, WORKSHOPS, DISCUSSION GROUPS, PROGRAMS, FORUMS, LECTURES, CONFERENCES, TELEVISION PROGRAMS, RADIO PROGRAMS, TUTORING, PERSONAL COACHING, MENTORING, AND SPEAKER EVENTS IN THE FIELDS OF PERSONAL EMPOWERMENT, PERSONAL GROWTH, MOTIVATION, SELF-HELP, SELF-AWARENESS, SELF-ESTEEM, LIFESTYLE, SELF-IMPROVEMENT, SELF-FULFILLMENT, AND PERSONAL AND PROFESSIONAL SUCCESS, AND CREATING AND DISTRIBUTING MATERIALS IN CONNECTION THEREWITH (U.S. CLS. 100, 101 AND 107).

FIRST USE 2-1-2005; IN COMMERCE 2-1-2005.
KAREN K. BUSH, EXAMINING ATTORNEY

SN 77-159,152. GEEWORKS, INC., NEW YORK, NY. FILED 4-18-2007.

GeeWorks

THE MARK CONSISTS OF STANDARD CHARACTERS WITHOUT CLAIM TO ANY PARTICULAR FONT, STYLE, SIZE, OR COLOR.

FOR TRAINING SERVICES IN THE FIELD OF COSMETICS RETAILING (U.S. CLS. 100, 101 AND 107).
JENNY PARK, EXAMINING ATTORNEY

SN 77-159,191. CONNECTICUT ATTORNEYS TITLE INSURANCE COMPANY, ROCKY HILL, CT. FILED 4-18-2007.



OWNER OF U.S. REG. NOS. 2,100,831, 3,131,152 AND OTHERS.

THE MARK CONSISTS OF A BLOCK C DESIGN WITH THE WORDS "CATIC ACCESS TO SUCCESS."

FOR EDUCATIONAL SERVICES, NAMELY, WORKSHOPS AND SEMINARS IN THE FIELD OF TITLE SEARCHING AND REAL PROPERTY LAW (U.S. CLS. 100, 101 AND 107).

CHRIS WELLS, EXAMINING ATTORNEY

CLASS 41—(Continued).

SN 77-159,235. TIMOTHY HAAHS & ASSOCIATES, INC., BLUE BELL, PA. FILED 4-18-2007.

THE EXTRA MILE

THE MARK CONSISTS OF STANDARD CHARACTERS WITHOUT CLAIM TO ANY PARTICULAR FONT, STYLE, SIZE, OR COLOR.

FOR PROVIDING A PERSONAL COACHING AND MENTORING PROGRAM TO BUILD INTER-OFFICE RELATIONSHIPS, PROVIDE ENCOURAGEMENT AND KNOWLEDGE TO OTHERS, AND STRENGTHEN LEADERSHIP WITHIN ORGANIZATIONS (U.S. CLS. 100, 101 AND 107).

FIRST USE 2-1-2007; IN COMMERCE 2-1-2007.
KYLE PEETE, EXAMINING ATTORNEY

SN 77-159,422. FOOS, JOHN, CHICAGO, IL. FILED 4-18-2007.

MISS FOOZIE

THE MARK CONSISTS OF STANDARD CHARACTERS WITHOUT CLAIM TO ANY PARTICULAR FONT, STYLE, SIZE, OR COLOR.

FOR ENTERTAINMENT IN THE NATURE OF LIVE PERFORMANCES BY A FEMALE IMPERSONATOR; ENTERTAINMENT IN THE NATURE OF A LIVE EMCEE OR HOSTING PERFORMANCE BY A FEMALE IMPERSONATOR; PROVIDING A WEB SITE FEATURING PERFORMANCES, BIOGRAPHICAL AND PERFORMANCE INFORMATION, AND RELATED PHOTOGRAPHS AND VIDEO CLIPS OF A FEMALE IMPERSONATOR (U.S. CLS. 100, 101 AND 107).

FIRST USE 4-6-1997; IN COMMERCE 4-6-1997.
IRA J. GOODSID, EXAMINING ATTORNEY

SN 77-159,452. ZGS COMMUNICATIONS, INC., ARLINGTON, VA. FILED 4-18-2007.

QUE NO VES SOMOS TRES!

THE MARK CONSISTS OF STANDARD CHARACTERS WITHOUT CLAIM TO ANY PARTICULAR FONT, STYLE, SIZE, OR COLOR.

THE FOREIGN WORDING IN THE MARK TRANSLATES INTO ENGLISH AS CAN'T YOU SEE, WE ARE THREE.

FOR ENTERTAINMENT IN THE NATURE OF ONGOING TELEVISION PROGRAMS IN THE FIELD OF VARIETY (U.S. CLS. 100, 101 AND 107).

RICHARD A. STRASER, EXAMINING ATTORNEY

CLASS 41—(Continued).

SN 77-159,473. KIDBITZ, INC., WEST CHESTER, PA. FILED 4-18-2007.

KIDBITZ

THE MARK CONSISTS OF STANDARD CHARACTERS WITHOUT CLAIM TO ANY PARTICULAR FONT, STYLE, SIZE, OR COLOR.

FOR SUMMER COMPUTER CAMPS, AND EDUCATION SERVICES, NAMELY, PROVIDING WORKSHOPS IN THE FIELD OF DIGITAL ANIMATION AND VIDEO GAME CREATION (U.S. CLS. 100, 101 AND 107).

FIRST USE 1-0-2006; IN COMMERCE 1-0-2006.
JENNIFER MARTIN, EXAMINING ATTORNEY

SN 77-159,497. GREAT SEATS CO., INC., INDIANAPOLIS, IN. FILED 4-18-2007.

RACEDAY

THE MARK CONSISTS OF STANDARD CHARACTERS WITHOUT CLAIM TO ANY PARTICULAR FONT, STYLE, SIZE, OR COLOR.

FOR TICKET AGENCY SERVICES, NAMELY, THE BROKERING, PURCHASE AND SALE OF TICKETS TO ENTERTAINMENT AND SPORTING EVENTS (U.S. CLS. 100, 101 AND 107).

FIRST USE 2-19-2002; IN COMMERCE 2-19-2002.
JOHN WILKE, EXAMINING ATTORNEY

SN 77-159,596. GREAT SEATS CO., INC., INDIANAPOLIS, IN. FILED 4-18-2007.

RACEDAYTICKETS

THE MARK CONSISTS OF STANDARD CHARACTERS WITHOUT CLAIM TO ANY PARTICULAR FONT, STYLE, SIZE, OR COLOR.

FOR TICKET AGENCY SERVICES, NAMELY, THE BROKERING, PURCHASE AND SALE OF TICKETS TO ENTERTAINMENT AND SPORTING EVENTS (U.S. CLS. 100, 101 AND 107).

FIRST USE 2-19-2002; IN COMMERCE 2-19-2002.
JOHN WILKE, EXAMINING ATTORNEY

CLASS 41—(Continued).

SN 77-159,835. BRODART CO., WILLIAMSPORT, PA. FILED 4-18-2007.

HOT OFF THE PRESS

THE MARK CONSISTS OF STANDARD CHARACTERS WITHOUT CLAIM TO ANY PARTICULAR FONT, STYLE, SIZE, OR COLOR.

FOR LIBRARIES (U.S. CLS. 100, 101 AND 107).
FIRST USE 7-0-2006; IN COMMERCE 7-0-2006.
MICHAEL LEWIS, EXAMINING ATTORNEY

SN 77-159,913. ECHELON RESORTS CORPORATION, LAS VEGAS, NV. FILED 4-18-2007.

TAKE ME HIGHER

THE MARK CONSISTS OF STANDARD CHARACTERS WITHOUT CLAIM TO ANY PARTICULAR FONT, STYLE, SIZE, OR COLOR.

FOR CASINOS; CONDUCTING AND PROVIDING FACILITIES FOR SPECIAL EVENTS FEATURING CASINO AND GAMING CONTESTS AND TOURNAMENTS; EDUCATIONAL AND ENTERTAINMENT SERVICES, NAMELY, PROVIDING MOTIVATIONAL AND EDUCATIONAL SPEAKERS; ENTERTAINMENT IN THE NATURE OF LIVE MUSIC, SINGING, DANCING, ACTORS, ACROBATS, LIVE BANDS, BOXING MATCHES, MAGICIANS, COMEDIANS, CONCERTS AND PANTOMIMES (U.S. CLS. 100, 101 AND 107).

KATHLEEN M. VANSTON, EXAMINING ATTORNEY

SN 77-160,039. ECHELON RESORTS CORPORATION, LAS VEGAS, NV. FILED 4-18-2007.

**EXPLORE. EMBRACE.
ELEVATE.**

THE MARK CONSISTS OF STANDARD CHARACTERS WITHOUT CLAIM TO ANY PARTICULAR FONT, STYLE, SIZE, OR COLOR.

FOR CASINOS; PROVIDING CASINO FACILITIES; PROVIDING FACILITIES FOR EDUCATIONAL CONVENTIONS; ENTERTAINMENT IN THE NATURE OF LIVE MUSIC, SINGING, DANCING, ACTORS, ACROBATS, LIVE BANDS, BOXING MATCHES, MAGICIANS, COMEDIANS, CONCERTS AND PANTOMIMES (U.S. CLS. 100, 101 AND 107).

KATHLEEN M. VANSTON, EXAMINING ATTORNEY

CLASS 41—(Continued).

SN 77-160,053. REYNOLDS, GIL, NEWBERG, OR. FILED 4-18-2007.

HOT GLASS HORIZONS

THE MARK CONSISTS OF STANDARD CHARACTERS WITHOUT CLAIM TO ANY PARTICULAR FONT, STYLE, SIZE, OR COLOR.

NO CLAIM IS MADE TO THE EXCLUSIVE RIGHT TO USE "HOT GLASS", APART FROM THE MARK AS SHOWN.

FOR ARRANGING AND CONDUCTING EDUCATIONAL CONFERENCES; EDUCATIONAL SERVICES, NAMELY, CONDUCTING CONFERENCES, WORKSHOPS AND SEMINARS IN THE FIELD OF GLASS ART, AND DISTRIBUTING COURSE MATERIALS IN CONNECTION THEREWITH (U.S. CLS. 100, 101 AND 107).

FIRST USE 1-1-1993; IN COMMERCE 1-1-1993.
SARA THOMAS, EXAMINING ATTORNEY

CLASS 41—(Continued).

SN 77-160,163. MARCIO SOUZA, TUSTIN, CA. FILED 4-18-2007.



SN 77-160,103. BASKETBALL TRAVELERS, INC., EDMONDS, WA. FILED 4-18-2007.

PARADISE JAM

THE MARK CONSISTS OF STANDARD CHARACTERS WITHOUT CLAIM TO ANY PARTICULAR FONT, STYLE, SIZE, OR COLOR.

FOR ENTERTAINMENT IN THE NATURE OF COLLEGE BASKETBALL TOURNAMENTS (U.S. CLS. 100, 101 AND 107).

FIRST USE 2-0-2000; IN COMMERCE 2-0-2000.
CHRISTINE COOPER, EXAMINING ATTORNEY

THE COLOR(S) RED AND WHITE IS/ARE CLAIMED AS A FEATURE OF THE MARK.

THE MARK CONSISTS OF A RED CIRCLE, WHICH CONTAINS (I) A WHITE LINE WITHIN ITS PERIMETER AND (II) THE WORDS G BARRA IN WHITE.

FOR EDUCATIONAL SERVICES IN THE NATURE OF BRAZILIAN JIU JITSU SCHOOLS; MARTIAL ARTS INSTRUCTION; AND OPERATION OF MARTIAL ARTS SCHOOLS (U.S. CLS. 100, 101 AND 107).

FIRST USE 4-0-2007; IN COMMERCE 4-0-2007.
MICHAEL KAZAZIAN, EXAMINING ATTORNEY

SN 77-160,160. BRODART CO., WILLIAMSPORT, PA. FILED 4-18-2007.



THE MARK CONSISTS OF "FLYING" BOOKS OVER THE WORDS HOT OFF THE PRESS.

FOR LIBRARIES (U.S. CLS. 100, 101 AND 107).
FIRST USE 7-0-2006; IN COMMERCE 7-0-2006.
MICHAEL LEWIS, EXAMINING ATTORNEY

SN 77-160,188. ANGLING FOR ANGELS, LLC, GULF BREEZE, FL. FILED 4-18-2007.

Fish For A Wish

THE MARK CONSISTS OF STANDARD CHARACTERS WITHOUT CLAIM TO ANY PARTICULAR FONT, STYLE, SIZE, OR COLOR.

FOR ENTERTAINMENT IN THE NATURE OF FISHING TOURNAMENTS (U.S. CLS. 100, 101 AND 107).

REBECCA SMITH, EXAMINING ATTORNEY

CLASS 41—(Continued).

SN 77-160,229. DON DIVA ENTERTAINMENT LLC, WEST PARK, FL. FILED 4-18-2007.



THE MARK CONSISTS OF THE STYLIZED TERM DD CONTAINED WITHIN A CIRCULAR DESIGN, WITH THE FIRST LETTER D INVERTED, AND FORMING THE IMAGE OF A CROWN.

FOR PARTY PLANNING; PARTY PLANNING CONSULTATION; SPECIAL EVENT PLANNING; SPECIAL EVENT PLANNING CONSULTATION; ENTERTAINMENT SERVICES, NAMELY, CONDUCTING PARTIES (U.S. CLS. 100, 101 AND 107).

FIRST USE 3-0-2007; IN COMMERCE 3-0-2007.
REBECCA GILBERT, EXAMINING ATTORNEY

SN 77-160,235. SPECTOR, HOWARD MARTIN, LOS ANGELES, CA. FILED 4-19-2007.

renewableYOU

THE MARK CONSISTS OF STANDARD CHARACTERS WITHOUT CLAIM TO ANY PARTICULAR FONT, STYLE, SIZE, OR COLOR.

FOR MULTIMEDIA PUBLISHING OF BOOKS, MAGAZINES, JOURNALS, SOFTWARE, GAMES, MUSIC, AND ELECTRONIC PUBLICATIONS; NEWS AGENCIES, NAMELY, GATHERING AND DISSEMINATION OF NEWS; ON-LINE PUBLICATION OF INFORMATION AND MULTIMEDIA PRESENTATIONS ON RENEWABLE LIVING NAMELY SELF-CARE, ENVIRONMENTAL EDUCATION, AND RELATIONSHIPS; PRODUCTION OF RADIO OR TELEVISION PROGRAMS; PRODUCTION OF SOUND AND MUSIC VIDEO RECORDINGS; PROGRAMMING ON A GLOBAL COMPUTER NETWORK; PROVIDING A WEB SITE WHERE USERS CAN POST RATINGS, REVIEWS AND RECOMMENDATIONS ON EVENTS AND ACTIVITIES IN THE FIELD OF ENTERTAINMENT AND EDUCATION; PROVIDING NEWSLETTERS IN THE FIELD OF RENEWABLE LIVING VIA E-MAIL; PUBLICATION OF BOOKS; PUBLICATION OF BOOKS, MAGAZINES, ALMANACS AND JOURNALS; PUBLICATION OF BOOKS, OF MAGAZINES, OF JOURNALS, OF NEWSPAPERS, OF PERIODICALS, OF CATALOGS, OF BROCHURES; PUBLICATION OF THE EDITORIAL CONTENT OF SITES ACCESSIBLE VIA A GLOBAL COMPUTER NETWORK; PUBLISHING OF WEB MAGAZINES; WORKSHOPS AND SEMINARS IN THE FIELD OF RENEWABLE LIVING (U.S. CLS. 100, 101 AND 107).

CHERYL CLAYTON, EXAMINING ATTORNEY

CLASS 41—(Continued).

SN 77-160,316. FAZZI ASSOCIATES, INC., NORTHAMPTON, MA. FILED 4-19-2007.

OASIS WALK

THE MARK CONSISTS OF STANDARD CHARACTERS WITHOUT CLAIM TO ANY PARTICULAR FONT, STYLE, SIZE, OR COLOR.

NO CLAIM IS MADE TO THE EXCLUSIVE RIGHT TO USE "OASIS", APART FROM THE MARK AS SHOWN.

FOR TRAINING OF MEDICAL AND HOME HEALTH CARE PERSONNEL IN THE ADMINISTRATION OF SERVICES AND THE USE OF ASSESSMENT TECHNIQUES AND TOOLS (U.S. CLS. 100, 101 AND 107).

FIRST USE 3-30-2006; IN COMMERCE 3-30-2006.
JILL C. ALT, EXAMINING ATTORNEY

SN 77-160,597. SUREFIRE MARKETING, INC., POTOMAC, MD. FILED 4-19-2007.

UNDERGROUND ONLINE SEMINAR

THE MARK CONSISTS OF STANDARD CHARACTERS WITHOUT CLAIM TO ANY PARTICULAR FONT, STYLE, SIZE, OR COLOR.

NO CLAIM IS MADE TO THE EXCLUSIVE RIGHT TO USE "ONLINE SEMINAR", APART FROM THE MARK AS SHOWN.

FOR EDUCATIONAL SERVICES, NAMELY, CONDUCTING ON-LINE PROGRAMS AND SEMINARS, TELEPHONE PROGRAMS AND SEMINARS, RECORDED AND LIVE PROGRAMS AND SEMINARS IN THE FIELD OF INTERNET MARKETING, AND PRINTED MATERIALS DISTRIBUTED THEREWITH (U.S. CLS. 100, 101 AND 107).

FIRST USE 1-30-2005; IN COMMERCE 1-30-2005.
RICHARD A. STRASER, EXAMINING ATTORNEY

SN 77-160,613. PAYNE, KIMBERLI, BALTIMORE, MD. FILED 4-19-2007.

WE ARE HIP HOP TOO!

THE MARK CONSISTS OF STANDARD CHARACTERS WITHOUT CLAIM TO ANY PARTICULAR FONT, STYLE, SIZE, OR COLOR.

FOR EDUCATION SERVICES, NAMELY, PROVIDING CLASSES, SEMINARS, WORKSHOPS IN THE FIELD OF ENTERTAINMENT; CONDUCTING ENTERTAINMENT EXHIBITIONS IN THE NATURE OF OPEN MIC, AND ARTIST SHOWCASES; SPECIAL EVENT PLANNING (U.S. CLS. 100, 101 AND 107).

BARBARA BROWN, EXAMINING ATTORNEY

CLASS 41—(Continued).

SN 77-160,616. SUREFIRE MARKETING, INC., POTOMAC, MD. FILED 4-19-2007.

UNDERGROUND SECRET SOCIETY

THE MARK CONSISTS OF STANDARD CHARACTERS WITHOUT CLAIM TO ANY PARTICULAR FONT, STYLE, SIZE, OR COLOR.

FOR EDUCATIONAL SERVICES, NAMELY, CONDUCTING ON-LINE PROGRAMS AND SEMINARS, TELEPHONE PROGRAMS AND SEMINARS, RECORDED AND LIVE PROGRAMS AND SEMINARS IN THE FIELD OF INTERNET MARKETING, AND PRINTED MATERIALS DISTRIBUTED THEREWITH (U.S. CLS. 100, 101 AND 107).

FIRST USE 1-30-2005; IN COMMERCE 1-30-2005.
RICHARD A. STRASER, EXAMINING ATTORNEY

SN 77-160,641. SUREFIRE MARKETING, INC., POTOMAC, MD. FILED 4-19-2007.

UNDERGROUND

THE MARK CONSISTS OF STANDARD CHARACTERS WITHOUT CLAIM TO ANY PARTICULAR FONT, STYLE, SIZE, OR COLOR.

FOR EDUCATIONAL SERVICES, NAMELY, CONDUCTING ON-LINE PROGRAMS AND SEMINARS, TELEPHONE PROGRAMS AND SEMINARS, RECORDED AND LIVE PROGRAMS AND SEMINARS IN THE FIELD OF INTERNET MARKETING, AND PRINTED MATERIALS DISTRIBUTED THEREWITH (U.S. CLS. 100, 101 AND 107).

FIRST USE 1-30-2005; IN COMMERCE 1-30-2005.
RICHARD A. STRASER, EXAMINING ATTORNEY

CLASS 41—(Continued).

SN 77-160,719. GLOSSY FINISH, INC., PONTE VEDRA BEACH, FL. FILED 4-19-2007.



NO CLAIM IS MADE TO THE EXCLUSIVE RIGHT TO USE "GLOSSY FINISH.COM", APART FROM THE MARK AS SHOWN.

THE COLOR(S) BLUE, RED, GRAY, WHITE AND PINK IS/ARE CLAIMED AS A FEATURE OF THE MARK.

THE MARK CONSISTS OF A RED CIRCLE SHOWING A PINK SLIVER, WITH A WHITE RING AND THEN A GRAY RING AND THEN A BLUE RING AROUND THE CIRCLE. THE WORDING "GLOSSY FINISH.COM" IS IN WHITE AND OUTLINED IN BLUE. THE WORD "GLOSSY" IS IN BIGGER LETTERS WITH THE WORDING "FINISH.COM" UNDERNEATH IT.

FOR PHOTOGRAPHY SERVICES (U.S. CLS. 100, 101 AND 107).

FIRST USE 9-1-2006; IN COMMERCE 9-1-2006.
FRED MANDIR, EXAMINING ATTORNEY

SN 77-160,959. SIX TO SUNDOWN LLC, EAST WILLISTON, NY. FILED 4-19-2007.

Six to Sundown

THE MARK CONSISTS OF STANDARD CHARACTERS WITHOUT CLAIM TO ANY PARTICULAR FONT, STYLE, SIZE, OR COLOR.

FOR PRESENTATION OF MUSICAL PERFORMANCE (U.S. CLS. 100, 101 AND 107).

TANYA AMOS, EXAMINING ATTORNEY

SN 77-160,989. TWENTIETH CENTURY FOX FILM CORPORATION, LOS ANGELES, CA. FILED 4-19-2007.

BACK TO YOU

THE MARK CONSISTS OF STANDARD CHARACTERS WITHOUT CLAIM TO ANY PARTICULAR FONT, STYLE, SIZE, OR COLOR.

FOR ENTERTAINMENT SERVICES IN THE NATURE OF A TELEVISION SERIES FEATURING COMEDY (U.S. CLS. 100, 101 AND 107).

ROSELLE HERRERA, EXAMINING ATTORNEY

CLASS 41—(Continued).

SN 77-161,079. SAN DIEGO STATE UNIVERSITY RESEARCH FOUNDATION, SAN DIEGO, CA. FILED 4-19-2007.

CLASS 41—(Continued).

SN 77-161,120. ANTAL, CHRISTOPHER JOHN, WAPPINGERS FALLS, NY. FILED 4-19-2007.

PEACE KING PATH

e-CHUG

THE MARK CONSISTS OF STANDARD CHARACTERS WITHOUT CLAIM TO ANY PARTICULAR FONT, STYLE, SIZE, OR COLOR.

FOR EDUCATION SERVICES, NAMELY, PROVIDING ONLINE WORKSHOPS IN THE FIELD OF ALCOHOL ABUSE AWARENESS AND PREVENTION (U.S. CLS. 100, 101 AND 107).

FIRST USE 1-1-2002; IN COMMERCE 1-1-2003.
JESSICA A. POWERS, EXAMINING ATTORNEY

THE MARK CONSISTS OF STANDARD CHARACTERS WITHOUT CLAIM TO ANY PARTICULAR FONT, STYLE, SIZE, OR COLOR.

NO CLAIM IS MADE TO THE EXCLUSIVE RIGHT TO USE "PEACE", APART FROM THE MARK AS SHOWN.

FOR EDUCATION SERVICES, NAMELY, PROVIDING SEMINARS AND TRAINING WORKSHOPS IN THE FIELD OF INTER-RELIGIOUS PEACEBUILDING, NON-VIOLENCE, AND SOCIAL JUSTICE; EDUCATIONAL SERVICES NAMELY CONDUCTING PROGRAMS IN THE FIELD OF INTER-RELIGIOUS PEACEBUILDING, NON-VIOLENCE, AND SOCIAL JUSTICE; EDUCATIONAL SERVICES, NAMELY, DEVELOPING, ARRANGING, AND CONDUCTING EDUCATIONAL CONFERENCES AND PROGRAMS AND PROVIDING COURSES OF INSTRUCTION IN THE FIELD OF INTER-RELIGIOUS PEACEBUILDING, NON-VIOLENCE, AND SOCIAL JUSTICE; EDUCATIONAL SERVICES, NAMELY, PROVIDING COURSES OF INSTRUCTION AT THE HIGH SCHOOL, UNDERGRADUATE AND GRADUATE LEVEL; EDUCATIONAL SERVICES, NAMELY, PROVIDING COURSES OF INSTRUCTION AT THE HIGH SCHOOL, UNDERGRADUATE AND GRADUATE LEVEL AND DISTRIBUTION OF COURSE MATERIAL IN CONNECTION THEREWITH (U.S. CLS. 100, 101 AND 107).

JAY BESCH, EXAMINING ATTORNEY

SN 77-161,106. VINOTI DESIGN, SANTA CLARA, CA. FILED 4-19-2007.

SN 77-161,200. MAIN, SUMMER J, MARINA DEL REY, CA. FILED 4-19-2007.

a smile. a teardrop. a
kiss. an instant.

Boogie Power!

THE MARK CONSISTS OF STANDARD CHARACTERS WITHOUT CLAIM TO ANY PARTICULAR FONT, STYLE, SIZE, OR COLOR.

FOR PHOTOGRAPHY SERVICES (U.S. CLS. 100, 101 AND 107).

DARRYL SPRUILL, EXAMINING ATTORNEY

THE MARK CONSISTS OF STANDARD CHARACTERS WITHOUT CLAIM TO ANY PARTICULAR FONT, STYLE, SIZE, OR COLOR.

FOR PRODUCTION OF DVDS, VIDEOTAPES AND TELEVISION PROGRAMS FEATURING EDUCATIONAL AND ENTERTAINING CONTENT FOR CHILDREN (U.S. CLS. 100, 101 AND 107).

FIRST USE 2-15-2007; IN COMMERCE 4-12-2007.
SUSAN LESLIE DUBOIS, EXAMINING ATTORNEY

CLASS 41—(Continued).

SN 77-161,498. CHSG PARTNERS, LLC, HOMERGLEN, IL.
FILED 4-20-2007.

PAY THE FAN

THE MARK CONSISTS OF STANDARD CHARACTERS
WITHOUT CLAIM TO ANY PARTICULAR FONT, STYLE,
SIZE, OR COLOR.

FOR ENTERTAINMENT SERVICES IN THE NATURE
OF ONLINE FANTASY GAMES FOR SPORTS (U.S. CLS.
100, 101 AND 107).

PAUL E. FAHRENKOPF, EXAMINING ATTORNEY

CLASS 41—(Continued).

SN 77-161,535. LUCKY STRIKE ENTERTAINMENT, LLC,
SHERMAN OAKS, CA. FILED 4-20-2007.

SMASH PIN

THE MARK CONSISTS OF STANDARD CHARACTERS
WITHOUT CLAIM TO ANY PARTICULAR FONT, STYLE,
SIZE, OR COLOR.

FOR BOWLING ALLEY SERVICES AND CONDUCT-
ING PARTIES RELATED THERETO (U.S. CLS. 100, 101
AND 107).

WARREN L. OLANDRIA, EXAMINING ATTORNEY

SN 77-161,517. CHSG PARTNERS, LLC, HOMERGLEN, IL.
FILED 4-20-2007.

GET PAID LIKE A DRIVER

THE MARK CONSISTS OF STANDARD CHARACTERS
WITHOUT CLAIM TO ANY PARTICULAR FONT, STYLE,
SIZE, OR COLOR.

FOR ENTERTAINMENT SERVICES IN THE NATURE
OF AN ONLINE FANTASY AUTO RACING GAME (U.S.
CLS. 100, 101 AND 107).

PAUL E. FAHRENKOPF, EXAMINING ATTORNEY

SN 77-161,536. LUCKY STRIKE ENTERTAINMENT, LLC,
SHERMAN OAKS, CA. FILED 4-20-2007.

PIN SMASH

THE MARK CONSISTS OF STANDARD CHARACTERS
WITHOUT CLAIM TO ANY PARTICULAR FONT, STYLE,
SIZE, OR COLOR.

FOR BOWLING ALLEY SERVICES AND CONDUCT-
ING PARTIES RELATED THERETO (U.S. CLS. 100, 101
AND 107).

WARREN L. OLANDRIA, EXAMINING ATTORNEY

SN 77-161,526. CHSG PARTNERS, LLC, HOMERGLEN, IL.
FILED 4-20-2007.

GET PAID LIKE A QUARTERBACK

THE MARK CONSISTS OF STANDARD CHARACTERS
WITHOUT CLAIM TO ANY PARTICULAR FONT, STYLE,
SIZE, OR COLOR.

FOR ENTERTAINMENT SERVICES IN THE NATURE
OF AN ONLINE FANTASY FOOTBALL GAME (U.S.
CLS. 100, 101 AND 107).

PAUL E. FAHRENKOPF, EXAMINING ATTORNEY

SN 77-161,541. LUCKY STRIKE ENTERTAINMENT, LLC,
SHERMAN OAKS, CA. FILED 4-20-2007.

MZ. PIN

THE MARK CONSISTS OF STANDARD CHARACTERS
WITHOUT CLAIM TO ANY PARTICULAR FONT, STYLE,
SIZE, OR COLOR.

FOR BOWLING ALLEY SERVICES AND CONDUCT-
ING PARTIES RELATED THERETO (U.S. CLS. 100, 101
AND 107).

WARREN L. OLANDRIA, EXAMINING ATTORNEY

CLASS 41—(Continued).

SN 77-161,697. LUCKY STRIKE ENTERTAINMENT, LLC, SHERMAN OAKS, CA. FILED 4-20-2007.

MS. SASSY PIN

THE MARK CONSISTS OF STANDARD CHARACTERS WITHOUT CLAIM TO ANY PARTICULAR FONT, STYLE, SIZE, OR COLOR.

FOR BOWLING ALLEY SERVICES AND CONDUCTING PARTIES RELATED THERETO (U.S. CLS. 100, 101 AND 107).

WARREN L. OLANDRIA, EXAMINING ATTORNEY

SN 77-161,900. RAY MARKS CO. LLC, NEW YORK, NY. FILED 4-20-2007.

YUM-O!

THE MARK CONSISTS OF STANDARD CHARACTERS WITHOUT CLAIM TO ANY PARTICULAR FONT, STYLE, SIZE, OR COLOR.

FOR EDUCATIONAL AND ENTERTAINMENT SERVICES, NAMELY EVENTS AND PROGRAMS FOR CHILDREN ABOUT FOOD PREPARATION, NUTRITION AND HEALTHY EATING HABITS ACCESSIBLE BY LIVE AUDIENCES AND THROUGH RADIO, TELEVISION, SATELLITE, AUDIO, VIDEO AND VIA GLOBAL AND LOCAL COMMUNICATIONS NETWORKS (U.S. CLS. 100, 101 AND 107).

PAUL CROWLEY, EXAMINING ATTORNEY

SN 77-161,933. WILLIAM J. COOK COMPANY, INC., MONTGOMERY, AL. FILED 4-20-2007.

SYNTAGMA

THE MARK CONSISTS OF STANDARD CHARACTERS WITHOUT CLAIM TO ANY PARTICULAR FONT, STYLE, SIZE, OR COLOR.

FOR EDUCATIONAL SERVICES, NAMELY, CONDUCTING PROGRAMS IN THE FIELD OF STRATEGIC THINKING, STRATEGIC PLANNING, AND IMPLEMENTATION OF ACTION PLANS FOR INDIVIDUAL AND GROUP DEVELOPMENT (U.S. CLS. 100, 101 AND 107).

ELLEN B. AWRICH, EXAMINING ATTORNEY

CLASS 41—(Continued).

SN 77-162,179. PAMELA K. BOLTER, PALM COAST, FL. FILED 4-20-2007.

Perfect Couple

THE MARK CONSISTS OF STANDARD CHARACTERS WITHOUT CLAIM TO ANY PARTICULAR FONT, STYLE, SIZE, OR COLOR.

FOR ENTERTAINMENT IN THE NATURE OF BEAUTY PAGEANTS (U.S. CLS. 100, 101 AND 107).

INGA ERVIN, EXAMINING ATTORNEY

SN 77-162,295. KOSA COMMUNICATIONS, LTD., MORRISVILLE, VT. FILED 4-20-2007.

KOSA

THE MARK CONSISTS OF STANDARD CHARACTERS WITHOUT CLAIM TO ANY PARTICULAR FONT, STYLE, SIZE, OR COLOR.

FOR ENTERTAINMENT IN THE NATURE OF MUSIC FESTIVALS AND LIVE MUSICAL PERFORMANCES; ENTERTAINMENT, NAMELY, PRODUCTION OF MUSIC FESTIVALS AND LIVE PERFORMANCES FEATURING MUSIC; ENTERTAINMENT, NAMELY, LIVE MUSIC CONCERTS; EDUCATIONAL SERVICES, NAMELY, PROVIDING CLASSES, SEMINARS AND WORKSHOPS IN THE FIELDS OF MUSIC AND MUSIC EDUCATION; EDUCATIONAL SERVICES, NAMELY, CONDUCTING INFORMAL ON-LINE PROGRAMS IN THE FIELDS OF MUSIC AND MUSIC EDUCATION, AND PRINTABLE MATERIALS DISTRIBUTED THEREWITH; EDUCATIONAL SERVICES, NAMELY, CONDUCTING CLASSES, SEMINARS AND WORKSHOPS IN THE FIELD OF MUSIC AND MUSIC EDUCATION AND DISTRIBUTION OF COURSE MATERIAL IN CONNECTION THEREWITH; EDUCATIONAL SERVICES, NAMELY, CONDUCTING DISTANCE LEARNING INSTRUCTION IN THE FIELD OF MUSIC (U.S. CLS. 100, 101 AND 107).

CHERYL CLAYTON, EXAMINING ATTORNEY

SN 77-162,391. GAGLIARDI, HELENE TONI, LOS ANGELES, CA. FILED 4-20-2007.

LIFEQUAKE

THE MARK CONSISTS OF STANDARD CHARACTERS WITHOUT CLAIM TO ANY PARTICULAR FONT, STYLE, SIZE, OR COLOR.

FOR CONDUCTING WORKSHOPS AND SEMINARS IN PERSONAL IMPROVEMENT (U.S. CLS. 100, 101 AND 107).

FIRST USE 3-19-1990; IN COMMERCE 3-19-1990. DAVID H. STINE, EXAMINING ATTORNEY

CLASS 41—(Continued).

SN 77-162,475. MP PUBLISHING, INC., SAN ANTONIO, TX. FILED 4-21-2007.

Spanish Friendly Business

THE MARK CONSISTS OF STANDARD CHARACTERS WITHOUT CLAIM TO ANY PARTICULAR FONT, STYLE, SIZE, OR COLOR.

FOR BOOK AND REVIEW PUBLISHING; DESKTOP PUBLISHING FOR OTHERS; ELECTRONIC PUBLISHING SERVICES, NAMELY, PUBLICATION OF TEXT AND GRAPHIC WORKS OF OTHERS ON DIRECTORIES FEATURING INFORMATION; MAGAZINE PUBLISHING; MULTIMEDIA PUBLISHING OF BOOKS, MAGAZINES, JOURNALS, SOFTWARE, GAMES, MUSIC, AND ELECTRONIC PUBLICATIONS; MUSIC PUBLISHING SERVICES; NEWSPAPER PUBLISHING; PUBLISHING AND ISSUING SCIENTIFIC PAPERS IN RELATION TO MEDICAL TECHNOLOGY; PUBLISHING OF BOOKS AND REVIEWS; PUBLISHING OF BOOKS, MAGAZINES; PUBLISHING OF ELECTRONIC PUBLICATIONS; PUBLISHING OF JOURNALS, BOOKS AND HANDBOOKS IN THE FIELD OF MEDICINE; PUBLISHING OF REVIEWS; PUBLISHING OF WEB MAGAZINES (U.S. CLS. 100, 101 AND 107).

FIRST USE 9-1-2004; IN COMMERCE 9-1-2004.
 NAAKWAMA ANKRAH, EXAMINING ATTORNEY

SN 77-162,783. VIACOM INTERNATIONAL INC., NEW YORK, NY. FILED 4-23-2007.

NEANDERTHALS

THE MARK CONSISTS OF STANDARD CHARACTERS WITHOUT CLAIM TO ANY PARTICULAR FONT, STYLE, SIZE, OR COLOR.

FOR ENTERTAINMENT SERVICES IN THE NATURE OF TELEVISION SERIES, FEATURING ANIMATION, COMEDY AND DRAMA; PROVIDING ONLINE INFORMATION IN THE FIELD OF ENTERTAINMENT CONCERNING TELEVISION PROGRAMS (U.S. CLS. 100, 101 AND 107).

ELISSA GARBER KON, EXAMINING ATTORNEY

CLASS 41—(Continued).

SN 77-162,795. VIACOM INTERNATIONAL INC., NEW YORK, NY. FILED 4-23-2007.

CLUB NATION

THE MARK CONSISTS OF STANDARD CHARACTERS WITHOUT CLAIM TO ANY PARTICULAR FONT, STYLE, SIZE, OR COLOR.

FOR ENTERTAINMENT SERVICES IN THE NATURE OF TELEVISION SERIES, FEATURING LIVE ACTION, COMEDY AND DRAMA; PROVIDING ONLINE INFORMATION IN THE FIELD OF ENTERTAINMENT CONCERNING TELEVISION PROGRAMS (U.S. CLS. 100, 101 AND 107).

ELISSA GARBER KON, EXAMINING ATTORNEY

SN 77-164,170. UNIVISION COMMUNICATIONS INC., LOS ANGELES, CA. FILED 4-24-2007.



OWNER OF U.S. REG. NO. 1,615,210.
 NO CLAIM IS MADE TO THE EXCLUSIVE RIGHT TO USE "LATINA", APART FROM THE MARK AS SHOWN.

THE MARK CONSISTS OF THE PHRASE NUESTRA BELLEZA LATINA IN SCRIPT WITH A DRAWING OF A CROWN ON TOP OF THE LETTERS.

THE FOREIGN WORDING IN THE MARK TRANSLATES INTO ENGLISH AS OUR LATIN BEAUTY.

FOR ENTERTAINMENT SERVICES, NAMELY, A RECURRING TELEVISION PROGRAM FEATURING BEAUTY AND TALENT CONTESTS (U.S. CLS. 100, 101 AND 107).

FIRST USE 1-28-2007; IN COMMERCE 1-28-2007.
 KAPIL BHANOT, EXAMINING ATTORNEY

SN 77-164,186. LAURA H. PUTNAM, SAN FRANCISCO, CA. FILED 4-24-2007.

MOTION INFUSION

THE MARK CONSISTS OF STANDARD CHARACTERS WITHOUT CLAIM TO ANY PARTICULAR FONT, STYLE, SIZE, OR COLOR.

FOR EDUCATIONAL SERVICES, NAMELY, CONDUCTING CLASSES, SEMINARS, CONFERENCES AND WORKSHOPS IN THE FIELDS OF WELLNESS, HOW PEOPLE LEARN AND LEADERSHIP TRAINING AND DISTRIBUTION OF COURSE MATERIAL IN CONNECTION THEREWITH (U.S. CLS. 100, 101 AND 107).

Laurie Mayes, Examining Attorney

CLASS 41—(Continued).

SN 77-164,252. SEAN T. SHALLIS, JERSEY CITY, NJ. FILED 4-24-2007.

**THE SECRETS TO TURNING
DREAMS INTO REALITY**

THE MARK CONSISTS OF STANDARD CHARACTERS WITHOUT CLAIM TO ANY PARTICULAR FONT, STYLE, SIZE, OR COLOR.

FOR EDUCATIONAL SERVICES; NAMELY, CONSULTING, COACHING AND CONDUCTING SEMINARS AND INSTRUCTIONAL CLASSES IN THE FIELDS OF PERSONAL DEVELOPMENT AND WEALTH BUILDING (U.S. CLS. 100, 101 AND 107).

FRED MANDIR, EXAMINING ATTORNEY

SN 77-164,444. TWENTIETH CENTURY FOX FILM CORPORATION, LOS ANGELES, CA. FILED 4-24-2007.

JOURNEYMAN

THE MARK CONSISTS OF STANDARD CHARACTERS WITHOUT CLAIM TO ANY PARTICULAR FONT, STYLE, SIZE, OR COLOR.

FOR ENTERTAINMENT SERVICES IN THE NATURE OF A TELEVISION SERIES FEATURING DRAMA (U.S. CLS. 100, 101 AND 107).

ROSELLE HERRERA, EXAMINING ATTORNEY

SN 77-164,619. AMERICAN CHRISTIAN COLLEGE, INC., MANITOU SPRINGS, CO. FILED 4-24-2007.

SUMMIT MINISTRIES

THE MARK CONSISTS OF STANDARD CHARACTERS WITHOUT CLAIM TO ANY PARTICULAR FONT, STYLE, SIZE, OR COLOR.

NO CLAIM IS MADE TO THE EXCLUSIVE RIGHT TO USE "MINISTRIES", APART FROM THE MARK AS SHOWN.

FOR EDUCATIONAL SERVICES, NAMELY, DEVELOPING CURRICULUM FOR OTHERS IN THE FIELD OF CHRISTIANITY, ELEMENTARY, MIDDLE SCHOOL, AND HIGH SCHOOL HOME SCHOOLING, SUNDAY SCHOOLS AND ADULT EDUCATION; AND EDUCATIONAL SERVICES, NAMELY, CONDUCTING CLASSES, SEMINARS, WORKSHOPS AND CONFERENCES IN THE FIELD OF CHRISTIAN EDUCATION AND CHRISTIANITY AND DISTRIBUTION OF COURSE MATERIALS IN CONNECTION THEREWITH (U.S. CLS. 100, 101 AND 107).

FIRST USE 6-30-1962; IN COMMERCE 6-30-1962.
DORITT L. CARROLL, EXAMINING ATTORNEY

CLASS 41—(Continued).

SN 77-165,390. DIVINE PHYSICS HOLISTIC LIFESTYLES & REGENERATION INSTITUTE, INC., CENTENNIAL, CO. FILED 4-25-2007.

**THE ART OF UNFOLDING THE
SPIRIT WITHIN**

THE MARK CONSISTS OF STANDARD CHARACTERS WITHOUT CLAIM TO ANY PARTICULAR FONT, STYLE, SIZE, OR COLOR.

FOR EDUCATIONAL SERVICES, NAMELY, PROVIDING CLASSES, SEMINARS AND WORKSHOPS IN THE FIELDS OF MEDICAL, SOCIAL, SPIRITUAL, POLITICAL, ENVIRONMENTAL, HEALTHCARE, AND CULTURAL ISSUES (U.S. CLS. 100, 101 AND 107).

MORENO, PAUL, EXAMINING ATTORNEY

SN 77-166,122. SHIPMAN & GOODWIN LLP, HARTFORD, CT. FILED 4-26-2007.



SHIPMAN & GOODWIN^{LLP}

OWNER OF U.S. REG. NOS. 2,536,828, 2,556,160 AND OTHERS.

NO CLAIM IS MADE TO THE EXCLUSIVE RIGHT TO USE "LLP", APART FROM THE MARK AS SHOWN.

THE MARK CONSISTS OF A DEPICTION OF SAILS OVER THE WORDS "SHIPMAN & GOODWIN LLP".

FOR EDUCATIONAL SERVICES, NAMELY, CONDUCTING SEMINARS, WORKSHOPS, CLASSES AND CONFERENCES IN THE FIELD OF LAW (U.S. CLS. 100, 101 AND 107).

DAYNA BROWNE, EXAMINING ATTORNEY

SN 77-166,279. AL WHITE PHOTOGRAPHY, GARNER, NC. FILED 4-26-2007.



NO CLAIM IS MADE TO THE EXCLUSIVE RIGHT TO USE "PHOTOGRAPHY", APART FROM THE MARK AS SHOWN.

THE LIKENESS IN THE MARK DOES NOT IDENTIFY A LIVING INDIVIDUAL.

THE MARK CONSISTS OF A SILHOUETTE OF A FEMALE FACE WITH THE WORDS AL WHITE PHOTOGRAPHY.

FOR PHOTOGRAPHY SERVICES (U.S. CLS. 100, 101 AND 107).

FIRST USE 11-1-1985; IN COMMERCE 11-1-1985.
JOHN WILKE, EXAMINING ATTORNEY

CLASS 41—(Continued).

SN 77-166,296. LUCKY STRIKE ENTERTAINMENT, LLC, SHERMAN OAKS, CA. FILED 4-26-2007.

GAMECOURT

THE MARK CONSISTS OF STANDARD CHARACTERS WITHOUT CLAIM TO ANY PARTICULAR FONT, STYLE, SIZE, OR COLOR.

FOR AMUSEMENT ARCADES (U.S. CLS. 100, 101 AND 107).

WARREN L. OLANDRIA, EXAMINING ATTORNEY

SN 77-166,371. AZTECA INTERNATIONAL CORPORATION, EL SEGUNDO, CA. FILED 4-26-2007.

SEXO SENTIDO

THE MARK CONSISTS OF STANDARD CHARACTERS WITHOUT CLAIM TO ANY PARTICULAR FONT, STYLE, SIZE, OR COLOR.

NO CLAIM IS MADE TO THE EXCLUSIVE RIGHT TO USE "SEXO", APART FROM THE MARK AS SHOWN.

THE FOREIGN WORDING IN THE MARK TRANSLATES INTO ENGLISH AS SEX SENSE.

FOR ENTERTAINMENT IN THE NATURE OF ONGOING TELEVISION PROGRAMS IN THE FIELD OF SEX (U.S. CLS. 100, 101 AND 107).

LEE-ANNE BERNS, EXAMINING ATTORNEY

SN 77-166,814. RUSTICO COOKING, NEW YORK, NY. FILED 4-26-2007.

Rustico
cooking

NO CLAIM IS MADE TO THE EXCLUSIVE RIGHT TO USE "COOKING", APART FROM THE MARK AS SHOWN.

THE ENGLISH TRANSLATION OF THE ITALIAN WORD "RUSTICO" IN THE MARK IS "RUSTIC."

FOR CONSULTING SERVICES IN THE FIELD OF CULINARY COMPETITIONS; EDUCATION SERVICES, NAMELY, PROVIDING HANDS ON CLASSES AND WORKSHOPS IN THE FIELDS OF COOKING AND GASTRONOMY; EDUCATIONAL DEMONSTRATIONS; ENTERTAINMENT SERVICES, NAMELY, WINE AND FOOD TASTINGS; GUIDED TOURS OF WINERIES, RESTAURANT KITCHENS, OLIVE OIL PRODUCERS (U.S. CLS. 100, 101 AND 107).

FIRST USE 1-1-2002; IN COMMERCE 1-1-2002.

MARY MUNSON, EXAMINING ATTORNEY

CLASS 41—(Continued).

SN 77-168,109. DA VINCI, S.A., SAN JOSE, COSTA RICA, FILED 4-27-2007.

BET WON

THE MARK CONSISTS OF STANDARD CHARACTERS WITHOUT CLAIM TO ANY PARTICULAR FONT, STYLE, SIZE, OR COLOR.

NO CLAIM IS MADE TO THE EXCLUSIVE RIGHT TO USE "BET", APART FROM THE MARK AS SHOWN.

FOR WAGERING SERVICES; CASINO SERVICES; SPORTS WAGERING SERVICES; ON-LINE POKER AND BINGO GAMES; GAMBLING SERVICES (U.S. CLS. 100, 101 AND 107).

JENNIFER HETU, EXAMINING ATTORNEY

SN 77-169,379. HAWK EYE HELICOPTER LLC, ANDOVER, MN. FILED 4-30-2007.

Hawk Eye Helicopter

THE MARK CONSISTS OF STANDARD CHARACTERS WITHOUT CLAIM TO ANY PARTICULAR FONT, STYLE, SIZE, OR COLOR.

NO CLAIM IS MADE TO THE EXCLUSIVE RIGHT TO USE "HELICOPTER", APART FROM THE MARK AS SHOWN.

FOR RECREATIONAL SERVICES IN THE NATURE OF HELICOPTER RIDES (U.S. CLS. 100, 101 AND 107).

FIRST USE 5-20-2006; IN COMMERCE 5-20-2006.

MARY MUNSON, EXAMINING ATTORNEY

SN 77-169,888. VIACOM INTERNATIONAL INC., NEW YORK, NY. FILED 5-1-2007.

NEWS DOGGS

THE MARK CONSISTS OF STANDARD CHARACTERS WITHOUT CLAIM TO ANY PARTICULAR FONT, STYLE, SIZE, OR COLOR.

FOR ENTERTAINMENT SERVICES IN THE NATURE OF TELEVISION SERIES, FEATURING LIVE ACTION, COMEDY AND DRAMA; PROVIDING ONLINE INFORMATION IN THE FIELD OF ENTERTAINMENT CONCERNING TELEVISION PROGRAMS (U.S. CLS. 100, 101 AND 107).

ELISSA GARBER KON, EXAMINING ATTORNEY

CLASS 41—(Continued).

SN 77-169,895. VIACOM INTERNATIONAL INC., NEW YORK, NY. FILED 5-1-2007.

NEWSDOGGS

THE MARK CONSISTS OF STANDARD CHARACTERS WITHOUT CLAIM TO ANY PARTICULAR FONT, STYLE, SIZE, OR COLOR.

FOR ENTERTAINMENT SERVICES IN THE NATURE OF TELEVISION SERIES, FEATURING LIVE ACTION, COMEDY AND DRAMA; PROVIDING ONLINE INFORMATION IN THE FIELD OF ENTERTAINMENT CONCERNING TELEVISION PROGRAMS (U.S. CLS. 100, 101 AND 107).

ELISSA GARBER KON, EXAMINING ATTORNEY

SN 77-171,222. GOFISH CORPORATION, SAN FRANCISCO, CA. FILED 5-2-2007.

Seduce A Celeb

THE MARK CONSISTS OF STANDARD CHARACTERS WITHOUT CLAIM TO ANY PARTICULAR FONT, STYLE, SIZE, OR COLOR.

FOR (BASED ON USE IN COMMERCE) ENTERTAINMENT SERVICES, NAMELY, PROVIDING A TELEVISION PROGRAM IN THE FIELD OF NEWS, ENTERTAINMENT AND EDUCATION VIA A GLOBAL COMPUTER NETWORK; PROGRAMMING ON A GLOBAL COMPUTER NETWORK; ENTERTAINMENT SERVICES NAMELY PROVIDING A WEBSITE FEATURING, PHOTOGRAPHIC, AUDIO, VIDEO AND PROSE PRESENTATIONS FEATURING LIVE-ACTION, COMEDY, DRAMA AND REALITY-BASED WEB SERIES; ENTERTAINMENT IN THE NATURE OF ON-GOING TELEVISION PROGRAMS IN THE FIELD OF NEWS, ENTERTAINMENT AND EDUCATION; ENTERTAINMENT IN THE NATURE OF LIVE-ACTION, COMEDY, DRAMA AND REALITY-BASED WEB SERIES; ENTERTAINMENT NAMELY, PRODUCTION OF LIVE-ACTION, COMEDY, DRAMA AND REALITY-BASED WEB SERIES; ENTERTAINMENT SERVICES, NAMELY, PROVIDING A WEB SITE FEATURING MUSICAL PERFORMANCES, MUSICAL VIDEOS, RELATED FILM CLIPS, PHOTOGRAPHS, AND OTHER MULTIMEDIA MATERIALS; ENTERTAINMENT, NAMELY A CONTINUING LIVE-ACTION, COMEDY, DRAMA AND REALITY-BASED SHOW BROADCAST OVER TELEVISION, SA-

CLASS 41—(Continued).

TELLITE, AUDIO, AND VIDEO MEDIA; ENTERTAINMENT IN THE NATURE OF VISUAL AND AUDIO PERFORMANCES, AND MUSICAL, VARIETY, NEWS AND COMEDY SHOWS; TELEVISION SHOW PRODUCTION; (BASED ON INTENT TO USE) ENTERTAINMENT IN THE NATURE OF ON-GOING TELEVISION PROGRAMS IN THE FIELD OF GENERAL NEWS INTEREST, ENTERTAINMENT AND EDUCATION INFORMATION; ENTERTAINMENT, NAMELY A CONTINUING LIVE-ACTION, COMEDY, DRAMA AND REALITY-BASED SHOW BROADCAST OVER TELEVISION, SATELLITE, AUDIO, AND VIDEO MEDIA; TELEVISION SHOW PRODUCTION; ENTERTAINMENT SERVICES IN THE NATURE OF AN ON-GOING REALITY BASED TELEVISION PROGRAM; PRODUCTION OF CABLE TELEVISION PROGRAMS; PRODUCTION OF RADIO OR TELEVISION PROGRAMS; TELEVISION PROGRAM SYNDICATION; MOTION PICTURE FILM PRODUCTION; PROVISION OF NON-DOWNLOADABLE FILMS AND TV PROGRAMMES VIA A VIDEO-ON-DEMAND SERVICE (U.S. CLS. 100, 101 AND 107).

FIRST USE 4-5-2007; IN COMMERCE 4-26-2007.
KYLE PEETE, EXAMINING ATTORNEY

SN 77-173,090. SUNSET PICTURES, LLC, HENDERSON, NV. FILED 5-4-2007.

SUNSET PICTURES

THE MARK CONSISTS OF STANDARD CHARACTERS WITHOUT CLAIM TO ANY PARTICULAR FONT, STYLE, SIZE, OR COLOR.

NO CLAIM IS MADE TO THE EXCLUSIVE RIGHT TO USE "PICTURES", APART FROM THE MARK AS SHOWN. FOR MOTION PICTURE FILM PRODUCTION; PRODUCTION AND DISTRIBUTION OF INDEPENDENT MOTION PICTURES (U.S. CLS. 100, 101 AND 107).

FIRST USE 6-1-2005; IN COMMERCE 6-1-2005.
CARYN GLASSER, EXAMINING ATTORNEY

CLASS 41—(Continued).

SN 77-174,308. NBA DEVELOPMENT LEAGUE, LLC, SE-CAUCUS, NJ. FILED 5-7-2007.



NO CLAIM IS MADE TO THE EXCLUSIVE RIGHT TO USE "TULSA", APART FROM THE MARK AS SHOWN.

THE MARK CONSISTS OF A SHIELD, A HIGHWAY, MOUNTAINS, AND A BASKETBALL WITH THE WORDS TULSA 66ERS STYLIZED.

FOR ENTERTAINMENT AND EDUCATIONAL SERVICES IN THE NATURE OF ONGOING TELEVISION AND RADIO PROGRAMS IN THE FIELD OF BASKETBALL AND RENDERING LIVE BASKETBALL GAMES AND BASKETBALL EXHIBITIONS; THE PRODUCTION AND DISTRIBUTION OF RADIO AND TELEVISION BROADCASTS OF BASKETBALL GAMES, BASKETBALL EVENTS AND PROGRAMS IN THE FIELD OF BASKETBALL; CONDUCTING AND ARRANGING BASKETBALL CLINICS AND CAMPS, COACHES CLINICS AND CAMPS, DANCE TEAM CLINICS AND CAMPS AND BASKETBALL EVENTS; ENTERTAINMENT SERVICES IN THE NATURE OF PERSONAL APPEARANCES BY A COSTUMED MASCOT OR DANCE TEAM AT BASKETBALL GAMES AND EXHIBITIONS, CLINICS, CAMPS, PROMOTIONS, AND OTHER BASKETBALL-RELATED EVENTS, SPECIAL EVENTS AND PARTIES; FAN CLUB SERVICES; ENTERTAINMENT SERVICES, NAMELY, PROVIDING A WEBSITE FEATURING THE FOLLOWING NON-DOWNLOADABLE CONTENT—TELEVISION HIGHLIGHTS, INTERACTIVE TELEVISION HIGHLIGHTS, VIDEO RECORDINGS, VIDEO STREAM RECORDINGS, INTERACTIVE VIDEO HIGHLIGHT SELECTIONS, RADIO PROGRAMS, RADIO HIGHLIGHTS, AND AUDIO RECORDINGS IN THE FIELD OF BASKETBALL, BASKETBALL NEWS IN THE NATURE OF INFORMATION, STATISTICS, AND TRIVIA ABOUT BASKETBALL, ON-LINE COMPUTER GAMES, VIDEO GAMES, INTERACTIVE VIDEO GAMES, ACTION SKILL GAMES, ARCADE GAMES, ADULTS' AND CHILDREN'S PARTY GAMES, BOARD GAMES, PUZZLES, AND TRIVIA GAMES; PROVIDING ON-LINE MAGAZINES, GUIDES, NEWSLETTERS, COLORING BOOKS, AND GAME SCHEDULES IN THE FIELD OF BASKETBALL OVER THE INTERNET; PROVIDING AN ONLINE COMPUTER DATABASE IN THE FIELD OF BASKETBALL (U.S. CLS. 100, 101 AND 107).

CARRIE GENOVESE, EXAMINING ATTORNEY

CLASS 41—(Continued).

SN 77-177,517. TEAM TYPE 1, INC., ATLANTA, GA. FILED 5-10-2007.

TEAM TYPE 1

THE MARK CONSISTS OF STANDARD CHARACTERS WITHOUT CLAIM TO ANY PARTICULAR FONT, STYLE, SIZE, OR COLOR.

NO CLAIM IS MADE TO THE EXCLUSIVE RIGHT TO USE "TYPE 1", APART FROM THE MARK AS SHOWN.

FOR ORGANIZING SPORTING EVENTS, NAMELY, BICYCLING EVENTS TO PROMOTE PUBLIC AWARENESS OF THE IMPORTANCE OF GOOD DIABETES CONTROL TO PREVENT DIABETES COMPLICATIONS (U.S. CLS. 100, 101 AND 107).

FIRST USE 1-31-2005; IN COMMERCE 1-31-2005.
EDWARD NELSON, EXAMINING ATTORNEY

SN 77-179,533. LEIB, JODI R., NEW YORK, NY. FILED 5-12-2007.

Talk It Out

THE MARK CONSISTS OF STANDARD CHARACTERS WITHOUT CLAIM TO ANY PARTICULAR FONT, STYLE, SIZE, OR COLOR.

FOR ENTERTAINMENT IN THE NATURE OF AN ONGOING SPECIAL VARIETY, NEWS, MUSIC OR COMEDY SHOW FEATURING CELEBRITY INTERVIEWS, DOCUMENTARY BIOGRAPHIES, LIVE PERFORMANCE, MUSIC VIDEOS, MOVIES, AUDIENCE INTERACTIVITY, AND WEBSITE SOCIAL NETWORKING BROADCAST OVER TELEVISION, SATELLITE, AUDIO, AND VIDEO MEDIA (U.S. CLS. 100, 101 AND 107).

FIRST USE 11-0-2001; IN COMMERCE 1-26-2002.
JOHN KELLY, EXAMINING ATTORNEY

SN 77-180,715. SPECTOR, HOWARD MARTIN, LOS ANGELES, CA. FILED 5-14-2007.

rYOU?

THE MARK CONSISTS OF STANDARD CHARACTERS WITHOUT CLAIM TO ANY PARTICULAR FONT, STYLE, SIZE, OR COLOR.

FOR ON-LINE PUBLICATION OF NEWS, REVIEWS, ARTICLES, AND VIDEOS, NAMELY, IN THE AREA OF RENEWABLE LIVING CONSISTING OF HEALTH, SELF-CARE, GREEN LIVING, AND TECHNOLOGY; MULTIMEDIA PUBLISHING OF BOOKS, MAGAZINES, JOURNALS, SOFTWARE, GAMES, MUSIC, AND ELECTRONIC PUBLICATIONS (U.S. CLS. 100, 101 AND 107).

CHERYL CLAYTON, EXAMINING ATTORNEY

CLASS 41—(Continued).

SN 77-180,950. NBA DEVELOPMENT LEAGUE, LLC, SE-CAUCUS, NJ. FILED 5-15-2007.

CLASS 41—(Continued).

SN 77-180,966. NBA DEVELOPMENT LEAGUE, LLC, SE-CAUCUS, NJ. FILED 5-15-2007.

FORT WAYNE FIRE

FORT WAYNE COYOTES

THE MARK CONSISTS OF STANDARD CHARACTERS WITHOUT CLAIM TO ANY PARTICULAR FONT, STYLE, SIZE, OR COLOR.

NO CLAIM IS MADE TO THE EXCLUSIVE RIGHT TO USE "FORT WAYNE", APART FROM THE MARK AS SHOWN.

FOR ENTERTAINMENT AND EDUCATIONAL SERVICES IN THE NATURE OF ONGOING TELEVISION AND RADIO PROGRAMS IN THE FIELD OF BASKETBALL AND RENDERING LIVE BASKETBALL GAMES AND BASKETBALL EXHIBITIONS; THE PRODUCTION AND DISTRIBUTION OF RADIO AND TELEVISION BROADCASTS OF BASKETBALL GAMES, BASKETBALL EVENTS AND PROGRAMS IN THE FIELD OF BASKETBALL; CONDUCTING AND ARRANGING BASKETBALL CLINICS AND CAMPS, COACHES CLINICS AND CAMPS, DANCE TEAM CLINICS AND CAMPS AND BASKETBALL EVENTS; ENTERTAINMENT SERVICES IN THE NATURE OF PERSONAL APPEARANCES BY A COSTUMED MASCOT OR DANCE TEAM AT BASKETBALL GAMES AND EXHIBITIONS, CLINICS, CAMPS, PROMOTIONS, AND OTHER BASKETBALL-RELATED EVENTS, SPECIAL EVENTS AND PARTIES; FAN CLUB SERVICES; ENTERTAINMENT SERVICES, NAMELY, PROVIDING A WEBSITE FEATURING THE FOLLOWING NON-DOWNLOADABLE CONTENT- TELEVISION HIGHLIGHTS, INTERACTIVE TELEVISION HIGHLIGHTS, VIDEO RECORDINGS, VIDEO STREAM RECORDINGS, INTERACTIVE VIDEO HIGHLIGHT SELECTIONS, RADIO PROGRAMS, RADIO HIGHLIGHTS, AND AUDIO RECORDINGS IN THE FIELD OF BASKETBALL, BASKETBALL NEWS IN THE NATURE OF INFORMATION, STATISTICS, AND TRIVIA ABOUT BASKETBALL, ON-LINE COMPUTER GAMES, VIDEO GAMES, INTERACTIVE VIDEO GAMES, ACTION SKILL GAMES, ARCADE GAMES, ADULTS' AND CHILDREN'S PARTY GAMES, BOARD GAMES, PUZZLES, AND TRIVIA GAMES; PROVIDING ON-LINE MAGAZINES, GUIDES, NEWSLETTERS, COLORING BOOKS, AND GAME SCHEDULES IN THE FIELD OF BASKETBALL OVER THE INTERNET; PROVIDING AN ONLINE COMPUTER DATABASE IN THE FIELD OF BASKETBALL (U.S. CLS. 100, 101 AND 107).

CARRIE GENOVESE, EXAMINING ATTORNEY

THE MARK CONSISTS OF STANDARD CHARACTERS WITHOUT CLAIM TO ANY PARTICULAR FONT, STYLE, SIZE, OR COLOR.

NO CLAIM IS MADE TO THE EXCLUSIVE RIGHT TO USE "FORT WAYNE", APART FROM THE MARK AS SHOWN.

FOR ENTERTAINMENT AND EDUCATIONAL SERVICES IN THE NATURE OF ONGOING TELEVISION AND RADIO PROGRAMS IN THE FIELD OF BASKETBALL AND RENDERING LIVE BASKETBALL GAMES AND BASKETBALL EXHIBITIONS; THE PRODUCTION AND DISTRIBUTION OF RADIO AND TELEVISION BROADCASTS OF BASKETBALL GAMES, BASKETBALL EVENTS AND PROGRAMS IN THE FIELD OF BASKETBALL; CONDUCTING AND ARRANGING BASKETBALL CLINICS AND CAMPS, COACHES CLINICS AND CAMPS, DANCE TEAM CLINICS AND CAMPS AND BASKETBALL EVENTS; ENTERTAINMENT SERVICES IN THE NATURE OF PERSONAL APPEARANCES BY A COSTUMED MASCOT OR DANCE TEAM AT BASKETBALL GAMES AND EXHIBITIONS, CLINICS, CAMPS, PROMOTIONS, AND OTHER BASKETBALL-RELATED EVENTS, SPECIAL EVENTS AND PARTIES; FAN CLUB SERVICES; ENTERTAINMENT SERVICES, NAMELY, PROVIDING A WEBSITE FEATURING THE FOLLOWING NON-DOWNLOADABLE CONTENT- TELEVISION HIGHLIGHTS, INTERACTIVE TELEVISION HIGHLIGHTS, VIDEO RECORDINGS, VIDEO STREAM RECORDINGS, INTERACTIVE VIDEO HIGHLIGHT SELECTIONS, RADIO PROGRAMS, RADIO HIGHLIGHTS, AND AUDIO RECORDINGS IN THE FIELD OF BASKETBALL, BASKETBALL NEWS IN THE NATURE OF INFORMATION, STATISTICS, AND TRIVIA ABOUT BASKETBALL, ON-LINE COMPUTER GAMES, VIDEO GAMES, INTERACTIVE VIDEO GAMES, ACTION SKILL GAMES, ARCADE GAMES, ADULTS' AND CHILDREN'S PARTY GAMES, BOARD GAMES, PUZZLES, AND TRIVIA GAMES; PROVIDING ON-LINE MAGAZINES, GUIDES, NEWSLETTERS, COLORING BOOKS, AND GAME SCHEDULES IN THE FIELD OF BASKETBALL OVER THE INTERNET; PROVIDING AN ONLINE COMPUTER DATABASE IN THE FIELD OF BASKETBALL (U.S. CLS. 100, 101 AND 107).

CARRIE GENOVESE, EXAMINING ATTORNEY

CLASS 41—(Continued).

SN 77-180,980. NBA DEVELOPMENT LEAGUE, LLC, SE-CAUCUS, NJ. FILED 5-15-2007.

FORT WAYNE LIGHTNING

THE MARK CONSISTS OF STANDARD CHARACTERS WITHOUT CLAIM TO ANY PARTICULAR FONT, STYLE, SIZE, OR COLOR.

NO CLAIM IS MADE TO THE EXCLUSIVE RIGHT TO USE "FORT WAYNE", APART FROM THE MARK AS SHOWN.

FOR ENTERTAINMENT AND EDUCATIONAL SERVICES IN THE NATURE OF ONGOING TELEVISION AND RADIO PROGRAMS IN THE FIELD OF BASKETBALL AND RENDERING LIVE BASKETBALL GAMES AND BASKETBALL EXHIBITIONS; THE PRODUCTION AND DISTRIBUTION OF RADIO AND TELEVISION BROADCASTS OF BASKETBALL GAMES, BASKETBALL EVENTS AND PROGRAMS IN THE FIELD OF BASKETBALL; CONDUCTING AND ARRANGING BASKETBALL CLINICS AND CAMPS, COACHES CLINICS AND CAMPS, DANCE TEAM CLINICS AND CAMPS AND BASKETBALL EVENTS; ENTERTAINMENT SERVICES IN THE NATURE OF PERSONAL APPEARANCES BY A COSTUMED MASCOT OR DANCE TEAM AT BASKETBALL GAMES AND EXHIBITIONS, CLINICS, CAMPS, PROMOTIONS, AND OTHER BASKETBALL-RELATED EVENTS, SPECIAL EVENTS AND PARTIES; FAN CLUB SERVICES; ENTERTAINMENT SERVICES, NAMELY PROVIDING A WEBSITE FEATURING THE FOLLOWING NON-DOWNLOADABLE CONTENT—TELEVISION HIGHLIGHTS, INTERACTIVE TELEVISION HIGHLIGHTS, VIDEO RECORDINGS, VIDEO STREAM RECORDINGS, INTERACTIVE VIDEO HIGHLIGHT SELECTIONS, RADIO PROGRAMS, RADIO HIGHLIGHTS, AND AUDIO RECORDINGS IN THE FIELD OF BASKETBALL, BASKETBALL NEWS IN THE NATURE OF INFORMATION, STATISTICS, AND TRIVIA ABOUT BASKETBALL, ON-LINE COMPUTER GAMES, VIDEO GAMES, INTERACTIVE VIDEO GAMES, ACTION SKILL GAMES, ARCADE GAMES, ADULTS' AND CHILDREN'S PARTY GAMES, BOARD GAMES, PUZZLES, AND TRIVIA GAMES; PROVIDING ON-LINE MAGAZINES, GUIDES, NEWSLETTERS, COLORING BOOKS, AND GAME SCHEDULES IN THE FIELD OF BASKETBALL OVER THE INTERNET; PROVIDING AN ONLINE COMPUTER DATABASE IN THE FIELD OF BASKETBALL (U.S. CLS. 100, 101 AND 107).

CARRIE GENOVESE, EXAMINING ATTORNEY

SN 77-182,627. STUDIO K, LLC, PHILADELPHIA, PA. FILED 5-16-2007.

YOGA SQUARED

THE MARK CONSISTS OF STANDARD CHARACTERS WITHOUT CLAIM TO ANY PARTICULAR FONT, STYLE, SIZE, OR COLOR.

NO CLAIM IS MADE TO THE EXCLUSIVE RIGHT TO USE "YOGA", APART FROM THE MARK AS SHOWN.

FOR YOGA INSTRUCTION; PHYSICAL FITNESS CONSULTATION AND INSTRUCTION; PROVIDING FITNESS AND EXERCISE FACILITIES (U.S. CLS. 100, 101 AND 107).

KATHERINE STOIDES, EXAMINING ATTORNEY

CLASS 41—(Continued).

SN 77-183,820. CBS RADIO INC., NEW YORK, NY. FILED 5-17-2007.

T.A.G. TOTALLY AGAINST GRAFFITI

THE MARK CONSISTS OF STANDARD CHARACTERS WITHOUT CLAIM TO ANY PARTICULAR FONT, STYLE, SIZE, OR COLOR.

NO CLAIM IS MADE TO THE EXCLUSIVE RIGHT TO USE "GRAFFITI", APART FROM THE MARK AS SHOWN.

FOR EDUCATIONAL SERVICES, NAMELY, A COMMUNITY AWARENESS PROGRAM IN THE NATURE OF INTERACTIVE LIVE PERFORMANCES EDUCATING CHILDREN AND YOUTH ABOUT GRAFFITI (U.S. CLS. 100, 101 AND 107).

FIRST USE 1-2-2000; IN COMMERCE 1-2-2000.

JENNIFER KRISP, EXAMINING ATTORNEY

SN 77-184,559. AVESTA SYSTEMS, INC, HUDSON, OH. FILED 5-18-2007.

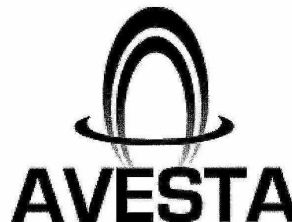

FOR CORPORATE TRAINING PROGRAMS FOCUSED ON PROVIDING STRATEGIES AND TACTICS TO IMPROVE JOB PERFORMANCE AMONG EMPLOYEES IN THE HEALTHCARE INDUSTRY (U.S. CLS. 100, 101 AND 107).

FIRST USE 5-1-2007; IN COMMERCE 5-1-2007.

KARANENDRA S. CHHINA, EXAMINING ATTORNEY

SN 77-186,744. LUCKY STRIKE ENTERTAINMENT, LLC, SHERMAN OAKS, CA. FILED 5-22-2007.

ROCK BOX

THE MARK CONSISTS OF STANDARD CHARACTERS WITHOUT CLAIM TO ANY PARTICULAR FONT, STYLE, SIZE, OR COLOR.

FOR AMUSEMENT ARCADES (U.S. CLS. 100, 101 AND 107).

WARREN L. OLANDRIA, EXAMINING ATTORNEY

CLASS 41—(Continued).

SN 77-187,337. VISION QUEST LLC, CHICAGO, IL. FILED 5-22-2007.

VISION QUEST

THE MARK CONSISTS OF STANDARD CHARACTERS WITHOUT CLAIM TO ANY PARTICULAR FONT, STYLE, SIZE, OR COLOR.

FOR PERSONAL COACHING SERVICES FOR CYCLISTS, TRIATHLETES AND RUNNERS (U.S. CLS. 100, 101 AND 107).

FIRST USE 5-15-2000; IN COMMERCE 5-15-2000.
STEPHANIE ALI, EXAMINING ATTORNEY

SN 77-187,665. KING, ANTONIO V., MONTGOMERY, AL. FILED 5-22-2007.



THE COLOR(S) WHITE, RED, BLACK AND BLUE IS/ARE CLAIMED AS A FEATURE OF THE MARK.

THE COLOR WHITE APPEARS IN THE WORDING "FIT" AND "CHRIST," IN THE HORIZONTAL LINE BELOW THIS WORDING, AND IN THE SUNSHINE DESIGN AT THE LOWER RIGHT EDGE OF THE MARK; THE COLOR RED APPEARS IN THE LARGE NUMBER "4"; THE COLOR BLACK APPEARS IN THE CROSS DESIGN THAT APPEARS INSIDE THE LETTER "T" IN THE WORD "CHRIST"; AND THE COLOR BLUE APPEARS IN THE OVAL BACKGROUND.

FOR PROVIDING FITNESS AND EXERCISE FACILITIES (U.S. CLS. 100, 101 AND 107).
GILBERT SWIFT, EXAMINING ATTORNEY

SN 77-190,867. LEAPFROG STRATEGIES, INC., WHITE BEAR LAKE, MN. FILED 5-25-2007.

SALES SHEBANG

THE MARK CONSISTS OF STANDARD CHARACTERS WITHOUT CLAIM TO ANY PARTICULAR FONT, STYLE, SIZE, OR COLOR.

NO CLAIM IS MADE TO THE EXCLUSIVE RIGHT TO USE "SALES", APART FROM THE MARK AS SHOWN.

FOR ARRANGING PROFESSIONAL WORKSHOP AND TRAINING COURSES; EDUCATIONAL SERVICES, NAMELY, DEVELOPING, ARRANGING, AND CONDUCTING EDUCATIONAL CONFERENCES AND PROGRAMS AND PROVIDING COURSES OF INSTRUCTION IN THE FIELD OF SALES; PROVIDING ON-LINE TRAINING COURSES, SEMINARS AND WORKSHOPS IN THE FIELD OF SALES (U.S. CLS. 100, 101 AND 107).
PETER CHENG, EXAMINING ATTORNEY

CLASS 41—(Continued).

SN 77-195,360. UBISOFT PROPERTIES LLC, SAN FRANCISCO, CA. FILED 6-1-2007.

WILD PETZ

THE MARK CONSISTS OF STANDARD CHARACTERS WITHOUT CLAIM TO ANY PARTICULAR FONT, STYLE, SIZE, OR COLOR.

OWNER OF U.S. REG. NO. 2,756,487.

FOR ENTERTAINMENT SERVICES NAMELY PROVIDING INFORMATION ON-LINE RELATING TO COMPUTER GAMES, VIDEO GAMES AND COMPUTER AND VIDEO GAMES RELATED PRODUCTS (U.S. CLS. 100, 101 AND 107).

JASON ROTH, EXAMINING ATTORNEY

SN 77-195,402. JTM PROVISIONS COMPANY, INC., HARRISON, OH. FILED 6-1-2007.



THE MARK CONSISTS OF A DEPICTION OF A FIGURE RUNNING WITH THE WORDS "BETTER STEPS" BELOW, ALL CONTAINED WITHIN A CIRCLE.

FOR EDUCATIONAL SERVICES, NAMELY, CONDUCTING PROGRAMS IN THE FIELD OF HEALTHY EATING AND NUTRITION, AND PRINTED MATERIALS DISTRIBUTED IN CONNECTION THEREWITH (U.S. CLS. 100, 101 AND 107).

CHRISTOPHER OTT, EXAMINING ATTORNEY

SN 77-195,491. WESTIN HOTEL MANAGEMENT, L.P., WHITE PLAINS, NY. FILED 6-1-2007.

RUNWESTIN

THE MARK CONSISTS OF STANDARD CHARACTERS WITHOUT CLAIM TO ANY PARTICULAR FONT, STYLE, SIZE, OR COLOR.

FOR PHYSICAL FITNESS CONDITIONING CLASSES; PHYSICAL FITNESS CONSULTATION; PHYSICAL FITNESS INSTRUCTION (U.S. CLS. 100, 101 AND 107).

ROBIN CHOSID, EXAMINING ATTORNEY

CLASS 41—(Continued).

SN 77-198,870. TECHNO SOURCE, KOWLOON, HONG KONG, FILED 6-6-2007.

STRIKE IT BIG

THE MARK CONSISTS OF STANDARD CHARACTERS WITHOUT CLAIM TO ANY PARTICULAR FONT, STYLE, SIZE, OR COLOR.

FOR ENTERTAINMENT SERVICES, NAMELY, PROVIDING AN ON-LINE COMPUTER GAME (U.S. CLS. 100, 101 AND 107).

LINDA M. KING, EXAMINING ATTORNEY

SN 77-199,976. SHISEIDO COMPANY, LTD., TOKYO, JAPAN, FILED 6-7-2007.

KIRANA SPA

THE MARK CONSISTS OF STANDARD CHARACTERS WITHOUT CLAIM TO ANY PARTICULAR FONT, STYLE, SIZE, OR COLOR.

NO CLAIM IS MADE TO THE EXCLUSIVE RIGHT TO USE "SPA", APART FROM THE MARK AS SHOWN.

THE FOREIGN WORDING IN THE MARK TRANSLATES INTO ENGLISH AS RAY; BEAUTIFUL; GLORIOUS, LOVELY.

FOR EDUCATIONAL SERVICES, NAMELY, INSTRUCTION IN HOW TO USE MAKEUP AND MAKEUP TECHNIQUES; ARRANGING AND CONDUCTING EDUCATIONAL SEMINARS ON BEAUTY AND HEALTH; HEALTH CLUB SERVICES, NAMELY, PROVIDING INSTRUCTION AND EQUIPMENT IN THE FIELD OF PHYSICAL EXERCISE (U.S. CLS. 100, 101 AND 107).

TAMARA FRAZIER, EXAMINING ATTORNEY

SN 77-206,632. AZTECA INTERNATIONAL CORPORATION, LOS ANGELES, CA. FILED 6-14-2007.

SEXTO SENTIDO

THE MARK CONSISTS OF STANDARD CHARACTERS WITHOUT CLAIM TO ANY PARTICULAR FONT, STYLE, SIZE, OR COLOR.

THE FOREIGN WORDING IN THE MARK TRANSLATES INTO ENGLISH AS SIXTH SENSE.

FOR ENTERTAINMENT IN THE NATURE OF ONGOING TELEVISION PROGRAMS IN THE FIELD OF SEX (U.S. CLS. 100, 101 AND 107).

LEE-ANNE BERNIS, EXAMINING ATTORNEY

CLASS 41—(Continued).

SN 77-212,843. AOL LLC, DULLES, VA. FILED 6-22-2007.

CIRCAVIE

THE MARK CONSISTS OF STANDARD CHARACTERS WITHOUT CLAIM TO ANY PARTICULAR FONT, STYLE, SIZE, OR COLOR.

FOR ONLINE JOURNALS, NAMELY, BLOGS FEATURING INFORMATION ABOUT PERSONAL, SOCIAL, AND GROUP EVENTS (U.S. CLS. 100, 101 AND 107).

PAMELA HIRSCHMAN, EXAMINING ATTORNEY

SN 77-215,466. PREVO'S FAMILY MARKETS, INC., GRAND RAPIDS, MI. FILED 6-26-2007.

VIDEOTIME

THE MARK CONSISTS OF STANDARD CHARACTERS WITHOUT CLAIM TO ANY PARTICULAR FONT, STYLE, SIZE, OR COLOR.

FOR RENTAL OF DVDS, VIDEOTAPES AND VIDEO GAMES (U.S. CLS. 100, 101 AND 107).

FIRST USE 0-0-1994; IN COMMERCE 0-0-1994.

WON TEAK OH, EXAMINING ATTORNEY

SN 77-219,152. ACCELERATION PRODUCTS, INC., FARGO, ND. FILED 6-29-2007.

UNLEVEL THE PLAYING FIELD

THE MARK CONSISTS OF STANDARD CHARACTERS WITHOUT CLAIM TO ANY PARTICULAR FONT, STYLE, SIZE, OR COLOR.

FOR EDUCATIONAL SERVICES, NAMELY, CONDUCTING SEMINARS IN THE FIELD OF EXERCISE AND SPORT TRAINING; SPORT SKILLS TRAINING INSTRUCTION; PHYSICAL FITNESS INSTRUCTION (U.S. CLS. 100, 101 AND 107).

DOMINIC J. FERRAIUOLO, EXAMINING ATTORNEY

CLASS 41—(Continued).

SN 77-225,946. AAFL ENTERPRISES, LLC, NEW YORK, NY.
FILED 7-10-2007.

THE TRADITIONS CONTINUE

THE MARK CONSISTS OF STANDARD CHARACTERS WITHOUT CLAIM TO ANY PARTICULAR FONT, STYLE, SIZE, OR COLOR.

FOR ORGANIZATION OF SPORTS EVENTS IN THE FIELD OF FOOTBALL; STAGING OF SPORTS EVENTS IN THE FIELD OF FOOTBALL; ENTERTAINMENT SERVICES IN THE NATURE OF FOOTBALL CONTESTS AND EXHIBITIONS; PROVIDING INFORMATION IN THE FIELD OF SPORTS, ENTERTAINMENT AND RELATED TOPICS LIVE AND VIA AUDIO AND VIDEO BROADCASTING OR A GLOBAL COMPUTER NETWORK; PRODUCTION OF AUDIO AND VIDEO PROGRAMS IN THE NATURE OF FOOTBALL EVENTS (U.S. CLS. 100, 101 AND 107).

FIRST USE 7-3-2007; IN COMMERCE 7-3-2007.
CHERYL CLAYTON, EXAMINING ATTORNEY

SN 77-232,610. GOFISH CORPORATION, SAN FRANCISCO, CA. FILED 7-18-2007.

MMA Today

THE MARK CONSISTS OF STANDARD CHARACTERS WITHOUT CLAIM TO ANY PARTICULAR FONT, STYLE, SIZE, OR COLOR.

NO CLAIM IS MADE TO THE EXCLUSIVE RIGHT TO USE "MMA", APART FROM THE MARK AS SHOWN.

FOR (BASED ON USE IN COMMERCE) ENTERTAINMENT SERVICES NAMELY PROVIDING A WEBSITE FEATURING, PHOTOGRAPHIC, AUDIO, VIDEO AND PROSE PRESENTATIONS FEATURING INFORMATION, NEWS AND INSTRUCTION IN THE FIELD OF THE SYSTEMIZATION OF FIGHTING TECHNIQUES CONSISTING OF COMBAT SKILLS, FITNESS, SELF-DEFENSE, SPORT, SELF-CULTIVATION/MEDITATION, MENTAL DISCIPLINE, CHARACTER DEVELOPMENT AND BUILDING CONFIDENCE; ENTERTAINMENT NAMELY, PRODUCTION OF LIVE-ACTION, COMEDY, DRAMA AND REALITY-BASED WEB SERIES; ENTERTAINMENT SERVICES, NAMELY, PROVIDING A TELEVISION PROGRAM FEATURING INFORMATION, NEWS AND INSTRUCTION IN THE FIELD OF THE SYSTEMIZATION OF FIGHTING TECHNIQUES CONSISTING OF COMBAT SKILLS, FITNESS, SELF-DEFENSE, SPORT, SELF-CULTIVATION/MEDITATION, MENTAL DISCIPLINE, CHARACTER DEVELOPMENT AND BUILDING CONFIDENCE VIA A GLOBAL COMPUTER NETWORK; ENTERTAINMENT SERVICES, NAMELY, PROVIDING A WEB SITE FEATURING MUSICAL PERFORMANCES, MUSICAL VIDEOS, RELATED FILM CLIPS, PHOTOGRAPHS, AND OTHER MULTIMEDIA MATERIALS; ENTERTAINMENT SERVICES, NAMELY, PROVIDING PODCASTS FEATURING INFORMATION, NEWS AND INSTRUCTION IN THE FIELD OF THE SYSTEMIZATION OF FIGHTING TECHNIQUES CONSISTING OF COMBAT SKILLS, FITNESS, SELF-DEFENSE, SPORT, SELF-CULTIVATION/MEDITATION, MENTAL DISCIPLINE, CHARACTER DEVELOPMENT AND BUILDING CONFIDENCE; ENTERTAINMENT SERVICES, NAMELY, PROVIDING WEBCASTS FEATURING INFORMATION, NEWS AND INSTRUCTION IN THE FIELD OF THE SYSTEMIZA-

CLASS 41—(Continued).

TION OF FIGHTING TECHNIQUES CONSISTING OF COMBAT SKILLS, FITNESS, SELF-DEFENSE, SPORT, SELF-CULTIVATION/MEDITATION, MENTAL DISCIPLINE, CHARACTER DEVELOPMENT AND BUILDING CONFIDENCE; ENTERTAINMENT, NAMELY A CONTINUING LIVE-ACTION, COMEDY, DRAMA AND REALITY-BASED WEB SHOW BROADCAST OVER TELEVISION, SATELLITE, AUDIO, AND VIDEO MEDIA; PROVIDING A WEB SITE WHERE USERS CAN POST RATINGS, REVIEWS AND RECOMMENDATIONS ON EVENTS AND ACTIVITIES IN THE FIELD OF ENTERTAINMENT AND EDUCATION; PROVIDING INFORMATION, NEWS AND COMMENTARY IN THE FIELD OF ENTERTAINMENT; EDUCATIONAL AND ENTERTAINMENT SERVICES, NAMELY, A CONTINUING PROGRAM FEATURING INFORMATION, NEWS AND INSTRUCTION OF SYSTEMIZATION OF FIGHTING TECHNIQUES CONSISTING OF COMBAT SKILLS, FITNESS, SELF-DEFENSE, SPORT, SELF-CULTIVATION/MEDITATION, MENTAL DISCIPLINE, CHARACTER DEVELOPMENT AND BUILDING CONFIDENCE ACCESSIBLE BY RADIO, TELEVISION, SATELLITE, AUDIO, VIDEO AND COMPUTER NETWORKS(BASED ON INTENT TO USE) ENTERTAINMENT IN THE NATURE OF AN ON-GOING SPECIAL VARIETY, NEWS, MUSIC OR COMEDY SHOW FEATURING INFORMATION, NEWS AND INSTRUCTION IN THE FIELD OF THE SYSTEMIZATION OF FIGHTING TECHNIQUES CONSISTING OF COMBAT SKILLS, FITNESS, SELF-DEFENSE, SPORT, SELF-CULTIVATION/MEDITATION, MENTAL DISCIPLINE, CHARACTER DEVELOPMENT AND BUILDING CONFIDENCE BROADCAST OVER TELEVISION, SATELLITE, AUDIO, AND VIDEO MEDIA; ENTERTAINMENT IN THE NATURE OF ON-GOING TELEVISION PROGRAMS FEATURING INFORMATION, NEWS AND INSTRUCTION IN THE FIELD OF THE SYSTEMIZATION OF FIGHTING TECHNIQUES CONSISTING OF COMBAT SKILLS, FITNESS, SELF-DEFENSE, SPORT, SELF-CULTIVATION/MEDITATION, MENTAL DISCIPLINE, CHARACTER DEVELOPMENT AND BUILDING CONFIDENCE (U.S. CLS. 100, 101 AND 107).

FIRST USE 6-6-2007; IN COMMERCE 6-6-2007.
KYLE PEETE, EXAMINING ATTORNEY

SN 78-320,707. FORMAN MILLS, INC., PENNSAUKEN, NJ.
FILED 10-30-2003.

MODELS STARS & JERKS

NO CLAIM IS MADE TO THE EXCLUSIVE RIGHT TO USE "MODELS STARS", APART FROM THE MARK AS SHOWN.

FOR PROVIDING LIVE ENTERTAINMENT IN THE FIELD OF VARIETY SHOWS (U.S. CLS. 100, 101 AND 107).

FIRST USE 12-1-2003; IN COMMERCE 12-1-2003.
WON TEAK OH, EXAMINING ATTORNEY

CLASS 41—(Continued).

SN 78-617,182. ADVANCE CONSULTING INC., BELVEDERE, CA. FILED 4-26-2005.

Partnering for Results

THE MARK CONSISTS OF STANDARD CHARACTERS WITHOUT CLAIM TO ANY PARTICULAR FONT, STYLE, SIZE, OR COLOR.

FOR TRAINING COURSES IN ADVERTISING, PROMOTION, MARKETING AND BUSINESS, AND TRAINING MATERIALS DISTRIBUTED THEREWITH (U.S. CLS. 100, 101 AND 107).

FIRST USE 11-12-1995; IN COMMERCE 11-12-1995.
COLLEEN KEARNEY, EXAMINING ATTORNEY

SN 78-672,483. PRICE, BONNIE, NORTHFIELD, IL. FILED 7-18-2005.



THE MARK CONSISTS OF STYLIZED WOMAN'S FACE FOR ARRANGING OF SEMINARS AND CONFERENCES; ARRANGING PROFESSIONAL WORKSHOP AND TRAINING COURSES; BOOK AND REVIEW PUBLISHING; CONDUCTING WORKSHOPS AND SEMINARS IN PERSONAL AWARENESS; ENTERTAINMENT SERVICES, NAMELY, PROVIDING ON-LINE REVIEWS OF BOOKS (U.S. CLS. 100, 101 AND 107).

FIRST USE 4-1-2005; IN COMMERCE 4-1-2005.
TINA L. SNAPP, EXAMINING ATTORNEY

SN 78-674,261. KORNER, DAVID, LEE, MT. VIEW, CA. FILED 7-20-2005.

SportsKorner.com

THE MARK CONSISTS OF STANDARD CHARACTERS WITHOUT CLAIM TO ANY PARTICULAR FONT, STYLE, SIZE, OR COLOR.

FOR ONLINE PUBLICATIONS IN THE NATURE OF CARTOON STRIPS, AND NEWSPAPER CARTOONS IN THE FIELD OF SPORTS AND SPORTS TRIVIA (U.S. CLS. 100, 101 AND 107).

FIRST USE 7-14-2005; IN COMMERCE 7-14-2005.
SARA THOMAS, EXAMINING ATTORNEY

CLASS 41—(Continued).

SN 78-678,957. JOSEPH CAMPBELL FOUNDATION, SAN ANSELMO, CA. FILED 7-26-2005.

MYTHOLOGICAL ROUNDTABLE

THE MARK CONSISTS OF STANDARD CHARACTERS WITHOUT CLAIM TO ANY PARTICULAR FONT, STYLE, SIZE, OR COLOR.

SEC. 2(F).

FOR ORGANIZATION OF SEMINARS, WORKING GROUPS, AND RESEARCH GROUPS IN THE FIELD OF MYTHOLOGY AND COMPARATIVE RELIGION (U.S. CLS. 100, 101 AND 107).

FIRST USE 6-0-1998; IN COMMERCE 6-0-1998.
WENDY GOODMAN, EXAMINING ATTORNEY

SN 78-701,978. CHURCH, DAWSON, SANTA ROSA, CA. FILED 8-27-2005.

Elite Editions

THE MARK CONSISTS OF STANDARD CHARACTERS WITHOUT CLAIM TO ANY PARTICULAR FONT, STYLE, SIZE, OR COLOR.

NO CLAIM IS MADE TO THE EXCLUSIVE RIGHT TO USE "EDITIONS", APART FROM THE MARK AS SHOWN. FOR PUBLICATION OF BOOKS (U.S. CLS. 100, 101 AND 107).

FIRST USE 1-1-2001; IN COMMERCE 1-1-2001.
MICHELLE DUBOIS, EXAMINING ATTORNEY

SN 78-708,903. HONER, JODI, NY, NY. FILED 9-8-2005.

CLONEPROOF

THE MARK CONSISTS OF STANDARD CHARACTERS WITHOUT CLAIM TO ANY PARTICULAR FONT, STYLE, SIZE, OR COLOR.

FOR ENTERTAINMENT IN THE NATURE OF TELEVISION NETWORK SERVICES, NAMELY, PRODUCTION OF TELEVISION SHOWS; PRODUCTION, SYNDICATION AND DISTRIBUTION OF TELEVISION SHOWS, INTERACTIVE TELEVISION SHOWS, TELEVISION SHOWS BROADCAST VIA THE INTERNET, AND RADIO PROGRAMMING; PRODUCTION AND DISTRIBUTION OF MOTION PICTURE FILMS; ENTERTAINMENT IN THE NATURE OF INTERACTIVE TELEVISION PROGRAMS IN THE AREA OF NEWS, COMEDY, DRAMA, VARIETY, AWARD SHOWS, NON-FICTION, DOCUMENTARY, EDUCATION, GAME SHOWS, GAMES AND SPORTS; ENTERTAINMENT IN THE NATURE OF ONGOING TELEVISION PROGRAMS IN THE FIELD OF CHILDREN'S ENTERTAINMENT; DIRECTION OF MAKING RADIO AND TELEVISION PROGRAMS; EDITING OR RECORDING OF SOUNDS AND IMAGES; ENTERTAINMENT SERVICES,

CLASS 41—(Continued).

NAMELY, PROVIDING INTERACTIVE, NETWORKED AND REAL-TIME MULTIPLAYER GAMES AND CONTESTS VIA TELEVISION, DIGITAL BROADBAND AND GLOBAL COMPUTER NETWORKS; ENTERTAINMENT SERVICES, NAMELY, PROVIDING COMPUTER GAMES AND VIDEO GAMES THAT CAN BE ACCESSED, PLAYED, STREAMED OVER COMPUTER NETWORKS, INTERACTIVE TELEVISION, BROADBAND, WIRELESS NETWORKS, SATELLITE AND CABLE; ENTERTAINMENT, NAMELY, CONDUCTING CONTESTS; ORGANIZATION OF GAMES; PROVIDING VIDEO AND COMPUTER GAMES THAT MAY BE ACCESSED NETWORK-WIDE BY NETWORK USERS; SPORTS REFEREEING AND OFFICIATING; PROVIDING COMPANIONSHIP FOR PLAYING GAMES; CONDUCTING LIVE CURRENT EVENTS REPORTING; EDUCATION SERVICES, NAMELY, ONE-ON-ONE MENTORING IN THE FIELDS OF BUSINESS, PERSONAL EMPOWERMENT AND LIFE COACHING; EDUCATIONAL SERVICES IN THE NATURE OF CORRESPONDENCE SCHOOLS; STANDARDIZED TESTING; LIBRARIES; ENTERTAINMENT IN THE NATURE OF CREATIVE AND SPORTS COMPETITIONS AND EXHIBITIONS; PUBLISHING OF WEB AND TELEVISION MAGAZINES, GUIDES AND MANUALS; MAGAZINE PUBLISHING; CD AND DVD PRODUCTION FOR OTHERS; MULTIMEDIA ENTERTAINMENT AND EDUCATION SOFTWARE PRODUCTION SERVICES; DIGITAL IMAGING SERVICES; ORGANIZING COMMUNITY SPORTS COMPETITIONS, GAME TOURNAMENTS, TALENT SHOWS, AWARD SHOWS, FASHION SHOWS, MAGIC SHOWS AND CULTURAL EVENTS; LIVE MUSIC CONCERTS; SPECIAL EFFECTS AND ANIMATION PRODUCTION SERVICES; ELECTRONIC PUBLISHING SERVICES, NAMELY, PUBLICATION OF NEWS CLIPS, PHOTOS, LINKS, JOURNALS, ESSAYS, MUSIC, VIDEO BLOGS, REVIEWS, AND GENERAL PUBLIC OPINION COMMENTARY; MUSIC PUBLISHING SERVICES; CASINOS; NIGHT CLUBS; SOCIAL CLUBS; FAN CLUBS; PROVIDING THEME PARK SERVICES; PROVIDING ENTERTAINMENT AND AMUSEMENT CENTERS FEATURING INTERACTIVE PLAY AREAS; ENTERTAINMENT SERVICES, NAMELY, CONDUCTING PARTIES FOR THE PURPOSE OF DATING AND SOCIAL INTRODUCTION FOR ADULTS; WAGERING SERVICES; EDUCATION SERVICES, NAMELY, CONDUCTING CLASSES IN THE NATURE OF FASHION AND BEAUTY SKILLS; LANGUAGE TRANSLATION; MUSEUMS; ENTERTAINMENT IN THE NATURE OF CIRCUSES; CINEMA THEATERS; ON-LINE LIBRARY SERVICES, NAMELY, PROVIDING ELECTRONIC LIBRARY SERVICES IN THE NATURE OF SEARCHES WHICH FEATURE NEWS, MAGAZINES, PHOTOGRAPHS AND PICTURES VIA AN ON-LINE COMPUTER NETWORK, INTERACTIVE TELEVISION, HANDHELD COMPUTERS, CELLULAR PHONES, INTRANETS, AND THE INTERNET; CHARITABLE SERVICES, NAMELY, PROVIDING BOOKS, TOYS AND SPORTING GOODS TO THE NEEDY; AWARDS PROGRAM FOR MAJOR CORPORATIONS AND INDIVIDUALS WHO HAVE MADE SIGNIFICANT CHARITABLE COMMUNITY CONTRIBUTIONS; PROVIDING INCENTIVES TO PEOPLE BY THE WAY OF AWARDS TO DEMONSTRATE INDIVIDUAL EXCELLENCE IN CREATIVITY, INNOVATION, AND ACHIEVEMENT; ENTERTAINMENT SERVICES, NAMELY, PROVIDING A WEBSITE FEATURING MUSIC, VIDEO, TELEVISION, RADIO, MOVIES, AND USER-GENERATED ENTERTAINMENT CONTENT THAT USERS CAN CONTRIBUTE TO AND INTERACT WITH; PROVIDING AN INTERACTIVE WEBSITE FOR USER-GENERATED REVIEWS AND RATINGS OF ENTERTAINMENT CONTENT; ONLINE JOURNALS AND ENTERTAINMENT CONTENT, NAMELY, BLOGS AND HYPERLINKS FEATURING ORIGINAL MULTIMEDIA CONTENT; MULTIMEDIA STUDIOS (U.S. CLS. 100, 101 AND 107).

JESSICA A. POWERS, EXAMINING ATTORNEY

CLASS 41—(Continued).

SN 78-748,482. FOX, SANDY, STUDIO CITY, CA. AND LANG, LEX, STUDIO CITY, CA. FILED 11-7-2005.

INSIDE ANIME

THE MARK CONSISTS OF STANDARD CHARACTERS WITHOUT CLAIM TO ANY PARTICULAR FONT, STYLE, SIZE, OR COLOR.

NO CLAIM IS MADE TO THE EXCLUSIVE RIGHT TO USE "ANIME", APART FROM THE MARK AS SHOWN.

THE FOREIGN WORDING IN THE MARK TRANSLATES INTO ENGLISH AS A JAPANESE STYLE OF MOTION-PICTURE ANIMATION; A STYLE OF ANIMATION DEVELOPED IN JAPAN.

FOR ENTERTAINMENT SERVICES IN THE NATURE OF A TELEVISION SERIES FEATURING AN ENTERTAINMENT NEWS PROGRAM REPORTING ON ALL ASPECTS OF "ANIME" PRODUCTION; PRODUCTION AND SYNDICATION OF TELEVISIONS SHOWS AND TELEVISION PROGRAMS FEATURING REPORTING ON ALL ASPECTS OF "ANIME" PRODUCTION; PRODUCTION AND DISTRIBUTION OF TELEVISION PROGRAMS IN DIGITAL FORMAT VIA BROADCAST TELEVISION, CABLE TELEVISION, SATELLITE, WIRELESS, INTERNET AND BROADBAND; ENTERTAINMENT SERVICES, IN THE NATURE OF INTERACTIVE TELEVISION PROGRAMS IN THE FIELD OF NEWS AND VARIETY PROGRAMS (U.S. CLS. 100, 101 AND 107).

FIRST USE 1-1-2004; IN COMMERCE 1-1-2004.
BONNIE LUKEN, EXAMINING ATTORNEY

CLASS 41—(Continued).

SN 78-752,184. NBA PROPERTIES, INC., NEW YORK, NY.
FILED 11-11-2005.



OWNER OF U.S. REG. NOS. 1,992,917, 2,770,671 AND OTHERS.

THE MARK CONSISTS OF A REPRESENTATION OF A GLOBE AND A BASKETBALL WITH A HEART ALONG SIDE THE NBA LOGO CONSISTING OF A BASKETBALL PLAYER SILHOUETTE.

FOR ENTERTAINMENT AND EDUCATIONAL SERVICES IN THE NATURE OF ONGOING TELEVISION AND RADIO PROGRAMS IN THE FIELD OF BASKETBALL AND RENDERING LIVE BASKETBALL GAMES AND BASKETBALL EXHIBITIONS; THE PRODUCTION AND DISTRIBUTION OF RADIO AND TELEVISION BROADCASTS OF BASKETBALL GAMES, BASKETBALL EVENTS AND PROGRAMS IN THE FIELD OF BASKETBALL; CONDUCTING AND ARRANGING BASKETBALL CLINICS AND CAMPS, COACHES CLINICS AND CAMPS, DANCE TEAM CLINICS AND CAMPS AND BASKETBALL EVENTS; ENTERTAINMENT SERVICES IN THE NATURE OF PERSONAL APPEARANCES BY A COSTUMED MASCOT OR DANCE TEAM AT BASKETBALL GAMES AND EXHIBITIONS, CLINICS, CAMPS, PROMOTIONS, AND OTHER BASKETBALL-RELATED EVENTS, SPECIAL EVENTS AND PARTIES; FAN CLUB SERVICES; ENTERTAINMENT SERVICES, NAMELY, PROVIDING A WEBSITE FEATURING MULTIMEDIA MATERIAL IN THE NATURE OF TELEVISION HIGHLIGHTS, INTERACTIVE TELEVISION HIGHLIGHTS, VIDEO RECORDINGS, VIDEO STREAM RECORDINGS, INTERACTIVE VIDEO HIGHLIGHT SELECTIONS, RADIO PROGRAMS, RADIO HIGHLIGHTS, AND AUDIO RECORDINGS IN THE FIELD OF BASKETBALL; BASKETBALL NEWS IN THE NATURE OF INFORMATION, STATISTICS, AND TRIVIA ABOUT BASKETBALL; ON-LINE NON-DOWNLOADABLE GAMES, NAMELY, COMPUTER GAMES, VIDEO GAMES, INTERACTIVE VIDEO GAMES, ACTION SKILL GAMES, ARCADE GAMES, ADULTS' AND CHILDREN'S PARTY GAMES, BOARD GAMES, PUZZLES, AND TRIVIA GAMES; PROVIDING ON-LINE NON-DOWNLOADABLE PUBLICATIONS IN THE NATURE OF MAGAZINES, GUIDES, NEWSLETTERS, COLORING BOOKS, GAME SCHEDULES IN THE FIELD OF BASKETBALL OVER THE INTERNET; PROVIDING AN ONLINE COMPUTER DATABASE IN THE FIELD OF BASKETBALL; PROVIDING RECOGNITION AND INCENTIVES BY THE WAY OF AWARDS TO DEMONSTRATE EXCELLENCE IN THE FIELD OF COMMUNITY OUTREACH PROGRAMS DESIGNED TO PROMOTE THE IMPORTANCE OF EDUCATION, ENCOURAGE COMMUNITY AWARENESS AND FIGHT ILLITERACY (U.S. CLS. 100, 101 AND 107).

BARBARA GAYNOR, EXAMINING ATTORNEY

CLASS 41—(Continued).

SN 78-765,836. WADELL, JACKIE, BEVERLY HILLS, CA.
FILED 12-2-2005.

SKY SPORT & SPA

THE MARK CONSISTS OF STANDARD CHARACTERS WITHOUT CLAIM TO ANY PARTICULAR FONT, STYLE, SIZE, OR COLOR.

NO CLAIM IS MADE TO THE EXCLUSIVE RIGHT TO USE "SPORT AND SPA", APART FROM THE MARK AS SHOWN.

FOR PHYSICAL FITNESS CONSULTATION SERVICES (U.S. CLS. 100, 101 AND 107).

FIRST USE 10-1-2002; IN COMMERCE 10-1-2002.
GISELLE AGOSTO, EXAMINING ATTORNEY

SN 78-780,787. LIVING THE NEW LIFE MINISTRIES,
DALLAS, GA. FILED 12-26-2005.

**Making the Rest of Your
Years - the Best of Your
Years!**

THE MARK CONSISTS OF STANDARD CHARACTERS WITHOUT CLAIM TO ANY PARTICULAR FONT, STYLE, SIZE, OR COLOR.

FOR EDUCATIONAL SERVICES, NAMELY, CONDUCTING SEMINARS IN THE FIELD OF RELIGIOUS INSTRUCTION, AND DISTRIBUTING MATERIALS IN CONNECTION THEREWITH (U.S. CLS. 100, 101 AND 107).

FIRST USE 11-4-2005; IN COMMERCE 11-14-2005.
PRISCILLA MILTON, EXAMINING ATTORNEY

SN 78-785,188. MEDECOACH.COM, INC., HOUSTON, TX.
FILED 1-4-2006.

COACHPRO

THE MARK CONSISTS OF STANDARD CHARACTERS WITHOUT CLAIM TO ANY PARTICULAR FONT, STYLE, SIZE, OR COLOR.

FOR ONLINE, INTERACTIVE EDUCATIONAL SERVICES, NAMELY, PROVIDING ONE-ON-ONE MENTORING IN THE FIELD OF HEALTH IMPROVEMENT (U.S. CLS. 100, 101 AND 107).

FIRST USE 8-31-2005; IN COMMERCE 8-31-2005.
CAROL SPILLS, EXAMINING ATTORNEY

CLASS 41—(Continued).

SN 78-792,538. ARIZTICAL ENTERTAINMENT, INC., TUCSON, AZ. FILED 1-16-2006.

Ariztical Entertainment

THE MARK CONSISTS OF STANDARD CHARACTERS WITHOUT CLAIM TO ANY PARTICULAR FONT, STYLE, SIZE, OR COLOR.

NO CLAIM IS MADE TO THE EXCLUSIVE RIGHT TO USE "ENTERTAINMENT", APART FROM THE MARK AS SHOWN.

FOR PRODUCTION AND DISTRIBUTION OF MOTION PICTURES; AND PRODUCTION OF PRERECORDED DVD'S AND VIDEO TAPES FOR OTHERS (U.S. CLS. 100, 101 AND 107).

FIRST USE 1-1-1999; IN COMMERCE 1-1-1999.
RAY THOMAS, EXAMINING ATTORNEY

SN 78-793,671. STRIANO, RONALD C., MENDHAM, NJ. FILED 1-18-2006.

Sunshine Lane

THE MARK CONSISTS OF STANDARD CHARACTERS WITHOUT CLAIM TO ANY PARTICULAR FONT, STYLE, SIZE, OR COLOR.

OWNER OF U.S. REG. NO. 2,698,781.
FOR PUBLICATION OF BOOKS (U.S. CLS. 100, 101 AND 107).

FIRST USE 9-27-2000; IN COMMERCE 11-1-2000.
PETER CHENG, EXAMINING ATTORNEY

SN 78-799,263. EISSA, AMR Y., SAN JOSE, CA. FILED 1-25-2006.

WORLD CLASS DOCUMENTATION FOR WORLD CLASS PRODUCTS

THE MARK CONSISTS OF STANDARD CHARACTERS WITHOUT CLAIM TO ANY PARTICULAR FONT, STYLE, SIZE, OR COLOR.

FOR CUSTOM WRITING SERVICES (U.S. CLS. 100, 101 AND 107).

FIRST USE 1-12-2005; IN COMMERCE 1-12-2005.
DOMINIC J. FERRAIUOLO, EXAMINING ATTORNEY

CLASS 41—(Continued).

SN 78-799,358. PASCUA YAQUI TRIBE, TUCSON, AZ. FILED 1-25-2006.

STAGE 21

THE MARK CONSISTS OF STANDARD CHARACTERS WITHOUT CLAIM TO ANY PARTICULAR FONT, STYLE, SIZE, OR COLOR.

FOR LIVE ENTERTAINMENT, NAMELY, MUSICAL CONCERTS, SHOWS FEATURING STAND-UP COMEDY ACTS, AND SHOWCASES FEATURING CARD TOURNAMENTS AND VIDEO GAME TOURNAMENTS; ORGANIZING COMMUNITY SPORTING AND CULTURAL EVENTS; ARRANGING OF CONTESTS; DISTRIBUTION OF RADIO PROGRAMS; PROVIDING FACILITIES FOR TELEVISION SHOW LAUNCH PARTIES (U.S. CLS. 100, 101 AND 107).

FIRST USE 4-0-2005; IN COMMERCE 4-0-2005.
DAVID MURRAY, EXAMINING ATTORNEY

SN 78-799,361. PASCUA YAQUI TRIBE, TUCSON, AZ. FILED 1-25-2006.



NO CLAIM IS MADE TO THE EXCLUSIVE RIGHT TO USE "STAGE", APART FROM THE MARK AS SHOWN.

THE COLOR(S) RED, GRAY, AND BLACK IS/ARE CLAIMED AS A FEATURE OF THE MARK.

THE MARK CONSISTS OF A DISTINCTIVE LOGO CONTAINING THE STAGE 21 MARK WHEREIN THE COLOR RED APPEARS IN THE WORD "STAGE," THE COLOR GRAY APPEARS IN THE OUTLINE OF THE WORD "STAGE" AND IN THE DESIGN ELEMENT, AND THE COLOR BLACK APPEARS IN THE NUMBER 21 AND AS BACKGROUND TO THE ENTIRE MARK.

FOR LIVE ENTERTAINMENT, NAMELY, MUSICAL CONCERTS, SHOWS FEATURING STAND-UP COMEDY ACTS, AND SHOWCASES FEATURING CARD TOURNAMENTS AND VIDEO GAME TOURNAMENTS; ORGANIZING COMMUNITY SPORTING AND CULTURAL EVENTS; ARRANGING OF CONTESTS; DISTRIBUTION OF RADIO PROGRAMS; PROVIDING FACILITIES FOR TELEVISION SHOW LAUNCH PARTIES (U.S. CLS. 100, 101 AND 107).

FIRST USE 4-0-2005; IN COMMERCE 4-0-2005.
DAVID MURRAY, EXAMINING ATTORNEY

CLASS 41—(Continued).

SN 78-826,315. CATALANO, RICHARD, GATES MILLS, OH.
FILED 3-1-2006.



NO CLAIM IS MADE TO THE EXCLUSIVE RIGHT TO USE "FIGHTING ACADEMY", APART FROM THE MARK AS SHOWN.

FOR PROVIDING INSTRUCTIONS IN A SCHOOL IN THE FIELD OF MARTIAL ARTS AND ARRANGING AND CONDUCTING MARTIAL ARTS COMPETITIONS (U.S. CLS. 100, 101 AND 107).

SHAILA SETTLES, EXAMINING ATTORNEY

CLASS 41—(Continued).

SN 78-847,889. BONUS.COM, INC., PALO ALTO, CA. FILED 3-28-2006.

The Paranormals

THE MARK CONSISTS OF STANDARD CHARACTERS WITHOUT CLAIM TO ANY PARTICULAR FONT, STYLE, SIZE, OR COLOR.

FOR ENTERTAINMENT SERVICES, NAMELY, AN ON-LINE COMIC ADVENTURE SERIES (U.S. CLS. 100, 101 AND 107).

PAULA MAYS, EXAMINING ATTORNEY

SN 78-849,402. DEMAGOGUEDVD.COM, LLC, SACRAMENTO, CA. FILED 3-29-2006.

DEMAGOGUE

SN 78-826,453. LIQUID PRODUCTIONS, INC., MESA, AZ.
FILED 3-1-2006.



OWNER OF U.S. REG. NOS. 3,123,264 AND 3,123,265.
NO CLAIM IS MADE TO THE EXCLUSIVE RIGHT TO USE "PRODUCTIONS", APART FROM THE MARK AS SHOWN.

"THE COLOR(S) BLUE AND BLACK IS/ARE CLAIMED AS A FEATURE OF THE MARK."

THE MARK CONSISTS OF THE WORD "LIQUID" IS BLUE IN ALL CAPITAL LETTERS; THE WORD "PRODUCTIONS" IS BLACK IN LOWER CASE LETTERING BELOW THE SECOND HALF OF THE WORD "LIQUID;" THERE IS A BLUE OVAL SWIRL BELOW THE FIRST HALF OF THE WORD "LIQUID."

FOR LIVE EVENT DESIGN, PLANNING AND IMPLEMENTATION SERVICES, NAMELY, DEVELOPING, DESIGNING, PLANNING AND COORDINATING EVENTS FOR OTHERS FOR EVENTS OTHER THAN THOSE RELATED TO BUSINESS FUNCTIONS (U.S. CLS. 100, 101 AND 107).

FIRST USE 10-1-2005; IN COMMERCE 10-1-2005.
PETER CHENG, EXAMINING ATTORNEY

THE MARK CONSISTS OF STANDARD CHARACTERS WITHOUT CLAIM TO ANY PARTICULAR FONT, STYLE, SIZE, OR COLOR.

FOR ENTERTAINMENT SERVICES, NAMELY, PRODUCTION AND DISTRIBUTION OF MOTION PICTURES, MOTION PICTURE FILM CLIPS, AND TELEVISION PROGRAMS FOR OTHERS; MULTIMEDIA ENTERTAINMENT SOFTWARE PRODUCTION SERVICES; ON-LINE ENTERTAINMENT SERVICES, NAMELY, PROVIDING WEB SITES FEATURING VIDEOS, FILM CLIPS, PHOTOGRAPHS, AND OTHER MULTIMEDIA MATERIALS BY MEANS OF A GLOBAL COMPUTER NETWORK (U.S. CLS. 100, 101 AND 107).

MICHAEL KEATING, EXAMINING ATTORNEY

SN 78-858,844. HARDY GIRLS - HEALTHY WOMEN, INC., WATERVILLE, ME. FILED 4-11-2006.

HARDY GIRLS HEALTHY WOMEN

THE MARK CONSISTS OF STANDARD CHARACTERS WITHOUT CLAIM TO ANY PARTICULAR FONT, STYLE, SIZE, OR COLOR.

FOR EDUCATIONAL SERVICES, NAMELY, CONDUCTING WORKSHOPS, CONFERENCES, PROGRAMS AND CLASSES IN THE FIELD OF INDEPENDENCE, EQUALITY AND SAFETY IN THE LIVES OF WOMEN AND GIRLS (U.S. CLS. 100, 101 AND 107).

FIRST USE 10-1-2000; IN COMMERCE 10-1-2000.
PAUL E. FAHRENKOPF, EXAMINING ATTORNEY

CLASS 41—(Continued).

SN 78-858,857. HARDY GIRLS - HEALTHY WOMEN, INC., WATERVILLE, ME. FILED 4-11-2006.

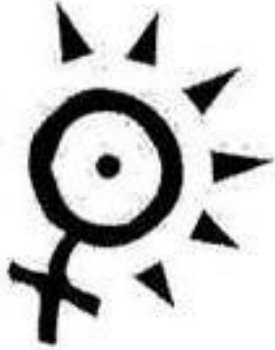

THE MARK CONSISTS OF A STYLIZED VERSION OF THE VENUS SYMBOL.

FOR EDUCATIONAL SERVICES, NAMELY, CONDUCTING WORKSHOPS, CONFERENCES, PROGRAMS AND CLASSES IN THE FIELD OF INDEPENDENCE, EQUALITY AND SAFETY IN THE LIVES OF WOMEN AND GIRLS (U.S. CLS. 100, 101 AND 107).

FIRST USE 10-1-2000; IN COMMERCE 10-1-2000.
PAUL E. FAHRENKOPF, EXAMINING ATTORNEY

SN 78-868,042. GODDARD COLLEGE, PLAINFIELD, VT. FILED 4-24-2006.

Goddard College

THE MARK CONSISTS OF STANDARD CHARACTERS WITHOUT CLAIM TO ANY PARTICULAR FONT, STYLE, SIZE, OR COLOR.

NO CLAIM IS MADE TO THE EXCLUSIVE RIGHT TO USE "COLLEGE", APART FROM THE MARK AS SHOWN. SEC. 2(F).

FOR EDUCATIONAL SERVICES, NAMELY, PROVIDING BA MA AND MFA DEGREE PROGRAMS AND COURSES OF INSTRUCTION AT THE POST-SECONDARY OR COLLEGE LEVEL AND DISTRIBUTING COURSE MATERIAL IN CONNECTION THEREWITH (U.S. CLS. 100, 101 AND 107).

FIRST USE 0-0-1938; IN COMMERCE 0-0-1938.
DARRYL SPRUILL, EXAMINING ATTORNEY

CLASS 41—(Continued).

SN 78-873,210. AUGELLO-COOK, ALICIA, NEW YORK, NY. AND ROBINSON, JEFFREY, NEW YORK, NY. FILED 5-1-2006.

BIG PITA, LITTLE PITA

THE MARK CONSISTS OF STANDARD CHARACTERS WITHOUT CLAIM TO ANY PARTICULAR FONT, STYLE, SIZE, OR COLOR.

FOR ENTERTAINMENT SERVICES, NAMELY, TELEVISION PRODUCTION, MOTION PICTURE PRODUCTION, SHORT SUBJECT FILM PRODUCTION, MUSIC VIDEO PRODUCTION, DIRECTION OF MAKING TELEVISION PROGRAMS, AND DISTRIBUTION OF TELEVISION PROGRAMS FOR OTHERS (U.S. CLS. 100, 101 AND 107).

DOMINIC J. FERRAIUOLO, EXAMINING ATTORNEY

SN 78-879,598. BEOWULF, INC., TUCSON, AZ. FILED 5-9-2006.

SETSAIL

THE MARK CONSISTS OF STANDARD CHARACTERS WITHOUT CLAIM TO ANY PARTICULAR FONT, STYLE, SIZE, OR COLOR.

FOR PROVIDING A WEBSITE FEATURING RECREATIONAL SAILING INFORMATION (U.S. CLS. 100, 101 AND 107).

FIRST USE 3-31-1997; IN COMMERCE 3-31-1997.
NAAKWAMA ANKRAH, EXAMINING ATTORNEY

SN 78-897,955. MOWER, THOMAS E., SPRINGVILLE, UT. FILED 6-1-2006.

MOWER MOUNTAIN

THE MARK CONSISTS OF STANDARD CHARACTERS WITHOUT CLAIM TO ANY PARTICULAR FONT, STYLE, SIZE, OR COLOR.

NO CLAIM IS MADE TO THE EXCLUSIVE RIGHT TO USE "MOUNTAIN", APART FROM THE MARK AS SHOWN.

FOR CONDUCTING CORPORATE BUSINESS TRAINING RETREATS, AND PROVIDING SEMINARS, WORKSHOPS, CONFERENCES, CLASSES AND PROGRAMS ALL IN THE FIELDS OF BUSINESS MANAGEMENT, LEADERSHIP, MARKETING, PERSONAL DEVELOPMENT, IMPROVEMENT, HEALTH, NUTRITION, BODY CARE AND SKIN CARE (U.S. CLS. 100, 101 AND 107).

MARGERY A. TIERNEY, EXAMINING ATTORNEY

CLASS 41—(Continued).

SN 78-898,503. SIX APART, LTD, SAN FRANCISCO, CA.
FILED 6-1-2006.



THE COLOR(S) WHITE AND BLACK IS/ARE CLAIMED
AS A FEATURE OF THE MARK.

THE MARK CONSISTS OF THE WORD VOX IN WHITE
COLOR INSIDE A BLACK BUBBLE.

FOR PUBLISHING OF ELECTRONIC PUBLICATIONS
(U.S. CLS. 100, 101 AND 107).

DAVID C. REIHNER, EXAMINING ATTORNEY

SN 78-913,843. AGASI, SUZANNE ALSTON, SAN FRANCISCO, CA. FILED 6-21-2006.

Clothing Swap

THE MARK CONSISTS OF STANDARD CHARACTERS
WITHOUT CLAIM TO ANY PARTICULAR FONT, STYLE,
SIZE, OR COLOR.

SEC. 2(F).
FOR SPECIAL EVENT PLANNING (U.S. CLS. 100, 101
AND 107).

FIRST USE 11-1-1996; IN COMMERCE 11-1-1996.
TARAH HARDY, EXAMINING ATTORNEY

SN 78-921,137. KAREN LEON GROSSMAN, DF, MEXICO,
FILED 6-30-2006.

LA CARRERA PANAMERICANA

THE MARK CONSISTS OF STANDARD CHARACTERS
WITHOUT CLAIM TO ANY PARTICULAR FONT, STYLE,
SIZE, OR COLOR.

OWNER OF MEXICO REG. NO. 352641, DATED 5-10-1988,
EXPIRES 5-10-2013.

NO CLAIM IS MADE TO THE EXCLUSIVE RIGHT TO
USE "CARRERA", APART FROM THE MARK AS SHOWN.

THE FOREIGN WORDING IN THE MARK TRANSLATES
INTO ENGLISH AS PANAMERICAN RACE.

SEC. 2(F).
FOR ENTERTAINMENT SERVICES NAMELY, PARTICI-
PATION IN SPORT EVENTS IN THE NATURE OF
CAR RACES (U.S. CLS. 100, 101 AND 107).

FIRST USE 5-10-1988; IN COMMERCE 5-10-1988.
EMILY CHUO, EXAMINING ATTORNEY

CLASS 41—(Continued).

SN 78-922,593. SOVEREIGN DEED, LLC, CHICAGO, IL.
FILED 7-5-2006.

RESCUE

THE MARK CONSISTS OF STANDARD CHARACTERS
WITHOUT CLAIM TO ANY PARTICULAR FONT, STYLE,
SIZE, OR COLOR.

FOR DEVELOPMENT AND DISSEMINATION OF
EDUCATIONAL MATERIALS OF OTHERS IN THE
FIELD OF SECURITY; DIGITAL IMAGING SERVICES;
DISTRIBUTION OF RADIO PROGRAMS FOR OTHERS;
DISTRIBUTION OF TELEVISION PROGRAMS FOR
OTHERS; EDITING OR RECORDING OF SOUNDS
AND IMAGES; INSTRUCTION IN THE FIELD OF
SECURITY; EDUCATION THROUGH CORRESPON-
DENCE COURSES IN THE FIELDS OF SECURITY,
SAFETY, EMERGENCY, MILITARY, MILITARY TAC-
TICS AND STRATEGIES; NEWS ANALYSIS AND FEAT-
URES DISTRIBUTION; NEWS REPORTING SERVICES;
ON-LINE LIBRARY SERVICES, NAMELY, PROVIDING
ELECTRONIC LIBRARY SERVICES WHICH FEATURE
NEWSPAPERS, MAGAZINES, PHOTOGRAPHS AND
PICTURES VIA AN ON-LINE COMPUTER NETWORK;
ON-LINE PUBLICATION OF NEWSPAPERS, MAGA-
ZINES, NEWSLETTERS, BROCHURES, ARTICLES AND
PICTURES; PRODUCTION OF RADIO AND TELEVI-
SION PROGRAMS; PROGRAMMING ON A GLOBAL
COMPUTER NETWORK; PUBLICATION AND EDITING
OF PRINTED MATTER; PUBLISHING OF ELECTRONIC
PUBLICATIONS; PUBLICATION OF BOOKS, MAGA-
ZINES, ALMANACS AND JOURNALS; PUBLICATION
OF ELECTRONIC MAGAZINES; PUBLICATION OF
TEXT BOOK; PUBLISHING OF BOOKS AND REVIEWS
(U.S. CLS. 100, 101 AND 107).

ANNE FARRELL, EXAMINING ATTORNEY

SN 78-923,476. PRESTI, JOSEPH, AUSTIN, TX. FILED 7-6-
2006.

FOR HER AND THE SNOW

THE MARK CONSISTS OF STANDARD CHARACTERS
WITHOUT CLAIM TO ANY PARTICULAR FONT, STYLE,
SIZE, OR COLOR.

FOR ENTERTAINMENT SERVICES, NAMELY, LIVE
PERFORMANCES BY A MUSICAL BAND (U.S. CLS. 100,
101 AND 107).

FIRST USE 5-1-2006; IN COMMERCE 5-1-2006.

DAVID C. REIHNER, EXAMINING ATTORNEY

CLASS 41—(Continued).

SN 78-944,652. 1800 BLK ENTERTAINMENT, LLC, LOS ANGELES, CA. FILED 8-3-2006.

CLASS 41—(Continued).

SN 78-944,667. 1800 BLK ENTERTAINMENT, LLC, LOS ANGELES, CA. FILED 8-3-2006.

1800 BLK ENTERTAINMENT

LIL BOB GOTTI

THE MARK CONSISTS OF STANDARD CHARACTERS WITHOUT CLAIM TO ANY PARTICULAR FONT, STYLE, SIZE, OR COLOR.

NO CLAIM IS MADE TO THE EXCLUSIVE RIGHT TO USE "ENTERTAINMENT", APART FROM THE MARK AS SHOWN.

FOR PRODUCTION OF PRE-RECORDED AUDIO TAPES, COMPACT DISCS, VIDEOTAPES AND DVDS FEATURING MUSIC AND MUSICAL PERFORMANCES; MUSIC PUBLISHING SERVICES; ENTERTAINMENT SERVICES, NAMELY PRODUCTION OF TELEVISION AND RADIO PROGRAMS; DISTRIBUTION OF TELEVISION AND RADIO PROGRAMS FOR OTHERS; PRODUCTION AND DISTRIBUTION OF MOTION PICTURES; PRODUCTION AND DISTRIBUTION OF AUDIO, VIDEO, TEXTUAL AND GRAPHIC CONTENT FOR ENTERTAINMENT PURPOSES FOR WIRELESS DISTRIBUTION VIA TELEPHONY AND THE GLOBAL COMMUNICATION NETWORK; NIGHT CLUBS; EDUCATIONAL SERVICES IN THE FIELD OF MUSIC AND DANCING, NAMELY, DANCE INSTRUCTION, DANCE SCHOOLS, DANCE STUDIOS, TEACHING AND INSTRUCTION IN THE FIELD OF MUSIC AND DANCING; ENTERTAINMENT SERVICES IN THE FIELD OF MUSIC AND DANCING, NAMELY, DANCE EVENTS, DANCE PERFORMANCES, ONLINE ACTIVITY WHERE YOU CREATE YOUR OWN MUSIC VIDEOS, MUSICAL SHOWS; ENTERTAINMENT SERVICES, NAMELY, PROVIDING NON DOWNLOADABLE PRERECORDED MUSIC ONLINE VIA WIRELESS DEVICES, NAMELY, CELL PHONES, PERSONAL DIGITAL ASSISTANTS AND PORTABLE ENTERTAINMENT AND GAMING DEVICES; PROVIDING NON DOWNLOADABLE ONLINE INTERACTIVE GAMES VIA WIRELESS DEVICES, NAMELY, CELL PHONES, PERSONAL DIGITAL ASSISTANTS AND PORTABLE ENTERTAINMENT AND GAMING DEVICES (U.S. CLS. 100, 101 AND 107).

JAY BESCH, EXAMINING ATTORNEY

THE MARK CONSISTS OF STANDARD CHARACTERS WITHOUT CLAIM TO ANY PARTICULAR FONT, STYLE, SIZE, OR COLOR.

THE NAME(S), PORTRAIT(S), AND/OR SIGNATURE(S) SHOWN IN THE MARK IDENTIFIES BOBBY WASHINGTON, WHOSE CONSENT(S) TO REGISTER IS OF RECORD.

FOR ENTERTAINMENT, NAMELY, LIVE MUSIC CONCERTS AND PERFORMANCES BY A MUSICAL GROUP; PRODUCTION OF PRE-RECORDED AUDIO TAPES, COMPACT DISCS, VIDEO TAPES AND DVDS FEATURING MUSIC AND MUSICAL PERFORMANCES; MUSIC PUBLISHING SERVICES; ENTERTAINMENT SERVICES, NAMELY PRODUCTION OF TELEVISION AND RADIO PROGRAMS; DISTRIBUTION OF TELEVISION AND RADIO PROGRAMS FOR OTHERS; PRODUCTION AND DISTRIBUTION OF MOTION PICTURES; PRODUCTION AND DISTRIBUTION OF AUDIO, VIDEO, TEXTUAL AND GRAPHIC CONTENT FOR ENTERTAINMENT PURPOSES FOR WIRELESS DISTRIBUTION VIA TELEPHONY AND THE GLOBAL COMMUNICATION NETWORK; NIGHT CLUBS; EDUCATIONAL SERVICES IN THE FIELD OF MUSIC AND DANCING, NAMELY, DANCE INSTRUCTION, DANCE SCHOOLS, DANCE STUDIOS, TEACHING AND INSTRUCTION IN THE FIELD OF MUSIC AND DANCING; ENTERTAINMENT SERVICES IN THE FIELD OF MUSIC AND DANCING, NAMELY, DANCE EVENTS, DANCE PERFORMANCES, ONLINE ACTIVITY WHERE YOU CREATE YOUR OWN MUSIC VIDEOS, MUSICAL SHOWS; ENTERTAINMENT SERVICES, NAMELY, PROVIDING NON DOWNLOADABLE PRERECORDED MUSIC ONLINE VIA WIRELESS DEVICES, NAMELY, CELL PHONES, PERSONAL DIGITAL ASSISTANTS AND PORTABLE ENTERTAINMENT AND GAMING DEVICES; PROVIDING NON DOWNLOADABLE ONLINE INTERACTIVE GAMES VIA WIRELESS DEVICES, NAMELY, CELL PHONES, PERSONAL DIGITAL ASSISTANTS AND PORTABLE ENTERTAINMENT AND GAMING DEVICES (U.S. CLS. 100, 101 AND 107).

JAY BESCH, EXAMINING ATTORNEY

CLASS 41—(Continued).

SN 78-944,688. 1800 BLK ENTERTAINMENT, LLC, LOS ANGELES, CA. FILED 8-3-2006.

LBG

THE MARK CONSISTS OF STANDARD CHARACTERS WITHOUT CLAIM TO ANY PARTICULAR FONT, STYLE, SIZE, OR COLOR.

THE NAME LBG IDENTIFIES BOBBY WASHINGTON LIVING INDIVIDUAL WHOSE CONSENT IS OF RECORD.

FOR ENTERTAINMENT, NAMELY, LIVE MUSIC CONCERTS AND PERFORMANCES BY A MUSICAL GROUP; PRODUCTION OF PRE-RECORDED AUDIO TAPES, COMPACT DISCS, VIDEO TAPES AND DVDS FEATURING MUSIC AND MUSICAL PERFORMANCES; MUSIC PUBLISHING SERVICES; ENTERTAINMENT SERVICES, NAMELY PRODUCTION OF TELEVISION AND RADIO PROGRAMS; DISTRIBUTION OF TELEVISION AND RADIO PROGRAMS FOR OTHERS; PRODUCTION AND DISTRIBUTION OF MOTION PICTURES; PRODUCTION AND DISTRIBUTION OF AUDIO, VIDEO, TEXTUAL AND GRAPHIC CONTENT FOR ENTERTAINMENT PURPOSES FOR WIRELESS DISTRIBUTION VIA TELEPHONY AND THE GLOBAL COMMUNICATION NETWORK; NIGHT CLUBS; EDUCATIONAL SERVICES IN THE FIELD OF MUSIC AND DANCING, NAMELY, DANCE INSTRUCTION, DANCE SCHOOLS, DANCE STUDIOS, TEACHING AND INSTRUCTION IN THE FIELD OF MUSIC AND DANCING; ENTERTAINMENT SERVICES IN THE FIELD OF MUSIC AND DANCING, NAMELY, DANCE EVENTS, DANCE PERFORMANCES, ONLINE ACTIVITY WHERE YOU CREATE YOUR OWN MUSIC VIDEOS, MUSICAL SHOWS; ENTERTAINMENT SERVICES, NAMELY, PROVIDING NON DOWNLOADABLE PRERECORDED MUSIC ONLINE VIA WIRELESS DEVICES, NAMELY, CELL PHONES, PERSONAL DIGITAL ASSISTANTS AND PORTABLE ENTERTAINMENT AND GAMING DEVICES; PROVIDING NON DOWNLOADABLE ONLINE INTERACTIVE GAMES VIA WIRELESS DEVICES, NAMELY, CELL PHONES, PERSONAL DIGITAL ASSISTANTS AND PORTABLE ENTERTAINMENT AND GAMING DEVICES (U.S. CLS. 100, 101 AND 107).

JAY BESCH, EXAMINING ATTORNEY

CLASS 41—(Continued).

SN 78-944,704. 1800 BLK ENTERTAINMENT, LLC, LOS ANGELES, CA. FILED 8-3-2006.

THA GOTTI BOYZ

THE MARK CONSISTS OF STANDARD CHARACTERS WITHOUT CLAIM TO ANY PARTICULAR FONT, STYLE, SIZE, OR COLOR.

THE NAME(S), PORTRAIT(S), AND/OR SIGNATURE(S) SHOWN IN THE MARK IDENTIFIES BOBBY WASHINGTON, CHRISTOPHER WILLIAMS, GARY BELCHER, AND TIMOTHY RANDOLPH, WHOSE CONSENT(S) TO REGISTER IS OF RECORD.

FOR ENTERTAINMENT, NAMELY, LIVE MUSIC CONCERTS AND PERFORMANCES BY A MUSICAL GROUP; PRODUCTION OF PRE-RECORDED AUDIO TAPES, COMPACT DISCS, VIDEO TAPES AND DVDS FEATURING MUSIC AND MUSICAL PERFORMANCES; MUSIC PUBLISHING SERVICES; ENTERTAINMENT SERVICES, NAMELY, PRODUCTION OF TELEVISION AND RADIO PROGRAMS; DISTRIBUTION OF TELEVISION AND RADIO PROGRAMS FOR OTHERS; PRODUCTION AND DISTRIBUTION OF MOTION PICTURES; PRODUCTION AND DISTRIBUTION OF AUDIO, VIDEO, TEXTUAL AND GRAPHIC CONTENT FOR ENTERTAINMENT PURPOSES FOR WIRELESS DISTRIBUTION VIA TELEPHONY AND THE GLOBAL COMMUNICATION NETWORK; NIGHT CLUBS; EDUCATIONAL SERVICES IN THE FIELD OF MUSIC AND DANCING, NAMELY, DANCE INSTRUCTION, DANCE SCHOOLS, DANCE STUDIOS, TEACHING AND INSTRUCTION IN THE FIELD OF MUSIC AND DANCING; ENTERTAINMENT SERVICES IN THE FIELD OF MUSIC AND DANCING, NAMELY, DANCE EVENTS, DANCE PERFORMANCES, ONLINE ACTIVITY WHERE YOU CREATE YOUR OWN MUSIC VIDEOS, MUSICAL SHOWS; ENTERTAINMENT SERVICES, NAMELY, PROVIDING NON DOWNLOADABLE PRERECORDED MUSIC ONLINE VIA WIRELESS DEVICES, NAMELY, CELL PHONES, PERSONAL DIGITAL ASSISTANTS AND PORTABLE ENTERTAINMENT AND GAMING DEVICES (U.S. CLS. 100, 101 AND 107).

JAY BESCH, EXAMINING ATTORNEY

SN 78-945,941. TONER MATTHEW H, VANCOUVER, CANADA, FILED 8-6-2006.

Zeros 2 Heroes

THE MARK CONSISTS OF STANDARD CHARACTERS WITHOUT CLAIM TO ANY PARTICULAR FONT, STYLE, SIZE, OR COLOR.

SEC. 2(F).

FOR ENTERTAINMENT SERVICES, NAMELY, PROVIDING ONLINE COMICS (U.S. CLS. 100, 101 AND 107). FIRST USE 7-21-2006; IN COMMERCE 7-21-2006.

TANYA AMOS, EXAMINING ATTORNEY

CLASS 41—(Continued).

SN 78-946,948. THE TUTORING CENTER, INC., LONG BEACH, CA. FILED 8-8-2006.

The Tutoring Center

THE MARK CONSISTS OF STANDARD CHARACTERS WITHOUT CLAIM TO ANY PARTICULAR FONT, STYLE, SIZE, OR COLOR.

NO CLAIM IS MADE TO THE EXCLUSIVE RIGHT TO USE "TUTORING", APART FROM THE MARK AS SHOWN. SEC. 2(F).

FOR EDUCATION SERVICES, NAMELY, PROVIDING TUTORIAL SESSIONS IN THE FIELDS OF READING, MATH AND WRITING FOR CHILDREN (U.S. CLS. 100, 101 AND 107).

FIRST USE 6-1-1994; IN COMMERCE 6-1-1994.
JILL C. ALT, EXAMINING ATTORNEY

CLASS 41—(Continued).

SN 78-956,264. READY AND MOTIVATED MINDS, L.L.C., LYNDHURST, NJ. FILED 8-21-2006.

RMING

THE MARK CONSISTS OF STANDARD CHARACTERS WITHOUT CLAIM TO ANY PARTICULAR FONT, STYLE, SIZE, OR COLOR.

FOR EDUCATIONAL SERVICES, NAMELY, CONDUCTING CLASSES, SEMINARS AND WORKSHOPS ONLINE IN THE FIELD OF PERSONAL GROWTH, EDUCATIONAL OPPORTUNITIES AND CAREER COUNSELING AND DISTRIBUTING COURSE MATERIALS IN CONNECTION THEREWITH (U.S. CLS. 100, 101 AND 107).

JOHN DALIER, EXAMINING ATTORNEY

SN 78-951,242. HERNÁNDEZ, PEDRO, CÉSAR DÍAZ, MONTERREY, MEXICO, AND MOLINA, DIONICIO ALAN GALARZA, MONTERREY, MEXICO, AND TORRES, ILSA ELIA RUIZ, MONTERREY, MEXICO, FILED 8-14-2006.

NERV

THE MARK CONSISTS OF STANDARD CHARACTERS WITHOUT CLAIM TO ANY PARTICULAR FONT, STYLE, SIZE, OR COLOR.

OWNER OF MEXICO REG. NO. 916728, DATED 12-1-2005, EXPIRES 12-1-2015.

FOR ENTERTAINMENT SERVICES, NAMELY, PROVIDING LIVE AND RECORDED PERFORMANCES OF ROCK AND ROLL MUSIC BY A MUSICAL BAND OR ENSEMBLE; AND MUSICAL COMPOSITION SERVICES (U.S. CLS. 100, 101 AND 107).

CURTIS FRENCH, EXAMINING ATTORNEY

SN 78-959,016. EXPERT KNOWLEDGE SYSTEMS, LLC, WHITE PLAINS, NY. FILED 8-23-2006.

EKS

THE MARK CONSISTS OF STANDARD CHARACTERS WITHOUT CLAIM TO ANY PARTICULAR FONT, STYLE, SIZE, OR COLOR.

FOR EDUCATION SERVICES, NAMELY, CLASSES AND SEMINARS IN THE FIELD OF MEDICINE, HEALTH, CLINICAL RESEARCH AND PHARMACEUTICAL PREPARATIONS (U.S. CLS. 100, 101 AND 107).

FIRST USE 7-0-1996; IN COMMERCE 7-0-1996.
BONNIE LUKEN, EXAMINING ATTORNEY

SN 78-952,419. BARTH, THOMAS R., GOOSE CREEK, SC. FILED 8-15-2006.

Cranetastrophe

THE MARK CONSISTS OF STANDARD CHARACTERS WITHOUT CLAIM TO ANY PARTICULAR FONT, STYLE, SIZE, OR COLOR.

FOR TRAINING IN THE USE OF CONSTRUCTION, MARITIME AND PORT CRANES (U.S. CLS. 100, 101 AND 107).

FIRST USE 12-31-1997; IN COMMERCE 3-1-1998.
MARK SPARACINO, EXAMINING ATTORNEY

SN 78-960,226. ROCK & REPUBLIC ENTERPRISES, INC., CULVER CITY, CA. FILED 8-25-2006.

ROCK & REPUBLIC

THE MARK CONSISTS OF STANDARD CHARACTERS WITHOUT CLAIM TO ANY PARTICULAR FONT, STYLE, SIZE, OR COLOR.

OWNER OF U.S. REG. NO. 2,700,209.
FOR ENTERTAINMENT IN THE NATURE OF LIVE PERFORMANCES BY A MUSICAL GROUP; ENTERTAINMENT IN THE NATURE OF BICYCLE RACING. (U.S. CLS. 100, 101 AND 107).

LESLEY LAMOTHE, EXAMINING ATTORNEY

CLASS 41—(Continued).

SN 78-960,720. KABBALAH CENTRE INTERNATIONAL, INC., LOS ANGELES, CA. FILED 8-25-2006.

RAISING MALAWI

THE MARK CONSISTS OF STANDARD CHARACTERS WITHOUT CLAIM TO ANY PARTICULAR FONT, STYLE, SIZE, OR COLOR.

SEC. 2(F) AS TO MALAWI.
 FOR CHARITABLE SERVICES, NAMELY, ACADEMIC MENTORING OF SCHOOL AGE CHILDREN; CHARITABLE SERVICES, NAMELY, PROVIDING BOOKS TO THE NEEDY; CHARITABLE SERVICES, NAMELY, PROVIDING SCHOOL SUPPLIES TO CHILDREN IN NEED; CHARITABLE SERVICES, NAMELY, PROVIDING SPORTING GOODS TO UNDERPRIVILEGED CHILDREN; CHARITABLE SERVICES, NAMELY, PROVIDING TOYS TO NEEDY CHILDREN; CHARITABLE SERVICES, NAMELY, PROVIDING TRAINING IN THE FIELD OF EDUCATION (U.S. CLS. 100, 101 AND 107).
 FIRST USE 4-21-2006; IN COMMERCE 4-21-2006.
 PETER B. BROMAGHIM, EXAMINING ATTORNEY

SN 78-960,722. KABBALAH CENTRE INTERNATIONAL, INC., LOS ANGELES, CA. FILED 8-25-2006.

raising malawi

THE MARK CONSISTS OF THE WORDS RAISING MALAWI IN A STYLIZED FORMAT WHERE THE WORD MALAWI IS UNDERLINED.

SEC. 2(F) AS TO MALAWI.
 FOR CHARITABLE SERVICES, NAMELY, ACADEMIC MENTORING OF SCHOOL AGE CHILDREN; CHARITABLE SERVICES, NAMELY, PROVIDING BOOKS TO THE NEEDY; CHARITABLE SERVICES, NAMELY, PROVIDING SCHOOL SUPPLIES TO CHILDREN IN NEED; CHARITABLE SERVICES, NAMELY, PROVIDING SPORTING GOODS TO UNDERPRIVILEGED CHILDREN; CHARITABLE SERVICES, NAMELY, PROVIDING TOYS TO NEEDY CHILDREN; CHARITABLE SERVICES, NAMELY, PROVIDING TRAINING IN THE FIELD OF EDUCATION (U.S. CLS. 100, 101 AND 107).
 FIRST USE 4-21-2006; IN COMMERCE 4-21-2006.
 PETER B. BROMAGHIM, EXAMINING ATTORNEY

CLASS 41—(Continued).

SN 78-960,887. VIACOM INTERNATIONAL INC., NEW YORK, NY. FILED 8-25-2006.

MIS #1s

THE MARK CONSISTS OF STANDARD CHARACTERS WITHOUT CLAIM TO ANY PARTICULAR FONT, STYLE, SIZE, OR COLOR.

"THE FOREIGN WORDING IN THE MARK TRANSLATES INTO ENGLISH AS MY #1S."
 FOR ENTERTAINMENT SERVICES IN THE NATURE OF TELEVISION SERIES, FEATURING LIVE ACTION, COMEDY AND DRAMA; PROVIDING ONLINE INFORMATION IN THE FIELD OF ENTERTAINMENT CONCERNING TELEVISION PROGRAMS (U.S. CLS. 100, 101 AND 107).
 TINA KUAN, EXAMINING ATTORNEY

SN 78-961,007. HOTMOMSCLUB, LLC, SHERMAN OAKS, CA. FILED 8-25-2006.

HOT MOMS

THE MARK CONSISTS OF STANDARD CHARACTERS WITHOUT CLAIM TO ANY PARTICULAR FONT, STYLE, SIZE, OR COLOR.

OWNER OF U.S. REG. NOS. 3,192,944 AND 3,192,974.
 NO CLAIM IS MADE TO THE EXCLUSIVE RIGHT TO USE "MOMS", APART FROM THE MARK AS SHOWN.
 FOR ENTERTAINMENT SERVICES, NAMELY, PROVIDING A TELEVISION PROGRAM IN THE FIELD OF LIFESTYLES FOR MOTHERS VIA A GLOBAL COMPUTER NETWORK; ON-GOING TELEVISION PROGRAMS IN THE FIELD OF NEWS, VARIETY AND REALITY, ON-GOING TELEVISION PROGRAMS IN THE FIELD OF CHILDREN'S ENTERTAINMENT, AND A CONTINUING NEWS, VARIETY AND REALITY SHOW BROADCAST OVER TELEVISION, SATELLITE, AUDIO AND VIDEO MEDIA (U.S. CLS. 100, 101 AND 107).
 JASON BLAIR, EXAMINING ATTORNEY

CLASS 41—(Continued).

SN 78-961,563. NATIONAL BUSINESS TRAVEL ASSOCIATION, INC., ALEXANDRIA, VA. FILED 8-28-2006.

GOVERNMENT TRAVEL EXECUTIVE

THE MARK CONSISTS OF STANDARD CHARACTERS WITHOUT CLAIM TO ANY PARTICULAR FONT, STYLE, SIZE, OR COLOR.

NO CLAIM IS MADE TO THE EXCLUSIVE RIGHT TO USE "GOVERNMENT TRAVEL", APART FROM THE MARK AS SHOWN.

FOR EDUCATIONAL SERVICES, NAMELY, CONDUCTING COURSES, WORKSHOPS AND SEMINARS IN THE FIELD OF GOVERNMENT TRAVEL MANAGEMENT; PREPARING, ADMINISTERING AND SCORING EXAMS IN THE FIELD OF GOVERNMENT TRAVEL MANAGEMENT (U.S. CLS. 100, 101 AND 107).

G. MAYERSCHOFF, EXAMINING ATTORNEY

SN 78-964,707. THE PROFESSIONAL GOLFERS' ASSOCIATION OF AMERICA, PALM BEACH GARDENS, FL. FILED 8-31-2006.

PGA TEAM CHAMPIONSHIP

THE MARK CONSISTS OF STANDARD CHARACTERS WITHOUT CLAIM TO ANY PARTICULAR FONT, STYLE, SIZE, OR COLOR.

OWNER OF U.S. REG. NOS. 578,653, 1,331,309 AND OTHERS.

NO CLAIM IS MADE TO THE EXCLUSIVE RIGHT TO USE "TEAM CHAMPIONSHIP", APART FROM THE MARK AS SHOWN.

FOR ENTERTAINMENT SERVICES, NAMELY, ORGANIZING AND CONDUCTING GOLF TOURNAMENTS (U.S. CLS. 100, 101 AND 107).

DAVID COLLIER, EXAMINING ATTORNEY

SN 78-964,711. THE PROFESSIONAL GOLFERS' ASSOCIATION OF AMERICA, PALM BEACH GARDENS, FL. FILED 8-31-2006.

SENIOR PGA PROFESSIONAL NATIONAL CHAMPIONSHIP

THE MARK CONSISTS OF STANDARD CHARACTERS WITHOUT CLAIM TO ANY PARTICULAR FONT, STYLE, SIZE, OR COLOR.

OWNER OF U.S. REG. NOS. 578,653, 1,331,309 AND OTHERS.

NO CLAIM IS MADE TO THE EXCLUSIVE RIGHT TO USE "SENIOR" AND "PROFESSIONAL NATIONAL CHAMPIONSHIP", APART FROM THE MARK AS SHOWN.

FOR ENTERTAINMENT SERVICES, NAMELY, ORGANIZING AND CONDUCTING GOLF TOURNAMENTS (U.S. CLS. 100, 101 AND 107).

DAVID COLLIER, EXAMINING ATTORNEY

CLASS 41—(Continued).

SN 78-964,712. THE PROFESSIONAL GOLFERS' ASSOCIATION OF AMERICA, PALM BEACH GARDENS, FL. FILED 8-31-2006.

SENIOR PNC

THE MARK CONSISTS OF STANDARD CHARACTERS WITHOUT CLAIM TO ANY PARTICULAR FONT, STYLE, SIZE, OR COLOR.

NO CLAIM IS MADE TO THE EXCLUSIVE RIGHT TO USE "SENIOR", APART FROM THE MARK AS SHOWN.

FOR ENTERTAINMENT SERVICES, NAMELY, ORGANIZING AND CONDUCTING GOLF TOURNAMENTS (U.S. CLS. 100, 101 AND 107).

DAVID COLLIER, EXAMINING ATTORNEY

SN 78-964,718. THE PROFESSIONAL GOLFERS' ASSOCIATION OF AMERICA, PALM BEACH GARDENS, FL. FILED 8-31-2006.

PGA PROFESSIONAL NATIONAL CHAMPIONSHIP

THE MARK CONSISTS OF STANDARD CHARACTERS WITHOUT CLAIM TO ANY PARTICULAR FONT, STYLE, SIZE, OR COLOR.

OWNER OF U.S. REG. NOS. 578,653, 1,331,309 AND OTHERS.

NO CLAIM IS MADE TO THE EXCLUSIVE RIGHT TO USE "PROFESSIONAL NATIONAL CHAMPIONSHIP", APART FROM THE MARK AS SHOWN.

FOR ENTERTAINMENT SERVICES, NAMELY, ORGANIZING AND CONDUCTING GOLF TOURNAMENTS (U.S. CLS. 100, 101 AND 107).

FIRST USE 6-22-2006; IN COMMERCE 6-22-2006.

DAVID COLLIER, EXAMINING ATTORNEY

CLASS 41—(Continued).

SN 78-967,305. DEFENSE INVESTIGATORS ASSOCIATION, SANTA MARIA, CA. FILED 9-5-2006.



NO CLAIM IS MADE TO THE EXCLUSIVE RIGHT TO USE "DEFENSE INVESTIGATOR TRAINING ACADEMY" "CALIFORNIA" AND "EST. 1999", APART FROM THE MARK AS SHOWN.

FOR EDUCATIONAL TRAINING ACADEMY IN THE FIELD OF CRIMINAL DEFENSE INVESTIGATION FOR DEFENSE INVESTIGATORS (U.S. CLS. 100, 101 AND 107).

FIRST USE 1-1-1999; IN COMMERCE 11-10-1999.
JENNIFER MARTIN, EXAMINING ATTORNEY

CLASS 41—(Continued).

SN 78-968,409. MICHAEL CRUCIANO, SEBASTOPOL, CA. FILED 9-6-2006.

STUDY ABROAD ITALY

THE MARK CONSISTS OF STANDARD CHARACTERS WITHOUT CLAIM TO ANY PARTICULAR FONT, STYLE, SIZE, OR COLOR.

OWNER OF U.S. REG. NOS. 2,439,628, 3,182,056 AND OTHERS.

SEC. 2(F).

FOR EDUCATIONAL SERVICES IN THE NATURE OF OF LANGUAGE, CULTURE AND ART SCHOOLS (U.S. CLS. 100, 101 AND 107).

FIRST USE 7-20-1998; IN COMMERCE 7-20-1998.

FLORENTINA BLANDU, EXAMINING ATTORNEY

SN 78-969,299. AJI SOURCE, INC., LOS ALTOS, CA. FILED 9-7-2006.

AJI SOURCE

THE MARK CONSISTS OF STANDARD CHARACTERS WITHOUT CLAIM TO ANY PARTICULAR FONT, STYLE, SIZE, OR COLOR.

NO CLAIM IS MADE TO THE EXCLUSIVE RIGHT TO USE "SOURCE", APART FROM THE MARK AS SHOWN.

"THE ENGLISH TRANSLATION OF THE WORD "AJI" IS "TASTE" OR "PEPPER."

FOR EDUCATIONAL SERVICES FOR INDIVIDUALS AND BUSINESSES, NAMELY, PROVIDING A WEB-BASED INTERACTIVE MULTIMEDIA EDUCATIONAL FORUM FEATURING EDUCATIONAL CONFERENCES, WORKSHOPS AND SEMINARS IN THE FIELDS OF BUSINESS OWNERSHIP, MANAGEMENT, SALES, LEADERSHIP AND ENTREPRENEURSHIP AND DISTRIBUTING COURSE MATERIAL THEREWITH IN THE NATURE OF WRITTEN ARTICLES AND ASSIGNMENTS; EDUCATIONAL SERVICES FOR INDIVIDUALS AND BUSINESSES, NAMELY, PROVIDING A WEBSITE FEATURING AUDIO AND VISUAL PRESENTATIONS AND WRITTEN TEXTS IN THE FIELDS OF BUSINESS OWNERSHIP, MANAGEMENT, SALES, LEADERSHIP AND ENTREPRENEURSHIP (U.S. CLS. 100, 101 AND 107).

FIRST USE 8-19-2005; IN COMMERCE 10-23-2005.

DAVID YONTEF, EXAMINING ATTORNEY

SN 78-968,343. ROCKFORD INTERNATIONAL PROFESSIONAL SOCCER, LLC, WOODSTOCK, IL. FILED 9-6-2006.

ROCKFORD THUNDER

THE MARK CONSISTS OF STANDARD CHARACTERS WITHOUT CLAIM TO ANY PARTICULAR FONT, STYLE, SIZE, OR COLOR.

NO CLAIM IS MADE TO THE EXCLUSIVE RIGHT TO USE "ROCKFORD", APART FROM THE MARK AS SHOWN.

FOR ENTERTAINMENT IN THE NATURE OF ORGANIZING, CONDUCTING AND STAGING PROFESSIONAL SOCCER GAMES AND EXHIBITIONS; PROVIDING A WEBSITE FEATURING SOCCER AND SOCCER-RELATED INFORMATION; PRODUCTION OF RADIO AND TELEVISION PROGRAMS IN THE NATURE OF PROFESSIONAL SOCCER GAMES AND EXHIBITIONS (U.S. CLS. 100, 101 AND 107).

FIRST USE 12-31-2005; IN COMMERCE 3-31-2006.

JORDAN BAKER, EXAMINING ATTORNEY

CLASS 41—(Continued).

SN 78-969,840. PHILLIPS, BRIAN M., FORT WORTH, TX. FILED 9-8-2006.

THE DAILY CAN

THE MARK CONSISTS OF STANDARD CHARACTERS WITHOUT CLAIM TO ANY PARTICULAR FONT, STYLE, SIZE, OR COLOR.

NO CLAIM IS MADE TO THE EXCLUSIVE RIGHT TO USE "DAILY", APART FROM THE MARK AS SHOWN.

FOR EDUCATION AND ENTERTAINMENT SERVICES, NAMELY, PROVIDING A WEBSITE FEATURING GENERAL NEWS, EDUCATIONAL, ENTERTAINMENT AND INFORMATIONAL ARTICLES, COMMENTARY AND ILLUSTRATIONS CONCERNING SPORTS AND OUTDOORS, FOOD, CULTURE, ART, MUSIC, THEATER, SOCIOLOGY, HISTORY, LANGUAGE ARTS, HUMOR, AND CURRENT EVENTS VIA THE INTERNET (U.S. CLS. 100, 101 AND 107).

FIRST USE 8-2-2006; IN COMMERCE 8-2-2006.
INGRID C. EULIN, EXAMINING ATTORNEY

SN 78-969,909. MEDED RESOURCES, LLC, ELLICOTT CITY, MD. FILED 9-8-2006.

QUEST MEDED

THE MARK CONSISTS OF STANDARD CHARACTERS WITHOUT CLAIM TO ANY PARTICULAR FONT, STYLE, SIZE, OR COLOR.

NO CLAIM IS MADE TO THE EXCLUSIVE RIGHT TO USE "MED ED", APART FROM THE MARK AS SHOWN.

FOR PROVIDING CONTINUING MEDICAL EDUCATION COURSES FOR HEALTHCARE PROFESSIONALS; EDUCATION SERVICES, NAMELY, CONDUCTING PROGRAMS IN THE FIELD OF QUALITY IMPROVEMENT IN HEALTHCARE (U.S. CLS. 100, 101 AND 107).
ADA HAN, EXAMINING ATTORNEY

SN 78-970,067. KENT, RICK L., ROSWELL, GA. FILED 9-8-2006.

MERIT ADVANTAGE

THE MARK CONSISTS OF STANDARD CHARACTERS WITHOUT CLAIM TO ANY PARTICULAR FONT, STYLE, SIZE, OR COLOR.

FOR EDUCATIONAL SERVICES, NAMELY, CLASSES, WORKSHOPS AND SEMINARS IN THE FIELD OF FINANCIAL PLANNING AND RETIREMENT BENEFITS (U.S. CLS. 100, 101 AND 107).

FIRST USE 7-2-2004; IN COMMERCE 12-3-2004.
KEVON CHISOLM, EXAMINING ATTORNEY

CLASS 41—(Continued).

SN 78-970,198. THE AMERICAN ACADEMY OF HEALTH BEHAVIOR, INC., COLLEGE PARK, MD. FILED 9-8-2006.

AMERICAN ACADEMY OF HEALTH BEHAVIOR

THE MARK CONSISTS OF STANDARD CHARACTERS WITHOUT CLAIM TO ANY PARTICULAR FONT, STYLE, SIZE, OR COLOR.

NO CLAIM IS MADE TO THE EXCLUSIVE RIGHT TO USE "ACADEMY", APART FROM THE MARK AS SHOWN. SEC. 2(F).

FOR EDUCATIONAL SERVICES, NAMELY, CONDUCTING SEMINARS, WORKSHOPS, CONFERENCES, MEETINGS, AND CLINICS IN THE FIELD OF HEALTH BEHAVIOR AND DISTRIBUTION OF COURSE MATERIAL IN CONNECTION THEREWITH; PUBLISHING OF EDUCATIONAL PRINTED MATTER IN THE FIELD OF HEALTH BEHAVIOR (U.S. CLS. 100, 101 AND 107).

FIRST USE 7-1-1997; IN COMMERCE 7-1-1997.
JILL C. ALT, EXAMINING ATTORNEY

SN 78-971,200. MEDICAL KNOWLEDGE GROUP LLC, NEW YORK, NY. FILED 9-11-2006.



NO CLAIM IS MADE TO THE EXCLUSIVE RIGHT TO USE "EDUCATIONAL NETWORK OF HEAD AND NECK CANCER EXPERTS", APART FROM THE MARK AS SHOWN.

FOR PROVIDING CONTINUING MEDICAL EDUCATION COURSES AND COURSE MATERIALS THEREWITH (U.S. CLS. 100, 101 AND 107).

FIRST USE 3-0-2006; IN COMMERCE 3-0-2006.
KAREN SEVERSON, EXAMINING ATTORNEY

SN 78-971,543. ONCOLOGY TODAY, L.P., HOUSTON, TX. FILED 9-11-2006.



NO CLAIM IS MADE TO THE EXCLUSIVE RIGHT TO USE "ONCOLOGY", APART FROM THE MARK AS SHOWN.

FOR CONDUCTING LIVE AND WEB-BASED SEMINARS AND EDUCATIONAL PROGRAMS IN THE FIELDS OF ONCOLOGY AND HEMATOLOGY AND ISSUES RELATED TO THE DIAGNOSIS, TREATMENT AND MANAGEMENT OF HEMATOLOGY AND ONCOLOGY AND RELATED CONDITIONS; ONLINE PUBLICATION OF INFORMATION IN THE FORM OF NEWLETTERS, BROCHURES, MONOGRAPHS AND SEMINAR MATERIALS AND OUTLINES IN THE FIELDS OF ONCOLOGY AND HEMATOLOGY AND ISSUES RELATED TO THE DIAGNOSIS, TREATMENT AND MANAGEMENT OF HEMATOLOGY AND ONCOLOGY AND RELATED CONDITIONS (U.S. CLS. 100, 101 AND 107).

KEVIN DINALLO, EXAMINING ATTORNEY

CLASS 41—(Continued).

SN 79-013,802. RED BULL GMBH, A-5330 FUSCHL AM SEE, AUSTRIA, FILED 4-28-2005.

TAURUS RUBENS

THE MARK CONSISTS OF STANDARD CHARACTERS WITHOUT CLAIM TO ANY PARTICULAR FONT, STYLE, SIZE, OR COLOR.

PRIORITY DATE OF 3-21-2005 IS CLAIMED.

OWNER OF INTERNATIONAL REGISTRATION 0857762 DATED 4-28-2005, EXPIRES 4-28-2015.

THE FOREIGN WORDING IN THE MARK TRANSLATES INTO ENGLISH AS RED BULL.

FOR EDUCATION SERVICES, NAMELY, PROVIDING, ARRANGING AND CONDUCTING SEMINARS, CLASSES, COURSES, CONFERENCES AND WORKSHOPS IN THE FIELD OF THEATER AND FLYING THEATER PERFORMANCES, AIRBORNE SHOWS AND MUSICAL ENTERTAINMENT; PROVIDING TRAINING IN THE FIELD OF THEATER AND FLYING THEATER PERFORMANCES, AIRBORNE SHOWS AND MUSICAL ENTERTAINMENT; ORGANIZING, CONDUCTING, STAGING AND PROVIDING FACILITIES FOR THEATER AND FLYING THEATER PERFORMANCES, AND FOR AIR SPORTS COMPETITIONS AND EXHIBITIONS; ENTERTAINMENT, NAMELY THEATER PERFORMANCES, FLYING THEATER PERFORMANCES, AIRBORNE SHOWS, MUSICAL PERFORMANCES AND MUSICAL ENTERTAINMENT; THEATER PRODUCTIONS; ENTERTAINMENT SERVICES, NAMELY, PRODUCTION OF LIVE PERFORMANCES, SHOWS, EXHIBITIONS, STAGE SHOWS, EVENTS AND MUSICALS; PRODUCTION AND PROVIDING OF RADIO AND TELEVISION ENTERTAINMENT PROGRAMS; SPORTING AND CULTURAL ACTIVITIES, NAMELY, THE STAGING OF AIR SPORTS COMPETITIONS; NIGHT CLUBS AND DISCOTHEQUE SERVICES; VIDEO TAPE FILM PRODUCTION; ELECTRONIC DESKTOP PUBLISHING, PUBLISHING OF ELECTRONIC PUBLICATIONS; ENTERTAINMENT SERVICES, NAMELY, PROVIDING ON-LINE COMPUTER GAMES; CONDUCTING ENTERTAINMENT EXHIBITIONS IN THE NATURE OF THEATER AND FLYING THEATER PERFORMANCES, AIRBORNE SHOWS AND MUSICAL ENTERTAINMENT (U.S. CLS. 100, 101 AND 107).

ALLISON HOLTZ, EXAMINING ATTORNEY

SN 79-025,619. ONGAME E-SOLUTIONS AB, SWEDEN, FILED 1-31-2006.

**CasinoRoom.com**

PRIORITY DATE OF 12-8-2005 IS CLAIMED.

OWNER OF INTERNATIONAL REGISTRATION 0889691 DATED 1-31-2006, EXPIRES 1-31-2016.

OWNER OF U.S. REG. NO. 3,165,444.

NO CLAIM IS MADE TO THE EXCLUSIVE RIGHT TO USE "CASINOROOM.COM", APART FROM THE MARK AS SHOWN.

FOR ENTERTAINMENT SERVICES, NAMELY PROVIDING ON-LINE POKER GAMES (U.S. CLS. 100, 101 AND 107).

DANIEL RUSSELL, EXAMINING ATTORNEY

CLASS 41—(Continued).

SN 79-029,037. REDLAUNCH PTY LTD, AUSTRALIA, FILED 7-27-2006.

Redlaunch

THE MARK CONSISTS OF STANDARD CHARACTERS WITHOUT CLAIM TO ANY PARTICULAR FONT, STYLE, SIZE, OR COLOR.

OWNER OF INTERNATIONAL REGISTRATION 0898859 DATED 7-27-2006, EXPIRES 7-27-2016.

FOR DESIGN AND DEVELOPMENT OF TRAINING AND EDUCATIONAL PROGRAMS TO MEET BUSINESS GOALS AND QUALIFICATIONS AND STANDARDS REQUIREMENTS (U.S. CLS. 100, 101 AND 107).

PAUL F. GAST, EXAMINING ATTORNEY

SN 79-035,243. ABC COOKING STUDIO CO., LTD., TOKYO, JAPAN, FILED 12-25-2006.



OWNER OF INTERNATIONAL REGISTRATION 0915556 DATED 12-25-2006, EXPIRES 12-25-2016.

OWNER OF U.S. REG. NO. 3,233,639.

NO CLAIM IS MADE TO THE EXCLUSIVE RIGHT TO USE "COOKING STUDIO", APART FROM THE MARK AS SHOWN.

THE COLOR(S) BLACK AND GREEN IS/ARE CLAIMED AS A FEATURE OF THE MARK.

THE COLOR GREEN IN THE MARK APPEARS IN THE WORDING "ABC" AND THE COLOR BLACK IN THE MARK APPEARS IN THE WORDING "COOKING STUDIO" AND IN THE DESIGN OF THE TWO HORIZONTAL LINES ABOVE AND BELOW THE TERM "COOKING STUDIO".

FOR PROVIDING COURSES IN THE FIELD OF COOKING (U.S. CLS. 100, 101 AND 107).

GIANCARLO CASTRO, EXAMINING ATTORNEY

CLASS 42—SCIENTIFIC AND COMPUTER SERVICES

SN 76-650,216. PRALAYA SOFTWARE SOLUTIONS, INC., SUNNYVALE, CA. FILED 11-14-2005.

PRALAYA

THE MARK CONSISTS OF STANDARD CHARACTERS WITHOUT CLAIM TO ANY PARTICULAR FONT, STYLE, SIZE, OR COLOR.

FOR TECHNICAL CONSULTATION SERVICES IN THE FIELD OF AEROSPACE ENGINEERING, AND THE DESIGN, CREATION, HOSTING AND MANAGEMENT OF INTERNET SITES FOR THIRD PARTIES (U.S. CLS. 100 AND 101).

FIRST USE 1-30-2002; IN COMMERCE 1-30-2002.
JERI J. FICKES, EXAMINING ATTORNEY

CLASS 42—(Continued).

SN 76-670,525. WHITE BADGER GROUP, INC., SINKING SPRING, PA. FILED 12-15-2006.



**WHITE BADGER
GROUP INC**

NO CLAIM IS MADE TO THE EXCLUSIVE RIGHT TO USE "GROUP INC", APART FROM THE MARK AS SHOWN. THE COLOR(S) BLACK, WHITE AND RED IS/ARE CLAIMED AS A FEATURE OF THE MARK.

THE MARK CONSIST OF A DRAWING OF A WHITE BADGER WITH RED EYES ON A BLACK BACKGROUND WITH WHITE BADGER GROUP, INC. PRINTED UNDERNEATH.

FOR COMPUTER SERVICES IN THE NATURE OF CONSULTATION IN THE FIELD OF COMPUTER SECURITY (U.S. CLS. 100 AND 101).

FIRST USE 5-1-2006; IN COMMERCE 5-1-2006.
FLORENTINA BLANDU, EXAMINING ATTORNEY

SN 76-669,249. TAGUE DESIGN ASSOCIATES, INC, BRONXVILLE, NY. FILED 11-20-2006.

CORE HOME

THE MARK CONSISTS OF STANDARD CHARACTERS WITHOUT CLAIM TO ANY PARTICULAR FONT, STYLE, SIZE, OR COLOR.

NO CLAIM IS MADE TO THE EXCLUSIVE RIGHT TO USE "HOME", APART FROM THE MARK AS SHOWN.

FOR ARCHITECTURAL SERVICES, NAMELY, GREEN HOUSE DESIGN AND INTERIOR DESIGN SERVICES FOR GREEN HOUSES (U.S. CLS. 100 AND 101).

CAROLYN GRAY, EXAMINING ATTORNEY

SN 76-673,290. FORT WORTH ENERGY COMPANY, LLC, FORT WORTH, TX. FILED 2-27-2007.



NO CLAIM IS MADE TO THE EXCLUSIVE RIGHT TO USE "FORT WORTH ENERGY", APART FROM THE MARK AS SHOWN.

FOR OIL AND GAS EXPLORATION SERVICES (U.S. CLS. 100 AND 101).

ZACHARY BELLO, EXAMINING ATTORNEY

CLASS 42—(Continued).

SN 76-674,876. EVERTON OGLESBY ARCHITECTS PLLC, NASHVILLE, TN. FILED 3-29-2007.

HUMANIZING DESIGN

THE MARK CONSISTS OF STANDARD CHARACTERS WITHOUT CLAIM TO ANY PARTICULAR FONT, STYLE, SIZE, OR COLOR.

NO CLAIM IS MADE TO THE EXCLUSIVE RIGHT TO USE "DESIGN", APART FROM THE MARK AS SHOWN.

FOR ARCHITECTURAL DESIGN AND PLANNING SERVICES; BUILDING DESIGN, PLANNING OF BUILDINGS AND INFRASTRUCTURE SYSTEMS FOR BUILDINGS SERVICES; CONSTRUCTION DESIGN SERVICES; AND LAND USE DESIGN AND PLANNING SERVICES (U.S. CLS. 100 AND 101).

FIRST USE 7-1-2004; IN COMMERCE 7-1-2004.
SUE LAWRENCE, EXAMINING ATTORNEY

SN 76-675,673. PICTORIA STUDIOS USA, INC., ORLANDO, FL. FILED 4-18-2007.

PICTORIA

THE MARK CONSISTS OF STANDARD CHARACTERS WITHOUT CLAIM TO ANY PARTICULAR FONT, STYLE, SIZE, OR COLOR.

FOR PROVIDING 3D RENDERINGS OF ARCHITECTURAL DRAWINGS AND ANIMATION DESIGN SERVICES (U.S. CLS. 100 AND 101).

FIRST USE 1-1-2007; IN COMMERCE 1-1-2007.
MARGERY A. TIERNEY, EXAMINING ATTORNEY

SN 76-675,687. PICTORIA STUDIOS USA, INC., ORLANDO, FL. FILED 4-18-2007.

WE MAKE THE "UNREAL" REAL

THE MARK CONSISTS OF STANDARD CHARACTERS WITHOUT CLAIM TO ANY PARTICULAR FONT, STYLE, SIZE, OR COLOR.

FOR PROVIDING 3D RENDERINGS OF ARCHITECTURAL DRAWINGS AND ANIMATION DESIGN SERVICES (U.S. CLS. 100 AND 101).

FIRST USE 1-1-2007; IN COMMERCE 1-1-2007.
MARGERY A. TIERNEY, EXAMINING ATTORNEY

CLASS 42—(Continued).

SN 76-677,655. TELLIGENT SYSTEMS, INC., DALLAS, TX. FILED 5-31-2007.



OWNER OF U.S. REG. NO. 3,085,918.

THE COLOR(S) BLUE AND BLACK IS/ARE CLAIMED AS A FEATURE OF THE MARK.

THE MARK CONSISTS OF ARROW IN VARYING SHADES OF DARK BLUE TO LIGHT BLUE FOLLOWED BY THE TERM TELLIGENT IN BLACK.

FOR TECHNOLOGY CONSULTING SERVICES, NAMELY THE DEVELOPMENT OF COMPUTER SOFTWARE PROGRAMS, FOR CONSUMER AND BUSINESS ENTERPRISES (U.S. CLS. 100 AND 101).

FIRST USE 6-1-2004; IN COMMERCE 6-1-2004.
KAREN K. BUSH, EXAMINING ATTORNEY

SN 77-000,358. MARPORT CANADA INC., CONCEPTION BAY SOUTH, NEW FOUNDLAND, CANADA, FILED 9-15-2006.

MARPORT

THE MARK CONSISTS OF STANDARD CHARACTERS WITHOUT CLAIM TO ANY PARTICULAR FONT, STYLE, SIZE, OR COLOR.

FOR DESIGN AND DEVELOPMENT OF DEEP SEA ACOUSTIC PRODUCTS USED FOR UNDERWATER SENSING, PROCESSING AND COMMUNICATION APPLICATIONS (U.S. CLS. 100 AND 101).

FIRST USE 7-15-2003; IN COMMERCE 7-15-2003.
ROBERT LAVACHE, EXAMINING ATTORNEY

SN 77-001,751. THE WHITEHALL GROUP, LLC., WASHINGTON, DC. FILED 9-18-2006.

EvacuTrack

THE MARK CONSISTS OF STANDARD CHARACTERS WITHOUT CLAIM TO ANY PARTICULAR FONT, STYLE, SIZE, OR COLOR.

FOR COMPUTER SERVICE, NAMELY, ACTING AS AN APPLICATION SERVICE PROVIDER IN THE FIELD OF KNOWLEDGE MANAGEMENT TO HOST COMPUTER APPLICATION SOFTWARE FOR SEARCHING AND RETRIEVING INFORMATION FROM DATABASES AND COMPUTER NETWORKS (U.S. CLS. 100 AND 101).

FIRST USE 6-1-2006; IN COMMERCE 6-1-2006.
NAPOLEON SHARMA, EXAMINING ATTORNEY

CLASS 42—(Continued).

SN 77-010,960. AQUATIC DESIGN GROUP, INC., CARLSBAD, CA. FILED 9-29-2006.



NO CLAIM IS MADE TO THE EXCLUSIVE RIGHT TO USE "AQUATIC DESIGN GROUP", APART FROM THE MARK AS SHOWN.

THE MARK CONSISTS OF AN ABSTRACT DESIGN WITH STYLIZED TEXT OF THE WORDS, "AQUATIC DESIGN GROUP".

FOR ARCHITECTURAL DESIGN; ENGINEERING (U.S. CLS. 100 AND 101).

FIRST USE 1-1-1986; IN COMMERCE 1-1-1986.

LEIGH CAROLINE CASE, EXAMINING ATTORNEY

CLASS 42—(Continued).

SN 77-016,480. XLLERATE CONSULTING, LLC, GARLAND, TX. FILED 10-8-2006.



THE MARK CONSISTS OF A STYLIZED VERSION OF THE WORD XLLERATE.

FOR COMPUTER SOFTWARE DESIGN, DEVELOPMENT, CUSTOMIZATION, CONSULTING, MAINTENANCE AND TECHNICAL SUPPORT SERVICES FOR OTHERS, AND CONSULTING ON SELECTION AND INTEGRATION OF COMPUTER HARDWARE AND SOFTWARE, IN THE FIELDS OF AUTOMATING MANUAL BUSINESS PRACTICES, DOCUMENTING BUSINESS PROCESSES, MANAGING AND INTEGRATING DATABASES, PROVIDING STATISTICAL ANALYSES, NOTIFICATIONS AND REPORTS, AND PROVIDING REAL-TIME, INTEGRATED BUSINESS MANAGEMENT TOOLS; CONSULTATION SERVICES IN THE FIELD OF OFFICE AND WORKPLACE AUTOMATION (U.S. CLS. 100 AND 101).

BRENDAN REGAN, EXAMINING ATTORNEY

SN 77-016,289. JMBP, INC., LOS ANGELES, CA. FILED 10-6-2006.



THE COLOR(S) LIGHT GOLD, DARK GOLD AND BLACK IS/ARE CLAIMED AS A FEATURE OF THE MARK. THE MARK CONSISTS OF A LIGHT GOLD THREE DIMENSIONAL IMAGE OF A BAR ON WHICH THE WORDS 'GOLD RUSH' ARE INSCRIBED IN DARK GOLD; THE COLOR BLACK APPEARS AS OUTLINING AROUND THE OUTSIDE OF EACH LETTER OF THE WORDS 'GOLD RUSH'.

FOR COMPUTER SERVICES, NAMELY, CREATING AN ONLINE COMMUNITY FOR USERS TO PARTICIPATE IN COMPETITIONS (U.S. CLS. 100 AND 101).

REBECCA EISINGER, EXAMINING ATTORNEY

SN 77-021,098. FUTURE MERCHANTS, LLC, NEW YORK, NY. FILED 10-13-2006.

FUTURE MERCHANTS

THE MARK CONSISTS OF STANDARD CHARACTERS WITHOUT CLAIM TO ANY PARTICULAR FONT, STYLE, SIZE, OR COLOR.

FOR BUILDING AND CREATING INTERACTIVE WEBSITES AND ONLINE RETAIL SALES PORTALS POPULATED WITH PROPRIETARY SALES-ORIENTED VIDEO CONTENT, FOR OTHERS (U.S. CLS. 100 AND 101).

ESTHER BELENKER, EXAMINING ATTORNEY

CLASS 42—(Continued).

SN 77-034,302. AEROTEK, INC., HANOVER, MD. FILED 11-1-2006.

EASI

THE MARK CONSISTS OF STANDARD CHARACTERS WITHOUT CLAIM TO ANY PARTICULAR FONT, STYLE, SIZE, OR COLOR.

FOR ENGINEERING SERVICES, NAMELY, ENGINEERING FOR THE AUTOMOTIVE INDUSTRY; TECHNOLOGY CONSULTATION IN THE FIELD OF AUTOMOTIVE DESIGN, SPECIFICALLY, PROVIDING CONSULTATION REGARDING TECHNOLOGY USED IN RELATION TO VERIFICATION AND VALIDATION FOR STRENGTH, NOISE, VIBRATION, AND MANUFACTURING PROCESSES, AND CRASHWORTHINESS, SAFETY, AND OCCUPANT PROTECTION (U.S. CLS. 100 AND 101).

FIRST USE 12-1-1981; IN COMMERCE 12-1-1981.
MARTHA FROMM, EXAMINING ATTORNEY

SN 77-036,033. ATGC LABS, LLC, ROCKVILLE, MD. FILED 11-3-2006.

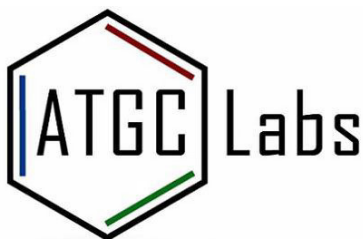

NO CLAIM IS MADE TO THE EXCLUSIVE RIGHT TO USE "LABS", APART FROM THE MARK AS SHOWN.

THE COLOR(S) RED, GREEN, VIOLET, BLACK AND WHITE IS/ARE CLAIMED AS A FEATURE OF THE MARK.

THE MARK CONSISTS OF THE COLORS RED, GREEN, AND VIOLET, APPEARING AS LINES INSIDE THE HEXAGON, RED IN UPPER-RIGHT, GREEN AT LOWER-RIGHT AND VIOLET AT LEFT SIDE; THE COLOR BLACK APPEARS AS THE AN OUTLINE FOR THE HEXAGON, INSIDE OF THE HEXAGON IN THE WORDING "ATGC", AND OUTSIDE OF THE HEXAGON (RIGHT SIDE) IN THE WORDING "LABS"; THE COLOR WHITE APPEARS AS BACKGROUND.

FOR COMPUTER SOFTWARE DEVELOPMENT; CONSULTING SERVICES IN THE FIELD OF DESIGN, SELECTION, IMPLEMENTATION AND USE OF COMPUTER HARDWARE AND SOFTWARE SYSTEMS FOR OTHERS (U.S. CLS. 100 AND 101).

FIRST USE 9-1-2004; IN COMMERCE 11-1-2006.
ADA HAN, EXAMINING ATTORNEY

CLASS 42—(Continued).

SN 77-045,543. MUZE, INC., NEW YORK, NY. FILED 11-16-2006.

MediaDNA

THE MARK CONSISTS OF STANDARD CHARACTERS WITHOUT CLAIM TO ANY PARTICULAR FONT, STYLE, SIZE, OR COLOR.

OWNER OF U.S. REG. NOS. 1,758,885, 2,955,328 AND OTHERS.

FOR APPLICATION SERVICE PROVIDER FEATURING SOFTWARE TO ENABLE USERS TO DOWNLOAD, TRANSMIT, RECEIVE, PLAY, STORE, AND ORGANIZE CONTENT AND DATA FOR INTERNET-BASED AND WIRELESS PURCHASE, SALE, AND USE OF ART, EDUCATION, OR ENTERTAINMENT-RELATED CONTENT AND DATA (U.S. CLS. 100 AND 101).

BARBARA GAYNOR, EXAMINING ATTORNEY

SN 77-046,214. CHAPTER97 LLC, MIDDLE HADDAM, CT. FILED 11-17-2006.

LITTLECHAPTERS

THE MARK CONSISTS OF STYLIZED TEXT FOR PHRASE LITTLECHAPTERS.

FOR COMPUTER SERVICES IN THE NATURE OF CUSTOMIZED WEB PAGES FEATURING USER-DEFINED INFORMATION, PERSONAL PROFILES AND INFORMATION (U.S. CLS. 100 AND 101).

FIRST USE 6-1-2006; IN COMMERCE 10-1-2006.

WENDY JUN, EXAMINING ATTORNEY

SN 77-054,536. COLLEGENET, INC., PORTLAND, OR. FILED 11-30-2006.

IT PAYS TO THINK

THE MARK CONSISTS OF STANDARD CHARACTERS WITHOUT CLAIM TO ANY PARTICULAR FONT, STYLE, SIZE, OR COLOR.

FOR COMPUTER SERVICES, NAMELY, HOSTING ON-LINE WEB FACILITIES FOR OTHERS FOR INTERACTIVE DISCUSSIONS (U.S. CLS. 100 AND 101).

PATRICIA EVANKO, EXAMINING ATTORNEY

CLASS 42—(Continued).

SN 77-054,574. ADAMS, DONALD MACK, CONNELLY SPRINGS, NC. FILED 11-30-2006.

uCanKnow

THE MARK CONSISTS OF STANDARD CHARACTERS WITHOUT CLAIM TO ANY PARTICULAR FONT, STYLE, SIZE, OR COLOR.

FOR MACHINE TESTING AND EVALUATION SERVICES IN THE FIELD OF INSTITUTIONAL AND PROCESS MANUFACTURING (U.S. CLS. 100 AND 101).
CHRISTOPHER OTT, EXAMINING ATTORNEY

SN 77-059,203. WATCH SYSTEMS, LLC, COVINGTON, LA. FILED 12-7-2006.



NO CLAIM IS MADE TO THE EXCLUSIVE RIGHT TO USE "OFFENDER WATCH", APART FROM THE MARK AS SHOWN.

THE MARK CONSISTS OF STYLIZED WORDS "OFFENDER", AND "WATCH" IN DIFFERENT FONTS, WITH MIRROR IMAGE BELOW; SYMBOLIC EYE AND EYEBROW ABOVE THE WORD "WATCH"; AND MEANDERING STRIPE BELOW THE WORD "OFFENDER".

FOR COMPUTER SERVICE, NAMELY, ACTING AS AN APPLICATION SERVICE PROVIDER TO HOST COMPUTER APPLICATION SOFTWARE FOR THE REGISTRATION, MONITORING, LOCATING, NOTIFICATION AND SHARING OF DATA AND INFORMATION REGARDING INDIVIDUALS CONVICTED OF SEX CRIMES (U.S. CLS. 100 AND 101).

FIRST USE 6-1-2003; IN COMMERCE 6-1-2003.
DARRYL SPRUILL, EXAMINING ATTORNEY

CLASS 42—(Continued).

SN 77-061,788. COLLEGENET, INC., PORTLAND, OR. FILED 12-11-2006.

IT IMPACT

THE MARK CONSISTS OF STANDARD CHARACTERS WITHOUT CLAIM TO ANY PARTICULAR FONT, STYLE, SIZE, OR COLOR.

NO CLAIM IS MADE TO THE EXCLUSIVE RIGHT TO USE "IT", APART FROM THE MARK AS SHOWN.

FOR COMPUTER PROGRAMMING FOR OTHERS; COMPUTER SERVICES NAMELY APPLICATION SERVICE PROVIDER FEATURING ACCESS TO AN INTERACTIVE COMPUTER DATABASE AND ON-LINE SOFTWARE TOOLS USED TO ASSESS, PLAN, RECORD, COMMUNICATE, AND AUDIT CHANGES IN INFORMATION TECHNOLOGY INFRASTRUCTURE; APPLICATION SERVICE PROVIDER SERVICES FEATURING SOFTWARE TOOLS FOR ON-LINE ACTIVITIES, NAMELY, TOOLS USED TO MANAGE, ASSESS, PLAN FOR AND AUDIT ENTERPRISE INFORMATION TECHNOLOGY CHANGE BY BUSINESSES AND EDUCATIONAL INSTITUTIONS (U.S. CLS. 100 AND 101).
PATRICIA EVANKO, EXAMINING ATTORNEY

SN 77-071,572. OFFSITE BACKUP SOLUTIONS, LLC, MESA, AZ. FILED 12-27-2006.



NO CLAIM IS MADE TO THE EXCLUSIVE RIGHT TO USE "OFFSITE BACKUP SOLUTIONS", APART FROM THE MARK AS SHOWN.

THE MARK CONSISTS OF A WINDOW WITH A COMPUTER AND A LAPTOP WITH THE WORDS OFFSITE BACKUP SOLUTIONS.

FOR ONLINE COMPUTER NETWORKING SERVICES, NAMELY, PROVIDING BACK-UP COMPUTER PROGRAMS AND FACILITIES; COMPUTER SERVICES, NAMELY, DATA RECOVERY SERVICES VIA A GLOBAL COMPUTER NETWORK; INSTALLATION OF COMPUTER SOFTWARE; TECHNICAL SUPPORT SERVICES, NAMELY, TROUBLESHOOTING OF COMPUTER SOFTWARE PROBLEMS (U.S. CLS. 100 AND 101).

FIRST USE 11-1-2005; IN COMMERCE 11-1-2005.
BRIAN CALLAGHAN, EXAMINING ATTORNEY

CLASS 42—(Continued).

SN 77-072,796. PHARMACEUTICAL SERVICES CORPORATION, PASADENA, CA. FILED 12-28-2006.



THE COLOR(S) BLUE, GREEN, WHITE AND GRAY IS/ARE CLAIMED AS A FEATURE OF THE MARK.

THE MARK CONSISTS OF A CAPITALIZED, STYLIZED LETTER P IN DARK BLUE, WITH A WHITE ERLLENMEYER FLASK CUTTING THROUGH THE TOP OF LETTER P AND A RING IN GRAY SURROUNDING THE LETTER P ON THE LEFT SIDE, AND TWO STARS IN LIGHT BLUE AND GREEN ARE DISPLAYED ON THE RIGHT SIDE.

FOR TECHNICAL CONSULTING SERVICES IN THE FIELDS OF PHARMACEUTICALS, BIOLOGICS, BIOTECHNOLOGY AND MEDICAL DEVICES, NAMELY ASSISTING COMPANIES WITH MANUFACTURING FACILITIES WITH TECHNICAL AND REGULATORY COMPLIANCE, NAMELY REGULATIONS PROMULGATED BY THE FDA AND OTHER GOVERNMENTAL AGENCIES THAT REGULATE MEDICINE; TECHNICAL CONSULTING SERVICES IN THE FIELDS OF PHARMACEUTICALS, BIOLOGICS, BIOTECHNOLOGY AND THE MEDICAL DEVICE INDUSTRY, NAMELY PROVIDING QUALITY ASSURANCE, CLINICAL DATA MANAGEMENT, DESIGN AND DEVELOPMENT OF COMPUTER SOFTWARE (U.S. CLS. 100 AND 101).

FIRST USE 7-23-1998; IN COMMERCE 7-23-1998.
RENEE SERVANCE, EXAMINING ATTORNEY

CLASS 42—(Continued).

SN 77-093,903. FORTIUSONE, INC., WASHINGTON, DC. FILED 1-29-2007.

GEOCOMMONS

THE MARK CONSISTS OF STANDARD CHARACTERS WITHOUT CLAIM TO ANY PARTICULAR FONT, STYLE, SIZE, OR COLOR.

FOR COMPUTER SERVICE, NAMELY, ACTING AS AN APPLICATION SERVICE PROVIDER IN THE FIELD OF KNOWLEDGE MANAGEMENT TO HOST COMPUTER APPLICATION SOFTWARE FOR GEOSPATIAL DATA SHARING, DATA MANAGEMENT AND DATA STORAGE; PROVIDING TEMPORARY ON-LINE, NON-DOWNLOADABLE COMMUNITY INTERACTIVE SOFTWARE TOOLS FOR USERS OF GEOSPATIAL DATA; ON-LINE WEB APPLICATION SOFTWARE AND SERVICE PLATFORMS FOR INTERACTIVE OR PROGRAMMATIC ORGANIZATION AND ANALYSIS OF GEOSPATIAL DATA; PROVIDING ON-LINE, NON-DOWNLOADABLE SOFTWARE FOR USE IN ANALYZING, MANIPULATING AND MANAGING GEOGRAPHIC DATA; PROVIDING ON-LINE COMMUNITY PORTAL HOSTING (U.S. CLS. 100 AND 101).

IRENE D. WILLIAMS, EXAMINING ATTORNEY

SN 77-072,904. PHARMACEUTICAL SERVICES CORPORATION, PASADENA, CA. FILED 12-28-2006.

PSC

THE MARK CONSISTS OF STANDARD CHARACTERS WITHOUT CLAIM TO ANY PARTICULAR FONT, STYLE, SIZE, OR COLOR.

FOR TECHNICAL CONSULTING SERVICES IN THE FIELDS OF PHARMACEUTICALS, BIOLOGICS, BIOTECHNOLOGY AND MEDICAL DEVICES, NAMELY ASSISTING COMPANIES WITH MANUFACTURING FACILITIES WITH TECHNICAL AND REGULATORY COMPLIANCE, NAMELY REGULATIONS PROMULGATED BY THE FDA AND OTHER GOVERNMENTAL AGENCIES THAT REGULATE MEDICINE; TECHNICAL CONSULTING SERVICES IN THE FIELDS OF PHARMACEUTICALS, BIOLOGICS, BIOTECHNOLOGY AND THE MEDICAL DEVICE INDUSTRY, NAMELY PROVIDING QUALITY ASSURANCE, CLINICAL DATA MANAGEMENT, DESIGN AND DEVELOPMENT OF COMPUTER SOFTWARE (U.S. CLS. 100 AND 101).

FIRST USE 2-1-1996; IN COMMERCE 7-23-1998.
RENEE SERVANCE, EXAMINING ATTORNEY

SN 77-109,181. EFI, INC., LAS VEGAS, NV. FILED 2-16-2007.

Evolutionary Exhibit Solutions

NO CLAIM IS MADE TO THE EXCLUSIVE RIGHT TO USE "EXHIBIT SOLUTIONS", APART FROM THE MARK AS SHOWN.

THE COLOR(S) GREEN, BLACK, WHITE, AND ORANGE IS/ARE CLAIMED AS A FEATURE OF THE MARK.

THE MARK CONSISTS OF THE GREEN LETTERING OF EVO AND ORANGE LETTERING OF X. THE LETTERING OF EVOLUTIONARY EXHIBIT SOLUTIONS IS WHITE INSIDE A BLACK RECTANGLE.

FOR DESIGN FOR OTHERS IN THE FIELD OF EXHIBIT BOOTHS FOR CONVENTIONS AND TRADE SHOWS (U.S. CLS. 100 AND 101).

FIRST USE 1-2-2007; IN COMMERCE 1-2-2007.
RAMONA ORTIGA, EXAMINING ATTORNEY

CLASS 42—(Continued).

SN 77-116,845. BLUELIX SERVICES INC., ATLANTA, GA. FILED 2-27-2007.



FOR PROVIDING TEMPORARY USE OF NON-DOWNLOADABLE COMPUTER SOFTWARE FOR PLANNING AND DESIGNING BUILDING PROJECTS (U.S. CLS. 100 AND 101).

FIRST USE 1-11-2006; IN COMMERCE 1-11-2006.
JUSTINE D. PARKER, EXAMINING ATTORNEY

CLASS 42—(Continued).

SN 77-124,266. THE SOCIETY OF THE PLASTICS INDUSTRY, INC., WASHINGTON, DC. FILED 3-7-2007.



THE MARK CONSISTS OF THE LETTER P INSIDE OF A CIRCLE.

FOR COMPUTER SERVICES, NAMELY CREATING AN ONLINE COMMUNITY FOR REGISTERED USERS TO OBTAIN PLASTICS INDUSTRY INFORMATION, NETWORK, AND PARTICIPATE IN WEB-BASED INDUSTRY ACTIVITIES (U.S. CLS. 100 AND 101).

BERNICE MIDDLETON, EXAMINING ATTORNEY

SN 77-121,903. SOFTSCAPE, INC., WAYLAND, MA. FILED 3-5-2007.

People Management Experts

THE MARK CONSISTS OF STANDARD CHARACTERS WITHOUT CLAIM TO ANY PARTICULAR FONT, STYLE, SIZE, OR COLOR.

NO CLAIM IS MADE TO THE EXCLUSIVE RIGHT TO USE "EXPERTS", APART FROM THE MARK AS SHOWN.

FOR CONSULTING SERVICES IN THE FIELD OF DESIGN, SELECTION, IMPLEMENTATION AND USE OF COMPUTER HARDWARE AND SOFTWARE SYSTEMS FOR OTHERS (U.S. CLS. 100 AND 101).

FIRST USE 1-1-2007; IN COMMERCE 1-1-2007.
ELI HELLMAN, EXAMINING ATTORNEY

SN 77-124,848. AMERICAN COLLEGE OF CARDIOLOGY FOUNDATION, WASHINGTON, DC. FILED 3-7-2007.

**QUALITY IMPROVEMENT.
QUANTIFIED.**

SN 77-122,903. PEGASUS RESEARCH, INC., PHOENIX, AZ. FILED 3-6-2007.

INTELEGILITY

THE MARK CONSISTS OF STANDARD CHARACTERS WITHOUT CLAIM TO ANY PARTICULAR FONT, STYLE, SIZE, OR COLOR.

FOR INFORMATION TECHNOLOGY CONSULTATION (U.S. CLS. 100 AND 101).

RENEE SERVANCE, EXAMINING ATTORNEY

THE MARK CONSISTS OF STANDARD CHARACTERS WITHOUT CLAIM TO ANY PARTICULAR FONT, STYLE, SIZE, OR COLOR.

NO CLAIM IS MADE TO THE EXCLUSIVE RIGHT TO USE "QUALITY IMPROVEMENT", APART FROM THE MARK AS SHOWN.

FOR PROVIDING QUALITY ASSURANCE MEASUREMENT SERVICES FOR DOCTORS, HOSPITALS, AND LABS IN THE FIELD OF MEDICINE AND HEALTH INCLUDING TARGETED PROCEDURES AND CONDITIONS (U.S. CLS. 100 AND 101).

PAULA MAHONEY, EXAMINING ATTORNEY

CLASS 42—(Continued).

SN 77-136,876. NATIONAL HEALTH MUSEUM, WASHINGTON, DC. FILED 3-21-2007.

Access Excellence

THE MARK CONSISTS OF STANDARD CHARACTERS WITHOUT CLAIM TO ANY PARTICULAR FONT, STYLE, SIZE, OR COLOR.

NO CLAIM IS MADE TO THE EXCLUSIVE RIGHT TO USE "ACCESS", APART FROM THE MARK AS SHOWN.

FOR COMPUTER SERVICES, NAMELY, HOSTING AND MAINTAINING AN ONLINE WEBSITE FOR OTHERS FEATURING INFORMATION IN THE FIELD OF EDUCATION RELATED TO BIOLOGICAL AND HEALTH SCIENCES (U.S. CLS. 100 AND 101).

FIRST USE 11-16-1993; IN COMMERCE 11-16-1993.
LAURIE KAUFMAN, EXAMINING ATTORNEY

SN 77-140,077. ASSET EVOLUTION, OREM, UT. FILED 3-26-2007.

ASSET EVOLUTION

THE MARK CONSISTS OF STANDARD CHARACTERS WITHOUT CLAIM TO ANY PARTICULAR FONT, STYLE, SIZE, OR COLOR.

NO CLAIM IS MADE TO THE EXCLUSIVE RIGHT TO USE "ASSET", APART FROM THE MARK AS SHOWN.

FOR COMPUTER SOFTWARE CONSULTATION; PROVIDING ON-LINE NON-DOWNLOADABLE SOFTWARE FOR USE IN INVENTORY OF FIXED ASSETS, AND BUDGETING FOR THE FACILITY MANAGEMENT INDUSTRY (U.S. CLS. 100 AND 101).

FIRST USE 7-1-2003; IN COMMERCE 7-1-2003.
MARILYN IZZI, EXAMINING ATTORNEY

SN 77-143,783. RIDGWAYS, LTD, HOUSTON, TX. FILED 3-29-2007.

IT PLUS NETWORK

THE MARK CONSISTS OF STANDARD CHARACTERS WITHOUT CLAIM TO ANY PARTICULAR FONT, STYLE, SIZE, OR COLOR.

NO CLAIM IS MADE TO THE EXCLUSIVE RIGHT TO USE "IT" AND "NETWORK", APART FROM THE MARK AS SHOWN.

FOR COMPUTER NETWORK DESIGN FOR THE COPYING AND PRINTING INDUSTRY (U.S. CLS. 100 AND 101).

JUSTINE D. PARKER, EXAMINING ATTORNEY

CLASS 42—(Continued).

SN 77-144,123. FNF INTELLECTUAL PROPERTY HOLDINGS, INC., JACKSONVILLE, FL. FILED 3-29-2007.

FNTI

THE MARK CONSISTS OF STANDARD CHARACTERS WITHOUT CLAIM TO ANY PARTICULAR FONT, STYLE, SIZE, OR COLOR.

FOR DOCUMENT CONVERSION SERVICES, NAMELY, CONVERSION OF DATA OR DOCUMENTS FROM PHYSICAL TO ELECTRONIC MEDIA AND FROM ONE FORM OF MEDIA TO ANOTHER (U.S. CLS. 100 AND 101).

FIRST USE 2-1-2007; IN COMMERCE 2-1-2007.

KENNETH E. SHARPERSON, EXAMINING ATTORNEY

SN 77-144,489. RIDGWAYS, LTD, HOUSTON, TX. FILED 3-30-2007.



NO CLAIM IS MADE TO THE EXCLUSIVE RIGHT TO USE "IT" AND "NETWORK", APART FROM THE MARK AS SHOWN.

THE COLOR(S) BLACK, ORANGE AND GREEN IS/ARE CLAIMED AS A FEATURE OF THE MARK.

THE MARK CONSISTS OF THE WORDING IT PLUS NETWORK IN BLACK; THE BOX AROUND IT AND TWO WAVY LINES AT THE TOP OF THE MARK IN ORANGE; AND THE BAR UNDERLINING PLUS AND TWO WAVY LINES AT THE TOP OF THE MARK IN GREEN.

FOR COMPUTER NETWORK DESIGN FOR THE COPYING AND PRINTING INDUSTRY (U.S. CLS. 100 AND 101).

JUSTINE D. PARKER, EXAMINING ATTORNEY

CLASS 42—(Continued).

SN 77-145,953. STIEGLITECH, LLC, NEW YORK, NY. FILED 4-2-2007.

STAINLESS CODE

THE MARK CONSISTS OF STANDARD CHARACTERS WITHOUT CLAIM TO ANY PARTICULAR FONT, STYLE, SIZE, OR COLOR.

NO CLAIM IS MADE TO THE EXCLUSIVE RIGHT TO USE "CODE", APART FROM THE MARK AS SHOWN.

FOR COMPUTER SERVICE, NAMELY, ACTING AS AN APPLICATION SERVICE PROVIDER IN THE FIELD OF KNOWLEDGE MANAGEMENT TO HOST COMPUTER APPLICATION SOFTWARE FOR CREATING SEARCHABLE DATABASES OF INFORMATION AND DATA; COMPUTER SERVICE, NAMELY, ACTING AS AN APPLICATION SERVICE PROVIDER IN THE FIELD OF KNOWLEDGE MANAGEMENT TO HOST COMPUTER APPLICATION SOFTWARE FOR SEARCHING AND RETRIEVING INFORMATION FROM DATABASES AND COMPUTER NETWORKS; COMPUTER SOFTWARE CONSULTANCY; COMPUTER SOFTWARE CONSULTATION; COMPUTER SOFTWARE DESIGN FOR OTHERS; COMPUTER SOFTWARE DESIGN, COMPUTER PROGRAMMING, OR MAINTENANCE OF COMPUTER SOFTWARE; COMPUTER SOFTWARE DEVELOPMENT; SOFTWARE AUTHORING; TECHNICAL SUPPORT SERVICES, NAMELY, TROUBLESHOOTING OF COMPUTER SOFTWARE PROBLEMS; CONSULTANCY IN THE FIELD OF SOFTWARE DESIGN; CUSTOMIZATION OF COMPUTER HARDWARE AND SOFTWARE; DESIGN OF COMPUTER NETWORKS AND SOFTWARE FOR OTHERS FOR THE MEDIA INDUSTRY; DESIGN OF HOME PAGES, COMPUTER SOFTWARE AND WEB SITES; IMAGE PROCESSING SOFTWARE DESIGN; MAINTENANCE OF COMPUTER SOFTWARE; DESIGN AND DEVELOPMENT OF ON-LINE COMPUTER SOFTWARE SYSTEMS; DESIGN, DEVELOPMENT AND IMPLEMENTATION OF SOFTWARE; DEVELOPMENT, UPDATING AND MAINTENANCE OF SOFTWARE AND DATA BASES (U.S. CLS. 100 AND 101).

FIRST USE 3-26-2007; IN COMMERCE 3-26-2007.
MICHELLE DUBOIS, EXAMINING ATTORNEY

CLASS 42—(Continued).

SN 77-148,006. NANO AND GIGA SOLUTIONS, INC., GILBERT, AZ. FILED 4-3-2007.

Nano and Giga

THE MARK CONSISTS OF STANDARD CHARACTERS WITHOUT CLAIM TO ANY PARTICULAR FONT, STYLE, SIZE, OR COLOR.

FOR CHEMICAL RESEARCH; CHEMISTRY CONSULTATION; COMPUTER CONSULTATION; COMPUTER SOFTWARE CONSULTANCY; COMPUTER SOFTWARE CONSULTATION; CONSULTANCY IN THE FIELD OF SOFTWARE DESIGN; CONSULTATION IN THE FIELD OF PHYSICS; CONSULTATION SERVICES IN THE FIELDS OF SELECTION, IMPLEMENTATION AND USE OF COMPUTER HARDWARE AND SOFTWARE SYSTEMS FOR OTHERS; CONSULTING SERVICES IN THE FIELD OF DESIGN OF NEWSLETTERS; CONSULTING SERVICES IN THE FIELD OF DESIGN, SELECTION, IMPLEMENTATION AND USE OF COMPUTER HARDWARE AND SOFTWARE SYSTEMS FOR OTHERS; INDUSTRIAL RESEARCH IN THE FIELD OF MATERIALS DESIGN FOR ELECTRONICS, PHOTONICS AND RENEWABLE ENERGY; INFORMATION TECHNOLOGY CONSULTATION; LABORATORY RESEARCH IN THE FIELD OF ELECTRONICS, PHOTONICS AND RENEWABLE ENERGY; MATERIAL TESTING; MATERIALS TESTING AND ANALYZING; MATERIALS TESTING AND EVALUATION; PRODUCT RESEARCH; PRODUCT RESEARCH AND DEVELOPMENT; RESEARCH AND DEVELOPMENT AND CONSULTATION RELATED THERETO IN THE FIELD OF ELECTRONICS, PHOTONICS AND RENEWABLE ENERGY; RESEARCH AND DEVELOPMENT FOR NEW PRODUCTS FOR OTHERS; RESEARCH IN THE AREA OF SEMICONDUCTOR PROCESSING TECHNOLOGY; RESEARCH IN THE FIELD OF CHEMISTRY; RESEARCH IN THE FIELD OF PHYSICS; SCIENTIFIC RESEARCH; SCIENTIFIC RESEARCH AND DEVELOPMENT; TECHNICAL CONSULTANCY IN RELATION TO THE PRODUCTION OF SEMICONDUCTORS; TECHNOLOGICAL CONSULTATION IN THE TECHNOLOGY FIELD OF ELECTRONICS, PHOTONICS AND RENEWABLE ENERGY; TECHNOLOGY CONSULTATION AND RESEARCH IN THE FIELD OF ELECTRONICS, PHOTONICS AND RENEWABLE ENERGY; TECHNOLOGY CONSULTATION IN THE FIELD OF ELECTRONICS, PHOTONICS AND RENEWABLE ENERGY (U.S. CLS. 100 AND 101).

FIRST USE 9-10-2002; IN COMMERCE 1-10-2005.
BRIDGETT SMITH, EXAMINING ATTORNEY

SN 77-148,611. DATANATIONAL CORPORATION, FARMINGTON HILLS, MI. FILED 4-4-2007.

RESIDENTIAL ENTERPRISE

THE MARK CONSISTS OF STANDARD CHARACTERS WITHOUT CLAIM TO ANY PARTICULAR FONT, STYLE, SIZE, OR COLOR.

NO CLAIM IS MADE TO THE EXCLUSIVE RIGHT TO USE "RESIDENTIAL", APART FROM THE MARK AS SHOWN.

FOR DESIGN OF BUILDING WIRING SYSTEMS (U.S. CLS. 100 AND 101).

JOHN SCHUYLER YARD, EXAMINING ATTORNEY

CLASS 42—(Continued).

SN 77-149,304. LASSO THE MOON INTERIORS, LLC, BIRMINGHAM, AL. FILED 4-5-2007.

LASSO THE MOON INTERIORS

THE MARK CONSISTS OF STANDARD CHARACTERS WITHOUT CLAIM TO ANY PARTICULAR FONT, STYLE, SIZE, OR COLOR.

NO CLAIM IS MADE TO THE EXCLUSIVE RIGHT TO USE "INTERIORS", APART FROM THE MARK AS SHOWN, FOR INTERIOR DECORATING (U.S. CLS. 100 AND 101).

FIRST USE 3-0-1999; IN COMMERCE 3-0-1999.
JUSTINE D. PARKER, EXAMINING ATTORNEY

SN 77-149,863. MEDIUM, INC., BOULDER, CO. FILED 4-5-2007.

BEING AROUND PEOPLE
CHANGES EVERYTHING

THE MARK CONSISTS OF STANDARD CHARACTERS WITHOUT CLAIM TO ANY PARTICULAR FONT, STYLE, SIZE, OR COLOR.

FOR COMPUTER SERVICES, NAMELY, PROVIDING AN INTERNET SEARCH ENGINE FOR OBTAINING DATA ON A GLOBAL COMPUTER NETWORK; CREATING INDEXES OF INFORMATION, SITES AND OTHER INFORMATION AVAILABLE ON COMPUTER NETWORKS (U.S. CLS. 100 AND 101).

ANDREW RHIM, EXAMINING ATTORNEY

SN 77-151,230. DOCUMENTTRUST, LLC, EXTON, PA. FILED 4-7-2007.

DocumentTrust

THE MARK CONSISTS OF STANDARD CHARACTERS WITHOUT CLAIM TO ANY PARTICULAR FONT, STYLE, SIZE, OR COLOR.

FOR HOSTING OF DIGITAL CONTENT ON THE INTERNET (U.S. CLS. 100 AND 101).

MARK PILARO, EXAMINING ATTORNEY

CLASS 42—(Continued).

SN 77-152,591. ARGYLE DESIGN & OVERSEAS MANAGEMENT, LLC, HORSEHEADS, NY. FILED 4-10-2007.

ARGYLE DESIGN & OVERSEAS
MANAGEMENT, LLC

THE MARK CONSISTS OF STANDARD CHARACTERS WITHOUT CLAIM TO ANY PARTICULAR FONT, STYLE, SIZE, OR COLOR.

NO CLAIM IS MADE TO THE EXCLUSIVE RIGHT TO USE "DESIGN & OVERSEAS MANAGEMENT, LLC", APART FROM THE MARK AS SHOWN.

FOR PACKAGING DESIGN FOR OTHERS (U.S. CLS. 100 AND 101).

BRIAN PINO, EXAMINING ATTORNEY

SN 77-154,812. JAMES GROSSMAN, WESTPORT, CT. FILED 4-12-2007.

RightDot

THE MARK CONSISTS OF STANDARD CHARACTERS WITHOUT CLAIM TO ANY PARTICULAR FONT, STYLE, SIZE, OR COLOR.

FOR PROVIDING ELECTRONIC VERIFICATION OF WEBSITE AND DOMAIN NAME DATA AND GENERATING AN INDICIA OF AUTHENTICITY TO ALLOW USERS TO QUICKLY AND ACCURATELY IDENTIFY OFFICIAL WEBSITES IN ON-LINE SEARCH ENGINE RESULTS LISTS; COMPUTER SERVICES, NAMELY, AUTHENTICATING AND VERIFYING THE AUTHENTICITY OF WEBSITE AND DOMAIN NAME DATA OF OTHERS; PROVIDING ON-LINE NON-DOWNLOADABLE SOFTWARE FOR USE IN REGISTERING OFFICIAL WEBSITES IN A PROGRAM THAT ALLOWS FOR DISPLAYING REGISTRATION INDICIA IN INTERNET SEARCH ENGINE RESULTS LISTS TO ENABLE USERS ON A GLOBAL COMPUTER NETWORK TO QUICKLY AND ACCURATELY IDENTIFY OFFICIAL WEBSITES (U.S. CLS. 100 AND 101).

MATTHEW MCDOWELL, EXAMINING ATTORNEY

CLASS 42—(Continued).

SN 77-155,495. TTC TECHNOLOGIES, INC., CENTEREACH, NY. FILED 4-12-2007.

TTC Technologies

THE MARK CONSISTS OF STANDARD CHARACTERS WITHOUT CLAIM TO ANY PARTICULAR FONT, STYLE, SIZE, OR COLOR.

NO CLAIM IS MADE TO THE EXCLUSIVE RIGHT TO USE "TECHNOLOGIES", APART FROM THE MARK AS SHOWN.

FOR SOFTWARE DEVELOPMENT FOR OTHERS; TECHNOLOGY CONSULTING SERVICES IN THE FIELDS OF FLUID, THERMAL AND AERODYNAMICS ENGINEERING AND THE DESIGN OF AEROSPACE, CHEMICAL AND MECHANICAL SYSTEMS; CONSULTING SERVICES IN THE FIELDS OF FLUID, THERMAL AND AERODYNAMICS ENGINEERING AND THE DESIGN OF AEROSPACE, CHEMICAL AND MECHANICAL SYSTEMS (U.S. CLS. 100 AND 101).

FIRST USE 5-5-1993; IN COMMERCE 8-1-2006.
APRIL ROACH, EXAMINING ATTORNEY

CLASS 42—(Continued).

SN 77-157,181. INTEGRITY GRAPHICS, INC., WINDSOR, CT. FILED 4-16-2007.

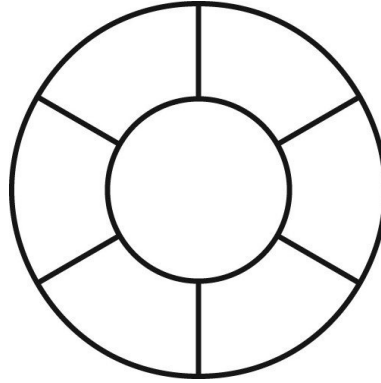

FOR PROVIDING TEMPORARY USE OF ON-LINE NON-DOWNLOADABLE SOFTWARE TO DESIGN, CREATE, PRINT AND MAINTAIN CUSTOMIZED MARKETING AND PROMOTIONAL MATERIALS (U.S. CLS. 100 AND 101).

FIRST USE 12-31-2004; IN COMMERCE 12-31-2004.
CHRIS WELLS, EXAMINING ATTORNEY

SN 77-157,226. THOMAS J. BURKE, LAKESIDE PARK, KY. FILED 4-16-2007.

CLICK360

THE MARK CONSISTS OF STANDARD CHARACTERS WITHOUT CLAIM TO ANY PARTICULAR FONT, STYLE, SIZE, OR COLOR.

FOR PROVIDING ON-LINE NON-DOWNLOADABLE SOFTWARE FOR MULTI-RATER PERFORMANCE APPRAISAL AND TRAINING SERVICES, USED FOR COLLECTING INDIVIDUAL PERFORMANCE INFORMATION, FOR ANALYZING INDIVIDUAL PERFORMANCE INFORMATION, AND FOR COMPENSATING PERSONNEL BASED ON THEIR INDIVIDUAL PERFORMANCE INFORMATION (U.S. CLS. 100 AND 101).

DORITT L. CARROLL, EXAMINING ATTORNEY

SN 77-156,665. DEZINEGIRL, SAN DIEGO, CA. FILED 4-13-2007.

DEZINEGIRL

THE MARK CONSISTS OF STANDARD CHARACTERS WITHOUT CLAIM TO ANY PARTICULAR FONT, STYLE, SIZE, OR COLOR.

FOR DESIGN OF HOMEPAGES AND WEB-SITES; GRAPHIC DESIGN SERVICES (U.S. CLS. 100 AND 101).
FIRST USE 5-1-2001; IN COMMERCE 5-1-2001.

KATHERINE CHANG, EXAMINING ATTORNEY

SN 77-157,290. BLD INTERNATIONAL, LEESBURG, FL. FILED 4-16-2007.

PIPETTERX

THE MARK CONSISTS OF STANDARD CHARACTERS WITHOUT CLAIM TO ANY PARTICULAR FONT, STYLE, SIZE, OR COLOR.

FOR PIPETTE CALIBRATION SERVICES (U.S. CLS. 100 AND 101).

JASON BLAIR, EXAMINING ATTORNEY

CLASS 42—(Continued).

SN 77-158,004. CWK2 LAND DEVELOPMENT CONSULTANTS, PORTLAND, OR. FILED 4-16-2007.



NO CLAIM IS MADE TO THE EXCLUSIVE RIGHT TO USE "LAND DEVELOPMENT CONSULTANTS", APART FROM THE MARK AS SHOWN.

THE MARK CONSISTS OF THE WORDS CWK2 LAND DEVELOPMENT CONSULTANTS. THERE ARE THREE BUILDINGS ON THE MARK WITH A SUNSET OVERTOP. THE TWO OUTSIDE BUILDINGS HAVE POINTED ROOFS, THE INSIDE BUILDING HAS A FLAT ROOF LIKE A SKYSCRAPER. CWK2 IS IN TALL LETTERS AT THE BOTTOM OF THE LOGO.

FOR CIVIL ENGINEERING; LAND USE PLANNING SERVICES; SURVEYING (U.S. CLS. 100 AND 101).

LAURIE MAYES, EXAMINING ATTORNEY

SN 77-158,022. SALAS O'BRIEN ENGINEERS, INC., SAN JOSE, CA. FILED 4-16-2007.

expect a difference

THE MARK CONSISTS OF STANDARD CHARACTERS WITHOUT CLAIM TO ANY PARTICULAR FONT, STYLE, SIZE, OR COLOR.

FOR ENGINEERING CONSULTING FIRM SPECIALIZING IN MECHANICAL, ELECTRICAL, TELECOMMUNICATIONS, AND ARCHITECTURAL DESIGN AND DRAFTING (U.S. CLS. 100 AND 101).

JUDITH HELFMAN, EXAMINING ATTORNEY

CLASS 42—(Continued).

SN 77-158,072. PEERCONNECTOR, WOODSTOCK, GA. FILED 4-16-2007.

PeerConnector

THE MARK CONSISTS OF STANDARD CHARACTERS WITHOUT CLAIM TO ANY PARTICULAR FONT, STYLE, SIZE, OR COLOR.

FOR COMPUTER SERVICE, NAMELY, ACTING AS AN APPLICATION SERVICE PROVIDER IN THE FIELD OF KNOWLEDGE MANAGEMENT TO HOST COMPUTER APPLICATION SOFTWARE FOR CREATING SEARCHABLE DATABASES OF INFORMATION AND DATA; COMPUTER SERVICE, NAMELY, ACTING AS AN APPLICATION SERVICE PROVIDER IN THE FIELD OF KNOWLEDGE MANAGEMENT TO HOST COMPUTER APPLICATION SOFTWARE FOR SEARCHING AND RETRIEVING INFORMATION FROM DATABASES AND COMPUTER NETWORKS; COMPUTER SERVICE, NAMELY, ACTING AS AN APPLICATION SERVICE PROVIDER IN THE FIELD OF KNOWLEDGE MANAGEMENT TO HOST COMPUTER APPLICATION SOFTWARE FOR THE COLLECTION, EDITING, ORGANIZING, MODIFYING, BOOK MARKING, TRANSMISSION, STORAGE AND SHARING OF DATA AND INFORMATION; COMPUTER SERVICES, NAMELY, CREATING AN ONLINE COMMUNITY FOR REGISTERED USERS TO PARTICIPATE IN COMPETITIONS, SHOWCASE THEIR SKILLS, GET FEEDBACK FROM THEIR PEERS, FORM VIRTUAL COMMUNITIES, ENGAGE IN SOCIAL NETWORKING AND IMPROVE THEIR TALENT (U.S. CLS. 100 AND 101).

FIRST USE 8-13-2006; IN COMMERCE 1-28-2007.

G. MAYERSCHOFF, EXAMINING ATTORNEY

SN 77-158,284. ESUREITY INC., ST. CLOUD, FL. FILED 4-17-2007.

eSureITy

THE MARK CONSISTS OF STANDARD CHARACTERS WITHOUT CLAIM TO ANY PARTICULAR FONT, STYLE, SIZE, OR COLOR.

FOR INFORMATION TECHNOLOGY CONSULTATION (U.S. CLS. 100 AND 101).

FIRST USE 11-1-2006; IN COMMERCE 11-1-2006.

KYLE PEETE, EXAMINING ATTORNEY

CLASS 42—(Continued).

SN 77-158,307. CHRISTY, KATHERINE, BETHESDA, MD. FILED 4-17-2007.

ConceptGirl

THE MARK CONSISTS OF STANDARD CHARACTERS WITHOUT CLAIM TO ANY PARTICULAR FONT, STYLE, SIZE, OR COLOR.

FOR ANIMATION AND SPECIAL-EFFECTS DESIGN FOR OTHERS; COMMERCIAL ART DESIGN; COMPUTER GRAPHICS SERVICES; COMPUTER SERVICES, NAMELY, DESIGNING AND IMPLEMENTING WEB SITES FOR OTHERS; DESIGN AND DEVELOPMENT OF MULTIMEDIA PRODUCTS; DESIGN AND TESTING OF NEW PRODUCTS FOR OTHERS; DESIGN FOR OTHERS IN THE FIELD OF COMPUTER ARTS; DESIGN OF CUSTOM PAINTINGS; DESIGN OF HOME PAGES; DESIGNING THEME GRAPHICS AND MULTIMEDIA SHOWS FOR CONVENTIONS, PRODUCT LAUNCHES, TRADE SHOWS, KEY NOTE ADDRESSES AND AWARD CEREMONIES FOR OTHERS; DESIGNING WEBSITES FOR ADVERTISING PURPOSES; DEVELOPMENT, DESIGN AND UPDATING OF HOME PAGES; GRAPHIC ART DESIGN; GRAPHIC DESIGN SERVICES; GRAPHIC ILLUSTRATION SERVICES FOR OTHERS; INDUSTRIAL DESIGN; PACKAGING DESIGN FOR OTHERS; PLANNING AND LAYOUT DESIGN FOR THE INTERIOR SPACE OF RETAIL BUSINESS ESTABLISHMENTS; SHOP INTERIOR DESIGN; THEME PARK ATTRACTION DESIGN SERVICES (U.S. CLS. 100 AND 101).

FIRST USE 5-1-1998; IN COMMERCE 9-8-2000.
CHERYL CLAYTON, EXAMINING ATTORNEY

SN 77-158,707. WILSON INTERESTS, LLC, NEW ORLEANS, LA. FILED 4-17-2007.

WISEware

THE MARK CONSISTS OF STANDARD CHARACTERS WITHOUT CLAIM TO ANY PARTICULAR FONT, STYLE, SIZE, OR COLOR.

FOR COMPUTER SOFTWARE CONSULTATION; CONSULTING SERVICES IN THE FIELD OF DESIGN, SELECTION, IMPLEMENTATION AND USE OF COMPUTER HARDWARE AND SOFTWARE SYSTEMS FOR OTHERS; MAINTENANCE OF COMPUTER SOFTWARE (U.S. CLS. 100 AND 101).

GEOFFREY FOSDICK, EXAMINING ATTORNEY

CLASS 42—(Continued).

SN 77-158,842. TPG IT CONSULTING - THE PILOT GROUP, LLC, KATY, TX. FILED 4-17-2007.

The
Pilot
Group
Navigating Business Technology

NO CLAIM IS MADE TO THE EXCLUSIVE RIGHT TO USE "GROUP" AND "BUSINESS TECHNOLOGY", APART FROM THE MARK AS SHOWN.

THE COLOR(S) NAVY AND BLUE IS/ARE CLAIMED AS A FEATURE OF THE MARK.

THE MARK CONSISTS OF THE WORDS "THE PILOT GROUP" ARE WRITTEN IN TREBUCHET FONT AND ARE NAVY BLUE. THE LETTER O IN THE WORD PILOT IS STYLIZED AS A SHIPS PILOT WHEEL. THE WORDS "NAVIGATING BUSINESS TECHNOLOGY" USE A TREBUCHET FONT BUT ARE REDUCED IN SIZE.

FOR INFORMATION TECHNOLOGY CONSULTATION (U.S. CLS. 100 AND 101).

CHRISTINA SOBRAL, EXAMINING ATTORNEY

SN 77-159,014. PAULIN, KATHY, LA JOLLA, CA. FILED 4-17-2007.

nscope
innovations

NO CLAIM IS MADE TO THE EXCLUSIVE RIGHT TO USE INNOVATIONS, APART FROM THE MARK AS SHOWN.

THE MARK CONSISTS OF A LOWER CASE N WITH UPPER CASE S, LOWER CASE COPE, WITH THE WORD INNOVATIONS UNDERNEATH.

FOR DESIGN AND TESTING FOR NEW PRODUCT DEVELOPMENT, EXCLUDING ENDOSCOPIC SURGICAL INSTRUMENTS (U.S. CLS. 100 AND 101).

AMY ALFIERI, EXAMINING ATTORNEY

CLASS 42—(Continued).

SN 77-159,592. PROSANOS CORPORATION, HARRISBURG, PA. FILED 4-18-2007.



THE COLOR(S) GREY AND RED IS/ARE CLAIMED AS A FEATURE OF THE MARK.

THE LETTERS C, L, R, I AND T AND THE VERTICAL AND HORIZONTAL LINES ARE GREY, THE LETTERS AE ARE A CAPITAL AE LIGATURE IN RED, AND THE STAR IS RED.

FOR PROVIDING ON-LINE NON-DOWNLOADABLE SOFTWARE FOR DETECTING DRUG SAFETY SIGNALS IN SPONTANEOUS REPORTING DATABASES FOR THE PHARMACEUTICAL INDUSTRY (U.S. CLS. 100 AND 101).

FIRST USE 2-26-2007; IN COMMERCE 3-26-2007.
JOHN WILKE, EXAMINING ATTORNEY

SN 77-159,593. KUTTNER LLC, PORT WASHINGTON, WI. FILED 4-18-2007.



NO CLAIM IS MADE TO THE EXCLUSIVE RIGHT TO USE "NORTH AMERICA", APART FROM THE MARK AS SHOWN.

THE COLOR(S) BLUE, BLACK, AND WHITE IS/ARE CLAIMED AS A FEATURE OF THE MARK.

THE MARK CONSISTS OF IN THE WORD "KUTTNER", THE LETTER "U" HAS TWO DOTS ABOVE IT. THE WORD "KUTTNER" IS BLUE. THE LINE UNDERNEATH "KUTTNER" IS BLACK, AS IS THE WORDS "NORTH AMERICA". THE BACKGROUND IS WHITE.

FOR ENVIRONMENTAL SERVICES, NAMELY, TECHNICAL CONSULTATION IN THE FIELD OF ENVIRONMENTAL SCIENCE, ENGINEERING SERVICES, DESIGN FOR OTHERS IN THE FIELD OF ENVIRONMENTAL ENGINEERING, DESIGNING AND TESTING OF NEW ENVIRONMENTALLY FRIENDLY PRODUCTS FOR OTHERS (U.S. CLS. 100 AND 101).

FIRST USE 1-1-2007; IN COMMERCE 1-1-2007.
JOHN WILKE, EXAMINING ATTORNEY

CLASS 42—(Continued).

SN 77-160,220. CORPTEK SYSTEMS, INC., FORT LAUDERDALE, FL. FILED 4-18-2007.



THE MARK CONSISTS OF STANDARD CHARACTERS WITHOUT CLAIM TO ANY PARTICULAR FONT, STYLE, SIZE, OR COLOR.

FOR COMPUTER SERVICES, NAMELY, COMPUTER SYSTEM ADMINISTRATION FOR OTHERS; COMPUTER SERVICES, NAMELY, DATA RECOVERY SERVICES; COMPUTER SERVICES, NAMELY, DESIGNING AND IMPLEMENTING NETWORK WEB PAGES FOR OTHERS (U.S. CLS. 100 AND 101).

FIRST USE 6-25-1998; IN COMMERCE 6-25-1998.
INGRID C. EULIN, EXAMINING ATTORNEY

SN 77-161,174. INTELLIGENT SEARCH TECHNOLOGIES LLC, CHARLOTTESVILLE, VA. FILED 4-19-2007.



THE MARK CONSISTS OF STANDARD CHARACTERS WITHOUT CLAIM TO ANY PARTICULAR FONT, STYLE, SIZE, OR COLOR.

FOR PROVIDING CUSTOMIZED ON-LINE WEB PAGES FEATURING USER-DEFINED INFORMATION, WHICH INCLUDES SEARCH ENGINES AND ON-LINE WEB LINKS TO OTHER WEB SITES (U.S. CLS. 100 AND 101).

FIRST USE 8-19-2006; IN COMMERCE 12-27-2006.
JUSTINE D. PARKER, EXAMINING ATTORNEY

SN 77-161,622. REDBIRD TECHNOLOGIES, INC., ACWORTH, GA. FILED 4-20-2007.



THE MARK CONSISTS OF AN ICONIC REDBIRD. FOR ENGINEERING SERVICES, NAMELY, ENGINEERING FOR THE AEROSPACE INDUSTRY (U.S. CLS. 100 AND 101).

FIRST USE 1-0-2005; IN COMMERCE 1-0-2005.
YONG KIM, EXAMINING ATTORNEY

CLASS 42—(Continued).

SN 77-161,850. ONE WORLD TELECOMMUNICATIONS HOLDINGS LTD, CENTRAL, HONG KONG, FILED 4-20-2007.

OWTALK

THE MARK CONSISTS OF STANDARD CHARACTERS WITHOUT CLAIM TO ANY PARTICULAR FONT, STYLE, SIZE, OR COLOR.

FOR DEVELOPMENT, MAINTENANCE AND UPDATING OF A TELECOMMUNICATION NETWORK SEARCH ENGINE (U.S. CLS. 100 AND 101).
LAURA KOVALSKY, EXAMINING ATTORNEY

SN 77-162,335. FUTURUM COMMUNICATIONS CORPORATION, DENVER, CO. FILED 4-20-2007.

PerfectPay

THE MARK CONSISTS OF STANDARD CHARACTERS WITHOUT CLAIM TO ANY PARTICULAR FONT, STYLE, SIZE, OR COLOR.

FOR APPLICATION SERVICE PROVIDER (ASP) FEATURING SOFTWARE FOR USE IN PERFORMING ELECTRONIC BUSINESS TRANSACTIONS VIA A GLOBAL COMPUTER NETWORK; APPLICATION SERVICE PROVIDER FEATURING SOFTWARE FOR PROVIDING AN ON-LINE DATABASE IN THE FIELD OF TRANSACTION PROCESSING TO UPLOAD TRANSACTIONAL DATA, PROVIDE STATISTICAL ANALYSIS, AND PRODUCE NOTIFICATIONS AND REPORTS (U.S. CLS. 100 AND 101).

FIRST USE 10-18-2000; IN COMMERCE 10-18-2000.
BILL DAWE, EXAMINING ATTORNEY

SN 77-165,432. SICORTEX, INC., MAYNARD, MA. FILED 4-25-2007.

SICORTEX

THE MARK CONSISTS OF STANDARD CHARACTERS WITHOUT CLAIM TO ANY PARTICULAR FONT, STYLE, SIZE, OR COLOR.

FOR TECHNICAL SUPPORT SERVICES, NAMELY, TROUBLESHOOTING OF COMPUTER HARDWARE AND SOFTWARE PROBLEMS (U.S. CLS. 100 AND 101).
FRANK LATTUCA, EXAMINING ATTORNEY

CLASS 42—(Continued).

SN 77-165,788. GARCIA, NOEL A., LARGO, MD. FILED 4-25-2007.



FOR INFORMATION TECHNOLOGY CONSULTATION (U.S. CLS. 100 AND 101).

FIRST USE 3-23-2007; IN COMMERCE 3-23-2007.
MICHAEL GAAFAR, EXAMINING ATTORNEY

SN 77-166,165. INSPECTOR GENERAL, LLC, MINNEAPOLIS, MN. FILED 4-26-2007.

INSPECTOR GENERAL

THE MARK CONSISTS OF STANDARD CHARACTERS WITHOUT CLAIM TO ANY PARTICULAR FONT, STYLE, SIZE, OR COLOR.

FOR INSPECTIONS OF HOUSES (U.S. CLS. 100 AND 101).

VERNA BETH RIRIE, EXAMINING ATTORNEY

SN 77-166,690. VISIBLE MEASURES CORP., CAMBRIDGE, MA. FILED 4-26-2007.

VISIBLE MEASURES

THE MARK CONSISTS OF STANDARD CHARACTERS WITHOUT CLAIM TO ANY PARTICULAR FONT, STYLE, SIZE, OR COLOR.

FOR PROVIDING ON-LINE NON-DOWNLOADABLE SOFTWARE FOR ENABLING USERS TO QUANTIFY AND ANALYZE AUDIENCE ENGAGEMENT AND EXPERIENCE WITH INTERNET VIDEO AND INTERACTIVE ADVERTISING (U.S. CLS. 100 AND 101).

TIMOTHY FINNEGAN, EXAMINING ATTORNEY

CLASS 42—(Continued).

SN 77-166,696. VISIBLE MEASURES CORP., CAMBRIDGE, MA. FILED 4-26-2007.



THE MARK CONSISTS OF THE WORDS VISIBLEMEASURES WITH A STYLIZED V ABOVE THE WORDS.

FOR PROVIDING ON-LINE NON-DOWNLOADABLE SOFTWARE FOR ENABLING USERS TO QUANTIFY AND ANALYZE AUDIENCE ENGAGEMENT AND EXPERIENCE WITH INTERNET VIDEO AND INTERACTIVE ADVERTISING (U.S. CLS. 100 AND 101).

TIMOTHY FINNEGAN, EXAMINING ATTORNEY

SN 77-169,929. SALAS O'BRIEN ENGINEERS, INC., SAN JOSE, CA. FILED 5-1-2007.

Green PRIX

THE MARK CONSISTS OF STANDARD CHARACTERS WITHOUT CLAIM TO ANY PARTICULAR FONT, STYLE, SIZE, OR COLOR.

NO CLAIM IS MADE TO THE EXCLUSIVE RIGHT TO USE "GREEN", APART FROM THE MARK AS SHOWN.

FOR ENGINEERING CONSULTING FIRM SPECIALIZING IN MECHANICAL, ELECTRICAL, TELECOMMUNICATIONS, AND ARCHITECTURAL DESIGN AND DRAFTING (U.S. CLS. 100 AND 101).

JUDITH HELFMAN, EXAMINING ATTORNEY

SN 77-173,592. THE DESIGN LOOPHOLE, DENVER, CO. FILED 5-4-2007.

LOOP HOLE

THE MARK CONSISTS OF STANDARD CHARACTERS WITHOUT CLAIM TO ANY PARTICULAR FONT, STYLE, SIZE, OR COLOR.

FOR CONSULTATION SERVICES, NAMELY ADVISING OTHERS IN THE DESIGN OF NEW PRODUCTS (U.S. CLS. 100 AND 101).

FIRST USE 1-20-2000; IN COMMERCE 6-9-2003.

PAUL F. GAST, EXAMINING ATTORNEY

CLASS 42—(Continued).

SN 77-174,527. TACILENT CORPORATION, DALLAS, TX. FILED 5-7-2007.

THE KNOWLEDGE WORKERS MARKETPLACE

THE MARK CONSISTS OF STANDARD CHARACTERS WITHOUT CLAIM TO ANY PARTICULAR FONT, STYLE, SIZE, OR COLOR.

FOR APPLICATION SERVICE PROVIDER FEATURING ON-LINE COMPUTER PROGRAMS FOR USE IN CREATING INFORMATION STORED IN MULTIPLE FORMATS; NAMELY, TO GATHER, CODIFY, CATALOG, ANALYZE AND ENHANCE INFORMATION WHICH IS SCORED AND ANALYZED IN DETAIL, THEN PUBLISHED TO A PLURALITY OF COMPUTERS CAPABLE OF ENCODING INTERNET BASED SOFTWARE IN THE FIELD OF PRIVATE ENTERPRISE (U.S. CLS. 100 AND 101).

FIRST USE 5-1-2007; IN COMMERCE 5-7-2007.

MICHAEL SOUDERS, EXAMINING ATTORNEY

SN 77-178,001. AMERICAN INTERNATIONAL GROUP, INC., NEW YORK, NY. FILED 5-10-2007.

AIG SOURCETRAC

THE MARK CONSISTS OF STANDARD CHARACTERS WITHOUT CLAIM TO ANY PARTICULAR FONT, STYLE, SIZE, OR COLOR.

OWNER OF U.S. REG. NOS. 1,151,229, 1,273,845 AND OTHERS.

FOR PROVIDING ON-LINE NON-DOWNLOADABLE SOFTWARE FOR USE IN DATABASE MANAGEMENT IN THE FIELD OF ANNUITIES (U.S. CLS. 100 AND 101).

BRIDGETT SMITH, EXAMINING ATTORNEY

SN 77-179,933. ASSOCIATED EQUIPMENT CO., INC., NASHVILLE, TN. FILED 5-14-2007.

Indoor Comfort ... Beyond Hot & Cold

THE MARK CONSISTS OF STANDARD CHARACTERS WITHOUT CLAIM TO ANY PARTICULAR FONT, STYLE, SIZE, OR COLOR.

NO CLAIM IS MADE TO THE EXCLUSIVE RIGHT TO USE "INDOOR COMFORT", APART FROM THE MARK AS SHOWN.

FOR TESTING OF INDOOR AIR QUALITY FOR RESIDENTIAL PURPOSES (U.S. CLS. 100 AND 101).

FIRST USE 2-24-2007; IN COMMERCE 2-24-2007.

JASON LOTT, EXAMINING ATTORNEY

CLASS 42—(Continued).

SN 77-195,763. VERTICAL SYSTEMS, INC., SUNNYVALE, CA. FILED 6-1-2007.

MobilePrint

THE MARK CONSISTS OF STANDARD CHARACTERS WITHOUT CLAIM TO ANY PARTICULAR FONT, STYLE, SIZE, OR COLOR.

FOR APPLICATION SERVICE PROVIDER, NAMELY, PROVIDING, HOSTING, MANAGING, DEVELOPING, AND MAINTAINING APPLICATIONS, SOFTWARE, WEBSITES, AND DATABASES IN THE FIELDS OF PERSONAL PRODUCTIVITY, WIRELESS COMMUNICATION, MOBILE INFORMATION ACCESS, AND REMOTE DATA MANAGEMENT FOR WIRELESS DELIVERY OF CONTENT TO HANDHELD COMPUTERS, LAPTOPS AND MOBILE ELECTRONIC DEVICES (U.S. CLS. 100 AND 101).

HENRY S. ZAK, EXAMINING ATTORNEY

CLASS 42—(Continued).

SN 78-712,250. X-FEDS, INC., LA MESA, CA. FILED 9-13-2005.



X-celence in business and engineering solutions

NO CLAIM IS MADE TO THE EXCLUSIVE RIGHT TO USE "EXCELLENCE IN BUSINESS AND ENGINEERING SOLUTIONS", APART FROM THE MARK AS SHOWN.

THE COLOR(S) BLACK AND GREY IS/ARE CLAIMED AS A FEATURE OF THE MARK.

THE MARK CONSISTS OF A LARGE LETTER "X" WITH THE CAPITALIZED LETTERS "FEDS" ACROSS THE CENTER AND THE WORDING "X-CELLENCE IN BUSINESS AND ENGINEERING SOLUTIONS" BELOW IT. THE LETTER "X" APPEARS IN BLACK AND IS SHADOWED IN GRAY NEAR THE CROSS OF THE LETTER. THE LETTERS "FEDS" AND THE WORDING "X-CELLENCE IN BUSINESS AND ENGINEERING SOLUTIONS" APPEAR IN BLACK AND ARE SHADOWED IN GRAY.

FOR DESIGN FOR OTHERS IN THE FIELD OF ENGINEERING; TECHNOLOGY CONSULTATION IN THE FIELD OF ENGINEERING (U.S. CLS. 100 AND 101).

FIRST USE 1-1-2004; IN COMMERCE 1-1-2004.

ALICIA COLLINS, EXAMINING ATTORNEY

SN 78-417,992. PACIFIC MUNICIPAL CONSULTANTS, SACRAMENTO, CA. FILED 5-13-2004.



FOR INSPECTIONS OF EXISTING BUILDINGS AND PROPERTIES FOR ZONING AND MUNICIPAL CODE COMPLIANCE; CODE COMPLIANCE, NAMELY, REVIEWING STANDARDS AND PRACTICES TO ENSURE COMPLIANCE WITH ZONING AND ENVIRONMENTAL LAWS AND REGULATIONS (U.S. CLS. 100 AND 101).

FIRST USE 10-30-2003; IN COMMERCE 6-1-2004.

JOHN SCHUYLER YARD, EXAMINING ATTORNEY

SN 78-779,734. LANCTOT, KRISTA, TORONTO, CANADA, FILED 12-22-2005.

MORE

THE MARK CONSISTS OF STANDARD CHARACTERS WITHOUT CLAIM TO ANY PARTICULAR FONT, STYLE, SIZE, OR COLOR.

OWNER OF CANADA REG. NO. TMA679806, DATED 1-19-2007, EXPIRES 1-19-2022.

FOR INVESTIGATIVE RESEARCH SERVICES RELATING TO HEALTH, NAMELY, MEDICAL RESEARCH AND PHARMACEUTICAL RESEARCH SERVICES (U.S. CLS. 100 AND 101).

BERYL GARDNER, EXAMINING ATTORNEY

CLASS 42—(Continued).

SN 78-794,704. THATCHER TECHNOLOGY GROUP, LLC, ADDISON, IL. FILED 1-19-2006.



OWNER OF U.S. REG. NO. 2,802,950.

NO CLAIM IS MADE TO THE EXCLUSIVE RIGHT TO USE "TECHNOLOGY GROUP, LLC", APART FROM THE MARK AS SHOWN.

THE MARK CONSISTS OF THE GRAY IN THE MARK IS TO INDICATE SHADING ONLY.

FOR COMPUTER SOFTWARE DESIGN AND DEVELOPMENT FOR OTHERS; CONSULTING SERVICES IN THE FIELD OF DESIGN, SELECTION, IMPLEMENTATION AND USE OF COMPUTER HARDWARE AND SOFTWARE SYSTEMS FOR OTHERS; CUSTOM COMPUTER PROGRAMMING FOR OTHERS; INTEGRATION OF COMPUTER SOFTWARE; AND COMPUTER SOFTWARE IMPLEMENTATION (U.S. CLS. 100 AND 101).

FIRST USE 4-0-2000; IN COMMERCE 4-0-2000.
GILBERT SWIFT, EXAMINING ATTORNEY

SN 78-826,021. MORTEN, BERNADETTE E, PENNINGTON, NJ. FILED 3-1-2006.

Bodhi Design

THE MARK CONSISTS OF STANDARD CHARACTERS WITHOUT CLAIM TO ANY PARTICULAR FONT, STYLE, SIZE, OR COLOR.

NO CLAIM IS MADE TO THE EXCLUSIVE RIGHT TO USE "DESIGN", APART FROM THE MARK AS SHOWN.

THE ENGLISH TRANSLATION OF "BODHI" IS "AWAKENED."

FOR ARCHITECTURAL DESIGN (U.S. CLS. 100 AND 101).

MICHAEL LEWIS, EXAMINING ATTORNEY

SN 78-855,290. ENVIRONMENTAL LAW AND POLICY CENTER OF THE MIDWEST, CHICAGO, IL. FILED 4-6-2006.

ENVIRONMENT GREAT PLAINS

THE MARK CONSISTS OF STANDARD CHARACTERS WITHOUT CLAIM TO ANY PARTICULAR FONT, STYLE, SIZE, OR COLOR.

OWNER OF U.S. REG. NOS. 2,229,845 AND 2,840,117.

NO CLAIM IS MADE TO THE EXCLUSIVE RIGHT TO USE "ENVIRONMENT", APART FROM THE MARK AS SHOWN.

FOR LEGAL SERVICES AND LEGAL CONSULTING SERVICES IN THE FIELDS OF ENVIRONMENTAL QUALITY, PUBLIC HEALTH AND ECONOMIC DEVELOPMENT (U.S. CLS. 100 AND 101).

PAULA MAHONEY, EXAMINING ATTORNEY

CLASS 42—(Continued).

SN 78-899,250. GROUP NBT PLC., LONDON, ENGLAND, FILED 6-2-2006.

NETNAMES

THE MARK CONSISTS OF STANDARD CHARACTERS WITHOUT CLAIM TO ANY PARTICULAR FONT, STYLE, SIZE, OR COLOR.

SEC. 2(F).

FOR PROVIDING TECHNICAL INFORMATION IN THE FIELD OF GLOBAL COMPUTER NETWORK ADDRESS AND URL REGISTRATIONS; COMPUTER SERVICES, NAMELY, PROVIDING SEARCH ENGINES FOR OBTAINING INFORMATION RELATING TO THE REGISTRATION OF GLOBAL COMPUTER NETWORK ADDRESSES AND URLS, VIA A GLOBAL COMPUTER NETWORK; AND REGISTRATION AND MAINTENANCE OF GLOBAL COMPUTER NETWORK ADDRESSES AND URLS VIA A GLOBAL COMPUTER NETWORK (U.S. CLS. 100 AND 101).

FIRST USE 2-0-1996; IN COMMERCE 2-0-1996.

MICHAEL TANNER, EXAMINING ATTORNEY

SN 78-903,715. ACCESS SYSTEMS AMERICAS, INC., SUNNYVALE, CA. FILED 6-8-2006.

IMESSENGER

THE MARK CONSISTS OF STANDARD CHARACTERS WITHOUT CLAIM TO ANY PARTICULAR FONT, STYLE, SIZE, OR COLOR.

OWNER OF U.S. REG. NO. 2,356,273.

SEC. 2(F).

FOR CUSTOM SOFTWARE AND DATABASE PROGRAMMING, TECHNICAL SUPPORT AND SOFTWARE MAINTENANCE SERVICES FOR OTHERS FOR HANDHELD MOBILE COMPUTERS, SMART PHONES AND FEATURE PHONES (U.S. CLS. 100 AND 101).

PETER CHENG, EXAMINING ATTORNEY

CLASS 42—(Continued).

SN 78-931,129. EMEDICALFILES, INC., ATLANTA, GA. FILED 7-17-2006.

EMEDICALFILES

THE MARK CONSISTS OF STANDARD CHARACTERS WITHOUT CLAIM TO ANY PARTICULAR FONT, STYLE, SIZE, OR COLOR.

OWNER OF U.S. REG. NO. 2,955,910.
SEC. 2(F).

FOR APPLICATION SERVICE PROVIDER (ASP) FEATURING SOFTWARE FOR MAINTAINING PERSONAL MEDICAL HISTORY RECORDS AND FILES ACCESSIBLE BY MEANS OF A GLOBAL COMPUTER NETWORK (U.S. CLS. 100 AND 101).

FIRST USE 3-31-2001; IN COMMERCE 3-31-2001.
ASMAT KHAN, EXAMINING ATTORNEY

CLASS 42—(Continued).

SN 78-953,536. THE COMPLEX SALE, INC., ALPHARETTA, GA. FILED 8-16-2006.

SALES PROPHET

THE MARK CONSISTS OF STANDARD CHARACTERS WITHOUT CLAIM TO ANY PARTICULAR FONT, STYLE, SIZE, OR COLOR.

NO CLAIM IS MADE TO THE EXCLUSIVE RIGHT TO USE "SALES", APART FROM THE MARK AS SHOWN.

FOR COMPUTER SERVICES, NAMELY, PROVIDING TEMPORARY USE OF ON-LINE NON-DOWNLOADABLE COMPUTER SOFTWARE THAT IS ACCESSIBLE THROUGH ON-LINE CUSTOMER RELATIONSHIP MANAGEMENT (CRM) SOFTWARE APPLICATIONS OF OTHERS TO ENABLE SALES MANAGERS TO OVERSEE SALES PIPELINES AND TO ANALYZE SALES FORECASTS AND RESULTS OF THE MANAGER'S COMPANY AND SALES TEAMS (U.S. CLS. 100 AND 101).

FIRST USE 7-1-2006; IN COMMERCE 7-1-2006.
KEVON CHISOLM, EXAMINING ATTORNEY

SN 78-955,843. INTELLIGENT COMPUTER SOLUTIONS CONSULTING CORPORATION, WEST CHESTER, PA. FILED 8-18-2006.

Main Line Hosting

THE MARK CONSISTS OF STANDARD CHARACTERS WITHOUT CLAIM TO ANY PARTICULAR FONT, STYLE, SIZE, OR COLOR.

NO CLAIM IS MADE TO THE EXCLUSIVE RIGHT TO USE "HOSTING", APART FROM THE MARK AS SHOWN.

SEC. 2(F).

FOR APPLICATION SERVICE PROVIDER (ASP), NAMELY, HOSTING COMPUTER SOFTWARE APPLICATIONS OF OTHERS; COMPUTER SERVICES IN THE NATURE OF CUSTOMIZED WEB PAGES FEATURING USER-DEFINED INFORMATION, PERSONAL PROFILES AND INFORMATION; COMPUTER SERVICES, NAMELY, CREATING AND MAINTAINING WEB SITES FOR OTHERS; COMPUTER SERVICES, NAMELY, DESIGNING AND IMPLEMENTING NETWORK WEB PAGES FOR OTHERS; COMPUTER SERVICES, NAMELY, DESIGNING AND IMPLEMENTING WEB SITES FOR OTHERS; COMPUTER SERVICES, NAMELY, HOSTING ONLINE WEB FACILITIES FOR OTHERS FOR ORGANIZING AND CONDUCTING ONLINE MEETINGS, GATHERINGS, AND INTERACTIVE DISCUSSIONS; COMPUTER SERVICES, NAMELY, MANAGING WEB SITES FOR OTHERS; CREATING OR MAINTAINING WEB SITES FOR OTHERS; CREATION AND MAINTENANCE OF WEB SITES FOR OTHERS (U.S. CLS. 100 AND 101).

FIRST USE 12-15-1999; IN COMMERCE 1-5-2000.
AMOS T. MATTHEWS, JR., EXAMINING ATTORNEY

SN 78-936,466. AMERICAN INTELLECTUAL PROPERTY LAW ASSOCIATION, INC., ARLINGTON, VA. FILED 7-24-2006.

AIPLA DIRECT

THE MARK CONSISTS OF STANDARD CHARACTERS WITHOUT CLAIM TO ANY PARTICULAR FONT, STYLE, SIZE, OR COLOR.

OWNER OF U.S. REG. NO. 3,029,133.

NO CLAIM IS MADE TO THE EXCLUSIVE RIGHT TO USE "DIRECT", APART FROM THE MARK AS SHOWN.

FOR PROVIDING INFORMATION ONLINE RELATING TO INTELLECTUAL PROPERTY LEGAL ISSUES (U.S. CLS. 100 AND 101).

FIRST USE 3-17-2006; IN COMMERCE 3-17-2006.
REBECCA POVARCHUK, EXAMINING ATTORNEY

CLASS 42—(Continued).

SN 78-960,104. SPECIALIZED SERVICES & CONSULTING, INC., SPARKS, NV. FILED 8-24-2006.



Specialized Services & Consulting, Inc.

NO CLAIM IS MADE TO THE EXCLUSIVE RIGHT TO USE "SERVICES & CONSULTING, INC.", APART FROM THE MARK AS SHOWN.

THE COLOR(S) RED, BLACK AND WHITE IS/ARE CLAIMED AS A FEATURE OF THE MARK.

THE MARK CONSISTS OF THE DESIGN OF THREE INTERLOCKING LETTERS SSC THAT IS OUTLINED IN THE COLORS BLACK AND WHITE AND SHADED IN RED LOCATED ON THE LEFT-HAND SIDE OF THE MARK; THE COLOR RED APPEARS IN THE LETTER "S" OF SPECIALIZED, THE LETTER "S" IN SERVICES AND THE LETTER "C" IN CONSULTING; THE COLOR BLACK APPEARS IN THE LETTERS "PECIALIZED ERVICES & ONSULTING, INC" AND IN THE UNDERLINE BENEATH THE WORDING SPECIALIZED SERVICES & CONSULTING INC, LOCATED IN THE CENTER OF THE MARK.

SEC. 2(F) AS TO "SPECIALIZED".

FOR COMPUTER DIAGNOSTIC SERVICES; COMPUTER DISASTER RECOVERY PLANNING; COMPUTER NETWORK DESIGN FOR OTHERS; COMPUTER SECURITY SERVICE, NAMELY, RESTRICTING ACCESS TO AND BY COMPUTER NETWORKS TO AND OF UNDESIRE WEB SITES, MEDIA AND INDIVIDUALS AND FACILITIES; COMPUTER SERVICES, NAMELY, CREATING AND MAINTAINING WEB SITES FOR OTHERS; COMPUTER SERVICES, NAMELY, DATA RECOVERY SERVICES; COMPUTER SERVICES, NAMELY, DESIGNING AND IMPLEMENTING NETWORK WEB PAGES FOR OTHERS; COMPUTER SERVICES, NAMELY, DESIGNING AND IMPLEMENTING WEB SITES FOR OTHERS; COMPUTER SERVICES, NAMELY, FILTERING OF UNWANTED E-MAILS; COMPUTER SOFTWARE DESIGN FOR OTHERS; COMPUTER SOFTWARE DESIGN, COMPUTER PROGRAMMING, OR MAINTENANCE OF COMPUTER SOFTWARE; COMPUTER VIRUS PROTECTION SERVICES; CONSULTING SERVICES IN THE FIELD OF DESIGN, SELECTION, IMPLEMENTATION AND USE OF COMPUTER HARDWARE AND SOFTWARE SYSTEMS FOR OTHERS; DESIGN AND DEVELOPMENT OF NETWORKS; DESIGN OF HOME PAGES, COMPUTER SOFTWARE AND WEB SITES; DESIGN, DEVELOPMENT AND IMPLEMENTATION OF SOFTWARE; DEVELOPMENT OF SOFTWARE FOR SECURE NETWORK OPERATIONS; DOCUMENT DATA TRANSFER FROM ONE COMPUTER FORMAT TO ANOTHER; INFORMATION TECHNOLOGY CONSULTATION; INTEGRATION OF COMPUTER SYSTEMS AND NETWORKS; MONITORING THE COMPUTER SYSTEMS OF OTHERS FOR TECHNICAL PURPOSES AND PROVIDING BACK-UP COMPUTER PROGRAMS AND FACILITIES; PLANNING, DEVELOPMENT AND TECHNICAL SUPPORT OF ELECTRONIC COMMUNICATIONS NETWORKS; RECOVERY OF COMPUTER DATA; TECHNICAL SUPPORT SERVICES, NAMELY, TROUBLESHOOTING OF COMPUTER HARDWARE AND SOFTWARE PROBLEMS; TECHNICAL SUPPORT, NAMELY, MONITORING OF NETWORK SYSTEMS; TECHNICAL SUPPORT, NAMELY, PROVIDING BACK-UP COMPUTER PROGRAMS AND FACILITIES (U.S. CLS. 100 AND 101).

MICHAEL LEWIS, EXAMINING ATTORNEY

CLASS 42—(Continued).

SN 78-964,450. THE PIATCHEK LAW FIRM, LLC, SPRINGFIELD, MO. FILED 8-30-2006.

Affordable Legal Services

THE MARK CONSISTS OF STANDARD CHARACTERS WITHOUT CLAIM TO ANY PARTICULAR FONT, STYLE, SIZE, OR COLOR.

NO CLAIM IS MADE TO THE EXCLUSIVE RIGHT TO USE "LEGAL SERVICES", APART FROM THE MARK AS SHOWN.

FOR LEGAL RESEARCH; LEGAL SERVICES; LICENSING OF INTELLECTUAL PROPERTY; MEDIATION; PROVIDING INFORMATION RELATING TO LEGAL AFFAIRS (U.S. CLS. 100 AND 101).

FIRST USE 8-15-2005; IN COMMERCE 8-15-2005.

AISHA CLARKE, EXAMINING ATTORNEY

SN 78-965,816. RESERCOM, L.P., IRVING, TX. FILED 9-1-2006.

RESERCOM

THE MARK CONSISTS OF STANDARD CHARACTERS WITHOUT CLAIM TO ANY PARTICULAR FONT, STYLE, SIZE, OR COLOR.

FOR PRODUCT RESEARCH AND DEVELOPMENT OF COMPUTER SOFTWARE FOR RESTAURANTS; PROVIDING ON-LINE NON-DOWNLOADABLE SOFTWARE FOR ONLINE FOOD ORDERING THROUGH THE INTERNET (U.S. CLS. 100 AND 101).

FIRST USE 6-0-2005; IN COMMERCE 6-0-2005.

EDWARD FENNESSY, EXAMINING ATTORNEY

SN 78-965,839. RESERCOM, L.P., IRVING, TX. FILED 9-1-2006.

RAZ

THE MARK CONSISTS OF STANDARD CHARACTERS WITHOUT CLAIM TO ANY PARTICULAR FONT, STYLE, SIZE, OR COLOR.

FOR PROVIDING ON-LINE NON-DOWNLOADABLE SOFTWARE FOR USE IN THE OPERATIONS OF RESTAURANTS (U.S. CLS. 100 AND 101).

FIRST USE 6-15-2005; IN COMMERCE 6-15-2005.

EDWARD FENNESSY, EXAMINING ATTORNEY

CLASS 42—(Continued).

SN 78-966,144. PACIFIC CONNECTOR GAS PIPELINE, LP, SALT LAKE CITY, UT. FILED 9-1-2006.

PACIFIC CONNECTOR

THE MARK CONSISTS OF STANDARD CHARACTERS WITHOUT CLAIM TO ANY PARTICULAR FONT, STYLE, SIZE, OR COLOR.

FOR DESIGN, PLANNING, AND ENGINEERING OF A PIPELINE FOR THE TRANSPORTATION OF NATURAL GAS (U.S. CLS. 100 AND 101).

LINDSEY RUBIN, EXAMINING ATTORNEY

SN 78-968,682. BRISTOL-MYERS SQUIBB COMPANY, NEW YORK, NY. FILED 9-7-2006.

**VINCEnT (VINflunine
Cisplatin inEligible Trial)**

THE MARK CONSISTS OF STANDARD CHARACTERS WITHOUT CLAIM TO ANY PARTICULAR FONT, STYLE, SIZE, OR COLOR.

NO CLAIM IS MADE TO THE EXCLUSIVE RIGHT TO USE "VINFLUNINE CISPLATIN INELIGIBLE TRIAL", APART FROM THE MARK AS SHOWN.

FOR MEDICAL AND SCIENTIFIC RESEARCH, NAMELY, CONDUCTING CLINICAL TRIALS AND CLINICAL STUDIES RELATING TO PHARMACEUTICAL PREPARATIONS FOR HUMAN USE (U.S. CLS. 100 AND 101).

ELLEN PERKINS, EXAMINING ATTORNEY

SN 78-969,116. DASHBOARD METRICS LLC, ANN ARBOR, MI. FILED 9-7-2006.



NO CLAIM IS MADE TO THE EXCLUSIVE RIGHT TO USE "DASHBOARD METRICS", APART FROM THE MARK AS SHOWN.

THE MARK CONSISTS OF THE LITERAL ELEMENTS OF THE MARK ARRANGED NEAR A DESIGN COMPRISING COLUMNS OF INCREASING HEIGHT.

FOR PROVIDING ON-LINE NON-DOWNLOADABLE SOFTWARE FOR PROJECT, GOAL, AND EMPLOYEE MANAGEMENT USED FOR TRACKING, DISPLAYING, AND IMPLEMENTING A NUMBER OF BUSINESS PROJECTS OR BUSINESS GOALS THAT ARE INPUT BY EMPLOYEES OF A BUSINESS AND TO DISPLAY INFORMATION REGARDING THE STATUS OF THE BUSINESS PROJECT OR BUSINESS GOAL IN ORDER TO ACCESS OVERALL BUSINESS AND EMPLOYEE PERFORMANCE AND PRODUCTIVITY (U.S. CLS. 100 AND 101).

CYNTHIA SLOAN, EXAMINING ATTORNEY

CLASS 42—(Continued).

SN 78-969,130. DASHBOARD METRICS LLC, ANN ARBOR, MI. FILED 9-7-2006.

IDEASBANK

THE MARK CONSISTS OF STANDARD CHARACTERS WITHOUT CLAIM TO ANY PARTICULAR FONT, STYLE, SIZE, OR COLOR.

FOR PROVIDING ON-LINE NON-DOWNLOADABLE SOFTWARE FOR PROJECT, GOAL, AND EMPLOYEE MANAGEMENT USED FOR TRACKING, DISPLAYING, AND IMPLEMENTING A NUMBER OF BUSINESS PROJECTS OR BUSINESS GOALS THAT ARE INPUT BY EMPLOYEES OF A BUSINESS AND TO DISPLAY INFORMATION REGARDING THE STATUS OF THE BUSINESS PROJECT OR BUSINESS GOAL IN ORDER TO ACCESS OVERALL BUSINESS AND EMPLOYEE PERFORMANCE AND PRODUCTIVITY (U.S. CLS. 100 AND 101).

CYNTHIA SLOAN, EXAMINING ATTORNEY

SN 78-969,414. GLOBAL ALERTS, LLC, SCOTTSDALE, AZ. FILED 9-7-2006.

**We'll All Be Looking For
You**

THE MARK CONSISTS OF STANDARD CHARACTERS WITHOUT CLAIM TO ANY PARTICULAR FONT, STYLE, SIZE, OR COLOR.

FOR DESIGN AND DEVELOPMENT OF INFORMATION AND DATA BASES FOR USE WITH FEDERAL AND STATE AMBER ALERT SYSTEMS; DESIGN AND DEVELOPMENT OF ON-LINE COMPUTER SOFTWARE SYSTEMS FOR USE WITH FEDERAL AND STATE AMBER ALERT SYSTEMS; DESIGN, DEVELOPMENT AND IMPLEMENTATION OF SOFTWARE FOR USE WITH FEDERAL AND STATE AMBER ALERT SYSTEMS; DEVELOPMENT OF SOFTWARE FOR SECURE NETWORK OPERATIONS FOR USE WITH FEDERAL AND STATE AMBER ALERT SYSTEMS; DEVELOPMENT, UPDATING AND MAINTENANCE OF SOFTWARE AND DATA BASES FOR USE WITH FEDERAL AND STATE AMBER ALERT SYSTEMS (U.S. CLS. 100 AND 101).

FIRST USE 8-16-2004; IN COMMERCE 12-14-2004.

REBECCA POVARCHUK, EXAMINING ATTORNEY

CLASS 42—(Continued).

SN 78-969,976. HOWSTUFFWORKS, INC., ATLANTA, GA.
FILED 9-8-2006.

BO WEN WANG

THE MARK CONSISTS OF STANDARD CHARACTERS WITHOUT CLAIM TO ANY PARTICULAR FONT, STYLE, SIZE, OR COLOR.

NO CLAIM IS MADE TO THE EXCLUSIVE RIGHT TO USE "WANG", APART FROM THE MARK AS SHOWN.

THE NAME BO WEN WANG DOES NOT IDENTIFY A LIVING INDIVIDUAL.

THE FOREIGN WORDING IN THE MARK TRANSLATES INTO ENGLISH AS WELL-VERSED WEB.

FOR INFORMATION SERVICES, NAMELY, PROVIDING A WIDE RANGE OF INFORMATION IN THE FIELDS OF SCIENCE AND TECHNOLOGY VIA A GLOBAL COMPUTER NETWORK (U.S. CLS. 100 AND 101).

APRIL ROACH, EXAMINING ATTORNEY

SN 78-971,929. ENERGY INDUSTRIES, LLC., HONOLULU, HI. FILED 9-11-2006.

Energy Industries

THE MARK CONSISTS OF STANDARD CHARACTERS WITHOUT CLAIM TO ANY PARTICULAR FONT, STYLE, SIZE, OR COLOR.

NO CLAIM IS MADE TO THE EXCLUSIVE RIGHT TO USE INDUSTRIES, APART FROM THE MARK AS SHOWN. SEC. 2(F).

FOR TECHNOLOGY CONSULTATION IN THE FIELD OF ENERGY MANAGEMENT AND ENERGY CONSERVATION; DESIGNING AND IMPLEMENTING ENERGY CONSERVATION PROGRAMS FOR OTHERS (U.S. CLS. 100 AND 101).

FIRST USE 5-1-1994; IN COMMERCE 5-1-1997.

SAIMA MAKHDOOM, EXAMINING ATTORNEY

CLASS 43—HOTEL AND RESTAURANT SERVICES

SN 76-493,770. SCOTTO, VINCENZO, CLAYMONT, DE. AND SCOTTO, BIAGIO, CLAYMONT, DE. FILED 2-28-2003.

WATERFALL BANQUET & CONFERENCE CENTER

NO CLAIM IS MADE TO THE EXCLUSIVE RIGHT TO USE BANQUET & CONFERENCE CENTER, APART FROM THE MARK AS SHOWN.

FOR PROVIDING BANQUET AND SOCIAL FUNCTION FACILITIES FOR SPECIAL OCCASIONS; CATERING SERVICES; RESTAURANT SERVICES (U.S. CLS. 100 AND 101).

ZHALEH DELANEY, EXAMINING ATTORNEY

SN 76-664,994. TRINITY CARE SENIOR LIVING, LLC, FRIENDSWOOD, TX. FILED 8-22-2006.

TRINITY CARE

THE MARK CONSISTS OF STANDARD CHARACTERS WITHOUT CLAIM TO ANY PARTICULAR FONT, STYLE, SIZE, OR COLOR.

NO CLAIM IS MADE TO THE EXCLUSIVE RIGHT TO USE "CARE", APART FROM THE MARK AS SHOWN.

FOR PROVIDING ELDER CARE, SPECIFICALLY, PROVIDING ASSISTED LIVING FACILITIES AND RETIREMENT HOMES FOR SENIOR CITIZENS AND ASSISTED LIVING FACILITIES FOR ALZHEIMERS PATIENTS (U.S. CLS. 100 AND 101).

FIRST USE 1-0-2000; IN COMMERCE 1-0-2000.

JOHN DWYER, EXAMINING ATTORNEY

SN 76-674,029. SARRIS, PETER, FALLS CHURCH, VA. FILED 3-12-2007.

CORNED BEEF KING

THE MARK CONSISTS OF STANDARD CHARACTERS WITHOUT CLAIM TO ANY PARTICULAR FONT, STYLE, SIZE, OR COLOR.

NO CLAIM IS MADE TO THE EXCLUSIVE RIGHT TO USE "CORNED BEEF", APART FROM THE MARK AS SHOWN.

FOR RESTAURANT, CATERING AND CARRY OUT SERVICES FEATURING PREPARED AND READY TO EAT INTERNATIONAL CUISINE AND BAR SERVICES (U.S. CLS. 100 AND 101).

RONALD AIKENS, EXAMINING ATTORNEY

CLASS 43—(Continued).

SN 77-001,407. WESTIN HOTEL MANAGEMENT, L.P.,
WHITE PLAINS, NY. FILED 9-18-2006.



THE COLOR(S) GREEN, AND LT. GREEN IS/ARE CLAIMED AS A FEATURE OF THE MARK.

THE MARK CONSISTS OF A PARTIAL CIRCLE IN LT. GREEN WITH A GREEN HALF MOON WITHIN THE PARTIAL CIRCLE AND THE TERM ELEMENT IN GREEN IN A STYLIZED FONT.

FOR HOTELS, MOTELS, RESORT HOTELS, TOURIST INNS, PROVIDING MEETING ROOM FACILITIES, AND MAKING HOTEL RESERVATION FOR OTHERS (U.S. CLS. 100 AND 101).

DAVID COLLIER, EXAMINING ATTORNEY

SN 77-001,545. WESTIN HOTEL MANAGEMENT, L.P.,
WHITE PLAINS, NY. FILED 9-18-2006.



OWNER OF U.S. REG. NOS. 1,320,080, 3,182,786 AND OTHERS.

NO CLAIM IS MADE TO THE EXCLUSIVE RIGHT TO USE "HOTELS", APART FROM THE MARK AS SHOWN.

THE COLOR(S) BROWN, WHITE AND GRAY IS/ARE CLAIMED AS A FEATURE OF THE MARK.

THE MARK CONSISTS OF THE COLOR BROWN APPEARS AS A BACKGROUND COLOR IN THE DESIGN. THE COLOR GRAY APPEARS IN THE CIRCULAR DESIGN AND WITHIN THE WORDS ELEMENT WESTIN HOTELS. THE COLOR WHITE APPEARS WITHIN THE SEMI CIRCULAR DESIGN.

FOR HOTELS, MOTELS, RESORT HOTELS, TOURIST INNS, PROVIDING MEETING ROOM FACILITIES, AND MAKING HOTEL RESERVATION FOR OTHERS (U.S. CLS. 100 AND 101).

DAVID COLLIER, EXAMINING ATTORNEY

CLASS 43—(Continued).

SN 77-001,571. WESTIN HOTEL MANAGEMENT, L.P.,
WHITE PLAINS, NY. FILED 9-18-2006.



THE MARK CONSISTS OF A CIRCULAR DEVICE WITH A HALF MOON.

FOR HOTELS, MOTELS, RESORT HOTELS, TOURIST INNS, PROVIDING MEETING ROOM FACILITIES, AND MAKING HOTEL RESERVATION FOR OTHERS (U.S. CLS. 100 AND 101).

DAVID COLLIER, EXAMINING ATTORNEY

SN 77-005,112. SOCIÉTÉ DES HÔTELS MÉRIDIEN, PARIS,
FRANCE, FILED 9-22-2006.

ONE NIGHT

THE MARK CONSISTS OF STANDARD CHARACTERS WITHOUT CLAIM TO ANY PARTICULAR FONT, STYLE, SIZE, OR COLOR.

FOR TEMPORARY ACCOMMODATIONS, NAMELY HOTEL AND RESORT SERVICES, PROVISION OF CONFERENCE, EXHIBITION AND MEETING FACILITIES (U.S. CLS. 100 AND 101).

PAUL E. FAHRENKOPF, EXAMINING ATTORNEY

SN 77-025,326. PERSONAL CHEF CHEO, LLC, MIAMI, FL,
FILED 10-19-2006.

CHEO HOUSE OF WINGS

THE MARK CONSISTS OF STANDARD CHARACTERS WITHOUT CLAIM TO ANY PARTICULAR FONT, STYLE, SIZE, OR COLOR.

NO CLAIM IS MADE TO THE EXCLUSIVE RIGHT TO USE "HOUSE OF WINGS", APART FROM THE MARK AS SHOWN.

FOR RESTAURANT SERVICES; AND CATERING SERVICES (U.S. CLS. 100 AND 101).

NICHOLAS ALTREE, EXAMINING ATTORNEY

CLASS 43—(Continued).

SN 77-066,170. WESTIN HOTEL MANAGEMENT, L.P.,
WHITE PLAINS, NY. FILED 12-18-2006.

UNWIND A WESTIN EVENING RITUAL

THE MARK CONSISTS OF STANDARD CHARACTERS
WITHOUT CLAIM TO ANY PARTICULAR FONT, STYLE,
SIZE, OR COLOR.

OWNER OF U.S. REG. NOS. 1,320,080, 3,182,786 AND
OTHERS.

FOR HOTEL, MOTEL, MOTOR INN AND RESORT
LODGING SERVICES, SERVING OF FOOD AND BEV-
ERAGES (U.S. CLS. 100 AND 101).

FIRST USE 9-0-2005; IN COMMERCE 9-0-2005.

DAVID COLLIER, EXAMINING ATTORNEY

SN 77-095,797. INTERNATIONAL MARKETPLACE INC.,
DETROIT, MI. FILED 1-31-2007.

THE BEAN BAR

THE MARK CONSISTS OF STANDARD CHARACTERS
WITHOUT CLAIM TO ANY PARTICULAR FONT, STYLE,
SIZE, OR COLOR.

NO CLAIM IS MADE TO THE EXCLUSIVE RIGHT TO
USE "BAR", APART FROM THE MARK AS SHOWN.

FOR RESTAURANT, CAFE, AND COFFEE HOUSE
SERVICES (U.S. CLS. 100 AND 101).

AISHA CLARKE, EXAMINING ATTORNEY

SN 77-100,023. EISENTR, INC., DOWNERS GROVE, IL.
FILED 2-6-2007.

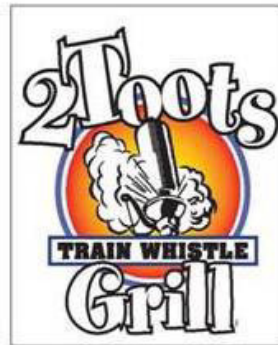

NO CLAIM IS MADE TO THE EXCLUSIVE RIGHT TO
USE GRILL, APART FROM THE MARK AS SHOWN.

THE COLOR(S) BLACK, WHITE, ORANGE, YELLOW,
AND BLUE IS/ARE CLAIMED AS A FEATURE OF THE
MARK.

THE MARK CONSISTS OF A GRAPHIC WITH A CIRCLE
IN YELLOW AND ORANGE WITH BLUE CIRCULAR

CLASS 43—(Continued).

OUTLINE, AND A TRAIN WHISTLE IN BLACK AND
WHITE WITH STEAM IN WHITE INSIDE THE CIRCLE,
WITH A RECTANGLE WITH A BLUE OUTLINE GOING
THROUGH THE CIRCLE AT THE BOTTOM WITH THE
WORDS TRAIN WHISTLE IN BLACK INSIDE THE REC-
TANGLE, AND THE WORD GRILL BELOW THE RECTAN-
GLE IN WHITE AND OUTLINED IN BLACK TOUCHING
THE BOTTOM OF THE CIRCLE, AND THE WORDS 2
TOOTS ABOVE IN WHITE AND OUTLINED IN BLACK
AND TOUCHING THE TOP OF THE CIRCLE.

FOR RESTAURANT SERVICES (U.S. CLS. 100 AND
101).

FIRST USE 1-18-2007; IN COMMERCE 1-18-2007.

JAMES STEIN, EXAMINING ATTORNEY

SN 77-100,849. LAWLERS SOUTHERN FOODS III, INC.,
ATHENS, AL. FILED 2-6-2007.



NO CLAIM IS MADE TO THE EXCLUSIVE RIGHT TO
USE "TASTY BARBECUE", APART FROM THE MARK AS
SHOWN.

THE COLOR(S) RED, YELLOW, WHITE, BLACK, PINK,
AND TAN IS/ARE CLAIMED AS A FEATURE OF THE
MARK.

THE COLOR RED APPEARS ON THE RECTANGLE; THE
COLOR YELLOW APPEARS ON THE OUTLINE OF THE
RECTANGLE WITH CURVED EDGES; THE COLORS YEL-
LOW AND BLACK APPEAR ON THE WORDING BARBE-
CUE; THE COLORS WHITE AND BLACK APPEAR ON THE
WORDING LAWLERS; THE COLOR WHITE APPEARS ON
THE WORD TASTY WHICH IS ON A BLACK RECTANGLE;
THE STYLIZED DESIGN OF THE PIG IS IN THE COLORS
BLACK AND TAN; THE STYLIZED PIG'S NOSE IS IN THE
COLORS BLACK AND PINK.

FOR RESTAURANTS (U.S. CLS. 100 AND 101).

FIRST USE 12-1-1999; IN COMMERCE 5-1-2000.

COLLEEN DOMBROW, EXAMINING ATTORNEY

CLASS 43—(Continued).

SN 77-114,364. DICUFFA, JILL, AUSTIN, TX. AND WIGHT, RONALD DAVID, AUSTIN, TX. FILED 2-23-2007.

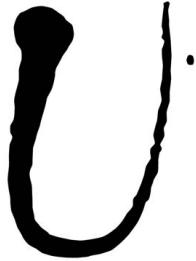

UNCORKED

TASTING ROOM & WINE BAR

NO CLAIM IS MADE TO THE EXCLUSIVE RIGHT TO USE "TASTING ROOM & WINE BAR", APART FROM THE MARK AS SHOWN.

THE MARK CONSISTS OF THE PHRASE UNCORKED TASTING ROOM & WINE BAR, WITH A STYLIZED U. FOR WINE BARS (U.S. CLS. 100 AND 101).
RONALD AIKENS, EXAMINING ATTORNEY

SN 77-121,581. NACHO CHICK INC., FARR WEST, UT. FILED 3-2-2007.

Nacho Chick

THE MARK CONSISTS OF STANDARD CHARACTERS WITHOUT CLAIM TO ANY PARTICULAR FONT, STYLE, SIZE, OR COLOR.

NO CLAIM IS MADE TO THE EXCLUSIVE RIGHT TO USE "NACHO", APART FROM THE MARK AS SHOWN. FOR MEXICAN RESTAURANT SERVICES (U.S. CLS. 100 AND 101).

ANGELA GAW, EXAMINING ATTORNEY

SN 77-125,989. CORNERSTONE MANAGEMENT & CONSULTING, INC., WATERBURY, CT. FILED 3-8-2007.

SOLTORO TEQUILA GRILL

THE MARK CONSISTS OF STANDARD CHARACTERS WITHOUT CLAIM TO ANY PARTICULAR FONT, STYLE, SIZE, OR COLOR.

NO CLAIM IS MADE TO THE EXCLUSIVE RIGHT TO USE "TEQUILA GRILL", APART FROM THE MARK AS SHOWN.

FOR RESTAURANT AND BAR SERVICES; CATERING (U.S. CLS. 100 AND 101).

DAVID H. STINE, EXAMINING ATTORNEY

CLASS 43—(Continued).

SN 77-135,138. STARKEY, CYNTHIA, WAXHAW, NC. FILED 3-20-2007.



NO CLAIM IS MADE TO THE EXCLUSIVE RIGHT TO USE "CAMP", APART FROM THE MARK AS SHOWN.

THE APPLICANT CLAIMS COLOR AS A FEATURE OF THE MARK, NAMELY, BROWN WHITE.

THE MARK CONSISTS OF BROWN AND WHITE LOGS FORM THE WORDS CAMP BARK IN AN ARC.

FOR PET BOARDING SERVICES; PET DAY CARE SERVICES (U.S. CLS. 100 AND 101).

FIRST USE 0-0-2006; IN COMMERCE 0-0-2006.
B. PARADEWELAI, EXAMINING ATTORNEY

SN 77-136,534. MEZAN, ERIC, PARIS, FRANCE, FILED 3-21-2007.

Art, Bed and Breakfast

THE MARK CONSISTS OF STANDARD CHARACTERS WITHOUT CLAIM TO ANY PARTICULAR FONT, STYLE, SIZE, OR COLOR.

NO CLAIM IS MADE TO THE EXCLUSIVE RIGHT TO USE "BED AND BREAKFAST", APART FROM THE MARK AS SHOWN.

FOR PROVIDING TRAVEL LODGING INFORMATION SERVICES AND TRAVEL LODGING BOOKING AGENCY SERVICES FOR TRAVELERS; RESORT LODGING SERVICES; TRAVEL AGENCY SERVICES, NAMELY, MAKING RESERVATIONS AND BOOKING FOR TEMPORARY LODGING (U.S. CLS. 100 AND 101).

FIRST USE 9-1-2005; IN COMMERCE 9-1-2005.
KENNETH E. SHARPERSON, EXAMINING ATTORNEY

SN 77-145,621. ADI'S BUILT-IN BURGERS & DOGS, LAS VEGAS, NV. FILED 3-31-2007.

Adi's Built-in Burgers

THE MARK CONSISTS OF STANDARD CHARACTERS WITHOUT CLAIM TO ANY PARTICULAR FONT, STYLE, SIZE, OR COLOR.

NO CLAIM IS MADE TO THE EXCLUSIVE RIGHT TO USE "BURGERS", APART FROM THE MARK AS SHOWN. FOR RESTAURANTS (U.S. CLS. 100 AND 101).

COLLEEN KEARNEY, EXAMINING ATTORNEY

CLASS 43—(Continued).

SN 77-145,623. ADI'S BUILT-IN BURGERS & DOGS, LAS VEGAS, NV. FILED 3-31-2007.

Built-in Burger

THE MARK CONSISTS OF STANDARD CHARACTERS WITHOUT CLAIM TO ANY PARTICULAR FONT, STYLE, SIZE, OR COLOR.

NO CLAIM IS MADE TO THE EXCLUSIVE RIGHT TO USE "BURGER", APART FROM THE MARK AS SHOWN.

FOR RESTAURANTS (U.S. CLS. 100 AND 101).
COLLEEN KEARNEY, EXAMINING ATTORNEY

SN 77-148,330. DELAVASSELAIS, PETER, ATLANTIC BEACH, FL. FILED 4-4-2007.

RAINBOW ORGANICS

THE MARK CONSISTS OF STANDARD CHARACTERS WITHOUT CLAIM TO ANY PARTICULAR FONT, STYLE, SIZE, OR COLOR.

NO CLAIM IS MADE TO THE EXCLUSIVE RIGHT TO USE "ORGANICS", APART FROM THE MARK AS SHOWN.

FOR SERVING FOOD AND DRINKS (U.S. CLS. 100 AND 101).

MICHAEL ENGEL, EXAMINING ATTORNEY

SN 77-149,172. CSC MAYFAIR LAND LIMITED PARTNERSHIP, WEST PALM BEACH, FL. FILED 4-5-2007.

MAYFAIR HOTEL & SPA

THE MARK CONSISTS OF STANDARD CHARACTERS WITHOUT CLAIM TO ANY PARTICULAR FONT, STYLE, SIZE, OR COLOR.

OWNER OF U.S. REG. NO. 3,078,197.

NO CLAIM IS MADE TO THE EXCLUSIVE RIGHT TO USE "HOTEL & SPA", APART FROM THE MARK AS SHOWN.

FOR HOTEL, BAR AND RESTAURANT SERVICES; SPA SERVICES, NAMELY, PROVIDING TEMPORARY ACCOMMODATIONS AND MEALS TO CLIENTS OF A HEALTH OR BEAUTY SPA (U.S. CLS. 100 AND 101).

FIRST USE 4-5-2007; IN COMMERCE 4-5-2007.

JUSTINE D. PARKER, EXAMINING ATTORNEY

CLASS 43—(Continued).

SN 77-150,610. INDYBITE, INC., BELLEVUE, WA. FILED 4-6-2007.



NO CLAIM IS MADE TO THE EXCLUSIVE RIGHT TO USE "INDIAN GRILL", APART FROM THE MARK AS SHOWN.

THE MARK CONSISTS OF THE WORDS "INDI BITE" INSIDE AND AT TOP OF AN OVAL SHAPE IN LOWER CASE LETTERS WITH THE WORDS "INDIAN GRILL" DIRECTLY BELOW IN CAPITAL LETTERS. THERE IS A FLOWER SYMBOL ABOVE THE SECOND "I" IN "INDI".

FOR CATERING FOR THE PROVISION OF FOOD AND BEVERAGES; CATERING IN FAST-FOOD CAFETERIAS; CATERING OF FOOD AND DRINKS; CONTRACT FOOD SERVICES; FAST FOOD AND NON-STOP RESTAURANT SERVICES; FAST-FOOD RESTAURANTS; FAST-FOOD RESTAURANTS AND SNACK-BARS; FOOD PREPARATION SERVICES; MOBILE CAFE SERVICES FOR PROVIDING FOOD AND DRINK; PREPARATION OF FOOD AND BEVERAGES; SERVING FOOD AND DRINKS; SERVING OF FOOD AND DRINK/ BEVERAGES (U.S. CLS. 100 AND 101).

SHANNON TWOHIG, EXAMINING ATTORNEY

SN 77-152,353. WILD ONION LLC, GLENDALE, MD. FILED 4-9-2007.



NO CLAIM IS MADE TO THE EXCLUSIVE RIGHT TO USE "ONION", APART FROM THE MARK AS SHOWN.

THE MARK CONSISTS OF A HORIZONTAL RECTANGLE WITH A BORDER. WILD ONION IS IN ALL CAPS, CENTERED HORIZONTALLY AND PLACED SLIGHTLY BELOW THE VERTICAL MIDPOINT. THE W AND O ARE A SLIGHTLY LARGER FONT. WILD ONION AND THE SPACE THAT SEPARATES THE WORDS IS UNDERLINED. A SCALLION IS PLACED BETWEEN THE WORDS WILD AND ONION AND COVERS THE UNDERLINE.

FOR CAFES (U.S. CLS. 100 AND 101).

FIRST USE 1-23-2006; IN COMMERCE 2-1-2006.

NAKWAMA ANKRAH, EXAMINING ATTORNEY

CLASS 43—(Continued).

SN 77-154,801. THE RESTAURANT COMPANY, RICHMOND, VA. FILED 4-12-2007.

CIN CIN

THE MARK CONSISTS OF STANDARD CHARACTERS WITHOUT CLAIM TO ANY PARTICULAR FONT, STYLE, SIZE, OR COLOR.

FOR RESTAURANT AND CATERING SERVICES (U.S. CLS. 100 AND 101).
 GEORGIA CARTY, EXAMINING ATTORNEY

SN 77-156,044. LANTSMAN, MARAT, STUDIO CITY, CA. AND LANTSMAN, ZOYA, STUDIO CITY, CA. FILED 4-13-2007.

City of Love

THE MARK CONSISTS OF STANDARD CHARACTERS WITHOUT CLAIM TO ANY PARTICULAR FONT, STYLE, SIZE, OR COLOR.

FOR RESTAURANT SERVICES (U.S. CLS. 100 AND 101).
 TINA BROWN, EXAMINING ATTORNEY

SN 77-156,737. ZUM RITTER CORP., SANTA MONICA, CA. FILED 4-13-2007.

P.S. BLU

THE MARK CONSISTS OF STANDARD CHARACTERS WITHOUT CLAIM TO ANY PARTICULAR FONT, STYLE, SIZE, OR COLOR.

FOR RESTAURANT SERVICES, BAR SERVICES, CATERING SERVICES, PROVIDING BANQUET AND SOCIAL FUNCTION FACILITIES FOR SPECIAL OCCASIONS (U.S. CLS. 100 AND 101).
 GENE MACIOL, EXAMINING ATTORNEY

CLASS 43—(Continued).

SN 77-156,939. C R K MANAGEMENT, LLC, PITTSBURGH, PA. FILED 4-14-2007.



NO CLAIM IS MADE TO THE EXCLUSIVE RIGHT TO USE "GRILL", APART FROM THE MARK AS SHOWN.

THE MARK CONSISTS OF STYLIZED LETTERS COMPRISING THE WORDS "STONEPEPPER'S GRILL".
 FOR RESTAURANT AND BAR SERVICES (U.S. CLS. 100 AND 101).
 ANGELA M. MICHELI, EXAMINING ATTORNEY

SN 77-157,104. THE TONEY WATKINS COMPANY, CHICAGO, IL. FILED 4-15-2007.

MUSIC CITY, ILLINOIS
 DESTINATION AND CONVENTION
 RESORT

THE MARK CONSISTS OF STANDARD CHARACTERS WITHOUT CLAIM TO ANY PARTICULAR FONT, STYLE, SIZE, OR COLOR.

NO CLAIM IS MADE TO THE EXCLUSIVE RIGHT TO USE "ILLINOIS DESTINATION AND CONVENTION RESORT", APART FROM THE MARK AS SHOWN.

FOR ARENA SERVICES, NAMELY, PROVIDING FACILITIES FOR SPORTS, CONCERTS, CONVENTIONS AND EXHIBITIONS; CAFE-RESTAURANTS; CARRY-OUT RESTAURANTS; DELICATESSENS; FAST FOOD AND NON-STOP RESTAURANT SERVICES; FAST-FOOD RESTAURANTS; FAST-FOOD RESTAURANTS AND SNACKBARS; HEALTH RESORT SERVICES, NAMELY, PROVIDING FOOD AND LODGING THAT SPECIALIZE IN PROMOTING PATRONS' GENERAL HEALTH AND WELL-BEING; HOTEL SERVICES; HOTEL SERVICES FOR PREFERRED CUSTOMERS; HOTEL, BAR AND RESTAURANT SERVICES; HOTELS; MAKING HOTEL RESERVATIONS FOR OTHERS; PROVIDING CONVENTION FACILITIES; PROVIDING FACILITIES FOR EXHIBITIONS; PROVIDING TEMPORARY LODGING SERVICES IN THE NATURE OF A CONDOMINIUM HOTEL; RESERVATION OF HOTEL ROOMS FOR TRAVELERS; RESERVATION OF HOTEL ROOMS FOR TRAVELLERS; RESERVATION OF RESTAURANTS; RESORT HOTELS; RESORT LODGING SERVICES; RESTAURANT AND BAR SERVICES; RESTAURANT SERVICES; RESTAURANTS; SELF-SERVICE RESTAURANTS; TAKE-OUT RESTAURANT SERVICES; TRAVEL AGENCY SERVICES, NAMELY, MAKING RESERVATIONS AND BOOKINGS FOR RESTAURANTS AND MEALS (U.S. CLS. 100 AND 101).
 BRIDGETT SMITH, EXAMINING ATTORNEY

CLASS 43—(Continued).

SN 77-157,432. FACTORY SUSHI JAPANESE RESTAURANT, TORRANCE, CA. FILED 4-16-2007.



NO CLAIM IS MADE TO THE EXCLUSIVE RIGHT TO USE "FUSION SUSHI", APART FROM THE MARK AS SHOWN.

THE COLOR(S) RED, YELLOW, BLUE, GRAY, WHITE, BLACK AND TAN IS/ARE CLAIMED AS A FEATURE OF THE MARK.

THE MARK IS COMPRISED OF A SAMURAI DRESSED IN THE COLOR RED WITH BLACK TRIM, WITH A BLUE AND GRAY SASH WITH TAN TASSELS, AND GRAY PANTS AND GRAY SWORD, HAVING BLACK AND GRAY HAIR, AND BLACK FACIAL FEATURES WITH RED FACE PAINT. HIS SKIN, BEING FACE, ARMS AND HANDS AND ONE FOOT, ARE IN WHITE AND THE FOOT ON THE LEFT SIDE IS IN GRAY. HE STANDS ON A YELLOW AND RED SHRIMP ON A BED OF RICE THAT IS GRAY ABOVE BLUE STYLIZED WAVES IN SHADES OF BLUE. THE WORDS FUSION SUSHI ARE IN WHITE LETTERS OUTLINED TO THE LEFT IN BLACK AND TO THE RIGHT IN RED.

FOR RESTAURANT SERVICES (U.S. CLS. 100 AND 101).

FIRST USE 4-17-2000; IN COMMERCE 4-17-2000.
LINDA POWELL, EXAMINING ATTORNEY

SN 77-157,445. HIGHTOWER, DAN, SAN CLEMENTE, CA. FILED 4-16-2007.

Mama's
able.com

THE MARK CONSISTS OF THE WORD MAMA'S OVER THE WORD TABLE.COM.

FOR PROVIDING A DATABASE IN THE FIELD OF RECIPES AND COOKING INFORMATION (U.S. CLS. 100 AND 101).

FIRST USE 1-9-2000; IN COMMERCE 1-9-2000.
CARRIE GENOVESE, EXAMINING ATTORNEY

CLASS 43—(Continued).

SN 77-157,658. NEIGHBORHOOD SENIOR LIVING, INC., DALLAS, TX. FILED 4-16-2007.

LIFE AS YOU WANT IT...CARE
AS YOU NEED IT.

THE MARK CONSISTS OF STANDARD CHARACTERS WITHOUT CLAIM TO ANY PARTICULAR FONT, STYLE, SIZE, OR COLOR.

FOR PROVIDING ASSISTED LIVING FACILITIES (U.S. CLS. 100 AND 101).

FIRST USE 6-1-1995; IN COMMERCE 6-1-1995.
JANET LEE, EXAMINING ATTORNEY

SN 77-157,961. EPIPHANY CLUBS AND RESORTS LLC, GREENWOOD VILLAGE, CO. FILED 4-16-2007.

EPIPHANY'S AVAILABILITY
GUARANTEE

THE MARK CONSISTS OF STANDARD CHARACTERS WITHOUT CLAIM TO ANY PARTICULAR FONT, STYLE, SIZE, OR COLOR.

NO CLAIM IS MADE TO THE EXCLUSIVE RIGHT TO USE "AVAILABILITY GUARANTEE", APART FROM THE MARK AS SHOWN.

FOR PRIVATE RESIDENCE CLUB SERVICES, NAMELY, PROVISION TO CLUB MEMBERS OF TEMPORARY ACCOMMODATIONS IN COMPANY OWNED OR LEASED PRIVATE RESIDENCES (U.S. CLS. 100 AND 101).

FIRST USE 2-17-2007; IN COMMERCE 2-17-2007.
JAMES LOVELACE, EXAMINING ATTORNEY

SN 77-157,970. EPIPHANY CLUBS AND RESORTS LLC, GREENWOOD VILLAGE, CO. FILED 4-16-2007.

EPIPHANY CLUBS & RESORTS

THE MARK CONSISTS OF STANDARD CHARACTERS WITHOUT CLAIM TO ANY PARTICULAR FONT, STYLE, SIZE, OR COLOR.

NO CLAIM IS MADE TO THE EXCLUSIVE RIGHT TO USE "CLUBS & RESORTS", APART FROM THE MARK AS SHOWN.

FOR PRIVATE RESIDENCE CLUB SERVICES, NAMELY, PROVISION TO CLUB MEMBERS OF TEMPORARY ACCOMMODATIONS IN COMPANY OWNED OR LEASED PRIVATE RESIDENCES (U.S. CLS. 100 AND 101).

JAMES LOVELACE, EXAMINING ATTORNEY

CLASS 43—(Continued).

SN 77-158,984. HEIRS OF ALEX AND ENGRACIA REYES SR., INC., MALATE, MANILA, PHILIPPINES, FILED 4-17-2007.

ARISTOCRAT BARBEQUE AND
GRILL

THE MARK CONSISTS OF STANDARD CHARACTERS WITHOUT CLAIM TO ANY PARTICULAR FONT, STYLE, SIZE, OR COLOR.

NO CLAIM IS MADE TO THE EXCLUSIVE RIGHT TO USE "BARBEQUE AND GRILL", APART FROM THE MARK AS SHOWN.

FOR RESTAURANT SERVICES, CATERING, TAKE-OUT RESTAURANT SERVICES, CARRY-OUTS, RESTAURANT SERVICES FEATURING HOME DELIVERY (U.S. CLS. 100 AND 101).

MIDGE BUTLER, EXAMINING ATTORNEY

SN 77-159,048. BROWN PALACE HOTEL ASSOCIATES LIMITED PARTNERSHIP, DENVER, CO. FILED 4-17-2007.



OWNER OF U.S. REG. NOS. 2,693,210 AND 2,693,211.
NO CLAIM IS MADE TO THE EXCLUSIVE RIGHT TO USE "HOTEL AND SPA", APART FROM THE MARK AS SHOWN.

THE MARK CONSISTS OF WORDS IN THE MIDDLE OF A CIRCLE IN FRONT OF A COLUMN WITH THE DEPICTION OF A CREATURE ON EACH SIDE WHICH HAVE WINGS THAT BORDER THE SIDES OF THE CIRCLE.

FOR PROVIDING TEMPORARY ACCOMMODATION; SPA SERVICES, NAMELY, PROVIDING TEMPORARY ACCOMMODATIONS AND MEALS TO CLIENTS OF A HEALTH OR BEAUTY SPA; HOTEL, BAR AND RESTAURANT SERVICES; PROVIDING BANQUET AND SOCIAL FUNCTION FACILITIES FOR SPECIAL OCCASIONS; PROVISION OF CONFERENCE, EXHIBITION AND MEETING FACILITIES; RESERVATION OF HOTEL ROOMS FOR TRAVELERS (U.S. CLS. 100 AND 101).

FIRST USE 12-19-2005; IN COMMERCE 12-19-2005.

JULIE WATSON, EXAMINING ATTORNEY

CLASS 43—(Continued).

SN 77-159,312. WESTIN HOTEL MANAGEMENT, L.P., WHITE PLAINS, NY. FILED 4-18-2007.

BARSU

THE MARK CONSISTS OF STANDARD CHARACTERS WITHOUT CLAIM TO ANY PARTICULAR FONT, STYLE, SIZE, OR COLOR.

FOR HOTEL, BAR AND RESTAURANT SERVICES (U.S. CLS. 100 AND 101).

ROBIN CHOSID, EXAMINING ATTORNEY

SN 77-159,670. ITALIAN COFFEE S.A. DE C.V., PUEBLA, PUE, MEXICO, FILED 4-18-2007.



NO CLAIM IS MADE TO THE EXCLUSIVE RIGHT TO USE "THE ITALIAN COFFEE COMPANY", APART FROM THE MARK AS SHOWN.

THE MARK CONSISTS OF A RENDITION OF A FACTORY-TYPE BUILDING AND THREE SMOKESTACKS.

FOR RESTAURANTS FEATURING ITALIAN-STYLE COFFEE, TEA AND RELATED COFFEE AND TEA BASED BEVERAGES, SOFT DRINKS, ITALIAN-STYLE SANDWICHES AND PASTRIES (U.S. CLS. 100 AND 101).

FIRST USE 0-0-1995; IN COMMERCE 4-1-2007.

MICHELE SWAIN, EXAMINING ATTORNEY

SN 77-159,691. EROL, NURI, ANNANDALE, VA. FILED 4-18-2007.

MANGINOS

THE MARK CONSISTS OF STANDARD CHARACTERS WITHOUT CLAIM TO ANY PARTICULAR FONT, STYLE, SIZE, OR COLOR.

FOR CARRY-OUT RESTAURANTS; FAST-FOOD RESTAURANTS; RESTAURANTS; TAKE-OUT RESTAURANT SERVICES (U.S. CLS. 100 AND 101).

FIRST USE 9-0-2003; IN COMMERCE 9-0-2003.

LEIGH CAROLINE CASE, EXAMINING ATTORNEY

CLASS 43—(Continued).

SN 77-160,010. ECHELON RESORTS CORPORATION, LAS VEGAS, NV. FILED 4-18-2007.

TAKE ME HIGHER

THE MARK CONSISTS OF STANDARD CHARACTERS WITHOUT CLAIM TO ANY PARTICULAR FONT, STYLE, SIZE, OR COLOR.

FOR ARENA SERVICES, NAMELY PROVIDING FACILITIES FOR SPORTS, CONCERTS, CONVENTIONS AND EXHIBITIONS; HOTEL SERVICES; RESORT HOTELS; PROVIDING CONVENTION FACILITIES (U.S. CLS. 100 AND 101).

KATHLEEN M. VANSTON, EXAMINING ATTORNEY

SN 77-160,061. ECHELON RESORTS CORPORATION, LAS VEGAS, NV. FILED 4-18-2007.

**EXPLORE. EMBRACE.
ELEVATE.**

THE MARK CONSISTS OF STANDARD CHARACTERS WITHOUT CLAIM TO ANY PARTICULAR FONT, STYLE, SIZE, OR COLOR.

FOR ARENA SERVICES, NAMELY PROVIDING FACILITIES FOR SPORTS, CONCERTS, CONVENTIONS AND EXHIBITIONS; HOTEL, BAR AND RESTAURANT SERVICES; PROVIDING CONVENTION FACILITIES; RESORT HOTELS (U.S. CLS. 100 AND 101).

KATHLEEN M. VANSTON, EXAMINING ATTORNEY

SN 77-160,242. LOONEY BEEN ROASTING COMPANY, BEND, OR. FILED 4-19-2007.

LOONEY BEAN

THE MARK CONSISTS OF STANDARD CHARACTERS WITHOUT CLAIM TO ANY PARTICULAR FONT, STYLE, SIZE, OR COLOR.

FOR COFFEE SHOPS (U.S. CLS. 100 AND 101).

CHERYL CLAYTON, EXAMINING ATTORNEY

CLASS 43—(Continued).

SN 77-160,449. LEAVE IT TO DAN, LLC, TRAVERSE CITY, MI. FILED 4-19-2007.

Red Ginger

THE MARK CONSISTS OF STANDARD CHARACTERS WITHOUT CLAIM TO ANY PARTICULAR FONT, STYLE, SIZE, OR COLOR.

FOR RESTAURANT SERVICES; CATERING (U.S. CLS. 100 AND 101).

ELI HELLMAN, EXAMINING ATTORNEY

SN 77-160,799. MAYNER, TODD, BLOOMINGTON, IL. FILED 4-19-2007.

Boo Boo's Dawghouse

THE MARK CONSISTS OF STANDARD CHARACTERS WITHOUT CLAIM TO ANY PARTICULAR FONT, STYLE, SIZE, OR COLOR.

FOR SERVING OF FOOD AND DRINK/BEVERAGES (U.S. CLS. 100 AND 101).

FIRST USE 3-3-1997; IN COMMERCE 3-3-1997.

LYDIA BELZER, EXAMINING ATTORNEY

SN 77-161,224. MADDY'S MANAGEMENT, INC., LAS VEGAS, NV. FILED 4-19-2007.

MADDY'S

THE MARK CONSISTS OF STANDARD CHARACTERS WITHOUT CLAIM TO ANY PARTICULAR FONT, STYLE, SIZE, OR COLOR.

FOR BAR SERVICES (U.S. CLS. 100 AND 101).

FIRST USE 3-0-1995; IN COMMERCE 3-0-1995.

SAMUEL E. SHARPER JR., EXAMINING ATTORNEY

CLASS 43—(Continued).

SN 77-161,418. FYKE, CHRISTIAN, VERONA, PA. FILED 4-20-2007.

RIVERTOWNE

THE MARK CONSISTS OF STANDARD CHARACTERS WITHOUT CLAIM TO ANY PARTICULAR FONT, STYLE, SIZE, OR COLOR.

FOR HOTEL, BAR AND RESTAURANT SERVICES (U.S. CLS. 100 AND 101).

NORA BUCHANAN WILL, EXAMINING ATTORNEY

SN 77-161,435. FYKE, CHRISTIAN, VERONA, PA. FILED 4-20-2007.



THE COLOR(S) PURPLISH-BLUE, BLACK, BROWN, RED, YELLOW AND CREAM IS/ARE CLAIMED AS A FEATURE OF THE MARK.

THE MARK CONSISTS OF A FISH STANDING UPRIGHT HOLDING A MUG OF BEER IN HIS LEFT HAND. THE FISH IS PURPLISH-BLUE IN COLOR WITH A BROWN COWBOY HAT WITH A RED BAND. THE OUTLINE OF THE ELEMENTS OF THE MARK, THE UNDERSIDE OF THE HAT, THE BACKGROUND OF THE TAIL, THE OUTLINE OF THE SCALES, THE EYE, THE INSIDE OF THE MOUTH AND THE ANCHOR TATTOO ON THE RIGHT ARM OF THE FISH ARE ALL IN BLACK. THE BEER THE FISH IS HOLDING IS YELLOW IN COLOR WITH CREAM FOAM.

FOR HOTEL, BAR AND RESTAURANT SERVICES (U.S. CLS. 100 AND 101).

NORA BUCHANAN WILL, EXAMINING ATTORNEY

SN 77-161,613. YANG, LENG, ADA, MI. FILED 4-20-2007.

Mynt Fusion

THE MARK CONSISTS OF STANDARD CHARACTERS WITHOUT CLAIM TO ANY PARTICULAR FONT, STYLE, SIZE, OR COLOR.

FOR RESTAURANT SERVICES (U.S. CLS. 100 AND 101).

VERNA BETH RIRIE, EXAMINING ATTORNEY

CLASS 43—(Continued).

SN 77-161,807. HOTELS COMBINED PTY LTD, NARRA-WEENA, AUSTRALIA, FILED 4-20-2007.

HOTELSCOMBINED

THE MARK CONSISTS OF STANDARD CHARACTERS WITHOUT CLAIM TO ANY PARTICULAR FONT, STYLE, SIZE, OR COLOR.

FOR RESERVATION OF HOTEL ROOMS FOR TRAVELLERS; SERVICES FOR THE RESERVATION OF ROOMS (U.S. CLS. 100 AND 101).

FIRST USE 1-12-2005; IN COMMERCE 1-12-2005.

RONALD AIKENS, EXAMINING ATTORNEY

SN 77-162,109. CHILD, JOSEPH R, BRIDGEVILLE, PA. FILED 4-20-2007.

Epicuria

THE MARK CONSISTS OF STANDARD CHARACTERS WITHOUT CLAIM TO ANY PARTICULAR FONT, STYLE, SIZE, OR COLOR.

FOR CATERING FOR THE PROVISION OF FOOD AND BEVERAGES; RESTAURANT SERVICES; CAFE-RESTAURANTS; CARRY-OUT RESTAURANTS; DELICATESSENS; FAST FOOD AND NON-STOP RESTAURANT SERVICES; FAST-FOOD RESTAURANTS; FAST-FOOD RESTAURANTS AND SNACKBARS; HOTEL, BAR AND RESTAURANT SERVICES; PROVIDING ADVICE TO TOURISTS AND BUSINESS TRAVELERS ON HOTEL AND RESTAURANT DESTINATIONS; PROVIDING ONLINE REVIEWS OF RESTAURANTS AND HOTELS; RESERVATION OF RESTAURANTS; RESTAURANT AND BAR SERVICES (U.S. CLS. 100 AND 101).

ROBIN CHOSID, EXAMINING ATTORNEY

SN 77-164,285. ZUM RITTER CORP., SANTA MONICA, CA. FILED 4-24-2007.

P.S. V.ino

THE MARK CONSISTS OF STANDARD CHARACTERS WITHOUT CLAIM TO ANY PARTICULAR FONT, STYLE, SIZE, OR COLOR.

FOR RESTAURANT SERVICES, BAR SERVICES, CATERING SERVICES, PROVIDING BANQUET AND SOCIAL FUNCTION FACILITIES FOR SPECIAL OCCASIONS (U.S. CLS. 100 AND 101).

GENE MACIOL, EXAMINING ATTORNEY

CLASS 43—(Continued).

SN 77-166,001. WESTIN HOTEL MANAGEMENT, L.P.,
WHITE PLAINS, NY. FILED 4-26-2007.

LIGHTHEARTED

THE MARK CONSISTS OF STANDARD CHARACTERS
WITHOUT CLAIM TO ANY PARTICULAR FONT, STYLE,
SIZE, OR COLOR.

FOR HOTEL SERVICES, NAMELY, SERVING AND
CATERING OF FOOD AND BEVERAGES (U.S. CLS. 100
AND 101).

ROBIN CHOSID, EXAMINING ATTORNEY

SN 77-170,502. HAN RESTAURANT INVESTMENT GROUP,
LLC, LAS VEGAS, NV. FILED 5-1-2007.

SAN TOKI

THE MARK CONSISTS OF STANDARD CHARACTERS
WITHOUT CLAIM TO ANY PARTICULAR FONT, STYLE,
SIZE, OR COLOR.

THE FOREIGN WORDING IN THE MARK TRANSLATES
INTO ENGLISH AS MOUNTAIN RABBIT.

FOR RESTAURANT SERVICES, NAMELY, KOREAN
BARBEQUE AND ASIAN CUISINE (U.S. CLS. 100 AND
101).

KENNETH E. SHARPERSON, EXAMINING ATTORNEY

SN 77-184,582. HYATT CORPORATION, CHICAGO, IL.
FILED 5-18-2007.

IT'S SO YOU

THE MARK CONSISTS OF STANDARD CHARACTERS
WITHOUT CLAIM TO ANY PARTICULAR FONT, STYLE,
SIZE, OR COLOR.

FOR HOTELS; RESORT HOTELS; MOTELS; MAKING
HOTEL RESERVATIONS FOR OTHERS; RESTAURANT,
BAR AND COCKTAIL LOUNGE SERVICES; SPECIAL-
IZED HOTEL SERVICES RENDERED AS PART OF A
PROGRAM FOR FREQUENT HOTEL GUESTS; PROVID-
ING CONFERENCE, EXHIBITION AND MEETING FAC-
ILITIES; PROVIDING BANQUET AND SOCIAL
FUNCTION FACILITIES FOR SPECIAL OCCASIONS;
CATERING FOR THE PROVISION OF FOOD AND
BEVERAGES (U.S. CLS. 100 AND 101).

FIRST USE 3-15-2007; IN COMMERCE 3-15-2007.

KARANENDRA S. CHHINA, EXAMINING ATTORNEY

CLASS 43—(Continued).

SN 77-188,993. WESTIN HOTEL MANAGEMENT, L.P.,
WHITE PLAINS, NY. FILED 5-23-2007.

A PLACE TO THRIVE

THE MARK CONSISTS OF STANDARD CHARACTERS
WITHOUT CLAIM TO ANY PARTICULAR FONT, STYLE,
SIZE, OR COLOR.

FOR HOTEL SERVICES; RESORT HOTELS (U.S. CLS.
100 AND 101).

ROBIN CHOSID, EXAMINING ATTORNEY

SN 77-195,494. WESTIN HOTEL MANAGEMENT, L.P.,
WHITE PLAINS, NY. FILED 6-1-2007.

RUNWESTIN

THE MARK CONSISTS OF STANDARD CHARACTERS
WITHOUT CLAIM TO ANY PARTICULAR FONT, STYLE,
SIZE, OR COLOR.

FOR HOTEL SERVICES; HOTELS; RESORT HOTELS
(U.S. CLS. 100 AND 101).

ROBIN CHOSID, EXAMINING ATTORNEY

SN 77-207,272. SBE ENTERTAINMENT GROUP, LLC, LOS
ANGELES, CA. FILED 6-15-2007.

SLS Beverly Hills

THE MARK CONSISTS OF STANDARD CHARACTERS
WITHOUT CLAIM TO ANY PARTICULAR FONT, STYLE,
SIZE, OR COLOR.

NO CLAIM IS MADE TO THE EXCLUSIVE RIGHT TO
USE "BEVERLY HILLS", APART FROM THE MARK AS
SHOWN.

FOR HOTEL SERVICES; HOTEL SERVICES FOR PRE-
ferred CUSTOMERS; HOTEL, BAR AND RESTAU-
RANT SERVICES; HOTELS; RESORT HOTELS (U.S. CLS.
100 AND 101).

MIDGE BUTLER, EXAMINING ATTORNEY

CLASS 43—(Continued).

SN 77-207,312. SBE ENTERTAINMENT GROUP, LLC, LOS ANGELES, CA. FILED 6-15-2007.

SLS Hotels

THE MARK CONSISTS OF STANDARD CHARACTERS WITHOUT CLAIM TO ANY PARTICULAR FONT, STYLE, SIZE, OR COLOR.

NO CLAIM IS MADE TO THE EXCLUSIVE RIGHT TO USE "HOTELS", APART FROM THE MARK AS SHOWN. FOR HOTEL SERVICES; HOTEL SERVICES FOR PREFERRED CUSTOMERS; HOTEL, BAR AND RESTAURANT SERVICES; HOTELS; RESORT HOTELS (U.S. CLS. 100 AND 101).

MIDGE BUTLER, EXAMINING ATTORNEY

SN 77-207,558. RED MANGO, INC., CULVER CITY, CA. FILED 6-15-2007.

TREAT YOURSELF WELL

THE MARK CONSISTS OF STANDARD CHARACTERS WITHOUT CLAIM TO ANY PARTICULAR FONT, STYLE, SIZE, OR COLOR.

FOR SERVING OF FOOD AND DRINK/BEVERAGES AT RESTAURANTS, CAFES AND DRINK BARS; RESTAURANT, CAFE, DRINK BAR SERVICES (U.S. CLS. 100 AND 101).

COLLEEN DOMBROW, EXAMINING ATTORNEY

SN 77-210,039. NEIGHBORHOOD SENIOR LIVING, INC., DALLAS, TX. FILED 6-19-2007.

COUNTRY PLACE

THE MARK CONSISTS OF STANDARD CHARACTERS WITHOUT CLAIM TO ANY PARTICULAR FONT, STYLE, SIZE, OR COLOR.

FOR PROVIDING ASSISTED LIVING FACILITIES (U.S. CLS. 100 AND 101).

FIRST USE 4-30-2003; IN COMMERCE 4-30-2003.
JANET LEE, EXAMINING ATTORNEY

CLASS 43—(Continued).

SN 77-218,547. WESTIN HOTEL MANAGEMENT, L.P., WHITE PLAINS, NY. FILED 6-28-2007.



THE MARK CONSISTS OF THE TERMS INGREDIENTS SOME ASSEMBLY REQUIRED WITH A CUP DEVICE.

FOR HOTEL, BAR AND RESTAURANT SERVICES; PREPARATION OF FOOD AND BEVERAGES; SERVING OF FOOD AND DRINK/BEVERAGES (U.S. CLS. 100 AND 101).

FIRST USE 10-16-2006; IN COMMERCE 10-16-2006.
ROBIN CHOSID, EXAMINING ATTORNEY

SN 77-975,050. VALLARTA SUPERMARKETS, INC., SAN FERNANDO, CA. FILED 9-21-2006.

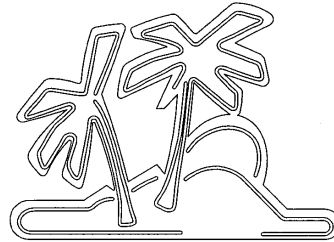

THE MARK CONSISTS OF PALM TREE DESIGN. FOR RESTAURANT SERVICES (U.S. CLS. 100 AND 101).

FIRST USE 5-0-1998; IN COMMERCE 5-0-1998.
MARY MUNSON, EXAMINING ATTORNEY

SN 78-542,477. HIGH TECH BURRITO CORPORATION, ROHNERT PARK, CA. FILED 1-5-2005.

HIGH TECH BURRITO

THE MARK CONSISTS OF STANDARD CHARACTERS WITHOUT CLAIM TO ANY PARTICULAR FONT, STYLE, SIZE, OR COLOR.

OWNER OF U.S. REG. NO. 1,801,267. SEC. 2(F) AS TO "BURRITO". FOR RESTAURANT SERVICES (U.S. CLS. 100 AND 101).

GEORGIA CARTY, EXAMINING ATTORNEY

CLASS 43—(Continued).

SN 78-552,837. MCNICHOLAS, THOMAS M., ROCKVILLE CENTRE, NY. FILED 1-24-2005.

KASEYS AMERICAN GRILLE

THE MARK CONSISTS OF STANDARD CHARACTERS WITHOUT CLAIM TO ANY PARTICULAR FONT, STYLE, SIZE, OR COLOR.

NO CLAIM IS MADE TO THE EXCLUSIVE RIGHT TO USE "AMERICAN GRILLE", APART FROM THE MARK AS SHOWN.

FOR RESTAURANT AND CATERING SERVICES (U.S. CLS. 100 AND 101).

FIRST USE 10-15-1999; IN COMMERCE 10-15-1999.
LESLEY LAMOTHE, EXAMINING ATTORNEY

SN 78-705,537. NICE N EASY GROCERY SHOPPES, INC., CANASTOTA, NY. FILED 9-1-2005.

EASY STREET EATERY

THE MARK CONSISTS OF STANDARD CHARACTERS WITHOUT CLAIM TO ANY PARTICULAR FONT, STYLE, SIZE, OR COLOR.

OWNER OF U.S. REG. NO. 1,341,695.

NO CLAIM IS MADE TO THE EXCLUSIVE RIGHT TO USE "EATERY", APART FROM THE MARK AS SHOWN.

FOR TAKE-OUT RESTAURANT SERVICES OFFERED EXCLUSIVELY THROUGH CONVENIENCE STORES (U.S. CLS. 100 AND 101).

FIRST USE 7-31-2004; IN COMMERCE 7-31-2004.
JAMES STEIN, EXAMINING ATTORNEY

SN 78-802,307. BRINKER INTERNATIONAL HOLDINGS, L.P., DALLAS, TX. FILED 1-30-2006.

BORDER SMART

THE MARK CONSISTS OF STANDARD CHARACTERS WITHOUT CLAIM TO ANY PARTICULAR FONT, STYLE, SIZE, OR COLOR.

FOR RESTAURANT AND CATERING SERVICES (U.S. CLS. 100 AND 101).

FIRST USE 11-14-2005; IN COMMERCE 11-14-2005.
JUSTINE D. PARKER, EXAMINING ATTORNEY

CLASS 43—(Continued).

SN 78-870,499. NH HOTELES, S.A., MADRID, SPAIN, FILED 4-26-2006.

NHOW

THE MARK CONSISTS OF STANDARD CHARACTERS WITHOUT CLAIM TO ANY PARTICULAR FONT, STYLE, SIZE, OR COLOR.

OWNER OF ERPN CMNTY TM OFC REG. NO. 003916111, DATED 10-11-2005, EXPIRES 7-6-2014.

FOR HOTEL, BAR AND RESTUARANT SERVICES (U.S. CLS. 100 AND 101).

PATRICIA EVANKO, EXAMINING ATTORNEY

SN 78-955,470. DARDEN CONCEPTS, INC., ORLANDO, FL. FILED 8-18-2006.

Ollie & Friends

THE MARK CONSISTS OF STANDARD CHARACTERS WITHOUT CLAIM TO ANY PARTICULAR FONT, STYLE, SIZE, OR COLOR.

FOR RESTAURANT SERVICES (U.S. CLS. 100 AND 101).

FIRST USE 6-30-2003; IN COMMERCE 6-30-2003.

RONALD MCMORROW, EXAMINING ATTORNEY

SN 78-960,878. MOORETOWN RANCHERIA OF MAIDU INDIANS OF CALIFORNIA, OROVILLE, CA. FILED 8-25-2006.

THE LODGE AT FEATHER FALLS CASINO

THE MARK CONSISTS OF STANDARD CHARACTERS WITHOUT CLAIM TO ANY PARTICULAR FONT, STYLE, SIZE, OR COLOR.

OWNER OF U.S. REG. NO. 2,906,479.

NO CLAIM IS MADE TO THE EXCLUSIVE RIGHT TO USE "LODGE", APART FROM THE MARK AS SHOWN.

FOR HOTEL SERVICES (U.S. CLS. 100 AND 101).

TINA BROWN, EXAMINING ATTORNEY

CLASS 43—(Continued).

SN 78-966,498. EVANS-WALLS, TONYA M., PHILADELPHIA, PA. AND WALLS, ORVILLE R. III, PHILADELPHIA, PA. FILED 9-2-2006.

JOY OF THE TABLE

THE MARK CONSISTS OF STANDARD CHARACTERS WITHOUT CLAIM TO ANY PARTICULAR FONT, STYLE, SIZE, OR COLOR.

FOR PROVIDING INFORMATION ABOUT WINE APPRECIATION VIA THE INTERNET (U.S. CLS. 100 AND 101).

FIRST USE 7-15-2006; IN COMMERCE 8-1-2006.
MARTHA FROMM, EXAMINING ATTORNEY

SN 78-974,024. PERET, CYRIL, PARIS, FRANCE, FILED 9-14-2006.

MELT SPA BAR

THE MARK CONSISTS OF STANDARD CHARACTERS WITHOUT CLAIM TO ANY PARTICULAR FONT, STYLE, SIZE, OR COLOR.

NO CLAIM IS MADE TO THE EXCLUSIVE RIGHT TO USE "SPA BAR", APART FROM THE MARK AS SHOWN.

FOR SERVICES FOR PROVIDING FOOD AND DRINK, NAMELY SERVING FOOD AND DRINKS; RESTAURANTS; BAR SERVICES; CATERING OF FOOD AND DRINK; SELF-SERVICE RESTAURANTS; SNACK-BARS; CAFES, CAFETERIAS (U.S. CLS. 100 AND 101).

DEIRDRE ROBERTSON, EXAMINING ATTORNEY

SN 79-034,357. PIZZA & COFFE S.R.L., ITALY, FILED 12-12-2006.



PRIORITY DATE OF 10-12-2006 IS CLAIMED.

OWNER OF INTERNATIONAL REGISTRATION 0912801 DATED 12-12-2006, EXPIRES 12-12-2016.

NO CLAIM IS MADE TO THE EXCLUSIVE RIGHT TO USE "PIZZA & COFFEE", APART FROM THE MARK AS SHOWN.

FOR CATERING FOR THE PROVISION OF BEVERAGES, SNACKS AND FOOD; RESTAURANT SERVICES; PUBS; RESTAURANTS; COFFEE-BARS; SELF-SERVICE RESTAURANTS (U.S. CLS. 100 AND 101).

DANIEL BRODY, EXAMINING ATTORNEY

CLASS 44—MEDICAL, BEAUTY AND AGRICULTURAL SERVICES

SN 76-632,758. BENNETT, KARIE, SAN JOSE, CA. FILED 3-10-2005.

ATELIER

THE MARK CONSISTS OF STANDARD CHARACTERS WITHOUT CLAIM TO ANY PARTICULAR FONT, STYLE, SIZE, OR COLOR.

ENGLISH TRANSLATION: ARTIST'S WORKSHOP
SEC. 2(F).

FOR HAIR SALON SERVICES, NAMELY HAIRCUTS, HAIR COLORING, PERMING, HAIR STRAIGHTENING AND RELAXING; HEALTH SPA SERVICES, NAMELY FACIAL MASSAGE, BODY MASSAGE, SKIN CARE SERVICES, NAMELY MAKEUP APPLICATION AND FACIALS, WAXING SERVICES NAMELY FACE, LIP, BROW, CHEEK, ARM, UNDERARM, LEG, BACK AND BIKINI WAXING (U.S. CLS. 100 AND 101).

FIRST USE 7-0-1997; IN COMMERCE 7-0-1997.

SALLY SHIH, EXAMINING ATTORNEY

SN 76-668,669. CHILDREN'S CENTER FOR GASTROENTEROLOGY AND NUTRITION, P.A., HOLLYWOOD, FL. FILED 11-7-2006.



Children's Center

GASTROENTEROLOGY & NUTRITION, P.A.

NO CLAIM IS MADE TO THE EXCLUSIVE RIGHT TO USE "CHILDREN'S CENTER GASTROENTEROLOGY & NUTRITION, P.A.", APART FROM THE MARK AS SHOWN. THE COLOR(S) BLACK, PINK, PURPLE, WHITE, SILVER, AND TEAL IS/ARE CLAIMED AS A FEATURE OF THE MARK.

THE MARK CONSISTS OF AN ANGLO/CAUCASIAN MALE CHILD WITH A PINK FACE AND FACIAL FEATURES OUTLINED IN BLACK DRESSED IN OVERSIZED SCRUBS AND LAB COAT. THE CHILD'S HAIR IS BLACK. THE HEADBAND IS PURPLE, THE REFLECTOR IS WHITE WITH BLACK SHADOWS GIVING A SILVER ILLUSION. THE STETHOSCOPE IS WHITE AND BLACK, ALSO GIVING A SILVER ILLUSION. THE SCRUBS ARE TEAL WITH BLACK SHADOWS. THE LAB COAT IS WHITE WITH BLACK SHADOWS. THE SHOES ARE PURPLE. THE REFLEX HAMMER HAS A BLACK AND SILVER HANDLE AND A PURPLE HEAD. THE "CHILDREN'S CENTER" PORTION OF THE COMPANY NAME IS IN CURSIVE/SCRIPT AND IN TEAL LETTERS. THE "GASTROENTEROLOGY & NUTRITION, P.A." IS ALL CAPITAL BLOCK LETTERS IN BLACK.

FOR MEDICAL SERVICES IN THE FIELD OF DIGESTIVE DISORDERS OF CHILDREN (U.S. CLS. 100 AND 101).

MICHELLE DUBOIS, EXAMINING ATTORNEY

CLASS 44—(Continued).

SN 77-013,153. ONCE UPON A BRIDE, INC., NEW YORK, NY. FILED 10-4-2006.

VIOLET

THE MARK CONSISTS OF STANDARD CHARACTERS WITHOUT CLAIM TO ANY PARTICULAR FONT, STYLE, SIZE, OR COLOR.

FOR BEAUTY SALON SERVICES (U.S. CLS. 100 AND 101).

FIRST USE 11-30-2005; IN COMMERCE 11-30-2005.
JOHN GARTNER, EXAMINING ATTORNEY



SN 77-013,607. NUTRILAWN US INC., CAMBRIDGE, MA. FILED 10-4-2006.

WE NOURISH LAWN AND LIVES

THE MARK CONSISTS OF STANDARD CHARACTERS WITHOUT CLAIM TO ANY PARTICULAR FONT, STYLE, SIZE, OR COLOR.

FOR LAWN CARE SERVICES; PROVIDING LAWN AND YARD CARE AND MAINTENANCE SERVICES, NAMELY, THE APPLICATION OF FERTILIZERS, HERBICIDES, AND INSECTICIDES, AERATION SERVICES, OVERSEEDING SERVICES, DETHATCHING, GRASS CUTTING, IRRIGATION, TREE AND SHRUB CARE, LAWN ROLLING, NAMELY, APPLYING WEIGHT TO A LAWN TO EVEN OUT THE GROUND, HYDROSEEING, AND TOP DRESSING NAMELY, APPLYING COMPOST AND/OR TOPSOIL TO EXISTING LAWNS; LANDSCAPE GARDENING SERVICES; AND LANDSCAPE DESIGN (U.S. CLS. 100 AND 101).

GENE MACIOL, EXAMINING ATTORNEY

CLASS 44—(Continued).

SN 77-020,840. NUTRILAWN US INC., CAMBRIDGE, MA. FILED 10-13-2006.



OWNER OF U.S. REG. NOS. 1,886,733 AND 2,017,135.
NO CLAIM IS MADE TO THE EXCLUSIVE RIGHT TO USE "ECOLOGY FRIENDLY LAWN CARE", APART FROM THE MARK AS SHOWN.

THE MARK CONSISTS OF THE WORDS NUTRI-LAWN ABOVE A SOLID BLACK LINE AND THE WORDS ECOLOGY FRIENDLY LAWN CARE BELOW THE SOLID BLACK LINE.

FOR LAWN CARE SERVICES; PROVIDING LAWN AND YARD CARE AND MAINTENANCE SERVICES, NAMELY THE APPLICATION OF FERTILIZERS, HERBICIDES, AND INSECTICIDES, AERATION SERVICES, OVERSEEDING SERVICES, DETHATCHING, GRASS CUTTING, IRRIGATING, TREE AND SHRUB CARE, LAWN ROLLING, NAMELY APPLYING WEIGHT TO A LAWN TO EVEN OUT THE GROUND, HYDROSEEDING, AND TOP DRESSING NAMELY APPLYING COMPOST AND/OR TOPSOIL TO EXISTING LAWNS; LANDSCAPE GARDENING SERVICES; AND LANDSCAPE DESIGN (U.S. CLS. 100 AND 101).

GENE MACIOL, EXAMINING ATTORNEY



SN 77-041,869. MERCY MEDICINES, BEVERLY HILLS, CA. FILED 11-10-2006.

MERCY MEDICINES

THE MARK CONSISTS OF STANDARD CHARACTERS WITHOUT CLAIM TO ANY PARTICULAR FONT, STYLE, SIZE, OR COLOR.

NO CLAIM IS MADE TO THE EXCLUSIVE RIGHT TO USE "MEDICINES", APART FROM THE MARK AS SHOWN.

FOR ELEEMOSYNARY SERVICES, NAMELY, OBTAINING PHARMACEUTICALS AND DISTRIBUTING THEM TO DEVELOPING COUNTRIES (U.S. CLS. 100 AND 101).

SHAILA SETTLES, EXAMINING ATTORNEY

CLASS 44—(Continued).

SN 77-076,548. HQ HEALTHQUEST MEDICAL & WELLNESS CENTER, LIMITED, BENTONVILLE, AR. FILED 1-5-2007.

PINK PAMPER

THE MARK CONSISTS OF STANDARD CHARACTERS WITHOUT CLAIM TO ANY PARTICULAR FONT, STYLE, SIZE, OR COLOR.

FOR HEALTH SPA SERVICES FOR HEALTH AND WELLNESS OF THE BODY AND SPIRIT OFFERED AT A MEDICAL SPA (U.S. CLS. 100 AND 101).

FIRST USE 4-0-2006; IN COMMERCE 4-0-2006.

BILL DAWE, EXAMINING ATTORNEY

SN 77-091,743. MEDTRONIC, INC., MINNEAPOLIS, MN. FILED 1-26-2007.

MEDTRONIC CAREPLUS

THE MARK CONSISTS OF STANDARD CHARACTERS WITHOUT CLAIM TO ANY PARTICULAR FONT, STYLE, SIZE, OR COLOR.

OWNER OF U.S. REG. NOS. 989,169, 1,014,415 AND OTHERS.

FOR MEDICAL CONSULTING SERVICES, NAMELY, FOLLOW UP PATIENT CONSULTATIONS (U.S. CLS. 100 AND 101).

MARK SPARACINO, EXAMINING ATTORNEY

CLASS 44—(Continued).

SN 77-110,662. EDEN SPA, INC., SAN JUAN, PUERTO RICO, FILED 2-19-2007.



NO CLAIM IS MADE TO THE EXCLUSIVE RIGHT TO USE "SPA", APART FROM THE MARK AS SHOWN.

THE COLOR(S) BLACK, WHITE, DARK GREEN AND LIGHT GREEN IS/ARE CLAIMED AS A FEATURE OF THE MARK.

THE MARK CONSISTS OF BLACK LETTERS ON TOP OF A GREEN APPLE. THE COLOR BLACK APPEARS IN THE LITERAL PORTIONS SECRETS OF EDEN SPA AND BELIEVE IN THE SECRETS OF NATURE AS WELL IN THE APPLE DESIGN-ELEMENT. THE COLORS WHITE, DARK GREEN AND LIGHT GREEN APPEAR IN THE APPLE DESIGN-ELEMENT.

FOR HEALTH SPA SERVICES FOR HEALTH AND WELLNESS OF THE BODY AND SPIRIT OFFERED AT A HEALTH RESORT (U.S. CLS. 100 AND 101).

FIRST USE 5-27-2003; IN COMMERCE 5-27-2003.

RAY THOMAS, EXAMINING ATTORNEY

SN 77-121,318. GILBERT, NANCY, BERWYN, IL. AND DOTSON, KRISTY, ROMEOVILLE, IL. FILED 3-2-2007.

COLORDINE

THE MARK CONSISTS OF STANDARD CHARACTERS WITHOUT CLAIM TO ANY PARTICULAR FONT, STYLE, SIZE, OR COLOR.

FOR NUTRITION AND WEIGHT REDUCTION PLANNING, CONTROL AND MAINTENANCE PROGRAMS INCLUDING THE DISTRIBUTION AND PROVIDING OF SUPPORT AND COURSE MATERIALS, NAMELY, MANUALS, DVDS, RECIPE BOOKS AND DIET RELATED APPARATUS IN CONNECTION THEREWITH (U.S. CLS. 100 AND 101).

MARLENE BELL, EXAMINING ATTORNEY

CLASS 44—(Continued).

SN 77-124,786. CHRISTENBURY EYE CENTER, PA, CHARLOTTE, NC. FILED 3-7-2007.

VISION TODAY

THE MARK CONSISTS OF STANDARD CHARACTERS WITHOUT CLAIM TO ANY PARTICULAR FONT, STYLE, SIZE, OR COLOR.

NO CLAIM IS MADE TO THE EXCLUSIVE RIGHT TO USE "VISION", APART FROM THE MARK AS SHOWN.

FOR MEDICAL SERVICES, NAMELY, EYE SURGERY (U.S. CLS. 100 AND 101).

WARREN L. OLANDRIA, EXAMINING ATTORNEY

SN 77-141,585. ANDERSSON, JOHN, IRVING, TX. FILED 3-27-2007.

The Lash Retreat

THE MARK CONSISTS OF STANDARD CHARACTERS WITHOUT CLAIM TO ANY PARTICULAR FONT, STYLE, SIZE, OR COLOR.

NO CLAIM IS MADE TO THE EXCLUSIVE RIGHT TO USE "LASH", APART FROM THE MARK AS SHOWN.

FOR BEAUTY SALONS (U.S. CLS. 100 AND 101).

BRIAN PINO, EXAMINING ATTORNEY

SN 77-148,010. CATHERINE DAVIDSON, SEATTLE, WA. FILED 4-4-2007.

The Potting Bench

THE MARK CONSISTS OF STANDARD CHARACTERS WITHOUT CLAIM TO ANY PARTICULAR FONT, STYLE, SIZE, OR COLOR.

FOR PLANT NURSERIES (U.S. CLS. 100 AND 101).

JESSICA FATHY, EXAMINING ATTORNEY

CLASS 44—(Continued).

SN 77-149,390. HI-ACRES, LLC, HOWEY-IN-THE-HILLS, FL. FILED 4-5-2007.

Hi-Acres Nursery

THE MARK CONSISTS OF STANDARD CHARACTERS WITHOUT CLAIM TO ANY PARTICULAR FONT, STYLE, SIZE, OR COLOR.

NO CLAIM IS MADE TO THE EXCLUSIVE RIGHT TO USE "NURSERY", APART FROM THE MARK AS SHOWN. FOR PLANT NURSERIES; TREE NURSERIES (U.S. CLS. 100 AND 101).

FIRST USE 10-1-2003; IN COMMERCE 6-1-2005.

JENNIFER DIXON, EXAMINING ATTORNEY

SN 77-151,426. ASCENTIS LLC, SACRAMENTO, CA. FILED 4-8-2007.

The Official Sports Salon

THE MARK CONSISTS OF STANDARD CHARACTERS WITHOUT CLAIM TO ANY PARTICULAR FONT, STYLE, SIZE, OR COLOR.

NO CLAIM IS MADE TO THE EXCLUSIVE RIGHT TO USE "SPORTS SALON", APART FROM THE MARK AS SHOWN.

FOR BEAUTY SALONS; HAIRDRESSING SALONS (U.S. CLS. 100 AND 101).

FIRST USE 11-18-2005; IN COMMERCE 11-18-2005.

DANIEL RUSSELL, EXAMINING ATTORNEY

SN 77-152,663. TRIAD HOSPITALS, INC., PLANO, TX. FILED 4-10-2007.

Willamette Valley Medical Center

THE MARK CONSISTS OF STANDARD CHARACTERS WITHOUT CLAIM TO ANY PARTICULAR FONT, STYLE, SIZE, OR COLOR.

NO CLAIM IS MADE TO THE EXCLUSIVE RIGHT TO USE "MEDICAL CENTER", APART FROM THE MARK AS SHOWN.

SEC. 2(F).

FOR HOSPITALS (U.S. CLS. 100 AND 101).

FIRST USE 2-1-1999; IN COMMERCE 2-1-1999.

AMY HELLA, EXAMINING ATTORNEY

CLASS 44—(Continued).

SN 77-152,671. TRIAD HOSPITALS, INC., PLANO, TX. FILED
4-10-2007.

Willamette Valley Cancer Center

THE MARK CONSISTS OF STANDARD CHARACTERS
WITHOUT CLAIM TO ANY PARTICULAR FONT, STYLE,
SIZE, OR COLOR.

NO CLAIM IS MADE TO THE EXCLUSIVE RIGHT TO
USE "CANCER CENTER", APART FROM THE MARK AS
SHOWN.

SEC. 2(F).

FOR HOSPITALS (U.S. CLS. 100 AND 101).

FIRST USE 6-26-2002; IN COMMERCE 6-26-2002.

AMY HELLA, EXAMINING ATTORNEY

SN 77-152,862. TRIAD HOSPITALS, INC., PLANO, TX. FILED
4-10-2007.

Family Tree Healthcare

THE MARK CONSISTS OF STANDARD CHARACTERS
WITHOUT CLAIM TO ANY PARTICULAR FONT, STYLE,
SIZE, OR COLOR.

NO CLAIM IS MADE TO THE EXCLUSIVE RIGHT TO
USE "HEALTHCARE", APART FROM THE MARK AS
SHOWN.

FOR HOSPITALS (U.S. CLS. 100 AND 101).

FIRST USE 9-1-1998; IN COMMERCE 9-1-1998.

AMY HELLA, EXAMINING ATTORNEY

SN 77-153,203. TRIAD HOSPITALS, INC., PLANO, TX. FILED
4-10-2007.

Claremore Regional Hospital

THE MARK CONSISTS OF STANDARD CHARACTERS
WITHOUT CLAIM TO ANY PARTICULAR FONT, STYLE,
SIZE, OR COLOR.

NO CLAIM IS MADE TO THE EXCLUSIVE RIGHT TO
USE "REGIONAL HOSPITAL", APART FROM THE MARK
AS SHOWN.

SEC. 2(F).

FOR HOSPITALS (U.S. CLS. 100 AND 101).

FIRST USE 9-15-2000; IN COMMERCE 9-15-2000.

AMY HELLA, EXAMINING ATTORNEY

CLASS 44—(Continued).

SN 77-154,224. TRIAD HOSPITALS, INC., PLANO, TX. FILED
4-11-2007.

SOUTHCREST HOSPITAL

THE MARK CONSISTS OF STANDARD CHARACTERS
WITHOUT CLAIM TO ANY PARTICULAR FONT, STYLE,
SIZE, OR COLOR.

OWNER OF U.S. REG. NO. 2,976,999.
NO CLAIM IS MADE TO THE EXCLUSIVE RIGHT TO
USE "HOSPITAL", APART FROM THE MARK AS SHOWN.

FOR HOSPITALS (U.S. CLS. 100 AND 101).

FIRST USE 5-3-1999; IN COMMERCE 5-3-1999.

STEVEN PEREZ, EXAMINING ATTORNEY

SN 77-154,743. BAUER FAMILY MEDICINE PLLC, CHAR-
LOTTE, NC. FILED 4-12-2007.



NO CLAIM IS MADE TO THE EXCLUSIVE RIGHT TO
USE "FAMILY MEDICINE", APART FROM THE MARK AS
SHOWN.

FOR GENERAL MEDICAL PRACTICE (U.S. CLS. 100
AND 101).

FIRST USE 2-1-2007; IN COMMERCE 2-1-2007.

RONALD MCMORROW, EXAMINING ATTORNEY

CLASS 44—(Continued).

SN 77-155,971. OLMSTEAD HEALTH CARE SERVICES, LLC, ALBUQUERQUE, NM. FILED 4-13-2007.



NO CLAIM IS MADE TO THE EXCLUSIVE RIGHT TO USE "NM TRAVEL HEALTH" AND "HEALTH CARE SERVICES, LLC", APART FROM THE MARK AS SHOWN.

THE MARK CONSISTS OF A STYLIZED ZIA SYMBOL WITH A GLOBE IN THE CENTER OF FOUR GROUPS OF THREE PARALLEL LINES EMANATING FROM THE GLOBE, WITH THE WORDS "NM TRAVEL HEALTH" AND "OLMSTEAD HEALTH CARE SERVICES, LLC" LOCATED ABOVE AND BELOW THE GROUP OF LINES EMANATING TO THE RIGHT, RESPECTIVELY.

FOR PROVIDING HEALTH CARE SERVICES, CONSULTATIONS, AND INFORMATION IN THE FIELD OF TRAVEL HEALTH (U.S. CLS. 100 AND 101).
ALEX KEAM, EXAMINING ATTORNEY

SN 77-156,543. CRESPO & ASSOCIATES, P.A., TAMPA, FL. FILED 4-13-2007.

**PAIN IS EVERYWHERE,
SUFFERING IS OPTIONAL**

THE MARK CONSISTS OF STANDARD CHARACTERS WITHOUT CLAIM TO ANY PARTICULAR FONT, STYLE, SIZE, OR COLOR.

FOR MEDICAL SERVICES (U.S. CLS. 100 AND 101).
FRANK LATTUCA, EXAMINING ATTORNEY

CLASS 44—(Continued).

SN 77-157,161. JOSE KATZ, CLOSTER, NJ. FILED 4-16-2007.



NO CLAIM IS MADE TO THE EXCLUSIVE RIGHT TO USE "CARDIOMEDICAL CENTERS", APART FROM THE MARK AS SHOWN.

"THE COLOR(S) BLUE, AQUAMARINE AND WHITE IS/ ARE CLAIMED AS A FEATURE OF THE MARK."

"THE MARK CONSISTS OF BLUE BACKGROUND, WITH "KATZ" IN LARGE TYPE OVER "CARDIOMEDICAL CENTERS" IN SMALLER TYPE, WITH ALL WORDS APPEARING IN THE COLOR WHITE AND SUPERIMPOSED OVER A BLUE AND AQUAMARINE CADUCEUS WHICH SLANTS FROM TOP RIGHT TO BOTTOM LEFT IN THE RIGHT THREE-FIFTHS OF THE MARK."

FOR MEDICAL CLINICS (U.S. CLS. 100 AND 101).
FIRST USE 3-15-2007; IN COMMERCE 3-15-2007.
TONI HICKEY, EXAMINING ATTORNEY

SN 77-157,179. AQUASCAPE DESIGNS, INC., ST. CHARLES, IL. FILED 4-16-2007.

PRO-FIT

THE MARK CONSISTS OF STANDARD CHARACTERS WITHOUT CLAIM TO ANY PARTICULAR FONT, STYLE, SIZE, OR COLOR.

FOR PROVIDING POND AND WATERGARDEN DESIGN SERVICES (U.S. CLS. 100 AND 101).
FIRST USE 11-1-2006; IN COMMERCE 11-1-2006.
CHRIS WELLS, EXAMINING ATTORNEY

SN 77-157,295. BAPTIST HEALTHCARE SYSTEM, INC., LOUISVILLE, KY. FILED 4-16-2007.



OWNER OF U.S. REG. NOS. 2,499,850, 3,145,167 AND OTHERS.

NO CLAIM IS MADE TO THE EXCLUSIVE RIGHT TO USE "URGENT CARE", APART FROM THE MARK AS SHOWN.

THE MARK CONSISTS OF THE WORDS BAPTIST URGENT CARE WITH THE LETTER T IN THE WORD BAPTIST CONSISTING OF A FANCIFUL REPRESENTATION OF A CRUCIFIXION CROSS.

SEC. 2(F) AS TO "BAPTIST".
FOR HEALTH CARE; MEDICAL CLINICS; URGENT MEDICAL CARE CENTERS (U.S. CLS. 100 AND 101).
FIRST USE 0-0-2004; IN COMMERCE 0-0-2004.
JASON BLAIR, EXAMINING ATTORNEY

CLASS 44—(Continued).

SN 77-157,301. BAPTIST HEALTHCARE SYSTEM, INC.,
LOUISVILLE, KY. FILED 4-16-2007.

BAPTIST MEDICAL ASSOCIATES

OWNER OF U.S. REG. NOS. 2,499,850, 3,145,167 AND OTHERS.

NO CLAIM IS MADE TO THE EXCLUSIVE RIGHT TO USE "MEDICAL ASSOCIATES", APART FROM THE MARK AS SHOWN.

THE MARK CONSISTS OF THE WORDS BAPTIST MEDICAL ASSOCIATES WITH THE LETTER T IN THE WORD BAPTIST CONSISTING OF A FANCIFUL REPRESENTATION OF A CRUCIFIXION CROSS.

SEC. 2(F) AS TO "BAPTIST".
FOR HEALTH CARE; MEDICAL CLINICS (U.S. CLS. 100 AND 101).

FIRST USE 0-0-2005; IN COMMERCE 0-0-2005.
JASON BLAIR, EXAMINING ATTORNEY

SN 77-157,305. BAPTIST HEALTHCARE SYSTEM, INC.,
LOUISVILLE, KY. FILED 4-16-2007.

BAPTIST BODYSCAN

OWNER OF U.S. REG. NOS. 2,499,850, 3,145,167 AND OTHERS.

NO CLAIM IS MADE TO THE EXCLUSIVE RIGHT TO USE "BODYSCAN", APART FROM THE MARK AS SHOWN.

THE MARK CONSISTS OF THE WORDS BAPTIST BODYSCAN WITH THE LETTER T IN THE WORD BAPTIST CONSISTING OF A FANCIFUL REPRESENTATION OF A CRUCIFIXION CROSS.

SEC. 2(F) AS TO "BAPTIST".
FOR HEALTH CARE; MEDICAL IMAGING SERVICES (U.S. CLS. 100 AND 101).

JASON BLAIR, EXAMINING ATTORNEY

SN 77-157,446. DEDERICH, MARK, GLENDORA, CA.
FILED 4-16-2007.

BART The BLOCKHOUND

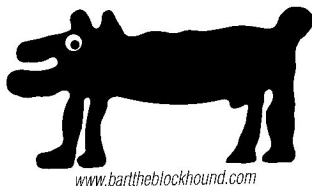

THE MARK CONSISTS OF A DOG DESIGN, WITH THE WORDING "BART THE BLOCKHOUND" ABOVE THE DESIGN AND THE WORDING "WWW.BARTTHEBLOCKHOUND.COM" BELOW THE DESIGN.

FOR ACUPUNCTURE; CHIROPRACTIC SERVICES (U.S. CLS. 100 AND 101).

FIRST USE 6-14-1993; IN COMMERCE 6-14-1993.
LAURA HAMMEL, EXAMINING ATTORNEY

CLASS 44—(Continued).

SN 77-157,577. CALVANO'S CANS, INC., DBA JOY'S JOHNS,
NILES, MI. FILED 4-16-2007.

WE GO WHERE YOU GO

THE MARK CONSISTS OF STANDARD CHARACTERS WITHOUT CLAIM TO ANY PARTICULAR FONT, STYLE, SIZE, OR COLOR.

FOR RENTAL OF PORTABLE TOILETS (U.S. CLS. 100 AND 101).

FIRST USE 0-0-1980; IN COMMERCE 0-0-1980.
CAROLINE WOOD, EXAMINING ATTORNEY

SN 77-158,093. ASCENTIS LLC, SACRAMENTO, CA. FILED
4-17-2007.

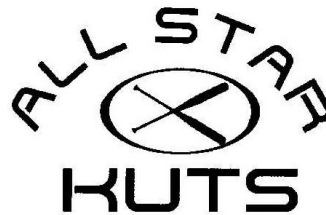

NO CLAIM IS MADE TO THE EXCLUSIVE RIGHT TO USE CUTS, APART FROM THE MARK AS SHOWN.

THE MARK CONSISTS OF THE WORDS "ALL STAR" AND "KUTS" ENCIRCLING AN OVAL LOCATED IN THE CENTER OF THE MARK THAT CONTAINS TWO CROSSED BATS.

FOR BEAUTY SALONS; HAIR SALON SERVICES, NAMELY, TREATMENTS TO PROTECT HAIR FROM AFFECTS OF EXPOSURE TO SUNLIGHT, HEAT, HUMIDITY AND CHLORINATED WATER; HAIRDRESSING SALONS; SALON SERVICES, NAMELY, FACIALS, MANICURES AND MESSAGES THAT ARE PROVIDED IN A TRAILER OUTFITTED WITH CHAIR, TABLE AND SINK ACCESSORIES (U.S. CLS. 100 AND 101).

FIRST USE 11-18-2005; IN COMMERCE 11-18-2005.
DANIEL RUSSELL, EXAMINING ATTORNEY

SN 77-158,098. WEIDLEY, SCOTT F, SAN FRANCISCO, CA.
FILED 4-17-2007.

ChiroProvider

THE MARK CONSISTS OF STANDARD CHARACTERS WITHOUT CLAIM TO ANY PARTICULAR FONT, STYLE, SIZE, OR COLOR.

FOR CHIROPRACTIC SERVICES (U.S. CLS. 100 AND 101).

GIANCARLO CASTRO, EXAMINING ATTORNEY

CLASS 44—(Continued).

SN 77-158,161. CROCKETT PEDIATRIC DENTISTRY, P.A., GREENVILLE, SC. FILED 4-17-2007.



THE MARK CONSISTS OF A CROCODILE BRUSHING HIS TEETH WITH A FROG FLOSSING ON THE CROCODILE'S TAIL.
FOR DENTIST SERVICES (U.S. CLS. 100 AND 101).
FIRST USE 7-11-2005; IN COMMERCE 7-11-2005.
CHERYL CLAYTON, EXAMINING ATTORNEY

SN 77-158,257. GREENWORKS LANDSCAPING SERVICES, INC., MIAMI, FL. FILED 4-17-2007.

Are You In the Mood For Green ...

THE MARK CONSISTS OF STANDARD CHARACTERS WITHOUT CLAIM TO ANY PARTICULAR FONT, STYLE, SIZE, OR COLOR.
FOR LANDSCAPE DESIGN (U.S. CLS. 100 AND 101).
FIRST USE 1-1-2006; IN COMMERCE 1-1-2006.
KAELIE KUNG, EXAMINING ATTORNEY

SN 77-158,465. ST. CYR, SCOTT E., JAMAICA PLAIN, MA. FILED 4-17-2007.



THE MARK CONSISTS OF A SOLID ROUND CIRCLE WITH THE NAME "ETANT" LOCATED IN THE CENTER OF THE CIRCLE.
THE FOREIGN WORDING IN THE MARK TRANSLATES INTO ENGLISH AS BEING.
FOR BODYWORK THERAPY (U.S. CLS. 100 AND 101).
SARA THOMAS, EXAMINING ATTORNEY

CLASS 44—(Continued).

SN 77-158,933. NEW LIFE SYSTEMS LLC, ATLANTA, GA. FILED 4-17-2007.



NO CLAIM IS MADE TO THE EXCLUSIVE RIGHT TO USE "INTERNATIONAL LASER THERAPY" AND "STOP SMOKING & WEIGHT LOSS", APART FROM THE MARK AS SHOWN.

THE MARK CONSISTS OF THE IMAGE OF A OVAL WORLD MAP CONTAINED WITHIN CONCENTRIC OVALS, WITH THE STYLIZED WORDS INTERNATIONAL LASER THERAPY APPEARING ABOVE THE OVAL WORLD MAP, AND THE STYLIZED WORDS STOP SMOKING & WEIGHT LOSS APPEARING BELOW THE OVAL WORLD MAP.

FOR PROVIDING LASER THERAPY FOR TREATING NICOTINE ADDICTION AND AIDING IN WEIGHT LOSS (U.S. CLS. 100 AND 101).
FIRST USE 3-26-2007; IN COMMERCE 3-26-2007.
MICHAEL WEBSTER, EXAMINING ATTORNEY

SN 77-158,944. OUER, DEAN A., KAILUA-KONA, HI. FILED 4-17-2007.

PALMPEDIA

THE MARK CONSISTS OF STANDARD CHARACTERS WITHOUT CLAIM TO ANY PARTICULAR FONT, STYLE, SIZE, OR COLOR.
FOR PROVIDING INFORMATION ONLINE IN THE FIELD OF GENERAL HORTICULTURAL KNOWLEDGE (U.S. CLS. 100 AND 101).
GISELLE AGOSTO, EXAMINING ATTORNEY

SN 77-158,953. HEART 2 HEART, AUBURN, WA. FILED 4-17-2007.

The Face Heart and Mind Foundation

THE MARK CONSISTS OF STANDARD CHARACTERS WITHOUT CLAIM TO ANY PARTICULAR FONT, STYLE, SIZE, OR COLOR.

NO CLAIM IS MADE TO THE EXCLUSIVE RIGHT TO USE "FOUNDATION", APART FROM THE MARK AS SHOWN.

FOR CHARITABLE SERVICES, NAMELY, PROVIDING PLASTIC AND RECONSTRUCTIVE SURGERY TO CHILDREN AND YOUTH IN NEED (U.S. CLS. 100 AND 101).

BRIAN CALLAGHAN, EXAMINING ATTORNEY

CLASS 44—(Continued).

SN 77-159,839. PRESBYTERIAN HEALTHCARE SERVICES, ALBUQUERQUE, NM. FILED 4-18-2007.

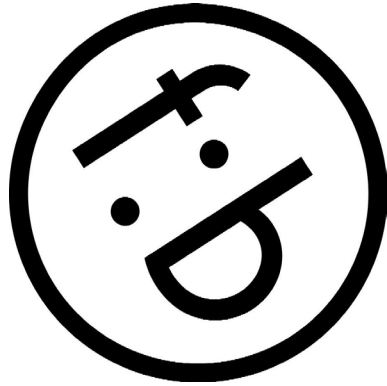

THE MARK CONSISTS OF THE CHARACTER SET "F:B" IN A CIRCLE ORIENTED TO REPRESENT A SMILEY FACE.

FOR HOSPITALS AND HEALTH CARE SERVICES (U.S. CLS. 100 AND 101).

KAREN BRACEY, EXAMINING ATTORNEY

CLASS 44—(Continued).

SN 77-160,108. MEMS MASSAGE STUDIO LLC, SEATTLE, WA. FILED 4-18-2007.



THE COLOR(S) BRICK RED AND KHAKI IS/ARE CLAIMED AS A FEATURE OF THE MARK.

THE MARK CONSISTS OF A PORTION OF THE ASHANTI SYMBOL "GYE NYAME" APPEARING IN BRICK RED AGAINST A KHAKI BACKGROUND, ENCLOSED WITHIN AN INNER BRICK RED CIRCLE, AN INTERMEDIATE KHAKI CIRCLE AND AN OUTER BRICK RED CIRCLE.

FOR MASSAGE (U.S. CLS. 100 AND 101).

FIRST USE 10-4-2004; IN COMMERCE 6-30-2005.

INGRID C. EULIN, EXAMINING ATTORNEY

SN 77-160,104. VIRGINIA LANDSCAPES INC., LOVE-TTSVILLE, VA. FILED 4-18-2007.



Virginia Landscapes

NO CLAIM IS MADE TO THE EXCLUSIVE RIGHT TO USE "VIRGINIA LANDSCAPES", APART FROM THE MARK AS SHOWN.

THE STIPPLING IS FOR SHADING PURPOSES ONLY.

THE MARK CONSISTS OF A V AND A L THAT ARE STYLED LIKE FLOWERS. THE WORDS VIRGINIA LANDSCAPES IS JUST BELOW THE V AND L.

FOR LANDSCAPE DESIGN (U.S. CLS. 100 AND 101).

FIRST USE 3-30-2004; IN COMMERCE 3-30-2004.

CHRISTINE COOPER, EXAMINING ATTORNEY

SN 77-160,588. MEME DELRAY BEACH, LLC, DELRAY BEACH, FL. FILED 4-19-2007.

ELEVEN

THE MARK CONSISTS OF STANDARD CHARACTERS WITHOUT CLAIM TO ANY PARTICULAR FONT, STYLE, SIZE, OR COLOR.

OWNER OF U.S. REG. NOS. 3,176,169 AND 3,213,170.

FOR BEAUTY SALON SERVICES AND HEALTH SPA SERVICES, NAMELY, COSMETIC BODY CARE SERVICES, FACIALS, MANICURES, PEDICURES, MESSAGES, MICRODERMABRASIONS, NAMELY, A TOPICAL SKIN TREATMENT INVOLVING ABRASION OF THE SKIN WITH A HIGH-PRESSURE FLOW OF CRYSTALS, BODY WAXING, HAIR SALON SERVICES, COSMETIC SERVICES, NAMELY, COSMETIC PEELS AND SKIN TANNING, AND AROMATHERAPY (U.S. CLS. 100 AND 101).

FIRST USE 11-11-2004; IN COMMERCE 11-11-2004.

LEE-ANNE BERNS, EXAMINING ATTORNEY

CLASS 44—(Continued).

SN 77-161,067. TRS BEHAVIORAL CARE, INC., HOUSTON, TX. FILED 4-19-2007.

CLASS 44—(Continued).

SN 77-162,134. HOUSECALLMEDI, INC., AUSTIN, TX. FILED 4-20-2007.

SPIRIT LODGE

SERVIENT HOUSECALLHEALTH

THE MARK CONSISTS OF STANDARD CHARACTERS WITHOUT CLAIM TO ANY PARTICULAR FONT, STYLE, SIZE, OR COLOR.

FOR ADDICTION TREATMENT SERVICES AND REHABILITATION OF DRUG, ALCOHOL, NARCOTIC AND SUBSTANCE ADDICTED PATIENTS, AND COUNSELING AND REHABILITATION SERVICES FOR ALCOHOL AND OTHER DRUG-DEPENDENT PATIENTS (U.S. CLS. 100 AND 101).
MARK SPARACINO, EXAMINING ATTORNEY

THE MARK CONSISTS OF STANDARD CHARACTERS WITHOUT CLAIM TO ANY PARTICULAR FONT, STYLE, SIZE, OR COLOR.

FOR HOME HEALTH CARE SERVICES (U.S. CLS. 100 AND 101).
IRA J. GOODSaid, EXAMINING ATTORNEY

SN 77-161,123. PROFESSIONAL SKIN AESTHETICS INC., DANVILLE, CA. FILED 4-19-2007.

SN 77-162,145. HOUSECALLMEDI, INC., AUSTIN, TX. FILED 4-20-2007.

The Art of Medicine

WHITEGLOVE HOUSECALLHEALTH

THE MARK CONSISTS OF STANDARD CHARACTERS WITHOUT CLAIM TO ANY PARTICULAR FONT, STYLE, SIZE, OR COLOR.

FOR HEALTH SPA SERVICES, NAMELY, COSMETIC BODY CARE SERVICES; LASER AND IPL (INTENSE PULSE LIGHT) SKIN ENHANCEMENT PROCEDURES; HEALTH CARE (U.S. CLS. 100 AND 101).
FIRST USE 7-1-2006; IN COMMERCE 8-1-2006.
RICHARD A. STRASER, EXAMINING ATTORNEY

THE MARK CONSISTS OF STANDARD CHARACTERS WITHOUT CLAIM TO ANY PARTICULAR FONT, STYLE, SIZE, OR COLOR.

FOR HOME HEALTH CARE SERVICES (U.S. CLS. 100 AND 101).
IRA J. GOODSaid, EXAMINING ATTORNEY

SN 77-161,463. CROWN HOSPICE, INC., CAPE GIRARDEAU, MO. FILED 4-20-2007.

SN 77-162,355. RODRIGUEZ, TYRONE, YAKIMA, WA. AND RODRIGUEZ, VICTORIA, YAKIMA, WA. AND RODRIGUEZ, KATHERINE, YAKIMA, WA. FILED 4-20-2007.

Crown Hospice

Making the world better
one smile at a time.

THE MARK CONSISTS OF STANDARD CHARACTERS WITHOUT CLAIM TO ANY PARTICULAR FONT, STYLE, SIZE, OR COLOR.

NO CLAIM IS MADE TO THE EXCLUSIVE RIGHT TO USE "HOSPICE", APART FROM THE MARK AS SHOWN.
FOR HOSPICE SERVICES (U.S. CLS. 100 AND 101).
FIRST USE 8-7-2006; IN COMMERCE 8-7-2006.
JOHN DWYER, EXAMINING ATTORNEY

THE MARK CONSISTS OF STANDARD CHARACTERS WITHOUT CLAIM TO ANY PARTICULAR FONT, STYLE, SIZE, OR COLOR.

FOR DENTISTRY (U.S. CLS. 100 AND 101).
RICHARD A. STRASER, EXAMINING ATTORNEY

CLASS 44—(Continued).

SN 77-162,514. EADES, EDWARD, TUCSON, AZ. FILED 4-21-2007.

Medibella

THE MARK CONSISTS OF STANDARD CHARACTERS WITHOUT CLAIM TO ANY PARTICULAR FONT, STYLE, SIZE, OR COLOR.

FOR SKIN CARE SALONS; COSMETIC AND PLASTIC SURGERY (U.S. CLS. 100 AND 101).
FIRST USE 3-7-2005; IN COMMERCE 3-7-2005.
NORA BUCHANAN WILL, EXAMINING ATTORNEY

SN 77-167,947. GREAT LAKES SERVICES, LLC, MADISON, WI. FILED 4-27-2007.



NO CLAIM IS MADE TO THE EXCLUSIVE RIGHT TO USE "KID SPA", APART FROM THE MARK AS SHOWN.

THE MARK CONSISTS OF A BANANA WITH THREE SCOOPS OF ICE CREAM ON IT ABOVE THE TERMS "SCOOPS" AND "KID SPA". THE MIDDLE SCOOP OF ICE CREAM IS TOPPED WITH A CHERRY. THE TERM "SCOOPS" IS POSITIONED BENEATH THE BANANA AND THE TERMS "KID SPA" ARE POSITIONED BENEATH THE TERM "SCOOPS".

FOR HEALTH SPA SERVICES FOR HEALTH AND WELLNESS OF BODY AND SPIRIT OFFERED AT A RESORT (U.S. CLS. 100 AND 101).

FIRST USE 3-26-2007; IN COMMERCE 3-26-2007.
TINA L. SNAPP, EXAMINING ATTORNEY

CLASS 44—(Continued).

SN 77-169,027. AMERICAN COLLEGE OF CARDIOLOGY FOUNDATION, WASHINGTON, DC. FILED 4-30-2007.

ACHIEVE REGISTRY

THE MARK CONSISTS OF STANDARD CHARACTERS WITHOUT CLAIM TO ANY PARTICULAR FONT, STYLE, SIZE, OR COLOR.

NO CLAIM IS MADE TO THE EXCLUSIVE RIGHT TO USE "REGISTRY", APART FROM THE MARK AS SHOWN.

FOR PROVIDING AN ONLINE REGISTRY FEATURING ADVERSE EVENT AND HEALTH STATUS MEASUREMENT FOLLOWING PERCUTANEOUS CORONARY INTERVENTION FOR DOCTORS, HOSPITALS AND LABS IN THE FIELD OF CARDIOLOGY, CARDIOVASCULAR MEDICINE AND HEALTH (U.S. CLS. 100 AND 101).

PAULA MAHONEY, EXAMINING ATTORNEY

SN 77-176,915. GILBERT, NANCY, BERWYN, IL. AND DOTSON, KRISTY, ROMEOVILLE, IL. FILED 5-9-2007.

What Color Are You?

THE MARK CONSISTS OF STANDARD CHARACTERS WITHOUT CLAIM TO ANY PARTICULAR FONT, STYLE, SIZE, OR COLOR.

FOR NUTRITION AND WEIGHT REDUCTION PLANNING, CONTROL AND MAINTENANCE PROGRAMS INCLUDING THE DISTRIBUTION AND PROVIDING OF SUPPORT AND COURSE MATERIALS, NAMELY, MANUALS, DVDS, RECIPE BOOKS AND DIET RELATED APPARATUS IN CONNECTION THEREWITH (U.S. CLS. 100 AND 101).

FIRST USE 5-8-2007; IN COMMERCE 5-8-2007.
MARLENE BELL, EXAMINING ATTORNEY

SN 77-184,435. HYATT CORPORATION, CHICAGO, IL. FILED 5-18-2007.

BLUE MARBLE

THE MARK CONSISTS OF STANDARD CHARACTERS WITHOUT CLAIM TO ANY PARTICULAR FONT, STYLE, SIZE, OR COLOR.

FOR HEALTH SPA SERVICES, NAMELY, COSMETIC BODY CARE SERVICES (U.S. CLS. 100 AND 101).

KARANENDRA S. CHHINA, EXAMINING ATTORNEY

CLASS 44—(Continued).

SN 77-188,682. OLYMPIC PHYSICAL THERAPY OF BELLEVUE, INC., BELLEVUE, WA. FILED 5-23-2007.



THE MARK CONSISTS OF A GRAPHIC OF A PERSON IN STRIDE.
FOR PHYSICAL THERAPY SERVICES (U.S. CLS. 100 AND 101).

KAREN K. BUSH, EXAMINING ATTORNEY

SN 77-188,816. PLUM SYSTEMS CO., LOS ANGELES, CA. FILED 5-23-2007.

THE MIRACLE GAS

THE MARK CONSISTS OF STANDARD CHARACTERS WITHOUT CLAIM TO ANY PARTICULAR FONT, STYLE, SIZE, OR COLOR.

FOR MEDICAL SERVICES, NAMELY, DERMATOLOGY (U.S. CLS. 100 AND 101).

JANICE KIM, EXAMINING ATTORNEY

SN 77-189,449. PELIKAN TECHNOLOGIES, INC., PALO ALTO, CA. FILED 5-24-2007.

PELIKAN ISLAND

THE MARK CONSISTS OF STANDARD CHARACTERS WITHOUT CLAIM TO ANY PARTICULAR FONT, STYLE, SIZE, OR COLOR.

FOR PROVIDING HEALTH INFORMATION; PROVIDING INFORMATION IN THE FIELD OF DIABETES (U.S. CLS. 100 AND 101).

DEIRDRE ROBERTSON, EXAMINING ATTORNEY

CLASS 44—(Continued).

SN 77-199,991. SHISEIDO COMPANY, LTD., TOKYO, JAPAN, FILED 6-7-2007.

KIRANA SPA

THE MARK CONSISTS OF STANDARD CHARACTERS WITHOUT CLAIM TO ANY PARTICULAR FONT, STYLE, SIZE, OR COLOR.

NO CLAIM IS MADE TO THE EXCLUSIVE RIGHT TO USE "SPA", APART FROM THE MARK AS SHOWN.

THE FOREIGN WORDING IN THE MARK TRANSLATES INTO ENGLISH AS RAY; BEAUTIFUL; GLORIOUS, LOVELY.

FOR BEAUTY SALONS; HAIRDRESSING SALONS (U.S. CLS. 100 AND 101).

TAMARA FRAZIER, EXAMINING ATTORNEY

SN 77-216,053. OLYMPIC PHYSICAL THERAPY OF BELLEVUE, INC., BELLEVUE, WA. FILED 6-26-2007.

PROLYMPIC

THE MARK CONSISTS OF STANDARD CHARACTERS WITHOUT CLAIM TO ANY PARTICULAR FONT, STYLE, SIZE, OR COLOR.

FOR PHYSICAL THERAPY SERVICES (U.S. CLS. 100 AND 101).

KAREN K. BUSH, EXAMINING ATTORNEY

SN 78-652,911. THE INSTITUTE OF SLEEP MEDICINE, INC., DBA THE HOUSTON SLEEP CENTER, HOUSTON, TX. FILED 6-17-2005.

DON'T DRIVE DROWSY

THE MARK CONSISTS OF STANDARD CHARACTERS WITHOUT CLAIM TO ANY PARTICULAR FONT, STYLE, SIZE, OR COLOR.

FOR MEDICAL SERVICES AND MEDICAL SLEEP CLINIC SERVICES (U.S. CLS. 100 AND 101).

FIRST USE 9-0-1999; IN COMMERCE 9-0-1999.

CIMMERIAN COLEMAN, EXAMINING ATTORNEY

CLASS 44—(Continued).

SN 78-665,777. MED GEN INC., BOCA RATON, FL. FILED 7-7-2005.

UN-DIET

THE MARK CONSISTS OF STANDARD CHARACTERS WITHOUT CLAIM TO ANY PARTICULAR FONT, STYLE, SIZE, OR COLOR.

FOR WEIGHT CONTROL SYSTEM IN THE NATURE OF DIET WEIGHT REDUCTION PLANNING AND SUPERVISION (U.S. CLS. 100 AND 101).
AMY GEARIN, EXAMINING ATTORNEY

SN 78-749,037. TEMPLE UNIVERSITY – OF THE COMMONWEALTH SYSTEM OF HIGHER EDUCATION, PHILADELPHIA, PA. FILED 11-8-2005.

NIGHTOWLS

THE MARK CONSISTS OF STANDARD CHARACTERS WITHOUT CLAIM TO ANY PARTICULAR FONT, STYLE, SIZE, OR COLOR.

FOR PROVIDING RADIOLOGY SERVICES, TELERADIOLOGY SERVICES, AND READINGS AND INTERPRETATIONS OF RADIOLOGIC DIAGNOSTIC PROCEDURES ALL EXCLUSIVELY TO HEALTH CARE PROFESSIONALS (U.S. CLS. 100 AND 101).
JASON ROTH, EXAMINING ATTORNEY

SN 78-832,766. WELLPOINT, INC., INDIANAPOLIS, IN. FILED 3-8-2006.

SmartValue

THE MARK CONSISTS OF STANDARD CHARACTERS WITHOUT CLAIM TO ANY PARTICULAR FONT, STYLE, SIZE, OR COLOR.

FOR COMPREHENSIVE MEDICAL, DENTAL HYGIENIST, HEARING SCREENING, AND OPTOMETRY SERVICES (U.S. CLS. 100 AND 101).
FIRST USE 10-1-2004; IN COMMERCE 10-1-2004.
BRIDGETT SMITH, EXAMINING ATTORNEY

CLASS 44—(Continued).

SN 78-832,771. WELLPOINT, INC., INDIANAPOLIS, IN. FILED 3-8-2006.

SecurityChoice

THE MARK CONSISTS OF STANDARD CHARACTERS WITHOUT CLAIM TO ANY PARTICULAR FONT, STYLE, SIZE, OR COLOR.

FOR COMPREHENSIVE MEDICAL, DENTAL HYGIENIST, HEARING SCREENING, AND OPTOMETRY SERVICES (U.S. CLS. 100 AND 101).
FIRST USE 3-1-2003; IN COMMERCE 3-1-2003.
BRIDGETT SMITH, EXAMINING ATTORNEY

SN 78-858,535. SPA PARTISAN, INC., AUSTIN, TX. FILED 4-11-2006.

**milk + honey spa retreat
shop**

THE MARK CONSISTS OF STANDARD CHARACTERS WITHOUT CLAIM TO ANY PARTICULAR FONT, STYLE, SIZE, OR COLOR.

NO CLAIM IS MADE TO THE EXCLUSIVE RIGHT TO USE "MILK", "HONEY", "SPA" AND "SHOP", APART FROM THE MARK AS SHOWN.

FOR SPA SERVICES, NAMELY, MASSAGE, SWEDISH-STYLE MASSAGE, DEEP TISSUE MASSAGE, HOT STONE MASSAGE, BODY PART SPECIFIC MASSAGE, PREGNANCY MASSAGE, TANDEM MASSAGE, REFLEXOLOGY, REIKI, SKIN TREATMENTS, BODY TREATMENTS, AROMATHERAPY, BODY POLISH, SEAWEED MUD BODY TREATMENTS, PARAFANGO COCOON, NAIL TREATMENTS, FACIALS, WAXING, MANICURES, PEDICURES, PARAFFIN DIPS (U.S. CLS. 100 AND 101).

FIRST USE 10-0-2004; IN COMMERCE 11-0-2005.
ROBERT STRUCK, EXAMINING ATTORNEY

SN 78-939,210. BC INTERNATIONAL COSMETIC & IMAGE SERVICES, INC., ORLANDO, FL. FILED 7-27-2006.

SMART COMPANY

THE MARK CONSISTS OF STANDARD CHARACTERS WITHOUT CLAIM TO ANY PARTICULAR FONT, STYLE, SIZE, OR COLOR.

NO CLAIM IS MADE TO THE EXCLUSIVE RIGHT TO USE "COMPANY", APART FROM THE MARK AS SHOWN. FOR CONDUCTING IN-HOME HEALTH SPA SERVICES, NAMELY, COSMETIC BODY AND FACIAL CARE SERVICES (U.S. CLS. 100 AND 101).

FIRST USE 7-28-2006; IN COMMERCE 7-28-2006.
SANI KHOURI, EXAMINING ATTORNEY

CLASS 44—(Continued).

SN 78-944,347. THE KESSLER ENTERPRISE, INC., ORLANDO, FL. FILED 8-3-2006.

The Art of Being Well

THE MARK CONSISTS OF STANDARD CHARACTERS WITHOUT CLAIM TO ANY PARTICULAR FONT, STYLE, SIZE, OR COLOR.

FOR HEALTH SPA SERVICES, NAMELY, COSMETIC BODY CARE SERVICES, OFFERED IN SELECT HOTELS AND RESORT PROPERTIES IN OR AFFILIATED WITH THE KESSLER COLLECTION⁽¹⁾ HOTELS (U.S. CLS. 100 AND 101).

KAPIL BHANOT, EXAMINING ATTORNEY

SN 78-949,461. LIN, DR. MICHAEL T., ENCINO, CA. FILED 8-10-2006.

MD SOLUTIONS

THE MARK CONSISTS OF STANDARD CHARACTERS WITHOUT CLAIM TO ANY PARTICULAR FONT, STYLE, SIZE, OR COLOR.

NO CLAIM IS MADE TO THE EXCLUSIVE RIGHT TO USE "MD", APART FROM THE MARK AS SHOWN.

FOR MEDICAL CLINICS; MEDICAL CONSULTATIONS; MEDICAL COUNSELING; MEDICAL INFORMATION; MEDICAL SERVICES; PROVIDING MEDICAL INFORMATION, CONSULTANCY AND ADVISORY SERVICES (U.S. CLS. 100 AND 101).

FIRST USE 9-24-2002; IN COMMERCE 9-24-2002.
LINDSEY RUBIN, EXAMINING ATTORNEY

CLASS 44—(Continued).

SN 78-958,344. CARDIAC WELLNESS SPECIALISTS PA, WILLIAMSTON, NC. FILED 8-23-2006.



**CARDIACWELLNESS
SPECIALISTS**

NO CLAIM IS MADE TO THE EXCLUSIVE RIGHT TO USE "CARDIAC WELLNESS SPECIALISTS", APART FROM THE MARK AS SHOWN.

THE MARK CONSISTS OF THREE HEARTS INTERLOCKING.

FOR HEART DISEASE PREVENTION, WELLNESS AND REHABILITATION SERVICES, NAMELY, THE PROVISION OF MEDICAL ADVISORY AND PHYSICAL THERAPY SERVICES FOR PREVENTION OF HEART DISEASE, EARLY ASSESSMENT OF CARDIOVASCULAR RISK FACTORS, MAINTENANCE OF CARDIAC WELLNESS, CARDIOVASCULAR RISK REDUCTION AND CARDIAC REHABILITATION; AND INDIVIDUAL AND GROUP CARDIOVASCULAR HEALTH COUNSELING (U.S. CLS. 100 AND 101).

RENEE SERVANCE, EXAMINING ATTORNEY

SN 78-958,778. METABOLIC BALANCE GMBH, ISEN, FED REP GERMANY, FILED 8-23-2006.



NO CLAIM IS MADE TO THE EXCLUSIVE RIGHT TO USE "METABOLIC BALANCE", APART FROM THE MARK AS SHOWN.

THE MARK CONSISTS OF THE WORDING METABOLIC BALANCE AND THE STYLIZED REPRESENTATION OF A BIRD'S WINGS.

FOR WEIGHT REDUCTION DIET PLANNING AND SUPERVISION; HEALTH CARE SERVICES, NAMELY, WELLNESS PROGRAMS (U.S. CLS. 100 AND 101).

FIRST USE 1-15-2003; IN COMMERCE 7-6-2004.
CHRISIE B. KING, EXAMINING ATTORNEY

CLASS 44—(Continued).

SN 78-959,043. EXPERT KNOWLEDGE SYSTEMS, LLC,
WHITE PLAINS, NY. FILED 8-23-2006.

EKS

THE MARK CONSISTS OF STANDARD CHARACTERS WITHOUT CLAIM TO ANY PARTICULAR FONT, STYLE, SIZE, OR COLOR.

FOR CONSULTING SERVICES RELATED TO MEDICAL TREATMENT AND HEALTH (U.S. CLS. 100 AND 101).

FIRST USE 7-0-1996; IN COMMERCE 7-0-1996.
BONNIE LUKEN, EXAMINING ATTORNEY

SN 78-971,871. AHHH MASSAGE. LLC, SPARKS, NV. FILED
9-11-2006.



OWNER OF U.S. REG. NO. 3,228,836.
NO CLAIM IS MADE TO THE EXCLUSIVE RIGHT TO USE "MASSAGE", APART FROM THE MARK AS SHOWN.
"THE COLOR(S) BLACK, WHITE, AND PURPLE IS/ARE CLAIMED AS A FEATURE OF THE MARK."

"THE MARK CONSISTS OF THE LETTER 'A' IN 'AHHH!' IS A STYLIZED PALM TREE WITH THE REMAINING LETTERS OF THE MARK APPEARING TO SUPPORT A STYLIZED FACE-DOWN RECLINING FIGURE OF A WOMAN WITH EACH OF THESE ELEMENTS AND THE LETTERING OUTLINED IN BLACK WITH PURPLE SHADING. THE PALM TREE AND THE FIGURE HAVE WHITE HIGHLIGHTS."

FOR MASSAGE THERAPY SERVICES (U.S. CLS. 100 AND 101).

FIRST USE 9-11-2006; IN COMMERCE 9-11-2006.
CAROLYN CATALDO, EXAMINING ATTORNEY

CLASS 45—PERSONAL AND LEGAL SERVICES

SN 76-673,289. CROWN PACKAGING TECHNOLOGY, INC.,
ALSIP, IL. FILED 2-27-2007.



NO CLAIM IS MADE TO THE EXCLUSIVE RIGHT TO USE "SAFETY AWARENESS FOR EMPLOYEES", APART FROM THE MARK AS SHOWN.

"THE COLOR(S) RED, BLUE, LIGHT BLUE, AND WHITE IS/ARE CLAIMED AS A FEATURE OF THE MARK."

THE MARK CONSISTS OF A THE COLORS RED, WHITE, AND BLUE, WITH A MEDIUM BLUE OUTER-CIRCLE, A RED INNER CIRCLE CONTAINING THE WORDS SAFETY AWARENESS FOR EMPLOYEES IN WHITE, AND A MEDIUM BLUE INNER CIRCLE CONTAINING THE TERM THINK IN MEDIUM BLUE. AT THE BOTTOM OF THE CIRCLE THERE IS A MEDIUM BLUE WAVE OR ARM-SHAPED FIGURE CONTAINING THE TERM S.A.F.E. IN WHITE ABOVE WHICH THERE ARE TWO HUMAN FORMS IN LIGHT BLUE WITH RED AND WHITE HATS.

FOR SAFETY INSPECTION AUDITS TO IMPROVE JOB SAFETY; INSPECTION OF FACTORIES FOR SAFETY PURPOSES (U.S. CLS. 100 AND 101).

FIRST USE 12-0-2006; IN COMMERCE 12-0-2006.
ZACHARY BELLO, EXAMINING ATTORNEY

SN 77-040,338. PABLO, INES DE, RESTON, VA. FILED 11-9-2006.



NO CLAIM IS MADE TO THE EXCLUSIVE RIGHT TO USE "EMERGENCY MANAGEMENT NETWORK MITIGATION PREPAREDNESS RECOVERY RESPONSE", APART FROM THE MARK AS SHOWN.

THE COLOR(S) RED, BLUE, YELLOW, BROWN, BLACK AND WHITE IS/ARE CLAIMED AS A FEATURE OF THE MARK.

THE MARK CONSISTS OF A DOG HOLDING A CIRCLE, REPRESENTING A FLYING DISC, IN ITS MOUTH. THE WORDS "EMERGENCY MANAGEMENT NETWORK" ARE WRITTEN IN BLACK OVER A RED BACKGROUND ON THE OUTER PERIMETER OF THE CIRCLE/FLYING DISC. WITHIN THE RED PERIMETER OF THE FLYING DISC THERE IS A BLACK DIAMOND WITH THE WORDS "MITIGATION PREPAREDNESS RECOVERY RESPONSE"

CLASS 45—(Continued).

WRITTEN IN WHITE LETTERS WITHIN THE BLACK DIAMOND LINES. INSIDE THE BLACK DIAMOND IS AN IMAGE OF A GLOBE SHOWING A MAP OF NORTH AND SOUTH AMERICA APPEARING WITHIN THE DIAMOND. THE GLOBE BACKGROUND IS LIGHT BLUE AND THE NORTH AND SOUTH AMERICAN CONTINENTS ARE IN YELLOW. THE DOG IS BROWN AND IS WEARING A COLLAR WITH THE LETTERS "G1" WRITTEN IN BLACK IN A WHITE CIRCLE. A WHITE STAR IS ON BOTH SIDES OF THE CIRCLE.

FOR PROVIDING A WEBSITE AND WEBSITE LINKS FOR STUDENTS, SECURITY PROFESSIONALS AND PET OWNERS FEATURING INFORMATION IN THE FIELD OF EMERGENCY RESPONSE FOR COMMUNITIES, INFORMATION REGARDING ASSISTANCE IN LOCATING LOST PETS, INFORMATION REGARDING NATIONAL SECURITY, AND INFORMATION REGARDING UNDERSTANDING AND PREVENTING TERRORISM (U.S. CLS. 100 AND 101).

FIRST USE 10-27-2006; IN COMMERCE 10-27-2006.
CHARLOTTE CORWIN, EXAMINING ATTORNEY

SN 77-149,057. PAGE, JOSEPH, LA JOLLA, CA. FILED 4-5-2007.

Couture Today

THE MARK CONSISTS OF STANDARD CHARACTERS WITHOUT CLAIM TO ANY PARTICULAR FONT, STYLE, SIZE, OR COLOR.

NO CLAIM IS MADE TO THE EXCLUSIVE RIGHT TO USE "COUTURE", APART FROM THE MARK AS SHOWN. FOR PROVIDING FASHION INFORMATION (U.S. CLS. 100 AND 101).

DAVID H. STINE, EXAMINING ATTORNEY

SN 77-150,503. INFINITY LAW GROUP LLC, MALDEN, MA. FILED 4-6-2007.

INFINITY LAW GROUP

NO CLAIM IS MADE TO THE EXCLUSIVE RIGHT TO USE "LAW GROUP", APART FROM THE MARK AS SHOWN.

THE MARK CONSISTS OF INFINITY LAW GROUP WITH A DOUBLE TAIL SHOOTING STAR LEADING TO THE SECOND I IN INFINITY AND WITH EACH TAIL ENDING ON THE WORDS LAW AND GROUP RESPECTIVELY.

FOR LEGAL SERVICES (U.S. CLS. 100 AND 101).
FIRST USE 10-13-2006; IN COMMERCE 10-13-2006.
DAVID TOOLEY, EXAMINING ATTORNEY

CLASS 45—(Continued).

SN 77-157,357. APPLESEED FOUNDATION, INC., WASHINGTON, DC. FILED 4-16-2007.

Appleseed

THE MARK CONSISTS OF STANDARD CHARACTERS WITHOUT CLAIM TO ANY PARTICULAR FONT, STYLE, SIZE, OR COLOR.

FOR LEGAL SERVICES, NAMELY, STATEWIDE PUBLIC INTEREST LAW CENTERS (U.S. CLS. 100 AND 101).
FIRST USE 5-6-1994; IN COMMERCE 5-16-1994.
TRICIA SONNEBORN, EXAMINING ATTORNEY

SN 77-157,565. SIN CITY HOOK-UPS, VAN NUYS, CA. FILED 4-16-2007.

Sin City Hook-ups

THE MARK CONSISTS OF STANDARD CHARACTERS WITHOUT CLAIM TO ANY PARTICULAR FONT, STYLE, SIZE, OR COLOR.

NO CLAIM IS MADE TO THE EXCLUSIVE RIGHT TO USE "SIN CITY", APART FROM THE MARK AS SHOWN.

FOR INTERNET BASED SOCIAL NETWORKING, INTRODUCTION, AND DATING SERVICES (U.S. CLS. 100 AND 101).

CAROLINE WOOD, EXAMINING ATTORNEY

SN 77-158,567. SCHMIDT, JOSEPH OTTO, LOS ANGELES, CA. FILED 4-17-2007.

generationmed

THE COLOR(S) BLACK, BLUE, AND WHITE IS/ARE CLAIMED AS A FEATURE OF THE MARK.

THE MARK CONSISTS OF THREE INTERLOCKING BLUE AND WHITE CHEVRONS THAT COMBINE TO FORM A TRIANGULAR SHAPE ABOVE THE BLACK WORD "GENERATION" AND THE BLUE WORD "MED".

FOR ONLINE SOCIAL NETWORKING SERVICES (U.S. CLS. 100 AND 101).
MORGAN WYNNE, EXAMINING ATTORNEY

CLASS 45—(Continued).

SN 77-158,718. PETERSON, DAVID M., KANSAS CITY, MO.
FILED 4-17-2007.

Fighting for a Safer America

THE MARK CONSISTS OF STANDARD CHARACTERS
WITHOUT CLAIM TO ANY PARTICULAR FONT, STYLE,
SIZE, OR COLOR.
FOR LEGAL SERVICES (U.S. CLS. 100 AND 101).
ELLEN B. AWRICH, EXAMINING ATTORNEY

SN 77-158,782. MUZZATTI, VITTORIO N, GAITHERSBURG,
MD. FILED 4-17-2007.

CONFIDENCE

THE MARK CONSISTS OF CAPITAL "C", AND A
CAPITAL "E" AT THE END AND THE LETTER IN
BETWEEN ARE SMALLER THAN THE C & E.
FOR REAL ESTATE SETTLEMENT SERVICES; REAL
ESTATE CLOSING SERVICES (U.S. CLS. 100 AND 101).
FIRST USE 2-8-2006; IN COMMERCE 2-8-2006.
JULIE THOMAS, EXAMINING ATTORNEY

SN 77-158,844. DRIVE-TO-WORK, RICHMOND, VA. FILED
4-17-2007.

DRIVE TO WORK

THE MARK CONSISTS OF STANDARD CHARACTERS
WITHOUT CLAIM TO ANY PARTICULAR FONT, STYLE,
SIZE, OR COLOR.
FOR LEGAL SERVICES PROVIDED PRO BONO TO
LOW INCOME AND PREVIOUSLY INCARCERATED
INDIVIDUALS, NAMELY, ASSISTANCE IN OBTAINING
DRIVER'S LICENSES, PERSONAL IDENTIFICATION
CARDS, BIRTH CERTIFICATES, AND OTHER FORMS
OF PERSONAL IDENTIFICATION; LEGAL SERVICES
PROVIDED PRO BONO TO LOW INCOME AND PRE-
VIOUSLY INCARCERATED INDIVIDUALS, NAMELY,
LEGAL DEFENSE OF SAID INDIVIDUALS WHEN
CHARGED WITH CERTAIN TRAFFIC VIOLATIONS
(U.S. CLS. 100 AND 101).
JAMES LOVELACE, EXAMINING ATTORNEY

CLASS 45—(Continued).

SN 77-159,008. GRASSHOPR, LLC, ALEXANDRIA, VA.
FILED 4-17-2007.



FOR ONLINE SOCIAL NETWORKING SERVICES (U.S.
CLS. 100 AND 101).
JASON ROTH, EXAMINING ATTORNEY

SN 77-159,357. ANTHONY J. BOURGET, EAU CLAIRE, WI.
FILED 4-18-2007.

INTELLECTUALGEMS

THE MARK CONSISTS OF STANDARD CHARACTERS
WITHOUT CLAIM TO ANY PARTICULAR FONT, STYLE,
SIZE, OR COLOR.
FOR LEGAL SERVICES (U.S. CLS. 100 AND 101).
FIRST USE 2-0-2007; IN COMMERCE 2-0-2007.
PAUL E. FAHRENKOPF, EXAMINING ATTORNEY

SN 77-159,538. WEISBERG & WALKON, P.C., SOUTHFIELD,
MI. FILED 4-18-2007.



OWNER OF U.S. REG. NO. 2,019,950.
NO CLAIM IS MADE TO THE EXCLUSIVE RIGHT TO
USE "THE LAW CENTER FOR DISABILITY RIGHTS",
APART FROM THE MARK AS SHOWN.
THE MARK CONSISTS OF A HAND HOLDING THE
SCALES OF JUSTICE WITH THE WORDS THE LAW
CENTER FOR DISABILITY RIGHTS HORIZONTALLY
TRAVERSING THE SCALES AND THE FIRST LETTER OF
EACH WORD THE LAW CENTER IN CURSIVE WRITING .
FOR LEGAL SERVICES (U.S. CLS. 100 AND 101).
CARYN GLASSER, EXAMINING ATTORNEY

CLASS 45—(Continued).

SN 77-159,580. FLACHSBART & GREENSPOON, LLC, CHICAGO, IL. FILED 4-18-2007.

Passion. Knowledge. Strategy. Action.

THE MARK CONSISTS OF STANDARD CHARACTERS WITHOUT CLAIM TO ANY PARTICULAR FONT, STYLE, SIZE, OR COLOR.

FOR LEGAL SERVICES; LICENSING OF INTELLECTUAL PROPERTY; LITIGATION SERVICES (U.S. CLS. 100 AND 101).

FIRST USE 4-15-2007; IN COMMERCE 4-15-2007.
AMY ALFIERI, EXAMINING ATTORNEY

SN 77-159,829. FRESH START LEGAL GROUP, INC., MADISON, WI. FILED 4-18-2007.



NO CLAIM IS MADE TO THE EXCLUSIVE RIGHT TO USE "LEGAL GROUP", APART FROM THE MARK AS SHOWN.

FOR LEGAL CONSULTATION, LEGAL SERVICES, AND ATTORNEY SERVICES (U.S. CLS. 100 AND 101).

CHRISTOPHER BUONGIORNO, EXAMINING ATTORNEY

SN 77-160,112. FREE2BME COMMUNICATIONS, LLC, CAMARILLO, CA. FILED 4-18-2007.



NO CLAIM IS MADE TO THE EXCLUSIVE RIGHT TO USE "COMMUNICATIONS, LLC", APART FROM THE MARK AS SHOWN.

THE MARK CONSISTS OF A UNISEX PERSON WITH "FREE2BME!" RENDERED ON A SHIRT HOLDING UP A SHORT WAVING BANNER WITH ENDS DISPLAYING THE STYLIZED WORD "ME!" ATTACHED WITH FOUR RIBBONS: TWO THIN RIBBONS AND ONE WIDE RIBBON WITH "WORDS", "BOUNDARIES" AND "CONNECTIONS". ONE WIDE RIBBON WITH "DESIRES", "FRIENDS", AND "FEELINGS". THE STYLIZED "FREE2B" IS DIRECTLY UNDER THE WIDE RIBBON. "FREE2BME COMMUNICATIONS, LLC" IS UNDERLINED AND DIRECTLY UNDER "FREE2B".

FOR ONLINE SOCIAL NETWORKING SERVICES (U.S. CLS. 100 AND 101).

KIMBERLY FRYE, EXAMINING ATTORNEY

CLASS 45—(Continued).

SN 77-160,161. DENIRO MARKETING, LLC., STOCKTON, CA. FILED 4-18-2007.

romancer.com

THE MARK CONSISTS OF STANDARD CHARACTERS WITHOUT CLAIM TO ANY PARTICULAR FONT, STYLE, SIZE, OR COLOR.

NO CLAIM IS MADE TO THE EXCLUSIVE RIGHT TO USE ".COM", APART FROM THE MARK AS SHOWN.

FOR WEB SITE SERVICES FEATURING ON-LINE DATING CLUB (U.S. CLS. 100 AND 101).

FIRST USE 9-15-2006; IN COMMERCE 9-15-2006.
MICHAEL LEWIS, EXAMINING ATTORNEY

SN 77-160,360. BRYANT, TERRY, HOUSTON, TX. FILED 4-19-2007.

TERRY BRYANT

THE MARK CONSISTS OF STANDARD CHARACTERS WITHOUT CLAIM TO ANY PARTICULAR FONT, STYLE, SIZE, OR COLOR.

THE NAME "TERRY BRYANT" IDENTIFIES A LIVING INDIVIDUAL WHOSE CONSENT IS OF RECORD.

FOR LEGAL SERVICES (U.S. CLS. 100 AND 101).

FIRST USE 12-31-1994; IN COMMERCE 12-31-1994.
EVELYN BRADLEY, EXAMINING ATTORNEY

SN 77-160,396. VISION MORTGAGE, LLC, ROCKVILLE, MD. FILED 4-19-2007.

CLEARFEE

THE MARK CONSISTS OF STANDARD CHARACTERS WITHOUT CLAIM TO ANY PARTICULAR FONT, STYLE, SIZE, OR COLOR.

FOR REAL ESTATE CLOSING SERVICES; REAL ESTATE SETTLEMENT SERVICES (U.S. CLS. 100 AND 101).

EMILY CHUO, EXAMINING ATTORNEY

CLASS 45—(Continued).

SN 77-160,808. PLUGGED IN, NEEDHAM, MA. FILED 4-19-2007.

Plugged In

THE MARK CONSISTS OF STANDARD CHARACTERS WITHOUT CLAIM TO ANY PARTICULAR FONT, STYLE, SIZE, OR COLOR.

FOR CHARITABLE SERVICES, NAMELY, ORGANIZING YOUTH GROUPS TO UNDERTAKE PROJECTS TO BENEFIT THE NEEDY AND THE COMMUNITY TO ENCOURAGE LEADERSHIP, CHARACTER, COMPASSION, AND GOOD CITIZENSHIP (U.S. CLS. 100 AND 101).

FIRST USE 9-15-2002; IN COMMERCE 9-15-2002.
AHSEN KHAN, EXAMINING ATTORNEY

SN 77-161,156. CHICAGO PROVINCE OF THE SOCIETY OF JESUS, CHICAGO, IL. FILED 4-19-2007.

IGNATIAN INSPIRATION

THE MARK CONSISTS OF STANDARD CHARACTERS WITHOUT CLAIM TO ANY PARTICULAR FONT, STYLE, SIZE, OR COLOR.

NO CLAIM IS MADE TO THE EXCLUSIVE RIGHT TO USE IGNATIAN, APART FROM THE MARK AS SHOWN.

FOR PROVIDING RELIGIOUS AND SPIRITUAL INFORMATION THROUGH PRINT AND ELECTRONIC MEDIA RELATED TO SAINT IGNATIUS LOYOLA, FOUNDER OF THE JESUIT ORDER, AND CATHOLIC TOPICS TO ENHANCE AND NURTURE THE SPIRITUAL LIVES OF CHILDREN, ADULTS, AND FAMILIES (U.S. CLS. 100 AND 101).

LYDIA BELZER, EXAMINING ATTORNEY

SN 77-161,222. HYPERACTIVE MEDIA LLC, CLAREMONT, NH. FILED 4-19-2007.

Startup
ADDICT
Dream Big · Be Great



NO CLAIM IS MADE TO THE EXCLUSIVE RIGHT TO USE "STARTUP", APART FROM THE MARK AS SHOWN.

THE MARK CONSIST OF THE WORDING STARTUP, ABOVE ADDICT, ABOVE "DREAM BIG · BE GREAT"; TO THE RIGHT OF WHICH IS THE SILHOUETTE OF A BUSINESS MAN HOLDING A BRIEFCASE IN HIS LEFT HAND AND CASTING A SLIGHT SHADOW BENEATH HIS FEET.

FOR ONLINE SOCIAL NETWORKING SERVICES (U.S. CLS. 100 AND 101).

FIRST USE 2-0-2007; IN COMMERCE 4-1-2007.
RAY THOMAS, EXAMINING ATTORNEY

CLASS 45—(Continued).

SN 77-161,552. COOPER, CHARLES J., WASHINGTON, DC. FILED 4-20-2007.

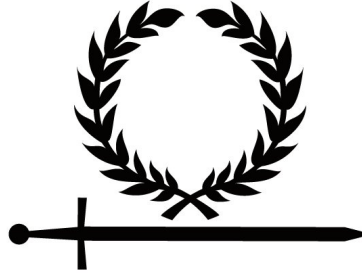

THE MARK CONSISTS OF A LAUREL WREATH ABOVE A HORIZONTAL SWORD.

FOR LEGAL SERVICES; LITIGATION SERVICES (U.S. CLS. 100 AND 101).

JOSETTE BEVERLY, EXAMINING ATTORNEY

SN 77-161,607. JOANNE OKIKO SHIGEKO KELLY, TUCSON, AZ. FILED 4-20-2007.



THE MARK CONSISTS OF EIGHT ARCHING AND ASCENDING SPHERES CROWNED BY A THREE-PETALLED FLOWER WITH TAPERED PETALS. THE LITERAL ELEMENT CONTAINS A BACKWARD "K" THE SECOND "K" IN THE WORD "OKIKO."

THE FOREIGN WORDING IN THE MARK TRANSLATES INTO ENGLISH AS ORCHID.

FOR PROVIDING INFORMATION RELATING TO DIVERSE HUMAN CULTURES, BELIEFS, AND LIFESTYLES (U.S. CLS. 100 AND 101).

FRED MANDIR, EXAMINING ATTORNEY

SN 77-162,309. LAVERY AND TRYBA, CHICAGO, IL. FILED 4-20-2007.

Conscious Connections

THE MARK CONSISTS OF STANDARD CHARACTERS WITHOUT CLAIM TO ANY PARTICULAR FONT, STYLE, SIZE, OR COLOR.

FOR COMPUTER DATING SERVICES; DATING SERVICES; ONLINE SOCIAL NETWORKING SERVICES (U.S. CLS. 100 AND 101).

JOHN DWYER, EXAMINING ATTORNEY

CLASS 45—(Continued).

SN 77-165,628. DEUTSCHE TELEKOM AG, BONN, FED REP GERMANY, FILED 4-25-2007.

MDA Touch

THE MARK CONSISTS OF STANDARD CHARACTERS WITHOUT CLAIM TO ANY PARTICULAR FONT, STYLE, SIZE, OR COLOR.

OWNER OF U.S. REG. NOS. 2,930,990, 2,942,203 AND OTHERS.

FOR LICENSING OF INDUSTRIAL PROPERTY RIGHTS (U.S. CLS. 100 AND 101).

JENNIFER HETU, EXAMINING ATTORNEY

SN 77-166,128. SHIPMAN & GOODWIN LLP, HARTFORD, CT. FILED 4-26-2007.



SHIPMAN & GOODWIN^{LLP}

OWNER OF U.S. REG. NOS. 2,536,828, 2,556,160 AND OTHERS.

NO CLAIM IS MADE TO THE EXCLUSIVE RIGHT TO USE "LLP", APART FROM THE MARK AS SHOWN.

THE MARK CONSISTS OF A DEPICTION OF SAILS OVER THE WORDS "SHIPMAN & GOODWIN LLP".

FOR LEGAL SERVICES (U.S. CLS. 100 AND 101).
DAYNA BROWNE, EXAMINING ATTORNEY

SN 77-169,370. BENNETT TUELLER JOHNSON & DEERE, P.C., SALT LAKE CITY, UT. FILED 4-30-2007.

BTJD

THE MARK CONSISTS OF THE LETTERS BTJD NEXT TO TWO CIRCLES LOCATED AT OPPOSITE ENDS (ONE IN THE LOWER LEFT CORNER AND THE OTHER IN THE UPPER RIGHT CORNER) OF AN INVISIBLE SQUARE. THE TWO CIRCLES ARE SEPARATED DIAGONALLY BY A THIRD STRETCHED-OUT CIRCLE THAT NARROWS IN THE MIDDLE AND THAT EXTENDS FROM THE UPPER LEFT CORNER TO THE LOWER RIGHT CORNER OF THE INVISIBLE SQUARE. ONE CIRCLE REPRESENTS A LAWYER, THE OTHER CIRCLE REPRESENTS A CLIENT, AND THE STRETCHED-OUT CIRCLE REPRESENTS A TABLE.

FOR LEGAL SERVICES (U.S. CLS. 100 AND 101).
MARY MUNSON, EXAMINING ATTORNEY

CLASS 45—(Continued).

SN 77-169,377. BENNETT TUELLER JOHNSON & DEERE, P.C., SALT LAKE CITY, UT. FILED 4-30-2007.

BTJD

BENNETT • TUELLER JOHNSON & DEERE

THE MARK CONSISTS OF THE LETTERS BTJD NEXT TO TWO CIRCLES LOCATED AT OPPOSITE ENDS (ONE IN THE LOWER LEFT CORNER AND THE OTHER IN THE UPPER RIGHT CORNER) OF AN INVISIBLE SQUARE. THE TWO CIRCLES ARE SEPARATED DIAGONALLY BY A THIRD STRETCHED-OUT CIRCLE THAT NARROWS IN THE MIDDLE AND THAT EXTENDS FROM THE UPPER LEFT CORNER TO THE LOWER RIGHT CORNER OF THE INVISIBLE SQUARE. ONE CIRCLE REPRESENTS A LAWYER, THE OTHER CIRCLE REPRESENTS A CLIENT, AND THE STRETCHED-OUT CIRCLE REPRESENTS A TABLE. UNDER THE LETTERS BTJD ARE THE WORDS BENNETT TUELLER JOHNSON & DEERE.

FOR LEGAL SERVICES (U.S. CLS. 100 AND 101).

FIRST USE 1-1-2006; IN COMMERCE 1-1-2006.
MARY MUNSON, EXAMINING ATTORNEY

SN 77-212,850. AOL LLC, DULLES, VA. FILED 6-22-2007.

CIRCAVIE

THE MARK CONSISTS OF STANDARD CHARACTERS WITHOUT CLAIM TO ANY PARTICULAR FONT, STYLE, SIZE, OR COLOR.

FOR ONLINE SOCIAL NETWORKING SERVICES (U.S. CLS. 100 AND 101).

PAMELA HIRSCHMAN, EXAMINING ATTORNEY

SN 78-593,220. LANDLORD SERVICE BUREAU, INC., NORTH HUNTINGTON, PA. FILED 3-23-2005.

The Tenant from Hell

THE MARK CONSISTS OF STANDARD CHARACTERS WITHOUT CLAIM TO ANY PARTICULAR FONT, STYLE, SIZE, OR COLOR.

FOR TENANT SCREENING, NAMELY, BACKGROUND SCREENING FOR CRIMINAL RECORDS, PERSONAL AND PROFESSIONAL BACKGROUND INFORMATION OF POTENTIAL TENANTS. (U.S. CLS. 100 AND 101).

FIRST USE 1-1-1998; IN COMMERCE 1-1-1998.
DARRYL SPRUILL, EXAMINING ATTORNEY

CLASS 45—(Continued).

SN 78-799,501. CRIMSON HOME CARE, LLC, CHARLOTTE, NC. FILED 1-25-2006.

CRIMSON HOME CARE

THE MARK CONSISTS OF STANDARD CHARACTERS WITHOUT CLAIM TO ANY PARTICULAR FONT, STYLE, SIZE, OR COLOR.

NO CLAIM IS MADE TO THE EXCLUSIVE RIGHT TO USE "HOME CARE", APART FROM THE MARK AS SHOWN.

FOR PERSONAL CARE ASSISTANCE OF ACTIVITIES OF DAILY LIVING, SUCH AS TRANSPORTATION, NAMELY, PERSONAL MOBILITY; PERSONAL GROCERY AND CLOTHING SHOPPING; SOCIAL SERVICES, NAMELY, COMPANIONSHIP SERVICES AND EMOTIONAL SUPPORT; AND ORGANIZATIONAL SERVICES FOR PERSONAL PURPOSES, NAMELY, ORGANIZING PERSONAL SCHEDULES, ALL FOR THE ELDERLY AND HANDICAPPED (U.S. CLS. 100 AND 101).

FIRST USE 10-1-2005; IN COMMERCE 10-1-2005.

RAY THOMAS, EXAMINING ATTORNEY

SN 78-923,254. SOVEREIGN DEED, LLC, CHICAGO, IL. FILED 7-6-2006.

GUIDE

THE MARK CONSISTS OF STANDARD CHARACTERS WITHOUT CLAIM TO ANY PARTICULAR FONT, STYLE, SIZE, OR COLOR.

FOR ASSISTING LOCALITIES AND LOCAL ENTITIES IN ORGANIZING AND ESTABLISHING GROUPS OF PRACTICING AND RETIRED PHYSICIANS, NURSES, AND OTHER HEALTH PROFESSIONALS TO ACT IN A COORDINATED MANNER IN TIMES OF LOCAL EMERGENCIES; BACKGROUND INVESTIGATION AND RESEARCH SERVICES; BEREAVEMENT CONSULTING; BODY GUARD SERVICES; CIVIL PROTECTION; COMPUTER SECURITY SERVICES IN THE NATURE OF PROVIDING AN INTERNET TRUST CENTER, NAMELY, COMPUTER SECURITY ASSURANCE AND ADMINISTRATION OF DIGITAL KEYS AND DIGITAL CERTIFICATES; CONCIERGE SERVICES FOR OTHERS COMPRISING MAKING REQUESTED PERSONAL ARRANGEMENTS AND RESERVATIONS AND PROVIDING CUSTOMER-SPECIFIC INFORMATION TO MEET INDIVIDUAL NEEDS RENDERED TOGETHER IN A HOUSING COMPLEX; CONSULTING SERVICES IN THE FIELD OF MAINTAINING THE SECURITY AND INTEGRITY OF DATABASES; CONTROL OF BUILDING ENVIRONMENTAL ACCESS AND SECURITY SYSTEMS; ELECTRONIC MONITORING SERVICES FOR SECURITY PURPOSES IN THE FIELD OF CIVIL DEFENSE; GUARD SERVICES; IDENTIFICATION VERIFICATION SERVICES, NAMELY, PROVIDING AUTHENTICATION OF PERSONAL IDENTIFICATION INFORMATION; INVESTIGATION OR SURVEILLANCE ON BACKGROUND PROFILES; MINISTERIAL SERVICES; MONITORING ALARMS; MONITORING OF COMPUTER SYSTEMS FOR SECURITY PURPOSES; MONITORING SECURITY SYSTEMS; MONITORING TELEPHONE CALLS FROM

CLASS 45—(Continued).

SUBSCRIBERS AND NOTIFYING EMERGENCY FACILITIES; ON-LINE MONITORING, NAMELY, VIDEO MONITORING OF FACILITIES, VIEWABLE THROUGH A GLOBAL COMPUTER NETWORK; ORGANIZATIONAL SERVICES FOR HOME OR PERSONAL PURPOSES, NAMELY, PERSONAL SAFETY; PERSONAL SECURITY CONSULTATION; POLICE AND CIVIL PROTECTION SERVICES; PROVIDING CONSULTATION AND INFORMATION IN THE FIELD OF EMERGENCY RESPONSE FOR COMMUNITIES; PROVIDING INFORMATION IN THE FIELD OF THE MILITARY, MILITARY TACTICS AND STRATEGIES; PROVIDING INFORMATION REGARDING UNDERSTANDING AND PREVENTING TERRORISM; SECURITY PRINTING, NAMELY, ENCODING IDENTIFICATION INFORMATION ON VALUABLE DOCUMENTS AND PRODUCTS; SECURITY SERVICES, NAMELY WATER VULNERABILITY ASSESSMENT SERVICES; SECURITY INSPECTIONS SERVICES FOR OTHERS; TRACKING SERVICES FOR RETRIEVAL OF ENCODED PRODUCTS (U.S. CLS. 100 AND 101).

PAUL E. FAHRENKOPF, EXAMINING ATTORNEY

SN 78-946,129. ELITIST ENTERTAINMENT, INC., SAN DIEGO, CA. FILED 8-7-2006.

ELITIST

THE MARK CONSISTS OF STANDARD CHARACTERS WITHOUT CLAIM TO ANY PARTICULAR FONT, STYLE, SIZE, OR COLOR.

FOR CONCIERGE SERVICES FOR OTHERS PROVIDED VIA THE INTERNET COMPRISING MAKING REQUESTED PERSONAL ARRANGEMENTS AND RESERVATIONS (U.S. CLS. 100 AND 101).

JOHN KELLY, EXAMINING ATTORNEY

SN 78-966,616. XLLERATE CONSULTING, LLC, GARLAND, TX. FILED 9-3-2006.

XLLERATE

THE MARK CONSISTS OF STANDARD CHARACTERS WITHOUT CLAIM TO ANY PARTICULAR FONT, STYLE, SIZE, OR COLOR.

FOR LICENSING OF COMPUTER SOFTWARE (U.S. CLS. 100 AND 101).

BRENDAN REGAN, EXAMINING ATTORNEY

CLASS 45—(Continued).

SN 78-973,847. MACEDONIA BAPTIST CHURCH, AUGUSTA, GA. FILED 9-13-2006.

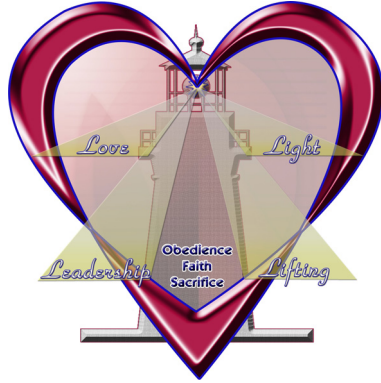

THE COLOR(S) RED, BLUE, YELLOW, PINK, WHITE, GRAY, AND BLACK IS/ARE CLAIMED AS A FEATURE OF THE MARK.
THE WORDS LOVE LIGHT LEADERSHIP AND LIFTING

CLASS 45—(Continued).

APPEAR IN THE COLOR WHITE WITH BLUE OUTLINING. THE WORDS OBEDIENCE, FAITH, AND SACRIFICE APPEAR IN THE COLOR BLUE WITH WHITE OUTLINING. A LIGHTHOUSE APPEARS IN THE BACKGROUND OF THE MARK IN THE COLOR GRAY WITH RED OUTLINING, WITH A RED AND GRAY FRONT AND A BLACK LOWER BASE. YELLOW RAYS OF LIGHT EMANATE FROM THE LIGHTHOUSE. THE MARK IS CARRIED BY A RED HEART OUTLINED IN BLUE AND SHADED IN BLACK AND WHITE WITH A PINK CENTER.

FOR RELIGIOUS AND SPIRITUAL SERVICES, NAMELY, PROVIDING GATHERINGS AND RETREATS TO DEVELOP AND ENHANCE THE SPIRITUAL LIVES OF INDIVIDUALS (U.S. CLS. 100 AND 101).
KAREN SEVERSON, EXAMINING ATTORNEY

SN 79-037,497. LOCKSLEY CORPORATION PTY LTD; C/- TRADEMARK WORKS, AUSTRALIA, FILED 3-8-2007.

PARTNER4REAL

THE MARK CONSISTS OF STANDARD CHARACTERS WITHOUT CLAIM TO ANY PARTICULAR FONT, STYLE, SIZE, OR COLOR.

PRIORITY DATE OF 2-13-2007 IS CLAIMED.
OWNER OF INTERNATIONAL REGISTRATION 0921476 DATED 3-8-2007, EXPIRES 3-8-2017.

FOR DATING SERVICES; COMPUTER DATING SERVICES; DATING AGENCY SERVICES; INTERNET BASED SOCIAL NETWORKING AND INTRODUCTIONS (U.S. CLS. 100 AND 101).
CAROLYN GRAY, EXAMINING ATTORNE

* * * * *

SECTION 3.—PRIOR UNITED STATES CLASSIFICATION

APPLICATION IN MORE THAN ONE CLASS

SN 77-007,790. ASSOCIATION OF SITES ADVOCATING CHILD PROTECTION, LOS ANGELES, CA. FILED 9-26-2006.



NO CLAIM IS MADE TO THE EXCLUSIVE RIGHT TO USE "RESTRICTED TO ADULTS", APART FROM THE MARK AS SHOWN.

THE CERTIFICATION MARK, AS USED BY PERSONS IN COMPLIANCE WITH THE TERMS AND CONDITIONS SET FORTH BY THE CERTIFIER, CERTIFIES THAT ANY GOODS AND/OR SERVICES LABELED WITH THE CERTIFICATION MARK FEATURE CONTENT THAT IS NOT SUITABLE FOR MINORS; AND THAT SUCH CONTENT SHOULD BE ACCESSED AND VIEWED ONLY BY ADULTS
CLASS A—GOODS

FOR PHOTOGRAPHS AND SIMILAR MULTIMEDIA MATERIALS.
CLASS B—SERVICES
FOR RADIO AND TELEVISION BROADCASTS; PROVIDING WEBSITES FEATURING PHOTOGRAPHS AND MULTIMEDIA ENTERTAINMENT MATERIALS.
KIMBERLY FRYE, EXAMINING ATTORNEY

SN 77-155,646. SIP FORUM LLC, NORTH ANDOVER, MA. FILED 4-12-2007.

SIPCONNECT

THE MARK CONSISTS OF STANDARD CHARACTERS WITHOUT CLAIM TO ANY PARTICULAR FONT, STYLE, SIZE, OR COLOR.

THE CERTIFICATION MARK, AS INTENDED TO BE USED BY AUTHORIZED PERSONS, IS INTENDED TO CERTIFY THAT GOODS MANUFACTURED AND SERVICES PROVIDED BY AUTHORIZED PERSONS COMPLY WITH INTEROPERABILITY STANDARDS.
CLASS A—GOODS

FOR PERSONAL COMMUNICATIONS SOFTWARE, ENTERPRISE COMMUNICATIONS SOFTWARE, IP PBX SYSTEMS, AND IP TELEPHONES.

CLASS B—SERVICES
FOR COMMUNICATIONS SERVICE PROVIDER SERVICES.
KARANENDRA S. CHHINA, EXAMINING ATTORNEY

SN 77-159,009. SIP FORUM LLC, NORTH ANDOVER, MA. FILED 4-17-2007.



THE CERTIFICATION MARK, AS INTENDED TO BE USED BY AUTHORIZED PERSONS, IS INTENDED TO CERTIFY THAT GOODS MANUFACTURED AND SERVICES PROVIDED BY AUTHORIZED PERSONS COMPLY WITH INTEROPERABILITY STANDARDS.
CLASS A—GOODS

FOR PERSONAL COMMUNICATIONS SOFTWARE, ENTERPRISE COMMUNICATIONS SOFTWARE, IP PBX SYSTEMS, AND IP TELEPHONES.
CLASS B—SERVICES
FOR COMMUNICATIONS SERVICE PROVIDER SERVICES.
KARANENDRA S. CHHINA, EXAMINING ATTORNEY

SN 77-159,011. SIP FORUM LLC, NORTH ANDOVER, MA. FILED 4-17-2007.



NO CLAIM IS MADE TO THE EXCLUSIVE RIGHT TO USE "CERTIFIED", APART FROM THE MARK AS SHOWN.

THE CERTIFICATION MARK, AS INTENDED TO BE USED BY AUTHORIZED PERSONS, IS INTENDED TO CERTIFY THAT GOODS MANUFACTURED AND SERVICES PROVIDED BY AUTHORIZED PERSONS COMPLY WITH INTEROPERABILITY STANDARDS.

CLASS A—GOODS
FOR PERSONAL COMMUNICATIONS SOFTWARE, ENTERPRISE COMMUNICATIONS SOFTWARE, IP PBX SYSTEMS, AND IP TELEPHONES.
CLASS B—SERVICES
FOR COMMUNICATIONS SERVICE PROVIDER SERVICES.
KARANENDRA S. CHHINA, EXAMINING ATTORNEY

* * * * *

SECTION 4.—PRIOR UNITED STATES CLASSIFICATION

APPLICATION IN ONE CLASS

CERTIFICATION MARKS

CLASS B—SERVICES
SN 76-454,894. INTERNATIONAL FOUNDATION OF EM-
PLOYEE BENEFIT PLANS, INC., BROOKFIELD, WI.
FILED 9-27-2002.

THE CERTIFICATION MARK, AS INTENDED TO BE
USED BY AUTHORIZED PERSONS, IS INTENDED TO
CERTIFY THAT SUCH PERSONS HAVE MET THE CERTI-
FIER'S EDUCATIONAL REQUIREMENTS IN THE FIELD
OF COMPENSATION MANAGEMENT.
FOR ADMINISTRATION OF EMPLOYEE BENEFIT
PLANS, NAMELY, COMPENSATION MANAGEMENT.
CURTIS FRENCH, EXAMINING ATTORNE

CMS

* * * * *

TRADEMARK REGISTRATIONS ISSUED

PRINCIPAL REGISTER

SECTION 1.— INTERNATIONAL CLASSIFICATION

The short titles associated below with the international class numbers are terms designed merely for quick identification and are not an official part of the international classification. The full names of international classes are given in section 6.1 of the trademark rules of practice.

The designation "U.S. Cl." appearing in this section refers to the U.S. class in effect prior to Sep. 1, 1973 rather than the international class which applies to applications filed on or after that date. For adoption of international classification see notice in the OFFICIAL GAZETTE of Jun. 26, 1973 (911 O.G. TM 210).

CLASS 1—CHEMICALS

- 3,310,188. **DELTA. NOVOZYMES DELTA LIMITED, MULTIPLE CLASS, (INT. CLS. 1 AND 5), (U.S. CLS. 1, 5, 6, 10, 18, 26, 44, 46, 51 AND 52).** SN 75-326,194. PUB. 7-31-2007. FILED 7-17-1997.
- 3,310,226. **ALTANA AND DESIGN. ALTANA AG, MULTIPLE CLASS, (INT. CLS. 1, 2, 9, 17 AND 30), (U.S. CLS. 1, 5, 6, 10, 11, 12, 13, 16, 21, 23, 26, 35, 36, 38, 46 AND 50).** SN 76-464,844. PUB. 7-31-2007. FILED 10-28-2002.
- 3,310,232. **CERACAT. DYTECH CORPORATION LIMITED, MULTIPLE CLASS, (INT. CLS. 1, 40 AND 42), (U.S. CLS. 1, 5, 6, 10, 26, 46, 100, 101, 103 AND 106).** SN 76-512,851. PUB. 7-31-2007. FILED 5-8-2003.
- 3,310,234. **ATMI AND DESIGN. ADVANCED TECHNOLOGY MATERIALS, INC., MULTIPLE CLASS, (INT. CLS. 1, 6, 7, 9, 11, 22, 35, 37, 40 AND 42), (U.S. CLS. 1, 2, 5, 6, 7, 10, 12, 13, 14, 19, 21, 22, 23, 25, 26, 31, 34, 35, 36, 38, 42, 46, 50, 100, 101, 102, 103 AND 106).** SN 76-550,175. PUB. 7-31-2007. FILED 10-8-2003.
- 3,310,248. **JACKSONLEA (BLOCK FORM). JASON INC., MULTIPLE CLASS, (INT. CLS. 1, 2, 3, 7 AND 24), (U.S. CLS. 1, 4, 5, 6, 10, 11, 13, 16, 19, 21, 23, 26, 31, 34, 35, 42, 46, 50, 51 AND 52).** SN 76-619,908. PUB. 7-31-2007. FILED 11-9-2004.
- 3,310,479. **BIO-DEX (BLOCK FORM). BIO-DEX LABORATORIES, (U.S. CLS. 1, 5, 6, 10, 26 AND 46).** SN 77-010,708. PUB. 7-31-2007. FILED 9-29-2006.
- 3,310,576. **OKEOSORB (BLOCK FORM). BEKO CONDENSATE SYSTEMS CORPORATION, DBA BEKO TECHNOLOGIES CORP. (U.S. CLS. 1, 5, 6, 10, 26 AND 46).** SN 77-025,430. PUB. 7-31-2007. FILED 10-19-2006.
- 3,310,690. **CARBONPOWERED (BLOCK FORM). FLORATINE PRODUCTS GROUP, (U.S. CLS. 1, 5, 6, 10, 26 AND 46).** SN 77-046,594. PUB. 7-31-2007. FILED 11-17-2006.
- 3,310,763. **AV7 (STYLIZED). AV7 LIMITED, MULTIPLE CLASS, (INT. CLS. 1, 5 AND 10), (U.S. CLS. 1, 5, 6, 10, 18, 26, 39, 44, 46, 51 AND 52).** SN 77-056,200. PUB. 7-17-2007. FILED 12-4-2006.
- 3,310,764. **HESS AND DESIGN. HESS CORPORATION, MULTIPLE CLASS, (INT. CLS. 1, 4, 25, 28, 35, 37, 39, 40 AND 42), (U.S. CLS. 1, 5, 6, 10, 15, 22, 23, 26, 38, 39, 46, 50, 100, 101, 102, 103, 105 AND 106).** SN 77-056,382. PUB. 7-31-2007. FILED 12-4-2006.
- 3,310,794. **NO HEAT PURPLE (BLOCK FORM). NO HEAT RESOURCES, LLC, (U.S. CLS. 1, 5, 6, 10, 26 AND 46).** SN 77-060,888. PUB. 7-31-2007. FILED 12-10-2006.
- 3,310,795. **NO HEAT GREEN (BLOCK FORM). NO HEAT RESOURCES, LLC, (U.S. CLS. 1, 5, 6, 10, 26 AND 46).** SN 77-060,889. PUB. 7-31-2007. FILED 12-10-2006.
- 3,310,796. **NO HEAT (BLOCK FORM). NO HEAT RESOURCES, LLC, (U.S. CLS. 1, 5, 6, 10, 26 AND 46).** SN 77-060,890. PUB. 7-31-2007. FILED 12-10-2006.
- 3,310,812. **MISCELLANEOUS DESIGN. NO HEAT RESOURCES, LLC, (U.S. CLS. 1, 5, 6, 10, 26 AND 46).** SN 77-062,823. PUB. 7-31-2007. FILED 12-12-2006.
- 3,310,818. **EZ-POLY (BLOCK FORM). VALIANT TECHNOLOGIES, INC., (U.S. CLS. 1, 5, 6, 10, 26 AND 46).** SN 77-063,806. PUB. 7-31-2007. FILED 12-13-2006.
- 3,310,861. **M-BUSTER (BLOCK FORM). TAIHUANG CHANG, (U.S. CLS. 1, 5, 6, 10, 26 AND 46).** SN 77-067,639. PUB. 7-31-2007. FILED 12-19-2006.
- 3,310,919. **LIFEBLOOD (BLOCK FORM). MID-SOUTH REGIONAL BLOOD CENTER, MULTIPLE CLASS, (INT. CLS. 1, 42 AND 44), (U.S. CLS. 1, 5, 6, 10, 26, 46, 100 AND 101).** SN 77-069,668. PUB. 7-31-2007. FILED 12-21-2006.
- 3,310,921. **LIFEBLOOD AND DESIGN. MID-SOUTH REGIONAL BLOOD CENTER, MULTIPLE CLASS, (INT. CLS. 1, 42 AND 44), (U.S. CLS. 1, 5, 6, 10, 26, 46, 100 AND 101).** SN 77-069,752. PUB. 7-31-2007. FILED 12-21-2006.
- 3,311,113. **AGROKELP (BLOCK FORM). K & W AGRICHEMICALS INC., (U.S. CLS. 1, 5, 6, 10, 26 AND 46).** SN 77-074,932. PUB. 7-31-2007. FILED 1-3-2007.
- 3,311,237. **PURAMATRIX (BLOCK FORM). 3-DMATRIX, INC., (U.S. CLS. 1, 5, 6, 10, 26 AND 46).** SN 77-086,077. PUB. 7-31-2007. FILED 1-18-2007.
- 3,311,260. **MASTERPAVE (BLOCK FORM). CONSTRUCTION RESEARCH & TECHNOLOGY, GMBH, (U.S. CLS. 1, 5, 6, 10, 26 AND 46).** SN 77-088,127. PUB. 7-31-2007. FILED 1-22-2007.
- 3,311,534. **VAC (STYLIZED). ADVANCED TECHNOLOGY MATERIALS, INC., MULTIPLE CLASS, (INT. CLS. 1 AND 6), (U.S. CLS. 1, 2, 5, 6, 10, 12, 13, 14, 23, 25, 26, 46 AND 50).** SN 77-114,396. PUB. 7-31-2007. FILED 2-23-2007.
- 3,311,584. **MANIFEST (BLOCK FORM). WILBUR-ELLIS COMPANY, (U.S. CLS. 1, 5, 6, 10, 26 AND 46).** SN 77-129,447. PUB. 7-31-2007. FILED 3-13-2007.
- 3,311,615. **O-FIX (BLOCK FORM). SURGIPATH MEDICAL INDUSTRIES, INC., (U.S. CLS. 1, 5, 6, 10, 26 AND 46).** SN 77-150,988. PUB. 7-31-2007. FILED 4-6-2007.
- 3,311,631. **MISCELLANEOUS DESIGN. KARO BIO AB, MULTIPLE CLASS, (INT. CLS. 1, 5, 10, 14, 16, 25, 42 AND 44), (U.S. CLS. 1, 2, 5, 6, 10, 18, 22, 23, 26, 27, 28, 29, 37, 38, 39, 44, 46, 50, 51, 52, 100 AND 101).** SN 78-144,228. PUB. 7-31-2007. FILED 7-16-2002.
- 3,311,641. **DYNNOX. UMICORE AG & CO. KG, MULTIPLE CLASS, (INT. CLS. 1, 7 AND 11), (U.S. CLS. 1, 5, 6, 10, 13, 19, 21, 23, 26, 31, 34, 35 AND 46).** SN 78-225,816. PUB. 7-31-2007. FILED 3-14-2003.
- 3,311,730. **THIXOGUM (BLOCK FORM). CNI COLLOIDES NATURELS INTERNATIONAL, (U.S. CLS. 1, 5, 6, 10, 26 AND 46).** SN 78-651,061. PUB. 7-31-2007. FILED 6-15-2005.
- 3,311,747. **CHOZN (BLOCK FORM). SANGAMO BIOSCIENCES, INC., MULTIPLE CLASS, (INT. CLS. 1 AND 5), (U.S. CLS. 1, 5, 6, 10, 18, 26, 44, 46, 51 AND 52).** SN 78-671,445. PUB. 7-31-2007. FILED 7-15-2005.
- 3,311,781. **G BIOSCIENCES (BLOCK FORM). GENO TECHNOLOGY, INC., MULTIPLE CLASS, (INT. CLS. 1 AND 16), (U.S. CLS. 1, 2, 5, 6, 10, 22, 23, 26, 29, 37, 38, 46 AND 50).** SN 78-700,508. PUB. 7-31-2007. FILED 8-25-2005.
- 3,311,839. **LEUPHASYL (BLOCK FORM). LIPOTEC S.A., MULTIPLE CLASS, (INT. CLS. 1, 3 AND 5), (U.S. CLS. 1, 4, 5, 6, 10, 18, 26, 44, 46, 50, 51 AND 52).** SN 78-740,016. PUB. 7-31-2007. FILED 10-25-2005.
- 3,311,869. **JURASSIC ACID (STYLIZED). LIGHT MANUFACTURING CO, (U.S. CLS. 1, 5, 6, 10, 26 AND 46).** SN 78-765,795. PUB. 7-31-2007. FILED 12-2-2005.
- 3,311,911. **FRYLIQUID (BLOCK FORM). OIL PROCESS SYSTEMS, INC., (U.S. CLS. 1, 5, 6, 10, 26 AND 46).** SN 78-800,132. PUB. 7-31-2007. FILED 1-26-2006.

3,312,165. **MISCELLANEOUS DESIGN**. BIOSAFE SYSTEMS LLC, (U.S. CLS. 1, 5, 6, 10, 26 AND 46). SN 78-880,962. PUB. 7-31-2007. FILED 5-10-2006.

3,312,168. **SUBEXPLORER (BLOCK FORM)**. INTREXON CORPORATION, MULTIPLE CLASS, (INT. CLS. 1, 5 AND 40), (U.S. CLS. 1, 5, 6, 10, 18, 26, 44, 46, 51, 52, 100, 103 AND 106). SN 78-881,099. PUB. 7-31-2007. FILED 5-11-2006.

3,312,201. **ISCOM (BLOCK FORM)**. ISCOTEC AB, MULTIPLE CLASS, (INT. CLS. 1 AND 5), (U.S. CLS. 1, 5, 6, 10, 18, 26, 44, 46, 51 AND 52). SN 78-885,591. PUB. 7-31-2007. FILED 5-17-2006.

3,312,214. **SUPER SHOCKWAVE (BLOCK FORM)**. ALLIANCE TRADING, INC., (U.S. CLS. 1, 5, 6, 10, 26 AND 46). SN 78-887,014. PUB. 7-31-2007. FILED 5-18-2006.

3,312,269. **BIOSINFO (BLOCK FORM)**. AAA CONSTRUCTION & DEVELOPMENT CORP., (U.S. CLS. 1, 5, 6, 10, 26 AND 46). SN 78-898,859. PUB. 7-31-2007. FILED 6-2-2006.

3,312,360. **BADGERLINERS (BLOCK FORM)**. VOLATILE FREE, INC., MULTIPLE CLASS, (INT. CLS. 1 AND 2), (U.S. CLS. 1, 5, 6, 10, 11, 16, 26 AND 46). SN 78-915,264. PUB. 7-31-2007. FILED 6-23-2006.

3,312,362. **KROFF (BLOCK FORM)**. KROFF, INC., (U.S. CLS. 1, 5, 6, 10, 26 AND 46). SN 78-915,660. PUB. 7-31-2007. FILED 6-23-2006.

3,312,435. **ALWAYS NEW (BLOCK FORM)**. KIMPEN, S.A. DE C.V., (U.S. CLS. 1, 5, 6, 10, 26 AND 46). SN 78-926,461. PUB. 7-31-2007. FILED 7-11-2006.

3,312,460. **RE-FRESH (BLOCK FORM)**. ALLIANCE TRADING, INC., (U.S. CLS. 1, 5, 6, 10, 26 AND 46). SN 78-929,125. PUB. 7-31-2007. FILED 7-13-2006.

3,312,668. **MF-55 (BLOCK FORM)**. CP KELCO U.S., INC., (U.S. CLS. 1, 5, 6, 10, 26 AND 46). SN 78-969,996. PUB. 7-31-2007. FILED 9-8-2006.

3,312,701. **WEDI (BLOCK FORM)**. WEDI, STEPHAN, MULTIPLE CLASS, (INT. CLS. 1, 2, 6, 9, 11, 17 AND 19), (U.S. CLS. 1, 2, 5, 6, 10, 11, 12, 13, 14, 16, 21, 23, 25, 26, 31, 33, 34, 35, 36, 38, 46 AND 50). SN 79-003,458. PUB. 7-31-2007. FILED S.R. 6-11-2004; AM. P.R. 1-3-2006.

3,312,705. **MC AND DESIGN**. VALAGRO S.P.A., (U.S. CLS. 1, 5, 6, 10, 26 AND 46). SN 79-009,998. PUB. 7-31-2007. FILED 2-28-2005.

3,312,712. **HYDRO AND DESIGN**. NORSK HYDRO ASA, MULTIPLE CLASS, (INT. CLS. 1, 4, 6, 22, 37, 39, 40 AND 42), (U.S. CLS. 1, 2, 5, 6, 7, 10, 12, 13, 14, 15, 19, 22, 23, 25, 26, 42, 46, 50, 100, 101, 103, 105 AND 106). SN 79-014,337. PUB. 7-31-2007. FILED 5-12-2004.

3,312,717. **H-CUBE (BLOCK FORM)**. THALES NANOTECHNOLOGIAI RT., MULTIPLE CLASS, (INT. CLS. 1, 7 AND 9), (U.S. CLS. 1, 5, 6, 10, 13, 19, 21, 23, 26, 31, 34, 35, 36, 38 AND 46). SN 79-015,177. PUB. 7-31-2007. FILED 6-16-2005.

3,312,818. **VINTESSENTIAL LABORATORIES (BLOCK FORM)**. VINTESSENTIAL LABORATORIES PTY LTD, MULTIPLE CLASS, (INT. CLS. 1, 9 AND 42), (U.S. CLS. 1, 5, 6, 10, 21, 23, 26, 36, 38, 46, 100 AND 101). SN 79-027,232. PUB. 7-31-2007. FILED 5-25-2006.

3,312,845. **SIKAMID (BLOCK FORM)**. SIKA AG, MULTIPLE CLASS, (INT. CLS. 1 AND 17), (U.S. CLS. 1, 5, 6, 10, 12, 13, 26, 35, 46 AND 50). SN 79-028,140. PUB. 7-31-2007. FILED 8-14-2006.

3,312,885. **NANOLIPID RESTORE CLR (BLOCK FORM)**. CHEMISCHES LABORATORIUM; DR. KURT RICHTER GMBH, (U.S. CLS. 1, 5, 6, 10, 26 AND 46). SN 79-029,805. PUB. 7-31-2007. FILED 9-8-2006.

3,312,892. **KETASPIRE (BLOCK FORM)**. SOLVAY SA, MULTIPLE CLASS, (INT. CLS. 1 AND 17), (U.S. CLS. 1, 5, 6, 10, 12, 13, 26, 35, 46 AND 50). SN 79-030,058. PUB. 7-31-2007. FILED 9-29-2006.

3,312,893. **PRIMOSPIRE (BLOCK FORM)**. SOLVAY SA, MULTIPLE CLASS, (INT. CLS. 1 AND 17), (U.S. CLS. 1, 5, 6, 10, 12, 13, 26, 35, 46 AND 50). SN 79-030,060. PUB. 7-31-2007. FILED 9-8-2006.

3,312,906. **ACTIBREW ADDING VALUE TO BREWING AND DESIGN**. BARRY CALLEBAUT AG, MULTIPLE CLASS, (INT. CLS. 1 AND 32), (U.S. CLS. 1, 5, 6, 10, 26, 45, 46 AND 48). SN 79-030,503. PUB. 7-31-2007. FILED 10-3-2006.

3,312,920. **ITZO (BLOCK FORM)**. IDEMITSU KOSAN CO., LTD., MULTIPLE CLASS, (INT. CLS. 1 AND 9), (U.S. CLS. 1, 5, 6, 10, 21, 23, 26, 36, 38 AND 46). SN 79-031,307. PUB. 7-

31-2007. FILED 10-11-2006.

3,312,952. **UNIBODY (BLOCK FORM)**. GENMAB A/S, MULTIPLE CLASS, (INT. CLS. 1, 5 AND 42), (U.S. CLS. 1, 5, 6, 10, 18, 26, 44, 46, 51, 52, 100 AND 101). SN 79-034,253. PUB. 7-31-2007. FILED 10-19-2006.

3,312,953. **RESORB (STYLIZED)**. RHODIA CHIMIE, MULTIPLE CLASS, (INT. CLS. 1 AND 40), (U.S. CLS. 1, 5, 6, 10, 26, 46, 100, 103 AND 106). SN 79-034,414. PUB. 7-31-2007. FILED 12-29-2006.

CLASS 2—PAINTS

3,310,226 (*See Class 1 for this trademark*).

3,310,248 (*See Class 1 for this trademark*).

3,310,392. **PORTA-LINER (BLOCK FORM)**. SPRAY ON PRODUCTS, LTD., (U.S. CLS. 6, 11 AND 16). SN 76-670,497. PUB. 7-31-2007. FILED 12-18-2006.

3,310,393. **PORTA-COAT (BLOCK FORM)**. SPRAY ON PRODUCTS, LTD., (U.S. CLS. 6, 11 AND 16). SN 76-670,498. PUB. 7-31-2007. FILED 12-18-2006.

3,310,463. **ALUMACLEAR THE ULTIMATE ALUMINUM CLEAR COAT SYSTEM (STYLIZED)**. ALUMACLEAR CORPORATION, (U.S. CLS. 6, 11 AND 16). SN 77-007,461. PUB. 7-31-2007. FILED 9-26-2006.

3,310,502. **M MEGA AND DESIGN**. MEGA INDUSTRIES CORP., (U.S. CLS. 6, 11 AND 16). SN 77-013,274. PUB. 7-31-2007. FILED 10-4-2006.

3,310,544. **MK PENETRATING SEALER AND DESIGN**. MARBLE KARE PRODUCTS, INC., (U.S. CLS. 6, 11 AND 16). SN 77-020,081. PUB. 7-31-2007. FILED 10-12-2006.

3,311,159. **PERMACHROME (BLOCK FORM)**. SPECTRUM METALWORKS, INC., (U.S. CLS. 6, 11 AND 16). SN 77-079,666. PUB. 7-31-2007. FILED 1-10-2007.

3,311,200. **BESTEMP (BLOCK FORM)**. CERTIFIED COLOR CORPORATION, (U.S. CLS. 6, 11 AND 16). SN 77-083,252. PUB. 7-31-2007. FILED 1-15-2007.

3,311,452. **REVOTECH (BLOCK FORM)**. BETCO CORPORATION, LTD., (U.S. CLS. 6, 11 AND 16). SN 77-100,099. PUB. 7-31-2007. FILED 2-6-2007.

3,311,491. **ASPHANE (BLOCK FORM)**. GUPTA, LAXMI C, (U.S. CLS. 6, 11 AND 16). SN 77-104,066. PUB. 7-31-2007. FILED 2-9-2007.

3,311,533. **E-PRIME (BLOCK FORM)**. GUPTA, LAXMI C, (U.S. CLS. 6, 11 AND 16). SN 77-114,067. PUB. 7-31-2007. FILED 2-22-2007.

3,311,634. **VARIOCOLOR**. OCE-TECHNOLOGIES B.V., MULTIPLE CLASS, (INT. CLS. 2, 9, 16, 37 AND 42), (U.S. CLS. 2, 5, 6, 11, 16, 21, 22, 23, 26, 29, 36, 37, 38, 50, 100, 101, 103 AND 106). SN 78-179,100. PUB. 7-31-2007. FILED 10-28-2002.

3,311,901. **EVERSHINE (BLOCK FORM)**. PLANCHERS DES APPALACHES LTÉE, (U.S. CLS. 6, 11 AND 16). SN 78-791,756. PUB. 7-31-2007. FILED 1-13-2006.

3,312,353. **CERTI-SHINE (BLOCK FORM)**. POLYSAT, INC., (U.S. CLS. 6, 11 AND 16). SN 78-913,272. PUB. 7-31-2007. FILED 6-21-2006.

3,312,360 (*See Class 1 for this trademark*).

3,312,699. **FERROGARD AND DESIGN**. BRANOPAC GMBH, (U.S. CLS. 6, 11 AND 16). SN 79-000,162. PUB. 7-31-2007. FILED 11-11-2003.

3,312,701 (*See Class 1 for this trademark*).

3,312,941. **DECOFUN (STYLIZED)**. MULTI-COMMUNICATION; NAAMLOZE VENNOOTSCHAP, MULTIPLE CLASS, (INT. CLS. 2, 11 AND 24), (U.S. CLS. 6, 11, 13, 16, 21, 23, 31, 34, 42 AND 50). SN 79-033,095. PUB. 7-31-2007. FILED 8-31-2006.

CLASS 3—COSMETICS AND CLEANING PREPARATIONS

3,310,204. **GOODWOOD**. GOODWOOD ESTATE COMPANY LIMITED, THE, MULTIPLE CLASS, (INT. CLS. 3, 4, 6, 9, 12, 14, 16, 18, 25, 26, 28, 35, 37, 41 AND 42), (U.S. CLS. 1, 2, 3, 4, 5, 6, 12, 13, 14, 15, 19, 21, 22, 23, 25, 26, 27, 28, 29, 31, 35, 36, 37,

- 38, 39, 40, 41, 42, 44, 50, 51, 52, 100, 101, 102, 103, 106 AND 107). SN 76-023,031. PUB. 4-17-2007. FILED 4-11-2000.
3,310,248 (See Class 1 for this trademark).
- 3,310,279. **LE SUPRE-DIAMANT COUTURE DE MAKI (BLOCK FORM)**. MIKI CORPORATION, (U.S. CLS. 1, 4, 6, 50, 51 AND 52). SN 76-651,951. PUB. 7-31-2007. FILED 12-15-2005.
- 3,310,291. **WRAP & ROLL (BLOCK FORM)**. CARTER JANE, (U.S. CLS. 1, 4, 6, 50, 51 AND 52). SN 76-657,383. PUB. 7-31-2007. FILED 3-23-2006.
- 3,310,322. **MISCELLANEOUS DESIGN**. COFINLUXE, (U.S. CLS. 1, 4, 6, 50, 51 AND 52). SN 76-661,504. PUB. 7-31-2007. FILED 6-13-2006.
- 3,310,368. **INBODYMENT (BLOCK FORM)**. MARTIN, JU-DEE, (U.S. CLS. 1, 4, 6, 50, 51 AND 52). SN 76-667,808. PUB. 7-31-2007. FILED 10-20-2006.
- 3,310,379. **INK AND DESIGN**. NYX, LOS ANGELES INC., (U.S. CLS. 1, 4, 6, 50, 51 AND 52). SN 76-668,820. PUB. 7-31-2007. FILED 11-13-2006.
- 3,310,409. **NYX (STYLIZED)**. NYX, LOS ANGELES INC., (U.S. CLS. 1, 4, 6, 50, 51 AND 52). SN 76-671,119. PUB. 7-31-2007. FILED 1-8-2007.
- 3,310,412. **PACQUIN (BLOCK FORM)**. JOHNSON & JOHNSON, (U.S. CLS. 1, 4, 6, 50, 51 AND 52). SN 76-671,443. PUB. 7-31-2007. FILED 1-16-2007.
- 3,310,414. **CLAIR & WHITE (BLOCK FORM)**. VICTORIA ALBI S.A.R.L., (U.S. CLS. 1, 4, 6, 50, 51 AND 52). SN 76-671,721. PUB. 7-31-2007. FILED 1-23-2007.
- 3,310,430. **DYNA-DOO (BLOCK FORM)**. BAUM, HAROLD DANIEL, (U.S. CLS. 1, 4, 6, 50, 51 AND 52). SN 77-000,832. PUB. 7-31-2007. FILED 9-15-2006.
- 3,310,545. **MK NEUTRAL KLEAN FOR FLOORS AND DESIGN**. MARBLE KARE PRODUCTS, INC., (U.S. CLS. 1, 4, 6, 50, 51 AND 52). SN 77-020,097. PUB. 7-31-2007. FILED 10-12-2006.
- 3,310,555. **MATERNACARE BY JACQUELYN MARIE, M.D. AND DESIGN**. MAIDEN VOYAGE ENTERPRISES, LLC, (U.S. CLS. 1, 4, 6, 50, 51 AND 52). SN 77-021,522. PUB. 7-31-2007. FILED 10-15-2006.
- 3,310,615. **MAGIC FUR BALL (BLOCK FORM)**. MAGIC FUR BALL, LLC, (U.S. CLS. 1, 4, 6, 50, 51 AND 52). SN 77-032,481. PUB. 7-31-2007. FILED 10-30-2006.
- 3,310,685. **AYURVEDIC LIFESTYLE COLLECTION (BLOCK FORM)**. CHOPRA ENTERPRISES, LLC, (U.S. CLS. 1, 4, 6, 50, 51 AND 52). SN 77-046,233. PUB. 7-31-2007. FILED 11-17-2006.
- 3,310,739. **BLEMISH DOCTOR (BLOCK FORM)**. KEVIN ANDERSON, (U.S. CLS. 1, 4, 6, 50, 51 AND 52). SN 77-053,564. PUB. 7-31-2007. FILED 11-29-2006.
- 3,310,748. **INGROWN ZONE (BLOCK FORM)**. MANCINE COSMETICS PTY LTD, (U.S. CLS. 1, 4, 6, 50, 51 AND 52). SN 77-054,313. PUB. 7-31-2007. FILED 11-30-2006.
- 3,310,750. **SUMMER TAN (BLOCK FORM)**. MANCINE COSMETICS PTY LTD, (U.S. CLS. 1, 4, 6, 50, 51 AND 52). SN 77-054,332. PUB. 7-31-2007. FILED 11-30-2006.
- 3,310,753. **AUDACE (BLOCK FORM)**. ANTONIO PUIG, S.A., (U.S. CLS. 1, 4, 6, 50, 51 AND 52). SN 77-054,490. PUB. 7-31-2007. FILED 11-30-2006.
- 3,310,793. **MYGEL (STYLIZED)**. RAVINDRA JHAVERI, (U.S. CLS. 1, 4, 6, 50, 51 AND 52). SN 77-060,823. PUB. 7-10-2007. FILED 12-10-2006.
- 3,310,848. **DERMOLEO (BLOCK FORM)**. L'OREAL, (U.S. CLS. 1, 4, 6, 50, 51 AND 52). SN 77-067,158. PUB. 7-31-2007. FILED 12-19-2006.
- 3,310,858. **ENERGY PROTECT (BLOCK FORM)**. L'OREAL, (U.S. CLS. 1, 4, 6, 50, 51 AND 52). SN 77-067,598. PUB. 7-31-2007. FILED 12-19-2006.
- 3,310,873. **ARCHANGEL COLOGNE AND DESIGN**. ARCHANGEL BRANDS INC., (U.S. CLS. 1, 4, 6, 50, 51 AND 52). SN 77-067,870. PUB. 7-31-2007. FILED 12-19-2006.
- 3,310,874. **THE MEN PEN (BLOCK FORM)**. ESSENBERG, RYAN J, (U.S. CLS. 1, 4, 6, 50, 51 AND 52). SN 77-067,888. PUB. 7-31-2007. FILED 12-19-2006.
- 3,310,897. **ECO-GREEN (BLOCK FORM)**. WORLDWIDE CLEANING SOLUTIONS, INC., (U.S. CLS. 1, 4, 6, 50, 51 AND 52). SN 77-068,820. PUB. 7-31-2007. FILED 12-20-2006.
- 3,310,904. **ESCAPES BY OGALLALA BODY (BLOCK FORM)**. OGALLALA DOWN COMFORTER COMPANY, MULTIPLE CLASS, (INT. CLS. 3 AND 4), (U.S. CLS. 1, 4, 6, 15, 50, 51 AND 52). SN 77-069,128. PUB. 7-31-2007. FILED 12-21-2006.
- 3,310,911. **PROCAL (BLOCK FORM)**. PROSTRONG, INC., (U.S. CLS. 1, 4, 6, 50, 51 AND 52). SN 77-069,354. PUB. 7-31-2007. FILED 12-21-2006.
- 3,310,936. **VMV HYPOALLERGENICS (BLOCK FORM)**. VER-ALLO-ROWELL, DRA. VERMÉN, (U.S. CLS. 1, 4, 6, 50, 51 AND 52). SN 77-070,617. PUB. 7-31-2007. FILED 12-22-2006.
- 3,310,947. **CALIFORNIA QUEEN (BLOCK FORM)**. BINGHAM, LISA, (U.S. CLS. 1, 4, 6, 50, 51 AND 52). SN 77-070,866. PUB. 7-31-2007. FILED 12-22-2006.
- 3,310,952. **KILL IT DEAD (BLOCK FORM)**. SIMONE CHICKENBONE, LLC, (U.S. CLS. 1, 4, 6, 50, 51 AND 52). SN 77-070,925. PUB. 7-31-2007. FILED 12-23-2006.
- 3,310,953. **GOOD GRAVEY (BLOCK FORM)**. SIMONE CHICKENBONE, LLC, (U.S. CLS. 1, 4, 6, 50, 51 AND 52). SN 77-070,926. PUB. 7-31-2007. FILED 12-23-2006.
- 3,310,954. **BABY POOP (BLOCK FORM)**. SIMONE CHICKENBONE, LLC, (U.S. CLS. 1, 4, 6, 50, 51 AND 52). SN 77-070,927. PUB. 7-31-2007. FILED 12-23-2006.
- 3,310,955. **WEDDING POOP (BLOCK FORM)**. SIMONE CHICKENBONE, LLC, (U.S. CLS. 1, 4, 6, 50, 51 AND 52). SN 77-070,930. PUB. 7-31-2007. FILED 12-23-2006.
- 3,311,105. **HYDRASPERSE (BLOCK FORM)**. INNOVATIVE BIOSCIENCES CORPORATION, (U.S. CLS. 1, 4, 6, 50, 51 AND 52). SN 77-074,753. PUB. 7-31-2007. FILED 1-2-2007.
- 3,311,134. **ROYGBP (BLOCK FORM)**. POLYNICE, DOMINIKA S., (U.S. CLS. 1, 4, 6, 50, 51 AND 52). SN 77-076,460. PUB. 7-31-2007. FILED 1-4-2007.
- 3,311,151. **TERRALUMINA (BLOCK FORM)**. LISA M KADISON, MULTIPLE CLASS, (INT. CLS. 3, 14, 21 AND 44), (U.S. CLS. 1, 2, 4, 6, 13, 23, 27, 28, 29, 30, 33, 40, 50, 51, 52, 100 AND 101). SN 77-077,981. PUB. 7-31-2007. FILED 1-8-2007.
- 3,311,156. **CAMBRURE (BLOCK FORM)**. LANCOME PARFUMS ET BEAUTE & CIE, (U.S. CLS. 1, 4, 6, 50, 51 AND 52). SN 77-079,159. PUB. 7-31-2007. FILED 1-9-2007.
- 3,311,194. **JUST HEAVEN (BLOCK FORM)**. JUST HEAVEN SOAP & BODY PRODUCTS, LLC, (U.S. CLS. 1, 4, 6, 50, 51 AND 52). SN 77-082,592. PUB. 7-31-2007. FILED 1-13-2007.
- 3,311,211. **MILTON TAYLOR (BLOCK FORM)**. TAYLOR NUTRITIONAL PRODUCTS, (U.S. CLS. 1, 4, 6, 50, 51 AND 52). SN 77-084,041. PUB. 7-31-2007. FILED 1-16-2007.
- 3,311,224. **THE AROMATIC OFFICE ENHANCING YOUR BUSINESS WITH AROMATHERAPY AND DESIGN**. THE AROMATIC OFFICE, (U.S. CLS. 1, 4, 6, 50, 51 AND 52). SN 77-085,517. PUB. 7-31-2007. FILED 1-18-2007.
- 3,311,321. **FAHRENHEIT 32 (BLOCK FORM)**. PARFUMS CHRISTIAN DIOR, (U.S. CLS. 1, 4, 6, 50, 51 AND 52). SN 77-093,488. PUB. 7-31-2007. FILED 1-29-2007.
- 3,311,346. **TUBEYOURLASH (BLOCK FORM)**. DAWN FISHER, (U.S. CLS. 1, 4, 6, 50, 51 AND 52). SN 77-095,458. PUB. 7-31-2007. FILED 1-31-2007.
- 3,311,379. **DISSOLVE (BLOCK FORM)**. CLEANING SYSTEMS, INC., (U.S. CLS. 1, 4, 6, 50, 51 AND 52). SN 77-097,592. PUB. 7-31-2007. FILED 2-2-2007.
- 3,311,383. **GLO CRÈME PROTECTANT (BLOCK FORM)**. CLEANING SYSTEMS, INC., (U.S. CLS. 1, 4, 6, 50, 51 AND 52). SN 77-097,714. PUB. 7-31-2007. FILED 2-2-2007.
- 3,311,385. **HYDROCLEAR (BLOCK FORM)**. CLEANING SYSTEMS, INC., (U.S. CLS. 1, 4, 6, 50, 51 AND 52). SN 77-097,749. PUB. 7-31-2007. FILED 2-2-2007.
- 3,311,412. **LASCENT (BLOCK FORM)**. LASCENT LLC, MULTIPLE CLASS, (INT. CLS. 3 AND 5), (U.S. CLS. 1, 4, 6, 18, 44, 46, 50, 51 AND 52). SN 77-098,661. PUB. 7-31-2007. FILED 2-3-2007.
- 3,311,413. **LEONARDO'S PRODUCTS (BLOCK FORM)**. LABORATORIOS NORUEL, (U.S. CLS. 1, 4, 6, 50, 51 AND 52). SN 77-098,667. PUB. 7-31-2007. FILED 2-3-2007.
- 3,311,446. **TECHNIQUE TUESDAY (BLOCK FORM)**. TECHNIQUE TUESDAY, LLC, MULTIPLE CLASS, (INT. CLS. 3 AND 16), (U.S. CLS. 1, 2, 4, 5, 6, 22, 23, 29, 37, 38, 50, 51 AND 52). SN 77-099,655. PUB. 7-31-2007. FILED 2-5-2007.
- 3,311,449. **MISCELLANEOUS DESIGN**. DERMORGANIC LABORATORIES, INC., (U.S. CLS. 1, 4, 6, 50, 51 AND 52). SN 77-099,796. PUB. 7-31-2007. FILED 2-5-2007.
- 3,311,451. **CRYOPUNCTURE (BLOCK FORM)**. LANCOME PARFUMS ET BEAUTE & CIE, (U.S. CLS. 1, 4, 6, 50, 51

- AND 52). SN 77-100,009. PUB. 7-31-2007. FILED 2-6-2007.
- 3,311,570. **CARIBBEAN DREAM (BLOCK FORM)**. STYLORS, INC., AND JESSE BRIGGS & BLANCA F. BRIGGS, (U.S. CLS. 1, 4, 6, 50, 51 AND 52). SN 77-125,511. PUB. 7-31-2007. FILED 3-8-2007.
- 3,311,620. **MIDNIGHT POISON AND DESIGN**. PARFUMS CHRISTIAN DIOR, (U.S. CLS. 1, 4, 6, 50, 51 AND 52). SN 77-158,743. PUB. 7-31-2007. FILED 4-17-2007.
- 3,311,625. **KITCHEN KLENZER (STYLIZED)**. FITZPATRICK BROS., INC., (U.S. CLS. 1, 4, 6, 50, 51 AND 52). SN 77-176,137. PUB. 7-31-2007. FILED 5-9-2007.
- 3,311,664. **MEDLINE AND DESIGN**. MEDLINE INDUSTRIES, INC., MULTIPLE CLASS, (INT. CLS. 3, 5, 9, 10, 12, 16, 20, 21, 24, 25, 27 AND 35), (U.S. CLS. 1, 2, 4, 5, 6, 13, 18, 19, 20, 21, 22, 23, 25, 26, 29, 30, 31, 32, 33, 35, 36, 37, 38, 39, 40, 42, 44, 46, 50, 51, 52, 100, 101 AND 102). SN 78-476,716. PUB. 7-31-2007. FILED 8-31-2004.
- 3,311,696. **H C H A R M O N Y C O V E AND DESIGN**. HARMONISATION LIMITED, MULTIPLE CLASS, (INT. CLS. 3, 8, 14, 16, 18, 20, 21, 24, 25, 41, 42, 43, 44 AND 45), (U.S. CLS. 1, 2, 3, 4, 5, 6, 13, 22, 23, 25, 27, 28, 29, 30, 32, 33, 37, 38, 39, 40, 41, 42, 44, 50, 51, 52, 100, 101 AND 107). SN 78-570,783. PUB. 7-31-2007. FILED 2-18-2005.
- 3,311,721. **CHEZ CLÉMENT RESTAURANT AND DESIGN**. PIB HOLDING, MULTIPLE CLASS, (INT. CLS. 3, 16, 18, 21, 24 AND 43), (U.S. CLS. 1, 2, 3, 4, 5, 6, 13, 22, 23, 29, 30, 33, 37, 38, 40, 41, 42, 50, 51, 52, 100 AND 101). SN 78-640,376. PUB. 7-31-2007. FILED 5-31-2005.
- 3,311,723. **FUN BY ESPOIR (STYLIZED)**. AMOREPACIFIC CORPORATION, (U.S. CLS. 1, 4, 6, 50, 51 AND 52). SN 78-641,599. PUB. 5-29-2007. FILED 6-1-2005.
- 3,311,772. **L'OEIL DU VERT (BLOCK FORM)**. ALEXANDER, H., (U.S. CLS. 1, 4, 6, 50, 51 AND 52). SN 78-697,652. PUB. 7-31-2007. FILED 8-22-2005.
- 3,311,804. **THEFACESHOP (BLOCK FORM)**. THEFACESHOP KOREA CO., LTD., (U.S. CLS. 1, 4, 6, 50, 51 AND 52). SN 78-719,900. PUB. 7-31-2007. FILED 9-23-2005.
- 3,311,824. **CRAVE CONTROL (BLOCK FORM)**. FUSION BRANDS INTERNATIONAL SRL, (U.S. CLS. 1, 4, 6, 50, 51 AND 52). SN 78-731,014. PUB. 7-31-2007. FILED 10-11-2005.
- 3,311,839 (*See Class 1 for this trademark*).
- 3,311,890. **PEAU MAGNIFIQUE (BLOCK FORM)**. BAYS BROWN LABORATORIES, INC., (U.S. CLS. 1, 4, 6, 50, 51 AND 52). SN 78-785,210. PUB. 7-31-2007. FILED 1-4-2006.
- 3,311,898. **MEDLINE (BLOCK FORM)**. MEDLINE INDUSTRIES, INC., MULTIPLE CLASS, (INT. CLS. 3, 9, 11, 12, 16, 20, 21, 22, 24, 25, 27 AND 35), (U.S. CLS. 1, 2, 4, 5, 6, 7, 13, 19, 20, 21, 22, 23, 25, 26, 29, 30, 31, 32, 33, 34, 35, 36, 37, 38, 39, 40, 42, 44, 50, 51, 52, 100, 101 AND 102). SN 78-789,639. PUB. 7-31-2007. FILED 1-12-2006.
- 3,311,966. **AND AND DESIGN**. KEMON S.P.A., (U.S. CLS. 1, 4, 6, 50, 51 AND 52). SN 78-833,186. PUB. 7-31-2007. FILED 3-9-2006.
- 3,311,978. **MAGIC WHITE ICE (BLOCK FORM)**. ANDERSON, KEVIN, (U.S. CLS. 1, 4, 6, 50, 51 AND 52). SN 78-837,960. PUB. 7-31-2007. FILED 3-15-2006.
- 3,312,011. **CRYSTAL CELEBRATION (BLOCK FORM)**. LANCOME PARFUMS ET BEAUTE & CIE, (U.S. CLS. 1, 4, 6, 50, 51 AND 52). SN 78-850,822. PUB. 7-31-2007. FILED 3-31-2006.
- 3,312,033. **STICKER LIFTER (BLOCK FORM)**. MAGIC AMERICAN PRODUCTS, INC., MULTIPLE CLASS, (INT. CLS. 3 AND 8), (U.S. CLS. 1, 4, 6, 23, 28, 44, 50, 51 AND 52). SN 78-855,918. PUB. 7-31-2007. FILED 4-6-2006.
- 3,312,046. **KLEAR ACTION (BLOCK FORM)**. THANE INTERNATIONAL, INC., (U.S. CLS. 1, 4, 6, 50, 51 AND 52). SN 78-860,411. PUB. 7-31-2007. FILED 4-12-2006.
- 3,312,061. **GG AQUA ALLEGORIA GROSELLINA GUERLAIN PARIS 125 ML E 42 FL OZ VAPORISATEUR EAU DE TOILETTE NATURAL SPRAY AND DESIGN**. GUERLAIN S.A., (U.S. CLS. 1, 4, 6, 50, 51 AND 52). SN 78-864,822. PUB. 7-31-2007. FILED 4-19-2006.
- 3,312,087. **SPA LAVISH YOUR PET AND DESIGN**. COSMOS CORPORATION, (U.S. CLS. 1, 4, 6, 50, 51 AND 52). SN 78-871,182. PUB. 7-31-2007. FILED 4-27-2006.
- 3,312,088. **SPA LAVISH YOUR PET (BLOCK FORM)**. COSMOS CORPORATION, (U.S. CLS. 1, 4, 6, 50, 51 AND 52). SN 78-871,192. PUB. 7-31-2007. FILED 4-27-2006.
- 3,312,089. **GINGER ESSENCE (BLOCK FORM)**. ORIGINS NATURAL RESOURCES, INC., (U.S. CLS. 1, 4, 6, 50, 51 AND 52). SN 78-871,276. PUB. 7-31-2007. FILED 4-27-2006.
- 3,312,113. **FULFILLMENT (BLOCK FORM)**. AVEDA CORPORATION, (U.S. CLS. 1, 4, 6, 50, 51 AND 52). SN 78-874,388. PUB. 7-31-2007. FILED 5-2-2006.
- 3,312,164. **READYCHEM (BLOCK FORM)**. READYCHEM INC., (U.S. CLS. 1, 4, 6, 50, 51 AND 52). SN 78-880,928. PUB. 7-31-2007. FILED 5-10-2006.
- 3,312,189. **ARMATURE (BLOCK FORM)**. LANCOME PARFUMS ET BEAUTE & CIE, (U.S. CLS. 1, 4, 6, 50, 51 AND 52). SN 78-883,929. PUB. 7-31-2007. FILED 5-15-2006.
- 3,312,199. **BELUMED X (BLOCK FORM)**. BELUMED X LLC, MULTIPLE CLASS, (INT. CLS. 3 AND 5), (U.S. CLS. 1, 4, 6, 18, 44, 46, 50, 51 AND 52). SN 78-885,486. PUB. 7-31-2007. FILED 5-17-2006.
- 3,312,212. **AKEED (STYLIZED)**. PROMAX INTERNATIONAL HOLDINGS LIMITED, MULTIPLE CLASS, (INT. CLS. 3, 9, 14, 18, 25 AND 35), (U.S. CLS. 1, 2, 3, 4, 6, 21, 22, 23, 26, 27, 28, 36, 38, 39, 41, 50, 51, 52, 100, 101 AND 102). SN 78-886,962. PUB. 7-31-2007. FILED 5-18-2006.
- 3,312,234. **SISI WASABI ZB CS AND DESIGN**. DREISSIG, ZERLINA, MULTIPLE CLASS, (INT. CLS. 3, 9 AND 24), (U.S. CLS. 1, 4, 6, 21, 23, 26, 36, 38, 42, 50, 51 AND 52). SN 78-890,721. PUB. 7-31-2007. FILED 5-23-2006.
- 3,312,263. **DORIANCE (BLOCK FORM)**. PLANTES ET MEDICINES, MULTIPLE CLASS, (INT. CLS. 3 AND 5), (U.S. CLS. 1, 4, 6, 18, 44, 46, 50, 51 AND 52). SN 78-897,246. PUB. 7-31-2007. FILED 5-31-2006.
- 3,312,268. **SWIMMER'S DEFENSE (BLOCK FORM)**. ICLISOY, JESSICA, (U.S. CLS. 1, 4, 6, 50, 51 AND 52). SN 78-898,682. PUB. 6-19-2007. FILED 6-1-2006.
- 3,312,283. **BEGLEY'S BEST (STYLIZED)**. BEGLEY'S BEST, INC., (U.S. CLS. 1, 4, 6, 50, 51 AND 52). SN 78-901,581. PUB. 7-31-2007. FILED 6-6-2006.
- 3,312,295. **ART OF BEING AND DESIGN**. EMANUEL, ELIZABETH F., MULTIPLE CLASS, (INT. CLS. 3 AND 25), (U.S. CLS. 1, 4, 6, 22, 39, 50, 51 AND 52). SN 78-903,555. PUB. 7-17-2007. FILED 6-8-2006.
- 3,312,299. **LINE & SEAL 24 (BLOCK FORM)**. INTER-MARK USA, INC., (U.S. CLS. 1, 4, 6, 50, 51 AND 52). SN 78-904,606. PUB. 7-31-2007. FILED 6-9-2006.
- 3,312,314. **FRUIT KICKS (BLOCK FORM)**. BELVEDERE INTERNATIONAL INC., (U.S. CLS. 1, 4, 6, 50, 51 AND 52). SN 78-906,685. PUB. 7-31-2007. FILED 6-13-2006.
- 3,312,341. **BEAUTIFUL BATH (BLOCK FORM)**. PH BEAUTY LABS, INC., (U.S. CLS. 1, 4, 6, 50, 51 AND 52). SN 78-911,778. PUB. 7-31-2007. FILED 6-19-2006.
- 3,312,406. **GORGEOUS DRY (BLOCK FORM)**. BOBBI PANTER, LLC, (U.S. CLS. 1, 4, 6, 50, 51 AND 52). SN 78-922,683. PUB. 7-31-2007. FILED 7-5-2006.
- 3,312,417. **HYDROXATONE (BLOCK FORM)**. BELLEZZA PRODUCTS, LLC, (U.S. CLS. 1, 4, 6, 50, 51 AND 52). SN 78-923,690. PUB. 7-31-2007. FILED 7-6-2006.
- 3,312,427. **SYSTEM DESIGN (BLOCK FORM)**. HAYASHI TECNICA, LLC, (U.S. CLS. 1, 4, 6, 50, 51 AND 52). SN 78-925,525. PUB. 7-31-2007. FILED 7-10-2006.
- 3,312,430. **ULTRA-LAST (BLOCK FORM)**. SURF CITY GARAGE, (U.S. CLS. 1, 4, 6, 50, 51 AND 52). SN 78-925,996. PUB. 2-20-2007. FILED 7-10-2006.
- 3,312,541. **CHOO LONDON (BLOCK FORM)**. J. CHOO LIMITED, MULTIPLE CLASS, (INT. CLS. 3 AND 9), (U.S. CLS. 1, 4, 6, 21, 23, 26, 36, 38, 50, 51 AND 52). SN 78-943,381. PUB. 7-31-2007. FILED 8-2-2006.
- 3,312,578. **KERTÉ (BLOCK FORM)**. 1094752 ONTARIO LIMITED, OPERATING AS NISIM INTERNATIONAL, (U.S. CLS. 1, 4, 6, 50, 51 AND 52). SN 78-952,110. PUB. 7-31-2007. FILED 8-15-2006.
- 3,312,645. **OLD ENGLISH (BLOCK FORM)**. RECKITT BENCKISER INC., (U.S. CLS. 1, 4, 6, 50, 51 AND 52). SN 78-965,000. PUB. 7-31-2007. FILED 8-31-2006.
- 3,312,653. **HONEY GIRL ORGANICS AND DESIGN**. MAXFIELD, ANTHONY, R., (U.S. CLS. 1, 4, 6, 50, 51 AND 52). SN 78-966,730. PUB. 7-31-2007. FILED 9-4-2006.
- 3,312,656. **VIOLETTE PRECIEUSE CARON (STYLIZED)**. PARFUMS CARON, (U.S. CLS. 1, 4, 6, 50, 51 AND 52). SN 78-968,064. PUB. 7-31-2007. FILED 9-6-2006.
- 3,312,692. **JONATHAN PRODUCT AND DESIGN**. JO-

NATHAN PRODUCT LLC, (U.S. CLS. 1, 4, 6, 50, 51 AND 52). SN 78-978,421. PUB. 7-31-2007. FILED 2-14-2006.

3,312,694. **I FEEL PRETTY (BLOCK FORM)**, THE LEONARD BERNSTEIN OFFICE, INC., (U.S. CLS. 1, 4, 6, 50, 51 AND 52). SN 78-978,478. PUB. 7-31-2007. FILED 8-21-2006.

3,312,745. **LAURETTA L ...A AND DESIGN**, VERMAR S.R.L., MULTIPLE CLASS, (INT. CLS. 3, 18 AND 25), (U.S. CLS. 1, 2, 3, 4, 6, 22, 39, 41, 50, 51 AND 52). SN 79-020,869. PUB. 7-31-2007. FILED 11-7-2005.

3,312,750. **ALCOTT (STYLIZED)**, FANNING CONSULTORES E SERVIÇOS LDA, MULTIPLE CLASS, (INT. CLS. 3, 9, 14, 18 AND 25), (U.S. CLS. 1, 2, 3, 4, 6, 21, 22, 23, 26, 27, 28, 36, 38, 39, 41, 50, 51 AND 52). SN 79-021,424. PUB. 7-31-2007. FILED 5-6-2005.

3,312,755. **VISILOX (BLOCK FORM)**, SCHWAN-STABILO; COSMETICS GMBH & CO. KG, MULTIPLE CLASS, (INT. CLS. 3 AND 5), (U.S. CLS. 1, 4, 6, 18, 44, 46, 50, 51 AND 52). SN 79-022,059. PUB. 7-31-2007. FILED 12-16-2005.

3,312,783. **ROLF BENZ (STYLIZED)**, ROLF BENZ AG & CO. KG, MULTIPLE CLASS, (INT. CLS. 3, 4, 8, 14, 18, 21, 24 AND 25), (U.S. CLS. 1, 2, 3, 4, 6, 13, 15, 22, 23, 27, 28, 29, 30, 33, 39, 40, 41, 42, 44, 50, 51 AND 52). SN 79-025,087. PUB. 7-31-2007. FILED 3-17-2006.

3,312,786. **ALBINO (BLOCK FORM)**, GIANFRANCO FENIZIA, AND ALBINO D'AMATO, MULTIPLE CLASS, (INT. CLS. 3, 18 AND 25), (U.S. CLS. 1, 2, 3, 4, 6, 22, 39, 41, 50, 51 AND 52). SN 79-025,428. PUB. 4-10-2007. FILED 4-14-2006.

3,312,795. **CARLA FRACCI SALOME' (BLOCK FORM)**, CARLA FRACCI PARFUMS S.R.L., (U.S. CLS. 1, 4, 6, 50, 51 AND 52). SN 79-026,010. PUB. 7-31-2007. FILED 5-5-2006.

3,312,796. **CARLA FRACCI AMLETO (BLOCK FORM)**, CARLA FRACCI PARFUMS S.R.L., (U.S. CLS. 1, 4, 6, 50, 51 AND 52). SN 79-026,011. PUB. 7-31-2007. FILED 5-5-2006.

3,312,819. **CAPHODENT (BLOCK FORM)**, INPHARMA AS, MULTIPLE CLASS, (INT. CLS. 3, 5 AND 21), (U.S. CLS. 1, 2, 4, 6, 13, 18, 23, 29, 30, 33, 40, 44, 46, 50, 51 AND 52). SN 79-027,237. PUB. 7-31-2007. FILED 5-9-2006.

3,312,852. **DNAGE LIFT (BLOCK FORM)**, BEIERSDORF AG, (U.S. CLS. 1, 4, 6, 50, 51 AND 52). SN 79-028,558. PUB. 7-31-2007. FILED 9-2-2006.

3,312,860. **ROUGHUP (BLOCK FORM)**, HANS SCHWARZKOPF & HENKEL GMBH & CO. KG, (U.S. CLS. 1, 4, 6, 50, 51 AND 52). SN 79-028,861. PUB. 7-31-2007. FILED 4-3-2006.

3,312,863. **SERENZO (BLOCK FORM)**, WOOD-FORUM HANDELSGESELLSCHAFT M.B.H., MULTIPLE CLASS, (INT. CLS. 3, 19 AND 27), (U.S. CLS. 1, 4, 6, 12, 19, 20, 33, 37, 42, 50, 51 AND 52). SN 79-028,955. PUB. 7-31-2007. FILED 9-6-2006.

3,312,875. **COMPTOIR DES COTONNIERS AND DESIGN**, CREATIONS NELSON, MULTIPLE CLASS, (INT. CLS. 3, 18, 24 AND 25), (U.S. CLS. 1, 2, 3, 4, 6, 22, 39, 41, 42, 50, 51 AND 52). SN 79-029,554. PUB. 7-31-2007. FILED 7-27-2006.

3,312,876. **FUN & BASICS AND DESIGN**, GRUPO FUN & BASICS, S.A., MULTIPLE CLASS, (INT. CLS. 3, 9, 14, 16, 18, 24, 25 AND 35), (U.S. CLS. 1, 2, 3, 4, 5, 6, 21, 22, 23, 26, 27, 28, 29, 36, 37, 38, 39, 41, 42, 50, 51, 52, 100, 101 AND 102). SN 79-029,563. PUB. 7-31-2007. FILED 1-16-2006.

3,312,877. **NOBACTER (BLOCK FORM)**, BEIERSDORF AG, MULTIPLE CLASS, (INT. CLS. 3 AND 5), (U.S. CLS. 1, 4, 6, 18, 44, 46, 50, 51 AND 52). SN 79-029,575. PUB. 7-31-2007. FILED 9-8-2006.

3,312,907. **NASTROFLEX (BLOCK FORM)**, NASTROFLEX S.P.A., (U.S. CLS. 1, 4, 6, 50, 51 AND 52). SN 79-030,518. PUB. 7-31-2007. FILED 8-7-2006.

3,312,939. **KENKO (BLOCK FORM)**, MARBERT COSMETICS GMBH, (U.S. CLS. 1, 4, 6, 50, 51 AND 52). SN 79-032,757. PUB. 7-31-2007. FILED 11-16-2006.

CLASS 4—LUBRICANTS AND FUELS

3,310,204 (*See Class 3 for this trademark*).

3,310,344. **H AND DESIGN**, HYPERION ENERGY, L.P., (U.S. CLS. 1, 6 AND 15). SN 76-663,935. PUB. 7-31-2007. FILED 8-1-2006.

3,310,566. **SUBURBAN PROPANE (BLOCK FORM)**, SUBURBAN PROPANE, L.P., MULTIPLE CLASS, (INT. CLS. 4, 35, 37 AND 39), (U.S. CLS. 1, 6, 15, 100, 101, 102, 103, 105 AND

106). SN 77-023,842. PUB. 7-31-2007. FILED 10-18-2006.

3,310,567. **SUBURBAN PROPANE (BLOCK FORM)**, SUBURBAN PROPANE, L.P., (U.S. CLS. 1, 6 AND 15). SN 77-023,848. PUB. 7-31-2007. FILED 10-18-2006.

3,310,575. **SUBURBAN PROPANE AND DESIGN**, SUBURBAN PROPANE, L.P., MULTIPLE CLASS, (INT. CLS. 4, 37 AND 39), (U.S. CLS. 1, 6, 15, 100, 103, 105 AND 106). SN 77-025,365. PUB. 7-31-2007. FILED 10-19-2006.

3,310,727. **CAFFÈ VELLUTO (BLOCK FORM)**, GOLD CANYON CANDLES, L.L.C., (U.S. CLS. 1, 6 AND 15). SN 77-051,419. PUB. 7-31-2007. FILED 11-27-2006.

3,310,764 (*See Class 1 for this trademark*).

3,310,766. **STAR CUT (BLOCK FORM)**, BLUE STAR LUBRICATION TECHNOLOGY, LLC, (U.S. CLS. 1, 6 AND 15). SN 77-056,441. PUB. 7-31-2007. FILED 12-4-2006.

3,310,904 (*See Class 3 for this trademark*).

3,311,427. **BIOLA (BLOCK FORM)**, NORTHERN CANOLA GROWERS ASSOCIATION INC, (U.S. CLS. 1, 6 AND 15). SN 77-099,052. PUB. 7-31-2007. FILED 2-5-2007.

3,311,862. **FIRE BIRD (BLOCK FORM)**, MIDWEST OIL SUPPLY INC., MULTIPLE CLASS, (INT. CLS. 4 AND 35), (U.S. CLS. 1, 6, 15, 100, 101 AND 102). SN 78-759,622. PUB. 2-13-2007. FILED 11-22-2005.

3,312,070. **AUTHENTIC HENDRIX AND DESIGN**, EXPERIENCE HENDRIX, L.L.C., (U.S. CLS. 1, 6 AND 15). SN 78-866,266. PUB. 7-31-2007. FILED 4-20-2006.

3,312,305. **MOTOR HEAD (BLOCK FORM)**, DCM INDUSTRIES INC., (U.S. CLS. 1, 6 AND 15). SN 78-905,194. PUB. 7-31-2007. FILED 6-9-2006.

3,312,632. **FIVESTAR AND DESIGN**, NEWCOMB OIL CO. LLC, MULTIPLE CLASS, (INT. CLS. 4 AND 35), (U.S. CLS. 1, 6, 15, 100, 101 AND 102). SN 78-963,474. PUB. 3-20-2007. FILED 8-30-2006.

3,312,712 (*See Class 1 for this trademark*).

3,312,783 (*See Class 3 for this trademark*).

CLASS 5—PHARMACEUTICALS

3,310,188 (*See Class 1 for this trademark*).

3,310,189. **FIBER 7**, MARLYN NUTRACEUTICALS, INC., DBA NATURALLY VITAMINS, (U.S. CLS. 6, 18, 44, 46, 51 AND 52). SN 75-363,878. PUB. 7-31-2007. FILED 9-26-1997.

3,310,212. **ULTIMATE MATRIX (BLOCK FORM)**, NUTRIBIOTIC, INC., (U.S. CLS. 6, 18, 44, 46, 51 AND 52). SN 76-217,906. PUB. 7-31-2007. FILED 3-2-2001.

3,310,223. **DNA AND DESIGN**, DNA PHARMACEUTICALS, INC., (U.S. CLS. 6, 18, 44, 46, 51 AND 52). SN 76-433,795. PUB. 7-31-2007. FILED 7-24-2002.

3,310,383. **MISCELLANEOUS DESIGN**, AKSHAY WELLNESS GROUP, INC., THE, (U.S. CLS. 6, 18, 44, 46, 51 AND 52). SN 76-669,388. PUB. 7-31-2007. FILED 11-22-2006.

3,310,402. **MORINGAN (BLOCK FORM)**, ORCAS INTERNATIONAL, INC., (U.S. CLS. 6, 18, 44, 46, 51 AND 52). SN 76-670,774. PUB. 7-31-2007. FILED 12-26-2006.

3,310,405. **MURAGAN (BLOCK FORM)**, ORCAS INTERNATIONAL, INC., (U.S. CLS. 6, 18, 44, 46, 51 AND 52). SN 76-670,863. PUB. 7-31-2007. FILED 12-28-2006.

3,310,416. **NEUROCHONDRIA (BLOCK FORM)**, THORNE RESEARCH, INC., (U.S. CLS. 6, 18, 44, 46, 51 AND 52). SN 76-672,209. PUB. 7-31-2007. FILED 2-2-2007.

3,310,423. **AMLAMAX (BLOCK FORM)**, ORCAS INTERNATIONAL, INC., (U.S. CLS. 6, 18, 44, 46, 51 AND 52). SN 76-673,488. PUB. 7-31-2007. FILED 3-2-2007.

3,310,457. **DERMAVIO (BLOCK FORM)**, AGELESS RESEARCH LABS, (U.S. CLS. 6, 18, 44, 46, 51 AND 52). SN 77-005,310. PUB. 5-8-2007. FILED 9-22-2006.

3,310,468. **INTEGRASEL (STYLIZED)**, RALCO NUTRITION, INC., (U.S. CLS. 6, 18, 44, 46, 51 AND 52). SN 77-008,386. PUB. 6-26-2007. FILED 9-27-2006.

3,310,471. **THE HISTAMINE BLOCKER AND DESIGN**, JOHNSON & JOHNSON, (U.S. CLS. 6, 18, 44, 46, 51 AND 52). SN 77-008,696. PUB. 7-31-2007. FILED 9-27-2006.

3,310,478. **SKILL-IT (BLOCK FORM)**, BIO-DEX LABORATORIES, (U.S. CLS. 6, 18, 44, 46, 51 AND 52). SN 77-010,573. PUB. 7-31-2007. FILED 9-29-2006.

3,310,508. **HYDROCID (BLOCK FORM)**, HYDROX CHEMI-

- CAL COMPANY, INC., (U.S. CLS. 6, 18, 44, 46, 51 AND 52). SN 77-014,806. PUB. 7-31-2007. FILED 3-12-2007.
- 3,310,557. **EZ PAC (BLOCK FORM)**, SHEPPARD, GEORGE, (U.S. CLS. 6, 18, 44, 46, 51 AND 52). SN 77-022,118. PUB. 7-31-2007. FILED 10-16-2006.
- 3,310,573. **ALLI (BLOCK FORM)**, SMITHKLINE BEECHAM CORPORATION, (U.S. CLS. 6, 18, 44, 46, 51 AND 52). SN 77-024,842. PUB. 7-31-2007. FILED 10-19-2006.
- 3,310,609. **INNERCAP (BLOCK FORM)**, INNERCAP TECHNOLOGIES, INC., (U.S. CLS. 6, 18, 44, 46, 51 AND 52). SN 77-031,424. PUB. 7-31-2007. FILED 10-27-2006.
- 3,310,710. **FOALPROOF (BLOCK FORM)**, FOALPROOF EQUINE, (U.S. CLS. 6, 18, 44, 46, 51 AND 52). SN 77-049,042. PUB. 7-31-2007. FILED 11-21-2006.
- 3,310,712. **STAMINA-XL (BLOCK FORM)**, ULTRA NUTRITIONALS CORP, (U.S. CLS. 6, 18, 44, 46, 51 AND 52). SN 77-049,098. PUB. 7-31-2007. FILED 11-21-2006.
- 3,310,715. **MISCELLANEOUS DESIGN**, GENETIC TESTING INSTITUTE, INC., (U.S. CLS. 6, 18, 44, 46, 51 AND 52). SN 77-049,890. PUB. 7-31-2007. FILED 11-22-2006.
- 3,310,763 (*See Class 1 for this trademark*).
- 3,310,791. **HOLLYWOOD 15 DAY DETOX (BLOCK FORM)**, SUNSET HEALTH PRODUCTS, INC., (U.S. CLS. 6, 18, 44, 46, 51 AND 52). SN 77-060,635. PUB. 7-31-2007. FILED 12-8-2006.
- 3,310,888. **BIODOPH-7 PLUS (BLOCK FORM)**, BIOTICS RESEARCH CORPORATION, (U.S. CLS. 6, 18, 44, 46, 51 AND 52). SN 77-068,468. PUB. 7-31-2007. FILED 12-20-2006.
- 3,310,909. **SHOCK SPORTS (BLOCK FORM)**, MD DRINKS, INC., MULTIPLE CLASS, (INT. CLS. 5 AND 32), (U.S. CLS. 6, 18, 44, 45, 46, 48, 51 AND 52). SN 77-069,198. PUB. 7-31-2007. FILED 12-21-2006.
- 3,310,939. **VMV HYPOALLERGENICS (BLOCK FORM)**, VER-ALLO-ROWELL, DRA. VERMÉN, (U.S. CLS. 6, 18, 44, 46, 51 AND 52). SN 77-070,638. PUB. 7-31-2007. FILED 12-22-2006.
- 3,310,971. **WHITEWOLF'S BOO BOO GOO (BLOCK FORM)**, COBLENTZ, ALICE A., (U.S. CLS. 6, 18, 44, 46, 51 AND 52). SN 77-071,557. PUB. 7-31-2007. FILED 12-27-2006.
- 3,311,066. **CHAN LUN MING AND DESIGN**, DUNG HUYNH, (U.S. CLS. 6, 18, 44, 46, 51 AND 52). SN 77-073,658. PUB. 7-31-2007. FILED 12-29-2006.
- 3,311,067. **SUPERIN AND DESIGN**, DUNG HUYNH, (U.S. CLS. 6, 18, 44, 46, 51 AND 52). SN 77-073,673. PUB. 7-31-2007. FILED 12-29-2006.
- 3,311,081. **WELL-HORSE (BLOCK FORM)**, FERNANDEZ, JORGE, J, (U.S. CLS. 6, 18, 44, 46, 51 AND 52). SN 77-073,972. PUB. 7-31-2007. FILED 12-31-2006.
- 3,311,192. **SLEEP WELL. LOSE WELL. (BLOCK FORM)**, CYTODYNE LLC, (U.S. CLS. 6, 18, 44, 46, 51 AND 52). SN 77-082,453. PUB. 7-3-2007. FILED 1-12-2007.
- 3,311,197. **HERBAL ROOTS AND DESIGN**, TAYLOR, SARA, (U.S. CLS. 6, 18, 44, 46, 51 AND 52). SN 77-083,013. PUB. 7-10-2007. FILED 1-15-2007.
- 3,311,264. **RHINO GUMMY BEAR VITAMINS (BLOCK FORM)**, NUTRITION NOW, INC., (U.S. CLS. 6, 18, 44, 46, 51 AND 52). SN 77-088,289. PUB. 7-31-2007. FILED 1-22-2007.
- 3,311,307. **GBG ALOEGEL (BLOCK FORM)**, RIDDELL & ASSOCIATES, INC., (U.S. CLS. 6, 18, 44, 46, 51 AND 52). SN 77-092,231. PUB. 7-10-2007. FILED 1-26-2007.
- 3,311,328. **LTI ULTRA-PREMIUM L-TRYPTOPHAN (STYLIZED)**, COMPOUND SOLUTIONS, INC., (U.S. CLS. 6, 18, 44, 46, 51 AND 52). SN 77-094,088. PUB. 7-31-2007. FILED 1-29-2007.
- 3,311,361. **ATTENDS BARIATRIC BRIEFS (BLOCK FORM)**, PAPERPAK PRODUCTS, INC., (U.S. CLS. 6, 18, 44, 46, 51 AND 52). SN 77-096,446. PUB. 7-31-2007. FILED 2-1-2007.
- 3,311,362. **ATTENDS LIGHT INSERT PADS (BLOCK FORM)**, PAPERPAK PRODUCTS, INC., (U.S. CLS. 6, 18, 44, 46, 51 AND 52). SN 77-096,505. PUB. 7-31-2007. FILED 2-1-2007.
- 3,311,376. **M AND DESIGN**, MARKS, DAVID, MULTIPLE CLASS, (INT. CLS. 5 AND 35), (U.S. CLS. 6, 18, 44, 46, 51, 52, 100, 101 AND 102). SN 77-097,524. PUB. 7-31-2007. FILED 2-2-2007.
- 3,311,389. **BEYOND HEALTH (BLOCK FORM)**, RAYMOND FRANCIS FRIESECKE, (U.S. CLS. 6, 18, 44, 46, 51 AND 52). SN 77-097,889. PUB. 7-31-2007. FILED 2-2-2007.
- 3,311,412 (*See Class 3 for this trademark*).
- 3,311,431. **LYMPHEBAND (BLOCK FORM)**, BIAFORM CORPORATION, MULTIPLE CLASS, (INT. CLS. 5 AND 10), (U.S. CLS. 6, 18, 26, 39, 44, 46, 51 AND 52). SN 77-099,155. PUB. 7-31-2007. FILED 2-5-2007.
- 3,311,474. **ATTENDS INSERT PADS (BLOCK FORM)**, PAPERPAK PRODUCTS, INC., (U.S. CLS. 6, 18, 44, 46, 51 AND 52). SN 77-101,610. PUB. 7-31-2007. FILED 2-7-2007.
- 3,311,489. **MUSCLE MILK N' OATS (BLOCK FORM)**, CYTOSPORT, INC., MULTIPLE CLASS, (INT. CLS. 5 AND 30), (U.S. CLS. 6, 18, 44, 46, 51 AND 52). SN 77-103,685. PUB. 7-31-2007. FILED 2-9-2007.
- 3,311,490. **MUSCLE MILK PUDDING (BLOCK FORM)**, CYTOSPORT, INC., MULTIPLE CLASS, (INT. CLS. 5 AND 30), (U.S. CLS. 6, 18, 44, 46, 51 AND 52). SN 77-103,691. PUB. 7-31-2007. FILED 2-9-2007.
- 3,311,512. **FOOD DETECTIVE (BLOCK FORM)**, CAMBRIDGE NUTRITIONAL SCIENCES LTD., (U.S. CLS. 6, 18, 44, 46, 51 AND 52). SN 77-109,549. PUB. 7-31-2007. FILED 2-16-2007.
- 3,311,551. **PARADISE ESSENTIALS (BLOCK FORM)**, PARADISE HERBS, INC., (U.S. CLS. 6, 18, 44, 46, 51 AND 52). SN 77-117,753. PUB. 7-31-2007. FILED 2-27-2007.
- 3,311,589. **ALLROUND (BLOCK FORM)**, THE ARGEN CORPORATION, (U.S. CLS. 6, 18, 44, 46, 51 AND 52). SN 77-131,002. PUB. 7-31-2007. FILED 3-14-2007.
- 3,311,614. **FRONTIERS OF INNOVATION (BLOCK FORM)**, DENALI BIOTECHNOLOGIES, LLC, (U.S. CLS. 6, 18, 44, 46, 51 AND 52). SN 77-150,236. PUB. 7-31-2007. FILED 4-5-2007.
- 3,311,631 (*See Class 1 for this trademark*).
- 3,311,647. **BLEDNA**, BLEDNA, MULTIPLE CLASS, (INT. CLS. 5, 29 AND 30), (U.S. CLS. 6, 18, 44, 46, 51 AND 52). SN 78-319,597. PUB. 7-31-2007. FILED 10-28-2003.
- 3,311,664 (*See Class 3 for this trademark*).
- 3,311,678. **FORZE VIT FORTE (BLOCK FORM)**, FARMACIAS DE SIMILARES, S.A. DE C.V., (U.S. CLS. 6, 18, 44, 46, 51 AND 52). SN 78-546,981. PUB. 7-31-2007. FILED 1-13-2005.
- 3,311,720. **PRO COMPLEX (BLOCK FORM)**, OPTIMUM NUTRITION, INC., (U.S. CLS. 6, 18, 44, 46, 51 AND 52). SN 78-636,934. PUB. 7-31-2007. FILED 5-25-2005.
- 3,311,746. **POWER UP FORMULAS AND DESIGN**, PAPAZACHARIOU, ILIAS, MULTIPLE CLASS, (INT. CLS. 5 AND 29), (U.S. CLS. 6, 18, 44, 46, 51 AND 52). SN 78-661,579. PUB. 7-31-2007. FILED 6-30-2005.
- 3,311,747 (*See Class 1 for this trademark*).
- 3,311,750. **INTERCYTEX (BLOCK FORM)**, INTERCYTEX LIMITED, MULTIPLE CLASS, (INT. CLS. 5, 10, 42 AND 44), (U.S. CLS. 6, 18, 26, 39, 44, 46, 51, 52, 100 AND 101). SN 78-674,087. PUB. 7-31-2007. FILED 7-20-2005.
- 3,311,839 (*See Class 1 for this trademark*).
- 3,311,867. **TWINJECT (BLOCK FORM)**, VERUS PHARMACEUTICALS INC., (U.S. CLS. 6, 18, 44, 46, 51 AND 52). SN 78-764,430. PUB. 7-31-2007. FILED 12-1-2005.
- 3,311,899. **GENT-L-CLENS (BLOCK FORM)**, SCHERING-PLOUGH ANIMAL HEALTH CORPORATION, (U.S. CLS. 6, 18, 44, 46, 51 AND 52). SN 78-791,401. PUB. 7-31-2007. FILED 1-13-2006.
- 3,311,921. **MISCELLANEOUS DESIGN**, KRUGER PRODUCTS LIMITED, MULTIPLE CLASS, (INT. CLS. 5 AND 16), (U.S. CLS. 2, 5, 6, 18, 22, 23, 29, 37, 38, 44, 46, 50, 51 AND 52). SN 78-803,137. PUB. 7-31-2007. FILED 1-31-2006.
- 3,312,051. **CHANNEL FLOW (BLOCK FORM)**, GOODE, INC., (U.S. CLS. 6, 18, 44, 46, 51 AND 52). SN 78-861,327. PUB. 7-31-2007. FILED 4-13-2006.
- 3,312,071. **AUTHENTIC HENDRIX AND DESIGN**, EXPERIENCE HENDRIX, L.L.C., (U.S. CLS. 6, 18, 44, 46, 51 AND 52). SN 78-866,268. PUB. 7-31-2007. FILED 4-20-2006.
- 3,312,132. **PROPELLER (BLOCK FORM)**, PROF. DR. HABIL THOMAS GEISHAUSER, (U.S. CLS. 6, 18, 44, 46, 51 AND 52). SN 78-876,259. PUB. 7-31-2007. FILED 5-4-2006.
- 3,312,137. **VISALUS SCIENCES (BLOCK FORM)**, VISALUS HOLDINGS LLC, MULTIPLE CLASS, (INT. CLS. 5 AND 35), (U.S. CLS. 6, 18, 44, 46, 51, 52, 100, 101 AND 102). SN 78-876,860. PUB. 7-31-2007. FILED 5-4-2006.
- 3,312,168 (*See Class 1 for this trademark*).
- 3,312,170. **STRESS-X (BLOCK FORM)**, TRACE MINERALS RESEARCH, L.C., (U.S. CLS. 6, 18, 44, 46, 51 AND 52). SN 78-881,404. PUB. 7-31-2007. FILED 5-11-2006.
- 3,312,186. **SKOOT (BLOCK FORM)**, RUSSELL ALISTAIR

- MCLEAN, (U.S. CLS. 6, 18, 44, 46, 51 AND 52). SN 78-883,460. PUB. 7-31-2007. FILED 5-15-2006.
3,312,199 (*See Class 3 for this trademark*).
- 3,312,200. **ISCOPEP (BLOCK FORM)**. ISCOTEC AB, (U.S. CLS. 6, 18, 44, 46, 51 AND 52). SN 78-885,503. PUB. 7-31-2007. FILED 5-17-2006.
- 3,312,201 (*See Class 1 for this trademark*).
- 3,312,203. **LACERUM (BLOCK FORM)**. BELUMED X LLC, (U.S. CLS. 6, 18, 44, 46, 51 AND 52). SN 78-885,641. PUB. 7-31-2007. FILED 5-17-2006.
- 3,312,204. **REM X (BLOCK FORM)**. BELUMED X LLC, (U.S. CLS. 6, 18, 44, 46, 51 AND 52). SN 78-885,665. PUB. 7-31-2007. FILED 5-17-2006.
- 3,312,236. **GLUCOTEL (BLOCK FORM)**. SAFE-COM GMBH & CO. KG, MULTIPLE CLASS, (INT. CLS. 5, 9, 10 AND 44), (U.S. CLS. 6, 18, 21, 23, 26, 36, 38, 39, 44, 46, 51, 52, 100 AND 101). SN 78-891,514. PUB. 7-31-2007. FILED 5-24-2006.
- 3,312,246. **MISCELLANEOUS DESIGN**. ALCON, INC., (U.S. CLS. 6, 18, 44, 46, 51 AND 52). SN 78-892,997. PUB. 7-31-2007. FILED 5-25-2006.
- 3,312,263 (*See Class 3 for this trademark*).
- 3,312,310. **BURNAWAY AND DESIGN**. GEORGE TOWNSEND & CO., INC., (U.S. CLS. 6, 18, 44, 46, 51 AND 52). SN 78-906,135. PUB. 7-31-2007. FILED 6-12-2006.
- 3,312,320. **GASTRITE (STYLIZED)**. MALABAR PRODUCTOS NATURALES, L.L.C., (U.S. CLS. 6, 18, 44, 46, 51 AND 52). SN 78-906,962. PUB. 7-31-2007. FILED 6-13-2006.
- 3,312,361. **INDIGENE SMARTER MEDICINE BY DESIGN AND DESIGN**. INDIGENE PHARMACEUTICALS, INC., (U.S. CLS. 6, 18, 44, 46, 51 AND 52). SN 78-915,351. PUB. 7-31-2007. FILED 6-23-2006.
- 3,312,374. **HEALTHY OPTIONS (BLOCK FORM)**. WEIGHT LOSS DIRECT, LLC, (U.S. CLS. 6, 18, 44, 46, 51 AND 52). SN 78-918,384. PUB. 7-31-2007. FILED 6-28-2006.
- 3,312,461. **OXYFRESH (BLOCK FORM)**. OXYFRESH WORLDWIDE, INC., (U.S. CLS. 6, 18, 44, 46, 51 AND 52). SN 78-929,166. PUB. 12-19-2006. FILED 7-13-2006.
- 3,312,592. **MAXXIMA (BLOCK FORM)**. DR. KNOLL PRODUCTS, INC., (U.S. CLS. 6, 18, 44, 46, 51 AND 52). SN 78-957,538. PUB. 4-10-2007. FILED 8-22-2006.
- 3,312,654. **EQUINE MAX (BLOCK FORM)**. HUDSON LIVESTOCK SUPPLEMENTS, INC., (U.S. CLS. 6, 18, 44, 46, 51 AND 52). SN 78-966,948. PUB. 4-24-2007. FILED 9-5-2006.
- 3,312,680. **MATERNAL TRIM AND DESIGN**. SOVEREIGN LABORATORIES, INC., (U.S. CLS. 6, 18, 44, 46, 51 AND 52). SN 78-973,015. PUB. 7-31-2007. FILED 9-13-2006.
- 3,312,704. **SHENGZHENDI (BLOCK FORM)**. TONGLIANG HUANG, MULTIPLE CLASS, (INT. CLS. 5, 16, 41 AND 44), (U.S. CLS. 2, 5, 6, 18, 22, 23, 29, 37, 38, 44, 46, 50, 51, 52, 100, 101 AND 107). SN 79-009,974. PUB. 7-31-2007. FILED 2-24-2005.
- 3,312,708. **M POUX ENVIRONNEMENT AND DESIGN**. OLMIX, MULTIPLE CLASS, (INT. CLS. 5 AND 31), (U.S. CLS. 1, 6, 18, 44, 46, 51 AND 52). SN 79-011,454. PUB. 7-31-2007. FILED 5-31-2005.
- 3,312,755 (*See Class 3 for this trademark*).
- 3,312,759. **VIRTIVA (BLOCK FORM)**. INDENA S.P.A., (U.S. CLS. 6, 18, 44, 46, 51 AND 52). SN 79-023,267. PUB. 2-20-2007. FILED 12-1-2005.
- 3,312,819 (*See Class 3 for this trademark*).
- 3,312,837. **TRIPLION (STYLIZED)**. BIOFARMA, (U.S. CLS. 6, 18, 44, 46, 51 AND 52). SN 79-027,698. PUB. 7-31-2007. FILED 7-13-2006.
- 3,312,859. **A-SKIN (BLOCK FORM)**. A-SKIN HOLDING B.V., MULTIPLE CLASS, (INT. CLS. 5, 10, 42 AND 44), (U.S. CLS. 6, 18, 26, 39, 44, 46, 51, 52, 100 AND 101). SN 79-028,852. PUB. 7-31-2007. FILED 5-31-2006.
- 3,312,877 (*See Class 3 for this trademark*).
- 3,312,909. **SANDOKAN (STYLIZED)**. DEN DI DE NORA PAOLO, (U.S. CLS. 6, 18, 44, 46, 51 AND 52). SN 79-030,602. PUB. 7-31-2007. FILED 7-4-2006.
- 3,312,914. **PROSEPT (BLOCK FORM)**. ORO CLEAN CHEMIE AG, (U.S. CLS. 6, 18, 44, 46, 51 AND 52). SN 79-031,071. PUB. 7-31-2007. FILED 10-12-2006.
- 3,312,918. **STA KEROS (STYLIZED)**. DIAGNOSTICA STAGO, MULTIPLE CLASS, (INT. CLS. 5 AND 10), (U.S. CLS. 6, 18, 26, 39, 44, 46, 51 AND 52). SN 79-031,281. PUB. 7-31-2007. FILED 10-20-2006.
- 3,312,921. **TRACERNET (STYLIZED)**. GE HEALTHCARE LIMITED, MULTIPLE CLASS, (INT. CLS. 5, 10 AND 44), (U.S. CLS. 6, 18, 26, 39, 44, 46, 51, 52, 100 AND 101). SN 79-031,340. PUB. 7-31-2007. FILED 6-22-2006.
- 3,312,926. **VOLUME INTERACTIONS AND DESIGN**. BRACCO IMAGING S.P.A., MULTIPLE CLASS, (INT. CLS. 5, 9, 10, 41 AND 42), (U.S. CLS. 6, 18, 21, 23, 26, 36, 38, 39, 44, 46, 51, 52, 100, 101 AND 107). SN 79-031,752. PUB. 7-31-2007. FILED 5-31-2006.
- 3,312,949. **VONTARG (BLOCK FORM)**. NOVARTIS AG, (U.S. CLS. 6, 18, 44, 46, 51 AND 52). SN 79-033,987. PUB. 7-31-2007. FILED 1-8-2007.
- 3,312,951. **PASSONA (BLOCK FORM)**. BOEHRINGER INGELHEIM INTERNATIONAL GMBH, (U.S. CLS. 6, 18, 44, 46, 51 AND 52). SN 79-034,181. PUB. 7-31-2007. FILED 12-13-2006.
- 3,312,952 (*See Class 1 for this trademark*).
- 3,312,955. **MISCELLANEOUS DESIGN**. SHENYANG SBT TECHNOLOGY & DEVELOPMENT CO., LTD., MULTIPLE CLASS, (INT. CLS. 5, 10 AND 34), (U.S. CLS. 2, 6, 8, 9, 17, 18, 26, 39, 44, 46, 51 AND 52). SN 79-034,576. PUB. 7-31-2007. FILED 7-28-2006.
- 3,312,974. **CIRIGO (BLOCK FORM)**. NOVARTIS AG, (U.S. CLS. 6, 18, 44, 46, 51 AND 52). SN 79-036,547. PUB. 7-31-2007. FILED 2-21-2007.

CLASS 6—METAL GOODS

- 3,310,204 (*See Class 3 for this trademark*).
- 3,310,234 (*See Class 1 for this trademark*).
- 3,310,251. **THE MEDIC (STYLIZED)**. DARCOR LIMITED, MULTIPLE CLASS, (INT. CLS. 6 AND 20), (U.S. CLS. 2, 12, 13, 14, 22, 23, 25, 32 AND 50). SN 76-630,628. PUB. 7-24-2007. FILED 2-8-2005.
- 3,310,542. **FORD OFFICIAL LICENSED PRODUCT AND DESIGN**. FORD MOTOR COMPANY, MULTIPLE CLASS, (INT. CLS. 6, 8, 12, 14, 16, 18, 20, 21, 25, 27, 28 AND 34), (U.S. CLS. 1, 2, 3, 5, 8, 9, 12, 13, 14, 17, 19, 20, 21, 22, 23, 25, 27, 28, 29, 30, 31, 32, 33, 35, 37, 38, 39, 40, 41, 42, 44 AND 50). SN 77-019,773. PUB. 7-31-2007. FILED 10-12-2006.
- 3,310,584. **M MORRIS (STYLIZED)**. MORRIS PRODUCTS, INC., (U.S. CLS. 2, 12, 13, 14, 23, 25 AND 50). SN 77-026,756. PUB. 7-31-2007. FILED 10-23-2006.
- 3,310,744. **FLEXI (BLOCK FORM)**. IRECO, LLC, (U.S. CLS. 2, 12, 13, 14, 23, 25 AND 50). SN 77-053,794. PUB. 7-31-2007. FILED 11-30-2006.
- 3,310,806. **HERCULES STRAPPING (BLOCK FORM)**. FREEBURY, RUSSELL E., (U.S. CLS. 2, 12, 13, 14, 23, 25 AND 50). SN 77-061,904. PUB. 7-31-2007. FILED 12-11-2006.
- 3,310,845. **SABERDRIVE AND DESIGN**. MIDWEST FASTENER CORPORATION, (U.S. CLS. 2, 12, 13, 14, 23, 25 AND 50). SN 77-066,356. PUB. 7-31-2007. FILED 12-18-2006.
- 3,310,853. **ENVIRO-GRID (BLOCK FORM)**. ENVIRO-SAN CORPORATION, (U.S. CLS. 2, 12, 13, 14, 23, 25 AND 50). SN 77-067,485. PUB. 7-31-2007. FILED 12-19-2006.
- 3,310,912. **ERGANIC (BLOCK FORM)**. A.J. FISHER DESIGN, (U.S. CLS. 2, 12, 13, 14, 23, 25 AND 50). SN 77-069,407. PUB. 7-31-2007. FILED 12-21-2006.
- 3,310,914. **AJF AND DESIGN**. A.J. FISHER DESIGN, (U.S. CLS. 2, 12, 13, 14, 23, 25 AND 50). SN 77-069,441. PUB. 7-31-2007. FILED 12-21-2006.
- 3,311,153. **SOLIDSTAR (BLOCK FORM)**. CONCOR TOOL AND MACHINE, INC., (U.S. CLS. 2, 12, 13, 14, 23, 25 AND 50). SN 77-078,507. PUB. 7-31-2007. FILED 1-9-2007.
- 3,311,330. **10 (STYLIZED)**. EVERNHAM MOTORSPORTS, LLC, MULTIPLE CLASS, (INT. CLS. 6, 9, 16, 21, 25, 28 AND 41), (U.S. CLS. 2, 5, 12, 13, 14, 21, 22, 23, 25, 26, 29, 30, 33, 36, 37, 38, 39, 40, 50, 100, 101 AND 107). SN 77-094,320. PUB. 7-17-2007. FILED 1-30-2007.
- 3,311,341. **MISCELLANEOUS DESIGN**. BLACK SHADOW DEER STANDS, INC., (U.S. CLS. 2, 12, 13, 14, 23, 25 AND 50). SN 77-094,672. PUB. 7-31-2007. FILED 1-30-2007.
- 3,311,387. **T AND DESIGN**. TRINITY FORGE, INC., (U.S. CLS. 2, 12, 13, 14, 23, 25 AND 50). SN 77-097,784. PUB. 7-31-2007. FILED 2-2-2007.
- 3,311,443. **CHRIS MADDEN (BLOCK FORM)**. CHRIS MAD-

- DEN INC., MULTIPLE CLASS, (INT. CLS. 6, 16, 20, 21 AND 24), (U.S. CLS. 2, 5, 12, 13, 14, 22, 23, 25, 29, 30, 32, 33, 37, 38, 40, 42 AND 50). SN 77-099,608. PUB. 7-31-2007. FILED 2-5-2007.
- 3,311,534 (*See Class 1 for this trademark*).
- 3,311,580. **SHF (BLOCK FORM)**, HENG TONG CASTING CO. LTD., (U.S. CLS. 2, 12, 13, 14, 23, 25 AND 50). SN 77-127,752. PUB. 7-31-2007. FILED 3-10-2007.
- 3,311,704. **NATIONAL SPECIALITY ALLOYS (BLOCK FORM)**, NATIONAL SPECIALITY ALLOYS, INC., MULTIPLE CLASS, (INT. CLS. 6, 7 AND 14), (U.S. CLS. 2, 12, 13, 14, 19, 21, 23, 25, 27, 28, 31, 34, 35 AND 50). SN 78-593,722. PUB. 4-17-2007. FILED 3-23-2005.
- 3,311,705. **NATIONAL SPECIALITY ALLOYS QUALITY SERVICE FRIENDSHIP AND DESIGN**, NATIONAL SPECIALITY ALLOYS, INC., MULTIPLE CLASS, (INT. CLS. 6, 7 AND 14), (U.S. CLS. 2, 12, 13, 14, 19, 21, 23, 25, 27, 28, 31, 34, 35 AND 50). SN 78-594,443. PUB. 4-17-2007. FILED 3-24-2005.
- 3,311,706. **NATIONAL SPECIALITY ALLOYS AND DESIGN**, NATIONAL SPECIALITY ALLOYS, INC., MULTIPLE CLASS, (INT. CLS. 6, 7 AND 14), (U.S. CLS. 2, 12, 13, 14, 19, 21, 23, 25, 27, 28, 31, 34, 35 AND 50). SN 78-594,450. PUB. 4-17-2007. FILED 3-24-2005.
- 3,311,714. **XE (BLOCK FORM)**, GROUPE VERRIER NOVATECH INC./NOVATECH GLASS GROUP INC., (U.S. CLS. 2, 12, 13, 14, 23, 25 AND 50). SN 78-629,471. PUB. 7-31-2007. FILED 5-13-2005.
- 3,311,732. **BANCROFT (BLOCK FORM)**, KOHLER CO., MULTIPLE CLASS, (INT. CLS. 6, 11, 20 AND 21), (U.S. CLS. 2, 12, 13, 14, 21, 22, 23, 25, 29, 30, 31, 32, 33, 34, 40 AND 50). SN 78-652,343. PUB. 7-31-2007. FILED 6-16-2005.
- 3,311,787. **SPIN FIN (BLOCK FORM)**, PND INC., (U.S. CLS. 2, 12, 13, 14, 23, 25 AND 50). SN 78-704,679. PUB. 7-31-2007. FILED 8-31-2005.
- 3,311,788. **OPEN CELL (BLOCK FORM)**, PND INC., (U.S. CLS. 2, 12, 13, 14, 23, 25 AND 50). SN 78-704,687. PUB. 7-31-2007. FILED 8-31-2005.
- 3,311,789. **OPEN CELL SHEET PILE (BLOCK FORM)**, PND INC., (U.S. CLS. 2, 12, 13, 14, 23, 25 AND 50). SN 78-704,688. PUB. 7-31-2007. FILED 8-31-2005.
- 3,311,809. **PLANETRUDER (BLOCK FORM)**, VMI - AZ EXTRUSION GMBH, MULTIPLE CLASS, (INT. CLS. 6 AND 7), (U.S. CLS. 2, 12, 13, 14, 19, 21, 23, 25, 31, 34, 35 AND 50). SN 78-722,501. PUB. 7-31-2007. FILED 9-28-2005.
- 3,311,816. **PK-30 SYSTEM AND DESIGN**, GIOVANNITTI, INC., MULTIPLE CLASS, (INT. CLS. 6, 19, 40 AND 42), (U.S. CLS. 1, 2, 12, 13, 14, 23, 25, 33, 50, 100, 101, 103 AND 106). SN 78-726,866. PUB. 7-31-2007. FILED 10-5-2005.
- 3,311,864. **AK ARTE KUAN AND DESIGN**, D.D.M. CONSULTING & TRADING LTD., (U.S. CLS. 2, 12, 13, 14, 23, 25 AND 50). SN 78-763,172. PUB. 7-31-2007. FILED 11-30-2005.
- 3,311,872. **SE-KURE CONTROLS (BLOCK FORM)**, SE-KURE CONTROLS, INC., MULTIPLE CLASS, (INT. CLS. 6, 8, 9, 17 AND 20), (U.S. CLS. 1, 2, 5, 12, 13, 14, 21, 22, 23, 25, 26, 28, 32, 35, 36, 38, 44 AND 50). SN 78-767,671. PUB. 7-31-2007. FILED 12-6-2005.
- 3,311,940. **TC (STYLIZED)**, TAH CHUNG STEEL CORPORATION, (U.S. CLS. 2, 12, 13, 14, 23, 25 AND 50). SN 78-815,769. PUB. 7-31-2007. FILED 2-15-2006.
- 3,311,991. **STANDING GUARD SINCE 1889 (BLOCK FORM)**, KEYSTONE CONSOLIDATED INDUSTRIES, INC., (U.S. CLS. 2, 12, 13, 14, 23, 25 AND 50). SN 78-844,408. PUB. 7-31-2007. FILED 3-23-2006.
- 3,312,015. **KITCHEN & BEYOND (BLOCK FORM)**, HBL IMPORTS, CORP, MULTIPLE CLASS, (INT. CLS. 6 AND 16), (U.S. CLS. 2, 5, 12, 13, 14, 22, 23, 25, 29, 37, 38 AND 50). SN 78-851,762. PUB. 7-31-2007. FILED 3-31-2006.
- 3,312,163. **HTS STRUCTURES (BLOCK FORM)**, HTS STRUCTURES GROUP, LLC, (U.S. CLS. 2, 12, 13, 14, 23, 25 AND 50). SN 78-880,900. PUB. 7-31-2007. FILED 5-10-2006.
- 3,312,228. **MUD DAUBER AND DESIGN**, CRESCIT, L.P., (U.S. CLS. 2, 12, 13, 14, 23, 25 AND 50). SN 78-889,869. PUB. 7-31-2007. FILED 5-23-2006.
- 3,312,289. **SEASONGUARD (BLOCK FORM)**, SCREENLINE INNOVATIONS, INC., (U.S. CLS. 2, 12, 13, 14, 23, 25 AND 50). SN 78-902,671. PUB. 7-31-2007. FILED 6-7-2006.
- 3,312,290. **ENTRYAIR (BLOCK FORM)**, SCREENLINE INNOVATIONS, INC., (U.S. CLS. 2, 12, 13, 14, 23, 25 AND 50). SN 78-902,760. PUB. 7-31-2007. FILED 6-7-2006.
- 3,312,291. **RETRACTAWAY (BLOCK FORM)**, SCREENLINE INNOVATIONS, INC., (U.S. CLS. 2, 12, 13, 14, 23, 25 AND 50). SN 78-902,777. PUB. 7-31-2007. FILED 6-7-2006.
- 3,312,397. **RIVER ROCK (BLOCK FORM)**, FUSION HARDWARE GROUP, INC., MULTIPLE CLASS, (INT. CLS. 6, 11 AND 21), (U.S. CLS. 2, 12, 13, 14, 21, 23, 25, 29, 30, 31, 33, 34, 40 AND 50). SN 78-921,889. PUB. 7-31-2007. FILED 7-3-2006.
- 3,312,400. **TURNBERRY (BLOCK FORM)**, FUSION HARDWARE GROUP, INC., MULTIPLE CLASS, (INT. CLS. 6, 11 AND 21), (U.S. CLS. 2, 12, 13, 14, 21, 23, 25, 29, 30, 31, 33, 34, 40 AND 50). SN 78-922,018. PUB. 7-31-2007. FILED 7-3-2006.
- 3,312,404. **PERKO POWER (BLOCK FORM)**, SAMUEL HEATH & SONS PLC, MULTIPLE CLASS, (INT. CLS. 6 AND 7), (U.S. CLS. 2, 12, 13, 14, 19, 21, 23, 25, 31, 34, 35 AND 50). SN 78-922,613. PUB. 7-31-2007. FILED 7-5-2006.
- 3,312,441. **MISCELLANEOUS DESIGN**, DORMANT MANUFACTURING COMPANY, MULTIPLE CLASS, (INT. CLS. 6 AND 11), (U.S. CLS. 2, 12, 13, 14, 21, 23, 25, 31, 34 AND 50). SN 78-927,404. PUB. 7-31-2007. FILED 7-12-2006.
- 3,312,471. **INTERBRONZE H7 (BLOCK FORM)**, INTERMET METALS SERVICES, INC., (U.S. CLS. 2, 12, 13, 14, 23, 25 AND 50). SN 78-931,210. PUB. 7-31-2007. FILED 7-17-2006.
- 3,312,478. **BVP AND DESIGN**, MOTOVAN CORPORATION, MULTIPLE CLASS, (INT. CLS. 6, 7, 12 AND 22), (U.S. CLS. 1, 2, 7, 12, 13, 14, 19, 21, 22, 23, 25, 31, 34, 35, 42, 44 AND 50). SN 78-931,918. PUB. 7-31-2007. FILED 7-18-2006.
- 3,312,490. **HATCHGRIP (BLOCK FORM)**, ELLIS LADDER IMPROVEMENTS, INC., (U.S. CLS. 2, 12, 13, 14, 23, 25 AND 50). SN 78-933,795. PUB. 7-31-2007. FILED 7-20-2006.
- 3,312,536. **41 (STYLIZED)**, CHIP GANASSI RACING WITH FELIX SABATES, INC., MULTIPLE CLASS, (INT. CLS. 6, 12, 14, 16, 18, 20, 21, 24, 25, 26, 28 AND 41), (U.S. CLS. 1, 2, 3, 5, 12, 13, 14, 19, 21, 22, 23, 25, 27, 28, 29, 30, 31, 32, 33, 35, 37, 38, 39, 40, 41, 42, 44, 50, 100, 101 AND 107). SN 78-942,343. PUB. 7-31-2007. FILED 8-1-2006.
- 3,312,544. **TELSCO (BLOCK FORM)**, TELSCO INDUSTRIES, INC., (U.S. CLS. 2, 12, 13, 14, 23, 25 AND 50). SN 78-943,805. PUB. 7-31-2007. FILED 8-3-2006.
- 3,312,579. **GFX (BLOCK FORM)**, GULF FASTENER, INC., (U.S. CLS. 2, 12, 13, 14, 23, 25 AND 50). SN 78-952,519. PUB. 7-31-2007. FILED 8-15-2006.
- 3,312,605. **MHCG (BLOCK FORM)**, MITSUI MINING & SMELTING CO., LTD., (U.S. CLS. 2, 12, 13, 14, 23, 25 AND 50). SN 78-959,243. PUB. 7-31-2007. FILED 8-24-2006.
- 3,312,701 (*See Class 1 for this trademark*).
- 3,312,712 (*See Class 1 for this trademark*).
- 3,312,724. **SERITECH (BLOCK FORM)**, BO.M.I.S.A. BOTTOMI MINUTERIE S.P.A., MULTIPLE CLASS, (INT. CLS. 6, 26 AND 40), (U.S. CLS. 2, 12, 13, 14, 23, 25, 37, 39, 40, 42, 50, 100, 103 AND 106). SN 79-016,678. PUB. 7-31-2007. FILED 8-18-2005.
- 3,312,725. **B (STYLIZED)**, BO.M.I.S.A. BOTTOMI MINUTERIE S.P.A., MULTIPLE CLASS, (INT. CLS. 6, 26 AND 40), (U.S. CLS. 2, 12, 13, 14, 23, 25, 37, 39, 40, 42, 50, 100, 103 AND 106). SN 79-016,679. PUB. 7-31-2007. FILED 8-18-2005.
- 3,312,741. **AXOR (STYLIZED)**, HANSGROHE AG, MULTIPLE CLASS, (INT. CLS. 6, 9, 11, 20 AND 21), (U.S. CLS. 2, 12, 13, 14, 21, 22, 23, 25, 26, 29, 30, 31, 32, 33, 34, 36, 38, 40 AND 50). SN 79-020,500. PUB. 7-31-2007. FILED 4-29-2005.
- 3,312,756. **RIMATRIX5 DRIVING IT-PERFORMANCE (STYLIZED)**, RITTAL GMBH & CO. KG, MULTIPLE CLASS, (INT. CLS. 6, 9, 11, 19, 37 AND 42), (U.S. CLS. 1, 2, 12, 13, 14, 21, 23, 25, 26, 31, 33, 34, 36, 38, 50, 100, 101, 103 AND 106). SN 79-022,234. PUB. 7-31-2007. FILED 6-21-2005.
- 3,312,770. **M AND DESIGN**, SHANGHAI BENCHI METAL WARE COMPANY, (U.S. CLS. 2, 12, 13, 14, 23, 25 AND 50). SN 79-024,246. PUB. 7-31-2007. FILED 3-16-2006.
- 3,312,791. **KVARO (BLOCK FORM)**, FLÖTOTTO BRAND GMBH, MULTIPLE CLASS, (INT. CLS. 6, 11, 20, 21, 24 AND 27), (U.S. CLS. 2, 12, 13, 14, 19, 20, 21, 22, 23, 25, 29, 30, 31, 32, 33, 34, 37, 40, 42 AND 50). SN 79-025,810. PUB. 7-31-2007. FILED 11-29-2005.
- 3,312,809. **FARESIN AND DESIGN**, FARESIN S.P.A., MULTIPLE CLASS, (INT. CLS. 6, 7 AND 12), (U.S. CLS. 2, 12, 13, 14, 19, 21, 23, 25, 31, 34, 35, 44 AND 50). SN 79-026,801. PUB. 7-31-2007. FILED 5-16-2006.
- 3,312,826. **GROUPE SEB (BLOCK FORM)**, SEB S.A., MULTI-

- PLE CLASS, (INT. CLS. 6, 7, 8, 9, 10, 11, 16, 20, 21, 37 AND 41), (U.S. CLS. 2, 5, 12, 13, 14, 19, 21, 22, 23, 25, 26, 28, 29, 30, 31, 32, 33, 34, 35, 36, 37, 38, 39, 40, 44, 50, 100, 101, 103, 106 AND 107), SN 79-027,406. PUB. 7-31-2007. FILED 1-26-2006.
- 3,312,886. **MAXPURE (STYLIZED)**. ARMATURENFABRIK-APPARATEBAU-METALLGIEßEREI GMBH + CO. KG, MULTIPLE CLASS, (INT. CLS. 6, 9 AND 20), (U.S. CLS. 2, 12, 13, 14, 21, 22, 23, 25, 26, 32, 36, 38 AND 50), SN 79-029,817. PUB. 7-31-2007. FILED 9-7-2005.
- 3,312,889. **S4 AND DESIGN**. SIEGMUND, BERND, MULTIPLE CLASS, (INT. CLS. 6, 7 AND 8), (U.S. CLS. 2, 12, 13, 14, 19, 21, 23, 25, 28, 31, 34, 35, 44 AND 50), SN 79-029,966. PUB. 7-31-2007. FILED 9-2-2005.
- 3,312,897. **SOLUTIONS IN FABRICS (STYLIZED)**. ANDREAS KUFFERATH GMBH & CO. KG, MULTIPLE CLASS, (INT. CLS. 6, 7 AND 11), (U.S. CLS. 2, 12, 13, 14, 19, 21, 23, 25, 31, 34, 35 AND 50), SN 79-030,121. PUB. 7-31-2007. FILED 7-10-2006.
- 3,312,923. **WELSER PROFILE AND DESIGN**. WELSER PROFILE AG, MULTIPLE CLASS, (INT. CLS. 6 AND 42), (U.S. CLS. 2, 12, 13, 14, 23, 25, 50, 100 AND 101), SN 79-031,699. PUB. 7-31-2007. FILED 10-17-2006.
- 3,312,924. **WELSER PROFILE (STYLIZED)**. WELSER PROFILE AG, MULTIPLE CLASS, (INT. CLS. 6 AND 42), (U.S. CLS. 2, 12, 13, 14, 23, 25, 50, 100 AND 101), SN 79-031,700. PUB. 7-31-2007. FILED 10-16-2006.
- 3,312,932. **WELSER PROFILE AND DESIGN**. WELSER PROFILE AG, MULTIPLE CLASS, (INT. CLS. 6 AND 42), (U.S. CLS. 2, 12, 13, 14, 23, 25, 50, 100 AND 101), SN 79-032,349. PUB. 7-31-2007. FILED 10-16-2006.
- 3,312,960. **DUOMATIC PREMIUM (STYLIZED)**. HÄFELE GMBH & CO KG, MULTIPLE CLASS, (INT. CLS. 6 AND 20), (U.S. CLS. 2, 12, 13, 14, 22, 23, 25, 32 AND 50), SN 79-035,065. PUB. 7-31-2007. FILED 1-15-2007.

CLASS 7—MACHINERY

- 3,310,210. **ASEPT**. ASEPT INTERNATIONAL AB, MULTIPLE CLASS, (INT. CLS. 7 AND 21), (U.S. CLS. 2, 13, 19, 21, 23, 29, 30, 31, 33, 34, 35, 40 AND 50), SN 76-186,686. PUB. 7-31-2007. FILED 12-22-2000.
- 3,310,230. **BLUE ROBIN (BLOCK FORM)**. IAR SYSTEMS AB, MULTIPLE CLASS, (INT. CLS. 7, 9, 10, 11, 12, 14, 16, 28 AND 42), (U.S. CLS. 2, 5, 13, 19, 21, 22, 23, 26, 27, 28, 29, 31, 34, 35, 36, 37, 38, 39, 44, 50, 100 AND 101), SN 76-510,179. PUB. 7-31-2007. FILED 4-28-2003.
- 3,310,234 (*See Class 1 for this trademark*).
- 3,310,248 (*See Class 1 for this trademark*).
- 3,310,318. **58132 (BLOCK FORM)**. STANDARD MOTOR PRODUCTS, INC., (U.S. CLS. 13, 19, 21, 23, 31, 34 AND 35), SN 76-661,457. PUB. 7-31-2007. FILED 6-12-2006.
- 3,310,319. **58950 (BLOCK FORM)**. STANDARD MOTOR PRODUCTS, INC., (U.S. CLS. 13, 19, 21, 23, 31, 34 AND 35), SN 76-661,460. PUB. 7-31-2007. FILED 6-12-2006.
- 3,310,320. **58146 (BLOCK FORM)**. STANDARD MOTOR PRODUCTS, INC., (U.S. CLS. 13, 19, 21, 23, 31, 34 AND 35), SN 76-661,461. PUB. 7-31-2007. FILED 6-12-2006.
- 3,310,321. **58120 (BLOCK FORM)**. STANDARD MOTOR PRODUCTS, INC., (U.S. CLS. 13, 19, 21, 23, 31, 34 AND 35), SN 76-661,462. PUB. 7-31-2007. FILED 6-12-2006.
- 3,310,370. **R AND DESIGN**. RUTHMAN PUMP & ENGINEERING, INC., (U.S. CLS. 13, 19, 21, 23, 31, 34 AND 35), SN 76-667,862. PUB. 7-31-2007. FILED 10-23-2006.
- 3,310,410. **VACALL (BLOCK FORM)**. ALAMO GROUP INC., (U.S. CLS. 13, 19, 21, 23, 31, 34 AND 35), SN 76-671,199. PUB. 7-31-2007. FILED 1-10-2007.
- 3,310,458. **EQUAPLY (BLOCK FORM)**. ANH3.COMPANY, (U.S. CLS. 13, 19, 21, 23, 31, 34 AND 35), SN 77-005,619. PUB. 7-31-2007. FILED 9-22-2006.
- 3,310,483. **BOURGAULT (BLOCK FORM)**. BOURGAULT INDUSTRIES LTD., (U.S. CLS. 13, 19, 21, 23, 31, 34 AND 35), SN 77-010,814. PUB. 7-31-2007. FILED 9-29-2006.
- 3,310,495. **PASIO (BLOCK FORM)**. SCHENCK ROTEC GMBH, MULTIPLE CLASS, (INT. CLS. 7 AND 37), (U.S. CLS. 13, 19, 21, 23, 31, 34, 35, 100, 103 AND 106), SN 77-012,485. PUB. 7-31-2007. FILED 10-3-2006.
- 3,310,630. **DURATRANS XD (BLOCK FORM)**. BELANGER, INC., (U.S. CLS. 13, 19, 21, 23, 31, 34 AND 35), SN 77-036,365. PUB. 7-31-2007. FILED 11-3-2006.
- 3,310,705. **BLOCK BEAR (BLOCK FORM)**. WORLD DIAMOND SOURCE, INC., (U.S. CLS. 13, 19, 21, 23, 31, 34 AND 35), SN 77-048,594. PUB. 7-31-2007. FILED 11-21-2006.
- 3,310,707. **CARNIVORE (BLOCK FORM)**. WORLD DIAMOND SOURCE, INC., (U.S. CLS. 13, 19, 21, 23, 31, 34 AND 35), SN 77-048,765. PUB. 7-31-2007. FILED 11-21-2006.
- 3,310,708. **JAWS (BLOCK FORM)**. WORLD DIAMOND SOURCE, INC., (U.S. CLS. 13, 19, 21, 23, 31, 34 AND 35), SN 77-048,987. PUB. 7-31-2007. FILED 11-21-2006.
- 3,310,769. **TOOLMATIC (BLOCK FORM)**. ILLINOIS TOOL WORKS INC., (U.S. CLS. 13, 19, 21, 23, 31, 34 AND 35), SN 77-057,051. PUB. 7-31-2007. FILED 12-5-2006.
- 3,310,832. **SEED VAC BULK SEED CONVEYER AND DESIGN**. CHRISTIANSON SYSTEMS, INC., (U.S. CLS. 13, 19, 21, 23, 31, 34 AND 35), SN 77-065,075. PUB. 7-31-2007. FILED 12-15-2006.
- 3,310,841. **TOP DRIVE (BLOCK FORM)**. FENNER (INDIA) LIMITED, MULTIPLE CLASS, (INT. CLS. 7 AND 12), (U.S. CLS. 13, 19, 21, 23, 31, 34, 35 AND 44), SN 77-066,145. PUB. 7-31-2007. FILED 12-18-2006.
- 3,310,991. **MR TECHNOLOGY (BLOCK FORM)**. INJEN TECHNOLOGY, (U.S. CLS. 13, 19, 21, 23, 31, 34 AND 35), SN 77-072,103. PUB. 7-31-2007. FILED 12-27-2006.
- 3,311,022. **AIR BOSS (STYLIZED)**. AIRBOSS AIR TOOL CO., LTD., (U.S. CLS. 13, 19, 21, 23, 31, 34 AND 35), SN 77-072,588. PUB. 7-31-2007. FILED 12-28-2006.
- 3,311,023. **C.U.B.E. (BLOCK FORM)**. CART-AWAY CONCRETE SYSTEMS, INC., MULTIPLE CLASS, (INT. CLS. 7 AND 12), (U.S. CLS. 13, 19, 21, 23, 31, 34, 35 AND 44), SN 77-072,603. PUB. 7-31-2007. FILED 12-28-2006.
- 3,311,090. **XTENDOR (BLOCK FORM)**. WINTER EQUIPMENT COMPANY, INC., (U.S. CLS. 13, 19, 21, 23, 31, 34 AND 35), SN 77-074,171. PUB. 7-31-2007. FILED 1-2-2007.
- 3,311,108. **ULTRALIFT (BLOCK FORM)**. CHINA MANUFACTURING & BROKERAGE, INC., (U.S. CLS. 13, 19, 21, 23, 31, 34 AND 35), SN 77-074,764. PUB. 7-31-2007. FILED 1-3-2007.
- 3,311,109. **ULTRAPACK (BLOCK FORM)**. CHINA MANUFACTURING & BROKERAGE, INC., (U.S. CLS. 13, 19, 21, 23, 31, 34 AND 35), SN 77-074,776. PUB. 7-31-2007. FILED 1-3-2007.
- 3,311,149. **CART-AWAY (BLOCK FORM)**. CART-AWAY CONCRETE SYSTEMS, INC., MULTIPLE CLASS, (INT. CLS. 7 AND 12), (U.S. CLS. 13, 19, 21, 23, 31, 34, 35 AND 44), SN 77-077,348. PUB. 7-31-2007. FILED 1-5-2007.
- 3,311,265. **TEXROPE (BLOCK FORM)**. GATES S.A.S., (U.S. CLS. 13, 19, 21, 23, 31, 34 AND 35), SN 77-088,320. PUB. 7-31-2007. FILED 1-22-2007.
- 3,311,548. **I-DOS (BLOCK FORM)**. BSH BOSCH UND SIEMENS HAUSGERÄTE GMBH, (U.S. CLS. 13, 19, 21, 23, 31, 34 AND 35), SN 77-117,281. PUB. 7-31-2007. FILED 2-27-2007.
- 3,311,564. **AIRBLADE (BLOCK FORM)**. DYSON LIMITED, MULTIPLE CLASS, (INT. CLS. 7 AND 11), (U.S. CLS. 13, 19, 21, 23, 31, 34 AND 35), SN 77-124,176. PUB. 7-31-2007. FILED 3-7-2007.
- 3,311,641 (*See Class 1 for this trademark*).
- 3,311,645. **AQUAMASTER**. NIGRELLI SYSTEMS, INC., MULTIPLE CLASS, (INT. CLS. 7, 11 AND 35), (U.S. CLS. 13, 19, 21, 23, 31, 34, 35, 100, 101 AND 102), SN 78-309,815. PUB. 7-31-2007. FILED 10-6-2003.
- 3,311,704 (*See Class 6 for this trademark*).
- 3,311,705 (*See Class 6 for this trademark*).
- 3,311,706 (*See Class 6 for this trademark*).
- 3,311,759. **DELIVERING INNOVATION (BLOCK FORM)**. LITENS AUTOMOTIVE PARTNERSHIP, MULTIPLE CLASS, (INT. CLS. 7, 9, 12, 40 AND 42), (U.S. CLS. 13, 19, 21, 23, 26, 31, 34, 35, 36, 38, 44, 100, 101, 103 AND 106), SN 78-685,718. PUB. 7-31-2007. FILED 8-4-2005.
- 3,311,798. **PATRIOT LIFT (BLOCK FORM)**. PATRIOT LIFT CO., LTD., (U.S. CLS. 13, 19, 21, 23, 31, 34 AND 35), SN 78-712,745. PUB. 7-31-2007. FILED 9-14-2005.
- 3,311,809 (*See Class 6 for this trademark*).
- 3,311,815. **ATX (BLOCK FORM)**. ETEL S.A., (U.S. CLS. 13, 19, 21, 23, 31, 34 AND 35), SN 78-726,636. PUB. 7-31-2007. FILED 10-5-2005.
- 3,311,830. **FLASH-CLEANING (BLOCK FORM)**. S-E-S KA-

- BUSHIKI KAISHA, TA S-E-S CO., LTD., (U.S. CLS. 13, 19, 21, 23, 31, 34 AND 35). SN 78-734,887. PUB. 7-31-2007. FILED 10-17-2005.
- 3,311,860. **SPX SMITHS AND DESIGN**. SPX CORPORATION, (U.S. CLS. 13, 19, 21, 23, 31, 34 AND 35). SN 78-756,534. PUB. 7-31-2007. FILED 11-17-2005.
- 3,311,879. **HORIZON (BLOCK FORM)**. AUGHEY PLANT INTERNATIONAL LIMITED, (U.S. CLS. 13, 19, 21, 23, 31, 34 AND 35). SN 78-776,350. PUB. 7-31-2007. FILED 12-19-2005.
- 3,311,904. **PAC AND DESIGN**. PETERSON AMERICAN CORPORATION, (U.S. CLS. 13, 19, 21, 23, 31, 34 AND 35). SN 78-793,824. PUB. 7-31-2007. FILED 1-18-2006.
- 3,312,115. **EASYCUTTER (BLOCK FORM)**. SEOUL LASER DIEBOARD SYSTEM CO., LTD., (U.S. CLS. 13, 19, 21, 23, 31, 34 AND 35). SN 78-874,631. PUB. 7-31-2007. FILED 5-2-2006.
- 3,312,122. **KELDERMAN (BLOCK FORM)**. KELDERMAN MANUFACTURING, INC., MULTIPLE CLASS, (INT. CLS. 7 AND 12), (U.S. CLS. 13, 19, 21, 23, 31, 34, 35 AND 44). SN 78-875,252. PUB. 7-31-2007. FILED 5-3-2006.
- 3,312,161. **ENVIROBOOT (BLOCK FORM)**. ENVIRONMENTAL SAFETY SOLUTIONS, LLC, (U.S. CLS. 13, 19, 21, 23, 31, 34 AND 35). SN 78-880,748. PUB. 7-31-2007. FILED 5-10-2006.
- 3,312,181. **HI BULK (BLOCK FORM)**. HANSEN MANUFACTURING CORP., (U.S. CLS. 13, 19, 21, 23, 31, 34 AND 35). SN 78-882,844. PUB. 7-31-2007. FILED 5-12-2006.
- 3,312,255. **BUTTERWORTH (BLOCK FORM)**. BUTTERWORTH TECHNOLOGY, INC., MULTIPLE CLASS, (INT. CLS. 7, 17, 37 AND 42), (U.S. CLS. 1, 5, 12, 13, 19, 21, 23, 31, 34, 35, 50, 100, 101, 103 AND 106). SN 78-895,984. PUB. 7-31-2007. FILED 5-30-2006.
- 3,312,256. **MISCELLANEOUS DESIGN**. BUTTERWORTH TECHNOLOGY, INC., MULTIPLE CLASS, (INT. CLS. 7, 17, 37 AND 42), (U.S. CLS. 1, 5, 12, 13, 19, 21, 23, 31, 34, 35, 50, 100, 101, 103 AND 106). SN 78-896,261. PUB. 7-31-2007. FILED 5-30-2006.
- 3,312,279. **FY AND DESIGN**. MA'ANSHAN FANGYUAN SLEWING RING COMPANY LIMITED, (U.S. CLS. 13, 19, 21, 23, 31, 34 AND 35). SN 78-900,015. PUB. 7-31-2007. FILED 6-4-2006.
- 3,312,315. **ZEPPELIN (BLOCK FORM)**. J/B INDUSTRIES, INC., (U.S. CLS. 13, 19, 21, 23, 31, 34 AND 35). SN 78-906,740. PUB. 7-31-2007. FILED 6-13-2006.
- 3,312,316. **JB JUST BETTER AND DESIGN**. J/B INDUSTRIES, INC., MULTIPLE CLASS, (INT. CLS. 7, 9 AND 17), (U.S. CLS. 1, 5, 12, 13, 19, 21, 23, 26, 31, 34, 35, 36, 38 AND 50). SN 78-906,787. PUB. 7-31-2007. FILED 6-13-2006.
- 3,312,338. **ALL-PHASE (BLOCK FORM)**. WARREN PUMPS, LLC, (U.S. CLS. 13, 19, 21, 23, 31, 34 AND 35). SN 78-911,265. PUB. 7-31-2007. FILED 6-19-2006.
- 3,312,404 (*See Class 6 for this trademark*).
- 3,312,412. **DANBY DESIGNER (BLOCK FORM)**. DANBY PRODUCTS LIMITED, MULTIPLE CLASS, (INT. CLS. 7 AND 11), (U.S. CLS. 13, 19, 21, 23, 31, 34 AND 35). SN 78-923,240. PUB. 7-31-2007. FILED 7-6-2006.
- 3,312,413. **BAD BLADE (BLOCK FORM)**. KWIKTOOL USA, INC., (U.S. CLS. 13, 19, 21, 23, 31, 34 AND 35). SN 78-923,264. PUB. 7-31-2007. FILED 7-6-2006.
- 3,312,437. **NANOSTREAM (BLOCK FORM)**. TUNZE AQUARIENTECHNIK GMBH, MULTIPLE CLASS, (INT. CLS. 7 AND 11), (U.S. CLS. 13, 19, 21, 23, 31, 34 AND 35). SN 78-927,044. PUB. 7-31-2007. FILED 7-11-2006.
- 3,312,454. **VEBOT (BLOCK FORM)**. VISIONS EAST, INC., MULTIPLE CLASS, (INT. CLS. 7 AND 37), (U.S. CLS. 13, 19, 21, 23, 31, 34, 35, 100, 103 AND 106). SN 78-928,569. PUB. 7-31-2007. FILED 7-13-2006.
- 3,312,478 (*See Class 6 for this trademark*).
- 3,312,487. **GW AND DESIGN**. GRAHAM-WHITE MANUFACTURING CO., (U.S. CLS. 13, 19, 21, 23, 31, 34 AND 35). SN 78-933,145. PUB. 7-31-2007. FILED 7-19-2006.
- 3,312,497. **PARAGON LASER SYSTEMS AND DESIGN**. VEKTEK, INC., (U.S. CLS. 13, 19, 21, 23, 31, 34 AND 35). SN 78-935,498. PUB. 7-31-2007. FILED 7-23-2006.
- 3,312,549. **DENALI (BLOCK FORM)**. AMAZON TECHNOLOGIES, INC., (U.S. CLS. 13, 19, 21, 23, 31, 34 AND 35). SN 78-944,381. PUB. 7-31-2007. FILED 8-3-2006.
- 3,312,551. **EVERLOY (BLOCK FORM)**. KYORITSU GOKIN CO., LTD., (U.S. CLS. 13, 19, 21, 23, 31, 34 AND 35). SN 78-945,232. PUB. 7-31-2007. FILED 8-4-2006.
- 3,312,570. **ROBOTIC PRODUCTION TECHNOLOGY (BLOCK FORM)**. ROBOTIC PRODUCTION TECHNOLOGY, INC., MULTIPLE CLASS, (INT. CLS. 7 AND 9), (U.S. CLS. 13, 19, 21, 23, 26, 31, 34, 35, 36 AND 38). SN 78-950,569. PUB. 7-31-2007. FILED 8-11-2006.
- 3,312,644. **MAGNUM (BLOCK FORM)**. M-I L.L.C., (U.S. CLS. 13, 19, 21, 23, 31, 34 AND 35). SN 78-964,805. PUB. 4-17-2007. FILED 8-31-2006.
- 3,312,682. **ROTO-DIE (BLOCK FORM)**. GEM EQUITY CORP., (U.S. CLS. 13, 19, 21, 23, 31, 34 AND 35). SN 78-973,486. PUB. 7-31-2007. FILED 9-13-2006.
- 3,312,717 (*See Class 1 for this trademark*).
- 3,312,723. **SIEI AND DESIGN**. GEFRA S.P.A., MULTIPLE CLASS, (INT. CLS. 7, 9 AND 42), (U.S. CLS. 13, 19, 21, 23, 26, 31, 34, 35, 36, 38, 100 AND 101). SN 79-016,625. PUB. 7-31-2007. FILED 8-19-2005.
- 3,312,731. **BONFIGLIOLI AND DESIGN**. BONFIGLIOLI RIDUTTORI S.P.A., MULTIPLE CLASS, (INT. CLS. 7, 9 AND 12), (U.S. CLS. 13, 19, 21, 23, 26, 31, 34, 35, 36, 38 AND 44). SN 79-019,105. PUB. 7-31-2007. FILED 10-25-2005.
- 3,312,749. **SINUMERIK 808 (BLOCK FORM)**. SIEMENS AKTIENGESELLSCHAFT, MULTIPLE CLASS, (INT. CLS. 7, 9 AND 41), (U.S. CLS. 13, 19, 21, 23, 26, 31, 34, 35, 36, 38, 100, 101 AND 107). SN 79-021,402. PUB. 7-31-2007. FILED 11-11-2005.
- 3,312,777. **XP4 (BLOCK FORM)**. MAGOTTEAUX INTERNATIONAL, SOCIÉTÉ ANONYME, (U.S. CLS. 13, 19, 21, 23, 31, 34 AND 35). SN 79-024,611. PUB. 7-31-2007. FILED 4-20-2006.
- 3,312,789. **AQUACUBE (BLOCK FORM)**. EBM-PAPST ST. GEORGEN; GMBH & CO. KG, MULTIPLE CLASS, (INT. CLS. 7 AND 9), (U.S. CLS. 13, 19, 21, 23, 26, 31, 34, 35, 36 AND 38). SN 79-025,755. PUB. 7-31-2007. FILED 5-9-2006.
- 3,312,809 (*See Class 6 for this trademark*).
- 3,312,823. **OSMOOVE (BLOCK FORM)**. SOMFY SAS, MULTIPLE CLASS, (INT. CLS. 7 AND 9), (U.S. CLS. 13, 19, 21, 23, 26, 31, 34, 35, 36 AND 38). SN 79-027,327. PUB. 7-31-2007. FILED 6-21-2006.
- 3,312,825. **HABAFLW (BLOCK FORM)**. HABASIT AG, (U.S. CLS. 13, 19, 21, 23, 31, 34 AND 35). SN 79-027,334. PUB. 7-31-2007. FILED 6-1-2006.
- 3,312,826 (*See Class 6 for this trademark*).
- 3,312,839. **TURBOLOOP (BLOCK FORM)**. DANIELI & C. OFFICINE MECCANICHE SPA, MULTIPLE CLASS, (INT. CLS. 7, 9 AND 11), (U.S. CLS. 13, 19, 21, 23, 26, 31, 34, 35, 36 AND 38). SN 79-027,734. PUB. 7-31-2007. FILED 6-5-2006.
- 3,312,840. **FASTARC (BLOCK FORM)**. DANIELI & C. OFFICINE MECCANICHE SPA, MULTIPLE CLASS, (INT. CLS. 7, 9 AND 11), (U.S. CLS. 13, 19, 21, 23, 26, 31, 34, 35, 36 AND 38). SN 79-027,817. PUB. 7-31-2007. FILED 6-5-2006.
- 3,312,846. **LASERMAT (BLOCK FORM)**. MESSER CUTTING & WELDING GMBH, (U.S. CLS. 13, 19, 21, 23, 31, 34 AND 35). SN 79-028,172. PUB. 7-31-2007. FILED 7-13-2006.
- 3,312,883. **OUTLAST (BLOCK FORM)**. WEIR MINERALS NETHERLANDS B.V., (U.S. CLS. 13, 19, 21, 23, 31, 34 AND 35). SN 79-029,668. PUB. 7-31-2007. FILED 8-22-2006.
- 3,312,889 (*See Class 6 for this trademark*).
- 3,312,897 (*See Class 6 for this trademark*).
- 3,312,912. **NSCORE AND DESIGN**. NSCORE, INC., MULTIPLE CLASS, (INT. CLS. 7, 9, 37, 40 AND 42), (U.S. CLS. 13, 19, 21, 23, 26, 31, 34, 35, 36, 38, 100, 101, 103 AND 106). SN 79-030,794. PUB. 7-31-2007. FILED 2-28-2006.
- 3,312,916. **HT AND DESIGN**. NINGBO HAITAI MACHINERY; MANUFACTURE CO., LTD., (U.S. CLS. 13, 19, 21, 23, 31, 34 AND 35). SN 79-031,178. PUB. 7-31-2007. FILED 3-3-2006.
- 3,312,942. **AEB AND DESIGN**. A.E.B. S.R.L., MULTIPLE CLASS, (INT. CLS. 7, 9 AND 37), (U.S. CLS. 13, 19, 21, 23, 26, 31, 34, 35, 36, 38, 100, 103 AND 106). SN 79-033,106. PUB. 7-31-2007. FILED 9-15-2006.

CLASS 8—HAND TOOLS

- 3,310,206. **GREYS. HOUSE OF HARDY LIMITED, MULTIPLE CLASS**, (INT. CLS. 8, 18, 25 AND 28), (U.S. CLS. 1, 2, 3, 22, 23, 28, 38, 39, 41, 44 AND 50). SN 76-086,616. PUB. 7-31-2007. FILED 7-11-2000.
- 3,310,241. **COMBI (STYLIZED)**, COMBI CORPORATION, MULTIPLE CLASS, (INT. CLS. 8, 9, 10, 11 AND 21), (U.S. CLS. 2, 13, 21, 23, 26, 28, 29, 30, 31, 33, 34, 36, 38, 39, 40, 44 AND 50). SN 76-595,674. PUB. 12-19-2006. FILED 6-4-2004.
- 3,310,259. **SCRUBRUB (BLOCK FORM)**, KOTLITZKY, AMIRAM, (U.S. CLS. 23, 28 AND 44). SN 76-644,132. PUB. 7-31-2007. FILED 8-3-2005.
- 3,310,425. **ULTRA (BLOCK FORM)**, SYSTEMAX, INC., MULTIPLE CLASS, (INT. CLS. 8 AND 9), (U.S. CLS. 21, 23, 26, 28, 36, 38 AND 44). SN 76-978,267. PUB. 7-31-2007. FILED 7-30-2004.
- 3,310,542 (*See Class 6 for this trademark*).
- 3,310,675. **DIAMOND WALL AND DESIGN**, DIAMOND WALL CORPORATION, (U.S. CLS. 23, 28 AND 44). SN 77-043,427. PUB. 7-31-2007. FILED 11-14-2006.
- 3,311,323. **MIX-N-CLEAN (BLOCK FORM)**, WHITNEY INNOVATIONS, INC., (U.S. CLS. 23, 28 AND 44). SN 77-093,577. PUB. 7-31-2007. FILED 1-29-2007.
- 3,311,484. **KA-JINK IT (BLOCK FORM)**, BLUMENTHAL LANSING COMPANY, MULTIPLE CLASS, (INT. CLS. 8 AND 26), (U.S. CLS. 23, 28, 37, 39, 40, 42, 44 AND 50). SN 77-102,564. PUB. 7-31-2007. FILED 2-8-2007.
- 3,311,485. **KA-JINK (BLOCK FORM)**, BLUMENTHAL LANSING COMPANY, MULTIPLE CLASS, (INT. CLS. 8 AND 26), (U.S. CLS. 23, 28, 37, 39, 40, 42, 44 AND 50). SN 77-102,567. PUB. 7-31-2007. FILED 2-8-2007.
- 3,311,675. **MISCELLANEOUS DESIGN**, SOLO INCORPORATED, (U.S. CLS. 23, 28 AND 44). SN 78-534,564. PUB. 5-9-2006. FILED 12-17-2004.
- 3,311,696 (*See Class 3 for this trademark*).
- 3,311,702. **BABY BOA (BLOCK FORM)**, KAI U.S.A., LTD., DBA KERSHAW KNIVES, (U.S. CLS. 23, 28 AND 44). SN 78-590,753. PUB. 7-31-2007. FILED 3-18-2005.
- 3,311,872 (*See Class 6 for this trademark*).
- 3,312,033 (*See Class 3 for this trademark*).
- 3,312,107. **WEATHER WORKS (BLOCK FORM)**, TOTES ISOTONER CORPORATION, MULTIPLE CLASS, (INT. CLS. 8, 9 AND 11), (U.S. CLS. 13, 21, 23, 26, 28, 31, 34, 36, 38 AND 44). SN 78-873,393. PUB. 6-19-2007. FILED 5-1-2006.
- 3,312,237. **GHIDINI AND DESIGN**, GHIDINI CIPRIANO S.P.A., MULTIPLE CLASS, (INT. CLS. 8 AND 21), (U.S. CLS. 2, 13, 23, 28, 29, 30, 33, 40, 44 AND 50). SN 78-891,784. PUB. 7-31-2007. FILED 5-24-2006.
- 3,312,697. **COMFORT GRIP (BLOCK FORM)**, ARY, INC., (U.S. CLS. 23, 28 AND 44). SN 78-978,680. PUB. 1-23-2007. FILED 11-4-2005.
- 3,312,715. **INTENSA (BLOCK FORM)**, FISSLER GMBH, MULTIPLE CLASS, (INT. CLS. 8 AND 21), (U.S. CLS. 2, 13, 23, 28, 29, 30, 33, 40, 44 AND 50). SN 79-014,532. PUB. 7-31-2007. FILED 3-12-2005.
- 3,312,783 (*See Class 3 for this trademark*).
- 3,312,826 (*See Class 6 for this trademark*).
- 3,312,833. **BALANCE-BALL (BLOCK FORM)**, E.A. MATTES GMBH, MULTIPLE CLASS, (INT. CLS. 8, 9 AND 18), (U.S. CLS. 1, 2, 3, 21, 22, 23, 26, 28, 36, 38, 41 AND 44). SN 79-027,656. PUB. 7-31-2007. FILED 1-23-2006.
- 3,312,889 (*See Class 6 for this trademark*).
- 3,312,903. **TIRRIT (STYLIZED)**, YUYAO TIRRIT INDUSTRY & TRADE CO., LTD, (U.S. CLS. 23, 28 AND 44). SN 79-030,445. PUB. 7-31-2007. FILED 10-25-2006.
- 3,312,973. **SCISSOROO (BLOCK FORM)**, SCISSORMAN PTY LTD, (U.S. CLS. 23, 28 AND 44). SN 79-036,454. PUB. 7-31-2007. FILED 2-1-2007.
- 847,573. PUB. 7-31-2007. FILED 11-12-1999.
- 3,310,200. **DOT.COM AND DESIGN**, DOUGHTY, SHARON, MULTIPLE CLASS, (INT. CLS. 9, 16, 25 AND 41), (U.S. CLS. 2, 5, 21, 22, 23, 26, 29, 36, 37, 38, 39, 50, 100, 101 AND 107). SN 75-853,276. PUB. 7-31-2007. FILED 11-19-1999.
- 3,310,204 (*See Class 3 for this trademark*).
- 3,310,207. **NEXGENIP (STYLIZED)**, NEXGEN SOFTWARE (S.A.R.L.), (U.S. CLS. 21, 23, 26, 36 AND 38). SN 76-150,552. PUB. 7-31-2007. FILED 10-19-2000.
- 3,310,208. **AUTO-REF**, AUTO-REF INC., (U.S. CLS. 21, 23, 26, 36 AND 38). SN 76-179,436. PUB. 7-31-2007. FILED 12-13-2000.
- 3,310,221. **MISCELLANEOUS DESIGN**, FEDERATION INTERNATIONALE DE FOOTBALL ASSOCIATION (FIFA), MULTIPLE CLASS, (INT. CLS. 9, 16, 36 AND 38), (U.S. CLS. 2, 5, 21, 22, 23, 26, 29, 36, 37, 38, 50, 100, 101, 102 AND 104). SN 76-412,580. PUB. 12-2-2003. FILED 5-24-2002.
- 3,310,226 (*See Class 1 for this trademark*).
- 3,310,227. **CRSTL AND DESIGN**, CORPORATE RESPONSIBILITY SYSTEM TECHNOLOGIES LTD., MULTIPLE CLASS, (INT. CLS. 9 AND 45), (U.S. CLS. 21, 23, 26, 36, 38, 100 AND 101). SN 76-473,821. PUB. 2-20-2007. FILED 12-11-2002.
- 3,310,230 (*See Class 7 for this trademark*).
- 3,310,234 (*See Class 1 for this trademark*).
- 3,310,235. **CAMPRI (BLOCK FORM)**, THE TRADE MARK LICENSING COMPANY LIMITED, MULTIPLE CLASS, (INT. CLS. 9, 18 AND 25), (U.S. CLS. 1, 2, 3, 21, 22, 23, 26, 36, 38, 39 AND 41). SN 76-560,352. PUB. 4-17-2007. FILED 11-14-2003.
- 3,310,237. **PATBASE (BLOCK FORM)**, RWS GROUP PLC, AND MINESOFT LIMITED, MULTIPLE CLASS, (INT. CLS. 9, 16, 35, 38, 41 AND 42), (U.S. CLS. 2, 5, 21, 22, 23, 26, 29, 36, 37, 38, 50, 100, 101, 102, 104 AND 107). SN 76-567,532. PUB. 7-31-2007. FILED 12-17-2003.
- 3,310,240. **GECKODRIVE AND DESIGN**, GECKODRIVE, INC., (U.S. CLS. 21, 23, 26, 36 AND 38). SN 76-582,238. PUB. 1-11-2005. FILED 3-19-2004.
- 3,310,241 (*See Class 8 for this trademark*).
- 3,310,244. **ULTRA (BLOCK FORM)**, SYSTEMAX, INC., (U.S. CLS. 21, 23, 26, 36 AND 38). SN 76-604,917. PUB. 7-31-2007. FILED 7-30-2004.
- 3,310,247. **WINDISK (BLOCK FORM)**, ROBIN HOOD SOFTWARE LIMITED, MULTIPLE CLASS, (INT. CLS. 9, 16, 35, 38 AND 42), (U.S. CLS. 2, 5, 21, 22, 23, 26, 29, 36, 37, 38, 50, 100, 101, 102 AND 104). SN 76-619,710. PUB. 7-31-2007. FILED 11-5-2004.
- 3,310,249. **RUN-DMC AND DESIGN**, MCDANIELS, DARRYL, MULTIPLE CLASS, (INT. CLS. 9, 25 AND 41), (U.S. CLS. 21, 22, 23, 26, 36, 38, 39, 100, 101 AND 107). SN 76-624,074. PUB. 7-10-2007. FILED 12-13-2004.
- 3,310,255. **YASH RAJ (BLOCK FORM)**, YASH RAJ FILMS PVT. LTD., MULTIPLE CLASS, (INT. CLS. 9 AND 41), (U.S. CLS. 21, 23, 26, 36, 38, 100, 101 AND 107). SN 76-639,790. PUB. 7-31-2007. FILED 5-31-2005.
- 3,310,257. **UNIVERSIDAD DEL INGLÉS AND DESIGN**, TRIALTEA USA, LLC, MULTIPLE CLASS, (INT. CLS. 9 AND 16), (U.S. CLS. 2, 5, 21, 22, 23, 26, 29, 36, 37, 38 AND 50). SN 76-640,284. PUB. 7-31-2007. FILED 6-6-2005.
- 3,310,258. **MORE TO LIFE (BLOCK FORM)**, KAIROS FOUNDATION, THE, MULTIPLE CLASS, (INT. CLS. 9 AND 41), (U.S. CLS. 21, 23, 26, 36, 38, 100, 101 AND 107). SN 76-640,756. PUB. 7-31-2007. FILED 6-15-2005.
- 3,310,283. **TACTICAL VISION (BLOCK FORM)**, ANGIOLAZ, INC., (U.S. CLS. 21, 23, 26, 36 AND 38). SN 76-653,729. PUB. 7-31-2007. FILED 1-20-2006.
- 3,310,285. **STREAMCACHE (STYLIZED)**, GOBACKTV, INC., (U.S. CLS. 21, 23, 26, 36 AND 38). SN 76-655,191. PUB. 7-31-2007. FILED S.R. 2-15-2006; AM. P.R. 10-16-2006.
- 3,310,310. **ESAOTE AND DESIGN**, ESAOTE, S.P.A., MULTIPLE CLASS, (INT. CLS. 9, 10 AND 42), (U.S. CLS. 21, 23, 26, 36, 38, 39, 44, 100 AND 101). SN 76-659,778. PUB. 7-31-2007. FILED 5-9-2006.
- 3,310,312. **ACM (BLOCK FORM)**, SENSATA TECHNOLOGIES HOLLAND, B.V., (U.S. CLS. 21, 23, 26, 36 AND 38). SN 76-660,220. PUB. 7-31-2007. FILED 5-18-2006.
- 3,310,313. **PERSONAL CAPTIONING SYSTEMS AND DESIGN**, PERSONAL CAPTIONING SYSTEMS, INC., (U.S.

CLASS 9—ELECTRICAL AND SCIENTIFIC APPARATUS

- 3,310,199. **THE VISION COMPANY**, LIFE OPTICS HANDEL UND VERTRIEB GMBH, MULTIPLE CLASS, (INT. CLS. 9 AND 10), (U.S. CLS. 21, 23, 26, 36, 38, 39 AND 44). SN 75-

- CLS. 21, 23, 26, 36 AND 38). SN 76-660,565. PUB. 7-10-2007. FILED 5-25-2006.
- 3,310,324. **PEDONE (STYLIZED)**. SEVENTH RANK MANAGEMENT, L.L.C., (U.S. CLS. 21, 23, 26, 36 AND 38). SN 76-661,607. PUB. 7-31-2007. FILED 6-15-2006.
- 3,310,330. **INFORMED (BLOCK FORM)**. CREATIVE VENTURES, INC., (U.S. CLS. 21, 23, 26, 36 AND 38). SN 76-662,135. PUB. 7-31-2007. FILED 6-26-2006.
- 3,310,331. **MCHART AND DESIGN**. MACK SOFTWARE SOLUTIONS, INC., (U.S. CLS. 21, 23, 26, 36 AND 38). SN 76-662,316. PUB. 7-31-2007. FILED 6-29-2006.
- 3,310,333. **THERADEX (BLOCK FORM)**. THERADEX SYSTEMS, INC., (U.S. CLS. 21, 23, 26, 36 AND 38). SN 76-662,795. PUB. 4-10-2007. FILED 7-10-2006.
- 3,310,342. **ROCK N' ROE PROMO (BLOCK FORM)**. ROCK N' ROE PROMO, INC., (U.S. CLS. 21, 23, 26, 36 AND 38). SN 76-663,656. PUB. 7-31-2007. FILED 7-26-2006.
- 3,310,347. **OMNI TOUCHPOINT (BLOCK FORM)**. FUJITSU TRANSACTION SOLUTIONS INC., (U.S. CLS. 21, 23, 26, 36 AND 38). SN 76-664,195. PUB. 7-31-2007. FILED 8-4-2006.
- 3,310,351. **CLUBRUNNER AND DESIGN**. CLUBRUNNER, INC., (U.S. CLS. 21, 23, 26, 36 AND 38). SN 76-664,985. PUB. 7-31-2007. FILED 8-21-2006.
- 3,310,364. **IDOLPRO (STYLIZED)**. DTS KARAOKE, INC., (U.S. CLS. 21, 23, 26, 36 AND 38). SN 76-667,231. PUB. 7-31-2007. FILED 10-10-2006.
- 3,310,365. **NUTRIKIDS AND DESIGN**. MORIARTY, PAUL, (U.S. CLS. 21, 23, 26, 36 AND 38). SN 76-667,486. PUB. 7-31-2007. FILED 10-13-2006.
- 3,310,375. **GUARDIAN INSPECTION SYSTEM (BLOCK FORM)**. PANELS & CONTROLS CORP., (U.S. CLS. 21, 23, 26, 36 AND 38). SN 76-668,642. PUB. 7-31-2007. FILED 11-7-2006.
- 3,310,380. **CINÉ STARS INTERNATIONAL PRODUCTIONS AND DESIGN**. DIGITAL RECORDS INC, (U.S. CLS. 21, 23, 26, 36 AND 38). SN 76-668,969. PUB. 6-26-2007. FILED 11-13-2006.
- 3,310,389. **CABLEVISTA (BLOCK FORM)**. VECIMA NETWORKS INC., (U.S. CLS. 21, 23, 26, 36 AND 38). SN 76-670,242. PUB. 7-31-2007. FILED 12-11-2006.
- 3,310,413. **ASSETSPHERE (STYLIZED)**. WAIMARIE ASSETS LIMITED, (U.S. CLS. 21, 23, 26, 36 AND 38). SN 76-671,615. PUB. 7-31-2007. FILED S.R. 1-22-2007; AM. P.R. 1-22-2007.
- 3,310,415. **ELEVATOR (BLOCK FORM)**. GRIFFIN TECHNOLOGY, INC., (U.S. CLS. 21, 23, 26, 36 AND 38). SN 76-671,743. PUB. 7-10-2007. FILED 1-24-2007.
- 3,310,425 (*See Class 8 for this trademark*).
- 3,310,453. **EASY FLOW (BLOCK FORM)**. SAWGRASS TECHNOLOGIES, INC., (U.S. CLS. 21, 23, 26, 36 AND 38). SN 77-004,572. PUB. 7-31-2007. FILED 9-21-2006.
- 3,310,459. **IT'S YOUR GOAL. IT'S OUR PHILOSOPHY. IMPROVE EVERYTHING. (BLOCK FORM)**. VERINT AMERICAS INC., (U.S. CLS. 21, 23, 26, 36 AND 38). SN 77-005,952. PUB. 7-31-2007. FILED 9-23-2006.
- 3,310,480. **INTELLIACT (BLOCK FORM)**. CORPORATEK INC., (U.S. CLS. 21, 23, 26, 36 AND 38). SN 77-010,719. PUB. 7-31-2007. FILED 9-29-2006.
- 3,310,496. **DURANGO CALIENTE AND DESIGN**. GARCILAZO, MAURICIO MENDOZA, (U.S. CLS. 21, 23, 26, 36 AND 38). SN 77-012,658. PUB. 7-31-2007. FILED 10-3-2006.
- 3,310,528. **A LENS (STYLIZED)**. SONY KABUSHIKI KAISHA, TA SONY CORPORATION, (U.S. CLS. 21, 23, 26, 36 AND 38). SN 77-017,494. PUB. 7-31-2007. FILED 10-10-2006.
- 3,310,541. **DCS AND DESIGN**. DIGITAL CURRENCY SYSTEMS HOLDINGS LLC, (U.S. CLS. 21, 23, 26, 36 AND 38). SN 77-019,744. PUB. 7-10-2007. FILED 10-12-2006.
- 3,310,543. **TELEPAX AND DESIGN**. HEALTHY-IT, LLC, (U.S. CLS. 21, 23, 26, 36 AND 38). SN 77-020,062. PUB. 7-31-2007. FILED 10-12-2006.
- 3,310,548. **PASI (BLOCK FORM)**. INFINEON TECHNOLOGIES AG, MULTIPLE CLASS, (INT. CLS. 9 AND 38), (U.S. CLS. 21, 23, 26, 36, 38, 100, 101 AND 104). SN 77-020,482. PUB. 7-31-2007. FILED 10-13-2006.
- 3,310,549. **CUSTOM CABLE AND DESIGN**. STEELCASE DEVELOPMENT CORPORATION, MULTIPLE CLASS, (INT. CLS. 9, 37 AND 42), (U.S. CLS. 21, 23, 26, 36, 38, 100, 101, 103 AND 106). SN 77-020,660. PUB. 7-31-2007. FILED 10-13-2006.
- 3,310,553. **SALES ROTOR (BLOCK FORM)**. ALEXANDER, ADAM, (U.S. CLS. 21, 23, 26, 36 AND 38). SN 77-021,263. PUB. 7-31-2007. FILED 10-14-2006.
- 3,310,558. **MISCELLANEOUS DESIGN**. PLAYFIRST, INC., (U.S. CLS. 21, 23, 26, 36 AND 38). SN 77-022,277. PUB. 7-31-2007. FILED 10-16-2006.
- 3,310,572. **HELPSPOT (BLOCK FORM)**. USERSCAPE, INC, (U.S. CLS. 21, 23, 26, 36 AND 38). SN 77-024,586. PUB. 7-31-2007. FILED 10-19-2006.
- 3,310,574. **FOR POSTERITY (BLOCK FORM)**. ARAFEH, SOUSAN, (U.S. CLS. 21, 23, 26, 36 AND 38). SN 77-024,881. PUB. 7-31-2007. FILED 10-19-2006.
- 3,310,583. **PROJECT KID SMART (BLOCK FORM)**. PROJECT KID SMART, (U.S. CLS. 21, 23, 26, 36 AND 38). SN 77-026,502. PUB. 7-31-2007. FILED 10-21-2006.
- 3,310,587. **STUBBS THE ZOMBIE (BLOCK FORM)**. WIDELOAD GAMES, INC., (U.S. CLS. 21, 23, 26, 36 AND 38). SN 77-027,220. PUB. 7-31-2007. FILED 10-23-2006.
- 3,310,589. **PROJECT KID SMART AND DESIGN**. PROJECT KID SMART, (U.S. CLS. 21, 23, 26, 36 AND 38). SN 77-027,582. PUB. 7-31-2007. FILED 10-23-2006.
- 3,310,597. **TRUMPET MOBILE (BLOCK FORM)**. THE SAUSALITO GROUP, INC., MULTIPLE CLASS, (INT. CLS. 9 AND 38), (U.S. CLS. 21, 23, 26, 36, 38, 100, 101 AND 104). SN 77-029,513. PUB. 7-31-2007. FILED 10-25-2006.
- 3,310,598. **TRUMPET (BLOCK FORM)**. THE SAUSALITO GROUP, INC., MULTIPLE CLASS, (INT. CLS. 9 AND 38), (U.S. CLS. 21, 23, 26, 36, 38, 100, 101 AND 104). SN 77-029,547. PUB. 7-31-2007. FILED 10-25-2006.
- 3,310,601. **JEAN-LUC D'ABREAU (BLOCK FORM)**. D'ABREAU, JEAN-LUC, (U.S. CLS. 21, 23, 26, 36 AND 38). SN 77-029,825. PUB. 7-31-2007. FILED 10-26-2006.
- 3,310,622. **BEHIND THE WHEEL (BLOCK FORM)**. FROBOSE, MARK, (U.S. CLS. 21, 23, 26, 36 AND 38). SN 77-033,832. PUB. 7-31-2007. FILED 11-1-2006.
- 3,310,624. **MC2 AND DESIGN**. MANAGEMENT COMPUTER CONTROLS, INC., MULTIPLE CLASS, (INT. CLS. 9 AND 16), (U.S. CLS. 2, 5, 21, 22, 23, 26, 29, 36, 37, 38 AND 50). SN 77-034,028. PUB. 7-31-2007. FILED 11-1-2006.
- 3,310,648. **BATHTUB BABIES (BLOCK FORM)**. GARIBALDI, VERA, A, MULTIPLE CLASS, (INT. CLS. 9 AND 41), (U.S. CLS. 21, 23, 26, 36, 38, 100, 101 AND 107). SN 77-038,657. PUB. 7-31-2007. FILED 11-7-2006.
- 3,310,654. **UNLIMITED TRAINING LIBRARY (BLOCK FORM)**. THE AMERICAN HOTEL & LODGING EDUCATIONAL INSTITUTE, MULTIPLE CLASS, (INT. CLS. 9 AND 16), (U.S. CLS. 2, 5, 21, 22, 23, 26, 29, 36, 37, 38 AND 50). SN 77-039,581. PUB. 7-31-2007. FILED 11-8-2006.
- 3,310,656. **ICOIN (BLOCK FORM)**. MAGIKIST LTD., (U.S. CLS. 21, 23, 26, 36 AND 38). SN 77-040,085. PUB. 7-31-2007. FILED 11-8-2006.
- 3,310,660. **WEATHERSCOUT (BLOCK FORM)**. LAPOINT BLASE IND. INC., (U.S. CLS. 21, 23, 26, 36 AND 38). SN 77-041,346. PUB. 7-31-2007. FILED 11-10-2006.
- 3,310,665. **AXXENCE SPIRIT (BLOCK FORM)**. BSH BOSCH UND SIEMENS HAUSGERAETE GMBH, (U.S. CLS. 21, 23, 26, 36 AND 38). SN 77-041,588. PUB. 7-31-2007. FILED 11-10-2006.
- 3,310,678. **GLOBE (BLOCK FORM)**. GLOBE HOLDING COMPANY, LLC, (U.S. CLS. 21, 23, 26, 36 AND 38). SN 77-044,263. PUB. 7-31-2007. FILED 11-15-2006.
- 3,310,691. **FUSIONCODER (BLOCK FORM)**. FUSION OFFICE INTEGRATION SYSTEMS, L.L.C., (U.S. CLS. 21, 23, 26, 36 AND 38). SN 77-046,713. PUB. 7-31-2007. FILED 11-17-2006.
- 3,310,702. **AREARAE (BLOCK FORM)**. RAE SYSTEMS INC., (U.S. CLS. 21, 23, 26, 36 AND 38). SN 77-048,343. PUB. 7-31-2007. FILED 11-20-2006.
- 3,310,730. **SINTON (BLOCK FORM)**. SINTON ELECTRIC CO., LTD., (U.S. CLS. 21, 23, 26, 36 AND 38). SN 77-051,567. PUB. 7-31-2007. FILED 11-27-2006.
- 3,310,731. **NUHERTZ AND DESIGN**. NUHERTZ TECHNOLOGIES, LLC, (U.S. CLS. 21, 23, 26, 36 AND 38). SN 77-051,631. PUB. 7-31-2007. FILED 11-27-2006.
- 3,310,740. **GRID-X (BLOCK FORM)**. SEAFIRE MICROS, INC., (U.S. CLS. 21, 23, 26, 36 AND 38). SN 77-053,631. PUB. 7-31-2007. FILED 11-30-2006.
- 3,310,752. **ESP (BLOCK FORM)**. THE FIRST AMERICAN CORPORATION, (U.S. CLS. 21, 23, 26, 36 AND 38). SN 77-

- 054,377. PUB. 7-31-2007. FILED 11-30-2006.
- 3,310,756. **TOUCH + (STYLIZED)**. ENDOSENSE SA, MULTIPLE CLASS, (INT. CLS. 9, 10, 42 AND 44), (U.S. CLS. 21, 23, 26, 36, 38, 39, 44, 100 AND 101). SN 77-054,845. PUB. 7-17-2007. FILED 12-1-2006.
- 3,310,758. **TACTICATH (STYLIZED)**. ENDOSENSE SA, MULTIPLE CLASS, (INT. CLS. 9 AND 10), (U.S. CLS. 21, 23, 26, 36, 38, 39 AND 44). SN 77-055,007. PUB. 7-17-2007. FILED 12-1-2006.
- 3,310,770. **FEDEX KINKO'S (BLOCK FORM)**. FEDERAL EXPRESS CORPORATION, AND KINKO'S VENTURES, INC., MULTIPLE CLASS, (INT. CLS. 9, 35, 38, 39, 40, 41 AND 42), (U.S. CLS. 21, 23, 26, 36, 38, 100, 101, 102, 103, 104, 105, 106 AND 107). SN 77-057,465. PUB. 7-31-2007. FILED 12-5-2006.
- 3,310,772. **NANOTEC GLISSEE (BLOCK FORM)**. BSH BOSCH UND SIEMENS HAUSGERAETE GMBH, (U.S. CLS. 21, 23, 26, 36 AND 38). SN 77-058,096. PUB. 7-31-2007. FILED 12-6-2006.
- 3,310,784. **QRAE (BLOCK FORM)**. RAE SYSTEMS INC., (U.S. CLS. 21, 23, 26, 36 AND 38). SN 77-059,659. PUB. 7-31-2007. FILED 12-7-2006.
- 3,310,792. **CAMIRA (BLOCK FORM)**. SE-IR CORPORATION, (U.S. CLS. 21, 23, 26, 36 AND 38). SN 77-060,785. PUB. 7-31-2007. FILED 12-9-2006.
- 3,310,802. **RINGLEADER AND DESIGN**. SADRICIA WILSON, AND CHAD WILSON, (U.S. CLS. 21, 23, 26, 36 AND 38). SN 77-061,421. PUB. 7-31-2007. FILED 12-11-2006.
- 3,310,804. **DVDOTS AND DESIGN**. SADRICIA WILSON, AND CHAD WILSON, (U.S. CLS. 21, 23, 26, 36 AND 38). SN 77-061,634. PUB. 7-31-2007. FILED 12-11-2006.
- 3,310,808. **CIPHER TALK (BLOCK FORM)**. TECHNICAL COMMUNICATIONS CORPORATION, (U.S. CLS. 21, 23, 26, 36 AND 38). SN 77-062,068. PUB. 7-31-2007. FILED 12-12-2006.
- 3,310,811. **NJV NAVISON AUDIO AND DESIGN**. NAVISON AUDIO, (U.S. CLS. 21, 23, 26, 36 AND 38). SN 77-062,330. PUB. 7-31-2007. FILED 12-12-2006.
- 3,310,816. **ULTRAPOWER "ENGINE PERFORMANCE PRODUCTS" AND DESIGN**. BRAZEK'S RV PERFORMANCE, (U.S. CLS. 21, 23, 26, 36 AND 38). SN 77-063,140. PUB. 7-31-2007. FILED S.R. 12-13-2006; AM. P.R. 6-13-2007.
- 3,310,819. **TURBOSYNC (BLOCK FORM)**. YADULLAH T. JORDAN, (U.S. CLS. 21, 23, 26, 36 AND 38). SN 77-063,885. PUB. 7-31-2007. FILED 12-13-2006.
- 3,310,825. **SEE INSIDE THE CHART (BLOCK FORM)**. MARKETDELTA, LLC, (U.S. CLS. 21, 23, 26, 36 AND 38). SN 77-064,577. PUB. 7-31-2007. FILED 12-14-2006.
- 3,310,834. **PRECIOUS MOMENTS (BLOCK FORM)**. PRECIOUS MOMENTS, INCORPORATED, (U.S. CLS. 21, 23, 26, 36 AND 38). SN 77-065,384. PUB. 7-31-2007. FILED 12-15-2006.
- 3,310,842. **SMART ON THE GO (BLOCK FORM)**. FRIEDLINE, JASON T., (U.S. CLS. 21, 23, 26, 36 AND 38). SN 77-066,153. PUB. 7-31-2007. FILED 12-18-2006.
- 3,310,894. **SEMBA (BLOCK FORM)**. SEMBA, INC., MULTIPLE CLASS, (INT. CLS. 9 AND 42), (U.S. CLS. 21, 23, 26, 36, 38, 100 AND 101). SN 77-068,683. PUB. 7-31-2007. FILED 12-20-2006.
- 3,310,900. **MICROGUARD MP (BLOCK FORM)**. INTERNATIONAL ENVIROGUARD SYSTEMS, INC., (U.S. CLS. 21, 23, 26, 36 AND 38). SN 77-069,078. PUB. 7-31-2007. FILED 12-21-2006.
- 3,310,903. **DATAWATCH (BLOCK FORM)**. DATAWATCH CORPORATION, (U.S. CLS. 21, 23, 26, 36 AND 38). SN 77-069,098. PUB. 7-31-2007. FILED 12-21-2006.
- 3,310,905. **GEM REMOTES (BLOCK FORM)**. SHANAHAN, RICHARD, (U.S. CLS. 21, 23, 26, 36 AND 38). SN 77-069,146. PUB. 7-31-2007. FILED 12-21-2006.
- 3,310,907. **ENTERPRICE (BLOCK FORM)**. MULTIPLAN, INC., (U.S. CLS. 21, 23, 26, 36 AND 38). SN 77-069,162. PUB. 7-31-2007. FILED 12-21-2006.
- 3,310,920. **SPR KNOWLEDGEPLAN (BLOCK FORM)**. SOFTWARE PRODUCTIVITY RESEARCH, LLC, (U.S. CLS. 21, 23, 26, 36 AND 38). SN 77-069,704. PUB. 7-31-2007. FILED 12-21-2006.
- 3,310,931. **CELLCORDER (BLOCK FORM)**. ALBER CORP., (U.S. CLS. 21, 23, 26, 36 AND 38). SN 77-070,350. PUB. 7-31-2007. FILED 12-22-2006.
- 3,310,933. **DEEP (BLOCK FORM)**. CRESCENT BAY SOFTWARE, (U.S. CLS. 21, 23, 26, 36 AND 38). SN 77-070,494. PUB. 7-31-2007. FILED 12-22-2006.
- 3,310,962. **SIMPLE ENERGY ESTIMATOR (BLOCK FORM)**. PROGRESSIVE LIGHTING SYSTEMS, INC., (U.S. CLS. 21, 23, 26, 36 AND 38). SN 77-071,260. PUB. 7-31-2007. FILED 12-26-2006.
- 3,310,978. **CENTEN (BLOCK FORM)**. SINTON ELECTRIC CO. LTD., (U.S. CLS. 21, 23, 26, 36 AND 38). SN 77-071,844. PUB. 7-31-2007. FILED 12-27-2006.
- 3,310,988. **AUTOCALIBRATION (BLOCK FORM)**. BERKELEY PROCESS CONTROL, INC., (U.S. CLS. 21, 23, 26, 36 AND 38). SN 77-072,062. PUB. 7-31-2007. FILED 12-27-2006.
- 3,310,994. **ABBI (BLOCK FORM)**. OH, STEVEN S., MULTIPLE CLASS, (INT. CLS. 9 AND 18), (U.S. CLS. 1, 2, 3, 21, 22, 23, 26, 36, 38 AND 41). SN 77-072,220. PUB. 7-31-2007. FILED 12-27-2006.
- 3,311,001. **MOTHER-DAUGHTER WISDOM (BLOCK FORM)**. CHRISTIANE NORTHRUP, INC., (U.S. CLS. 21, 23, 26, 36 AND 38). SN 77-072,341. PUB. 7-31-2007. FILED 12-28-2006.
- 3,311,029. **FACEONBODY (BLOCK FORM)**. FACEONBODY, INC., (U.S. CLS. 21, 23, 26, 36 AND 38). SN 77-072,783. PUB. 7-31-2007. FILED 12-28-2006.
- 3,311,046. **PD AND DESIGN**. PERSONIFY DESIGN INC., MULTIPLE CLASS, (INT. CLS. 9 AND 42), (U.S. CLS. 21, 23, 26, 36, 38, 100 AND 101). SN 77-073,285. PUB. 7-31-2007. FILED 12-29-2006.
- 3,311,047. **TEAMSOLUTIONS (BLOCK FORM)**. PERSONIFY DESIGN INC., (U.S. CLS. 21, 23, 26, 36 AND 38). SN 77-073,287. PUB. 7-31-2007. FILED 12-29-2006.
- 3,311,048. **TEAMSPEC (BLOCK FORM)**. PERSONIFY DESIGN INC., (U.S. CLS. 21, 23, 26, 36 AND 38). SN 77-073,296. PUB. 7-31-2007. FILED 12-29-2006.
- 3,311,062. **AEROGARDEN (BLOCK FORM)**. AEROGROW INTERNATIONAL, INC., (U.S. CLS. 21, 23, 26, 36 AND 38). SN 77-073,424. PUB. 7-31-2007. FILED 12-29-2006.
- 3,311,064. **MUNICIPALITY (BLOCK FORM)**. GENERAL CODE PUBLISHERS CORP., (U.S. CLS. 21, 23, 26, 36 AND 38). SN 77-073,526. PUB. 7-31-2007. FILED 12-29-2006.
- 3,311,082. **FLEXFIELD AND DESIGN**. HELENE ABRAMS, (U.S. CLS. 21, 23, 26, 36 AND 38). SN 77-073,997. PUB. 7-31-2007. FILED 1-1-2007.
- 3,311,083. **FLEXFIELD EXPRESS (STYLIZED)**. HELENE ABRAMS, (U.S. CLS. 21, 23, 26, 36 AND 38). SN 77-073,998. PUB. 7-31-2007. FILED 1-1-2007.
- 3,311,084. **MAGICMARKER (BLOCK FORM)**. PERSYST DEVELOPMENT CORPORATION, INC., (U.S. CLS. 21, 23, 26, 36 AND 38). SN 77-074,024. PUB. 7-31-2007. FILED 1-1-2007.
- 3,311,085. **REVEAL (BLOCK FORM)**. PERSYST DEVELOPMENT CORPORATION, INC., (U.S. CLS. 21, 23, 26, 36 AND 38). SN 77-074,025. PUB. 7-31-2007. FILED 1-1-2007.
- 3,311,099. **KEEPVAULT (BLOCK FORM)**. PROXURE, INC., (U.S. CLS. 21, 23, 26, 36 AND 38). SN 77-074,434. PUB. 7-31-2007. FILED 1-2-2007.
- 3,311,106. **AMMO (STYLIZED)**. BOR JYE ENTERPRISE CO., LTD., (U.S. CLS. 21, 23, 26, 36 AND 38). SN 77-074,759. PUB. 7-31-2007. FILED 1-3-2007.
- 3,311,117. **TAC-PAC (BLOCK FORM)**. SECTION8TACTICAL INC, (U.S. CLS. 21, 23, 26, 36 AND 38). SN 77-074,999. PUB. 7-31-2007. FILED 1-3-2007.
- 3,311,119. **ALPHAEMR (BLOCK FORM)**. GRIFFITH INC T/A ALPHA SYSTEMS, (U.S. CLS. 21, 23, 26, 36 AND 38). SN 77-075,111. PUB. 7-31-2007. FILED 1-3-2007.
- 3,311,126. **REWARD CHECKING (BLOCK FORM)**. BANC-VUE, LTD., MULTIPLE CLASS, (INT. CLS. 9, 35 AND 36), (U.S. CLS. 21, 23, 26, 36, 38, 100, 101 AND 102). SN 77-076,198. PUB. 7-31-2007. FILED 1-4-2007.
- 3,311,139. **ONIX LOUDSPEAKERS (BLOCK FORM)**. PERPETUAL TECHNOLOGIES, LLC, (U.S. CLS. 21, 23, 26, 36 AND 38). SN 77-076,734. PUB. 7-31-2007. FILED 1-5-2007.
- 3,311,161. **POWER UP (BLOCK FORM)**. STANDARD CABLE, DBA CONDUCTIVE CABLE, (U.S. CLS. 21, 23, 26, 36 AND 38). SN 77-079,782. PUB. 7-31-2007. FILED 1-10-2007.
- 3,311,171. **SPI AND DESIGN**. STREAM PROCESSORS, INC., (U.S. CLS. 21, 23, 26, 36 AND 38). SN 77-080,724. PUB. 7-31-2007. FILED 1-11-2007.
- 3,311,184. **NAUTEL, INC. (BLOCK FORM)**. NAUTEL MAINE,

- INC., (U.S. CLS. 21, 23, 26, 36 AND 38). SN 77-081,741. PUB. 7-31-2007. FILED 1-12-2007.
- 3,311,187. **PHILADELPHIA EAGLES (BLOCK FORM)**. PHILADELPHIA EAGLES LLC, MULTIPLE CLASS, (INT. CLS. 9, 14 AND 28), (U.S. CLS. 2, 21, 22, 23, 26, 27, 28, 36, 38 AND 50). SN 77-081,808. PUB. 7-31-2007. FILED 1-12-2007.
- 3,311,210. **RXI (BLOCK FORM)**. RESTEK CORPORATION, (U.S. CLS. 21, 23, 26, 36 AND 38). SN 77-083,686. PUB. 7-31-2007. FILED 1-16-2007.
- 3,311,216. **DISCOVERY ENGINE (BLOCK FORM)**. I411 INC, MULTIPLE CLASS, (INT. CLS. 9, 35 AND 42), (U.S. CLS. 21, 23, 26, 36, 38, 100, 101 AND 102). SN 77-084,903. PUB. 7-31-2007. FILED 1-17-2007.
- 3,311,243. **IQ FLOW (BLOCK FORM)**. BRONKHORST HIGH - TECH B.V., (U.S. CLS. 21, 23, 26, 36 AND 38). SN 77-086,530. PUB. 7-31-2007. FILED 1-19-2007.
- 3,311,247. **MILLER WELDMASTER (BLOCK FORM)**. MILLER WELDMASTER CORPORATION, MULTIPLE CLASS, (INT. CLS. 9 AND 37), (U.S. CLS. 21, 23, 26, 36, 38, 100, 103 AND 106). SN 77-086,844. PUB. 7-31-2007. FILED 1-19-2007.
- 3,311,253. **MONOWALL (BLOCK FORM)**. KASPER, MANUEL, (U.S. CLS. 21, 23, 26, 36 AND 38). SN 77-087,283. PUB. 7-31-2007. FILED 1-20-2007.
- 3,311,257. **MW (STYLIZED)**. MILLER WELDMASTER CORPORATION, MULTIPLE CLASS, (INT. CLS. 9 AND 37), (U.S. CLS. 21, 23, 26, 36, 38, 100, 103 AND 106). SN 77-087,604. PUB. 7-31-2007. FILED 1-22-2007.
- 3,311,262. **CINCOM ELOQUENCE (BLOCK FORM)**. CINCOM SYSTEMS, INC., (U.S. CLS. 21, 23, 26, 36 AND 38). SN 77-088,217. PUB. 7-31-2007. FILED 1-22-2007.
- 3,311,271. **NS2 (BLOCK FORM)**. UNICONTROL INC., (U.S. CLS. 21, 23, 26, 36 AND 38). SN 77-089,197. PUB. 7-31-2007. FILED 1-23-2007.
- 3,311,281. **AUTEC BATTERY (BLOCK FORM)**. AUTEC POWER SYSTEMS, INC., (U.S. CLS. 21, 23, 26, 36 AND 38). SN 77-089,891. PUB. 7-31-2007. FILED 1-24-2007.
- 3,311,284. **KLAFS (BLOCK FORM)**. KLAFS SAUNABAU GMBH & CO. KG MEDIZINISCHE TECHNIK, MULTIPLE CLASS, (INT. CLS. 9 AND 11), (U.S. CLS. 13, 21, 23, 26, 31, 34, 36 AND 38). SN 77-090,017. PUB. 7-31-2007. FILED 1-24-2007.
- 3,311,295. **TRAUMA CENTER (BLOCK FORM)**. ATLUS U.S.A., INC., (U.S. CLS. 21, 23, 26, 36 AND 38). SN 77-090,832. PUB. 7-31-2007. FILED 1-25-2007.
- 3,311,313. **YOGA GROOVE AND DESIGN**. KAREN RUSSELL, MULTIPLE CLASS, (INT. CLS. 9 AND 41), (U.S. CLS. 21, 23, 26, 36, 38, 100, 101 AND 107). SN 77-093,077. PUB. 7-17-2007. FILED 1-28-2007.
- 3,311,327. **MISCELLANEOUS DESIGN**. ZINKY ELECTRONICS, (U.S. CLS. 21, 23, 26, 36 AND 38). SN 77-093,981. PUB. 7-17-2007. FILED 1-29-2007.
- 3,311,330 (*See Class 6 for this trademark*).
- 3,311,333. **ACT OF COMMUNICATION (BLOCK FORM)**. ACT OF COMMUNICATION, (U.S. CLS. 21, 23, 26, 36 AND 38). SN 77-094,396. PUB. 7-31-2007. FILED 1-30-2007.
- 3,311,334. **TROPHY BASS (BLOCK FORM)**. SIERRA ENTERTAINMENT, INC., (U.S. CLS. 21, 23, 26, 36 AND 38). SN 77-094,399. PUB. 7-31-2007. FILED 1-30-2007.
- 3,311,335. **ADACS (BLOCK FORM)**. AVIATION TECHNOLOGY, INC., (U.S. CLS. 21, 23, 26, 36 AND 38). SN 77-094,401. PUB. 7-31-2007. FILED 1-30-2007.
- 3,311,338. **FROM LEGAL MINDS, FOR LEGAL FIRMS (BLOCK FORM)**. THE LEGAL ASSISTANT, LLC, (U.S. CLS. 21, 23, 26, 36 AND 38). SN 77-094,447. PUB. 7-31-2007. FILED 1-30-2007.
- 3,311,351. **EZBRACKET (BLOCK FORM)**. LAVA CONTROLS, LLC, (U.S. CLS. 21, 23, 26, 36 AND 38). SN 77-095,776. PUB. 7-31-2007. FILED 1-31-2007.
- 3,311,384. **BILLMASTER (BLOCK FORM)**. DATA WEST CORPORATION, (U.S. CLS. 21, 23, 26, 36 AND 38). SN 77-097,738. PUB. 7-31-2007. FILED 2-2-2007.
- 3,311,414. **LEG-GUARD (BLOCK FORM)**. HTC, INC, (U.S. CLS. 21, 23, 26, 36 AND 38). SN 77-098,749. PUB. 7-31-2007. FILED 2-4-2007.
- 3,311,416. **VULCANWEAR (BLOCK FORM)**. HTC, INC, (U.S. CLS. 21, 23, 26, 36 AND 38). SN 77-098,791. PUB. 7-31-2007. FILED 2-4-2007.
- 3,311,425. **CLEARLINK (BLOCK FORM)**. CYRACOM INTER-NATIONAL INC., MULTIPLE CLASS, (INT. CLS. 9 AND 41), (U.S. CLS. 21, 23, 26, 36, 38, 100, 101 AND 107). SN 77-098,977. PUB. 7-31-2007. FILED 2-5-2007.
- 3,311,438. **MADE IN XX (BLOCK FORM)**. LIN, JONATHAN ZHI-HAN, (U.S. CLS. 21, 23, 26, 36 AND 38). SN 77-099,405. PUB. 7-31-2007. FILED 2-5-2007.
- 3,311,440. **DEFENDERMX (BLOCK FORM)**. FORTRTERS SYSTEMS LTD., (U.S. CLS. 21, 23, 26, 36 AND 38). SN 77-099,432. PUB. 7-31-2007. FILED 2-5-2007.
- 3,311,464. **TITANMOON (BLOCK FORM)**. GONZALEZ DIAZ , ENRIQUE A., DBA M.A. PRODUCTIONS/POLLYMOOD RECORDS, MULTIPLE CLASS, (INT. CLS. 9 AND 41), (U.S. CLS. 21, 23, 26, 36, 38, 100, 101 AND 107). SN 77-101,007. PUB. 7-31-2007. FILED 2-6-2007.
- 3,311,472. **MY PERSONAL TUTOR (BLOCK FORM)**. AMERICAN TELECOMMUNICATION DEVICES, INC., (U.S. CLS. 21, 23, 26, 36 AND 38). SN 77-101,510. PUB. 7-31-2007. FILED 2-7-2007.
- 3,311,475. **MOBILPROX (BLOCK FORM)**. DEISTER ELECTRONIC GMBH, (U.S. CLS. 21, 23, 26, 36 AND 38). SN 77-101,682. PUB. 7-31-2007. FILED 2-7-2007.
- 3,311,480. **MISCELLANEOUS DESIGN**. BLAZENT, INC., (U.S. CLS. 21, 23, 26, 36 AND 38). SN 77-101,990. PUB. 7-31-2007. FILED 2-7-2007.
- 3,311,496. **FERROTRON (BLOCK FORM)**. SPECIALTY MINERALS (MICHIGAN) INC., MULTIPLE CLASS, (INT. CLS. 9 AND 42), (U.S. CLS. 21, 23, 26, 36, 38, 100 AND 101). SN 77-104,859. PUB. 7-31-2007. FILED 2-12-2007.
- 3,311,503. **X EXEEDER (STYLIZED)**. ZHE, WANG, (U.S. CLS. 21, 23, 26, 36 AND 38). SN 77-106,972. PUB. 7-31-2007. FILED 2-14-2007.
- 3,311,504. **PAYFOREIGN (BLOCK FORM)**. PAYSETT CORPORATION, (U.S. CLS. 21, 23, 26, 36 AND 38). SN 77-107,314. PUB. 7-31-2007. FILED 2-14-2007.
- 3,311,513. **SAJARA (BLOCK FORM)**. AVENCIA INCORPORATED, (U.S. CLS. 21, 23, 26, 36 AND 38). SN 77-109,635. PUB. 7-31-2007. FILED 2-16-2007.
- 3,311,555. **KOVE (BLOCK FORM)**. KIM, BOOYUN, (U.S. CLS. 21, 23, 26, 36 AND 38). SN 77-118,835. PUB. 7-31-2007. FILED 2-28-2007.
- 3,311,558. **FLEXISLIC (BLOCK FORM)**. INFINEON TECHNOLOGIES AG, (U.S. CLS. 21, 23, 26, 36 AND 38). SN 77-121,034. PUB. 7-31-2007. FILED 3-2-2007.
- 3,311,574. **TRUEPLAY (BLOCK FORM)**. ON2 TECHNOLOGIES, INC., (U.S. CLS. 21, 23, 26, 36 AND 38). SN 77-125,943. PUB. 7-31-2007. FILED 3-8-2007.
- 3,311,577. **TRAILER LIFE (BLOCK FORM)**. AFFINITY GROUP, INC., (U.S. CLS. 21, 23, 26, 36 AND 38). SN 77-126,177. PUB. 7-31-2007. FILED 3-8-2007.
- 3,311,578. **WALCHEM (BLOCK FORM)**. WALCHEM CORPORATION, (U.S. CLS. 21, 23, 26, 36 AND 38). SN 77-126,610. PUB. 7-31-2007. FILED 3-9-2007.
- 3,311,581. **VXT (BLOCK FORM)**. KRK SYSTEMS, L.L.C., (U.S. CLS. 21, 23, 26, 36 AND 38). SN 77-128,332. PUB. 7-31-2007. FILED 3-12-2007.
- 3,311,595. **CLAIMS OUTCOME ADVISOR (BLOCK FORM)**. ISO CLAIMS SERVICES, INC., (U.S. CLS. 21, 23, 26, 36 AND 38). SN 77-132,312. PUB. 7-31-2007. FILED 3-15-2007.
- 3,311,613. **LYRION (BLOCK FORM)**. SEAGATE TECHNOLOGY LLC, (U.S. CLS. 21, 23, 26, 36 AND 38). SN 77-150,127. PUB. 7-31-2007. FILED 4-5-2007.
- 3,311,619. **QMAC (BLOCK FORM)**. AIR PRODUCTS AND CHEMICALS, INC., (U.S. CLS. 21, 23, 26, 36 AND 38). SN 77-155,286. PUB. 7-31-2007. FILED 4-12-2007.
- 3,311,626. **I MODE AND DESIGN**. KABUSHIKI KAISHA NTT DOCOMO, DBA NTT DOCOMO, INC., MULTIPLE CLASS, (INT. CLS. 9, 16, 38 AND 42), (U.S. CLS. 2, 5, 21, 22, 23, 26, 29, 36, 37, 38, 50, 100, 101 AND 104). SN 78-059,501. PUB. 7-31-2007. FILED 4-20-2001.
- 3,311,627. **SIVOX (STYLIZED)**. INTERKINETIC, INC., (U.S. CLS. 21, 23, 26, 36 AND 38). SN 78-100,948. PUB. 7-31-2007. FILED 1-4-2002.
- 3,311,632. **A ARGON TECHNOLOGY CORPORATION AND DESIGN**. ARGON TECHNOLOGY CORPORATION, (U.S. CLS. 21, 23, 26, 36 AND 38). SN 78-158,369. PUB. 7-31-2007. FILED 8-27-2002.
- 3,311,634 (*See Class 2 for this trademark*).
- 3,311,643. **LONG REACH (STYLIZED)**. GENNUM COR-

- PORATION, (U.S. CLS. 21, 23, 26, 36 AND 38). SN 78-297,705. PUB. 3-27-2007. FILED 9-9-2003.
- 3,311,646. **MISCELLANEOUS DESIGN.** WRG SERVICES INC., (U.S. CLS. 21, 23, 26, 36 AND 38). SN 78-316,739. PUB. 7-31-2007. FILED 10-21-2003.
- 3,311,651. **PUSH-ONTV (BLOCK FORM).** KABUSHIKI KAISHA ACCESS, TA ACCESS CO., LTD., MULTIPLE CLASS, (INT. CLS. 9, 35, 38 AND 42), (U.S. CLS. 21, 23, 26, 36, 38, 100, 101, 102 AND 104). SN 78-375,116. PUB. 7-31-2007. FILED 2-27-2004.
- 3,311,652. **JUST LISTEN (BLOCK FORM).** RED CHIP COMPANY LTD., MULTIPLE CLASS, (INT. CLS. 9 AND 15), (U.S. CLS. 2, 21, 23, 26, 36 AND 38). SN 78-379,156. PUB. 7-31-2007. FILED 3-5-2004.
- 3,311,654. **CATAPULT (BLOCK FORM).** MENTOR GRAPHICS CORPORATION, (U.S. CLS. 21, 23, 26, 36 AND 38). SN 78-402,917. PUB. 7-31-2007. FILED 4-16-2004.
- 3,311,659. **ROUTE SMART TECHNOLOGIES AND DESIGN.** BOWNE DISTINCT, LTD., (U.S. CLS. 21, 23, 26, 36 AND 38). SN 78-454,276. PUB. 7-31-2007. FILED 7-21-2004.
- 3,311,663. **VFINITY (BLOCK FORM).** WAN NET TECHNOLOGY, LTD. (BVI), MULTIPLE CLASS, (INT. CLS. 9, 39, 41 AND 42), (U.S. CLS. 21, 23, 26, 36, 38, 100, 101, 105 AND 107). SN 78-475,093. PUB. 7-31-2007. FILED 8-27-2004.
- 3,311,664 (*See Class 3 for this trademark*).
- 3,311,666. **ALGO (BLOCK FORM).** ALGORITHMICS TRADEMARKS LLC, MULTIPLE CLASS, (INT. CLS. 9, 35, 36, 41 AND 42), (U.S. CLS. 21, 23, 26, 36, 38, 100, 101, 102 AND 107). SN 78-502,481. PUB. 7-31-2007. FILED 10-19-2004.
- 3,311,668. **FIRST TO KNOW. FIRST TO ACT. (BLOCK FORM).** SAAB AB, MULTIPLE CLASS, (INT. CLS. 9, 38 AND 42), (U.S. CLS. 21, 23, 26, 36, 38, 100, 101 AND 104). SN 78-509,732. PUB. 7-31-2007. FILED 11-2-2004.
- 3,311,674. **ELEMENTAL (BLOCK FORM).** ELEMENTAL SECURITY, INC., (U.S. CLS. 21, 23, 26, 36 AND 38). SN 78-532,393. PUB. 7-31-2007. FILED 12-14-2004.
- 3,311,681. **IRISO AND DESIGN.** IRISO ELECTRONICS CO., LTD., (U.S. CLS. 21, 23, 26, 36 AND 38). SN 78-551,699. PUB. 7-31-2007. FILED 1-21-2005.
- 3,311,684. **MOOKS (BLOCK FORM).** PACIFIC BRANDS SPORT & LEISURE PTY LTD, MULTIPLE CLASS, (INT. CLS. 9, 18 AND 25), (U.S. CLS. 1, 2, 3, 21, 22, 23, 26, 36, 38, 39 AND 41). SN 78-553,755. PUB. 7-31-2007. FILED 1-25-2005.
- 3,311,685. **MOOKS CLOTHING CO. AND DESIGN.** PACIFIC BRANDS SPORT & LEISURE PTY LTD, (U.S. CLS. 21, 23, 26, 36 AND 38). SN 78-553,764. PUB. 7-31-2007. FILED 1-25-2005.
- 3,311,687. **LB ICON (BLOCK FORM).** LB ICON AB, MULTIPLE CLASS, (INT. CLS. 9, 35, 38, 41 AND 42), (U.S. CLS. 21, 23, 26, 36, 38, 100, 101, 102, 104 AND 107). SN 78-554,708. PUB. 4-10-2007. FILED 1-27-2005.
- 3,311,694. **ERASURE (BLOCK FORM).** ADTRON CORPORATION, (U.S. CLS. 21, 23, 26, 36 AND 38). SN 78-568,276. PUB. 6-6-2006. FILED 2-16-2005.
- 3,311,695. **DTS AND DESIGN.** DIGITAL THEATER SYSTEMS, INC., MULTIPLE CLASS, (INT. CLS. 9 AND 41), (U.S. CLS. 21, 23, 26, 36, 38, 100, 101 AND 107). SN 78-569,940. PUB. 7-31-2007. FILED 2-17-2005.
- 3,311,697. **OPTIMODE (BLOCK FORM).** ARM LIMITED, MULTIPLE CLASS, (INT. CLS. 9, 16 AND 42), (U.S. CLS. 2, 5, 21, 22, 23, 26, 29, 36, 37, 38, 50, 100 AND 101). SN 78-577,746. PUB. 7-31-2007. FILED 3-1-2005.
- 3,311,700. **OBERON (BLOCK FORM).** OBERON MEDIA, INC., MULTIPLE CLASS, (INT. CLS. 9, 35, 41 AND 42), (U.S. CLS. 21, 23, 26, 36, 38, 100, 101, 102 AND 107). SN 78-581,327. PUB. 7-31-2007. FILED 3-7-2005.
- 3,311,701. **TRACESECURITY (BLOCK FORM).** TRACESECURITY, INC., MULTIPLE CLASS, (INT. CLS. 9, 42 AND 45), (U.S. CLS. 21, 23, 26, 36, 38, 100 AND 101). SN 78-587,181. PUB. 7-31-2007. FILED 3-15-2005.
- 3,311,707. **BIG SHOT (BLOCK FORM).** PEEDEE PRODUCTIONS LIMITED, (U.S. CLS. 21, 23, 26, 36 AND 38). SN 78-595,189. PUB. 4-17-2007. FILED 3-25-2005.
- 3,311,725. **TIMPANI AND DESIGN.** LIVEPERSON, INC., (U.S. CLS. 21, 23, 26, 36 AND 38). SN 78-642,047. PUB. 7-31-2007. FILED 6-2-2005.
- 3,311,727. **GFI (STYLIZED).** AU OPTRONICS CORP., (U.S. CLS. 21, 23, 26, 36 AND 38). SN 78-649,367. PUB. 7-31-2007. FILED 6-13-2005.
- 3,311,731. **EXILE AND DESIGN.** MORRISON, GEORGE IVAN, DBA VAN MORRISON, MULTIPLE CLASS, (INT. CLS. 9, 39 AND 41), (U.S. CLS. 21, 23, 26, 36, 38, 100, 101, 105 AND 107). SN 78-651,953. PUB. 7-31-2007. FILED 6-16-2005.
- 3,311,740. **ID MAKER (BLOCK FORM).** BAUDVILLE INC., (U.S. CLS. 21, 23, 26, 36 AND 38). SN 78-656,631. PUB. 7-31-2007. FILED 6-23-2005.
- 3,311,742. **RIZOMA (BLOCK FORM).** RIZOMA S.R.L., MULTIPLE CLASS, (INT. CLS. 9, 12, 14 AND 25), (U.S. CLS. 2, 19, 21, 22, 23, 26, 27, 28, 31, 35, 36, 38, 39, 44 AND 50). SN 78-658,819. PUB. 7-31-2007. FILED 6-27-2005.
- 3,311,748. **XANTREX (BLOCK FORM).** XANTREX INTERNATIONAL, MULTIPLE CLASS, (INT. CLS. 9 AND 11), (U.S. CLS. 13, 21, 23, 26, 31, 34, 36 AND 38). SN 78-672,372. PUB. 7-31-2007. FILED 7-18-2005.
- 3,311,755. **BIBLETTELLING (BLOCK FORM).** INTERNATIONAL LEARNING SOLUTIONS, MULTIPLE CLASS, (INT. CLS. 9 AND 16), (U.S. CLS. 2, 5, 21, 22, 23, 26, 29, 36, 37, 38 AND 50). SN 78-677,941. PUB. 7-31-2007. FILED 7-25-2005.
- 3,311,759 (*See Class 7 for this trademark*).
- 3,311,765. **BANANA (BLOCK FORM).** SOUNDHOUSE MUSIC ALLIANCE PTY LTD., MULTIPLE CLASS, (INT. CLS. 9 AND 15), (U.S. CLS. 2, 21, 23, 26, 36 AND 38). SN 78-690,154. PUB. 7-31-2007. FILED 8-10-2005.
- 3,311,766. **ENABLING TOMORROW'S TECHNOLOGY TODAY (BLOCK FORM).** RAVE, LLC, MULTIPLE CLASS, (INT. CLS. 9 AND 37), (U.S. CLS. 21, 23, 26, 36, 38, 100, 103 AND 106). SN 78-690,967. PUB. 7-31-2007. FILED 8-11-2005.
- 3,311,770. **INTELI-POWER (BLOCK FORM).** PROGRESSIVE DYNAMICS, INC., (U.S. CLS. 21, 23, 26, 36 AND 38). SN 78-695,493. PUB. 7-31-2007. FILED 8-18-2005.
- 3,311,791. **AVADIS (BLOCK FORM).** STRAND LIFE SCIENCES PRIVATE LIMITED, MULTIPLE CLASS, (INT. CLS. 9 AND 16), (U.S. CLS. 2, 5, 21, 22, 23, 26, 29, 36, 37, 38 AND 50). SN 78-709,061. PUB. 7-31-2007. FILED 9-8-2005.
- 3,311,802. **SIMPLE. STYLISH. SMART. (BLOCK FORM).** D & M HOLDINGS US, INC., (U.S. CLS. 21, 23, 26, 36 AND 38). SN 78-717,934. PUB. 7-31-2007. FILED 9-21-2005.
- 3,311,811. **EAGLE SEARCH PRODUCT (BLOCK FORM).** THE FIRST AMERICAN CORPORATION, (U.S. CLS. 21, 23, 26, 36 AND 38). SN 78-723,095. PUB. 7-31-2007. FILED 9-29-2005.
- 3,311,821. **METER ENGINEERS (BLOCK FORM).** METER ENGINEERS, INC., MULTIPLE CLASS, (INT. CLS. 9, 37, 40 AND 42), (U.S. CLS. 21, 23, 26, 36, 38, 100, 101, 103 AND 106). SN 78-729,711. PUB. 7-31-2007. FILED 10-10-2005.
- 3,311,831. **2BEE (BLOCK FORM).** COMPEX SYSTEMSHAUS GMBH, (U.S. CLS. 21, 23, 26, 36 AND 38). SN 78-737,074. PUB. 7-31-2007. FILED 10-20-2005.
- 3,311,843. **SEW MAGIC MOMENTS (BLOCK FORM).** MURPHY, VALARIE, (U.S. CLS. 21, 23, 26, 36 AND 38). SN 78-743,760. PUB. 7-31-2007. FILED 10-31-2005.
- 3,311,849. **MISCELLANEOUS DESIGN.** NEUSOFT GROUP LTD., MULTIPLE CLASS, (INT. CLS. 9, 10 AND 42), (U.S. CLS. 21, 23, 26, 36, 38, 39, 44, 100 AND 101). SN 78-748,481. PUB. 7-31-2007. FILED 11-7-2005.
- 3,311,850. **S AND DESIGN.** CARSPOT.COM, LLC, MULTIPLE CLASS, (INT. CLS. 9 AND 35), (U.S. CLS. 21, 23, 26, 36, 38, 100, 101 AND 102). SN 78-748,790. PUB. 7-31-2007. FILED 11-7-2005.
- 3,311,858. **BLUELAB AND DESIGN.** NZ HYDROPONICS INTERNATIONAL LTD., MULTIPLE CLASS, (INT. CLS. 9 AND 11), (U.S. CLS. 13, 21, 23, 26, 31, 34, 36 AND 38). SN 78-755,251. PUB. 7-31-2007. FILED 11-16-2005.
- 3,311,871. **YAKABOD (BLOCK FORM).** YAKABOD, INC., MULTIPLE CLASS, (INT. CLS. 9 AND 42), (U.S. CLS. 21, 23, 26, 36, 38, 100 AND 101). SN 78-766,965. PUB. 7-31-2007. FILED 12-5-2005.
- 3,311,872 (*See Class 6 for this trademark*).
- 3,311,881. **TECCONNECT (BLOCK FORM).** MULTIVAC SEPP HAGGENMÜLLER GMBH & CO. KG, MULTIPLE CLASS, (INT. CLS. 9 AND 42), (U.S. CLS. 21, 23, 26, 36, 38, 100 AND 101). SN 78-777,835. PUB. 7-31-2007. FILED 12-21-2005.
- 3,311,886. **CIRQUE DE SOPHIE (BLOCK FORM).** UNIVERSAL DE DESARROLLOS ELECTRONICOS, S.A., MULTIPLE CLASS, (INT. CLS. 9 AND 28), (U.S. CLS. 21, 22, 23, 26, 36, 38 AND 50). SN 78-781,677. PUB. 7-31-2007. FILED 12-28-2005.

- 3,311,898 (*See Class 3 for this trademark*).
- 3,311,915. **I AND DESIGN**. PERIMETER HEALTH, LLC, (U.S. CLS. 21, 23, 26, 36 AND 38). SN 78-801,115. PUB. 4-10-2007. FILED 1-27-2006.
- 3,311,916. **LABGEN (BLOCK FORM)**. COLE-PARMER INSTRUMENT COMPANY, (U.S. CLS. 21, 23, 26, 36 AND 38). SN 78-801,117. PUB. 7-31-2007. FILED 1-27-2006.
- 3,311,922. **M-TECH (BLOCK FORM)**. STAR HEADLIGHT & LANTERN CO., INC., (U.S. CLS. 21, 23, 26, 36 AND 38). SN 78-803,406. PUB. 6-26-2007. FILED 1-31-2006.
- 3,311,932. **POLLYWORLD (STYLIZED)**. ORIGIN PRODUCTS LIMITED, MULTIPLE CLASS, (INT. CLS. 9, 16, 28 AND 41), (U.S. CLS. 2, 5, 21, 22, 23, 26, 29, 36, 37, 38, 50, 100, 101 AND 107). SN 78-809,991. PUB. 7-31-2007. FILED 2-8-2006.
- 3,311,954. **I FLEX (BLOCK FORM)**. ITALEE OPTICS, INC., (U.S. CLS. 21, 23, 26, 36 AND 38). SN 78-825,512. PUB. 7-31-2007. FILED 2-28-2006.
- 3,311,960. **OLIVE (BLOCK FORM)**. OLIVE, MARCEL, (U.S. CLS. 21, 23, 26, 36 AND 38). SN 78-831,225. PUB. 7-31-2007. FILED 3-7-2006.
- 3,311,972. **MEDVISOR AND DESIGN**. REALITY ENGINEERING, INC., (U.S. CLS. 21, 23, 26, 36 AND 38). SN 78-834,736. PUB. 7-31-2007. FILED 3-10-2006.
- 3,311,973. **SSL-EXPLORER (STYLIZED)**. 3SP LIMITED, (U.S. CLS. 21, 23, 26, 36 AND 38). SN 78-836,280. PUB. 7-31-2007. FILED 3-14-2006.
- 3,311,977. **N W AND DESIGN**. NAM WAH DEVELOPMENT LIMITED, MULTIPLE CLASS, (INT. CLS. 9 AND 12), (U.S. CLS. 19, 21, 23, 26, 31, 35, 36, 38 AND 44). SN 78-837,751. PUB. 7-17-2007. FILED 3-15-2006.
- 3,311,984. **MEDIACART (BLOCK FORM)**. MEDIA CART HOLDINGS, INC., MULTIPLE CLASS, (INT. CLS. 9, 12 AND 35), (U.S. CLS. 19, 21, 23, 26, 31, 35, 36, 38, 44, 100, 101 AND 102). SN 78-838,846. PUB. 7-31-2007. FILED 3-16-2006.
- 3,311,987. **RAPOR (BLOCK FORM)**. GVI SECURITY, INC., (U.S. CLS. 21, 23, 26, 36 AND 38). SN 78-840,974. PUB. 7-31-2007. FILED 3-20-2006.
- 3,311,989. **A AND DESIGN**. ADENUS GROUP, LLC, MULTIPLE CLASS, (INT. CLS. 9, 11, 40 AND 42), (U.S. CLS. 13, 21, 23, 26, 31, 34, 36, 38, 100, 101, 103 AND 106). SN 78-844,232. PUB. 7-31-2007. FILED 3-23-2006.
- 3,311,998. **VBS (BLOCK FORM)**. BOHEMIA INTERACTIVE STUDIO S.R.O., (U.S. CLS. 21, 23, 26, 36 AND 38). SN 78-846,882. PUB. 4-24-2007. FILED 3-27-2006.
- 3,312,000. **TRANSACTION BASED BUSINESS RULES (TBRR) (BLOCK FORM)**. EPAYABLES, LLC, MULTIPLE CLASS, (INT. CLS. 9 AND 42), (U.S. CLS. 21, 23, 26, 36, 38, 100 AND 101). SN 78-847,635. PUB. 7-31-2007. FILED 3-28-2006.
- 3,312,007. **HP (BLOCK FORM)**. INFRARED FIBER SYSTEMS, INC., (U.S. CLS. 21, 23, 26, 36 AND 38). SN 78-848,580. PUB. 7-31-2007. FILED 3-29-2006.
- 3,312,008. **RIGHT-ENERGY (BLOCK FORM)**. WRIGHTSOFT CORPORATION, (U.S. CLS. 21, 23, 26, 36 AND 38). SN 78-848,639. PUB. 7-31-2007. FILED 3-29-2006.
- 3,312,013. **EVENTINVENTORY (BLOCK FORM)**. EVENTINVENTORY.COM, INC., MULTIPLE CLASS, (INT. CLS. 9, 35 AND 42), (U.S. CLS. 21, 23, 26, 36, 38, 100, 101 AND 102). SN 78-851,601. PUB. 7-31-2007. FILED 3-31-2006.
- 3,312,016. **BB BETTER BASKETBALL AND DESIGN**. BETTER BASKETBALL, INC., (U.S. CLS. 21, 23, 26, 36 AND 38). SN 78-852,153. PUB. 7-31-2007. FILED 4-2-2006.
- 3,312,017. **TOMOVISION (BLOCK FORM)**. MAGIE VIRTUELLE, INC., DBA TOMOVISION, (U.S. CLS. 21, 23, 26, 36 AND 38). SN 78-852,414. PUB. 7-31-2007. FILED 4-3-2006.
- 3,312,020. **DICOMATIC (BLOCK FORM)**. MAGIE VIRTUELLE, INC., DBA TOMOVISION, (U.S. CLS. 21, 23, 26, 36 AND 38). SN 78-852,524. PUB. 7-31-2007. FILED 4-3-2006.
- 3,312,032. **MISCELLANEOUS DESIGN**. THE SECRETAN CENTER INC., MULTIPLE CLASS, (INT. CLS. 9, 16, 35, 41 AND 45), (U.S. CLS. 2, 5, 21, 22, 23, 26, 29, 36, 37, 38, 50, 100, 101, 102 AND 107). SN 78-855,263. PUB. 7-31-2007. FILED 4-6-2006.
- 3,312,035. **RT IDAHO RATIONAL TECHNOLOGY AND DESIGN**. RATIONAL TECHNOLOGY OF IDAHO, LLC, MULTIPLE CLASS, (INT. CLS. 9 AND 35), (U.S. CLS. 21, 23, 26, 36, 38, 100, 101 AND 102). SN 78-856,705. PUB. 7-31-2007. FILED 4-7-2006.
- 3,312,065. **GOLF KING (BLOCK FORM)**. NHN CORPORATION, MULTIPLE CLASS, (INT. CLS. 9 AND 41), (U.S. CLS. 21, 23, 26, 36, 38, 100, 101 AND 107). SN 78-865,477. PUB. 7-31-2007. FILED 4-20-2006.
- 3,312,076. **C AND DESIGN**. CHEMDAQ, INC., (U.S. CLS. 21, 23, 26, 36 AND 38). SN 78-867,386. PUB. 7-31-2007. FILED 4-22-2006.
- 3,312,082. **AUTOMOBILI LAMBORGHINI AND DESIGN**. AUTOMOBILI LAMBORGHINI HOLDING S.P.A., (U.S. CLS. 21, 23, 26, 36 AND 38). SN 78-870,133. PUB. 7-31-2007. FILED 4-26-2006.
- 3,312,085. **PROCABLE (STYLIZED)**. RADTECH, LLC, (U.S. CLS. 21, 23, 26, 36 AND 38). SN 78-870,936. PUB. 7-31-2007. FILED 4-27-2006.
- 3,312,096. **RUOK (BLOCK FORM)**. JOHNSON, BRUCE L., (U.S. CLS. 21, 23, 26, 36 AND 38). SN 78-872,300. PUB. 7-31-2007. FILED 4-28-2006.
- 3,312,100. **KLONDIKE DELUXE (BLOCK FORM)**. GOSUB 60, INC., (U.S. CLS. 21, 23, 26, 36 AND 38). SN 78-872,927. PUB. 7-31-2007. FILED 4-30-2006.
- 3,312,101. **FRECELL DELUXE (BLOCK FORM)**. GOSUB 60, INC., (U.S. CLS. 21, 23, 26, 36 AND 38). SN 78-872,929. PUB. 7-31-2007. FILED 4-30-2006.
- 3,312,107 (*See Class 8 for this trademark*).
- 3,312,108. **NATHAN AND DESIGN**. PENGUIN BRANDS, INC., MULTIPLE CLASS, (INT. CLS. 9, 18, 21 AND 25), (U.S. CLS. 1, 2, 3, 13, 21, 22, 23, 26, 29, 30, 33, 36, 38, 39, 40, 41 AND 50). SN 78-873,431. PUB. 7-31-2007. FILED 5-1-2006.
- 3,312,131. **SKYSPORTS (BLOCK FORM)**. SKYSPORTS INTERNATIONAL, INC., (U.S. CLS. 21, 23, 26, 36 AND 38). SN 78-876,193. PUB. 7-31-2007. FILED 5-4-2006.
- 3,312,139. **EXPERIENCE EXTRAORDINARY PERFORMANCES (BLOCK FORM)**. LRSMEDIA, LLC, (U.S. CLS. 21, 23, 26, 36 AND 38). SN 78-877,596. PUB. 7-31-2007. FILED 5-5-2006.
- 3,312,149. **UNIFI (BLOCK FORM)**. SMART TECHNOLOGIES INC., (U.S. CLS. 21, 23, 26, 36 AND 38). SN 78-878,563. PUB. 7-31-2007. FILED 5-8-2006.
- 3,312,155. **TRITON (BLOCK FORM)**. DIGITAL INTERACTIVE STREAMS, INC., MULTIPLE CLASS, (INT. CLS. 9 AND 41), (U.S. CLS. 21, 23, 26, 36, 38, 100, 101 AND 107). SN 78-880,153. PUB. 7-31-2007. FILED 5-10-2006.
- 3,312,166. **AMAZING MAGNETS (BLOCK FORM)**. AMAZING MAGNETS, LLC, (U.S. CLS. 21, 23, 26, 36 AND 38). SN 78-880,981. PUB. 7-31-2007. FILED 5-10-2006.
- 3,312,175. **NEVERGLARE (BLOCK FORM)**. NATIONAL VISION, INC., (U.S. CLS. 21, 23, 26, 36 AND 38). SN 78-881,989. PUB. 7-31-2007. FILED 5-11-2006.
- 3,312,180. **E AND DESIGN**. BLUE OCEAN TRADEMARKS NV, MULTIPLE CLASS, (INT. CLS. 9, 16, 25, 28, 33, 42 AND 44), (U.S. CLS. 2, 5, 21, 22, 23, 26, 29, 36, 37, 38, 39, 47, 49, 50, 100 AND 101). SN 78-882,752. PUB. 4-24-2007. FILED 5-12-2006.
- 3,312,185. **MISCELLANEOUS DESIGN**. SAND DUNE VENTURES, INC., MULTIPLE CLASS, (INT. CLS. 9, 35, 36, 40 AND 42), (U.S. CLS. 21, 23, 26, 36, 38, 100, 101, 102, 103 AND 106). SN 78-883,307. PUB. 7-31-2007. FILED 5-15-2006.
- 3,312,205. **CHURCH DOCTOR (BLOCK FORM)**. CHURCH GROWTH ANALYSIS AND LEARNING CENTER, MULTIPLE CLASS, (INT. CLS. 9, 35 AND 41), (U.S. CLS. 21, 23, 26, 36, 38, 100, 101, 102 AND 107). SN 78-885,969. PUB. 7-31-2007. FILED 5-17-2006.
- 3,312,206. **AUTHENTIC HENDRIX AND DESIGN**. EXPERIENCE HENDRIX, L.L.C., (U.S. CLS. 21, 23, 26, 36 AND 38). SN 78-886,099. PUB. 7-31-2007. FILED 5-17-2006.
- 3,312,212 (*See Class 3 for this trademark*).
- 3,312,222. **LAZER S WIZARD AND DESIGN**. 7HBF, LTD., (U.S. CLS. 21, 23, 26, 36 AND 38). SN 78-887,615. PUB. 7-31-2007. FILED 5-19-2006.
- 3,312,230. **N—SIGHT (STYLIZED)**. LIBRESTREAM TECHNOLOGIES INC., (U.S. CLS. 21, 23, 26, 36 AND 38). SN 78-890,285. PUB. 7-31-2007. FILED 5-23-2006.
- 3,312,234 (*See Class 3 for this trademark*).
- 3,312,236 (*See Class 5 for this trademark*).
- 3,312,239. **TINY TUMMIES (BLOCK FORM)**. DELMONICO, SANNA, MULTIPLE CLASS, (INT. CLS. 9 AND 16), (U.S. CLS. 2, 5, 21, 22, 23, 26, 29, 36, 37, 38 AND 50). SN 78-892,010. PUB. 7-31-2007. FILED 5-24-2006.
- 3,312,253. **INTERCEPT (BLOCK FORM)**. CABLETENNA

- CORP., (U.S. CLS. 21, 23, 26, 36 AND 38), SN 78-895,762. PUB. 7-31-2007. FILED 5-30-2006.
- 3,312,254. **EMPOWERGY (BLOCK FORM)**. EMPOWERGY, INC., (U.S. CLS. 21, 23, 26, 36 AND 38), SN 78-895,869. PUB. 6-26-2007. FILED 5-30-2006.
- 3,312,257. **ABOUTBUSINESS (BLOCK FORM)**. CITY OF EDINA, (U.S. CLS. 21, 23, 26, 36 AND 38), SN 78-896,629. PUB. 7-31-2007. FILED 5-31-2006.
- 3,312,262. **FASTRON (BLOCK FORM)**. GABOR R. FASKERTY, (U.S. CLS. 21, 23, 26, 36 AND 38), SN 78-897,187. PUB. 7-31-2007. FILED 5-31-2006.
- 3,312,280. **ISLAND FEVER (BLOCK FORM)**. DIGITAL PLAYGROUND, INC., (U.S. CLS. 21, 23, 26, 36 AND 38), SN 78-901,130. PUB. 7-31-2007. FILED 6-5-2006.
- 3,312,288. **SKIP THE LINE (BLOCK FORM)**. MOBO SYSTEMS, INC., (U.S. CLS. 21, 23, 26, 36 AND 38), SN 78-902,377. PUB. 7-31-2007. FILED 6-7-2006.
- 3,312,297. **HEIM (BLOCK FORM)**. HEIM DATA SYSTEMS, INC., (U.S. CLS. 21, 23, 26, 36 AND 38), SN 78-904,041. PUB. 7-31-2007. FILED 6-8-2006.
- 3,312,298. **REPLAY MUSIC (BLOCK FORM)**. APPLIAN TECHNOLOGIES INC, (U.S. CLS. 21, 23, 26, 36 AND 38), SN 78-904,213. PUB. 4-17-2007. FILED 6-8-2006.
- 3,312,300. **SIM (BLOCK FORM)**. MCKESSON HEALTH SOLUTIONS LLC, MULTIPLE CLASS, (INT. CLS. 9 AND 16), (U.S. CLS. 2, 5, 21, 22, 23, 26, 29, 36, 37, 38 AND 50), SN 78-904,663. PUB. 7-31-2007. FILED 6-9-2006.
- 3,312,316 (*See Class 7 for this trademark*).
- 3,312,331. **CARBIDE (BLOCK FORM)**. RVISION, INC., (U.S. CLS. 21, 23, 26, 36 AND 38), SN 78-909,575. PUB. 7-31-2007. FILED 6-15-2006.
- 3,312,336. **SUNFLOWER SYNCLINK (BLOCK FORM)**. ANAMS SYSTEMS CORPORATION, (U.S. CLS. 21, 23, 26, 36 AND 38), SN 78-910,591. PUB. 7-31-2007. FILED 6-16-2006.
- 3,312,337. **AIR, LAND AND SEA RESCUE (BLOCK FORM)**. MATTEL, INC., (U.S. CLS. 21, 23, 26, 36 AND 38), SN 78-911,117. PUB. 7-31-2007. FILED 6-19-2006.
- 3,312,345. **HALLOWELL EMC (BLOCK FORM)**. HALLOWELL ENGINEERING AND MANUFACTURING CORPORATION, MULTIPLE CLASS, (INT. CLS. 9 AND 10), (U.S. CLS. 21, 23, 26, 36, 38, 39 AND 44), SN 78-912,389. PUB. 7-31-2007. FILED 6-20-2006.
- 3,312,347. **ER (BLOCK FORM)**. ETYMOTIC RESEARCH, INC., MULTIPLE CLASS, (INT. CLS. 9 AND 10), (U.S. CLS. 21, 23, 26, 36, 38, 39 AND 44), SN 78-912,666. PUB. 7-31-2007. FILED 6-20-2006.
- 3,312,358. **GHOSTWRITER (BLOCK FORM)**. AUTOMATED SIGNATURE TECHNOLOGY, INC., (U.S. CLS. 21, 23, 26, 36 AND 38), SN 78-914,712. PUB. 4-24-2007. FILED 6-22-2006.
- 3,312,359. **I AND DESIGN**. EURASIA CONCEPTS, INC., MULTIPLE CLASS, (INT. CLS. 9, 11 AND 21), (U.S. CLS. 2, 13, 21, 23, 26, 29, 30, 31, 33, 34, 36, 38, 40 AND 50), SN 78-914,913. PUB. 7-31-2007. FILED 6-22-2006.
- 3,312,367. **SHAPELY SECRETS (BLOCK FORM)**. SAVVIER, L.P., (U.S. CLS. 21, 23, 26, 36 AND 38), SN 78-916,683. PUB. 7-31-2007. FILED 6-26-2006.
- 3,312,370. **URBAN JUNKET (BLOCK FORM)**. BUILDING E DESIGN, INC., (U.S. CLS. 21, 23, 26, 36 AND 38), SN 78-916,940. PUB. 7-31-2007. FILED 6-26-2006.
- 3,312,371. **MERCER VALVE COMPANY, INC. (BLOCK FORM)**. MERCER VALVE COMPANY, INC., (U.S. CLS. 21, 23, 26, 36 AND 38), SN 78-917,007. PUB. 7-31-2007. FILED 6-26-2006.
- 3,312,372. **MV (STYLIZED)**. MERCER VALVE COMPANY, INC., (U.S. CLS. 21, 23, 26, 36 AND 38), SN 78-917,055. PUB. 7-31-2007. FILED 6-26-2006.
- 3,312,390. **DOUWE EGBERTS (BLOCK FORM)**. SARA LEE/DE N.V., (U.S. CLS. 21, 23, 26, 36 AND 38), SN 78-921,022. PUB. 7-31-2007. FILED 6-30-2006.
- 3,312,395. **SEE IT RIGHT! (BLOCK FORM)**. SEE IT RIGHT! CORPORATION, MULTIPLE CLASS, (INT. CLS. 9 AND 16), (U.S. CLS. 2, 5, 21, 22, 23, 26, 29, 36, 37, 38 AND 50), SN 78-921,442. PUB. 7-31-2007. FILED 6-30-2006.
- 3,312,396. **SKYLINE (BLOCK FORM)**. SHELTERED WINGS, INC., (U.S. CLS. 21, 23, 26, 36 AND 38), SN 78-921,839. PUB. 7-31-2007. FILED 7-3-2006.
- 3,312,410. **RESIDENTIAL COMPONENT TECHNOLOGY HIGH VALUE (STYLIZED)**. MARSHALL & SWIFT/BOECKH, LLC, MULTIPLE CLASS, (INT. CLS. 9 AND 36), (U.S. CLS. 21, 23, 26, 36, 38, 100, 101 AND 102), SN 78-923,002. PUB. 7-31-2007. FILED 7-5-2006.
- 3,312,411. **RESIDENTIAL COMPONENT TECHNOLOGY MOBILE MANUFACTURED HOUSING (STYLIZED)**. MARSHALL & SWIFT/BOECKH, LLC, MULTIPLE CLASS, (INT. CLS. 9 AND 36), (U.S. CLS. 21, 23, 26, 36, 38, 100, 101 AND 102), SN 78-923,027. PUB. 7-31-2007. FILED 7-5-2006.
- 3,312,428. **PLANMATIC (BLOCK FORM)**. PLANMATIC, INC., (U.S. CLS. 21, 23, 26, 36 AND 38), SN 78-925,544. PUB. 7-31-2007. FILED 7-10-2006.
- 3,312,436. **BANK GOTHIC (BLOCK FORM)**. GROSSE POINTE GROUP, LLC, (U.S. CLS. 21, 23, 26, 36 AND 38), SN 78-926,599. PUB. 7-31-2007. FILED 7-11-2006.
- 3,312,438. **P AND DESIGN**. RWD TECHNOLOGIES, INC., (U.S. CLS. 21, 23, 26, 36 AND 38), SN 78-927,055. PUB. 7-31-2007. FILED 7-11-2006.
- 3,312,449. **KOOL KAT (BLOCK FORM)**. IGT, (U.S. CLS. 21, 23, 26, 36 AND 38), SN 78-928,329. PUB. 7-31-2007. FILED 7-12-2006.
- 3,312,458. **EYEQ (BLOCK FORM)**. J.H. FENNER & CO. LIMITED, (U.S. CLS. 21, 23, 26, 36 AND 38), SN 78-928,792. PUB. 7-31-2007. FILED 7-13-2006.
- 3,312,465. **CS (STYLIZED)**. MODERN LUXURY MEDIA, LLC, MULTIPLE CLASS, (INT. CLS. 9 AND 16), (U.S. CLS. 2, 5, 21, 22, 23, 26, 29, 36, 37, 38 AND 50), SN 78-930,642. PUB. 7-31-2007. FILED 7-17-2006.
- 3,312,476. **MISCELLANEOUS DESIGN**. STATUS PRO MASCHINENMESSTECHNIK GMBH, MULTIPLE CLASS, (INT. CLS. 9 AND 42), (U.S. CLS. 21, 23, 26, 36, 38, 100 AND 101), SN 78-931,354. PUB. 7-31-2007. FILED 7-17-2006.
- 3,312,486. **SALEM (BLOCK FORM)**. GRAHAM-WHITE MANUFACTURING CO., (U.S. CLS. 21, 23, 26, 36 AND 38), SN 78-933,104. PUB. 7-31-2007. FILED 7-19-2006.
- 3,312,496. **TUFFY (BLOCK FORM)**. GLYNLYON, INC., (U.S. CLS. 21, 23, 26, 36 AND 38), SN 78-935,198. PUB. 7-31-2007. FILED 7-21-2006.
- 3,312,500. **NUCLEOPUR (BLOCK FORM)**. BENEV COMPANY INC., (U.S. CLS. 21, 23, 26, 36 AND 38), SN 78-935,922. PUB. 7-31-2007. FILED 7-24-2006.
- 3,312,503. **ROBOFLAGGER (BLOCK FORM)**. FIRST CALL FLAGGING INC, (U.S. CLS. 21, 23, 26, 36 AND 38), SN 78-936,088. PUB. 7-31-2007. FILED 7-24-2006.
- 3,312,508. **CHEMIZER (BLOCK FORM)**. ROCHESTER MIDLAND CORPORATION, (U.S. CLS. 21, 23, 26, 36 AND 38), SN 78-937,036. PUB. 7-31-2007. FILED 7-25-2006.
- 3,312,528. **G AND DESIGN**. GILSON COMPANY, INC., (U.S. CLS. 21, 23, 26, 36 AND 38), SN 78-940,548. PUB. 7-31-2007. FILED 7-29-2006.
- 3,312,533. **MAGIC MAESTRO MUSIC AND DESIGN**. SIMON & SIMON LLC, (U.S. CLS. 21, 23, 26, 36 AND 38), SN 78-942,183. PUB. 7-31-2007. FILED 8-1-2006.
- 3,312,534. **STORIES IN MUSIC AND DESIGN**. SIMON & SIMON LLC, (U.S. CLS. 21, 23, 26, 36 AND 38), SN 78-942,186. PUB. 7-31-2007. FILED 8-1-2006.
- 3,312,539. **CYTOSCAPE (BLOCK FORM)**. THE CYTOSCAPE CONSORTIUM, (U.S. CLS. 21, 23, 26, 36 AND 38), SN 78-942,950. PUB. 7-31-2007. FILED 8-2-2006.
- 3,312,541 (*See Class 3 for this trademark*).
- 3,312,550. **NOMAD (BLOCK FORM)**. SHELTERED WINGS, INC., (U.S. CLS. 21, 23, 26, 36 AND 38), SN 78-945,109. PUB. 7-31-2007. FILED 8-4-2006.
- 3,312,552. **ARMOR BACKUP & RECOVERY (BLOCK FORM)**. KANE, TOM, JR., AND LOWENSTEIN, CHAIM, (U.S. CLS. 21, 23, 26, 36 AND 38), SN 78-945,726. PUB. 4-17-2007. FILED 8-5-2006.
- 3,312,564. **MIM AND DESIGN**. MIMVISTA CORP., (U.S. CLS. 21, 23, 26, 36 AND 38), SN 78-949,220. PUB. 7-31-2007. FILED 8-10-2006.
- 3,312,565. **ARMOR SECURITY (BLOCK FORM)**. KANE, TOM, JR., AND LOWENSTEIN, CHAIM, (U.S. CLS. 21, 23, 26, 36 AND 38), SN 78-949,575. PUB. 4-17-2007. FILED 8-10-2006.
- 3,312,566. **RÄZO (STYLIZED)**. CAR MATE MFG. CO., LTD., MULTIPLE CLASS, (INT. CLS. 9, 12, 14, 25 AND 34), (U.S. CLS. 2, 8, 9, 17, 19, 21, 22, 23, 26, 27, 28, 31, 35, 36, 38, 39, 44 AND 50), SN 78-949,675. PUB. 7-31-2007. FILED 8-10-2006.
- 3,312,568. **MISCELLANEOUS DESIGN**. MSTAR SEMICONDUCTOR, INC., (U.S. CLS. 21, 23, 26, 36 AND 38), SN 78-

- 950,095. PUB. 7-31-2007. FILED 8-11-2006.
- 3,312,570 (*See Class 7 for this trademark*).
- 3,312,571. **ARMOR PROTECTION (BLOCK FORM)**. KANE, TOM, JR., AND LOWENSTEIN, CHAIM, (U.S. CLS. 21, 23, 26, 36 AND 38). SN 78-950,640. PUB. 4-17-2007. FILED 8-11-2006.
- 3,312,572. **ARMOR SUITE (BLOCK FORM)**. KANE, TOM, JR., AND LOWENSTEIN, CHAIM, (U.S. CLS. 21, 23, 26, 36 AND 38). SN 78-950,918. PUB. 4-17-2007. FILED 8-12-2006.
- 3,312,573. **ARMOR DATA (BLOCK FORM)**. KANE, TOM, JR., AND LOWENSTEIN, CHAIM, (U.S. CLS. 21, 23, 26, 36 AND 38). SN 78-951,239. PUB. 4-17-2007. FILED 8-14-2006.
- 3,312,576. **MISCELLANEOUS DESIGN**. LEVITON MANUFACTURING CO., INC., (U.S. CLS. 21, 23, 26, 36 AND 38). SN 78-951,481. PUB. 7-31-2007. FILED 8-14-2006.
- 3,312,585. **QUELLAN (BLOCK FORM)**. QUELLAN INCORPORATED, MULTIPLE CLASS, (INT. CLS. 9 AND 42), (U.S. CLS. 21, 23, 26, 36, 38, 100 AND 101). SN 78-954,852. PUB. 7-31-2007. FILED 8-17-2006.
- 3,312,606. **SCORPION POD (BLOCK FORM)**. KENDALL, CHARLES S., (U.S. CLS. 21, 23, 26, 36 AND 38). SN 78-959,634. PUB. 7-31-2007. FILED 8-24-2006.
- 3,312,627. **METAMANAGER (BLOCK FORM)**. BRIGHTSTAR PARTNERS, INC., (U.S. CLS. 21, 23, 26, 36 AND 38). SN 78-961,811. PUB. 7-31-2007. FILED 8-28-2006.
- 3,312,650. **DISTILLATION STATION (BLOCK FORM)**. AQUAMEDIA CORP, MULTIPLE CLASS, (INT. CLS. 9 AND 35), (U.S. CLS. 21, 23, 26, 36, 38, 100, 101 AND 102). SN 78-965,573. PUB. 7-31-2007. FILED 8-31-2006.
- 3,312,659. **WIDELOAD (BLOCK FORM)**. WIDELOAD GAMES, INC., (U.S. CLS. 21, 23, 26, 36 AND 38). SN 78-968,799. PUB. 7-31-2007. FILED 9-7-2006.
- 3,312,665. **SMS 4D FOUR DISCRETES AND DESIGN**. ELYNX TECHNOLOGIES, L.L.C., (U.S. CLS. 21, 23, 26, 36 AND 38). SN 78-969,336. PUB. 7-31-2007. FILED 9-7-2006.
- 3,312,671. **AUTO-PANATAR (BLOCK FORM)**. PANAVISION INTERNATIONAL, L.P., (U.S. CLS. 21, 23, 26, 36 AND 38). SN 78-970,605. PUB. 7-31-2007. FILED 9-8-2006.
- 3,312,681. **MKCONNECTIONS (BLOCK FORM)**. MARY KAY INC., (U.S. CLS. 21, 23, 26, 36 AND 38). SN 78-973,215. PUB. 7-31-2007. FILED 9-13-2006.
- 3,312,683. **ARGUS VES BY EFKON USA AND DESIGN**. EFKON USA, INC., (U.S. CLS. 21, 23, 26, 36 AND 38). SN 78-973,801. PUB. 7-31-2007. FILED 9-13-2006.
- 3,312,685. **EMC PARADIGM (BLOCK FORM)**. EMC CORPORATION, MULTIPLE CLASS, (INT. CLS. 9 AND 16), (U.S. CLS. 2, 5, 21, 22, 23, 26, 29, 36, 37, 38 AND 50). SN 78-974,138. PUB. 2-20-2007. FILED 9-14-2006.
- 3,312,690. **TECHDISPLAY AND DESIGN**. EYEFI DIGITAL TV, INC., (U.S. CLS. 21, 23, 26, 36 AND 38). SN 78-978,272. PUB. 7-31-2007. FILED 2-24-2006.
- 3,312,701 (*See Class 1 for this trademark*).
- 3,312,703. **DRAWINGS (STYLIZED)**. WINGS SYSTEMS LIMITED, MULTIPLE CLASS, (INT. CLS. 9, 16, 23, 26, 41 AND 42), (U.S. CLS. 2, 5, 21, 22, 23, 26, 29, 36, 37, 38, 39, 40, 42, 43, 50, 100, 101 AND 107). SN 79-006,533. PUB. 7-31-2007. FILED 3-26-2004.
- 3,312,711. **EASYPAD (BLOCK FORM)**. SIRONA DENTAL SYSTEMS GMBH, MULTIPLE CLASS, (INT. CLS. 9 AND 10), (U.S. CLS. 21, 23, 26, 36, 38, 39 AND 44). SN 79-014,094. PUB. 7-31-2007. FILED 4-25-2005.
- 3,312,714. **DATATRACEDNA (BLOCK FORM)**. DATATRACE DNA PTY LIMITED, (U.S. CLS. 21, 23, 26, 36 AND 38). SN 79-014,457. PUB. 7-31-2007. FILED 8-19-2005.
- 3,312,717 (*See Class 1 for this trademark*).
- 3,312,720. **MISCELLANEOUS DESIGN**. LANGCHAO GROUP CO., LTD (LANGCHAO JITUAN YOUXIAN GONGSI), MULTIPLE CLASS, (INT. CLS. 9 AND 42), (U.S. CLS. 21, 23, 26, 36, 38, 100 AND 101). SN 79-016,017. PUB. 7-31-2007. FILED 4-28-2005.
- 3,312,721. **ARCCOS COPY CONTROL AND DESIGN**. SONY DADC AUSTRIA AG, MULTIPLE CLASS, (INT. CLS. 9 AND 42), (U.S. CLS. 21, 23, 26, 36, 38, 100 AND 101). SN 79-016,026. PUB. 7-31-2007. FILED 9-15-2005.
- 3,312,722. **MISCELLANEOUS DESIGN**. GILLI S.R.L., MULTIPLE CLASS, (INT. CLS. 9, 14, 18 AND 25), (U.S. CLS. 1, 2, 3, 21, 22, 23, 26, 27, 28, 36, 38, 39, 41 AND 50). SN 79-016,429. PUB. 4-24-2007. FILED 8-18-2005.
- 3,312,723 (*See Class 7 for this trademark*).
- 3,312,727. **PIDION (BLOCK FORM)**. BLUEBIRD SOFT, (U.S. CLS. 21, 23, 26, 36 AND 38). SN 79-017,057. PUB. 7-31-2007. FILED 8-24-2005.
- 3,312,729. **LISTAN (BLOCK FORM)**. LISTAN GMBH & CO. KG, MULTIPLE CLASS, (INT. CLS. 9, 38 AND 42), (U.S. CLS. 21, 23, 26, 36, 38, 100, 101 AND 104). SN 79-018,644. PUB. 7-31-2007. FILED 10-18-2005.
- 3,312,731 (*See Class 7 for this trademark*).
- 3,312,733. **MARK AND DESIGN**. MARK INFORMATION A/S, MULTIPLE CLASS, (INT. CLS. 9, 16, 35, 36, 37 AND 42), (U.S. CLS. 2, 5, 21, 22, 23, 26, 29, 36, 37, 38, 50, 100, 101, 102, 103 AND 106). SN 79-019,172. PUB. 7-31-2007. FILED 3-21-2005.
- 3,312,735. **HEALTHE AND DESIGN**. HEALTHE PTY LTD ACN 104 814 842, MULTIPLE CLASS, (INT. CLS. 9, 35, 36 AND 44), (U.S. CLS. 21, 23, 26, 36, 38, 100, 101 AND 102). SN 79-019,429. PUB. 7-31-2007. FILED 10-21-2004.
- 3,312,738. **FORCEROBOT (BLOCK FORM)**. NAMBITION GMBH, (U.S. CLS. 21, 23, 26, 36 AND 38). SN 79-019,735. PUB. 7-31-2007. FILED 11-15-2005.
- 3,312,739. **SUMMER THE SURF GIRL (BLOCK FORM)**. SUMMER THE SURF GIRL LIMITED, MULTIPLE CLASS, (INT. CLS. 9, 16, 21, 25 AND 28), (U.S. CLS. 2, 5, 13, 21, 22, 23, 26, 29, 30, 33, 36, 37, 38, 39, 40 AND 50). SN 79-020,059. PUB. 7-31-2007. FILED 6-14-2005.
- 3,312,740. **IMAGELINK (BLOCK FORM)**. KODAK S.A.; (SO-CIÉTÉ ANONYME FRANÇAISE), (U.S. CLS. 21, 23, 26, 36 AND 38). SN 79-020,468. PUB. 7-31-2007. FILED 9-9-2005.
- 3,312,741 (*See Class 6 for this trademark*).
- 3,312,742. **MISCELLANEOUS DESIGN**. TELECOM ITALIA S.P.A., MULTIPLE CLASS, (INT. CLS. 9, 38 AND 41), (U.S. CLS. 21, 23, 26, 36, 38, 100, 101, 104 AND 107). SN 79-020,738. PUB. 7-31-2007. FILED 10-3-2005.
- 3,312,746. **VOLKSBRILLE (STYLIZED)**. ICL BERLIN BRILLEN GMBH, MULTIPLE CLASS, (INT. CLS. 9 AND 35), (U.S. CLS. 21, 23, 26, 36, 38, 100, 101 AND 102). SN 79-020,903. PUB. 2-20-2007. FILED 12-29-2005.
- 3,312,749 (*See Class 7 for this trademark*).
- 3,312,750 (*See Class 3 for this trademark*).
- 3,312,751. **HOME-CARE AND DESIGN**. CARFO TRADING S.R.L., (U.S. CLS. 21, 23, 26, 36 AND 38). SN 79-021,740. PUB. 7-17-2007. FILED 12-24-2005.
- 3,312,752. **MISCELLANEOUS DESIGN**. KHOUGASSIAN SACHA; KHOUGASSIAN SANDIE, AND KHOUGASSIAN MICHA; ROZEZ CLARA, ÉPOUSE KHOUGASSIAN, (U.S. CLS. 21, 23, 26, 36 AND 38). SN 79-021,767. PUB. 7-31-2007. FILED 2-17-2006.
- 3,312,753. **PRECIOUS (BLOCK FORM)**. KHOUGASSIAN SACHA; KHOUGASSIAN SANDIE, AND KHOUGASSIAN MICHA; ROZEZ CLARA, ÉPOUSE KHOUGASSIAN, (U.S. CLS. 21, 23, 26, 36 AND 38). SN 79-021,768. PUB. 7-31-2007. FILED 2-17-2006.
- 3,312,756 (*See Class 6 for this trademark*).
- 3,312,758. **OPTIMISO (BLOCK FORM)**. OPTIMISO SA, MULTIPLE CLASS, (INT. CLS. 9, 35, 41 AND 42), (U.S. CLS. 21, 23, 26, 36, 38, 100, 101, 102 AND 107). SN 79-023,041. PUB. 4-10-2007. FILED 2-10-2006.
- 3,312,764. **RFID AND DESIGN**. DATAMARS SA, (U.S. CLS. 21, 23, 26, 36 AND 38). SN 79-024,175. PUB. 7-31-2007. FILED 4-25-2006.
- 3,312,782. **WITHOUT WARNING (BLOCK FORM)**. CE EUROPE LIMITED, MULTIPLE CLASS, (INT. CLS. 9, 16, 28 AND 41), (U.S. CLS. 2, 5, 21, 22, 23, 26, 29, 36, 37, 38, 50, 100, 101 AND 107). SN 79-025,082. PUB. 7-31-2007. FILED 6-29-2005.
- 3,312,784. **ORIENT PEARL AND DESIGN**. NINGBO ORIENT GROUP CO., LTD; (NINGBO DONGFANG JITUAN; YOUXIAN GONGSI), (U.S. CLS. 21, 23, 26, 36 AND 38). SN 79-025,143. PUB. 4-17-2007. FILED 4-13-2006.
- 3,312,787. **MAY BERLIN (STYLIZED)**. SCHIMMEL VERWALTUNGSGESELLSCHAFT MBH, MULTIPLE CLASS, (INT. CLS. 9 AND 15), (U.S. CLS. 2, 21, 23, 26, 36 AND 38). SN 79-025,477. PUB. 7-31-2007. FILED 6-6-2006.
- 3,312,788. **ACTIVAERO (STYLIZED)**. ACTIVAERO GMBH, MULTIPLE CLASS, (INT. CLS. 9, 10, 42 AND 44), (U.S. CLS. 21, 23, 26, 36, 38, 39, 44, 100 AND 101). SN 79-025,718. PUB. 7-31-2007. FILED 4-26-2006.

- 3,312,789 (*See Class 7 for this trademark*).
- 3,312,794. **DON'T BE A USER. BE A CONGSTER (BLOCK FORM)**. DEUTSCHE TELEKOM AG, MULTIPLE CLASS, (INT. CLS. 9, 16, 25, 28, 35, 36, 37, 38, 41 AND 42), (U.S. CLS. 2, 5, 21, 22, 23, 26, 29, 36, 37, 38, 39, 50, 100, 101, 102, 103, 104, 106 AND 107). SN 79-025,973. PUB. 7-31-2007. FILED 8-26-2005.
- 3,312,799. **RSI ALARM (BLOCK FORM)**. RADIO SYSTEMES INGENIERIE; (SOCIÉTÉ ANONYME), MULTIPLE CLASS, (INT. CLS. 9, 37, 38, 42 AND 45), (U.S. CLS. 21, 23, 26, 36, 38, 100, 101, 103, 104 AND 106). SN 79-026,192. PUB. 7-31-2007. FILED 3-29-2006.
- 3,312,806. **CAPRESCUE (STYLIZED)**. MEDUG UWE GÜNTHER E.K., (U.S. CLS. 21, 23, 26, 36 AND 38). SN 79-026,677. PUB. 7-31-2007. FILED 6-19-2006.
- 3,312,816. **JUSE-STATWORKS (STYLIZED)**. KABUSHIKI-KAISHA NIHON; KAGAKU GIJUTSU KENSHUJO, (U.S. CLS. 21, 23, 26, 36 AND 38). SN 79-027,171. PUB. 7-31-2007. FILED 5-29-2006.
- 3,312,818 (*See Class 1 for this trademark*).
- 3,312,820. **BRANDING YOU (BLOCK FORM)**. KABUSHIKI KAISHA FAST RETAILING, MULTIPLE CLASS, (INT. CLS. 9, 18, 24 AND 25), (U.S. CLS. 1, 2, 3, 21, 22, 23, 26, 36, 38, 39, 41, 42 AND 50). SN 79-027,265. PUB. 7-31-2007. FILED 6-30-2006.
- 3,312,823 (*See Class 7 for this trademark*).
- 3,312,826 (*See Class 6 for this trademark*).
- 3,312,829. **SISTEMA ECODECO (STYLIZED)**. ECODECO S.R.L., MULTIPLE CLASS, (INT. CLS. 9, 40 AND 42), (U.S. CLS. 21, 23, 26, 36, 38, 100, 101, 103 AND 106). SN 79-027,577. PUB. 7-31-2007. FILED 4-26-2006.
- 3,312,830. **IQ MOVE INTEGRATED QUALITY MANAGEMENT AND DESIGN**. LUFTHANSA TECHNIK AG, MULTIPLE CLASS, (INT. CLS. 9, 35, 41 AND 42), (U.S. CLS. 21, 23, 26, 36, 38, 100, 101, 102 AND 107). SN 79-027,583. PUB. 7-31-2007. FILED 3-31-2006.
- 3,312,833 (*See Class 8 for this trademark*).
- 3,312,839 (*See Class 7 for this trademark*).
- 3,312,840 (*See Class 7 for this trademark*).
- 3,312,842. **MY-SOUND (BLOCK FORM)**. MICROSOUND A/S, MULTIPLE CLASS, (INT. CLS. 9 AND 10), (U.S. CLS. 21, 23, 26, 36, 38, 39 AND 44). SN 79-028,000. PUB. 7-31-2007. FILED 3-31-2006.
- 3,312,850. **FOODPRODUCTIONDAILY (BLOCK FORM)**. DECISION NEWS MEDIA SAS, MULTIPLE CLASS, (INT. CLS. 9, 35, 38, 41 AND 42), (U.S. CLS. 21, 23, 26, 36, 38, 100, 101, 102, 104 AND 107). SN 79-028,460. PUB. 7-31-2007. FILED 3-24-2006.
- 3,312,853. **ROUSEN AND DESIGN**. CITUS CO., LTD., (U.S. CLS. 21, 23, 26, 36 AND 38). SN 79-028,664. PUB. 7-31-2007. FILED 6-15-2006.
- 3,312,864. **R AND DESIGN**. ZHANG YUHUI, (U.S. CLS. 21, 23, 26, 36 AND 38). SN 79-028,966. PUB. 7-31-2007. FILED 8-14-2006.
- 3,312,865. **PREMID (BLOCK FORM)**. KAPSCH TRAFFICOM AG, MULTIPLE CLASS, (INT. CLS. 9, 36 AND 37), (U.S. CLS. 21, 23, 26, 36, 38, 100, 101, 102, 103 AND 106). SN 79-028,976. PUB. 7-31-2007. FILED 5-9-2006.
- 3,312,866. **MACNA (BLOCK FORM)**. SPLASH DESIGN B.V., MULTIPLE CLASS, (INT. CLS. 9, 18 AND 25), (U.S. CLS. 1, 2, 3, 21, 22, 23, 26, 36, 38, 39 AND 41). SN 79-028,979. PUB. 7-31-2007. FILED 2-8-2006.
- 3,312,867. **NTR GLOBAL AND DESIGN**. NTR, S.L., MULTIPLE CLASS, (INT. CLS. 9, 38 AND 42), (U.S. CLS. 21, 23, 26, 36, 38, 100, 101 AND 104). SN 79-029,064. PUB. 7-31-2007. FILED 9-13-2006.
- 3,312,870. **STARSIM (BLOCK FORM)**. GIESECKE & DEVRIENT GMBH, (U.S. CLS. 21, 23, 26, 36 AND 38). SN 79-029,176. PUB. 7-31-2007. FILED 7-14-2006.
- 3,312,873. **VELP SCIENTIFICA AND DESIGN**. VELP SCIENTIFICA S.R.L., (U.S. CLS. 21, 23, 26, 36 AND 38). SN 79-029,507. PUB. 7-31-2007. FILED 7-6-2006.
- 3,312,874. **THE SECRET (BLOCK FORM)**. PRIME TIME PRODUCTIONS HOLDINGS PTY LTD, MULTIPLE CLASS, (INT. CLS. 9, 16, 28 AND 41), (U.S. CLS. 2, 5, 21, 22, 23, 26, 29, 36, 37, 38, 50, 100, 101 AND 107). SN 79-029,527. PUB. 7-31-2007. FILED 1-27-2006.
- 3,312,876 (*See Class 3 for this trademark*).
- 3,312,879. **RELACOM AND DESIGN**. RELACOM INTERNATIONAL HOLDING AB, MULTIPLE CLASS, (INT. CLS. 9, 37, 38 AND 42), (U.S. CLS. 21, 23, 26, 36, 38, 100, 101, 103, 104 AND 106). SN 79-029,630. PUB. 7-31-2007. FILED 2-2-2006.
- 3,312,880. **BUENAS TARDES AND DESIGN**. BIVIGAL S.R.L., MULTIPLE CLASS, (INT. CLS. 9, 18, 24 AND 25), (U.S. CLS. 1, 2, 3, 21, 22, 23, 26, 36, 38, 39, 41, 42 AND 50). SN 79-029,635. PUB. 7-31-2007. FILED 5-3-2006.
- 3,312,886 (*See Class 6 for this trademark*).
- 3,312,890. **TRACKID (BLOCK FORM)**. SONY ERICSSON MOBILE COMMUNICATIONS AB, (U.S. CLS. 21, 23, 26, 36 AND 38). SN 79-029,985. PUB. 7-31-2007. FILED 9-8-2006.
- 3,312,891. **DR. BOTT (BLOCK FORM)**. DR. BOTT KG, MULTIPLE CLASS, (INT. CLS. 9, 18 AND 42), (U.S. CLS. 1, 2, 3, 21, 22, 23, 26, 36, 38, 41, 100 AND 101). SN 79-030,004. PUB. 7-31-2007. FILED 12-28-2005.
- 3,312,898. **ST.EMILE (BLOCK FORM)**. JOSEF REIS GMBH & CO. KG, MULTIPLE CLASS, (INT. CLS. 9, 18 AND 25), (U.S. CLS. 1, 2, 3, 21, 22, 23, 26, 36, 38, 39 AND 41). SN 79-030,125. PUB. 7-31-2007. FILED 7-31-2006.
- 3,312,901. **TELEPO (STYLIZED)**. TELEPO AB, MULTIPLE CLASS, (INT. CLS. 9, 38 AND 42), (U.S. CLS. 21, 23, 26, 36, 38, 100, 101 AND 104). SN 79-030,307. PUB. 7-31-2007. FILED 9-21-2006.
- 3,312,902. **INFRASCAN (BLOCK FORM)**. CLIPSAL AUSTRALIA PTY LTD, (U.S. CLS. 21, 23, 26, 36 AND 38). SN 79-030,427. PUB. 7-31-2007. FILED 10-9-2006.
- 3,312,904. **MOONWALK (BLOCK FORM)**. MOONWALK UNIVERSAL PTY LTD, MULTIPLE CLASS, (INT. CLS. 9 AND 42), (U.S. CLS. 21, 23, 26, 36, 38, 100 AND 101). SN 79-030,451. PUB. 7-31-2007. FILED 3-8-2006.
- 3,312,905. **PRIMOZONE (BLOCK FORM)**. PRIMOZONE PRODUCTION AB, MULTIPLE CLASS, (INT. CLS. 9, 11 AND 40), (U.S. CLS. 13, 21, 23, 26, 31, 34, 36, 38, 100, 103 AND 106). SN 79-030,497. PUB. 7-31-2007. FILED 6-23-2006.
- 3,312,910. **WELCOM WORLD ELECTRONIC COMMUNITY (STYLIZED)**. WORLD ECONOMIC FORUM, MULTIPLE CLASS, (INT. CLS. 9, 16 AND 38), (U.S. CLS. 2, 5, 21, 22, 23, 26, 29, 36, 37, 38, 50, 100, 101 AND 104). SN 79-030,731. PUB. 7-31-2007. FILED 8-11-2006.
- 3,312,912 (*See Class 7 for this trademark*).
- 3,312,915. **IMAGE SCIENCE AND DESIGN**. MATSUSADA PRECISION, INC., (U.S. CLS. 21, 23, 26, 36 AND 38). SN 79-031,162. PUB. 7-31-2007. FILED 6-8-2006.
- 3,312,920 (*See Class 1 for this trademark*).
- 3,312,926 (*See Class 5 for this trademark*).
- 3,312,930. **LODESTONE (BLOCK FORM)**. THE LODESTONE GUITAR COMPANY LIMITED, MULTIPLE CLASS, (INT. CLS. 9 AND 15), (U.S. CLS. 2, 21, 23, 26, 36 AND 38). SN 79-032,268. PUB. 7-31-2007. FILED 10-9-2006.
- 3,312,931. **PILOT AND DESIGN**. LI HAIBO, (U.S. CLS. 21, 23, 26, 36 AND 38). SN 79-032,334. PUB. 7-31-2007. FILED 11-28-2006.
- 3,312,936. **HEDLOC (BLOCK FORM)**. HEDLOC PTY LTD, MULTIPLE CLASS, (INT. CLS. 9, 35 AND 42), (U.S. CLS. 21, 23, 26, 36, 38, 100, 101 AND 102). SN 79-032,670. PUB. 7-31-2007. FILED 8-11-2006.
- 3,312,942 (*See Class 7 for this trademark*).
- 3,312,943. **ONESTO (STYLIZED)**. YUEQING ONESTO ELECTRIC CO., LTD., (U.S. CLS. 21, 23, 26, 36 AND 38). SN 79-033,237. PUB. 7-31-2007. FILED 6-6-2006.
- 3,312,944. **FAITH CONNEXION (STYLIZED)**. FAITH CONNEXION, (U.S. CLS. 21, 23, 26, 36 AND 38). SN 79-033,393. PUB. 7-31-2007. FILED 12-1-2006.
- 3,312,946. **NTR SUPPORT AND DESIGN**. NTR, S.L., MULTIPLE CLASS, (INT. CLS. 9, 38 AND 42), (U.S. CLS. 21, 23, 26, 36, 38, 100, 101 AND 104). SN 79-033,485. PUB. 7-31-2007. FILED 9-28-2006.
- 3,312,948. **LUXOFT AND DESIGN**. "LUXOFT"; LIMITED LIABILITY COMPANY, MULTIPLE CLASS, (INT. CLS. 9, 35, 37 AND 42), (U.S. CLS. 21, 23, 26, 36, 38, 100, 101, 102, 103 AND 106). SN 79-033,930. PUB. 7-31-2007. FILED 11-24-2006.
- 3,312,950. **V-LUX (BLOCK FORM)**. LEICA CAMERA AG, (U.S. CLS. 21, 23, 26, 36 AND 38). SN 79-034,153. PUB. 6-12-2007. FILED 11-13-2006.
- 3,312,965. **KONVIVIO (BLOCK FORM)**. N&W GLOBAL VENDING S.P.A., (U.S. CLS. 21, 23, 26, 36 AND 38). SN 79-035,537. PUB. 7-31-2007. FILED 2-1-2007.

3,312,966. **KOBALTO (BLOCK FORM)**. N&W GLOBAL VENDING S.P.A., (U.S. CLS. 21, 23, 26, 36 AND 38). SN 79-035,547. PUB. 7-31-2007. FILED 2-1-2007.

3,312,977. **KEDGE AND DESIGN**. KEDGE HOLDING B.V., MULTIPLE CLASS, (INT. CLS. 9 AND 19), (U.S. CLS. 1, 12, 21, 23, 26, 33, 36, 38 AND 50). SN 79-036,887. PUB. 7-31-2007. FILED 12-12-2006.

CLASS 10—MEDICAL APPARATUS

3,310,199 (*See Class 9 for this trademark*).

3,310,230 (*See Class 7 for this trademark*).

3,310,241 (*See Class 8 for this trademark*).

3,310,260. **NOVAVISION VRT (BLOCK FORM)**. NOVAVISION, INC., MULTIPLE CLASS, (INT. CLS. 10, 16, 41 AND 44), (U.S. CLS. 2, 5, 22, 23, 26, 29, 37, 38, 39, 44, 50, 100, 101 AND 107). SN 76-644,183. PUB. 7-31-2007. FILED 8-3-2005.

3,310,306. **THE SPIO WORKS (BLOCK FORM)**. DYNAMIC FAMILY SERVICES, (U.S. CLS. 26, 39 AND 44). SN 76-659,123. PUB. 7-31-2007. FILED 4-26-2006.

3,310,310 (*See Class 9 for this trademark*).

3,310,311. **OPERA E-SCAN DEDICATED MRI AND DESIGN**. ESAOTE, S.P.A., (U.S. CLS. 26, 39 AND 44). SN 76-659,779. PUB. 6-26-2007. FILED 5-9-2006.

3,310,476. **PROHALER (BLOCK FORM)**. VALOIS SAS, (U.S. CLS. 26, 39 AND 44). SN 77-009,651. PUB. 7-31-2007. FILED 9-28-2006.

3,310,564. **OTTER TANK (BLOCK FORM)**. RAMVAC DENTAL PRODUCTS, INC., (U.S. CLS. 26, 39 AND 44). SN 77-023,538. PUB. 7-31-2007. FILED 10-18-2006.

3,310,724. **GRIDMESH (BLOCK FORM)**. MEDTRONIC, INC., (U.S. CLS. 26, 39 AND 44). SN 77-050,980. PUB. 7-31-2007. FILED 11-27-2006.

3,310,756 (*See Class 9 for this trademark*).

3,310,758 (*See Class 9 for this trademark*).

3,310,763 (*See Class 1 for this trademark*).

3,310,817. **VISICHART (BLOCK FORM)**. TOPCON MEDICAL SYSTEMS, INC., (U.S. CLS. 26, 39 AND 44). SN 77-063,349. PUB. 7-31-2007. FILED 12-13-2006.

3,310,922. **PEDI-KIT (BLOCK FORM)**. ADVANTAGE GEAR, INC., (U.S. CLS. 26, 39 AND 44). SN 77-069,820. PUB. 7-31-2007. FILED 12-21-2006.

3,310,924. **PEDI-AIRWAY (BLOCK FORM)**. ADVANTAGE GEAR, INC., (U.S. CLS. 26, 39 AND 44). SN 77-069,901. PUB. 7-31-2007. FILED 12-21-2006.

3,311,010. **BLACK DIAMOND (BLOCK FORM)**. CLASS ONE ORTHODONTICS, INC., (U.S. CLS. 26, 39 AND 44). SN 77-072,437. PUB. 7-31-2007. FILED 12-28-2006.

3,311,089. **LIVE LARGE WITH A TWIST (BLOCK FORM)**. CHURCH & DWIGHT VIRGINIA CO., INC., (U.S. CLS. 26, 39 AND 44). SN 77-074,125. PUB. 7-31-2007. FILED 1-2-2007.

3,311,112. **FIBERFORM (BLOCK FORM)**. CHESAPEAKE MEDICAL PRODUCTS, INC., (U.S. CLS. 26, 39 AND 44). SN 77-074,886. PUB. 7-31-2007. FILED 1-3-2007.

3,311,130. **EYEMAG (BLOCK FORM)**. CARL ZEISS AG, (U.S. CLS. 26, 39 AND 44). SN 77-076,304. PUB. 7-31-2007. FILED 1-4-2007.

3,311,146. **ORTHOMARK (BLOCK FORM)**. ROLLESOLUTIONS, INC., (U.S. CLS. 26, 39 AND 44). SN 77-077,056. PUB. 7-31-2007. FILED 1-5-2007.

3,311,270. **MARCO HD EYE EXAM (BLOCK FORM)**. MARCO OPHTHALMIC, INC., (U.S. CLS. 26, 39 AND 44). SN 77-088,963. PUB. 7-31-2007. FILED 1-23-2007.

3,311,294. **SOCKETCONE (BLOCK FORM)**. CHESAPEAKE MEDICAL PRODUCTS, INC., (U.S. CLS. 26, 39 AND 44). SN 77-090,815. PUB. 7-31-2007. FILED 1-25-2007.

3,311,431 (*See Class 5 for this trademark*).

3,311,583. **QUADRASPHERE (BLOCK FORM)**. BIOSPHERE MEDICAL, INC., (U.S. CLS. 26, 39 AND 44). SN 77-128,906. PUB. 7-31-2007. FILED 3-12-2007.

3,311,594. **KO (BLOCK FORM)**. DRUG DETECTION DEVICES, LTD., (U.S. CLS. 26, 39 AND 44). SN 77-132,253. PUB. 7-31-2007. FILED 3-15-2007.

3,311,607. **EARSCAN (BLOCK FORM)**. MICRO AUDIO-METRICS CORP., (U.S. CLS. 26, 39 AND 44). SN 77-146,002. PUB. 7-31-2007. FILED 4-2-2007.

3,311,608. **MICROLAB (BLOCK FORM)**. MICRO AUDIO-METRICS CORP., (U.S. CLS. 26, 39 AND 44). SN 77-146,021. PUB. 7-31-2007. FILED 4-2-2007.

3,311,618. **WORKHORSE (BLOCK FORM)**. ANGIODYNAMICS, INC., (U.S. CLS. 26, 39 AND 44). SN 77-153,690. PUB. 7-31-2007. FILED 4-11-2007.

3,311,631 (*See Class 1 for this trademark*).

3,311,664 (*See Class 3 for this trademark*).

3,311,750 (*See Class 5 for this trademark*).

3,311,768. **MTS AND DESIGN**. MTS EUROPE GMBH, MULTIPLE CLASS, (INT. CLS. 10 AND 42), (U.S. CLS. 26, 39, 44, 100 AND 101). SN 78-693,229. PUB. 7-31-2007. FILED 8-16-2005.

3,311,849 (*See Class 9 for this trademark*).

3,311,880. **CBUST (BLOCK FORM)**. HELIX MEDICAL SYSTEMS LTD., (U.S. CLS. 26, 39 AND 44). SN 78-776,979. PUB. 7-31-2007. FILED 12-20-2005.

3,311,906. **ITL AND DESIGN**. NOBLE HOUSE GROUP PTY LTD, (U.S. CLS. 26, 39 AND 44). SN 78-794,771. PUB. 7-31-2007. FILED 1-19-2006.

3,311,967. **S3 (BLOCK FORM)**. ALIGNMED, INC., (U.S. CLS. 26, 39 AND 44). SN 78-833,766. PUB. 7-31-2007. FILED 3-9-2006.

3,312,109. **ENRICHING LIVES (BLOCK FORM)**. TRACE LIFE SCIENCES, INC., (U.S. CLS. 26, 39 AND 44). SN 78-873,723. PUB. 7-31-2007. FILED 5-1-2006.

3,312,154. **COMFORTVIEW (BLOCK FORM)**. PREMIER DENTAL PRODUCTS COMPANY, (U.S. CLS. 26, 39 AND 44). SN 78-879,836. PUB. 7-31-2007. FILED 5-9-2006.

3,312,169. **SEE CLEAR (BLOCK FORM)**. JLJ MEDICAL DEVICES INTERNATIONAL, LLC, (U.S. CLS. 26, 39 AND 44). SN 78-881,152. PUB. 7-31-2007. FILED 5-11-2006.

3,312,202. **ACUMEN (BLOCK FORM)**. ACUMEN MEDICAL, INC., (U.S. CLS. 26, 39 AND 44). SN 78-885,630. PUB. 7-31-2007. FILED 5-17-2006.

3,312,236 (*See Class 5 for this trademark*).

3,312,313. **EWG AND DESIGN**. EAGLE WORK CLOTHES, INC., MULTIPLE CLASS, (INT. CLS. 10 AND 25), (U.S. CLS. 22, 26, 39 AND 44). SN 78-906,286. PUB. 7-31-2007. FILED 6-12-2006.

3,312,345 (*See Class 9 for this trademark*).

3,312,347 (*See Class 9 for this trademark*).

3,312,373. **EDS (BLOCK FORM)**. A MAJOR DIFFERENCE, INC., (U.S. CLS. 26, 39 AND 44). SN 78-917,742. PUB. 2-13-2007. FILED 6-27-2006.

3,312,711 (*See Class 9 for this trademark*).

3,312,760. **NUVO (STYLIZED)**. NOTTINGHAM REHAB LIMITED, (U.S. CLS. 26, 39 AND 44). SN 79-023,557. PUB. 7-31-2007. FILED 2-16-2006.

3,312,788 (*See Class 9 for this trademark*).

3,312,815. **FENDERWEDGE (STYLIZED)**. DIRECTA AB, (U.S. CLS. 26, 39 AND 44). SN 79-027,123. PUB. 7-31-2007. FILED 1-25-2006.

3,312,826 (*See Class 6 for this trademark*).

3,312,842 (*See Class 9 for this trademark*).

3,312,843. **CRYSTALFIX (STYLIZED)**. VYGON, (U.S. CLS. 26, 39 AND 44). SN 79-028,043. PUB. 7-31-2007. FILED 8-7-2006.

3,312,859 (*See Class 5 for this trademark*).

3,312,913. **FLEXZONE (STYLIZED)**. GLÖCKL, JOSEF, MULTIPLE CLASS, (INT. CLS. 10 AND 20), (U.S. CLS. 2, 13, 22, 25, 26, 32, 39, 44 AND 50). SN 79-030,988. PUB. 7-31-2007. FILED 11-2-2006.

3,312,918 (*See Class 5 for this trademark*).

3,312,921 (*See Class 5 for this trademark*).

3,312,926 (*See Class 5 for this trademark*).

3,312,935. **SURE CARDIO (BLOCK FORM)**. TOSHIBA MEDICAL SYSTEMS CORPORATION, (U.S. CLS. 26, 39 AND 44). SN 79-032,649. PUB. 7-31-2007. FILED 11-28-2006.

3,312,947. **INSULAIR (BLOCK FORM)**. BANG & OLUFSEN MEDICOM A/S, (U.S. CLS. 26, 39 AND 44). SN 79-033,775. PUB. 7-31-2007. FILED 12-29-2006.

3,312,955 (*See Class 5 for this trademark*).

3,312,963. **DENTALASTIC (STYLIZED)**. DENTAURUM J.P. WINKELSTROETER KG, (U.S. CLS. 26, 39 AND 44). SN 79-035,483. PUB. 7-31-2007. FILED 2-2-2007.

3,312,964. **DENTALASTICS (STYLIZED)**. DENTAURUM J.P. WINKELSTROETER KG, (U.S. CLS. 26, 39 AND 44). SN 79-

035,505. PUB. 7-31-2007. FILED 2-2-2007.

CLASS 11—ENVIRONMENTAL CONTROL APPARATUS

- 3,310,230 (*See Class 7 for this trademark*).
 3,310,234 (*See Class 1 for this trademark*).
 3,310,241 (*See Class 8 for this trademark*).
 3,310,268. **HI-HOSE (BLOCK FORM)**. PHYTOTRONICS, INC., (U.S. CLS. 13, 21, 23, 31 AND 34). SN 76-648,034. PUB. 7-31-2007. FILED 10-6-2005.
 3,310,301. **HYPERION R-LITE SYSTEM (BLOCK FORM)**. LUMIFICIENT TECHNOLOGIES, INC., (U.S. CLS. 13, 21, 23, 31 AND 34). SN 76-657,799. PUB. 6-12-2007. FILED 4-3-2006.
 3,310,343. **TIO2 SHIELD (BLOCK FORM)**. PURESPECTRUM TECHNOLOGIES, INC., (U.S. CLS. 13, 21, 23, 31 AND 34). SN 76-663,758. PUB. 7-31-2007. FILED 7-27-2006.
 3,310,361. **ECCO GROUP AND DESIGN**. ELECTRONIC CONTROLS COMPANY, MULTIPLE CLASS, (INT. CLS. 11 AND 12), (U.S. CLS. 13, 19, 21, 23, 31, 34, 35 AND 44). SN 76-667,025. PUB. 7-31-2007. FILED 10-4-2006.
 3,310,374. **MEMOLUX (BLOCK FORM)**. CITY BRIGHT INTERNATIONAL LIMITED, (U.S. CLS. 13, 21, 23, 31 AND 34). SN 76-668,641. PUB. 7-31-2007. FILED 11-7-2006.
 3,310,432. **NU-LITES (BLOCK FORM)**. DIS GROUP INC., (U.S. CLS. 13, 21, 23, 31 AND 34). SN 77-001,213. PUB. 7-31-2007. FILED 9-17-2006.
 3,310,475. **P+E "INSIDE" (BLOCK FORM)**. POWER & ENERGY, INC., (U.S. CLS. 13, 21, 23, 31 AND 34). SN 77-009,448. PUB. 7-31-2007. FILED 9-28-2006.
 3,310,493. **RAPID RECOVERY UNIT (BLOCK FORM)**. RGF ENVIRONMENTAL GROUP, INC., (U.S. CLS. 13, 21, 23, 31 AND 34). SN 77-012,248. PUB. 7-17-2007. FILED 10-3-2006.
 3,310,503. **TURTLE FOUNTAINS (BLOCK FORM)**. TURTLE FOUNTAINS, LLC, (U.S. CLS. 13, 21, 23, 31 AND 34). SN 77-013,318. PUB. 7-31-2007. FILED 10-4-2006.
 3,310,642. **FLITELITE AND DESIGN**. MOMENTUM INTERACTIVE, (U.S. CLS. 13, 21, 23, 31 AND 34). SN 77-038,089. PUB. 7-31-2007. FILED 11-6-2006.
 3,310,773. **DACAPO (BLOCK FORM)**. BSH BOSCH UND SIEMENS HAUSGERAETE GMBH, (U.S. CLS. 13, 21, 23, 31 AND 34). SN 77-058,132. PUB. 7-31-2007. FILED 12-6-2006.
 3,310,827. **BEACHCOMBER HOT TUBS (BLOCK FORM)**. BEACHCOMBER HOT TUBS INC., (U.S. CLS. 13, 21, 23, 31 AND 34). SN 77-064,755. PUB. 7-31-2007. FILED 12-14-2006.
 3,311,254. **MIGHTYKOOL (BLOCK FORM)**. STICH, JOHN L., DBA TRUSTEE OF THE STICH FAMILY TRUST, (U.S. CLS. 13, 21, 23, 31 AND 34). SN 77-087,447. PUB. 7-31-2007. FILED 1-21-2007.
 3,311,284 (*See Class 9 for this trademark*).
 3,311,421. **SCRUB-WARE (BLOCK FORM)**. ACORN ENGINEERING COMPANY, (U.S. CLS. 13, 21, 23, 31 AND 34). SN 77-098,892. PUB. 7-31-2007. FILED 2-5-2007.
 3,311,564 (*See Class 7 for this trademark*).
 3,311,641 (*See Class 1 for this trademark*).
 3,311,645 (*See Class 7 for this trademark*).
 3,311,732 (*See Class 6 for this trademark*).
 3,311,748 (*See Class 9 for this trademark*).
 3,311,792. **EBC ENGINEERED BRASS COMPANY (BLOCK FORM)**. JUST MANUFACTURING COMPANY, (U.S. CLS. 13, 21, 23, 31 AND 34). SN 78-709,216. PUB. 7-31-2007. FILED 9-8-2005.
 3,311,858 (*See Class 9 for this trademark*).
 3,311,895. **TIGIS FACTOR AND DESIGN**. TONI & GUY (USA) LIMITED, MULTIPLE CLASS, (INT. CLS. 11 AND 21), (U.S. CLS. 2, 13, 21, 23, 29, 30, 31, 33, 34, 40 AND 50). SN 78-786,689. PUB. 4-10-2007. FILED 1-6-2006.
 3,311,898 (*See Class 3 for this trademark*).
 3,311,942. **PREFERRED HEIGHT (BLOCK FORM)**. JAMECO INTERNATIONAL, LLC, (U.S. CLS. 13, 21, 23, 31 AND 34). SN 78-816,233. PUB. 7-31-2007. FILED 2-16-2006.
 3,311,989 (*See Class 9 for this trademark*).
 3,312,078. **CHEMFLEX (BLOCK FORM)**. POROUS MEDIA CORPORATION, (U.S. CLS. 13, 21, 23, 31 AND 34). SN 78-867,878. PUB. 7-31-2007. FILED 4-24-2006.
 3,312,103. **DAHLIA (BLOCK FORM)**. MAAX CANADA INC., (U.S. CLS. 13, 21, 23, 31 AND 34). SN 78-873,167. PUB. 7-31-2007. FILED 5-1-2006.
 3,312,107 (*See Class 8 for this trademark*).
 3,312,133. **ULTIDRI (BLOCK FORM)**. POROUS MEDIA CORPORATION, (U.S. CLS. 13, 21, 23, 31 AND 34). SN 78-876,401. PUB. 7-31-2007. FILED 5-4-2006.
 3,312,232. **I-BBQ AND DESIGN**. LUCAS INNOVATION, INC., (U.S. CLS. 13, 21, 23, 31 AND 34). SN 78-890,575. PUB. 7-31-2007. FILED 5-23-2006.
 3,312,359 (*See Class 9 for this trademark*).
 3,312,391. **DOUWE EGBERTS (BLOCK FORM)**. SARA LEE/DE N.V., (U.S. CLS. 13, 21, 23, 31 AND 34). SN 78-921,026. PUB. 7-31-2007. FILED 6-30-2006.
 3,312,397 (*See Class 6 for this trademark*).
 3,312,400 (*See Class 6 for this trademark*).
 3,312,412 (*See Class 7 for this trademark*).
 3,312,416. **STERILFLO SYSTEM (BLOCK FORM)**. AIR SYSTEM COMPONENTS LP, (U.S. CLS. 13, 21, 23, 31 AND 34). SN 78-923,616. PUB. 7-31-2007. FILED 7-6-2006.
 3,312,437 (*See Class 7 for this trademark*).
 3,312,441 (*See Class 6 for this trademark*).
 3,312,509. **CROSSRAY AND DESIGN**. GRAND HALL ENTERPRISE CO., LTD., (U.S. CLS. 13, 21, 23, 31 AND 34). SN 78-937,494. PUB. 7-31-2007. FILED 7-26-2006.
 3,312,518. **SANUVOX INSIDE (BLOCK FORM)**. SANUVOX TECHNOLOGIES INC., (U.S. CLS. 13, 21, 23, 31 AND 34). SN 78-939,152. PUB. 7-31-2007. FILED 7-27-2006.
 3,312,598. **BUSCH GARDENS (BLOCK FORM)**. ANHEUSER-BUSCH, INCORPORATED, (U.S. CLS. 13, 21, 23, 31 AND 34). SN 78-958,346. PUB. 7-31-2007. FILED 8-23-2006.
 3,312,701 (*See Class 1 for this trademark*).
 3,312,741 (*See Class 6 for this trademark*).
 3,312,756 (*See Class 6 for this trademark*).
 3,312,762. **LAVAI AND DESIGN**. L.A.V.A.I. S.A.S.; DI GIULIANO STATUA & C., MULTIPLE CLASS, (INT. CLS. 11 AND 21), (U.S. CLS. 2, 13, 21, 23, 29, 30, 31, 33, 34, 40 AND 50). SN 79-023,971. PUB. 7-31-2007. FILED 2-8-2006.
 3,312,775. **INAX (STYLIZED)**. INAX CORPORATION, (U.S. CLS. 13, 21, 23, 31 AND 34). SN 79-024,554. PUB. 7-31-2007. FILED 8-1-2005.
 3,312,791 (*See Class 6 for this trademark*).
 3,312,804. **M MARK SLÖJD SWEDEN AND DESIGN**. MARK-SLÖJD AB, (U.S. CLS. 13, 21, 23, 31 AND 34). SN 79-026,337. PUB. 7-31-2007. FILED 5-16-2006.
 3,312,821. **OXINEO (STYLIZED)**. ADAMANT TECHNOLOGIES SA, MULTIPLE CLASS, (INT. CLS. 11 AND 37), (U.S. CLS. 13, 21, 23, 31, 34, 100, 103 AND 106). SN 79-027,295. PUB. 7-31-2007. FILED 8-2-2006.
 3,312,826 (*See Class 6 for this trademark*).
 3,312,839 (*See Class 7 for this trademark*).
 3,312,840 (*See Class 7 for this trademark*).
 3,312,857. **WATERCOLOURS AND DESIGN**. NEOPERL SERVICES AG, MULTIPLE CLASS, (INT. CLS. 11, 16, 17, 40 AND 42), (U.S. CLS. 1, 2, 5, 12, 13, 21, 22, 23, 29, 31, 34, 35, 37, 38, 50, 100, 101, 103 AND 106). SN 79-028,789. PUB. 7-31-2007. FILED 12-9-2005.
 3,312,862. **LECHUZA (BLOCK FORM)**. GEOBRA BRANDSTÄTTER GMBH & CO. KG, MULTIPLE CLASS, (INT. CLS. 11 AND 21), (U.S. CLS. 2, 13, 21, 23, 29, 30, 31, 33, 34, 40 AND 50). SN 79-028,952. PUB. 7-31-2007. FILED 8-18-2006.
 3,312,887. **ORILAX (BLOCK FORM)**. GUANGZHOU FAIRLAND ELECTRIC CO., LTD., (U.S. CLS. 13, 21, 23, 31 AND 34). SN 79-029,878. PUB. 7-31-2007. FILED 5-16-2006.
 3,312,897 (*See Class 6 for this trademark*).
 3,312,899. **MUSHIPON (STYLIZED)**. BEN-HAR FUYO CO., LTD., (U.S. CLS. 13, 21, 23, 31 AND 34). SN 79-030,132. PUB. 7-31-2007. FILED 7-7-2005.
 3,312,905 (*See Class 9 for this trademark*).
 3,312,911. **AMFAG (STYLIZED)**. AMFAG - S.P.A., MULTIPLE CLASS, (INT. CLS. 11 AND 17), (U.S. CLS. 1, 5, 12, 13, 21, 23, 31, 34, 35 AND 50). SN 79-030,788. PUB. 7-31-2007. FILED 11-2-2005.
 3,312,941 (*See Class 2 for this trademark*).

CLASS 12—VEHICLES

- 3,310,183. **SPARKY COBRA**. COBRA ENGINEERING CORPORATION, (U.S. CLS. 19, 21, 23, 31, 35 AND 44). SN 75-068,785. PUB. 9-29-1998. FILED 3-7-1996.
- 3,310,184. **BOULEVARD PRODUCTS U.S.A. COBRA AND DESIGN**. COBRA ENGINEERING CORPORATION, (U.S. CLS. 19, 21, 23, 31, 35 AND 44). SN 75-079,910. PUB. 9-29-1998. FILED 3-28-1996.
- 3,310,185. **BOULEVARD EXHAUST USA COBRA**. COBRA ENGINEERING CORPORATION, (U.S. CLS. 19, 21, 23, 31, 35 AND 44). SN 75-095,533. PUB. 9-29-1998. FILED 4-29-1996.
- 3,310,186. **BOULEVARD EXHAUST U.S.A. COBRA AND DESIGN**. COBRA ENGINEERING CORPORATION, (U.S. CLS. 19, 21, 23, 31, 35 AND 44). SN 75-095,534. PUB. 9-29-1998. FILED 4-29-1996.
- 3,310,204 (*See Class 3 for this trademark*).
- 3,310,230 (*See Class 7 for this trademark*).
- 3,310,243. **C 280 (BLOCK FORM)**. DAIMLERCHRYSLER AG, (U.S. CLS. 19, 21, 23, 31, 35 AND 44). SN 76-604,835. PUB. 7-31-2007. FILED 7-30-2004.
- 3,310,245. **ADVICS ADVICS PREMIUM BRAKE PADS CARBON CERAMIC FORMULA EXCEPTIONAL BRAKING POWER LONGER PERFORMANCE LIFE HIGH QUALITY MATERIALS LOW DUST FORMULATION PRECISION ENGINEERED SMOOTH BRAKING AND DESIGN**. KABUSHIKI KAISHA ADVICS, DBA ADVICS CO., LTD., (U.S. CLS. 19, 21, 23, 31, 35 AND 44). SN 76-612,736. PUB. 6-26-2007. FILED 9-24-2004.
- 3,310,284. **TOTE MULE (BLOCK FORM)**. KENNEDY, WILLIAM L., (U.S. CLS. 19, 21, 23, 31, 35 AND 44). SN 76-654,665. PUB. 7-31-2007. FILED 2-3-2006.
- 3,310,289. **STAR AND DESIGN**. JH GLOBAL SERVICES, INC., (U.S. CLS. 19, 21, 23, 31, 35 AND 44). SN 76-656,711. PUB. 7-31-2007. FILED 3-16-2006.
- 3,310,326. **K AND DESIGN**. KRAUSE, VICTOR A., (U.S. CLS. 19, 21, 23, 31, 35 AND 44). SN 76-661,635. PUB. 7-10-2007. FILED 6-15-2006.
- 3,310,361 (*See Class 11 for this trademark*).
- 3,310,477. **AUSTYRE (STYLIZED)**. RAHMANI HOLDINGS PTY. LTD., (U.S. CLS. 19, 21, 23, 31, 35 AND 44). SN 77-010,099. PUB. 7-31-2007. FILED 9-28-2006.
- 3,310,542 (*See Class 6 for this trademark*).
- 3,310,698. **DISCOVERY (BLOCK FORM)**. FLEETWOOD ENTERPRISES, INC., (U.S. CLS. 19, 21, 23, 31, 35 AND 44). SN 77-047,913. PUB. 6-12-2007. FILED 11-20-2006.
- 3,310,701. **YETI (BLOCK FORM)**. BRP FINLAND OY, (U.S. CLS. 19, 21, 23, 31, 35 AND 44). SN 77-048,054. PUB. 7-31-2007. FILED 11-20-2006.
- 3,310,841 (*See Class 7 for this trademark*).
- 3,311,023 (*See Class 7 for this trademark*).
- 3,311,149 (*See Class 7 for this trademark*).
- 3,311,233. **BE SEEN (BLOCK FORM)**. SWEETSKINZ INC., (U.S. CLS. 19, 21, 23, 31, 35 AND 44). SN 77-085,827. PUB. 7-31-2007. FILED 1-18-2007.
- 3,311,276. **BODE (BLOCK FORM)**. BODE CORPORATION, (U.S. CLS. 19, 21, 23, 31, 35 AND 44). SN 77-089,692. PUB. 7-31-2007. FILED 1-24-2007.
- 3,311,342. **INFANT SHADE AND DESIGN**. GARRAND, MARGO A ; GARRAND, MICHAEL L, (U.S. CLS. 19, 21, 23, 31, 35 AND 44). SN 77-094,851. PUB. 7-31-2007. FILED 1-30-2007.
- 3,311,367. **REDI-WHEEL (BLOCK FORM)**. REDINGTON COUNTERS, INC., (U.S. CLS. 19, 21, 23, 31, 35 AND 44). SN 77-096,898. PUB. 7-31-2007. FILED 2-1-2007.
- 3,311,394. **KING KONG (BLOCK FORM)**. TRUCK ADS, LLC, (U.S. CLS. 19, 21, 23, 31, 35 AND 44). SN 77-098,102. PUB. 7-31-2007. FILED 2-2-2007.
- 3,311,606. **P3000 ENERGY (BLOCK FORM)**. PIRELLI TYRE S.P.A., (U.S. CLS. 19, 21, 23, 31, 35 AND 44). SN 77-145,859. PUB. 7-31-2007. FILED 4-2-2007.
- 3,311,635. **LMS**. DANA CORPORATION, (U.S. CLS. 19, 21, 23, 31, 35 AND 44). SN 78-184,727. PUB. 7-31-2007. FILED 11-13-2002.
- 3,311,655. **TRUCKXPRESSIONS.COM AND DESIGN**. S & S FIRESTONE, INC., (U.S. CLS. 19, 21, 23, 31, 35 AND 44). SN 78-418,023. PUB. 7-31-2007. FILED 5-13-2004.
- 3,311,664 (*See Class 3 for this trademark*).
- 3,311,711. **FIT BIKE CO. (BLOCK FORM)**. S & M BIKES, INC., (U.S. CLS. 19, 21, 23, 31, 35 AND 44). SN 78-610,052. PUB. 6-26-2007. FILED 4-15-2005.
- 3,311,742 (*See Class 9 for this trademark*).
- 3,311,759 (*See Class 7 for this trademark*).
- 3,311,773. **DCA WEIGHTMASTER (BLOCK FORM)**. DAIMLERCHRYSLER AG, MULTIPLE CLASS, (INT. CLS. 12 AND 40), (U.S. CLS. 19, 21, 23, 31, 35, 44, 100, 103 AND 106). SN 78-698,111. PUB. 10-24-2006. FILED 8-23-2005.
- 3,311,859. **AUTO COUTURE (BLOCK FORM)**. WARD, DANIEL R., (U.S. CLS. 19, 21, 23, 31, 35 AND 44). SN 78-755,308. PUB. 7-31-2007. FILED 11-16-2005.
- 3,311,898 (*See Class 3 for this trademark*).
- 3,311,961. **TRACK DAY (BLOCK FORM)**. THOMAS LLOYD CETTA, (U.S. CLS. 19, 21, 23, 31, 35 AND 44). SN 78-831,744. PUB. 7-31-2007. FILED 3-7-2006.
- 3,311,977 (*See Class 9 for this trademark*).
- 3,311,984 (*See Class 9 for this trademark*).
- 3,311,988. **OTR (BLOCK FORM)**. FLEETPRIDE, INC., (U.S. CLS. 19, 21, 23, 31, 35 AND 44). SN 78-842,336. PUB. 7-31-2007. FILED 3-21-2006.
- 3,312,038. **SHARK BITE (BLOCK FORM)**. CLASS M CORPORATION, (U.S. CLS. 19, 21, 23, 31, 35 AND 44). SN 78-857,971. PUB. 6-26-2007. FILED 4-10-2006.
- 3,312,114. **CLERK (BLOCK FORM)**. HNI TECHNOLOGIES INC., (U.S. CLS. 19, 21, 23, 31, 35 AND 44). SN 78-874,559. PUB. 7-31-2007. FILED 5-2-2006.
- 3,312,122 (*See Class 7 for this trademark*).
- 3,312,220. **DETH BIKES (BLOCK FORM)**. SAMMONS, BEN, (U.S. CLS. 19, 21, 23, 31, 35 AND 44). SN 78-887,374. PUB. 7-31-2007. FILED 5-19-2006.
- 3,312,306. **MISCELLANEOUS DESIGN**. REALM HOLDINGS, LLC, (U.S. CLS. 19, 21, 23, 31, 35 AND 44). SN 78-905,434. PUB. 7-31-2007. FILED 6-10-2006.
- 3,312,324. **AIRFLEX AND DESIGN**. DEXTER AXLE COMPANY, (U.S. CLS. 19, 21, 23, 31, 35 AND 44). SN 78-908,076. PUB. 7-31-2007. FILED 6-14-2006.
- 3,312,330. **V VETTER AND DESIGN**. VETTER UMFORMTECHNIK GMBH, (U.S. CLS. 19, 21, 23, 31, 35 AND 44). SN 78-909,255. PUB. 7-31-2007. FILED 6-15-2006.
- 3,312,399. **722 EDITION (BLOCK FORM)**. DAIMLERCHRYSLER AG, MULTIPLE CLASS, (INT. CLS. 12 AND 14), (U.S. CLS. 2, 19, 21, 23, 27, 28, 31, 35, 44 AND 50). SN 78-922,017. PUB. 7-31-2007. FILED 7-3-2006.
- 3,312,440. **ZAFIRA (BLOCK FORM)**. OPEL EISENACH GMBH, (U.S. CLS. 19, 21, 23, 31, 35 AND 44). SN 78-927,244. PUB. 7-31-2007. FILED 7-11-2006.
- 3,312,478 (*See Class 6 for this trademark*).
- 3,312,536 (*See Class 6 for this trademark*).
- 3,312,566 (*See Class 9 for this trademark*).
- 3,312,567. **TORQMAX (BLOCK FORM)**. LUK LAMELLEN UND KUPPLUNGSBAU BEITEILIGUNGS KG, (U.S. CLS. 19, 21, 23, 31, 35 AND 44). SN 78-949,831. PUB. 7-31-2007. FILED 8-10-2006.
- 3,312,716. **GOLDEN TEAM AND DESIGN**. GOLDEN TEAM SPORT GMBH & CO. KG, MULTIPLE CLASS, (INT. CLS. 12, 18, 22, 25 AND 28), (U.S. CLS. 1, 2, 3, 7, 19, 21, 22, 23, 31, 35, 38, 39, 41, 42, 44 AND 50). SN 79-014,775. PUB. 7-31-2007. FILED 11-25-2004.
- 3,312,731 (*See Class 7 for this trademark*).
- 3,312,736. **PEDDERS SUSPENSION AND DESIGN**. PEDDERS SHOCK ABSORBER SERVICE PTY LTD, MULTIPLE CLASS, (INT. CLS. 12 AND 37), (U.S. CLS. 19, 21, 23, 31, 35, 44, 100, 103 AND 106). SN 79-019,613. PUB. 7-31-2007. FILED 7-8-2005.
- 3,312,809 (*See Class 6 for this trademark*).
- 3,312,814. **SPARK (BLOCK FORM)**. SCOTT USA LIMITED, (U.S. CLS. 19, 21, 23, 31, 35 AND 44). SN 79-026,965. PUB. 7-31-2007. FILED 6-13-2006.
- 3,312,822. **POWER GRIP (BLOCK FORM)**. THULE GMBH & CO. KG, (U.S. CLS. 19, 21, 23, 31, 35 AND 44). SN 79-027,307. PUB. 7-31-2007. FILED 5-4-2006.
- 3,312,828. **TIGRA (STYLIZED)**. OPEL EISENACH GMBH, (U.S. CLS. 19, 21, 23, 31, 35 AND 44). SN 79-027,522. PUB. 7-31-2007. FILED 6-2-2006.
- 3,312,831. **NIVOMAT (BLOCK FORM)**. ZF SACHS AG, (U.S. CLS. 19, 21, 23, 31, 35 AND 44). SN 79-027,637. PUB. 7-31-2007. FILED 7-5-2006.
- 3,312,832. **NIVOMAT (STYLIZED)**. ZF SACHS AG, (U.S. CLS. 19, 21, 23, 31, 35 AND 44). SN 79-027,638. PUB. 7-31-2007.

- FILED 7-5-2006.
- 3,312,834. **AICON YACHTS AND DESIGN**. AICON SPA, MULTIPLE CLASS, (INT. CLS. 12, 25, 28 AND 37), (U.S. CLS. 19, 21, 22, 23, 31, 35, 38, 39, 44, 50, 100, 103 AND 106). SN 79-027,663. PUB. 7-31-2007. FILED 5-30-2006.
- 3,312,844. **AICON (BLOCK FORM)**. AICON SPA, MULTIPLE CLASS, (INT. CLS. 12, 25, 28 AND 37), (U.S. CLS. 19, 21, 22, 23, 31, 35, 38, 39, 44, 50, 100, 103 AND 106). SN 79-028,049. PUB. 7-31-2007. FILED 5-30-2006.
- 3,312,854. **CORSA (STYLIZED)**. OPEL EISENACH GMBH, (U.S. CLS. 19, 21, 23, 31, 35 AND 44). SN 79-028,692. PUB. 7-31-2007. FILED 6-2-2006.
- 3,312,855. **ATALA (STYLIZED)**. ATALA S.P.A., MULTIPLE CLASS, (INT. CLS. 12 AND 28), (U.S. CLS. 19, 21, 22, 23, 31, 35, 38, 44 AND 50). SN 79-028,701. PUB. 7-31-2007. FILED 4-6-2006.
- 3,312,856. **MERIVA (BLOCK FORM)**. OPEL EISENACH GMBH, (U.S. CLS. 19, 21, 23, 31, 35 AND 44). SN 79-028,718. PUB. 7-31-2007. FILED 6-2-2006.
- 3,312,945. **ORIBAY ORIGINAL BUTTONS FOR AUTOMOTIVE YNDUSTRY (STYLIZED)**. ORIBAY MIRROR BUTTONS, S.L., (U.S. CLS. 19, 21, 23, 31, 35 AND 44). SN 79-033,446. PUB. 7-31-2007. FILED 9-21-2006.
- 3,312,969. **BMW 555 (BLOCK FORM)**. BAYERISCHE MOTOREN WERKE AKTIENGESELLSCHAFT, MULTIPLE CLASS, (INT. CLS. 12, 16 AND 28), (U.S. CLS. 2, 5, 19, 21, 22, 23, 29, 31, 35, 37, 38, 44 AND 50). SN 79-035,778. PUB. 7-31-2007. FILED 2-9-2007.
- 3,312,970. **WHIZZ (BLOCK FORM)**. RED CASTLE FRANCE, (U.S. CLS. 19, 21, 23, 31, 35 AND 44). SN 79-035,784. PUB. 7-31-2007. FILED 12-21-2006.

CLASS 13—FIREARMS

- 3,310,629. **FULL BLAST BRAND AND DESIGN**. LI, XIONG, (U.S. CLS. 2 AND 9). SN 77-036,134. PUB. 7-31-2007. FILED 11-3-2006.
- 3,311,093. **LEBEAU-COURALLY (BLOCK FORM)**. MANUFACTURE D'ARMES FINES VERREES ET CIE, (U.S. CLS. 2 AND 9). SN 77-074,235. PUB. 7-31-2007. FILED 1-2-2007.
- 3,311,304. **GO BIG OR GO HOME BIG FIREWORKS AND DESIGN**. AMERICAN EAGLE SUPERSTORE, INC., (U.S. CLS. 2 AND 9). SN 77-091,756. PUB. 7-31-2007. FILED 1-26-2007.
- 3,311,408. **XGRIP (BLOCK FORM)**. FREED DESIGNS INC., (U.S. CLS. 2 AND 9). SN 77-098,614. PUB. 7-31-2007. FILED 2-3-2007.
- 3,311,575. **TEAM SD (BLOCK FORM)**. TEAM SD, INC., (U.S. CLS. 2 AND 9). SN 77-126,071. PUB. 7-31-2007. FILED 3-8-2007.
- 3,311,576. **TSD TACTICAL (BLOCK FORM)**. TEAM SD, INC., (U.S. CLS. 2 AND 9). SN 77-126,092. PUB. 7-31-2007. FILED 3-8-2007.
- 3,311,777. **404 (STYLIZED)**. S.A.T. SWISS ARMS TECHNOLOGY AG, (U.S. CLS. 2 AND 9). SN 78-699,036. PUB. 6-5-2007. FILED 8-24-2005.
- 3,311,778. **505 (BLOCK FORM)**. S.A.T. SWISS ARMS TECHNOLOGY AG, (U.S. CLS. 2 AND 9). SN 78-699,043. PUB. 6-26-2007. FILED 8-24-2005.
- 3,311,963. **S.C.S (BLOCK FORM)**. S.A.T. SWISS ARMS TECHNOLOGY AG, (U.S. CLS. 2 AND 9). SN 78-832,989. PUB. 7-10-2007. FILED 3-9-2006.
- 3,311,964. **SMARTUBE AND DESIGN**. S.A.T. SWISS ARMS TECHNOLOGY AG, (U.S. CLS. 2 AND 9). SN 78-833,027. PUB. 7-10-2007. FILED 3-9-2006.
- 3,312,036. **GMLRS (BLOCK FORM)**. LOCKHEED MARTIN CORPORATION, (U.S. CLS. 2 AND 9). SN 78-856,787. PUB. 7-31-2007. FILED 4-7-2006.
- 3,312,125. **TEXAS OUTLAW (BLOCK FORM)**. TEXAS FIREWORKS COMPANY, INC., (U.S. CLS. 2 AND 9). SN 78-875,315. PUB. 7-31-2007. FILED 5-3-2006.
- 3,312,583. **RICHARDS TRANSITION MODEL (BLOCK FORM)**. CIMARRON FIREARMS COMPANY, INC., (U.S. CLS. 2 AND 9). SN 78-953,866. PUB. 7-31-2007. FILED 8-16-2006.

CLASS 14—JEWELRY

- 3,310,204 (*See Class 3 for this trademark*).
- 3,310,220. **ID'N STYLE (STYLIZED)**. ON AIR ON LINE, (U.S. CLS. 2, 27, 28 AND 50). SN 76-382,570. PUB. 7-31-2007. FILED 3-15-2002.
- 3,310,230 (*See Class 7 for this trademark*).
- 3,310,286. **MISCELLANEOUS DESIGN**. JEWEL DÉCOR CO., LTD., (U.S. CLS. 2, 27, 28 AND 50). SN 76-656,045. PUB. 7-31-2007. FILED 3-3-2006.
- 3,310,314. **JOY BALI AND DESIGN**. GOOD CHARMA INC., (U.S. CLS. 2, 27, 28 AND 50). SN 76-660,704. PUB. 7-31-2007. FILED 5-26-2006.
- 3,310,394. **NARMI (BLOCK FORM)**. AIF CORPORATION, (U.S. CLS. 2, 27, 28 AND 50). SN 76-670,543. PUB. 7-10-2007. FILED 12-19-2006.
- 3,310,486. **PS PILLAR & STONE INTERNATIONAL LLC DEFINE . DISCLOSE . DELIVER AND DESIGN**. NARYRATHA HENG SCHLUESSEL, AND ROLAND SCHLUESSEL, (U.S. CLS. 2, 27, 28 AND 50). SN 77-011,225. PUB. 6-26-2007. FILED 9-30-2006.
- 3,310,539. **MJ AND DESIGN**. SOULE, MORGAN JEAN, (U.S. CLS. 2, 27, 28 AND 50). SN 77-019,293. PUB. 7-31-2007. FILED 10-12-2006.
- 3,310,540. **MORGAN JEAN (BLOCK FORM)**. SOULE, MORGAN JEAN, (U.S. CLS. 2, 27, 28 AND 50). SN 77-019,295. PUB. 7-31-2007. FILED 10-12-2006.
- 3,310,542 (*See Class 6 for this trademark*).
- 3,310,857. **ASTRODEA AND DESIGN**. CITIZEN HOLDINGS CO., LTD., (U.S. CLS. 2, 27, 28 AND 50). SN 77-067,521. PUB. 7-31-2007. FILED 12-19-2006.
- 3,310,859. **TIFFANY LEGACY COLLECTION (BLOCK FORM)**. TIFFANY (NJ) INC., (U.S. CLS. 2, 27, 28 AND 50). SN 77-067,617. PUB. 7-31-2007. FILED 12-19-2006.
- 3,310,886. **STRICTLY STERLING (BLOCK FORM)**. STRICTLY STERLING, INC., (U.S. CLS. 2, 27, 28 AND 50). SN 77-068,439. PUB. 7-31-2007. FILED 12-20-2006.
- 3,310,890. **S AND DESIGN**. STRICTLY STERLING, INC., (U.S. CLS. 2, 27, 28 AND 50). SN 77-068,478. PUB. 7-31-2007. FILED 12-20-2006.
- 3,310,992. **GOLD AND SILVER LINEN (BLOCK FORM)**. DIANA WIDMAN, (U.S. CLS. 2, 27, 28 AND 50). SN 77-072,126. PUB. 7-31-2007. FILED 12-27-2006.
- 3,310,997. **SONYA PAZ (BLOCK FORM)**. SONYA PAZ INCORPORATED, MULTIPLE CLASS, (INT. CLS. 14, 21, 24 AND 35), (U.S. CLS. 2, 13, 23, 27, 28, 29, 30, 33, 40, 42, 50, 100, 101 AND 102). SN 77-072,274. PUB. 7-31-2007. FILED 12-27-2006.
- 3,311,145. **STATUS WHAT'S YOURS? (BLOCK FORM)**. STATUS, LLC, MULTIPLE CLASS, (INT. CLS. 14, 18, 25 AND 35), (U.S. CLS. 1, 2, 3, 22, 27, 28, 39, 41, 50, 100, 101 AND 102). SN 77-077,030. PUB. 7-31-2007. FILED 1-5-2007.
- 3,311,151 (*See Class 3 for this trademark*).
- 3,311,173. **GARAVELLI DESIGN ITALY AND DESIGN**. GARAVELLI ALDO SRL, (U.S. CLS. 2, 27, 28 AND 50). SN 77-080,806. PUB. 7-31-2007. FILED 1-11-2007.
- 3,311,187 (*See Class 9 for this trademark*).
- 3,311,369. **SU (BLOCK FORM)**. SUNSTONE IMPORTS, INC., (U.S. CLS. 2, 27, 28 AND 50). SN 77-096,944. PUB. 7-31-2007. FILED 2-1-2007.
- 3,311,420. **MELISSA JOY MANNING (BLOCK FORM)**. MELISSA JOY MANNING, INC., (U.S. CLS. 2, 27, 28 AND 50). SN 77-098,873. PUB. 7-31-2007. FILED 2-5-2007.
- 3,311,463. **AUSTIN ALEXANDER (BLOCK FORM)**. CANDACE L. BLOM, (U.S. CLS. 2, 27, 28 AND 50). SN 77-101,005. PUB. 7-31-2007. FILED 2-6-2007.
- 3,311,470. **MJM AND DESIGN**. MELISSA JOY MANNING, INC., (U.S. CLS. 2, 27, 28 AND 50). SN 77-101,467. PUB. 7-31-2007. FILED 2-7-2007.
- 3,311,473. **HG HÈBÉ GRACE (STYLIZED)**. HEBEGRACE, INC., (U.S. CLS. 2, 27, 28 AND 50). SN 77-101,554. PUB. 7-31-2007. FILED 2-7-2007.
- 3,311,494. **LEONWATCH (BLOCK FORM)**. KAYARIAN, LEON M., (U.S. CLS. 2, 27, 28 AND 50). SN 77-104,379. PUB. 7-31-2007. FILED 2-10-2007.
- 3,311,550. **MISCELLANEOUS DESIGN**. HELLS ANGELS MOTORCYCLE CORPORATION, (U.S. CLS. 2, 27, 28 AND 50). SN 77-117,742. PUB. 7-31-2007. FILED 2-27-2007.
- 3,311,631 (*See Class 1 for this trademark*).

3,311,649. **JLO (STYLIZED)**. JLO HOLDING COMPANY, LLC, MULTIPLE CLASS, (INT. CLS. 14, 18 AND 25), (U.S. CLS. 1, 2, 3, 22, 27, 28, 39, 41 AND 50). SN 78-363,392. PUB. 7-31-2007. FILED 2-5-2004.

3,311,653. **STANLEY AND DESIGN**. STANLEY MUSEUM, INC., MULTIPLE CLASS, (INT. CLS. 14, 16 AND 41), (U.S. CLS. 2, 5, 22, 23, 27, 28, 29, 37, 38, 50, 100, 101 AND 107). SN 78-390,416. PUB. 7-31-2007. FILED 3-25-2004.

3,311,677. **SABRIM (STYLIZED)**. BRIMONT, MADELEINE, (U.S. CLS. 2, 27, 28 AND 50). SN 78-536,945. PUB. 7-31-2007. FILED 12-22-2004.

3,311,696 (*See Class 3 for this trademark*).

3,311,704 (*See Class 6 for this trademark*).

3,311,705 (*See Class 6 for this trademark*).

3,311,706 (*See Class 6 for this trademark*).

3,311,742 (*See Class 9 for this trademark*).

3,311,897. **INSTANT HEIRLOOMS COLLECTION (BLOCK FORM)**. M2 DESIGN BY MARY MARGRILL, INC. D/B/A KEATING & ROARK BY MARY MARGRILL, (U.S. CLS. 2, 27, 28 AND 50). SN 78-789,048. PUB. 7-31-2007. FILED 1-11-2006.

3,312,062. **ROLEX AND DESIGN**. ROLEX WATCH USA, INC., (U.S. CLS. 2, 27, 28 AND 50). SN 78-864,831. PUB. 7-31-2007. FILED 4-19-2006.

3,312,212 (*See Class 3 for this trademark*).

3,312,233. **WHITEFLASH (BLOCK FORM)**. WHITEFLASH-COM, INC., (U.S. CLS. 2, 27, 28 AND 50). SN 78-890,668. PUB. 7-31-2007. FILED 5-23-2006.

3,312,282. **GOOD HEALTH CHARMS (BLOCK FORM)**. MEDIMETRIX GROUP, INC., MULTIPLE CLASS, (INT. CLS. 14 AND 44), (U.S. CLS. 2, 27, 28, 50, 100 AND 101). SN 78-901,425. PUB. 7-31-2007. FILED 6-6-2006.

3,312,285. **MISCELLANEOUS DESIGN**. BELIEVE, ART FROM THE HEART, (U.S. CLS. 2, 27, 28 AND 50). SN 78-901,955. PUB. 7-31-2007. FILED 6-6-2006.

3,312,301. **BIRKS RPM (BLOCK FORM)**. BIRKS & MAYORS INC., (U.S. CLS. 2, 27, 28 AND 50). SN 78-904,728. PUB. 7-31-2007. FILED 6-9-2006.

3,312,398. **BROOKS & DUNN (BLOCK FORM)**. B & D, INC., MULTIPLE CLASS, (INT. CLS. 14 AND 26), (U.S. CLS. 2, 27, 28, 37, 39, 40, 42 AND 50). SN 78-921,968. PUB. 7-31-2007. FILED 7-3-2006.

3,312,399 (*See Class 12 for this trademark*).

3,312,409. **SILVERXT (BLOCK FORM)**. JOSTENS, INC., (U.S. CLS. 2, 27, 28 AND 50). SN 78-922,939. PUB. 7-31-2007. FILED 7-5-2006.

3,312,499. **PICK OF THE GLITTER FINE PET JEWELRY AND DESIGN**. PICK OF THE GLITTER, LLC, (U.S. CLS. 2, 27, 28 AND 50). SN 78-935,902. PUB. 7-31-2007. FILED 7-24-2006.

3,312,536 (*See Class 6 for this trademark*).

3,312,566 (*See Class 9 for this trademark*).

3,312,599. **PINSOURCE (STYLIZED)**. SPECIALITES UNLIMITED, INC., (U.S. CLS. 2, 27, 28 AND 50). SN 78-958,439. PUB. 7-31-2007. FILED 8-23-2006.

3,312,722 (*See Class 9 for this trademark*).

3,312,750 (*See Class 3 for this trademark*).

3,312,771. **D AND DESIGN**. COLTEX B.V., MULTIPLE CLASS, (INT. CLS. 14, 18 AND 25), (U.S. CLS. 1, 2, 3, 22, 27, 28, 39, 41 AND 50). SN 79-024,332. PUB. 7-31-2007. FILED 4-5-2006.

3,312,772. **DIDI (BLOCK FORM)**. COLTEX B.V., MULTIPLE CLASS, (INT. CLS. 14, 18, 25 AND 35), (U.S. CLS. 1, 2, 3, 22, 27, 28, 39, 41, 50, 100, 101 AND 102). SN 79-024,390. PUB. 7-31-2007. FILED 4-5-2006.

3,312,783 (*See Class 3 for this trademark*).

3,312,792. **BE EIGHT BY DE GRISOGONO (BLOCK FORM)**. DE GRISOGONO S.A., (U.S. CLS. 2, 27, 28 AND 50). SN 79-025,811. PUB. 7-31-2007. FILED 6-20-2006.

3,312,793. **BROWNY BROWN (BLOCK FORM)**. DE GRISOGONO S.A., (U.S. CLS. 2, 27, 28 AND 50). SN 79-025,838. PUB. 7-31-2007. FILED 6-20-2006.

3,312,807. **ARIS (STYLIZED)**. ARIS HEDIYELIK ESYA; SANAYI VE TICARET ANONIM SIRKETI, (U.S. CLS. 2, 27, 28 AND 50). SN 79-026,727. PUB. 7-31-2007. FILED 6-15-2006.

3,312,813. **JYX AND DESIGN**. LU CHENG WU, (U.S. CLS. 2, 27, 28 AND 50). SN 79-026,953. PUB. 7-31-2007. FILED 4-17-2006.

3,312,876 (*See Class 3 for this trademark*).

3,312,934. **J. U. (STYLIZED)**. ART + DESIGN GMBH, (U.S. CLS. 2, 27, 28 AND 50). SN 79-032,612. PUB. 7-31-2007. FILED 11-13-2006.

CLASS 15—MUSICAL INSTRUMENTS

3,310,373. **SKYNDEEP (BLOCK FORM)**. REMO, INC., (U.S. CLS. 2, 21 AND 36). SN 76-668,502. PUB. 7-31-2007. FILED 11-6-2006.

3,311,169. **GRACE MUSIC (BLOCK FORM)**. GRACE MUSIC INCORPORATION, (U.S. CLS. 2, 21 AND 36). SN 77-080,408. PUB. 7-31-2007. FILED 1-10-2007.

3,311,352. **FACTORY METAL PERCUSSION AND DESIGN**. PERCUSSIVE INNOVATIONS, LLC, (U.S. CLS. 2, 21 AND 36). SN 77-095,840. PUB. 7-31-2007. FILED 1-31-2007.

3,311,652 (*See Class 9 for this trademark*).

3,311,670. **GOOTAR (BLOCK FORM)**. CRANWELL, JAMES C, (U.S. CLS. 2, 21 AND 36). SN 78-515,281. PUB. 7-31-2007. FILED 11-11-2004.

3,311,765 (*See Class 9 for this trademark*).

3,311,796. **SOLARIS (BLOCK FORM)**. BOWEN, JOHN, SCOTT, (U.S. CLS. 2, 21 AND 36). SN 78-711,828. PUB. 7-31-2007. FILED 9-13-2005.

3,311,931. **OZARK (BLOCK FORM)**. STENTOR MUSIC CO. LTD., (U.S. CLS. 2, 21 AND 36). SN 78-809,415. PUB. 7-31-2007. FILED 2-7-2006.

3,312,785. **DETOA AND DESIGN**. DETOA ALBRECHTICE S.R.O., MULTIPLE CLASS, (INT. CLS. 15, 20 AND 28), (U.S. CLS. 2, 13, 21, 22, 23, 25, 32, 36, 38 AND 50). SN 79-025,408. PUB. 4-10-2007. FILED 3-22-2006.

3,312,787 (*See Class 9 for this trademark*).

3,312,930 (*See Class 9 for this trademark*).

CLASS 16—PAPER GOODS AND PRINTED MATTER

3,310,187. **AURORA WRITING HISTORY**. AURORA DUE S.R.L., (U.S. CLS. 2, 5, 22, 23, 29, 37, 38 AND 50). SN 75-259,396. PUB. 7-31-2007. FILED 3-18-1997.

3,310,200 (*See Class 9 for this trademark*).

3,310,204 (*See Class 3 for this trademark*).

3,310,221 (*See Class 9 for this trademark*).

3,310,225. **UNITED WE STAND 9/11 REMEMBERED AND DESIGN**. WILLIAMSON, DIXIE LAIN, MULTIPLE CLASS, (INT. CLS. 16 AND 24), (U.S. CLS. 2, 5, 22, 23, 29, 37, 38, 42 AND 50). SN 76-457,022. PUB. 7-31-2007. FILED 10-1-2002.

3,310,230 (*See Class 7 for this trademark*).

3,310,237 (*See Class 9 for this trademark*).

3,310,247 (*See Class 9 for this trademark*).

3,310,250. **SOFT & PURE PREMIUM (STYLIZED)**. KRUGER PRODUCTS LIMITED, (U.S. CLS. 2, 5, 22, 23, 29, 37, 38 AND 50). SN 76-625,071. PUB. 7-31-2007. FILED 12-17-2004.

3,310,257 (*See Class 9 for this trademark*).

3,310,260 (*See Class 10 for this trademark*).

3,310,280. **CLAYTHINGS (STYLIZED)**. EADDY, SUSAN ADAMS, (U.S. CLS. 2, 5, 22, 23, 29, 37, 38 AND 50). SN 76-652,712. PUB. 7-31-2007. FILED 1-3-2006.

3,310,287. **JOURNAL OF CONTINUING EDUCATION IN THE HEALTH PROFESSIONS (BLOCK FORM)**. ALLIANCE FOR CONTINUING MEDICAL EDUCATION, AND ASSOCIATION FOR HOSPITAL MEDICAL EDUCATION, AND SOCIETY FOR ACADEMIC CONTINUING MEDICAL EDUCATION, (U.S. CLS. 2, 5, 22, 23, 29, 37, 38 AND 50). SN 76-656,076. PUB. 7-31-2007. FILED 3-1-2006.

3,310,288. **EMM! SOFT SUAVE AND DESIGN**. REGALADO, MANUAL, DBA EL COWBOY, (U.S. CLS. 2, 5, 22, 23, 29, 37, 38 AND 50). SN 76-656,266. PUB. 7-31-2007. FILED 3-8-2006.

3,310,292. **MISCELLANEOUS DESIGN**. JEI CORPORATION, (U.S. CLS. 2, 5, 22, 23, 29, 37, 38 AND 50). SN 76-657,578. PUB. 7-31-2007. FILED 3-31-2006.

3,310,293. **SELF-LEARNING JEI MATH (BLOCK FORM)**. JEI CORPORATION, (U.S. CLS. 2, 5, 22, 23, 29, 37, 38 AND 50). SN 76-657,579. PUB. 7-31-2007. FILED 3-31-2006.

- 3,310,294. **SELF-LEARNING JEI ENGLISH (STYLIZED)**. JEI CORPORATION, (U.S. CLS. 2, 5, 22, 23, 29, 37, 38 AND 50). SN 76-657,580. PUB. 7-31-2007. FILED 3-31-2006.
- 3,310,295. **WWW.JEILEARNING.COM AND DESIGN**. JEI CORPORATION, MULTIPLE CLASS, (INT. CLS. 16 AND 41), (U.S. CLS. 2, 5, 22, 23, 29, 37, 38, 50, 100, 101 AND 107). SN 76-657,581. PUB. 7-31-2007. FILED 3-31-2006.
- 3,310,296. **WWW.JEI-EDU.COM AND DESIGN**. JEI CORPORATION, MULTIPLE CLASS, (INT. CLS. 16 AND 41), (U.S. CLS. 2, 5, 22, 23, 29, 37, 38, 50, 100, 101 AND 107). SN 76-657,582. PUB. 7-31-2007. FILED 3-31-2006.
- 3,310,297. **JEI SELF-LEARNING SYSTEMS (BLOCK FORM)**. JEI CORPORATION, MULTIPLE CLASS, (INT. CLS. 16 AND 41), (U.S. CLS. 2, 5, 22, 23, 29, 37, 38, 50, 100, 101 AND 107). SN 76-657,583. PUB. 7-31-2007. FILED 3-31-2006.
- 3,310,298. **JEI SELF-LEARNING CENTERS (BLOCK FORM)**. JEI CORPORATION, MULTIPLE CLASS, (INT. CLS. 16 AND 41), (U.S. CLS. 2, 5, 22, 23, 29, 37, 38, 50, 100, 101 AND 107). SN 76-657,584. PUB. 7-31-2007. FILED 3-31-2006.
- 3,310,299. **JEI AND DESIGN**. JEI CORPORATION, MULTIPLE CLASS, (INT. CLS. 16 AND 41), (U.S. CLS. 2, 5, 22, 23, 29, 37, 38, 50, 100, 101 AND 107). SN 76-657,585. PUB. 7-31-2007. FILED 3-31-2006.
- 3,310,352. **OMBUDESMAN (BLOCK FORM)**. ADVANCE MAGAZINE PUBLISHERS INC., (U.S. CLS. 2, 5, 22, 23, 29, 37, 38 AND 50). SN 76-665,127. PUB. 7-31-2007. FILED 8-25-2006.
- 3,310,422. **ECHOS (BLOCK FORM)**. MUSEUM OF SCIENCE INC., MULTIPLE CLASS, (INT. CLS. 16 AND 41), (U.S. CLS. 2, 5, 22, 23, 29, 37, 38, 50, 100, 101 AND 107). SN 76-673,391. PUB. 7-31-2007. FILED 3-1-2007.
- 3,310,447. **NPB GREETINGS DIVINE CARDS YOU CAN TRUST AND DESIGN**. NPB GREETINGS CORPORATION, (U.S. CLS. 2, 5, 22, 23, 29, 37, 38 AND 50). SN 77-004,265. PUB. 7-31-2007. FILED 9-21-2006.
- 3,310,450. **PACIFIC SHIPPER (BLOCK FORM)**. COMMONWEALTH BUSINESS MEDIA, (U.S. CLS. 2, 5, 22, 23, 29, 37, 38 AND 50). SN 77-004,509. PUB. 7-31-2007. FILED 9-21-2006.
- 3,310,454. **PIPPIN PUBLISHING AND DESIGN**. MARKET-ING LLC, (U.S. CLS. 2, 5, 22, 23, 29, 37, 38 AND 50). SN 77-004,777. PUB. 7-31-2007. FILED 9-21-2006.
- 3,310,482. **CERTIFICATION MAGAZINE (BLOCK FORM)**. MEDIATEC PUBLISHING, INC., (U.S. CLS. 2, 5, 22, 23, 29, 37, 38 AND 50). SN 77-010,794. PUB. 7-31-2007. FILED 9-29-2006.
- 3,310,494. **UNIQLO (BLOCK FORM)**. KABUSHIKI KAISHA FAST RETAILING, (U.S. CLS. 2, 5, 22, 23, 29, 37, 38 AND 50). SN 77-012,299. PUB. 7-31-2007. FILED 10-3-2006.
- 3,310,504. **PARENTS STEP AHEAD PADRES UN PASO ADELANTE AND DESIGN**. COLMENERO, MARIA GUADALUPE, (U.S. CLS. 2, 5, 22, 23, 29, 37, 38 AND 50). SN 77-013,785. PUB. 7-31-2007. FILED 10-4-2006.
- 3,310,516. **NORTHEAST COUNTRY ESTATES BY FARM & RANCH (BLOCK FORM)**. FARM & RANCH PUBLISHING, L.L.C., MULTIPLE CLASS, (INT. CLS. 16 AND 35), (U.S. CLS. 2, 5, 22, 23, 29, 37, 38, 50, 100, 101 AND 102). SN 77-016,193. PUB. 7-31-2007. FILED 10-6-2006.
- 3,310,542 (*See Class 6 for this trademark*).
- 3,310,596. **KRYLON (BLOCK FORM)**. SWIMC, INC., (U.S. CLS. 2, 5, 22, 23, 29, 37, 38 AND 50). SN 77-028,691. PUB. 7-31-2007. FILED 10-25-2006.
- 3,310,603. **DOGFRIENDLY.COM (BLOCK FORM)**. DOGFRIENDLY.COM, INC., MULTIPLE CLASS, (INT. CLS. 16, 35, 39 AND 41), (U.S. CLS. 2, 5, 22, 23, 29, 37, 38, 50, 100, 101, 102, 105 AND 107). SN 77-030,564. PUB. 7-31-2007. FILED 10-26-2006.
- 3,310,605. **WEE GALLERY (STYLIZED)**. WEE GALLERY, INC., (U.S. CLS. 2, 5, 22, 23, 29, 37, 38 AND 50). SN 77-030,753. PUB. 7-10-2007. FILED 10-27-2006.
- 3,310,618. **GEORGIA ASSOCIATION OF REALTORS (BLOCK FORM)**. GEORGIA ASSOCIATION OF REALTORS, INC., MULTIPLE CLASS, (INT. CLS. 16, 35 AND 41), (U.S. CLS. 2, 5, 22, 23, 29, 37, 38, 50, 100, 101, 102 AND 107). SN 77-032,870. PUB. 7-31-2007. FILED 10-31-2006.
- 3,310,624 (*See Class 9 for this trademark*).
- 3,310,637. **WARDROBE STATIONERY (BLOCK FORM)**. WARDROBE STATIONERY, INC., (U.S. CLS. 2, 5, 22, 23, 29, 37, 38 AND 50). SN 77-037,508. PUB. 7-31-2007. FILED 11-6-2006.
- 3,310,654 (*See Class 9 for this trademark*).
- 3,310,674. **MENTMORE (BLOCK FORM)**. HOBBS, STUART, AND JORDAN, GARY, AND XU, TINGJIAN, AND LOVE, JOHN, (U.S. CLS. 2, 5, 22, 23, 29, 37, 38 AND 50). SN 77-043,205. PUB. 6-26-2007. FILED 11-14-2006.
- 3,310,684. **RAY CATENA (BLOCK FORM)**. RAY CATENA MOTOR CAR CORPORATION, MULTIPLE CLASS, (INT. CLS. 16, 18, 25, 35 AND 37), (U.S. CLS. 1, 2, 3, 5, 22, 23, 29, 37, 38, 39, 41, 50, 100, 101, 102, 103 AND 106). SN 77-045,746. PUB. 7-31-2007. FILED 11-16-2006.
- 3,310,687. **HPT MAGAZINE AND DESIGN**. MEDIA PUBLISHING HOUSE, LLC, (U.S. CLS. 2, 5, 22, 23, 29, 37, 38 AND 50). SN 77-046,399. PUB. 7-31-2007. FILED 11-17-2006.
- 3,310,751. **IN LIGHTENMENT, INC IMAGINATION TO NTH POWER AND DESIGN**. INLIGHTENMENT, INC., (U.S. CLS. 2, 5, 22, 23, 29, 37, 38 AND 50). SN 77-054,375. PUB. 7-17-2007. FILED 11-30-2006.
- 3,310,765. **TRYST (BLOCK FORM)**. CREATIVE RESOURCES ONLINE, MULTIPLE CLASS, (INT. CLS. 16 AND 18), (U.S. CLS. 1, 2, 3, 5, 22, 23, 29, 37, 38, 41 AND 50). SN 77-056,417. PUB. 7-31-2007. FILED 12-4-2006.
- 3,310,787. **MINNESOTA ASTHMA COALITION (BLOCK FORM)**. AMERICAN LUNG ASSOCIATION OF THE UPPER MIDWEST, MULTIPLE CLASS, (INT. CLS. 16 AND 41), (U.S. CLS. 2, 5, 22, 23, 29, 37, 38, 50, 100, 101 AND 107). SN 77-060,314. PUB. 7-31-2007. FILED 12-8-2006.
- 3,310,821. **HOUSE CALL (BLOCK FORM)**. PATIENT NEWS PUBLISHING LTD., (U.S. CLS. 2, 5, 22, 23, 29, 37, 38 AND 50). SN 77-064,210. PUB. 7-31-2007. FILED 12-14-2006.
- 3,310,822. **TOOTH TALK (BLOCK FORM)**. PATIENT NEWS PUBLISHING LTD., (U.S. CLS. 2, 5, 22, 23, 29, 37, 38 AND 50). SN 77-064,214. PUB. 7-31-2007. FILED 12-14-2006.
- 3,310,823. **BRUSH UP (BLOCK FORM)**. PATIENT NEWS PUBLISHING LTD., (U.S. CLS. 2, 5, 22, 23, 29, 37, 38 AND 50). SN 77-064,219. PUB. 7-31-2007. FILED 12-14-2006.
- 3,310,840. **FREE THE FUTURE (BLOCK FORM)**. ANDREW PAPAGEORGE, (U.S. CLS. 2, 5, 22, 23, 29, 37, 38 AND 50). SN 77-066,009. PUB. 7-31-2007. FILED 12-17-2006.
- 3,310,867. **\$5 COFFEE TIME CALL ME TIME PREPAID PHONE CARD NO CONNECTION FEE AND DESIGN**. VOICE PREPAID, INC., (U.S. CLS. 2, 5, 22, 23, 29, 37, 38 AND 50). SN 77-067,758. PUB. 7-31-2007. FILED 12-19-2006.
- 3,310,876. **MC MAN-CARDS.NET (STYLIZED)**. MAN-MADE ENTERPRISES, L.P., (U.S. CLS. 2, 5, 22, 23, 29, 37, 38 AND 50). SN 77-068,001. PUB. 7-31-2007. FILED 12-20-2006.
- 3,310,877. **DBUSINESS (STYLIZED)**. HOUR MEDIA, LLC, (U.S. CLS. 2, 5, 22, 23, 29, 37, 38 AND 50). SN 77-068,106. PUB. 7-31-2007. FILED 12-20-2006.
- 3,310,940. **VMV HYPOALLERGENICS (BLOCK FORM)**. VER-ALLO-ROWELL, DRA. VERMÉN, (U.S. CLS. 2, 5, 22, 23, 29, 37, 38 AND 50). SN 77-070,673. PUB. 7-31-2007. FILED 12-22-2006.
- 3,310,977. **HERE FOR YOU CENTRAL (BLOCK FORM)**. DAILEY, ANTRONE, (U.S. CLS. 2, 5, 22, 23, 29, 37, 38 AND 50). SN 77-071,802. PUB. 7-31-2007. FILED 12-27-2006.
- 3,310,980. **MENTORING MINDS (BLOCK FORM)**. MENTOR-ING MINDS, L.P., (U.S. CLS. 2, 5, 22, 23, 29, 37, 38 AND 50). SN 77-071,878. PUB. 7-31-2007. FILED 12-27-2006.
- 3,311,024. **READING POWER ESSENTIALS RPE THE RIGHT MEASURES FOR READING SUCCESS AND DESIGN**. QUESTAR ASSESSMENT, INC., (U.S. CLS. 2, 5, 22, 23, 29, 37, 38 AND 50). SN 77-072,637. PUB. 7-10-2007. FILED 12-28-2006.
- 3,311,054. **AEROGARDEN (BLOCK FORM)**. AEROGROW INTERNATIONAL, INC., (U.S. CLS. 2, 5, 22, 23, 29, 37, 38 AND 50). SN 77-073,362. PUB. 7-31-2007. FILED 12-29-2006.
- 3,311,072. **CRESCENT MOON GALLERIES (BLOCK FORM)**. VERITY, JULIE L., (U.S. CLS. 2, 5, 22, 23, 29, 37, 38 AND 50). SN 77-073,848. PUB. 7-31-2007. FILED 12-30-2006.
- 3,311,073. **HOLY ORIGINALS AND DESIGN**. HAWKINS, BETH KINGSLEY, MULTIPLE CLASS, (INT. CLS. 16 AND 45), (U.S. CLS. 2, 5, 22, 23, 29, 37, 38, 50, 100 AND 101). SN 77-073,850. PUB. 7-31-2007. FILED 12-30-2006.
- 3,311,103. **MEDPICC (BLOCK FORM)**. MEDTEXX MEDICAL CORPORATION, (U.S. CLS. 2, 5, 22, 23, 29, 37, 38 AND 50). SN 77-074,572. PUB. 7-31-2007. FILED 1-2-2007.
- 3,311,158. **RN CAREERSEARCH (BLOCK FORM)**. ADVAN-STAR COMMUNICATIONS INC., (U.S. CLS. 2, 5, 22, 23, 29,

- 37, 38 AND 50). SN 77-079,529. PUB. 7-31-2007. FILED 1-10-2007.
- 3,311,186. **TANGO (BLOCK FORM)**. SAN ANTONIO LIGHTHOUSE, (U.S. CLS. 2, 5, 22, 23, 29, 37, 38 AND 50). SN 77-081,795. PUB. 7-31-2007. FILED 1-12-2007.
- 3,311,223. **WATER QUALITY PRODUCTS (BLOCK FORM)**. SCRANTON GILLETTE COMMUNICATIONS, INC., (U.S. CLS. 2, 5, 22, 23, 29, 37, 38 AND 50). SN 77-085,468. PUB. 7-31-2007. FILED 1-18-2007.
- 3,311,329. **CLINSYS CLINICAL RESEARCH, INC. (BLOCK FORM)**. CLINSYS CLINICAL RESEARCH, INC., MULTIPLE CLASS, (INT. CLS. 16, 35 AND 42), (U.S. CLS. 2, 5, 22, 23, 29, 37, 38, 50, 100, 101 AND 102). SN 77-094,273. PUB. 7-31-2007. FILED 1-30-2007.
- 3,311,330 (*See Class 6 for this trademark*).
- 3,311,364. **MISCELLANEOUS DESIGN**. S-ANON INTERNATIONAL FAMILY GROUPS, MULTIPLE CLASS, (INT. CLS. 16 AND 45), (U.S. CLS. 2, 5, 22, 23, 29, 37, 38, 50, 100 AND 101). SN 77-096,701. PUB. 7-31-2007. FILED 2-1-2007.
- 3,311,391. **NATIONAL FITNESS TRADE JOURNAL (BLOCK FORM)**. WALLY BOYKO PRODUCTIONS, INC., (U.S. CLS. 2, 5, 22, 23, 29, 37, 38 AND 50). SN 77-098,018. PUB. 7-31-2007. FILED 2-2-2007.
- 3,311,407. **HOW'S YOUR PEN DANGLING? (BLOCK FORM)**. DANGLE PENS, INC., (U.S. CLS. 2, 5, 22, 23, 29, 37, 38 AND 50). SN 77-098,482. PUB. 7-31-2007. FILED 2-2-2007.
- 3,311,435. **DILLY AND FRIENDS (BLOCK FORM)**. ROBERT-LESLIE PUBLISHING LLC, MULTIPLE CLASS, (INT. CLS. 16 AND 28), (U.S. CLS. 2, 5, 22, 23, 29, 37, 38 AND 50). SN 77-099,365. PUB. 7-31-2007. FILED 2-5-2007.
- 3,311,436. **LA MAS CHIDA (BLOCK FORM)**. EASY CALL INC, MULTIPLE CLASS, (INT. CLS. 16 AND 36), (U.S. CLS. 2, 5, 22, 23, 29, 37, 38, 50, 100, 101 AND 102). SN 77-099,399. PUB. 7-31-2007. FILED 2-5-2007.
- 3,311,443 (*See Class 6 for this trademark*).
- 3,311,444. **THE CLARITY REPORT (BLOCK FORM)**. THE CLARITY GROUP, INC., (U.S. CLS. 2, 5, 22, 23, 29, 37, 38 AND 50). SN 77-099,638. PUB. 7-31-2007. FILED 2-5-2007.
- 3,311,446 (*See Class 3 for this trademark*).
- 3,311,454. **MISCELLANEOUS DESIGN**. KOREA KYOCHARO COMPANY LIMITED, (U.S. CLS. 2, 5, 22, 23, 29, 37, 38 AND 50). SN 77-100,235. PUB. 7-31-2007. FILED 2-6-2007.
- 3,311,455. **KYOCHARO AND DESIGN**. KOREA KYOCHARO COMPANY LIMITED, (U.S. CLS. 2, 5, 22, 23, 29, 37, 38 AND 50). SN 77-100,270. PUB. 7-31-2007. FILED 2-6-2007.
- 3,311,469. **STICKERKING AND DESIGN**. TSAI, ALEX H.N., (U.S. CLS. 2, 5, 22, 23, 29, 37, 38 AND 50). SN 77-101,436. PUB. 7-31-2007. FILED 2-7-2007.
- 3,311,493. **C AND DESIGN**. SAPIEN, ENRIQUE, (U.S. CLS. 2, 5, 22, 23, 29, 37, 38 AND 50). SN 77-104,353. PUB. 7-31-2007. FILED 2-10-2007.
- 3,311,510. **GRANDMA PUTT (BLOCK FORM)**. AMERICAN MASTER PRODUCTS, INC., (U.S. CLS. 2, 5, 22, 23, 29, 37, 38 AND 50). SN 77-108,981. PUB. 7-31-2007. FILED 2-16-2007.
- 3,311,515. **AMERICAN FITNESS (BLOCK FORM)**. AEROBICS AND FITNESS ASSOCIATION OF AMERICA, (U.S. CLS. 2, 5, 22, 23, 29, 37, 38 AND 50). SN 77-109,963. PUB. 7-31-2007. FILED 2-16-2007.
- 3,311,529. **SWANSTONE WYNOT (BLOCK FORM)**. ELLIOTT, STEPHEN B., (U.S. CLS. 2, 5, 22, 23, 29, 37, 38 AND 50). SN 77-112,841. PUB. 7-31-2007. FILED 2-21-2007.
- 3,311,542. **AMERICAN NURSING STUDENT (BLOCK FORM)**. WOLTERS KLUWER HEALTH, INC., (U.S. CLS. 2, 5, 22, 23, 29, 37, 38 AND 50). SN 77-116,286. PUB. 7-31-2007. FILED 2-26-2007.
- 3,311,559. **I AND DESIGN**. AMERICAN HEALTH ASSISTANCE FOUNDATION, MULTIPLE CLASS, (INT. CLS. 16, 35, 36 AND 44), (U.S. CLS. 2, 5, 22, 23, 29, 37, 38, 50, 100, 101 AND 102). SN 77-121,327. PUB. 7-31-2007. FILED 3-2-2007.
- 3,311,626 (*See Class 9 for this trademark*).
- 3,311,631 (*See Class 1 for this trademark*).
- 3,311,634 (*See Class 2 for this trademark*).
- 3,311,653 (*See Class 14 for this trademark*).
- 3,311,661. **CREATE A-SIZE (BLOCK FORM)**. GEORGIA-PACIFIC CONSUMER PRODUCTS LP, (U.S. CLS. 2, 5, 22, 23, 29, 37, 38 AND 50). SN 78-467,349. PUB. 7-31-2007. FILED 8-13-2004.
- 3,311,664 (*See Class 3 for this trademark*).
- 3,311,665. **GEOINT AND DESIGN**. UNITED STATES GEOSPATIAL INTELLIGENCE FOUNDATION, MULTIPLE CLASS, (INT. CLS. 16, 35 AND 41), (U.S. CLS. 2, 5, 22, 23, 29, 37, 38, 50, 100, 101, 102 AND 107). SN 78-493,643. PUB. 7-31-2007. FILED 10-3-2004.
- 3,311,690. **I AND DESIGN**. CREATIVE VENTURES, INC., MULTIPLE CLASS, (INT. CLS. 16 AND 41), (U.S. CLS. 2, 5, 22, 23, 29, 37, 38, 50, 100, 101 AND 107). SN 78-559,699. PUB. 7-31-2007. FILED 2-3-2005.
- 3,311,696 (*See Class 3 for this trademark*).
- 3,311,697 (*See Class 9 for this trademark*).
- 3,311,721 (*See Class 3 for this trademark*).
- 3,311,738. **OGSA (BLOCK FORM)**. OPEN GRID FORUM, MULTIPLE CLASS, (INT. CLS. 16 AND 41), (U.S. CLS. 2, 5, 22, 23, 29, 37, 38, 50, 100, 101 AND 107). SN 78-656,159. PUB. 7-31-2007. FILED 6-22-2005.
- 3,311,752. **CHILD MALTREATMENT AND DESIGN**. G.W. MEDICAL PUBLISHING, INC., (U.S. CLS. 2, 5, 22, 23, 29, 37, 38 AND 50). SN 78-676,093. PUB. 7-31-2007. FILED 7-22-2005.
- 3,311,755 (*See Class 9 for this trademark*).
- 3,311,764. **LIFECHECK WELLNESS PROFILE (BLOCK FORM)**. LIFECHECK LABORATORY, LLC, (U.S. CLS. 2, 5, 22, 23, 29, 37, 38 AND 50). SN 78-690,099. PUB. 7-31-2007. FILED 8-10-2005.
- 3,311,771. **ICOPY (BLOCK FORM)**. ICOPY, L.L.C., MULTIPLE CLASS, (INT. CLS. 16, 35 AND 39), (U.S. CLS. 2, 5, 22, 23, 29, 37, 38, 50, 100, 101, 102 AND 105). SN 78-695,597. PUB. 5-9-2006. FILED 8-18-2005.
- 3,311,781 (*See Class 1 for this trademark*).
- 3,311,785. **LIFE STORY (BLOCK FORM)**. BAUER PUBLISHING COMPANY, L.P., (U.S. CLS. 2, 5, 22, 23, 29, 37, 38 AND 50). SN 78-704,127. PUB. 7-31-2007. FILED 8-31-2005.
- 3,311,791 (*See Class 9 for this trademark*).
- 3,311,801. **THE ACQUISITIONS LIBRARIAN (BLOCK FORM)**. THE HAWORTH PRESS, INC., (U.S. CLS. 2, 5, 22, 23, 29, 37, 38 AND 50). SN 78-717,198. PUB. 7-31-2007. FILED 9-21-2005.
- 3,311,847. **COLLECTOR NETWORK (BLOCK FORM)**. THE HAGERTY GROUP, INC., MULTIPLE CLASS, (INT. CLS. 16 AND 39), (U.S. CLS. 2, 5, 22, 23, 29, 37, 38, 50, 100 AND 105). SN 78-744,514. PUB. 7-31-2007. FILED 11-1-2005.
- 3,311,856. **FISH LIPS (BLOCK FORM)**. GARRITY COMMUNICATIONS, INC., (U.S. CLS. 2, 5, 22, 23, 29, 37, 38 AND 50). SN 78-753,442. PUB. 7-31-2007. FILED 11-14-2005.
- 3,311,866. **SENTINEL (BLOCK FORM)**. SHEAFFER PEN CORPORATION, (U.S. CLS. 2, 5, 22, 23, 29, 37, 38 AND 50). SN 78-763,783. PUB. 7-31-2007. FILED 11-30-2005.
- 3,311,874. **MISCELLANEOUS DESIGN**. THE NED HERRMANN GROUP INC., MULTIPLE CLASS, (INT. CLS. 16 AND 35), (U.S. CLS. 2, 5, 22, 23, 29, 37, 38, 50, 100, 101 AND 102). SN 78-773,151. PUB. 7-31-2007. FILED 12-14-2005.
- 3,311,876. **PHARMA DDS (BLOCK FORM)**. STORA ENSO OYJ, (U.S. CLS. 2, 5, 22, 23, 29, 37, 38 AND 50). SN 78-775,003. PUB. 7-31-2007. FILED 12-16-2005.
- 3,311,877. **BERRIANGLES (BLOCK FORM)**. WBL ENTERPRISE LLC, (U.S. CLS. 2, 5, 22, 23, 29, 37, 38 AND 50). SN 78-775,080. PUB. 7-31-2007. FILED 12-16-2005.
- 3,311,883. **THE AMERICAN ALPINE CLUB (BLOCK FORM)**. THE AMERICAN ALPINE CLUB, MULTIPLE CLASS, (INT. CLS. 16, 41 AND 42), (U.S. CLS. 2, 5, 22, 23, 29, 37, 38, 50, 100, 101 AND 107). SN 78-779,635. PUB. 7-31-2007. FILED 12-22-2005.
- 3,311,887. **LA COQUETTE (BLOCK FORM)**. LA COQUETTE, (U.S. CLS. 2, 5, 22, 23, 29, 37, 38 AND 50). SN 78-782,757. PUB. 7-31-2007. FILED 12-29-2005.
- 3,311,898 (*See Class 3 for this trademark*).
- 3,311,900. **DIA DESARROLLO DE INTELIGENCIAS A TRAVES DEL ARTE AND DESIGN**. LA VACA INDEPENDIENTE, S.A. DE C.V., (U.S. CLS. 2, 5, 22, 23, 29, 37, 38 AND 50). SN 78-791,445. PUB. 7-3-2007. FILED 1-13-2006.
- 3,311,921 (*See Class 5 for this trademark*).
- 3,311,932 (*See Class 9 for this trademark*).
- 3,311,938. **SCREW (STYLIZED)**. DJK PUBLICATIONS, INC., (U.S. CLS. 2, 5, 22, 23, 29, 37, 38 AND 50). SN 78-812,505. PUB. 7-31-2007. FILED 2-10-2006.
- 3,311,939. **CAFS INSTITUTE AND DESIGN**. LIVE FIRE TRAINING INSTITUTE, INC., MULTIPLE CLASS, (INT.

- CLS. 16 AND 41), (U.S. CLS. 2, 5, 22, 23, 29, 37, 38, 50, 100, 101 AND 107). SN 78-813,009. PUB. 7-31-2007. FILED 2-12-2006.
- 3,311,949. **HARD OF HEARING HH AND DESIGN**. BOSSMAN, MARGARET ANN, (U.S. CLS. 2, 5, 22, 23, 29, 37, 38 AND 50). SN 78-821,872. PUB. 7-31-2007. FILED 2-23-2006.
- 3,311,950. **LA SEMANA POR E&N AND DESIGN**. NEGOCIOS EDITORIALES PANAMÁ, S.A., (U.S. CLS. 2, 5, 22, 23, 29, 37, 38 AND 50). SN 78-822,505. PUB. 7-31-2007. FILED 2-24-2006.
- 3,311,962. **DOTTIE LOVES... (BLOCK FORM)**. TARGET BRANDS, INC., MULTIPLE CLASS, (INT. CLS. 16 AND 35), (U.S. CLS. 2, 5, 22, 23, 29, 37, 38, 50, 100, 101 AND 102). SN 78-831,904. PUB. 7-31-2007. FILED 3-8-2006.
- 3,312,001. **NATIONAL SOCIETY OF HISPANIC MBAS (BLOCK FORM)**. NATIONAL SOCIETY OF HISPANIC MBAS, MULTIPLE CLASS, (INT. CLS. 16, 35, 36 AND 41), (U.S. CLS. 2, 5, 22, 23, 29, 37, 38, 50, 100, 101, 102 AND 107). SN 78-847,648. PUB. 7-31-2007. FILED 3-28-2006.
- 3,312,015 (*See Class 6 for this trademark*).
- 3,312,032 (*See Class 9 for this trademark*).
- 3,312,058. **RECURRENT CALENDAR (BLOCK FORM)**. ASHES TO ASHES, (U.S. CLS. 2, 5, 22, 23, 29, 37, 38 AND 50). SN 78-864,049. PUB. 7-31-2007. FILED 4-18-2006.
- 3,312,116. **MISCELLANEOUS DESIGN**. WESTERN PULP PRODUCTS CO., MULTIPLE CLASS, (INT. CLS. 16 AND 21), (U.S. CLS. 2, 5, 13, 22, 23, 29, 30, 33, 37, 38, 40 AND 50). SN 78-874,810. PUB. 7-31-2007. FILED 5-2-2006.
- 3,312,119. **BURNELL FOUNDATION (BLOCK FORM)**. BURNELL FOUNDATION, (U.S. CLS. 2, 5, 22, 23, 29, 37, 38 AND 50). SN 78-874,882. PUB. 7-31-2007. FILED 5-2-2006.
- 3,312,120. **GEB AND DESIGN**. BURNELL FOUNDATION, (U.S. CLS. 2, 5, 22, 23, 29, 37, 38 AND 50). SN 78-874,885. PUB. 7-31-2007. FILED 5-2-2006.
- 3,312,123. **NICK AND DESIGN**. VIACOM INTERNATIONAL INC., (U.S. CLS. 2, 5, 22, 23, 29, 37, 38 AND 50). SN 78-875,311. PUB. 7-31-2007. FILED 5-3-2006.
- 3,312,152. **BANFIELD (BLOCK FORM)**. MEDICAL MANAGEMENT INTERNATIONAL, INC., (U.S. CLS. 2, 5, 22, 23, 29, 37, 38 AND 50). SN 78-879,082. PUB. 7-31-2007. FILED 5-8-2006.
- 3,312,157. **FLAIR SHOWCASE (BLOCK FORM)**. FSB ACQUISITION COMPANY, LLC, (U.S. CLS. 2, 5, 22, 23, 29, 37, 38 AND 50). SN 78-880,344. PUB. 7-31-2007. FILED 5-10-2006.
- 3,312,180 (*See Class 9 for this trademark*).
- 3,312,196. **ST. VINCENT - ST. MARY (BLOCK FORM)**. ST. VINCENT - ST. MARY HIGH SCHOOL, MULTIPLE CLASS, (INT. CLS. 16, 25 AND 41), (U.S. CLS. 2, 5, 22, 23, 29, 37, 38, 39, 50, 100, 101 AND 107). SN 78-885,379. PUB. 7-31-2007. FILED 5-17-2006.
- 3,312,198. **HS SAINT VINCENT - SAINT MARY AND DESIGN**. ST. VINCENT - ST. MARY HIGH SCHOOL, MULTIPLE CLASS, (INT. CLS. 16 AND 41), (U.S. CLS. 2, 5, 22, 23, 29, 37, 38, 50, 100, 101 AND 107). SN 78-885,444. PUB. 7-31-2007. FILED 5-17-2006.
- 3,312,217. **STATE OF LOGISTICS REPORT (BLOCK FORM)**. COUNCIL OF LOGISTICS MANAGEMENT D/B/A COUNCIL OF SUPPLY CHAIN MANAGEMENT PROFESSIONALS, MULTIPLE CLASS, (INT. CLS. 16 AND 41), (U.S. CLS. 2, 5, 22, 23, 29, 37, 38, 50, 100, 101 AND 107). SN 78-887,061. PUB. 7-31-2007. FILED 5-18-2006.
- 3,312,239 (*See Class 9 for this trademark*).
- 3,312,249. **SOCIETY OF INCENTIVE & TRAVEL EXECUTIVES (BLOCK FORM)**. SOCIETY OF INCENTIVE & TRAVEL EXECUTIVES, MULTIPLE CLASS, (INT. CLS. 16, 35 AND 41), (U.S. CLS. 2, 5, 22, 23, 29, 37, 38, 50, 100, 101, 102 AND 107). SN 78-894,400. PUB. 7-31-2007. FILED 5-26-2006.
- 3,312,258. **ABOUTBUSINESS (BLOCK FORM)**. CITY OF EDINA, (U.S. CLS. 2, 5, 22, 23, 29, 37, 38 AND 50). SN 78-896,636. PUB. 7-31-2007. FILED 5-31-2006.
- 3,312,265. **STAR BABIES (BLOCK FORM)**. PHILLIPS, PAMELA, (U.S. CLS. 2, 5, 22, 23, 29, 37, 38 AND 50). SN 78-897,594. PUB. 7-31-2007. FILED 5-31-2006.
- 3,312,274. **LOOP CUBE (BLOCK FORM)**. METTLER, MICHAEL, DBA PAPIER-METTLER INHABER, (U.S. CLS. 2, 5, 22, 23, 29, 37, 38 AND 50). SN 78-899,385. PUB. 7-31-2007. FILED 6-2-2006.
- 3,312,300 (*See Class 9 for this trademark*).
- 3,312,302. **GET OUTTA TOWN (BLOCK FORM)**, MAD MAPS, INC., (U.S. CLS. 2, 5, 22, 23, 29, 37, 38 AND 50). SN 78-904,972. PUB. 7-31-2007. FILED 6-9-2006.
- 3,312,303. **RALLY RUN (BLOCK FORM)**, MAD MAPS, INC., (U.S. CLS. 2, 5, 22, 23, 29, 37, 38 AND 50). SN 78-905,073. PUB. 7-31-2007. FILED 6-9-2006.
- 3,312,328. **THINGS OF GOD 4 LESS (BLOCK FORM)**. CHRISTIAN WORKSHOP MINISTRIES, INC., (U.S. CLS. 2, 5, 22, 23, 29, 37, 38 AND 50). SN 78-908,850. PUB. 7-31-2007. FILED 6-15-2006.
- 3,312,348. **CUT TO FIT YOUR LIFE (BLOCK FORM)**. FREEDOM COMMUNICATIONS, INC. DBA THE ORANGE COUNTY REGISTER, MULTIPLE CLASS, (INT. CLS. 16 AND 41), (U.S. CLS. 2, 5, 22, 23, 29, 37, 38, 50, 100, 101 AND 107). SN 78-912,734. PUB. 7-31-2007. FILED 6-20-2006.
- 3,312,395 (*See Class 9 for this trademark*).
- 3,312,402. **SCRATCH-A-DOSE (BLOCK FORM)**. AMERICAN RESPIRATORY ALLIANCE OF WESTERN PENNSYLVANIA, (U.S. CLS. 2, 5, 22, 23, 29, 37, 38 AND 50). SN 78-922,340. PUB. 7-31-2007. FILED 7-5-2006.
- 3,312,414. **GREEN LIFE INTERIORS AND DESIGN**. PLANTS-CAPERS, LLC, MULTIPLE CLASS, (INT. CLS. 16, 35, 42 AND 44), (U.S. CLS. 2, 5, 22, 23, 29, 37, 38, 50, 100, 101 AND 102). SN 78-923,300. PUB. 7-31-2007. FILED 7-6-2006.
- 3,312,453. **AMERICAN ASSOCIATION FOR MARRIAGE AND FAMILY THERAPY (BLOCK FORM)**. AMERICAN ASSOCIATION FOR MARRIAGE AND FAMILY THERAPY, MULTIPLE CLASS, (INT. CLS. 16 AND 35), (U.S. CLS. 2, 5, 22, 23, 29, 37, 38, 50, 100, 101 AND 102). SN 78-928,556. PUB. 7-31-2007. FILED 7-13-2006.
- 3,312,455. **JOURNAL OF MARITAL AND FAMILY THERAPY (BLOCK FORM)**. AMERICAN ASSOCIATION FOR MARRIAGE AND FAMILY THERAPY, (U.S. CLS. 2, 5, 22, 23, 29, 37, 38 AND 50). SN 78-928,651. PUB. 7-31-2007. FILED 7-13-2006.
- 3,312,465 (*See Class 9 for this trademark*).
- 3,312,468. **AWESCAPES (BLOCK FORM)**. AARON SVENBY, MULTIPLE CLASS, (INT. CLS. 16 AND 35), (U.S. CLS. 2, 5, 22, 23, 29, 37, 38, 50, 100, 101 AND 102). SN 78-931,014. PUB. 7-31-2007. FILED 7-17-2006.
- 3,312,493. **THE PAPER DIVA (STYLIZED)**. THE PAPER DIVA, INC., (U.S. CLS. 2, 5, 22, 23, 29, 37, 38 AND 50). SN 78-934,625. PUB. 7-31-2007. FILED 7-21-2006.
- 3,312,506. **TEAM FOX (BLOCK FORM)**. MICHAEL J. FOX FOUNDATION FOR PARKINSON'S RESEARCH, MULTIPLE CLASS, (INT. CLS. 16, 35, 36 AND 41), (U.S. CLS. 2, 5, 22, 23, 29, 37, 38, 50, 100, 101, 102 AND 107). SN 78-936,787. PUB. 7-31-2007. FILED 7-25-2006.
- 3,312,536 (*See Class 6 for this trademark*).
- 3,312,558. **BANKNORTH (BLOCK FORM)**. TD BANKNORTH, INC., MULTIPLE CLASS, (INT. CLS. 16 AND 36), (U.S. CLS. 2, 5, 22, 23, 29, 37, 38, 50, 100, 101 AND 102). SN 78-948,090. PUB. 7-31-2007. FILED 8-9-2006.
- 3,312,581. **HOME & DESIGN (BLOCK FORM)**. SPANO, ANTHONY, MULTIPLE CLASS, (INT. CLS. 16 AND 41), (U.S. CLS. 2, 5, 22, 23, 29, 37, 38, 50, 100, 101 AND 107). SN 78-952,595. PUB. 7-31-2007. FILED 8-15-2006.
- 3,312,661. **SLEEP (BLOCK FORM)**. ASSOCIATED PROFESSIONAL SLEEP SOCIETIES, LLC, (U.S. CLS. 2, 5, 22, 23, 29, 37, 38 AND 50). SN 78-969,076. PUB. 7-31-2007. FILED 9-7-2006.
- 3,312,663. **NGI'S BIDWEEK SURVEY (BLOCK FORM)**. INTELLIGENCE PRESS INC., MULTIPLE CLASS, (INT. CLS. 16 AND 41), (U.S. CLS. 2, 5, 22, 23, 29, 37, 38, 50, 100, 101 AND 107). SN 78-969,182. PUB. 7-31-2007. FILED 9-7-2006.
- 3,312,685 (*See Class 9 for this trademark*).
- 3,312,702. **REVEAL YOUR TALENTS (BLOCK FORM)**. CONDAT, MULTIPLE CLASS, (INT. CLS. 16 AND 40), (U.S. CLS. 2, 5, 22, 23, 29, 37, 38, 50, 100, 103 AND 106). SN 79-004,200. PUB. 7-31-2007. FILED 5-24-2004.
- 3,312,703 (*See Class 9 for this trademark*).
- 3,312,704 (*See Class 5 for this trademark*).
- 3,312,707. **INTERNI (BLOCK FORM)**. ARNOLDO MONDADORI EDITORE S.P.A., (U.S. CLS. 2, 5, 22, 23, 29, 37, 38 AND 50). SN 79-011,417. PUB. 7-31-2007. FILED 4-22-2005.
- 3,312,713. **MINDO (BLOCK FORM)**. MINDO AB, MULTIPLE CLASS, (INT. CLS. 16, 35 AND 41), (U.S. CLS. 2, 5, 22, 23, 29, 37, 38, 50, 100, 101, 102 AND 107). SN 79-014,383. PUB. 7-31-2007. FILED 1-20-2005.

3,312,733 (*See Class 9 for this trademark.*)
 3,312,739 (*See Class 9 for this trademark.*)
 3,312,763. **MM (STYLIZED)**. LEIPZIGER MESSE GMBH, MULTIPLE CLASS, (INT. CLS. 16, 35, 38, 39, 41 AND 42), (U.S. CLS. 2, 5, 22, 23, 29, 37, 38, 50, 100, 101, 102, 104, 105 AND 107). SN 79-024,163. PUB. 7-31-2007. FILED 2-3-2006.
 3,312,782 (*See Class 9 for this trademark.*)
 3,312,794 (*See Class 9 for this trademark.*)
 3,312,810. **KOEHLER PAPER GROUP AND DESIGN**. PAPIER-FABRIK AUGUST KOEHLER AG, (U.S. CLS. 2, 5, 22, 23, 29, 37, 38 AND 50). SN 79-026,871. PUB. 7-31-2007. FILED 11-10-2005.
 3,312,826 (*See Class 6 for this trademark.*)
 3,312,848. **TSINGHUA (STYLIZED)**. TSINGHUA UNIVERSITY, MULTIPLE CLASS, (INT. CLS. 16, 41 AND 42), (U.S. CLS. 2, 5, 22, 23, 29, 37, 38, 50, 100, 101 AND 107). SN 79-028,452. PUB. 7-31-2007. FILED 1-9-2006.
 3,312,857 (*See Class 11 for this trademark.*)
 3,312,874 (*See Class 9 for this trademark.*)
 3,312,876 (*See Class 3 for this trademark.*)
 3,312,910 (*See Class 9 for this trademark.*)
 3,312,969 (*See Class 12 for this trademark.*)

CLASS 17—RUBBER GOODS

3,310,226 (*See Class 1 for this trademark.*)
 3,310,547. **HELPS KEEP BUGS OUT-AND COMFORT IN! (STYLIZED)**. HUDSON RIVER TRADING CO., INC. (U.S. CLS. 1, 5, 12, 13, 35 AND 50). SN 77-020,429. PUB. 7-31-2007. FILED 10-13-2006.
 3,310,711. **TRIMBRITE (BLOCK FORM)**. SHARPLINE CONVERTING, INC., (U.S. CLS. 1, 5, 12, 13, 35 AND 50). SN 77-049,094. PUB. 7-31-2007. FILED 11-21-2006.
 3,310,716. **ULTRAVISION (BLOCK FORM)**. ULTRAFLEX SYSTEMS, INC., (U.S. CLS. 1, 5, 12, 13, 35 AND 50). SN 77-049,911. PUB. 7-31-2007. FILED 11-22-2006.
 3,310,749. **WET-FLASH (BLOCK FORM)**. BUILDING ENVELOPE INNOVATIONS LLC, MULTIPLE CLASS, (INT. CLS. 17 AND 19), (U.S. CLS. 1, 5, 12, 13, 33, 35 AND 50). SN 77-054,324. PUB. 7-31-2007. FILED 11-30-2006.
 3,311,683. **RHINOCORE (BLOCK FORM)**. THE DILLER CORPORATION, (U.S. CLS. 1, 5, 12, 13, 35 AND 50). SN 78-553,481. PUB. 7-31-2007. FILED 1-25-2005.
 3,311,719. **THERMA-COTE (BLOCK FORM)**. THERMA-COTE, INC., (U.S. CLS. 1, 5, 12, 13, 35 AND 50). SN 78-636,656. PUB. 7-31-2007. FILED 5-25-2005.
 3,311,872 (*See Class 6 for this trademark.*)
 3,312,005. **TAPE TENDER (BLOCK FORM)**. PRO-PAK INDUSTRIES, INC., (U.S. CLS. 1, 5, 12, 13, 35 AND 50). SN 78-848,132. PUB. 7-31-2007. FILED 3-28-2006.
 3,312,255 (*See Class 7 for this trademark.*)
 3,312,256 (*See Class 7 for this trademark.*)
 3,312,316 (*See Class 7 for this trademark.*)
 3,312,553. **PROPEX AND DESIGN**. PROPEX INC., MULTIPLE CLASS, (INT. CLS. 17, 19, 22, 24 AND 28), (U.S. CLS. 1, 2, 5, 7, 12, 13, 19, 22, 23, 33, 35, 38, 42 AND 50). SN 78-945,769. PUB. 7-31-2007. FILED 8-5-2006.
 3,312,620. **LUDIF (BLOCK FORM)**. LG CHEM, LTD., (U.S. CLS. 1, 5, 12, 13, 35 AND 50). SN 78-961,480. PUB. 7-31-2007. FILED 8-28-2006.
 3,312,701 (*See Class 1 for this trademark.*)
 3,312,801. **I-STRUT (STYLIZED)**. TECHNOFORM CAPRANO UND; BRUNNHOFER GMBH & CO. KG, (U.S. CLS. 1, 5, 12, 13, 35 AND 50). SN 79-026,324. PUB. 7-31-2007. FILED 6-9-2006.
 3,312,808. **EDV PACKAGING (BLOCK FORM)**. ENVASES DEL VALLES, S.A., MULTIPLE CLASS, (INT. CLS. 17, 20 AND 40), (U.S. CLS. 1, 2, 5, 12, 13, 22, 25, 32, 35, 50, 100, 103 AND 106). SN 79-026,765. PUB. 7-31-2007. FILED 6-15-2006.
 3,312,845 (*See Class 1 for this trademark.*)
 3,312,857 (*See Class 11 for this trademark.*)
 3,312,892 (*See Class 1 for this trademark.*)
 3,312,893 (*See Class 1 for this trademark.*)
 3,312,911 (*See Class 11 for this trademark.*)
 3,312,954. **ADPO FIT YOUR STYLE AND DESIGN**. LIANG XIAO BIN, (U.S. CLS. 1, 5, 12, 13, 35 AND 50). SN 79-034,468.

PUB. 7-31-2007. FILED 11-28-2006.

CLASS 18—LEATHER GOODS

3,310,204 (*See Class 3 for this trademark.*)
 3,310,206 (*See Class 8 for this trademark.*)
 3,310,229. **GREAT PLAINS**. HOLLY HUNT LTD., MULTIPLE CLASS, (INT. CLS. 18 AND 24), (U.S. CLS. 1, 2, 3, 22, 41, 42 AND 50). SN 76-500,205. PUB. 7-31-2007. FILED 3-25-2003.
 3,310,235 (*See Class 9 for this trademark.*)
 3,310,302. **A AND DESIGN**. SSP ENTERPRISES - AYS, LLC, (U.S. CLS. 1, 2, 3, 22 AND 41). SN 76-657,935. PUB. 7-31-2007. FILED 4-6-2006.
 3,310,353. **SHOE SACKS AND DESIGN**. BELTER, MARIANNE WILLIAMS, (U.S. CLS. 1, 2, 3, 22 AND 41). SN 76-665,504. PUB. 7-31-2007. FILED 8-31-2006.
 3,310,442. **BULLYWARE IF YOU THINK ITS THERE AND DESIGN**. ROCKIT SCIENCE LABS, LLC, (U.S. CLS. 1, 2, 3, 22 AND 41). SN 77-003,129. PUB. 7-31-2007. FILED 9-20-2006.
 3,310,488. **PILLOW BRELLA PACK (BLOCK FORM)**. ROPER, JESSE, III, (U.S. CLS. 1, 2, 3, 22 AND 41). SN 77-011,342. PUB. 7-31-2007. FILED 10-1-2006.
 3,310,542 (*See Class 6 for this trademark.*)
 3,310,684 (*See Class 16 for this trademark.*)
 3,310,765 (*See Class 16 for this trademark.*)
 3,310,941. **VMV HYPOALLERGENICS (BLOCK FORM)**. VER-ALLO-ROWELL, DRA. VERMÈN, (U.S. CLS. 1, 2, 3, 22 AND 41). SN 77-070,691. PUB. 7-31-2007. FILED 12-22-2006.
 3,310,965. **PUT SOME WOW IN YOUR BOW-WOW! (BLOCK FORM)**. PUP-PUP DESIGNS, LLC, (U.S. CLS. 1, 2, 3, 22 AND 41). SN 77-071,399. PUB. 7-31-2007. FILED 12-26-2006.
 3,310,994 (*See Class 9 for this trademark.*)
 3,311,145 (*See Class 14 for this trademark.*)
 3,311,198. **COPOFLOR AND DESIGN**. XU JIAMAN, MULTIPLE CLASS, (INT. CLS. 18 AND 25), (U.S. CLS. 1, 2, 3, 22, 39 AND 41). SN 77-083,090. PUB. 7-31-2007. FILED 1-15-2007.
 3,311,286. **KS AND DESIGN**. KATE SPADE LLC, (U.S. CLS. 1, 2, 3, 22 AND 41). SN 77-090,161. PUB. 7-17-2007. FILED 1-24-2007.
 3,311,299. **M2M (BLOCK FORM)**. PHS INTERNATIONAL, MULTIPLE CLASS, (INT. CLS. 18 AND 25), (U.S. CLS. 1, 2, 3, 22, 39 AND 41). SN 77-091,313. PUB. 7-31-2007. FILED 1-25-2007.
 3,311,437. **ZHANNA ZABOLOTSKAIA (BLOCK FORM)**. ZABOLOTSKAIA, ZHANNA, (U.S. CLS. 1, 2, 3, 22 AND 41). SN 77-099,401. PUB. 7-31-2007. FILED 2-5-2007.
 3,311,554. **HEATHER'S HANDBAGS (BLOCK FORM)**. MAR-KEL, HEATHER JILL, (U.S. CLS. 1, 2, 3, 22 AND 41). SN 77-118,813. PUB. 7-31-2007. FILED 2-28-2007.
 3,311,586. **EYEFUL (BLOCK FORM)**. RAM FASHION ACCESSORIES, INC., (U.S. CLS. 1, 2, 3, 22 AND 41). SN 77-129,593. PUB. 7-31-2007. FILED 3-13-2007.
 3,311,630. **MISCELLANEOUS DESIGN**. LABELL S.A., MULTIPLE CLASS, (INT. CLS. 18, 25, 35 AND 42), (U.S. CLS. 1, 2, 3, 22, 39, 41, 100, 101 AND 102). SN 78-127,742. PUB. 7-31-2007. FILED 5-10-2002.
 3,311,639. **AZPE**. MMI, S.A. DE C.V., (U.S. CLS. 1, 2, 3, 22 AND 41). SN 78-219,810. PUB. 7-31-2007. FILED 2-27-2003.
 3,311,649 (*See Class 14 for this trademark.*)
 3,311,684 (*See Class 9 for this trademark.*)
 3,311,696 (*See Class 3 for this trademark.*)
 3,311,718. **BOLZANO (STYLIZED)**. DUTY FREE WORLD, INC., (U.S. CLS. 1, 2, 3, 22 AND 41). SN 78-635,155. PUB. 7-31-2007. FILED 5-23-2005.
 3,311,721 (*See Class 3 for this trademark.*)
 3,312,108 (*See Class 9 for this trademark.*)
 3,312,195. **CHIEN COATURE AND DESIGN**. CHIEN COATURE LLC, MULTIPLE CLASS, (INT. CLS. 18 AND 35), (U.S. CLS. 1, 2, 3, 22, 41, 100, 101 AND 102). SN 78-885,102. PUB. 4-24-2007. FILED 5-16-2006.
 3,312,212 (*See Class 3 for this trademark.*)
 3,312,248. **MISCELLANEOUS DESIGN**. VIKING SURFBOARDS, INC., MULTIPLE CLASS, (INT. CLS. 18, 25 AND 28), (U.S. CLS. 1, 2, 3, 22, 23, 38, 39, 41 AND 50). SN 78-894,380. PUB. 7-31-2007. FILED 5-26-2006.
 3,312,286. **DULCE (BLOCK FORM)**. DEHAVEN, DULCE

- BURGOS, (U.S. CLS. 1, 2, 3, 22 AND 41). SN 78-902,127. PUB. 7-31-2007. FILED 6-6-2006.
- 3,312,505. **PET4PETS (BLOCK FORM)**. GENIA LLC, (U.S. CLS. 1, 2, 3, 22 AND 41). SN 78-936,454. PUB. 7-31-2007. FILED 7-24-2006.
- 3,312,536 (*See Class 6 for this trademark*).
- 3,312,557. **THE SMALL BAG WITH BIG POSSIBILITIES! (BLOCK FORM)**. STONE CREEK CREATIONS, INC., (U.S. CLS. 1, 2, 3, 22 AND 41). SN 78-947,497. PUB. 7-31-2007. FILED 8-8-2006.
- 3,312,716 (*See Class 12 for this trademark*).
- 3,312,722 (*See Class 9 for this trademark*).
- 3,312,745 (*See Class 3 for this trademark*).
- 3,312,750 (*See Class 3 for this trademark*).
- 3,312,754. **HORZE (STYLIZED)**. HORZE OY, MULTIPLE CLASS, (INT. CLS. 18, 25 AND 28), (U.S. CLS. 1, 2, 3, 22, 23, 38, 39, 41 AND 50). SN 79-021,902. PUB. 7-31-2007. FILED 12-19-2005.
- 3,312,757. **PRO META ANA TELO (CELL) DVSN AND DESIGN**. BENOUSAAD JAAFAR, MULTIPLE CLASS, (INT. CLS. 18, 25 AND 28), (U.S. CLS. 1, 2, 3, 22, 23, 38, 39, 41 AND 50). SN 79-022,734. PUB. 4-10-2007. FILED 1-17-2006.
- 3,312,761. **POWERSHIRT (BLOCK FORM)**. GÜNTER HOLZNER, (U.S. CLS. 1, 2, 3, 22 AND 41). SN 79-023,671. PUB. 7-31-2007. FILED 4-11-2006.
- 3,312,771 (*See Class 14 for this trademark*).
- 3,312,772 (*See Class 14 for this trademark*).
- 3,312,783 (*See Class 3 for this trademark*).
- 3,312,786 (*See Class 3 for this trademark*).
- 3,312,805. **EPE EXPLOREPLANETEARTH AND DESIGN**. EXPLORE PLANET EARTH PTY LTD, MULTIPLE CLASS, (INT. CLS. 18, 20, 22 AND 25), (U.S. CLS. 1, 2, 3, 7, 13, 19, 22, 25, 32, 39, 41, 42 AND 50). SN 79-026,368. PUB. 7-31-2007. FILED 7-6-2006.
- 3,312,820 (*See Class 9 for this trademark*).
- 3,312,827. **DESIGNERS INVITATION PROJECT (BLOCK FORM)**. KABUSHIKI KAISHA FAST RETAILING, MULTIPLE CLASS, (INT. CLS. 18 AND 25), (U.S. CLS. 1, 2, 3, 22, 39 AND 41). SN 79-027,457. PUB. 7-31-2007. FILED 6-30-2006.
- 3,312,833 (*See Class 8 for this trademark*).
- 3,312,866 (*See Class 9 for this trademark*).
- 3,312,871. **SUPERREAL (BLOCK FORM)**. LAUNDRY ATHLETICS LLP, (U.S. CLS. 1, 2, 3, 22 AND 41). SN 79-029,378. PUB. 7-31-2007. FILED 8-18-2006.
- 3,312,875 (*See Class 3 for this trademark*).
- 3,312,876 (*See Class 3 for this trademark*).
- 3,312,880 (*See Class 9 for this trademark*).
- 3,312,891 (*See Class 9 for this trademark*).
- 3,312,894. **NAKETANO (BLOCK FORM)**. SASCHA PELJHAN, AND JOZO LONAC, MULTIPLE CLASS, (INT. CLS. 18, 25 AND 42), (U.S. CLS. 1, 2, 3, 22, 39, 41, 100 AND 101). SN 79-030,061. PUB. 7-31-2007. FILED 10-31-2005.
- 3,312,898 (*See Class 9 for this trademark*).
- 3,312,925. **OROBIANCO L'UNIQUE AND DESIGN**. OROBIANCO S.R.L., MULTIPLE CLASS, (INT. CLS. 18 AND 25), (U.S. CLS. 1, 2, 3, 22, 39 AND 41). SN 79-031,710. PUB. 7-31-2007. FILED 9-19-2006.
- 3,312,927. **ROBERT IN'T VELD (BLOCK FORM)**. GELD S.R.L., MULTIPLE CLASS, (INT. CLS. 18 AND 25), (U.S. CLS. 1, 2, 3, 22, 39 AND 41). SN 79-031,870. PUB. 7-31-2007. FILED 9-26-2006.
- 3,312,959. **LOCKIT (BLOCK FORM)**. LOUIS VUITTON MALLETIER, (U.S. CLS. 1, 2, 3, 22 AND 41). SN 79-035,046. PUB. 7-31-2007. FILED 1-16-2007.
- ENTERPRISES, LLC, (U.S. CLS. 1, 12, 33 AND 50). SN 76-657,781. PUB. 7-31-2007. FILED 4-3-2006.
- 3,310,303. **LEXWOOD (BLOCK FORM)**. TA CHEN INTERNATIONAL, INC., (U.S. CLS. 1, 12, 33 AND 50). SN 76-658,428. PUB. 7-10-2007. FILED 4-14-2006.
- 3,310,350. **HURRICANE GLASS AND DESIGN**. REGENCY PLUS, INC., (U.S. CLS. 1, 12, 33 AND 50). SN 76-664,704. PUB. 7-31-2007. FILED S.R. 8-16-2006; AM. P.R. 6-22-2007.
- 3,310,507. **CAST-CRETE (STYLIZED)**. FLORIDA ENGINEERED CONSTRUCTION PRODUCTS CORPORATION, (U.S. CLS. 1, 12, 33 AND 50). SN 77-014,468. PUB. 7-31-2007. FILED 10-5-2006.
- 3,310,631. **SECURCOAT (BLOCK FORM)**. D.B.M. IMPORT, EXPORT, INC., (U.S. CLS. 1, 12, 33 AND 50). SN 77-036,580. PUB. 7-31-2007. FILED 11-3-2006.
- 3,310,633. **SECRET DOORWAYS (BLOCK FORM)**. SECRET DOORWAYS, INC., (U.S. CLS. 1, 12, 33 AND 50). SN 77-037,003. PUB. 7-31-2007. FILED 11-4-2006.
- 3,310,658. **THE SLIDING DOOR CO., INC. AND DESIGN**. THE SLIDING DOOR COMPANY, INC., (U.S. CLS. 1, 12, 33 AND 50). SN 77-040,789. PUB. 7-17-2007. FILED 11-9-2006.
- 3,310,717. **IQ (BLOCK FORM)**. TARKETT INC., MULTIPLE CLASS, (INT. CLS. 19 AND 27), (U.S. CLS. 1, 12, 19, 20, 33, 37, 42 AND 50). SN 77-049,974. PUB. 7-31-2007. FILED 11-22-2006.
- 3,310,749 (*See Class 17 for this trademark*).
- 3,310,779. **PANTHEON COMPLETE AND DESIGN**. PANTHEON FLOOR SOLUTIONS, (U.S. CLS. 1, 12, 33 AND 50). SN 77-058,796. PUB. 7-31-2007. FILED 12-7-2006.
- 3,310,883. **ENVIRO-NET (BLOCK FORM)**. ENVIRO-SAN CORPORATION, (U.S. CLS. 1, 12, 33 AND 50). SN 77-068,403. PUB. 7-31-2007. FILED 12-20-2006.
- 3,311,057. **ROLLING GREEN RG AND DESIGN**. BUCK SWINDLE ASSOCIATES, INC., (U.S. CLS. 1, 12, 33 AND 50). SN 77-073,383. PUB. 7-31-2007. FILED 12-29-2006.
- 3,311,406. **KLEAR CHOICE (STYLIZED)**. CONSOLIDATED MOULDING & MILLWORK COMPANY, LLC, (U.S. CLS. 1, 12, 33 AND 50). SN 77-098,462. PUB. 7-31-2007. FILED 2-2-2007.
- 3,311,629. **CLIFFSTONE**. ELDORADO STONE OPERATIONS LLC, (U.S. CLS. 1, 12, 33 AND 50). SN 78-119,003. PUB. 10-18-2005. FILED 4-2-2002.
- 3,311,717. **MISCELLANEOUS DESIGN**. WEYERHAEUSER COMPANY, (U.S. CLS. 1, 12, 33 AND 50). SN 78-633,844. PUB. 7-31-2007. FILED 5-20-2005.
- 3,311,760. **MOGANSHAN AND DESIGN**. ZHEJIANG SHENGHUA YUNFENG GREENNEO STOCK CO., LTD., AND DEQUINGXIAN SHENGQIANG WOOD CO., LTD, (U.S. CLS. 1, 12, 33 AND 50). SN 78-686,173. PUB. 7-31-2007. FILED 8-4-2005.
- 3,311,816 (*See Class 6 for this trademark*).
- 3,311,832. **ART FROM THE SATELLITE (BLOCK FORM)**. ROGERS, ANDREW, (U.S. CLS. 1, 12, 33 AND 50). SN 78-737,497. PUB. 7-31-2007. FILED 10-20-2005.
- 3,311,865. **RWM ROUND WINDOW MOULDINGS INC. AND DESIGN**. CHRISTENSEN, CAROLYN S., AND CHRISTENSEN, D. G. JOHN, MULTIPLE CLASS, (INT. CLS. 19, 37 AND 40), (U.S. CLS. 1, 12, 33, 50, 100, 103 AND 106). SN 78-763,712. PUB. 7-31-2007. FILED 11-30-2005.
- 3,312,044. **UNIBEST (BLOCK FORM)**. UNIBOARD CANADA INC., (U.S. CLS. 1, 12, 33 AND 50). SN 78-859,445. PUB. 7-31-2007. FILED 4-11-2006.
- 3,312,126. **LAZERQUICK (BLOCK FORM)**. GRAPHIC INFORMATION SYSTEMS, INC., MULTIPLE CLASS, (INT. CLS. 19, 20 AND 35), (U.S. CLS. 1, 2, 12, 13, 22, 25, 32, 33, 50, 100, 101 AND 102). SN 78-875,321. PUB. 7-31-2007. FILED 5-3-2006.
- 3,312,128. **LAZERQUICK (STYLIZED)**. GRAPHIC INFORMATION SYSTEMS, INC., MULTIPLE CLASS, (INT. CLS. 19, 20 AND 35), (U.S. CLS. 1, 2, 12, 13, 22, 25, 32, 33, 50, 100, 101 AND 102). SN 78-875,340. PUB. 7-31-2007. FILED 5-3-2006.
- 3,312,129. **MISCELLANEOUS DESIGN**. GRAPHIC INFORMATION SYSTEMS, INC., MULTIPLE CLASS, (INT. CLS. 19, 20 AND 35), (U.S. CLS. 1, 2, 12, 13, 22, 25, 32, 33, 50, 100, 101 AND 102). SN 78-875,360. PUB. 7-31-2007. FILED 5-3-2006.
- 3,312,376. **SEABLUE (BLOCK FORM)**. ALLIANCE TRADING, INC., MULTIPLE CLASS, (INT. CLS. 19 AND 35), (U.S.

CLASS 19—NON-METALLIC BUILDING MATERIALS

- 3,310,213. **NEWPORT DOORS RIGID VINYL PREMIUM SWINGDOORS (BLOCK FORM)**. ACADIA WINDOWS & DOORS, INC., (U.S. CLS. 1, 12, 33 AND 50). SN 76-273,892. PUB. 7-31-2007. FILED 6-20-2001.
- 3,310,254. **KODIAK MOUNTAIN STONE (BLOCK FORM)**. KODIAK MOUNTAIN STONE INC., (U.S. CLS. 1, 12, 33 AND 50). SN 76-637,987. PUB. 7-31-2007. FILED 5-6-2005.
- 3,310,300. **E-SEAM (BLOCK FORM)**. EDWARD MICHAEL

- CLS. 1, 12, 33, 50, 100, 101 AND 102). SN 78-918,660. PUB. 7-31-2007. FILED 6-28-2006.
- 3,312,377. **GORILLA (BLOCK FORM)**, HOMELAND VINYL PRODUCTS, INC., (U.S. CLS. 1, 12, 33 AND 50). SN 78-918,843. PUB. 7-31-2007. FILED 6-28-2006.
- 3,312,379. **BARKER-TILE (BLOCK FORM)**, J.J. BARKER COMPANY LIMITED, (U.S. CLS. 1, 12, 33 AND 50). SN 78-918,969. PUB. 7-31-2007. FILED 6-28-2006.
- 3,312,429. **FEATHERWEIGHT CONCRETE (BLOCK FORM)**, BRANTLEY SEAN, (U.S. CLS. 1, 12, 33 AND 50). SN 78-925,831. PUB. 7-31-2007. FILED 7-10-2006.
- 3,312,457. **CRETEWERX (BLOCK FORM)**, HERCO SERVICES, INC., (U.S. CLS. 1, 12, 33 AND 50). SN 78-928,763. PUB. 7-31-2007. FILED 7-13-2006.
- 3,312,466. **CLEAR CHOICE GATE (BLOCK FORM)**, NORTH STATES INDUSTRIES, INC., (U.S. CLS. 1, 12, 33 AND 50). SN 78-930,791. PUB. 7-31-2007. FILED 7-17-2006.
- 3,312,553 (*See Class 17 for this trademark*).
- 3,312,629. **POLY-CLASSIC (BLOCK FORM)**, CASCADE WOOD PRODUCTS, INC., (U.S. CLS. 1, 12, 33 AND 50). SN 78-962,410. PUB. 7-31-2007. FILED 8-29-2006.
- 3,312,701 (*See Class 1 for this trademark*).
- 3,312,718. **M M MAYR MELNHOF HOLZ AND DESIGN**, MAYR-MELNHOF HOLZ LEOBEN GMBH, (U.S. CLS. 1, 12, 33 AND 50). SN 79-015,329. PUB. 7-31-2007. FILED 8-12-2005.
- 3,312,737. **DANZER (BLOCK FORM)**, DANZER FURNIERWERKE GMBH, (U.S. CLS. 1, 12, 33 AND 50). SN 79-019,650. PUB. 7-31-2007. FILED 8-24-2005.
- 3,312,756 (*See Class 6 for this trademark*).
- 3,312,847. **HERA AND DESIGN**, ODORIZZI PORFIDI S.P.A., (U.S. CLS. 1, 12, 33 AND 50). SN 79-028,407. PUB. 7-31-2007. FILED 3-20-2006.
- 3,312,863 (*See Class 3 for this trademark*).
- 3,312,977 (*See Class 9 for this trademark*).

CLASS 20—FURNITURE AND ARTICLES NOT OTHERWISE CLASSIFIED

- 3,310,251 (*See Class 6 for this trademark*).
- 3,310,334. **RETREATS BY GRAND DESIGNS AND DESIGN**, STANDARD FURNITURE MANUFACTURING COMPANY, INC., (U.S. CLS. 2, 13, 22, 25, 32 AND 50). SN 76-662,811. PUB. 7-31-2007. FILED 7-10-2006.
- 3,310,335. **ESTATE CLASSICS BY GRAND DESIGNS AND DESIGN**, STANDARD FURNITURE MANUFACTURING COMPANY, INC., (U.S. CLS. 2, 13, 22, 25, 32 AND 50). SN 76-662,812. PUB. 7-31-2007. FILED 7-10-2006.
- 3,310,336. **CITY STYLE BY GRAND DESIGNS AND DESIGN**, STANDARD FURNITURE MANUFACTURING COMPANY, INC., (U.S. CLS. 2, 13, 22, 25, 32 AND 50). SN 76-662,814. PUB. 7-31-2007. FILED 7-10-2006.
- 3,310,366. **HEAT THERAPY (BLOCK FORM)**, PARK PLACE CORPORATION, (U.S. CLS. 2, 13, 22, 25, 32 AND 50). SN 76-667,606. PUB. 7-31-2007. FILED 10-13-2006.
- 3,310,367. **ECO THERAPY (BLOCK FORM)**, PARK PLACE CORPORATION, (U.S. CLS. 2, 13, 22, 25, 32 AND 50). SN 76-667,625. PUB. 7-31-2007. FILED 10-16-2006.
- 3,310,390. **POW'R LOUNGER (BLOCK FORM)**, CLEVELAND CHAIR COMPANY, (U.S. CLS. 2, 13, 22, 25, 32 AND 50). SN 76-670,250. PUB. 7-31-2007. FILED 12-12-2006.
- 3,310,407. **WILDING WALL BEDS (BLOCK FORM)**, WALL BEDS BY WILDING, LLC, (U.S. CLS. 2, 13, 22, 25, 32 AND 50). SN 76-671,076. PUB. 7-31-2007. FILED 12-29-2006.
- 3,310,408. **WILDING (BLOCK FORM)**, WALL BEDS BY WILDING, LLC, (U.S. CLS. 2, 13, 22, 25, 32 AND 50). SN 76-671,077. PUB. 7-31-2007. FILED 12-29-2006.
- 3,310,542 (*See Class 6 for this trademark*).
- 3,310,964. **ICE BUDDIES (BLOCK FORM)**, TSAI, ROGER K., (U.S. CLS. 2, 13, 22, 25, 32 AND 50). SN 77-071,372. PUB. 7-31-2007. FILED 12-26-2006.
- 3,311,107. **HOSER (BLOCK FORM)**, CHINA MANUFACTURING & BROKERAGE, INC., (U.S. CLS. 2, 13, 22, 25, 32 AND 50). SN 77-074,761. PUB. 7-31-2007. FILED 1-3-2007.
- 3,311,269. **PEACEFUL PAWS (BLOCK FORM)**, PEACEFUL PAWS PET CREMATION & MEMORIALS, INC., MULTIPLE CLASS, (INT. CLS. 20 AND 45), (U.S. CLS. 2, 13, 22, 25, 32, 50, 100 AND 101). SN 77-088,906. PUB. 7-31-2007. FILED 1-23-2007.
- 3,311,275. **PEACEFUL PAWS AND DESIGN**, PEACEFUL PAWS PET CREMATION & MEMORIALS, INC., MULTIPLE CLASS, (INT. CLS. 20 AND 45), (U.S. CLS. 2, 13, 22, 25, 32, 50, 100 AND 101). SN 77-089,435. PUB. 7-31-2007. FILED 1-23-2007.
- 3,311,289. **FUNKIO (STYLIZED)**, HART, RUPERT MICHAEL, (U.S. CLS. 2, 13, 22, 25, 32 AND 50). SN 77-090,333. PUB. 7-31-2007. FILED 1-24-2007.
- 3,311,322. **FITBALL (BLOCK FORM)**, BALL DYNAMICS INTERNATIONAL, LLC, (U.S. CLS. 2, 13, 22, 25, 32 AND 50). SN 77-093,536. PUB. 7-31-2007. FILED 1-29-2007.
- 3,311,443 (*See Class 6 for this trademark*).
- 3,311,538. **LE RUSTIQUE (BLOCK FORM)**, WINE MASTER CELLARS LLC, (U.S. CLS. 2, 13, 22, 25, 32 AND 50). SN 77-114,883. PUB. 7-31-2007. FILED 2-23-2007.
- 3,311,585. **SOMNA PEDIC (BLOCK FORM)**, SOMNUS MATTRESS CORPORATION, (U.S. CLS. 2, 13, 22, 25, 32 AND 50). SN 77-129,567. PUB. 7-31-2007. FILED 3-13-2007.
- 3,311,664 (*See Class 3 for this trademark*).
- 3,311,696 (*See Class 3 for this trademark*).
- 3,311,732 (*See Class 6 for this trademark*).
- 3,311,761. **SHELFWORKS TECHNOLOGIES (BLOCK FORM)**, SHELFWORKS TECHNOLOGIES, LLC, (U.S. CLS. 2, 13, 22, 25, 32 AND 50). SN 78-688,757. PUB. 7-31-2007. FILED 8-9-2005.
- 3,311,840. **NATCHEZ (BLOCK FORM)**, HISTORIC NATCHEZ FOUNDATION, (U.S. CLS. 2, 13, 22, 25, 32 AND 50). SN 78-741,123. PUB. 7-31-2007. FILED 10-26-2005.
- 3,311,848. **ELMAR (STYLIZED)**, ELMAR S.R.L., (U.S. CLS. 2, 13, 22, 25, 32 AND 50). SN 78-745,258. PUB. 7-31-2007. FILED 11-2-2005.
- 3,311,872 (*See Class 6 for this trademark*).
- 3,311,898 (*See Class 3 for this trademark*).
- 3,312,048. **MISCELLANEOUS DESIGN**, NINGBO QIFA FURNITURE CO., LTD, (U.S. CLS. 2, 13, 22, 25, 32 AND 50). SN 78-860,590. PUB. 7-31-2007. FILED 4-13-2006.
- 3,312,057. **SHAFFER COMMERCIAL SEATING AND DESIGN**, SHAFFER COMMERCIAL SEATING, INC., (U.S. CLS. 2, 13, 22, 25, 32 AND 50). SN 78-864,037. PUB. 7-31-2007. FILED 4-18-2006.
- 3,312,074. **TIME FOR BLINDS AND DESIGN**, SAUSE, MARK, F, AND SAUSE, BARBARA, J, (U.S. CLS. 2, 13, 22, 25, 32 AND 50). SN 78-867,104. PUB. 7-31-2007. FILED 4-21-2006.
- 3,312,126 (*See Class 19 for this trademark*).
- 3,312,128 (*See Class 19 for this trademark*).
- 3,312,129 (*See Class 19 for this trademark*).
- 3,312,277. **INTERMARKET TECHNOLOGY (BLOCK FORM)**, INTERMARKET TECHNOLOGY, INC., (U.S. CLS. 2, 13, 22, 25, 32 AND 50). SN 78-899,924. PUB. 7-31-2007. FILED 6-3-2006.
- 3,312,344. **BONAR PLASTICS (BLOCK FORM)**, PROMENS USA, INC., MULTIPLE CLASS, (INT. CLS. 20 AND 40), (U.S. CLS. 2, 13, 22, 25, 32, 50, 100, 103 AND 106). SN 78-912,339. PUB. 7-31-2007. FILED 6-20-2006.
- 3,312,536 (*See Class 6 for this trademark*).
- 3,312,574. **LYNXCAP (BLOCK FORM)**, TRI-LYNX CORPORATION, (U.S. CLS. 2, 13, 22, 25, 32 AND 50). SN 78-951,330. PUB. 7-31-2007. FILED 8-14-2006.
- 3,312,673. **SEASUCKER (BLOCK FORM)**, ADVERTACARD, LLC, (U.S. CLS. 2, 13, 22, 25, 32 AND 50). SN 78-971,396. PUB. 7-31-2007. FILED 9-11-2006.
- 3,312,741 (*See Class 6 for this trademark*).
- 3,312,748. **EMS AND DESIGN**, ESTRUCTURAS, MÓDULOS Y SISTEMAS S.A., MULTIPLE CLASS, (INT. CLS. 20 AND 42), (U.S. CLS. 2, 13, 22, 25, 32, 50, 100 AND 101). SN 79-021,237. PUB. 7-31-2007. FILED 8-18-2005.
- 3,312,785 (*See Class 15 for this trademark*).
- 3,312,791 (*See Class 6 for this trademark*).
- 3,312,800. **STOKKE (BLOCK FORM)**, STOKKE AS, (U.S. CLS. 2, 13, 22, 25, 32 AND 50). SN 79-026,246. PUB. 7-31-2007. FILED 12-17-2004.
- 3,312,805 (*See Class 18 for this trademark*).
- 3,312,808 (*See Class 17 for this trademark*).
- 3,312,826 (*See Class 6 for this trademark*).
- 3,312,881. **SVANE (BLOCK FORM)**, EKORNES ASA, (U.S.

CLS. 2, 13, 22, 25, 32 AND 50). SN 79-029,637. PUB. 7-31-2007. FILED 8-14-2006.
 3,312,886 (*See Class 6 for this trademark*).
 3,312,913 (*See Class 10 for this trademark*).
 3,312,958. **RWK AND DESIGN**. RWK EINBAUKÜCHEN R. & W. KUHLMANN GMBH, (U.S. CLS. 2, 13, 22, 25, 32 AND 50). SN 79-034,904. PUB. 7-31-2007. FILED 12-21-2006.
 3,312,960 (*See Class 6 for this trademark*).

CLASS 21—HOUSEWARES AND GLASS

3,310,210 (*See Class 7 for this trademark*).
 3,310,228. **THE WAITER'S FRIEND**. FENNER, PAUL, (U.S. CLS. 2, 13, 23, 29, 30, 33, 40 AND 50). SN 76-485,983. PUB. 2-28-2006. FILED 1-29-2003.
 3,310,241 (*See Class 8 for this trademark*).
 3,310,542 (*See Class 6 for this trademark*).
 3,310,718. **VIVID AND DESIGN**. VIVID ENTERTAINMENT, LLC, (U.S. CLS. 2, 13, 23, 29, 30, 33, 40 AND 50). SN 77-050,214. PUB. 7-31-2007. FILED 11-22-2006.
 3,310,908. **BRUSHLAB (BLOCK FORM)**. INTERNATIONAL BEAUTY PRODUCTS, (U.S. CLS. 2, 13, 23, 29, 30, 33, 40 AND 50). SN 77-069,163. PUB. 7-31-2007. FILED 12-21-2006.
 3,310,942. **VMV HYPOALLERGENICS (BLOCK FORM)**. VER-ALLO-ROWELL, DRA. VERMÉN, (U.S. CLS. 2, 13, 23, 29, 30, 33, 40 AND 50). SN 77-070,715. PUB. 7-31-2007. FILED 12-22-2006.
 3,310,996. **JAVA WAND (BLOCK FORM)**. RAIMONDO, NANCY, (U.S. CLS. 2, 13, 23, 29, 30, 33, 40 AND 50). SN 77-072,269. PUB. 7-31-2007. FILED 12-27-2006.
 3,310,997 (*See Class 14 for this trademark*).
 3,311,151 (*See Class 3 for this trademark*).
 3,311,330 (*See Class 6 for this trademark*).
 3,311,422. **MAGIC DOUGH (BLOCK FORM)**. MICROTHIN.-COM, INC., (U.S. CLS. 2, 13, 23, 29, 30, 33, 40 AND 50). SN 77-098,963. PUB. 7-31-2007. FILED 2-5-2007.
 3,311,423. **MAGIC DOUGH AND DESIGN**. MICROTHIN.-COM, INC., (U.S. CLS. 2, 13, 23, 29, 30, 33, 40 AND 50). SN 77-098,969. PUB. 7-31-2007. FILED 2-5-2007.
 3,311,443 (*See Class 6 for this trademark*).
 3,311,582. **VIOX (BLOCK FORM)**. VIOX CORPORATION, (U.S. CLS. 2, 13, 23, 29, 30, 33, 40 AND 50). SN 77-128,567. PUB. 7-31-2007. FILED 3-12-2007.
 3,311,664 (*See Class 3 for this trademark*).
 3,311,696 (*See Class 3 for this trademark*).
 3,311,721 (*See Class 3 for this trademark*).
 3,311,732 (*See Class 6 for this trademark*).
 3,311,819. **EASY REACH (BLOCK FORM)**. CARL FREUDENBERG KG, (U.S. CLS. 2, 13, 23, 29, 30, 33, 40 AND 50). SN 78-728,606. PUB. 7-31-2007. FILED 10-7-2005.
 3,311,875. **VACUUMSAVER (BLOCK FORM)**. CONCISE LIVING CO., LTD., (U.S. CLS. 2, 13, 23, 29, 30, 33, 40 AND 50). SN 78-773,170. PUB. 7-31-2007. FILED 12-14-2005.
 3,311,895 (*See Class 11 for this trademark*).
 3,311,898 (*See Class 3 for this trademark*).
 3,312,064. **STOLEN FROM MY ATTORNEY (BLOCK FORM)**. EDMUND RUGGER BURKE III, (U.S. CLS. 2, 13, 23, 29, 30, 33, 40 AND 50). SN 78-865,344. PUB. 7-31-2007. FILED 4-19-2006.
 3,312,108 (*See Class 9 for this trademark*).
 3,312,116 (*See Class 16 for this trademark*).
 3,312,141. **NEW ENGLAND COFFEE (BLOCK FORM)**. NEW ENGLAND TEA & COFFEE CO., INC., (U.S. CLS. 2, 13, 23, 29, 30, 33, 40 AND 50). SN 78-877,653. PUB. 7-31-2007. FILED 5-5-2006.
 3,312,237 (*See Class 8 for this trademark*).
 3,312,354. **MEDICINE PLATES (BLOCK FORM)**. NWT WORLD ARTS, INC., DBA NEW WORLD TRADING, (U.S. CLS. 2, 13, 23, 29, 30, 33, 40 AND 50). SN 78-913,365. PUB. 7-31-2007. FILED 6-21-2006.
 3,312,359 (*See Class 9 for this trademark*).
 3,312,397 (*See Class 6 for this trademark*).
 3,312,400 (*See Class 6 for this trademark*).
 3,312,536 (*See Class 6 for this trademark*).
 3,312,603. **HONOR (BLOCK FORM)**. HONOR PLASTIC INDUSTRIAL CO., LTD., (U.S. CLS. 2, 13, 23, 29, 30, 33, 40

AND 50). SN 78-958,654. PUB. 4-17-2007. FILED 8-23-2006.
 3,312,634. **CHEF'SDESIGN (BLOCK FORM)**. WISCONSIN ALUMINUM FOUNDRY COMPANY, INC., (U.S. CLS. 2, 13, 23, 29, 30, 33, 40 AND 50). SN 78-963,715. PUB. 7-31-2007. FILED 8-30-2006.
 3,312,715 (*See Class 8 for this trademark*).
 3,312,739 (*See Class 9 for this trademark*).
 3,312,741 (*See Class 6 for this trademark*).
 3,312,762 (*See Class 11 for this trademark*).
 3,312,776. **SUNNYWIPES AND DESIGN**. SUNNYWIPES PTY LTD. (U.S. CLS. 2, 13, 23, 29, 30, 33, 40 AND 50). SN 79-024,597. PUB. 7-31-2007. FILED 4-13-2006.
 3,312,783 (*See Class 3 for this trademark*).
 3,312,790. **CTJKLEP AND DESIGN**. TIANJIN KANGLI EN-AMEL; PRODUCTS CO., LTD., (U.S. CLS. 2, 13, 23, 29, 30, 33, 40 AND 50). SN 79-025,779. PUB. 7-31-2007. FILED 3-1-2006.
 3,312,791 (*See Class 6 for this trademark*).
 3,312,819 (*See Class 3 for this trademark*).
 3,312,826 (*See Class 6 for this trademark*).
 3,312,862 (*See Class 11 for this trademark*).

CLASS 22—CORDAGE AND FIBERS

3,310,234 (*See Class 1 for this trademark*).
 3,310,239. **MISCELLANEOUS DESIGN**. ARGONICS, INC., (U.S. CLS. 1, 2, 7, 19, 22, 42 AND 50). SN 76-571,089. PUB. 7-31-2007. FILED 1-16-2004.
 3,310,384. **DEMO BAGS TEAR RESISTANT BAGS AND DESIGN**. GLOBAL STRATEGIES, INC., (U.S. CLS. 1, 2, 7, 19, 22, 42 AND 50). SN 76-669,398. PUB. 7-31-2007. FILED 11-22-2006.
 3,310,499. **ECO-DREAM (BLOCK FORM)**. K2 INTERNATIONAL CO., LTD., MULTIPLE CLASS, (INT. CLS. 22, 24 AND 25). (U.S. CLS. 1, 2, 7, 19, 22, 39, 42 AND 50). SN 77-013,179. PUB. 7-17-2007. FILED 10-4-2006.
 3,311,898 (*See Class 3 for this trademark*).
 3,312,478 (*See Class 6 for this trademark*).
 3,312,553 (*See Class 17 for this trademark*).
 3,312,648. **SMITH BROTHERS (BLOCK FORM)**. SMITH BROTHERS, INC., (U.S. CLS. 1, 2, 7, 19, 22, 42 AND 50). SN 78-965,271. PUB. 7-31-2007. FILED 8-31-2006.
 3,312,652. **INSULCUBE (BLOCK FORM)**. BRANDON, JAMES W., III D/B/A HELM ENTERPRISES, AND BRANDON, SHELLY A., D/B/A HELM ENTERPRISES, (U.S. CLS. 1, 2, 7, 19, 22, 42 AND 50). SN 78-966,523. PUB. 7-31-2007. FILED 9-2-2006.
 3,312,712 (*See Class 1 for this trademark*).
 3,312,716 (*See Class 12 for this trademark*).
 3,312,805 (*See Class 18 for this trademark*).

CLASS 23—YARNS AND THREADS

3,310,850. **SPUNCOVER (BLOCK FORM)**. DYNAYARN USA, LLC, (U.S. CL. 43). SN 77-067,299. PUB. 7-31-2007. FILED 12-19-2006.
 3,311,698. **MAXI-LOCK SWIRLS (BLOCK FORM)**. AMERICAN & EFIRD ENTERPRISES, INC., (U.S. CL. 43). SN 78-579,481. PUB. 7-31-2007. FILED 3-3-2005.
 3,312,639. **BELISANA (BLOCK FORM)**. J. & P. COATS, LIMITED, (U.S. CL. 43). SN 78-964,604. PUB. 7-31-2007. FILED 8-31-2006.
 3,312,640. **BELISANA COLOR (BLOCK FORM)**. J. & P. COATS, LIMITED, (U.S. CL. 43). SN 78-964,607. PUB. 7-31-2007. FILED 8-31-2006.
 3,312,703 (*See Class 9 for this trademark*).
 3,312,812. **BAMBOO HITEX AND DESIGN**. ROHLEDER GMBH, MULTIPLE CLASS, (INT. CLS. 23, 24, 25 AND 27), (U.S. CLS. 19, 20, 22, 37, 39, 42, 43 AND 50). SN 79-026,924. PUB. 7-31-2007. FILED 5-11-2006.

CLASS 24—FABRICS

- 3,310,209. **HACO AND DESIGN**. HACO ETIQUETAS LTDA., MULTIPLE CLASS, (INT. CLS. 24 AND 26), (U.S. CLS. 37, 39, 40, 42 AND 50). SN 76-181,421. PUB. 7-31-2007. FILED 12-15-2000.
- 3,310,225 (*See Class 16 for this trademark*).
- 3,310,229 (*See Class 18 for this trademark*).
- 3,310,248 (*See Class 1 for this trademark*).
- 3,310,282. **F5 AND DESIGN**. MARLENA INTERNATIONAL, LLC., (U.S. CLS. 42 AND 50). SN 76-653,558. PUB. 7-31-2007. FILED 1-17-2006.
- 3,310,499 (*See Class 22 for this trademark*).
- 3,310,790. **SIMPLY SEDONA (BLOCK FORM)**. KEENAN, JUDITH L., (U.S. CLS. 42 AND 50). SN 77-060,614. PUB. 7-31-2007. FILED 12-8-2006.
- 3,310,997 (*See Class 14 for this trademark*).
- 3,311,039. **KIT-TEA KAT AND DESIGN**. FESQ, MONICA J., (U.S. CLS. 42 AND 50). SN 77-073,038. PUB. 7-31-2007. FILED 12-28-2006.
- 3,311,443 (*See Class 6 for this trademark*).
- 3,311,664 (*See Class 3 for this trademark*).
- 3,311,696 (*See Class 3 for this trademark*).
- 3,311,721 (*See Class 3 for this trademark*).
- 3,311,734. **DON'T FREAK IT'S FAUX (BLOCK FORM)**. MULLENGER, SUSIE K., (U.S. CLS. 42 AND 50). SN 78-653,580. PUB. 7-31-2007. FILED 6-17-2005.
- 3,311,800. **OM BEBE (BLOCK FORM)**. OM BEBE INC., MULTIPLE CLASS, (INT. CLS. 24 AND 25), (U.S. CLS. 22, 39, 42 AND 50). SN 78-716,828. PUB. 7-31-2007. FILED 9-20-2005.
- 3,311,837. **THEREDTHREADS AND DESIGN**. RED THREADS INC., THE, (U.S. CLS. 42 AND 50). SN 78-738,610. PUB. 7-31-2007. FILED 10-22-2005.
- 3,311,898 (*See Class 3 for this trademark*).
- 3,311,928. **KTTEX AND DESIGN**. KING TECH INDUSTRY INC., (U.S. CLS. 42 AND 50). SN 78-807,516. PUB. 7-31-2007. FILED 2-6-2006.
- 3,312,068. **ROOM-IN-A-BAG (BLOCK FORM)**. GTT INTERNATIONAL, INC. (U.S. CLS. 42 AND 50). SN 78-865,818. PUB. 2-20-2007. FILED 4-20-2006.
- 3,312,106. **DURA GUARD (BLOCK FORM)**. HAYES-IVY MFG., INC., (U.S. CLS. 42 AND 50). SN 78-873,262. PUB. 7-31-2007. FILED 5-1-2006.
- 3,312,234 (*See Class 3 for this trademark*).
- 3,312,275. **PSVINTAGE (BLOCK FORM)**. PAMELA SIMON VINTAGE, INC., MULTIPLE CLASS, (INT. CLS. 24 AND 35), (U.S. CLS. 42, 50, 100, 101 AND 102). SN 78-899,492. PUB. 7-31-2007. FILED 6-2-2006.
- 3,312,317. **ARTIROSA (BLOCK FORM)**. TORAY KABUSHIKI KAISHA (TORAY INDUSTRIES, INC.), (U.S. CLS. 42 AND 50). SN 78-906,836. PUB. 7-31-2007. FILED 6-13-2006.
- 3,312,536 (*See Class 6 for this trademark*).
- 3,312,553 (*See Class 17 for this trademark*).
- 3,312,674. **THE CHARMED PATIO (BLOCK FORM)**. HOME-GOODS, INC., (U.S. CLS. 42 AND 50). SN 78-971,402. PUB. 7-31-2007. FILED 9-11-2006.
- 3,312,679. **SUNDANCE ORGANICS (BLOCK FORM)**. SUNDANCE ENTERPRISES, INC., (U.S. CLS. 42 AND 50). SN 78-972,919. PUB. 7-31-2007. FILED 9-12-2006.
- 3,312,783 (*See Class 3 for this trademark*).
- 3,312,791 (*See Class 6 for this trademark*).
- 3,312,803. **FEELAMORE (STYLIZED)**. OZANTEKS TEKSTIL; SANAYI VE TICARET ANONIM SIRKETI, MULTIPLE CLASS, (INT. CLS. 24 AND 25), (U.S. CLS. 22, 39, 42 AND 50). SN 79-026,336. PUB. 6-19-2007. FILED 4-10-2006.
- 3,312,812 (*See Class 23 for this trademark*).
- 3,312,820 (*See Class 9 for this trademark*).
- 3,312,835. **CERAMICA COOL BUILD THE SUMMER AND DESIGN**. RIOPELE TÊXTEIS, S.A., (U.S. CLS. 42 AND 50). SN 79-027,679. PUB. 7-31-2007. FILED 7-7-2006.
- 3,312,875 (*See Class 3 for this trademark*).
- 3,312,876 (*See Class 3 for this trademark*).
- 3,312,880 (*See Class 9 for this trademark*).
- 3,312,941 (*See Class 2 for this trademark*).
- 3,312,976. **CAPRITEX (BLOCK FORM)**. LEOMASTER S.P.A., (U.S. CLS. 42 AND 50). SN 79-036,827. PUB. 7-31-2007. FILED 1-30-2007.

CLASS 25—CLOTHING

- 3,310,200 (*See Class 9 for this trademark*).
- 3,310,204 (*See Class 3 for this trademark*).
- 3,310,206 (*See Class 8 for this trademark*).
- 3,310,211. **RIVER WOODS NORTH-EASTERN SUPPLIERS AND DESIGN**. AMERICAN CLOTHING ASSOCIATES, (U.S. CLS. 22 AND 39). SN 76-202,751. PUB. 7-31-2007. FILED 1-31-2001.
- 3,310,224. **EROS JEANS AND DESIGN**. CHIOCCA MYERS GROUP INC., (U.S. CLS. 22 AND 39). SN 76-455,785. PUB. 7-31-2007. FILED 10-4-2002.
- 3,310,235 (*See Class 9 for this trademark*).
- 3,310,249 (*See Class 9 for this trademark*).
- 3,310,262. **UA CHEF (BLOCK FORM)**. ZIER, INC., MULTIPLE CLASS, (INT. CLS. 25 AND 35), (U.S. CLS. 22, 39, 100, 101 AND 102). SN 76-644,643. PUB. 7-31-2007. FILED 8-10-2005.
- 3,310,267. **CAVIAR GIRL (BLOCK FORM)**. UNITED SOUVENIR & APPAREL, INC., (U.S. CLS. 22 AND 39). SN 76-647,948. PUB. 7-31-2007. FILED 10-4-2005.
- 3,310,271. **JUST LAX'N (BLOCK FORM)**. KRASTEL, JOSEPH B., (U.S. CLS. 22 AND 39). SN 76-648,804. PUB. 7-31-2007. FILED 10-11-2005.
- 3,310,272. **TEAMSTERS GRAPHIC COMMUNICATIONS CONFERENCE AND DESIGN**. INTERNATIONAL BROTHERHOOD OF TEAMSTERS, MULTIPLE CLASS, (INT. CL. 25 AND U.S. CL. 200), (U.S. CLS. 22 AND 39). SN 76-648,919. PUB. 7-31-2007. FILED 10-20-2005.
- 3,310,354. **VIBRANT (BLOCK FORM)**. VIBES BASE GROUP CORP., (U.S. CLS. 22 AND 39). SN 76-665,592. PUB. 4-24-2007. FILED 9-5-2006.
- 3,310,359. **I'M SO HARLEM (BLOCK FORM)**. BROUGHTON, GREGORY, (U.S. CLS. 22 AND 39). SN 76-666,759. PUB. 7-31-2007. FILED 9-28-2006.
- 3,310,382. **SB STICKIE BRAND (STYLIZED)**. GRIFFIN, COURTNEY F., AND GRIFFIN, TINA R., (U.S. CLS. 22 AND 39). SN 76-669,330. PUB. 7-31-2007. FILED 11-21-2006.
- 3,310,419. **DRESS TO A TEE (BLOCK FORM)**. THE APPAREL SOURCING GROUP, LLC, (U.S. CLS. 22 AND 39). SN 76-672,328. PUB. 7-31-2007. FILED 2-7-2007.
- 3,310,438. **TECHNO-RIDE (BLOCK FORM)**. ROCKY BRANDS, INC., (U.S. CLS. 22 AND 39). SN 77-002,482. PUB. 7-31-2007. FILED 9-19-2006.
- 3,310,498. **DRI FRESH (STYLIZED)**. JIMMY TEES INC., (U.S. CLS. 22 AND 39). SN 77-012,904. PUB. 7-31-2007. FILED 10-3-2006.
- 3,310,499 (*See Class 22 for this trademark*).
- 3,310,533. **SANITARY FISH MARKET AND RESTAURANT SINCE 1938 AND DESIGN**. SANITARY FISH MARKET AND RESTAURANT, INC., MULTIPLE CLASS, (INT. CLS. 25 AND 30), (U.S. CLS. 22, 39 AND 46). SN 77-017,908. PUB. 7-10-2007. FILED 10-10-2006.
- 3,310,542 (*See Class 6 for this trademark*).
- 3,310,546. **FEEL YOUR BOOBIES AND DESIGN**. HURST, LEIGH A., (U.S. CLS. 22 AND 39). SN 77-020,241. PUB. 7-31-2007. FILED 10-12-2006.
- 3,310,551. **ALO AND DESIGN**. COLOR IMAGE APPAREL, INC., (U.S. CLS. 22 AND 39). SN 77-021,171. PUB. 7-31-2007. FILED 10-13-2006.
- 3,310,556. **FREEDOME (BLOCK FORM)**. MCGARRY, ERIN, (U.S. CLS. 22 AND 39). SN 77-021,651. PUB. 7-31-2007. FILED 10-16-2006.
- 3,310,562. **MY ALIBI AND DESIGN**. ABBIE DURKEE, (U.S. CLS. 22 AND 39). SN 77-023,104. PUB. 7-31-2007. FILED 10-17-2006.
- 3,310,588. **DICEWEAR (BLOCK FORM)**. ELMENDORF, CRAIG C., (U.S. CLS. 22 AND 39). SN 77-027,377. PUB. 7-31-2007. FILED 10-23-2006.
- 3,310,635. **CHONIES PANTALONIES (BLOCK FORM)**. TAILINDA AND COMPANY, LLC, (U.S. CLS. 22 AND 39). SN 77-037,143. PUB. 7-31-2007. FILED 11-5-2006.
- 3,310,650. **HOLLISTER (BLOCK FORM)**. ABERCROMBIE & FITCH TRADING CO., (U.S. CLS. 22 AND 39). SN 77-038,757. PUB. 7-31-2007. FILED 11-7-2006.
- 3,310,652. **BOXERCRAFT GIRL AND DESIGN**. BOXERCRAFT, INC., (U.S. CLS. 22 AND 39). SN 77-038,889. PUB. 7-31-2007. FILED 11-7-2006.
- 3,310,684 (*See Class 16 for this trademark*).
- 3,310,699. **WARMSIE (BLOCK FORM)**. DEMORDAUNT,

- MELISSA MAE, (U.S. CLS. 22 AND 39). SN 77-047,919. PUB. 7-31-2007. FILED 11-20-2006.
- 3,310,723. **CHICAGOWEAR (BLOCK FORM)**. CHICAGOWEAR, LLC, MULTIPLE CLASS, (INT. CLS. 25 AND 35), (U.S. CLS. 22, 39, 100, 101 AND 102). SN 77-050,934. PUB. 7-31-2007. FILED 11-27-2006.
- 3,310,725. **HANK HIGGINS AND DESIGN**. KYLE JOHNSON, (U.S. CLS. 22 AND 39). SN 77-051,066. PUB. 7-31-2007. FILED 11-27-2006.
- 3,310,764 (*See Class 1 for this trademark*).
- 3,310,824. **I'M SO WONDERFUL! (BLOCK FORM)**. INNER EQUITY PRODUCTIONS, (U.S. CLS. 22 AND 39). SN 77-064,493. PUB. 7-31-2007. FILED 12-14-2006.
- 3,310,839. **ROTOBEAST (BLOCK FORM)**. ROTOSTUD LLC, (U.S. CLS. 22 AND 39). SN 77-065,911. PUB. 7-31-2007. FILED 12-16-2006.
- 3,310,851. **MISCELLANEOUS DESIGN**. ASICS CORPORATION, (U.S. CLS. 22 AND 39). SN 77-067,434. PUB. 7-31-2007. FILED 12-19-2006.
- 3,310,852. **MISCELLANEOUS DESIGN**. ASICS CORPORATION, (U.S. CLS. 22 AND 39). SN 77-067,475. PUB. 7-31-2007. FILED 12-19-2006.
- 3,310,855. **MISCELLANEOUS DESIGN**. ASICS CORPORATION, (U.S. CLS. 22 AND 39). SN 77-067,488. PUB. 7-31-2007. FILED 12-19-2006.
- 3,310,856. **MISCELLANEOUS DESIGN**. ASICS CORPORATION, (U.S. CLS. 22 AND 39). SN 77-067,511. PUB. 7-31-2007. FILED 12-19-2006.
- 3,310,880. **UPPER CORNER LACROSSE AND DESIGN**. UPPER CORNER LACROSSE, LLC, MULTIPLE CLASS, (INT. CLS. 25 AND 41), (U.S. CLS. 22, 39, 100, 101 AND 107). SN 77-068,376. PUB. 7-31-2007. FILED 12-20-2006.
- 3,310,884. **UPPER CORNER SPORTS AND DESIGN**. UPPER CORNER LACROSSE, LLC, (U.S. CLS. 22 AND 39). SN 77-068,429. PUB. 7-31-2007. FILED 12-20-2006.
- 3,310,896. **SPUMONI (BLOCK FORM)**. TODD MAGALINE, (U.S. CLS. 22 AND 39). SN 77-068,781. PUB. 7-31-2007. FILED 12-20-2006.
- 3,311,026. **VKM (BLOCK FORM)**. VENUS KNITTING MILLS, INC., (U.S. CLS. 22 AND 39). SN 77-072,704. PUB. 7-31-2007. FILED 12-28-2006.
- 3,311,030. **KING DAVID'S CLOTHIER (BLOCK FORM)**. HOLY ARRAY, LLC, (U.S. CLS. 22 AND 39). SN 77-072,789. PUB. 7-31-2007. FILED 12-28-2006.
- 3,311,032. **ESTHER'S EXTRAVAGANT (BLOCK FORM)**. HOLY ARRAY, LLC, (U.S. CLS. 22 AND 39). SN 77-072,856. PUB. 7-31-2007. FILED 12-28-2006.
- 3,311,036. **THE MILK FAIRY AND DESIGN**. BILLOT, CATALINA, (U.S. CLS. 22 AND 39). SN 77-073,015. PUB. 7-31-2007. FILED 12-28-2006.
- 3,311,116. **G AND DESIGN**. GINO GREEN INC., (U.S. CLS. 22 AND 39). SN 77-074,968. PUB. 7-31-2007. FILED 1-3-2007.
- 3,311,137. **MISCELLANEOUS DESIGN**. PROPPER INTERNATIONAL SALES, INC., (U.S. CLS. 22 AND 39). SN 77-076,657. PUB. 7-31-2007. FILED 1-5-2007.
- 3,311,145 (*See Class 14 for this trademark*).
- 3,311,176. **FASHION PIG (BLOCK FORM)**. PETERMAN, CHRISTION J., (U.S. CLS. 22 AND 39). SN 77-081,174. PUB. 7-31-2007. FILED 1-11-2007.
- 3,311,189. **PURE CONCEPT (BLOCK FORM)**. PURE & SIMPLE CONCEPTS INC., (U.S. CLS. 22 AND 39). SN 77-082,185. PUB. 7-31-2007. FILED 1-12-2007.
- 3,311,198 (*See Class 18 for this trademark*).
- 3,311,207. **MILK DUDS (BLOCK FORM)**. HUHTAMAKI FINANCE B.V., (U.S. CLS. 22 AND 39). SN 77-083,443. PUB. 7-31-2007. FILED 1-16-2007.
- 3,311,277. **PICAFLO (BLOCK FORM)**. PICAFLO LLC, (U.S. CLS. 22 AND 39). SN 77-089,714. PUB. 7-31-2007. FILED 1-24-2007.
- 3,311,299 (*See Class 18 for this trademark*).
- 3,311,310. **PO PACTIMO AND DESIGN**. PACTIMO, LLC, (U.S. CLS. 22 AND 39). SN 77-092,596. PUB. 7-10-2007. FILED 1-26-2007.
- 3,311,312. **RAINBOWTRONIC (BLOCK FORM)**. MAILLET-STACEY A., (U.S. CLS. 22 AND 39). SN 77-092,908. PUB. 7-17-2007. FILED 1-27-2007.
- 3,311,324. **INSTITUTE LIBERAL (BLOCK FORM)**. NADINE CARIDI, INC., (U.S. CLS. 22 AND 39). SN 77-093,840. PUB. 7-31-2007. FILED 1-29-2007.
- 3,311,325. **MISCELLANEOUS DESIGN**. PEPE JEANS LONDON, LLC, (U.S. CLS. 22 AND 39). SN 77-093,912. PUB. 7-31-2007. FILED 1-29-2007.
- 3,311,330 (*See Class 6 for this trademark*).
- 3,311,337. **TWO WISHES (STYLIZED)**. TWO WISHES, (U.S. CLS. 22 AND 39). SN 77-094,445. PUB. 7-17-2007. FILED 1-30-2007.
- 3,311,374. **PRINCIPESSA (BLOCK FORM)**. PRINCIPESSA BEAUTY INC., (U.S. CLS. 22 AND 39). SN 77-097,358. PUB. 7-31-2007. FILED 2-1-2007.
- 3,311,386. **SIXTY SIXERS AND DESIGN**. INLAND EMPIRE 66ERS BASEBALL CLUB OF SAN BERNARDINO, INC., (U.S. CLS. 22 AND 39). SN 77-097,751. PUB. 7-31-2007. FILED 2-2-2007.
- 3,311,417. **BIBLE BELT (BLOCK FORM)**. COHEN, JEFFREY A., (U.S. CLS. 22 AND 39). SN 77-098,797. PUB. 7-31-2007. FILED 2-4-2007.
- 3,311,430. **MISCELLANEOUS DESIGN**. VALISERE INDUSTRIA E COMERCIO LTDA., (U.S. CLS. 22 AND 39). SN 77-099,113. PUB. 7-31-2007. FILED 2-5-2007.
- 3,311,478. **ROCK & ROLL LIFESTYLE (BLOCK FORM)**. NADINE CARIDI, INC., (U.S. CLS. 22 AND 39). SN 77-101,935. PUB. 7-31-2007. FILED 2-7-2007.
- 3,311,479. **BYZANTINE (BLOCK FORM)**. NADINE CARIDI, INC., (U.S. CLS. 22 AND 39). SN 77-101,936. PUB. 7-31-2007. FILED 2-7-2007.
- 3,311,508. **DHAKMANI (BLOCK FORM)**. RUDDER, FAITH, (U.S. CLS. 22 AND 39). SN 77-108,496. PUB. 7-31-2007. FILED 2-15-2007.
- 3,311,509. **SVOBODA BY JESSICA SVOBODA (BLOCK FORM)**. JESSICA SVOBODA, (U.S. CLS. 22 AND 39). SN 77-108,835. PUB. 7-31-2007. FILED 2-15-2007.
- 3,311,539. **FRESH OUTTA REHAB AND DESIGN**. CARPE DIEM LLC, (U.S. CLS. 22 AND 39). SN 77-114,988. PUB. 7-31-2007. FILED 2-23-2007.
- 3,311,597. **BRILLIANT IMAGES SPORTSWEAR (BLOCK FORM)**. SPRINGHILL WHOLESALE, INC., (U.S. CLS. 22 AND 39). SN 77-133,411. PUB. 7-31-2007. FILED 3-16-2007.
- 3,311,598. **HEART LINKS (BLOCK FORM)**. MICHELIN STAR, INC., (U.S. CLS. 22 AND 39). SN 77-134,519. PUB. 7-31-2007. FILED 3-19-2007.
- 3,311,624. **WRANGLER 47 (BLOCK FORM)**. WRANGLER APPAREL CORP., (U.S. CLS. 22 AND 39). SN 77-171,172. PUB. 7-31-2007. FILED 5-2-2007.
- 3,311,630 (*See Class 18 for this trademark*).
- 3,311,631 (*See Class 1 for this trademark*).
- 3,311,640. **FIREBOX**. FIREBOX.COM HOLDINGS PLC, MULTIPLE CLASS, (INT. CLS. 25 AND 41), (U.S. CLS. 22, 39, 100, 101 AND 107). SN 78-225,677. PUB. 4-17-2007. FILED 3-14-2003.
- 3,311,649 (*See Class 14 for this trademark*).
- 3,311,664 (*See Class 3 for this trademark*).
- 3,311,669. **TOUGH TIMEZ (BLOCK FORM)**. SHAY L. PALMER, AND CHRIS THOMPSON, (U.S. CLS. 22 AND 39). SN 78-514,910. PUB. 7-31-2007. FILED 11-10-2004.
- 3,311,673. **X-FIT (BLOCK FORM)**. E-Z GARD INDUSTRIES, INC., DBA SHOCK DOCTOR, INC., (U.S. CLS. 22 AND 39). SN 78-524,231. PUB. 10-25-2005. FILED 11-30-2004.
- 3,311,682. **LIL'LABS (BLOCK FORM)**. DAVID J. MARES, (U.S. CLS. 22 AND 39). SN 78-551,905. PUB. 7-31-2007. FILED 1-21-2005.
- 3,311,684 (*See Class 9 for this trademark*).
- 3,311,686. **MOOKS CLOTHING CO. (BLOCK FORM)**. PACIFIC BRANDS SPORT & LEISURE PTY LTD, MULTIPLE CLASS, (INT. CLS. 25 AND 35), (U.S. CLS. 22, 39, 100, 101 AND 102). SN 78-553,791. PUB. 7-31-2007. FILED 1-25-2005.
- 3,311,692. **HOTTIE USA AND DESIGN**. O'NEIL, BRIAN, (U.S. CLS. 22 AND 39). SN 78-561,297. PUB. 2-13-2007. FILED 2-5-2005.
- 3,311,696 (*See Class 3 for this trademark*).
- 3,311,699. **13 BLACK CATS (BLOCK FORM)**. PANCHE BARNES ENTERPRISES, INCORPORATED, (U.S. CLS. 22 AND 39). SN 78-580,863. PUB. 7-31-2007. FILED 3-4-2005.
- 3,311,709. **PRIDE AND DESIGN**. DREAM STAGE ENTERTAINMENT, INC., (U.S. CLS. 22 AND 39). SN 78-605,530. PUB. 7-31-2007. FILED 4-9-2005.
- 3,311,742 (*See Class 9 for this trademark*).

- 3,311,745. **BANG ON THE DOOR (STYLIZED)**. BANG ON THE DOOR LIMITED, MULTIPLE CLASS, (INT. CLS. 25, 28 AND 30), (U.S. CLS. 22, 23, 38, 39, 46 AND 50). SN 78-660,182. PUB. 7-31-2007. FILED 6-28-2005.
- 3,311,775. **THE WILD TULIP AND DESIGN**. BONNIE K. INC., (U.S. CLS. 22 AND 39). SN 78-698,628. PUB. 7-31-2007. FILED 8-23-2005.
- 3,311,800 (*See Class 24 for this trademark*).
- 3,311,803. **FS (STYLIZED)**. FANTASTIC SAMS FRANCHISE CORPORATION, (U.S. CLS. 22 AND 39). SN 78-718,709. PUB. 7-31-2007. FILED 9-22-2005.
- 3,311,823. **TOSCANA (BLOCK FORM)**. FOOTSTAR CORPORATION, (U.S. CLS. 22 AND 39). SN 78-730,702. PUB. 7-31-2007. FILED 10-11-2005.
- 3,311,828. **RED FOX (BLOCK FORM)**. MAXY TRADING CORP., (U.S. CLS. 22 AND 39). SN 78-733,290. PUB. 7-31-2007. FILED 10-14-2005.
- 3,311,838. **ROIDAL (STYLIZED)**. ROIG BORONAT, JOSE MARIA, (U.S. CLS. 22 AND 39). SN 78-739,125. PUB. 7-31-2007. FILED 10-24-2005.
- 3,311,853. **SNOWFLAKE DESIGNS (BLOCK FORM)**. RICHARD L SNOW, AND LADONNA SNOW, MULTIPLE CLASS, (INT. CLS. 25 AND 35), (U.S. CLS. 22, 39, 100, 101 AND 102). SN 78-749,880. PUB. 7-31-2007. FILED 11-8-2005.
- 3,311,868. **USO (BLOCK FORM)**. UNITED SERVICE ORGANIZATIONS, INC., MULTIPLE CLASS, (INT. CLS. 25, 35, 36, 39, 41, 43 AND 45), (U.S. CLS. 22, 39, 100, 101, 102, 105 AND 107). SN 78-764,947. PUB. 7-31-2007. FILED 12-1-2005.
- 3,311,873. **FLIP-ITZ (STYLIZED)**. PILLOWS FOR POINTES, INC., (U.S. CLS. 22 AND 39). SN 78-771,845. PUB. 7-31-2007. FILED 12-13-2005.
- 3,311,884. **ANTI-MARKET (BLOCK FORM)**. JOHN Q INC., (U.S. CLS. 22 AND 39). SN 78-780,798. PUB. 7-31-2007. FILED 12-27-2005.
- 3,311,898 (*See Class 3 for this trademark*).
- 3,311,909. **NEGRIS LEBRUM (BLOCK FORM)**. TRAVIS HAMILTON, (U.S. CLS. 22 AND 39). SN 78-797,645. PUB. 7-31-2007. FILED 1-23-2006.
- 3,311,910. **CHUBO (BLOCK FORM)**. CHUBONYC, LLC, (U.S. CLS. 22 AND 39). SN 78-799,663. PUB. 7-31-2007. FILED 1-26-2006.
- 3,311,925. **MELI MELI (BLOCK FORM)**. MELI MELI, INC., (U.S. CLS. 22 AND 39). SN 78-804,949. PUB. 7-31-2007. FILED 2-1-2006.
- 3,311,936. **GOT NAPPS? TAM MAYFIELD (STYLIZED)**. MAYFIELD, TAMARA YVONNE, (U.S. CLS. 22 AND 39). SN 78-810,699. PUB. 7-31-2007. FILED 2-9-2006.
- 3,311,943. **YOU CAN MAKE IT! AND DESIGN**. MOUNT ZION BAPTIST CHURCH, MULTIPLE CLASS, (INT. CLS. 25 AND 41), (U.S. CLS. 22, 39, 100, 101 AND 107). SN 78-816,253. PUB. 7-31-2007. FILED 2-16-2006.
- 3,311,968. **ROMANCING YOUR SOUL (STYLIZED)**. RYS, INC., (U.S. CLS. 22 AND 39). SN 78-833,777. PUB. 7-31-2007. FILED 3-9-2006.
- 3,311,974. **NEARLY D (BLOCK FORM)**. HBI BRANDED APPAREL ENTERPRISES, LLC, (U.S. CLS. 22 AND 39). SN 78-837,359. PUB. 7-31-2007. FILED 3-15-2006.
- 3,312,030. **SMALL TOWN (BLOCK FORM)**. ORION SCREENWORKS INC., (U.S. CLS. 22 AND 39). SN 78-855,133. PUB. 7-31-2007. FILED 4-5-2006.
- 3,312,067. **DRIXPERT AND DESIGN**. TALTECH LIMITED, (U.S. CLS. 22 AND 39). SN 78-865,735. PUB. 7-31-2007. FILED 4-20-2006.
- 3,312,075. **MISCELLANEOUS DESIGN**. RETAIL ROYALTY COMPANY, (U.S. CLS. 22 AND 39). SN 78-867,135. PUB. 7-31-2007. FILED 4-21-2006.
- 3,312,092. **R.U. PRETTY (BLOCK FORM)**. THUNDER BAY FASHIONS INC./LES MODES THUNDER BAY INC., (U.S. CLS. 22 AND 39). SN 78-871,504. PUB. 7-31-2007. FILED 4-27-2006.
- 3,312,108 (*See Class 9 for this trademark*).
- 3,312,150. **HAVEUHEARD (BLOCK FORM)**. SCHNEIDER, JESSE, DBA HUH CLOTHING, (U.S. CLS. 22 AND 39). SN 78-878,695. PUB. 7-31-2007. FILED 5-8-2006.
- 3,312,159. **MOJANE (BLOCK FORM)**. CANAM ASSOCIATES, INC., (U.S. CLS. 22 AND 39). SN 78-880,366. PUB. 7-31-2007. FILED 5-10-2006.
- 3,312,174. **FEEL THE PAINT (BLOCK FORM)**, HATFIELD, PHILLIP, (U.S. CLS. 22 AND 39). SN 78-881,743. PUB. 7-31-2007. FILED 5-11-2006.
- 3,312,177. **MISCELLANEOUS DESIGN**. BECKLES, WILLIAM, (U.S. CLS. 22 AND 39). SN 78-882,577. PUB. 7-31-2007. FILED 5-12-2006.
- 3,312,180 (*See Class 9 for this trademark*).
- 3,312,182. **MISCELLANEOUS DESIGN**. BECKLES, WILLIAM, (U.S. CLS. 22 AND 39). SN 78-882,896. PUB. 7-31-2007. FILED 5-12-2006.
- 3,312,191. **UPHIT (BLOCK FORM)**. UP PHIT INC., (U.S. CLS. 22 AND 39). SN 78-884,377. PUB. 7-31-2007. FILED 5-16-2006.
- 3,312,196 (*See Class 16 for this trademark*).
- 3,312,212 (*See Class 3 for this trademark*).
- 3,312,229. **80%20 AND DESIGN**. CE CE CHIN, INC., (U.S. CLS. 22 AND 39). SN 78-889,877. PUB. 7-31-2007. FILED 5-23-2006.
- 3,312,235. **DAILY WEAR EASY CARE (BLOCK FORM)**. SCHOOL APPAREL, INC., MULTIPLE CLASS, (INT. CLS. 25 AND 40), (U.S. CLS. 22, 39, 100, 103 AND 106). SN 78-891,381. PUB. 7-31-2007. FILED 5-24-2006.
- 3,312,248 (*See Class 18 for this trademark*).
- 3,312,295 (*See Class 3 for this trademark*).
- 3,312,313 (*See Class 10 for this trademark*).
- 3,312,346. **WEST COAST TENNIS ACADEMY AND DESIGN**. FARMER, ANDY, AND FARMER, PAIGE, MULTIPLE CLASS, (INT. CLS. 25 AND 41), (U.S. CLS. 22, 39, 100, 101 AND 107). SN 78-912,612. PUB. 7-31-2007. FILED 6-20-2006.
- 3,312,384. **HUF (BLOCK FORM)**. HUFNAGEL, KEITH, (U.S. CLS. 22 AND 39). SN 78-919,870. PUB. 2-20-2007. FILED 6-29-2006.
- 3,312,425. **POOL GUY (BLOCK FORM)**. PAYAN, JAVIER, AND PAYAN, STEPHANIE, (U.S. CLS. 22 AND 39). SN 78-924,968. PUB. 7-31-2007. FILED 7-7-2006.
- 3,312,463. **MICHÈLLE BELAU (STYLIZED)**. MICHELLE BELAU S.A.C., (U.S. CLS. 22 AND 39). SN 78-930,044. PUB. 4-10-2007. FILED 7-14-2006.
- 3,312,474. **DIM MAK (BLOCK FORM)**. AOKI, STEVE, (U.S. CLS. 22 AND 39). SN 78-931,286. PUB. 2-27-2007. FILED 7-17-2006.
- 3,312,489. **REFERENCE APPAREL AND DESIGN**. LUCID FUSION, INC., (U.S. CLS. 22 AND 39). SN 78-933,762. PUB. 7-31-2007. FILED 7-20-2006.
- 3,312,536 (*See Class 6 for this trademark*).
- 3,312,566 (*See Class 9 for this trademark*).
- 3,312,628. **CAROL WIOR SLIMSUIT THE SUIT THAT TAKES AN INCH OR MORE OFF DESIGNER COLLECTION AND DESIGN**. WIOR, CAROL, (U.S. CLS. 22 AND 39). SN 78-962,162. PUB. 7-31-2007. FILED 8-28-2006.
- 3,312,630. **BOXING IS FOR GIRLS (BLOCK FORM)**. ELIZA JAMES, MULTIPLE CLASS, (INT. CLS. 25 AND 41), (U.S. CLS. 22, 39, 100, 101 AND 107). SN 78-962,872. PUB. 7-31-2007. FILED 8-29-2006.
- 3,312,631. **NOSARO (BLOCK FORM)**. DICKIE, DYLAN, B, (U.S. CLS. 22 AND 39). SN 78-963,075. PUB. 7-31-2007. FILED 8-29-2006.
- 3,312,633. **MISCELLANEOUS DESIGN**. CAESARS WORLD, INC., MULTIPLE CLASS, (INT. CLS. 25, 41 AND 43), (U.S. CLS. 22, 39, 100, 101 AND 107). SN 78-963,477. PUB. 7-31-2007. FILED 8-30-2006.
- 3,312,638. **MISCELLANEOUS DESIGN**. ADIN GOLF INTERNATIONAL, LLC, (U.S. CLS. 22 AND 39). SN 78-964,017. PUB. 7-31-2007. FILED 8-30-2006.
- 3,312,646. **JOHNNY WEAR NEW YORK (BLOCK FORM)**. JOHNNY WEAR N.Y. INC., (U.S. CLS. 22 AND 39). SN 78-965,157. PUB. 4-10-2007. FILED 8-31-2006.
- 3,312,664. **DUDU (BLOCK FORM)**. GINKANA, S.A., (U.S. CLS. 22 AND 39). SN 78-969,318. PUB. 7-31-2007. FILED 9-7-2006.
- 3,312,669. **LOOK FOR THE SPIKE AND DESIGN**. MULHOLLAND HEADWEAR, LTD., (U.S. CLS. 22 AND 39). SN 78-970,276. PUB. 7-31-2007. FILED 9-8-2006.
- 3,312,678. **BEEPLUSH COUTURE (BLOCK FORM)**. BEEPLUSH COUTURE, LLC, (U.S. CLS. 22 AND 39). SN 78-972,214. PUB. 7-31-2007. FILED 9-12-2006.
- 3,312,698. **MISCELLANEOUS DESIGN**. PENDERGRASS, TORRY, (U.S. CLS. 22 AND 39). SN 78-978,804. PUB. 7-11-2006. FILED 7-27-2005.
- 3,312,700. **GINA MANTELLI FOR OTREERRE (BLOCK FORM)**. OTREERRE S.P.A., (U.S. CLS. 22 AND 39). SN 79-

003,283. PUB. 7-31-2007. FILED 5-4-2004.
 3,312,709. **POLO CLUB SAINT-TROPEZ HARAS DE GASSIN AND DESIGN**. POLO CLUB, MULTIPLE CLASS, (INT. CLS. 25, 28 AND 41), (U.S. CLS. 22, 23, 38, 39, 50, 100, 101 AND 107). SN 79-012,836. PUB. 7-31-2007. FILED 4-27-2005.
 3,312,716 (*See Class 12 for this trademark*).
 3,312,722 (*See Class 9 for this trademark*).
 3,312,730. **J.C. RAGS (BLOCK FORM)**. J.C. RAGS B.V., (U.S. CLS. 22 AND 39). SN 79-018,814. PUB. 7-31-2007. FILED 10-19-2005.
 3,312,739 (*See Class 9 for this trademark*).
 3,312,745 (*See Class 3 for this trademark*).
 3,312,750 (*See Class 3 for this trademark*).
 3,312,754 (*See Class 18 for this trademark*).
 3,312,757 (*See Class 18 for this trademark*).
 3,312,771 (*See Class 14 for this trademark*).
 3,312,772 (*See Class 14 for this trademark*).
 3,312,774. **YIHE AND DESIGN**. ZHENJIANG FEIDA GARMENT CO., LTD., (U.S. CLS. 22 AND 39). SN 79-024,549. PUB. 7-31-2007. FILED 3-22-2006.
 3,312,779. **TABIO (STYLIZED)**. DAN CO., LTD., (U.S. CLS. 22 AND 39). SN 79-024,766. PUB. 7-31-2007. FILED 4-13-2006.
 3,312,783 (*See Class 3 for this trademark*).
 3,312,786 (*See Class 3 for this trademark*).
 3,312,794 (*See Class 9 for this trademark*).
 3,312,802. **MISCELLANEOUS DESIGN**. DAN CO., LTD., (U.S. CLS. 22 AND 39). SN 79-026,334. PUB. 7-31-2007. FILED 4-13-2006.
 3,312,803 (*See Class 24 for this trademark*).
 3,312,805 (*See Class 18 for this trademark*).
 3,312,812 (*See Class 23 for this trademark*).
 3,312,820 (*See Class 9 for this trademark*).
 3,312,827 (*See Class 18 for this trademark*).
 3,312,834 (*See Class 12 for this trademark*).
 3,312,844 (*See Class 12 for this trademark*).
 3,312,866 (*See Class 9 for this trademark*).
 3,312,872. **SLOW SHOES FOR FAST PEOPLE (BLOCK FORM)**. CAMPER, S.L., (U.S. CLS. 22 AND 39). SN 79-029,417. PUB. 7-31-2007. FILED 7-14-2006.
 3,312,875 (*See Class 3 for this trademark*).
 3,312,876 (*See Class 3 for this trademark*).
 3,312,880 (*See Class 9 for this trademark*).
 3,312,884. **NICOLAS & MARK (STYLIZED)**. M.G. VULPINARI; DI MARIA GABRIELLA VULPINARI, (U.S. CLS. 22 AND 39). SN 79-029,756. PUB. 7-31-2007. FILED 9-14-2006.
 3,312,888. **WALK IN PROGRESS (BLOCK FORM)**. CAMPER, S.L., (U.S. CLS. 22 AND 39). SN 79-029,890. PUB. 7-31-2007. FILED 1-30-2006.
 3,312,894 (*See Class 18 for this trademark*).
 3,312,898 (*See Class 9 for this trademark*).
 3,312,919. **PIN I CUT AND DESIGN**. LAFEM GIYIM INSAAT; SANAYI VE TICARET LIMITED SIRKETI, MULTIPLE CLASS, (INT. CLS. 25 AND 35), (U.S. CLS. 22, 39, 100, 101 AND 102). SN 79-031,297. PUB. 7-31-2007. FILED 7-24-2006.
 3,312,922. **FU TIAN AND DESIGN**. NINGBO FUTIAN GROUP CO., LTD., (U.S. CLS. 22 AND 39). SN 79-031,482. PUB. 7-31-2007. FILED 11-6-2006.
 3,312,925 (*See Class 18 for this trademark*).
 3,312,927 (*See Class 18 for this trademark*).
 3,312,938. **ROECK-GRIP AND DESIGN**. ROECKL SPORHANDSCHUHE; GMBH & CO. KG, MULTIPLE CLASS, (INT. CLS. 25 AND 28), (U.S. CLS. 22, 23, 38, 39 AND 50). SN 79-032,722. PUB. 7-31-2007. FILED 11-16-2006.
 3,312,940. **ACÓUSMA (STYLIZED)**. RONG ZHIGUO, (U.S. CLS. 22 AND 39). SN 79-032,962. PUB. 7-31-2007. FILED 12-11-2006.
 3,312,956. **CAMILLE CAMISAS (STYLIZED)**. CAMILLE RIO, S.A., (U.S. CLS. 22 AND 39). SN 79-034,590. PUB. 7-31-2007. FILED 8-29-2006.
 3,312,971. **MISCELLANEOUS DESIGN**. ZHEJIANG RED-CROWN CLOTHING; LIMITED COMPANY., (U.S. CLS. 22 AND 39). SN 79-035,787. PUB. 7-31-2007. FILED 10-20-2006.
 3,312,975. **BETWOIN (BLOCK FORM)**. GIGIESSE GROUP S.P.A., (U.S. CLS. 22 AND 39). SN 79-036,718. PUB. 7-31-2007. FILED 1-30-2007.
 3,312,978. **TONITE (BLOCK FORM)**. DELUXE HOLDING AG, (U.S. CLS. 22 AND 39). SN 79-036,972. PUB. 7-31-2007.

FILED 12-23-2006.

CLASS 26—FANCY GOODS

3,310,204 (*See Class 3 for this trademark*).
 3,310,209 (*See Class 24 for this trademark*).
 3,310,273. **BUNDLE O' BRAIDS (STYLIZED)**. SHALOM INTERNATIONAL INC., (U.S. CLS. 37, 39, 40, 42 AND 50). SN 76-649,742. PUB. 7-31-2007. FILED 11-3-2005.
 3,310,694. **SPAR AND DESIGN**. RIDDLE, DAVID, HENRY, (U.S. CLS. 37, 39, 40, 42 AND 50). SN 77-047,428. PUB. 7-31-2007. FILED 11-19-2006.
 3,311,484 (*See Class 8 for this trademark*).
 3,311,485 (*See Class 8 for this trademark*).
 3,311,549. **MISCELLANEOUS DESIGN**. HELLS ANGELS MOTORCYCLE CORPORATION, (U.S. CLS. 37, 39, 40, 42 AND 50). SN 77-117,710. PUB. 7-31-2007. FILED 2-27-2007.
 3,311,590. **HAIR FOR HAIR (BLOCK FORM)**. KWON, YOUNG, AND KWON, JENNIFER, (U.S. CLS. 37, 39, 40, 42 AND 50). SN 77-131,387. PUB. 7-31-2007. FILED 3-14-2007.
 3,311,591. **FIGARO (BLOCK FORM)**. KWON, YOUNG, AND KWON, JENNIFER, (U.S. CLS. 37, 39, 40, 42 AND 50). SN 77-131,390. PUB. 7-31-2007. FILED 3-14-2007.
 3,312,398 (*See Class 14 for this trademark*).
 3,312,536 (*See Class 6 for this trademark*).
 3,312,703 (*See Class 9 for this trademark*).
 3,312,724 (*See Class 6 for this trademark*).
 3,312,725 (*See Class 6 for this trademark*).

CLASS 27—FLOOR COVERINGS

3,310,542 (*See Class 6 for this trademark*).
 3,310,717 (*See Class 19 for this trademark*).
 3,310,926. **AWESOME RUGS INTERNATIONAL AND DESIGN**. AWESOME RUGS INTERNATIONAL, LLC, (U.S. CLS. 19, 20, 37, 42 AND 50). SN 77-070,097. PUB. 7-31-2007. FILED 12-22-2006.
 3,311,256. **DUO (BLOCK FORM)**. CONGOLEUM CORPORATION, (U.S. CLS. 19, 20, 37, 42 AND 50). SN 77-087,603. PUB. 7-31-2007. FILED 1-22-2007.
 3,311,664 (*See Class 3 for this trademark*).
 3,311,818. **AMERICAN HOME FASHIONS OF CALIFORNIA AND DESIGN**. COLUMBIA INSURANCE COMPANY, (U.S. CLS. 19, 20, 37, 42 AND 50). SN 78-727,907. PUB. 7-31-2007. FILED 10-6-2005.
 3,311,898 (*See Class 3 for this trademark*).
 3,312,791 (*See Class 6 for this trademark*).
 3,312,812 (*See Class 23 for this trademark*).
 3,312,863 (*See Class 3 for this trademark*).

CLASS 28—TOYS AND SPORTING GOODS

3,310,180. **MUZIC POGZ**. KOMARO INC., (U.S. CL. 22). SN 74-450,196. PUB. 7-31-2007. FILED 10-25-1993.
 3,310,204 (*See Class 3 for this trademark*).
 3,310,206 (*See Class 8 for this trademark*).
 3,310,219. **ROBINSON AND DESIGN**. "BIS" BUSZ, PSZCZOLA, STARKO SPOLKA JAWNA, (U.S. CLS. 22, 23, 38 AND 50). SN 76-354,825. PUB. 7-31-2007. FILED 1-2-2002.
 3,310,230 (*See Class 7 for this trademark*).
 3,310,252. **US TOUR (BLOCK FORM)**. SPORT GLOVE INTERNATIONAL, INC., (U.S. CLS. 22, 23, 38 AND 50). SN 76-631,340. PUB. 7-31-2007. FILED 2-14-2005.
 3,310,278. **TOMAHAWK (BLOCK FORM)**. KARCH, DALE, AND KARCH, SANDRA, (U.S. CLS. 22, 23, 38 AND 50). SN 76-651,877. PUB. 7-31-2007. FILED 12-14-2005.
 3,310,317. **MISCELLANEOUS DESIGN**. KABUSHIKI KAISHA VOLKS, (U.S. CLS. 22, 23, 38 AND 50). SN 76-661,441. PUB. 7-31-2007. FILED 6-9-2006.
 3,310,386. **SK8VISIONS (BLOCK FORM)**. FLECHA, DAVID C., (U.S. CLS. 22, 23, 38 AND 50). SN 76-669,594. PUB. 7-31-

2007. FILED 11-28-2006.
- 3,310,398. **CURTAILER (STYLIZED)**. CLASSIC FISHING PRODUCTS, INC., (U.S. CLS. 22, 23, 38 AND 50). SN 76-670,740. PUB. 7-31-2007. FILED 12-26-2006.
- 3,310,406. **STAR STASH (BLOCK FORM)**. TOTO PRODUCTS, LLC, (U.S. CLS. 22, 23, 38 AND 50). SN 76-670,914. PUB. 7-31-2007. FILED 12-29-2006.
- 3,310,462. **WORLD DISCOVERY (BLOCK FORM)**. WICKED VISION LIMITED, (U.S. CLS. 22, 23, 38 AND 50). SN 77-007,218. PUB. 7-31-2007. FILED 9-26-2006.
- 3,310,542 (*See Class 6 for this trademark*).
- 3,310,647. **EZROD AND DESIGN**. S & B PARTNERS, (U.S. CLS. 22, 23, 38 AND 50). SN 77-038,579. PUB. 7-31-2007. FILED 11-7-2006.
- 3,310,662. **INCREDIBLE TREASURE HUNTS AND DESIGN**. CLARK, LISA L, (U.S. CLS. 22, 23, 38 AND 50). SN 77-041,433. PUB. 7-31-2007. FILED 11-10-2006.
- 3,310,673. **CREATION SKATEBOARDS (BLOCK FORM)**. SATORI MOVEMENT, (U.S. CLS. 22, 23, 38 AND 50). SN 77-042,984. PUB. 7-31-2007. FILED S.R. 11-13-2006; AM. P.R. 4-4-2007.
- 3,310,741. **ARSENAL (BLOCK FORM)**. SOP SERVICES, INC., (U.S. CLS. 22, 23, 38 AND 50). SN 77-053,662. PUB. 6-26-2007. FILED 11-30-2006.
- 3,310,764 (*See Class 1 for this trademark*).
- 3,310,805. **MULTI TEE (BLOCK FORM)**. PIERCE, RONALD I, (U.S. CLS. 22, 23, 38 AND 50). SN 77-061,835. PUB. 7-31-2007. FILED 12-11-2006.
- 3,310,854. **HUCK DOLL (BLOCK FORM)**. NSM RESOURCES CORPORATION, MULTIPLE CLASS, (INT. CLS. 28 AND 35), (U.S. CLS. 22, 23, 38, 50, 100, 101 AND 102). SN 77-067,486. PUB. 7-31-2007. FILED 12-19-2006.
- 3,310,879. **ROLAR-RING (BLOCK FORM)**. GIBBS, A. ROGER, (U.S. CLS. 22, 23, 38 AND 50). SN 77-068,326. PUB. 7-31-2007. FILED 12-20-2006.
- 3,310,958. **THE SPUTNIK (BLOCK FORM)**. NOVOSOL, SR, JOHN M., (U.S. CLS. 22, 23, 38 AND 50). SN 77-070,958. PUB. 7-31-2007. FILED 12-23-2006.
- 3,310,998. **KEYMORE AND DESIGN**. KEYMORE INTERNATIONAL CO., LTD., (U.S. CLS. 22, 23, 38 AND 50). SN 77-072,285. PUB. 7-31-2007. FILED 12-27-2006.
- 3,311,035. **SPEED GROOVE (BLOCK FORM)**. RIEDELL SHOES, INC., (U.S. CLS. 22, 23, 38 AND 50). SN 77-072,967. PUB. 7-31-2007. FILED 12-28-2006.
- 3,311,038. **TOYVILLE (BLOCK FORM)**. MADDOG TOYS, INC., (U.S. CLS. 22, 23, 38 AND 50). SN 77-073,027. PUB. 7-31-2007. FILED 12-28-2006.
- 3,311,068. **M (STYLIZED)**. MAGIC CASTLES, INC., (U.S. CLS. 22, 23, 38 AND 50). SN 77-073,677. PUB. 7-31-2007. FILED 12-29-2006.
- 3,311,091. **DAREDEVIL (BLOCK FORM)**. MARVEL CHARACTERS, INC., (U.S. CLS. 22, 23, 38 AND 50). SN 77-074,200. PUB. 7-31-2007. FILED 1-2-2007.
- 3,311,166. **WING NUTZ CALLS (BLOCK FORM)**. MANN, SEAN E., (U.S. CLS. 22, 23, 38 AND 50). SN 77-080,030. PUB. 7-31-2007. FILED 1-10-2007.
- 3,311,187 (*See Class 9 for this trademark*).
- 3,311,330 (*See Class 6 for this trademark*).
- 3,311,378. **PERFECT CONNEXION (STYLIZED)**. TECKX-CO, INC, (U.S. CLS. 22, 23, 38 AND 50). SN 77-097,557. PUB. 7-31-2007. FILED 2-2-2007.
- 3,311,380. **DUNKSTAR (BLOCK FORM)**. SNAP COURT, LLC, (U.S. CLS. 22, 23, 38 AND 50). SN 77-097,618. PUB. 7-31-2007. FILED 2-2-2007.
- 3,311,419. **SPUD MUFFINS (BLOCK FORM)**. JULIE ANNE DIEHL, (U.S. CLS. 22, 23, 38 AND 50). SN 77-098,833. PUB. 7-31-2007. FILED 2-4-2007.
- 3,311,435 (*See Class 16 for this trademark*).
- 3,311,514. **GREAT AUNTIE LU (BLOCK FORM)**. ROBERT-LESLIE PUBLISHING LLC, (U.S. CLS. 22, 23, 38 AND 50). SN 77-109,938. PUB. 7-31-2007. FILED 2-16-2007.
- 3,311,516. **JT GATOR (BLOCK FORM)**. ROBERT-LESLIE PUBLISHING LLC, (U.S. CLS. 22, 23, 38 AND 50). SN 77-109,999. PUB. 7-31-2007. FILED 2-16-2007.
- 3,311,518. **MANNY SALAMANDER (BLOCK FORM)**. ROBERT-LESLIE PUBLISHING LLC, (U.S. CLS. 22, 23, 38 AND 50). SN 77-110,210. PUB. 7-31-2007. FILED 2-17-2007.
- 3,311,545. **CLK (BLOCK FORM)**. MIZUNO USA, INC., (U.S. CLS. 22, 23, 38 AND 50). SN 77-117,108. PUB. 7-31-2007. FILED 2-27-2007.
- 3,311,689. **INFINITY FOOTBAR (BLOCK FORM)**. BALANCED BODY, INC., (U.S. CLS. 22, 23, 38 AND 50). SN 78-556,410. PUB. 7-31-2007. FILED 1-29-2005.
- 3,311,745 (*See Class 25 for this trademark*).
- 3,311,769. **HEISMAN (BLOCK FORM)**. THE TRUSTEES OF THE HEISMAN TROPHY TRUST, (U.S. CLS. 22, 23, 38 AND 50). SN 78-694,162. PUB. 7-31-2007. FILED 8-17-2005.
- 3,311,784. **TLSDESIGNS (BLOCK FORM)**. SCHWARTZ, TRACY LYNN, (U.S. CLS. 22, 23, 38 AND 50). SN 78-703,915. PUB. 7-31-2007. FILED 8-31-2005.
- 3,311,886 (*See Class 9 for this trademark*).
- 3,311,932 (*See Class 9 for this trademark*).
- 3,311,946. **SAYCOIN AND DESIGN**. SAYCHAR, LLC, (U.S. CLS. 22, 23, 38 AND 50). SN 78-818,207. PUB. 7-31-2007. FILED 2-17-2006.
- 3,311,947. **GATOR GRIP (BLOCK FORM)**. MIRACLE RE-CREATION EQUIPMENT COMPANY, (U.S. CLS. 22, 23, 38 AND 50). SN 78-820,374. PUB. 7-31-2007. FILED 2-22-2006.
- 3,312,097. **MAGNETIC ADVENTURES (BLOCK FORM)**. UNIVERSITY GAMES CORPORATION, (U.S. CLS. 22, 23, 38 AND 50). SN 78-872,344. PUB. 7-31-2007. FILED 4-28-2006.
- 3,312,180 (*See Class 9 for this trademark*).
- 3,312,208. **FORCEFIELD (BLOCK FORM)**. CARL J. ABRAHAM, (U.S. CLS. 22, 23, 38 AND 50). SN 78-886,455. PUB. 7-31-2007. FILED 5-18-2006.
- 3,312,248 (*See Class 18 for this trademark*).
- 3,312,250. **GOLD (BLOCK FORM)**. PROCAPS L.P., (U.S. CLS. 22, 23, 38 AND 50). SN 78-895,418. PUB. 7-31-2007. FILED 5-30-2006.
- 3,312,251. **SILVER (BLOCK FORM)**. PROCAPS L.P., (U.S. CLS. 22, 23, 38 AND 50). SN 78-895,433. PUB. 7-31-2007. FILED 5-30-2006.
- 3,312,252. **BRONZE (BLOCK FORM)**. PROCAPS L.P., (U.S. CLS. 22, 23, 38 AND 50). SN 78-895,444. PUB. 7-31-2007. FILED 5-30-2006.
- 3,312,307. **SYSCUT (BLOCK FORM)**. PROJETCLUB, (U.S. CLS. 22, 23, 38 AND 50). SN 78-905,484. PUB. 7-31-2007. FILED 6-11-2006.
- 3,312,309. **BOAT POOL (BLOCK FORM)**. A FRESH TACK, LLC, (U.S. CLS. 22, 23, 38 AND 50). SN 78-905,895. PUB. 7-31-2007. FILED 6-12-2006.
- 3,312,323. **MAGNUTS (BLOCK FORM)**. FRESH INTELLECTUAL PROPERTIES, INC., (U.S. CLS. 22, 23, 38 AND 50). SN 78-907,887. PUB. 7-31-2007. FILED 6-14-2006.
- 3,312,392. **WHISKER BISCUIT (BLOCK FORM)**. SOP SERVICES, INC., (U.S. CLS. 22, 23, 38 AND 50). SN 78-921,045. PUB. 7-31-2007. FILED 6-30-2006.
- 3,312,394. **HOLLYWOOD HOT RODS (BLOCK FORM)**. LADD, TROY L., (U.S. CLS. 22, 23, 38 AND 50). SN 78-921,135. PUB. 7-31-2007. FILED 6-30-2006.
- 3,312,419. **HUF (BLOCK FORM)**. HUFNAGEL, KEITH, (U.S. CLS. 22, 23, 38 AND 50). SN 78-923,928. PUB. 2-20-2007. FILED 7-6-2006.
- 3,312,514. **FRESH FISH (BLOCK FORM)**. SHEFFER, MICHAEL J., (U.S. CLS. 22, 23, 38 AND 50). SN 78-938,518. PUB. 7-31-2007. FILED 7-27-2006.
- 3,312,529. **FLIP N GO (BLOCK FORM)**. MATTEL, INC., (U.S. CLS. 22, 23, 38 AND 50). SN 78-940,567. PUB. 7-31-2007. FILED 7-29-2006.
- 3,312,530. **LIGHTNING FAST SPEEDWAY (BLOCK FORM)**. MATTEL, INC., (U.S. CLS. 22, 23, 38 AND 50). SN 78-940,569. PUB. 7-31-2007. FILED 7-29-2006.
- 3,312,536 (*See Class 6 for this trademark*).
- 3,312,553 (*See Class 17 for this trademark*).
- 3,312,591. **JELLY BABIES (BLOCK FORM)**. PACIFIC TOYS, INC., (U.S. CLS. 22, 23, 38 AND 50). SN 78-957,528. PUB. 7-31-2007. FILED 8-22-2006.
- 3,312,595. **MUSICAL SLUMBER (BLOCK FORM)**. MATTEL, INC., (U.S. CLS. 22, 23, 38 AND 50). SN 78-958,114. PUB. 7-31-2007. FILED 8-22-2006.
- 3,312,610. **KUNG FU MAX (BLOCK FORM)**. MATTEL, INC., (U.S. CLS. 22, 23, 38 AND 50). SN 78-960,519. PUB. 7-31-2007. FILED 8-25-2006.
- 3,312,611. **TORNADO BOOTS (BLOCK FORM)**. MATTEL, INC., (U.S. CLS. 22, 23, 38 AND 50). SN 78-960,523. PUB. 7-31-2007. FILED 8-25-2006.

- 3,312,612. **DARE-OFF DUOS (BLOCK FORM)**. MATTEL, INC., (U.S. CLS. 22, 23, 38 AND 50). SN 78-960,524. PUB. 7-31-2007. FILED 8-25-2006.
- 3,312,613. **CRUISE 'N SHOP (BLOCK FORM)**. MATTEL, INC., (U.S. CLS. 22, 23, 38 AND 50). SN 78-960,536. PUB. 7-31-2007. FILED 8-25-2006.
- 3,312,615. **RACKO'BAT (BLOCK FORM)**. INNOVATIVE SPORTING SOLUTIONS INC., (U.S. CLS. 22, 23, 38 AND 50). SN 78-960,980. PUB. 7-31-2007. FILED 8-25-2006.
- 3,312,709 (*See Class 25 for this trademark*).
- 3,312,716 (*See Class 12 for this trademark*).
- 3,312,739 (*See Class 9 for this trademark*).
- 3,312,754 (*See Class 18 for this trademark*).
- 3,312,757 (*See Class 18 for this trademark*).
- 3,312,780. **SPHINX AND DESIGN**. BARRA FABRIZIO, (U.S. CLS. 22, 23, 38 AND 50). SN 79-024,789. PUB. 7-31-2007. FILED 3-28-2006.
- 3,312,782 (*See Class 9 for this trademark*).
- 3,312,785 (*See Class 15 for this trademark*).
- 3,312,794 (*See Class 9 for this trademark*).
- 3,312,834 (*See Class 12 for this trademark*).
- 3,312,844 (*See Class 12 for this trademark*).
- 3,312,855 (*See Class 12 for this trademark*).
- 3,312,861. **RELYABALL (BLOCK FORM)**. GEBRÜDER OBERMAIER OHG, (U.S. CLS. 22, 23, 38 AND 50). SN 79-028,945. PUB. 7-31-2007. FILED 7-14-2006.
- 3,312,874 (*See Class 9 for this trademark*).
- 3,312,938 (*See Class 25 for this trademark*).
- 3,312,969 (*See Class 12 for this trademark*).
- 3,311,248. **ANOOK (BLOCK FORM)**. THE DANNON COMPANY, INC., (U.S. CL. 46). SN 77-086,952. PUB. 7-31-2007. FILED 1-19-2007.
- 3,311,272. **PREMIUM MOUNTAINE CHEF READY CHICKEN BLACK LABEL AND DESIGN**. MOUNTAINE CORPORATION, (U.S. CL. 46). SN 77-089,316. PUB. 7-31-2007. FILED 1-23-2007.
- 3,311,647 (*See Class 5 for this trademark*).
- 3,311,746 (*See Class 5 for this trademark*).
- 3,311,846. **TENDER GREEN (BLOCK FORM)**. JOHNSON FOODS, INC., (U.S. CL. 46). SN 78-744,029. PUB. 7-31-2007. FILED 10-31-2005.
- 3,312,022. **SIMPLY THE FINEST (BLOCK FORM)**. PAUL SORVINO FOODS, INC., (U.S. CL. 46). SN 78-853,496. PUB. 7-31-2007. FILED 4-4-2006.
- 3,312,056. **TENDER GRILLE PREMIUM MEAT PRODUCTS AND DESIGN**. GLOBAL FOODS INNOVATIONS, INC. (U.S. CL. 46). SN 78-862,727. PUB. 7-31-2007. FILED 4-17-2006.
- 3,312,127. **NEW ORLEANS STYLE CUISINE AND DESIGN**. CHEF HANS' GOURMET FOODS, INC., MULTIPLE CLASS, (INT. CLS. 29 AND 30), (U.S. CL. 46). SN 78-875,329. PUB. 7-31-2007. FILED 5-3-2006.
- 3,312,173. **URBAN HERBS (BLOCK FORM)**. TSEVDOS, DION, MULTIPLE CLASS, (INT. CLS. 29, 30 AND 35), (U.S. CLS. 46, 100, 101 AND 102). SN 78-881,633. PUB. 7-31-2007. FILED 5-11-2006.
- 3,312,211. **VÉGÉGOURMET (BLOCK FORM)**. ALAIN ROYER CONSULTANT INC., (U.S. CL. 46). SN 78-886,803. PUB. 7-31-2007. FILED 5-18-2006.
- 3,312,352. **DAY-BY-DAY GOURMET (BLOCK FORM)**. DAY-BY-DAY GOURMET, LLC, MULTIPLE CLASS, (INT. CLS. 29, 35 AND 43), (U.S. CLS. 46, 100, 101 AND 102). SN 78-913,249. PUB. 7-31-2007. FILED 6-21-2006.
- 3,312,452. **BLUE MOON (BLOCK FORM)**. BONGRAIN S.A., (U.S. CL. 46). SN 78-928,468. PUB. 7-31-2007. FILED 7-13-2006.
- 3,312,522. **CLASSY DELITES AND DESIGN**. CLASSY DELITES, INC., MULTIPLE CLASS, (INT. CLS. 29 AND 30), (U.S. CL. 46). SN 78-939,382. PUB. 7-31-2007. FILED 7-27-2006.
- 3,312,548. **NATURAL AND DESIGN**. WINTER GARDENS QUALITY FOODS, INC., (U.S. CL. 46). SN 78-944,198. PUB. 7-31-2007. FILED 8-3-2006.
- 3,312,687. **SAVANNAH CLASSICS AND DESIGN**. SAVANNAH FOOD COMPANY, INC., MULTIPLE CLASS, (INT. CLS. 29 AND 30), (U.S. CL. 46). SN 78-974,695. PUB. 7-31-2007. FILED S.R. 9-14-2006; AM. P.R. 6-8-2007.
- 3,312,710. **TAHEEBO NAFDIN (BLOCK FORM)**. TAHEEBO JAPAN KABUSHIKI KAISHA, MULTIPLE CLASS, (INT. CLS. 29, 30 AND 32), (U.S. CLS. 45, 46 AND 48). SN 79-012,913. PUB. 7-31-2007. FILED 3-7-2005.
- 3,312,728. **BALKAYMAK AND DESIGN**. EMIN GIDA INSAAT OTOMOTIV ITHALAT IHRACAAT SAN. VE TIC. LTD. STI., (U.S. CL. 46). SN 79-017,524. PUB. 7-31-2007. FILED 8-12-2005.
- 3,312,747. **LES PURES PLANTATIONS (BLOCK FORM)**. CHOCOLATERIE DE L'OPERA, MULTIPLE CLASS, (INT. CLS. 29 AND 30), (U.S. CL. 46). SN 79-021,071. PUB. 7-31-2007. FILED 1-30-2006.
- 3,312,797. **RN13 (BLOCK FORM)**. INTERNATIONAL FOOD AND HOSPITALITY CONSULTING; MANAGEMENT SPRL, MULTIPLE CLASS, (INT. CLS. 29, 32 AND 33), (U.S. CLS. 45, 46, 47, 48 AND 49). SN 79-026,075. PUB. 7-31-2007. FILED 6-20-2006.
- 3,312,824. **SOIGNON AND DESIGN**. EURIAL-POITOURAINE, (U.S. CL. 46). SN 79-027,330. PUB. 7-31-2007. FILED 7-7-2006.
- 3,312,838. **YPYM AND DESIGN**. XIANGSHAN SOUTH AQUATIC FOOD CO., LTD., (U.S. CL. 46). SN 79-027,705. PUB. 7-31-2007. FILED 3-22-2006.
- 3,312,858. **RAPELLI AND DESIGN**. ORIOR AG, MULTIPLE CLASS, (INT. CLS. 29 AND 30), (U.S. CL. 46). SN 79-028,846. PUB. 7-31-2007. FILED 7-11-2006.
- 3,312,896. **HERISTO (BLOCK FORM)**. HERISTO AKTIENGESELLSCHAFT, MULTIPLE CLASS, (INT. CLS. 29, 30, 31, 32, 35, 36 AND 43), (U.S. CLS. 1, 45, 46, 48, 100, 101 AND 102). SN 79-030,117. PUB. 7-31-2007. FILED 10-5-2005.

CLASS 29—MEATS AND PROCESSED FOODS

- 3,310,196. **BIORIGIN**. ANTICA PASTERIA S.P.A., MULTIPLE CLASS, (INT. CLS. 29 AND 30), (U.S. CL. 46). SN 75-566,269. PUB. 3-6-2007. FILED 10-6-1998.
- 3,310,253. **GAMAY (BLOCK FORM)**. GAMAY FOODS, INC., MULTIPLE CLASS, (INT. CLS. 29 AND 30), (U.S. CL. 46). SN 76-632,065. PUB. 7-31-2007. FILED S.R. 2-24-2005; AM. P.R. 11-11-2006.
- 3,310,270. **BINGGRAE BANANA FLAVORED MILK (STYLIZED)**. BINGGRAE INC., (U.S. CL. 46). SN 76-648,619. PUB. 7-31-2007. FILED 10-17-2005.
- 3,310,404. **MISCELLANEOUS DESIGN**. SAFEWAY INC., (U.S. CL. 46). SN 76-670,848. PUB. 7-17-2007. FILED 12-27-2006.
- 3,310,509. **SEYFERT'S (BLOCK FORM)**. TROYER POTATO PRODUCTS, INC., MULTIPLE CLASS, (INT. CLS. 29 AND 30), (U.S. CL. 46). SN 77-014,907. PUB. 7-31-2007. FILED 10-5-2006.
- 3,310,577. **SURFBURGER (BLOCK FORM)**. CAPE COD BAY SEAFOOD, INC., (U.S. CL. 46). SN 77-025,612. PUB. 7-31-2007. FILED 10-20-2006.
- 3,310,591. **5 J CINCO JOTAS SANCHEZ ROMERO CARVAJAL JABUGO S.A. DESDE 1879 AND DESIGN**. SANCHEZ ROMERO CARVAJAL JABUGO S.A., MULTIPLE CLASS, (INT. CLS. 29 AND 43), (U.S. CLS. 46, 100 AND 101). SN 77-028,049. PUB. 7-31-2007. FILED 10-24-2006.
- 3,310,634. **MISCELLANEOUS DESIGN**. CHEVALIER INTERNATIONAL (USA) INC., (U.S. CL. 46). SN 77-037,036. PUB. 7-10-2007. FILED 11-5-2006.
- 3,310,719. **MEDITERRANEAN SUPREME (BLOCK FORM)**. FRESH EXPRESS INCORPORATED, (U.S. CL. 46). SN 77-050,306. PUB. 7-31-2007. FILED 11-23-2006.
- 3,310,923. **A BOLD NEW TASTE FOR THE ADVENTURER IN ALL OF US! (BLOCK FORM)**. NORLANDER'S ORIGINAL FOODS, INC., MULTIPLE CLASS, (INT. CLS. 29 AND 30), (U.S. CL. 46). SN 77-069,887. PUB. 7-31-2007. FILED 12-21-2006.
- 3,310,945. **SAKURA BRAND AND DESIGN**. AZUMA FOODS INTERNATIONAL INC., U.S.A., (U.S. CL. 46). SN 77-070,844. PUB. 7-31-2007. FILED 12-22-2006.
- 3,311,088. **UDDERLY THE BEST! (BLOCK FORM)**. RY-CON SPECIALTY FOODS, INC., (U.S. CL. 46). SN 77-074,104. PUB. 7-31-2007. FILED 1-2-2007.
- 3,311,124. **MISCELLANEOUS DESIGN**. ALTO DAIRY CO-OPERATIVE, (U.S. CL. 46). SN 77-075,667. PUB. 7-31-2007. FILED 1-4-2007.

CLASS 30—STAPLE FOODS

- 3,310,182. **BIG DIPPER**. WELLS' DAIRY, INC., (U.S. CL. 46). SN 75-047,601. PUB. 7-31-2007. FILED 1-24-1996.
- 3,310,195. **SMILEY**. EPR INVESTMENTS, INC., (U.S. CL. 46). SN 75-528,931. PUB. 7-31-2007. FILED 7-31-1998.
- 3,310,196 (*See Class 29 for this trademark*).
- 3,310,197. **SMILEY**. EAT'N PARK HOSPITALITY GROUP, INC., (U.S. CL. 46). SN 75-683,021. PUB. 7-31-2007. FILED 4-15-1999.
- 3,310,198. **CONTI BRANDOLINI D'ADDA VISTORTA AND DESIGN**. BRANDOLINI D'ADDA, BRANDINO, MULTIPLE CLASS, (INT. CLS. 30, 31 AND 32), (U.S. CLS. 1, 45, 46 AND 48). SN 75-841,999. PUB. 7-31-2007. FILED 11-5-1999.
- 3,310,215. **NEW COLONY**. SUCESTORES DE JOSE JESUS RESTREPO Y CIA S.A., DBA CASA LUKER S.A. (U.S. CL. 46). SN 76-284,170. PUB. 7-31-2007. FILED 7-12-2001.
- 3,310,226 (*See Class 1 for this trademark*).
- 3,310,253 (*See Class 29 for this trademark*).
- 3,310,277. **ROYAL BAKERY HAWAIIAN STYLE SWEET BREAD AND DESIGN**. A-1 BEST FOOD, INC., (U.S. CL. 46). SN 76-651,217. PUB. 7-31-2007. FILED 12-1-2005.
- 3,310,371. **TERRUÑO NAYARITA AND DESIGN**. SAN CRISTOBAL MULTIMERCADOS, INC., DBA SAN CRISTOBAL COFFEE IMPORTERS, (U.S. CL. 46). SN 76-668,249. PUB. 7-31-2007. FILED 10-30-2006.
- 3,310,431. **MISS ANNA'S (BLOCK FORM)**. CRUCIAN SAUCES, LLC, (U.S. CL. 46). SN 77-001,124. PUB. 7-31-2007. FILED 9-17-2006.
- 3,310,443. **BALI'S BEST (BLOCK FORM)**. FUSION GOURMET, INC., (U.S. CL. 46). SN 77-003,481. PUB. 7-31-2007. FILED 9-20-2006.
- 3,310,487. **MULTIZEN FOODS (BLOCK FORM)**. MULTIZEN HOLDINGS LIMITED, (U.S. CL. 46). SN 77-011,273. PUB. 7-31-2007. FILED 10-1-2006.
- 3,310,509 (*See Class 29 for this trademark*).
- 3,310,527. **ERAWAN BRAND AND DESIGN**. ERAWAN MARKETING COMPANY, LTD., (U.S. CL. 46). SN 77-017,325. PUB. 7-31-2007. FILED 10-10-2006.
- 3,310,533 (*See Class 25 for this trademark*).
- 3,310,604. **H 1847 HELSY EXCLUSIVE COLLECTION AND DESIGN**. LEONIDOVICH, KOGAN IGOR, (U.S. CL. 46). SN 77-030,638. PUB. 7-31-2007. FILED 10-27-2006.
- 3,310,676. **SONTAVA (BLOCK FORM)**. JARDINE FOODS, INC., (U.S. CL. 46). SN 77-043,499. PUB. 7-31-2007. FILED 11-14-2006.
- 3,310,680. **MOTIVO (BLOCK FORM)**. CROSS SOUND CHURCH, (U.S. CL. 46). SN 77-044,593. PUB. 7-31-2007. FILED 11-15-2006.
- 3,310,686. **CHOCO-WALLA (BLOCK FORM)**. ODWALLA, INC., (U.S. CL. 46). SN 77-046,307. PUB. 7-31-2007. FILED 11-17-2006.
- 3,310,703. **MISCELLANEOUS DESIGN**. GREEN FROG MARKET BERNARD, LLC, (U.S. CL. 46). SN 77-048,566. PUB. 7-31-2007. FILED 11-21-2006.
- 3,310,780. **MISCELLANEOUS DESIGN**. CILANTRO TRADING INTERNATIONAL, LTD., (U.S. CL. 46). SN 77-058,831. PUB. 7-31-2007. FILED 12-7-2006.
- 3,310,785. **HUNTERS CHOICE MARINADE (BLOCK FORM)**. JP AND LEE FOODS, LLC, (U.S. CL. 46). SN 77-059,699. PUB. 7-31-2007. FILED 12-7-2006.
- 3,310,799. **PEACH DELIGHT (BLOCK FORM)**. CELESTIAL SEASONINGS, INC., (U.S. CL. 46). SN 77-061,065. PUB. 7-31-2007. FILED 12-11-2006.
- 3,310,843. **BETTY CROCKER (BLOCK FORM)**. GENERAL MILLS, INC., (U.S. CL. 46). SN 77-066,193. PUB. 7-31-2007. FILED 12-18-2006.
- 3,310,844. **BISQUICK (BLOCK FORM)**. GENERAL MILLS, INC., (U.S. CL. 46). SN 77-066,195. PUB. 7-31-2007. FILED 12-18-2006.
- 3,310,863. **PAYDAY CHOCOLATEY AVALANCHE! (BLOCK FORM)**. HUHTAMAKI FINANCE B.V., (U.S. CL. 46). SN 77-067,699. PUB. 7-10-2007. FILED 12-19-2006.
- 3,310,868. **JUJUBES (BLOCK FORM)**. FARLEY'S AND SATHERS CANDY COMPANY, INC., (U.S. CL. 46). SN 77-067,762. PUB. 7-31-2007. FILED 12-19-2006.
- 3,310,869. **JUJUBES AND DESIGN**. FARLEY'S AND SATHERS CANDY COMPANY, INC., (U.S. CL. 46). SN 77-067,763. PUB. 7-31-2007. FILED 12-19-2006.
- 3,310,870. **JUJUBES (STYLIZED)**. FARLEY'S AND SATHERS CANDY COMPANY, INC., (U.S. CL. 46). SN 77-067,766. PUB. 7-31-2007. FILED 12-19-2006.
- 3,310,923 (*See Class 29 for this trademark*).
- 3,310,969. **GALLETAS REINA (BLOCK FORM)**. BORINQUEN BISCUIT CORPORATION, (U.S. CL. 46). SN 77-071,451. PUB. 7-31-2007. FILED 12-26-2006.
- 3,311,007. **PEDRO PEPPER'S AND DESIGN**. WRIGHT, CHAD D., (U.S. CL. 46). SN 77-072,405. PUB. 7-31-2007. FILED 12-28-2006.
- 3,311,009. **THE SCONE PONY AND DESIGN**. THE SCONE PONY, LLC, (U.S. CL. 46). SN 77-072,431. PUB. 7-31-2007. FILED 12-28-2006.
- 3,311,121. **WATCHOUTDEHNOW! (BLOCK FORM)**. BROWN, J. ANTHONY, (U.S. CL. 46). SN 77-075,383. PUB. 7-31-2007. FILED 1-3-2007.
- 3,311,129. **LIZCEL (BLOCK FORM)**. RABB, ELAINE, (U.S. CL. 46). SN 77-076,303. PUB. 7-31-2007. FILED 1-4-2007.
- 3,311,163. **BULLIARD'S LOUISIANA SUPREME BUFFALO CHICKEN WING-ZZZ!!! SAUCE AND DESIGN**. PEPPERS UNLIMITED OF LOUISIANA, INC., (U.S. CL. 46). SN 77-079,922. PUB. 7-31-2007. FILED 1-10-2007.
- 3,311,165. **LOUISIANA SELECT AND DESIGN**. PEPPERS UNLIMITED OF LOUISIANA, INC., (U.S. CL. 46). SN 77-080,029. PUB. 7-31-2007. FILED 1-10-2007.
- 3,311,181. **RUMFORD (BLOCK FORM)**. CLABBER GIRL CORPORATION, (U.S. CL. 46). SN 77-081,639. PUB. 7-31-2007. FILED 1-12-2007.
- 3,311,225. **MULTIGRAIN AND DESIGN**. SOH IP COMPANY, INC., (U.S. CL. 46). SN 77-085,539. PUB. 7-31-2007. FILED 1-18-2007.
- 3,311,226. **SNYDER'S OF HANOVER MULTIGRAIN AND DESIGN**. SOH IP COMPANY, INC., (U.S. CL. 46). SN 77-085,561. PUB. 7-31-2007. FILED 1-18-2007.
- 3,311,227. **GO WITH THE GRAIN! (BLOCK FORM)**. SOH IP COMPANY, INC., (U.S. CL. 46). SN 77-085,597. PUB. 7-31-2007. FILED 1-18-2007.
- 3,311,267. **CRUSTINI (BLOCK FORM)**. STIRRINGS, LLC, (U.S. CL. 46). SN 77-088,788. PUB. 7-31-2007. FILED 1-23-2007.
- 3,311,375. **SHIPWRECK COFFEE (BLOCK FORM)**. SHIPWRECK COFFEE COMPANY, (U.S. CL. 46). SN 77-097,504. PUB. 7-31-2007. FILED 2-2-2007.
- 3,311,415. **CLASSIC BREAKS (BLOCK FORM)**. COUNTRY MAID, INC., (U.S. CL. 46). SN 77-098,786. PUB. 7-31-2007. FILED 2-4-2007.
- 3,311,434. **DIPPITY DO FUDGE (BLOCK FORM)**. DONNA WEISS, D/B/A SWEET ART, (U.S. CL. 46). SN 77-099,362. PUB. 7-31-2007. FILED 2-5-2007.
- 3,311,465. **SHAKESPEARE'S CHOICE GOURMET PASTIES BY MARTY HIGHTON AND DESIGN**. HIGHTON, MARTIN, (U.S. CL. 46). SN 77-101,023. PUB. 7-31-2007. FILED 2-6-2007.
- 3,311,489 (*See Class 5 for this trademark*).
- 3,311,490 (*See Class 5 for this trademark*).
- 3,311,505. **SILOS DE ORO (BLOCK FORM)**. CORN FLOUR PRODUCERS, LLC, (U.S. CL. 46). SN 77-107,585. PUB. 7-31-2007. FILED 2-14-2007.
- 3,311,532. **OVEN GOLD (BLOCK FORM)**. INTERSTATE BAKERIES CORPORATION, (U.S. CL. 46). SN 77-113,875. PUB. 7-31-2007. FILED 2-22-2007.
- 3,311,541. **WICKED NATURAL (BLOCK FORM)**. WICKED GOOD COMPANY, LLC, (U.S. CL. 46). SN 77-115,991. PUB. 7-31-2007. FILED 2-26-2007.
- 3,311,561. **DOÑA CHOLE SABOR CASERO AND DESIGN**. LO NUESTRO PRODUCTS CORPORATION, (U.S. CL. 46). SN 77-121,687. PUB. 7-31-2007. FILED 3-3-2007.
- 3,311,601. **MERRY KISSMAS (BLOCK FORM)**. HERSHEY CHOCOLATE & CONFECTIONERY CORPORATION, (U.S. CL. 46). SN 77-137,317. PUB. 7-31-2007. FILED 3-22-2007.
- 3,311,602. **SHAKESPEARE'S CHOICE GOURMET PASTIES BY MARTIN HIGHTON AND DESIGN**. HIGHTON, MARTIN, (U.S. CL. 46). SN 77-139,650. PUB. 7-31-2007. FILED 3-25-2007.
- 3,311,647 (*See Class 5 for this trademark*).
- 3,311,671. **CAPPUCCINO FUDGE BLITZ (BLOCK FORM)**. WELLS' DAIRY, INC., (U.S. CL. 46). SN 78-519,944. PUB. 7-

- 31-2007. FILED 11-19-2004.
- 3,311,672. **BLUEBIRD (BLOCK FORM)**. FLOWERS BAKERIES BRANDS, INC., (U.S. CL. 46). SN 78-523,993. PUB. 7-31-2007. FILED 11-29-2004.
- 3,311,688. **AVALON COFFEE AND DESIGN**. MICHAEL NESTOR, AND SEAN FORD, MULTIPLE CLASS, (INT. CLS. 30 AND 43), (U.S. CLS. 46, 100 AND 101). SN 78-555,618. PUB. 7-31-2007. FILED 1-28-2005.
- 3,311,708. **GALLETTO D'ORO (BLOCK FORM)**. AL VALENTINO, INC., (U.S. CL. 46). SN 78-598,944. PUB. 7-31-2007. FILED 3-31-2005.
- 3,311,745 (*See Class 25 for this trademark*).
- 3,311,751. **IL PADRINO (BLOCK FORM)**. IL PADRINO, (U.S. CL. 46). SN 78-675,798. PUB. 7-31-2007. FILED 7-21-2005.
- 3,311,779. **PORCELANA (BLOCK FORM)**. SONAFI, (U.S. CL. 46). SN 78-699,161. PUB. 7-31-2007. FILED 8-24-2005.
- 3,311,805. **FLYING MONKEY (BLOCK FORM)**. FLYING MONKEY LLC, (U.S. CL. 46). SN 78-719,943. PUB. 7-31-2007. FILED 9-24-2005.
- 3,311,836. **SWEET MAMA JANISSE'S (BLOCK FORM)**. SWEET MAMA JANISSE, (U.S. CL. 46). SN 78-738,088. PUB. 7-31-2007. FILED 10-21-2005.
- 3,311,851. **FEDERAL YEAST (BLOCK FORM)**. LESAFFRE ET COMPAGNIE, (U.S. CL. 46). SN 78-748,884. PUB. 7-31-2007. FILED 11-7-2005.
- 3,311,945. **THREE AMIGOS TEX-MEX HOT AND SPICY OLD SOUTH TRADING COMPANY SQUEEZABLE CHEESE SAUCE, CHEESE CONDIMENT, PASTEURIZED PROCESS CHEESE SAUCE, NET WT. 12 OZ (340G), REAL CHEESE & SHELF STABLE KETCHUP MUSTARD AND DESIGN**. HIGHLAND BEEF FARMS, (U.S. CL. 46). SN 78-817,656. PUB. 7-31-2007. FILED 2-17-2006.
- 3,312,023. **LE GRAND CONFECTIONARY AND DESIGN**. LE GRAND CONFECTIONARY, INC., (U.S. CL. 46). SN 78-854,396. PUB. 7-31-2007. FILED 4-5-2006.
- 3,312,039. **SWEET SALVATION HANDCRAFTED FOOD BAR, ONE BAR FOR THE WHOLE OF YOU AND DESIGN**. SWEET SALVATION, LLC, (U.S. CL. 46). SN 78-858,157. PUB. 7-31-2007. FILED 4-10-2006.
- 3,312,045. **HAVANA (BLOCK FORM)**. HAVANA CAPPUCINO CO., (U.S. CL. 46). SN 78-859,974. PUB. 7-31-2007. FILED 4-12-2006.
- 3,312,127 (*See Class 29 for this trademark*).
- 3,312,144. **NEW ENGLAND BREAKFAST BLEND (BLOCK FORM)**. NEW ENGLAND TEA & COFFEE CO., INC., (U.S. CL. 46). SN 78-877,893. PUB. 7-31-2007. FILED 5-5-2006.
- 3,312,145. **4-SEASONS BLEND (BLOCK FORM)**. NEW ENGLAND TEA & COFFEE CO., INC., (U.S. CL. 46). SN 78-877,899. PUB. 7-31-2007. FILED 5-5-2006.
- 3,312,156. **FLORIDA GATOR POOP AND DESIGN**. MAR-LEN CONFECTIONS, INC., (U.S. CL. 46). SN 78-880,313. PUB. 7-31-2007. FILED 5-10-2006.
- 3,312,173 (*See Class 29 for this trademark*).
- 3,312,260. **FAIRYTALE ENDINGS (BLOCK FORM)**. FAIRYTALE BROWNIES, INC., (U.S. CL. 46). SN 78-897,022. PUB. 7-31-2007. FILED 5-31-2006.
- 3,312,261. **ROJO'S ROASTER JOE'S GOURMET COFFEES AND DESIGN**. WICHITA COFFEE ROASTERIE, INC., (U.S. CL. 46). SN 78-897,103. PUB. 7-31-2007. FILED 5-31-2006.
- 3,312,287. **BERRY BOBS (BLOCK FORM)**. SHARI'S BERRIES, INC., (U.S. CL. 46). SN 78-902,156. PUB. 7-31-2007. FILED 6-6-2006.
- 3,312,333. **FRUIT SQUARES AND DESIGN**. AWREY BAKERIES, LLC, (U.S. CL. 46). SN 78-909,968. PUB. 7-31-2007. FILED 6-16-2006.
- 3,312,356. **YOGURT SHACK YS AND DESIGN**. YOGURT SHACK, (U.S. CL. 46). SN 78-913,982. PUB. 7-31-2007. FILED 6-22-2006.
- 3,312,369. **WILDLY CANADIAN (STYLIZED)**. THE CANADIAN WILD RICE MERCANTILE LTD., MULTIPLE CLASS, (INT. CLS. 30 AND 35), (U.S. CLS. 46, 100, 101 AND 102). SN 78-916,827. PUB. 7-31-2007. FILED 6-26-2006.
- 3,312,462. **EMACK & BOLIO'S (BLOCK FORM)**. TRUSTEES OF THE ROBERT ROOK CHILDREN'S TRUST, (U.S. CL. 46). SN 78-929,964. PUB. 7-31-2007. FILED 7-14-2006.
- 3,312,481. **COFFEE BY DESIGN AND DESIGN**. COFFEE BY DESIGN, INC., (U.S. CL. 46). SN 78-932,018. PUB. 7-31-2007. FILED 7-18-2006.
- 3,312,520. **CHAMONG (BLOCK FORM)**. CHAMONG TEA EXPORTS PVT. LTD., (U.S. CL. 46). SN 78-939,207. PUB. 7-31-2007. FILED 7-27-2006.
- 3,312,522 (*See Class 29 for this trademark*).
- 3,312,524. **ASTHMAQUELL (BLOCK FORM)**. BOLIVER, THEO MICHAEL, (U.S. CL. 46). SN 78-939,699. PUB. 7-31-2007. FILED 7-28-2006.
- 3,312,561. **TEEKANNE HARMONY FOR BODY & SOUL (BLOCK FORM)**. R. SEELIG & HILLE OHG, (U.S. CL. 46). SN 78-948,474. PUB. 7-31-2007. FILED 8-9-2006.
- 3,312,621. **EST. AZ 1980 BARRO'S PIZZA A FAMILY TRADITION AND DESIGN**. MJB PIZZA INC, AND A&D PIZZA INC, MULTIPLE CLASS, (INT. CLS. 30 AND 43), (U.S. CLS. 46, 100 AND 101). SN 78-961,643. PUB. 7-31-2007. FILED 8-28-2006.
- 3,312,637. **NANTUCKET OFF-SHORE (BLOCK FORM)**. NANTUCKET HARVEST CO., INC., (U.S. CL. 46). SN 78-963,973. PUB. 7-31-2007. FILED 8-30-2006.
- 3,312,655. **HOT HAT (BLOCK FORM)**. STRAW HAT COOPERATIVE CORPORATION, (U.S. CL. 46). SN 78-967,523. PUB. 7-31-2007. FILED 9-5-2006.
- 3,312,687 (*See Class 29 for this trademark*).
- 3,312,696. **SUPER (STYLIZED)**. SUPER BAKERY, INCORPORATED, (U.S. CL. 46). SN 78-978,559. PUB. 7-31-2007. FILED 9-26-2005.
- 3,312,710 (*See Class 29 for this trademark*).
- 3,312,726. **LEKSANDS AND DESIGN**. LEKSANDSBRÖD AB, MULTIPLE CLASS, (INT. CLS. 30 AND 32), (U.S. CLS. 45, 46 AND 48). SN 79-016,786. PUB. 7-31-2007. FILED 8-12-2005.
- 3,312,732. **FUGASSA AND DESIGN**. LANTERNA ALIMEN-TARI GENOVA S.P.A., (U.S. CL. 46). SN 79-019,163. PUB. 7-17-2007. FILED 9-29-2005.
- 3,312,747 (*See Class 29 for this trademark*).
- 3,312,849. **MISCELLANEOUS DESIGN**. OBSHCHESTVO S OGRANICHENNOY; OTVETSTVENNOSTYU "GRUPPA; KOMPANY UNISERVIS", (U.S. CL. 46). SN 79-028,456. PUB. 7-31-2007. FILED 12-20-2005.
- 3,312,858 (*See Class 29 for this trademark*).
- 3,312,896 (*See Class 29 for this trademark*).
- 3,312,957. **MAO-POP (BLOCK FORM)**. HARIBO GMBH & CO. KG, (U.S. CL. 46). SN 79-034,856. PUB. 7-31-2007. FILED 1-23-2007.

CLASS 31—NATURAL AGRICULTURAL PRODUCTS

- 3,310,198 (*See Class 30 for this trademark*).
- 3,310,429. **CORE ZONE (BLOCK FORM)**. SOUTHERN OUT-DOOR TECHNOLOGIES, LLC, (U.S. CLS. 1 AND 46). SN 77-000,597. PUB. 7-31-2007. FILED 9-15-2006.
- 3,310,521. **BOND ORCHARD SELECTION (BLOCK FORM)**. BOND, CHRISTOPHER S, (U.S. CLS. 1 AND 46). SN 77-016,728. PUB. 7-31-2007. FILED 10-9-2006.
- 3,310,639. **BLUTOPIA (BLOCK FORM)**. BALL HORTICULTURAL COMPANY, (U.S. CLS. 1 AND 46). SN 77-037,785. PUB. 7-31-2007. FILED 11-6-2006.
- 3,310,640. **SNOWTOPIA (BLOCK FORM)**. BALL HORTICULTURAL COMPANY, (U.S. CLS. 1 AND 46). SN 77-037,790. PUB. 7-31-2007. FILED 11-6-2006.
- 3,310,683. **SESTER DWARF (BLOCK FORM)**. SESTER FARMS INC., (U.S. CLS. 1 AND 46). SN 77-045,412. PUB. 7-31-2007. FILED 11-16-2006.
- 3,311,013. **PH PRO HEALTH AND DESIGN**. PRO-HEALTH, LLC, (U.S. CLS. 1 AND 46). SN 77-072,479. PUB. 7-31-2007. FILED 12-28-2006.
- 3,311,213. **HILL'S PRESCRIPTION DIET AND DESIGN**. HILL'S PET NUTRITION, INC., (U.S. CLS. 1 AND 46). SN 77-084,464. PUB. 7-17-2007. FILED 1-17-2007.
- 3,311,462. **GYPSY GOLD (BLOCK FORM)**. THOMPSON, DENNIS R., (U.S. CLS. 1 AND 46). SN 77-100,868. PUB. 7-31-2007. FILED 2-6-2007.
- 3,311,468. **DARK ANGEL DAHLIA (BLOCK FORM)**. FA. GEBR. VERWER, (U.S. CLS. 1 AND 46). SN 77-101,281. PUB. 7-31-2007. FILED 2-7-2007.
- 3,311,807. **REBEL EXTEND (BLOCK FORM)**. PENNINGTON

- SEED, INC., (U.S. CLS. 1 AND 46). SN 78-720,488. PUB. 7-31-2007. FILED 9-26-2005.
- 3,311,820. **BUTTERFLY (BLOCK FORM)**. RAY L. TRAVERS, (U.S. CLS. 1 AND 46). SN 78-728,821. PUB. 7-31-2007. FILED 10-7-2005.
- 3,311,845. **TENDER GREEN (BLOCK FORM)**. JOHNSON FOODS, INC., (U.S. CLS. 1 AND 46). SN 78-744,018. PUB. 7-31-2007. FILED 10-31-2005.
- 3,311,854. **AB VISTA (BLOCK FORM)**. ABNA LIMITED, (U.S. CLS. 1 AND 46). SN 78-750,631. PUB. 7-31-2007. FILED 11-9-2005.
- 3,312,111. **KONA BAY TVR (BLOCK FORM)**. SUNRISE CAPITAL, INC., (U.S. CLS. 1 AND 46). SN 78-873,933. PUB. 7-31-2007. FILED 5-1-2006.
- 3,312,112. **FLOWERS MAKE THE DIFFERENCE (BLOCK FORM)**. WAL-MART STORES, INC., (U.S. CLS. 1 AND 46). SN 78-874,118. PUB. 7-31-2007. FILED 5-2-2006.
- 3,312,247. **BECK'S AND DESIGN**. BECK'S SUPERIOR HYBRIDS, INC., (U.S. CLS. 1 AND 46). SN 78-893,953. PUB. 7-31-2007. FILED 5-26-2006.
- 3,312,542. **BORREGO VALLEY SELEY REDS AND DESIGN**. SELEY RANCHES LIMITED PARTNERSHIP, (U.S. CLS. 1 AND 46). SN 78-943,612. PUB. 7-31-2007. FILED 8-2-2006.
- 3,312,708 (*See Class 5 for this trademark*).
- 3,312,836. **ECOSTARS AND DESIGN**. FLOREMA YOUNG PLANTS B.V., (U.S. CLS. 1 AND 46). SN 79-027,695. PUB. 7-31-2007. FILED 7-6-2006.
- 3,312,896 (*See Class 29 for this trademark*).
- 3,312,961. **FRILLIA (BLOCK FORM)**. SUNTORY FLOWERS LIMITED, (U.S. CLS. 1 AND 46). SN 79-035,113. PUB. 7-31-2007. FILED 1-31-2007.
- LLC, (U.S. CLS. 45, 46 AND 48). SN 78-908,489. PUB. 7-31-2007. FILED 6-14-2006.
- 3,312,334. **REGIA EXTRA AND DESIGN**. INDUSTRIAS LA CONSTANCIA, SOCIEDAD ANONIMA DE CAPITAL VARIABLE, (U.S. CLS. 45, 46 AND 48). SN 78-910,074. PUB. 7-31-2007. FILED 6-16-2006.
- 3,312,368. **DON'T BE AFRAID OF FLAVOR (BLOCK FORM)**. BBC BRANDS, LLC, (U.S. CLS. 45, 46 AND 48). SN 78-916,752. PUB. 7-31-2007. FILED 6-26-2006.
- 3,312,617. **HO HO HO (BLOCK FORM)**. WRIGHT, GARIN, C., (U.S. CLS. 45, 46 AND 48). SN 78-961,166. PUB. 4-10-2007. FILED 8-26-2006.
- 3,312,706. **MISCELLANEOUS DESIGN**. LIMITED LIABILITY COMPANY "SANDORA", (U.S. CLS. 45, 46 AND 48). SN 79-010,330. PUB. 7-31-2007. FILED 11-30-2004.
- 3,312,710 (*See Class 29 for this trademark*).
- 3,312,719. **MÜNCHNER ART (BLOCK FORM)**. VEREIN MÜNCHNER BRAUEREIEN E.V., MULTIPLE CLASS, (INT. CLS. 32 AND 43), (U.S. CLS. 45, 46, 48, 100 AND 101). SN 79-015,624. PUB. 7-31-2007. FILED 7-15-2005.
- 3,312,726 (*See Class 30 for this trademark*).
- 3,312,743. **DESPERADOS MAS AND DESIGN**. BRASSERIE FISCHER, MULTIPLE CLASS, (INT. CLS. 32 AND 33), (U.S. CLS. 45, 46, 47, 48 AND 49). SN 79-020,741. PUB. 7-31-2007. FILED 9-27-2005.
- 3,312,744. **DESPERADOS MAS (BLOCK FORM)**. BRASSERIE FISCHER, MULTIPLE CLASS, (INT. CLS. 32 AND 33), (U.S. CLS. 45, 46, 47, 48 AND 49). SN 79-020,797. PUB. 7-31-2007. FILED 9-27-2005.
- 3,312,797 (*See Class 29 for this trademark*).
- 3,312,896 (*See Class 29 for this trademark*).
- 3,312,906 (*See Class 1 for this trademark*).

CLASS 32—LIGHT BEVERAGES

- 3,310,198 (*See Class 30 for this trademark*).
- 3,310,807. **PEACH DELIGHT (BLOCK FORM)**. CELESTIAL SEASONINGS, INC., (U.S. CLS. 45, 46 AND 48). SN 77-062,036. PUB. 7-31-2007. FILED 12-12-2006.
- 3,310,864. **JOLLY RANCHER (BLOCK FORM)**. HUHTAMAKI FINANCE B.V., (U.S. CLS. 45, 46 AND 48). SN 77-067,709. PUB. 7-31-2007. FILED 12-19-2006.
- 3,310,909 (*See Class 5 for this trademark*).
- 3,311,019. **EXELL (BLOCK FORM)**. MISSISSIPPI BOTTLED WATER COMPANY, INC., (U.S. CLS. 45, 46 AND 48). SN 77-072,531. PUB. 7-31-2007. FILED 12-28-2006.
- 3,311,020. **LIVE HEALTHIER (BLOCK FORM)**. MISSISSIPPI BOTTLED WATER COMPANY, INC., (U.S. CLS. 45, 46 AND 48). SN 77-072,550. PUB. 7-31-2007. FILED 12-28-2006.
- 3,311,144. **NO ADDED SUGAR. NO PRESERVATIVES. NO INHIBITIONS. (BLOCK FORM)**. NAKED JUICE CO. OF GLENDORA, INC., (U.S. CLS. 45, 46 AND 48). SN 77-076,971. PUB. 7-31-2007. FILED 1-5-2007.
- 3,311,208. **TOP FUEL WITH TAURINE ENERGY DRINK SYRUP AND DESIGN**. BISORDI, ROBERT, (U.S. CLS. 45, 46 AND 48). SN 77-083,528. PUB. 7-31-2007. FILED 1-16-2007.
- 3,311,250. **SCRATCH (BLOCK FORM)**. THE DANNON COMPANY, INC., (U.S. CLS. 45, 46 AND 48). SN 77-086,993. PUB. 7-31-2007. FILED 1-19-2007.
- 3,311,636. **BLUESTAR (STYLIZED)**. G-UP CORPORATION, (U.S. CLS. 45, 46 AND 48). SN 78-205,164. PUB. 7-31-2007. FILED 1-20-2003.
- 3,311,729. **DOUBLE BEAN ELIXIR (BLOCK FORM)**. GREEN MOUNTAIN COFFEE ROASTERS, INC., (U.S. CLS. 45, 46 AND 48). SN 78-650,215. PUB. 7-4-2006. FILED 6-14-2005.
- 3,311,882. **SLY PURE GLACIAL WATER (BLOCK FORM)**. GLACIA NOVA, LLC, (U.S. CLS. 45, 46 AND 48). SN 78-778,759. PUB. 7-31-2007. FILED 12-21-2005.
- 3,312,160. **CAPITAL BREWERY ISLAND WHEAT (BLOCK FORM)**. CAPITAL BREWERY COMPANY, INC., (U.S. CLS. 45, 46 AND 48). SN 78-880,655. PUB. 7-31-2007. FILED 5-10-2006.
- 3,312,267. **ST. BERNARDUS WATOU AND DESIGN**. BRASSERIE ST. BERNARD, NAAMLOZE VENNOOTSCHAP, (U.S. CLS. 45, 46 AND 48). SN 78-898,225. PUB. 7-31-2007. FILED 6-1-2006.
- 3,312,326. **GIRELLO (BLOCK FORM)**. CULPEPPER SALES,

CLASS 33—WINES AND SPIRITS

- 3,310,216. **ALIZE RED PASSION (STYLIZED)**. KOBRAND CORPORATION, (U.S. CLS. 47 AND 49). SN 76-317,056. PUB. 7-31-2007. FILED 9-24-2001.
- 3,310,231. **ALIANTE**. FUSIONE S.R.L., (U.S. CLS. 47 AND 49). SN 76-512,421. PUB. 7-17-2007. FILED 5-7-2003.
- 3,310,242. **BELLA VIGNA (BLOCK FORM)**. BELLA VIGNA FARMS, INC., (U.S. CLS. 47 AND 49). SN 76-601,898. PUB. 7-31-2007. FILED 7-12-2004.
- 3,310,265. **SOCIETE CIVILE DU DOMAINE DE LA ROMANEE-CONTI PROPRIETAIRE A VOSNE-ROMANEE (COTE-D'OR) FRANCE ROMANEE-CONTI APPELLATION ROMANEE-CONTI CONTROLEE BOUTEILLES RECOLTEES BOUTEILLE NO ANNEE LES ASSOCIES-GERANTS HENRI-FREDERIC ROCH A. DE VILLAIN MISE EN BOUTEILLE AU DOMAINE (STYLIZED)**. SOCIÉTÉ CIVILE DU DOMAINE DE LA ROMANÉE-CONTI, (U.S. CLS. 47 AND 49). SN 76-645,674. PUB. 7-17-2007. FILED 4-27-2005.
- 3,310,426. **LEVEL**. V&S VIN & SPRIT AKTIEBOLAG (PUBL), (U.S. CLS. 47 AND 49). SN 76-978,547. PUB. 7-31-2007. FILED 10-9-2003.
- 3,310,456. **YABTREE (BLOCK FORM)**. WOLFENSOHN, JAMES DAVID, (U.S. CLS. 47 AND 49). SN 77-005,073. PUB. 7-31-2007. FILED 9-22-2006.
- 3,310,464. **MISCELLANEOUS DESIGN**. ADMBA IMPORTS INTERNATIONAL, INC., (U.S. CLS. 47 AND 49). SN 77-007,723. PUB. 7-31-2007. FILED 9-26-2006.
- 3,310,526. **BALUARTE (BLOCK FORM)**. TEQUILA INSIGNIA, S.A. DE C.V., (U.S. CLS. 47 AND 49). SN 77-017,256. PUB. 6-5-2007. FILED 10-9-2006.
- 3,310,570. **SNUS HILL WINERY AND DESIGN**. SNUS HILL VINEYARD & WINERY, INC., (U.S. CLS. 47 AND 49). SN 77-024,515. PUB. 7-31-2007. FILED 10-19-2006.
- 3,310,619. **LIOCO (BLOCK FORM)**. LIOCO WINE COMPANY, LLC, (U.S. CLS. 47 AND 49). SN 77-032,966. PUB. 7-31-2007. FILED 10-31-2006.
- 3,310,679. **COTO VINTAGE AND DESIGN**. EL COTO DE RIOJA, S.A., (U.S. CLS. 47 AND 49). SN 77-044,378. PUB. 7-31-2007. FILED 11-15-2006.
- 3,310,722. **SKN (BLOCK FORM)**. DON SEBASTIANI & SONS INTERNATIONAL WINE NEGOCIANTS, (U.S. CLS. 47

AND 49). SN 77-050,534. PUB. 7-31-2007. FILED 11-24-2006.
 3,311,179. **GRAND TRAVERSE SELECT (BLOCK FORM)**. CHATEAU GRAND TRAVERSE, LTD., (U.S. CLS. 47 AND 49). SN 77-081,311. PUB. 7-31-2007. FILED 1-11-2007.
 3,311,199. **PRIDE OF CUCAMONGA (BLOCK FORM)**. J. FILIPPI VINTAGE COMPANY INC., DBA JOSEPH FILIPPI WINERY, (U.S. CLS. 47 AND 49). SN 77-083,218. PUB. 7-10-2007. FILED 1-15-2007.
 3,311,348. **PINESBROOK (BLOCK FORM)**. LEONARD KREUSCH, INC., (U.S. CLS. 47 AND 49). SN 77-095,704. PUB. 7-31-2007. FILED 1-31-2007.
 3,311,354. **LA LUCHA SIGUE (BLOCK FORM)**. BOULDER IMPORTS LLC, (U.S. CLS. 47 AND 49). SN 77-096,152. PUB. 7-31-2007. FILED 1-31-2007.
 3,311,429. **SVEDKA (STYLIZED)**. SPIRITS MARQUE ONE, LLC, (U.S. CLS. 47 AND 49). SN 77-099,087. PUB. 7-31-2007. FILED 2-5-2007.
 3,311,456. **BONIC (BLOCK FORM)**. RESTIFO PHILIP, (U.S. CLS. 47 AND 49). SN 77-100,299. PUB. 7-31-2007. FILED 2-6-2007.
 3,311,492. **TRYFON (BLOCK FORM)**. LOLONIS WINERY, (U.S. CLS. 47 AND 49). SN 77-104,241. PUB. 7-31-2007. FILED 2-9-2007.
 3,311,642. **LAS ALMAS**. MICHEL LAROCHE & JORGE CODERCH S.A., (U.S. CLS. 47 AND 49). SN 78-232,654. PUB. 7-31-2007. FILED 4-1-2003.
 3,311,691. **APELACION DE ORIGEN CONTROLADO PASION (BLOCK FORM)**. RAVANDI, DAVID, AND HERMOSILLO, JOSE, (U.S. CLS. 47 AND 49). SN 78-561,290. PUB. 7-31-2007. FILED 2-5-2005.
 3,311,795. **SPIRYTUS REKTYFIKOWANY (BLOCK FORM)**. PRZEDSIĘBIORSTWO PRZEMYSŁU SPIRYTUSOWEGO "POLMOS" W WARSZAWIE SPOLKA AKCYJNA, (U.S. CLS. 47 AND 49). SN 78-711,657. PUB. 7-31-2007. FILED 9-13-2005.
 3,311,842. **SCHWARTZHOG (BLOCK FORM)**. HARDENBERG-WILTHEN AG, (U.S. CLS. 47 AND 49). SN 78-743,183. PUB. 2-27-2007. FILED 10-29-2005.
 3,311,926. **BANDIT (BLOCK FORM)**. REBEL WINE CO. LLC, (U.S. CLS. 47 AND 49). SN 78-805,267. PUB. 4-10-2007. FILED 2-2-2006.
 3,311,955. **BEACH HEAD (BLOCK FORM)**. CARBUNUP PTY. LTD., (U.S. CLS. 47 AND 49). SN 78-826,645. PUB. 7-31-2007. FILED 3-1-2006.
 3,311,957. **TERREDAVINO AND DESIGN**. TERRE DA VINO S.P.A., (U.S. CLS. 47 AND 49). SN 78-830,124. PUB. 7-31-2007. FILED 3-6-2006.
 3,311,958. **PAESI TUOI AND DESIGN**. TERRE DA VINO S.P.A., (U.S. CLS. 47 AND 49). SN 78-830,156. PUB. 7-31-2007. FILED 3-6-2006.
 3,311,959. **LA CASA IN COLLINA AND DESIGN**. TERRE DA VINO S.P.A., (U.S. CLS. 47 AND 49). SN 78-830,204. PUB. 7-31-2007. FILED 3-6-2006.
 3,311,965. **VINTAGE NEW YORK (STYLIZED)**. RIVENDELL WINERY LLC, MULTIPLE CLASS, (INT. CLS. 33, 35, 41 AND 43), (U.S. CLS. 47, 49, 100, 101, 102 AND 107). SN 78-833,123. PUB. 7-31-2007. FILED 3-9-2006.
 3,311,992. **GEORGES DUBOEU F AND DESIGN**. LES VINS GEORGES DUBOEU F, (U.S. CLS. 47 AND 49). SN 78-844,606. PUB. 5-29-2007. FILED 3-23-2006.
 3,311,993. **GEORGES DUBOEU F AND DESIGN**. LES VINS GEORGES DUBOEU F, (U.S. CLS. 47 AND 49). SN 78-844,631. PUB. 5-29-2007. FILED 3-23-2006.
 3,311,994. **TW (STYLIZED)**. TOMASELLO WINERY, INC., (U.S. CLS. 47 AND 49). SN 78-845,682. PUB. 7-31-2007. FILED 3-24-2006.
 3,312,009. **HIGHWAY 12 (BLOCK FORM)**. OFFENBACHER, DOUG, AND GENERATIONS OF SONOMA, LLC, (U.S. CLS. 47 AND 49). SN 78-849,323. PUB. 7-31-2007. FILED 3-29-2006.
 3,312,180 (*See Class 9 for this trademark*).
 3,312,192. **BARON DE LEY AND DESIGN**. BARON DE LEY, S.A., (U.S. CLS. 47 AND 49). SN 78-884,437. PUB. 7-31-2007. FILED 5-16-2006.
 3,312,194. **NENQUEN (BLOCK FORM)**. AGRICOLA SAN JOSE DE PERALILLO S.A., (U.S. CLS. 47 AND 49). SN 78-884,546. PUB. 7-31-2007. FILED 5-16-2006.
 3,312,495. **CUERVO SEASON (BLOCK FORM)**, TEQUILA

CUERVO LA ROJENA, S.A. DE C.V., (U.S. CLS. 47 AND 49). SN 78-934,882. PUB. 7-31-2007. FILED 7-21-2006.
 3,312,532. **DISTILLER'S SELECT (BLOCK FORM)**. BROWN-FORMAN CORPORATION, (U.S. CLS. 47 AND 49). SN 78-941,531. PUB. 2-20-2007. FILED 7-31-2006.
 3,312,584. **AU (BLOCK FORM)**. AUSSIE VINEYARDS LTD ACN 113 562 637, (U.S. CLS. 47 AND 49). SN 78-953,982. PUB. 4-10-2007. FILED 8-17-2006.
 3,312,734. **BERNARD MAGREZ COMPOSITEUR DE VINS RARES (STYLIZED)**. BERNARD MAGREZ, (U.S. CLS. 47 AND 49). SN 79-019,407. PUB. 7-31-2007. FILED 11-10-2005.
 3,312,743 (*See Class 32 for this trademark*).
 3,312,744 (*See Class 32 for this trademark*).
 3,312,773. **QUINTA DE CABRIZ (BLOCK FORM)**. DAO SUL - SOCIEDADE VITIVINICOLA, S.A., (U.S. CLS. 47 AND 49). SN 79-024,517. PUB. 7-31-2007. FILED 3-15-2006.
 3,312,797 (*See Class 29 for this trademark*).
 3,312,811. **CHATEAU L'ARROSÉE AND DESIGN**. GFA DU CHATEAU L'ARROSEE; (GROUPEMENT FONCIER AGRICOLE), (U.S. CLS. 47 AND 49). SN 79-026,891. PUB. 7-31-2007. FILED 6-6-2006.
 3,312,841. **HERDADE DO GAMITO (BLOCK FORM)**. GONÇALO AIRES DE SÁ DA BANDEIRA, (U.S. CLS. 47 AND 49). SN 79-027,838. PUB. 7-31-2007. FILED 7-17-2006.
 3,312,882. **SALENTEIN NUMINA (BLOCK FORM)**. SALENTEIN ARGENTINA B.V., (U.S. CLS. 47 AND 49). SN 79-029,654. PUB. 7-31-2007. FILED 8-18-2006.
 3,312,895. **ACÚSTIC (STYLIZED)**. ALBERT JANE UBEDA, (U.S. CLS. 47 AND 49). SN 79-030,093. PUB. 7-31-2007. FILED 8-17-2006.
 3,312,928. **COCOTIDA (BLOCK FORM)**. ANTON RIE-MERSCHMID WEINBRENNEREI; UND LIKÖRFABRIK GMBH & CO. KG, (U.S. CLS. 47 AND 49). SN 79-031,939. PUB. 7-31-2007. FILED 9-9-2006.
 3,312,962. **ARUSNATICO (BLOCK FORM)**. CUBI VALENTINA, (U.S. CLS. 47 AND 49). SN 79-035,298. PUB. 7-31-2007. FILED 1-30-2007.
 3,312,968. **CASA BAYO (BLOCK FORM)**. MAS QUE VINOS GLOBAL, S.L., (U.S. CLS. 47 AND 49). SN 79-035,696. PUB. 7-31-2007. FILED 11-23-2006.
 3,312,972. **TRAUMA (STYLIZED)**. ANÍBAL JOSÉ SIMÕES COUTINHO, (U.S. CLS. 47 AND 49). SN 79-036,080. PUB. 7-31-2007. FILED 12-28-2006.

CLASS 34—SMOKERS' ARTICLES

3,310,542 (*See Class 6 for this trademark*).
 3,311,188. **FOR PEOPLE WITH A TASTE FOR SOMETHING BETTER (BLOCK FORM)**. PLAYER'S COMPANY INC., (U.S. CLS. 2, 8, 9 AND 17). SN 77-081,878. PUB. 7-31-2007. FILED 1-12-2007.
 3,312,043. **OKI AND DESIGN**. ROCK INTERNATIONAL (SINGAPORE) PTE LTD, (U.S. CLS. 2, 8, 9 AND 17). SN 78-859,410. PUB. 7-31-2007. FILED 4-11-2006.
 3,312,566 (*See Class 9 for this trademark*).
 3,312,955 (*See Class 5 for this trademark*).

SERVICE MARKS

CLASS 35—ADVERTISING AND BUSINESS

3,310,204 (*See Class 3 for this trademark*).
 3,310,205. **SAMMY (BLOCK FORM)**. SAMMY CORPORATION, (U.S. CLS. 100, 101 AND 102). SN 76-052,091. PUB. 7-31-2007. FILED 5-19-2000.
 3,310,234 (*See Class 1 for this trademark*).
 3,310,237 (*See Class 9 for this trademark*).
 3,310,238. **PREMAS (STYLIZED)**. PREMAS PREVENTIVE MAINTENANCE SERVICE AG, MULTIPLE CLASS, (INT. CLS. 35, 36, 37, 39 AND 42), (U.S. CLS. 100, 101, 102, 103, 105 AND 106). SN 76-567,750. PUB. 6-14-2005. FILED 12-31-2003.
 3,310,247 (*See Class 9 for this trademark*).

- 3,310,256. **AGILE (STYLIZED)**. AGILE TICKETING SOLUTIONS, MULTIPLE CLASS, (INT. CLS. 35, 39, 41 AND 42), (U.S. CLS. 100, 101, 102, 105 AND 107). SN 76-639,897. PUB. 7-31-2007. FILED 6-1-2005.
- 3,310,262 (*See Class 25 for this trademark.*).
- 3,310,264. **MEMBER APPRECIATION PROGRAM (MAP) (BLOCK FORM)**. ULTIMATE RESORT, LLC, (U.S. CLS. 100, 101 AND 102). SN 76-644,912. PUB. 7-31-2007. FILED 8-15-2005.
- 3,310,281. **BSG CLEARING SOLUTIONS AND DESIGN**. BSG CLEARING SOLUTIONS NORTH AMERICA, LLC, MULTIPLE CLASS, (INT. CLS. 35 AND 36), (U.S. CLS. 100, 101 AND 102). SN 76-653,390. PUB. 7-10-2007. FILED 1-17-2006.
- 3,310,308. **M MPHASIS ARCHITECTING VALUE AND DESIGN**. MPHASIS LIMITED, (U.S. CLS. 100, 101 AND 102). SN 76-659,725. PUB. 7-31-2007. FILED 5-5-2006.
- 3,310,309. **MPHASIS (BLOCK FORM)**. MPHASIS LIMITED, (U.S. CLS. 100, 101 AND 102). SN 76-659,743. PUB. 7-31-2007. FILED 5-5-2006.
- 3,310,315. **GRAND RESORT PROPERTIES AND DESIGN**. GRAND RESORT PROPERTIES, LLC, MULTIPLE CLASS, (INT. CLS. 35, 36 AND 37), (U.S. CLS. 100, 101, 102, 103 AND 106). SN 76-660,976. PUB. 7-31-2007. FILED 6-2-2006.
- 3,310,316. **GRAND RESORT PROPERTIES (BLOCK FORM)**. GRAND RESORT PROPERTIES, LLC, MULTIPLE CLASS, (INT. CLS. 35, 36 AND 37), (U.S. CLS. 100, 101, 102, 103 AND 106). SN 76-660,977. PUB. 7-31-2007. FILED 6-2-2006.
- 3,310,323. **PEDONE (STYLIZED)**. SEVENTH RANK MANAGEMENT, L.L.C., (U.S. CLS. 100, 101 AND 102). SN 76-661,604. PUB. 7-31-2007. FILED 6-15-2006.
- 3,310,327. **IN HOLLYWOOD, ON HOLLYWOOD (BLOCK FORM)**. SULLIVAN AUTOMOTIVE GROUP, (U.S. CLS. 100, 101 AND 102). SN 76-661,691. PUB. 7-31-2007. FILED 6-16-2006.
- 3,310,329. **MC CM AND DESIGN**. EMORY UNIVERSITY, MULTIPLE CLASS, (INT. CLS. 35 AND 41), (U.S. CLS. 100, 101, 102 AND 107). SN 76-662,122. PUB. 7-31-2007. FILED 6-26-2006.
- 3,310,337. **V AND DESIGN**. VIEWFINDER PRODUCTIONS, LLC, (U.S. CLS. 100, 101 AND 102). SN 76-662,834. PUB. 7-31-2007. FILED 7-11-2006.
- 3,310,339. **OUTCOMES (BLOCK FORM)**. OUTCOMES PHARMACEUTICAL HEALTH CARE, L.C., (U.S. CLS. 100, 101 AND 102). SN 76-663,127. PUB. 7-31-2007. FILED 7-17-2006.
- 3,310,340. **OUTCOMES PHARMACEUTICAL HEALTH CARE (BLOCK FORM)**. OUTCOMES PHARMACEUTICAL HEALTH CARE, L.C., (U.S. CLS. 100, 101 AND 102). SN 76-663,128. PUB. 7-31-2007. FILED 7-17-2006.
- 3,310,341. **PROVEST AND DESIGN**. PROVEST, INC., MULTIPLE CLASS, (INT. CLS. 35, 39, 41, 42 AND 45), (U.S. CLS. 100, 101, 102, 105 AND 107). SN 76-663,336. PUB. 7-31-2007. FILED 7-19-2006.
- 3,310,346. **FIRST LOOK (BLOCK FORM)**. NEW YORK DESIGN CENTER, INC., (U.S. CLS. 100, 101 AND 102). SN 76-664,174. PUB. 7-31-2007. FILED 8-3-2006.
- 3,310,355. **RANGE (BLOCK FORM)**. RANGE ONLINE MEDIA, INC., MULTIPLE CLASS, (INT. CLS. 35 AND 42), (U.S. CLS. 100, 101 AND 102). SN 76-665,639. PUB. 7-31-2007. FILED 9-5-2006.
- 3,310,356. **THE 123 MART AND DESIGN**. DAL-SOON, CHOI, (U.S. CLS. 100, 101 AND 102). SN 76-665,731. PUB. 7-31-2007. FILED 9-7-2006.
- 3,310,363. **SOYODO NORTH AMERICA AND DESIGN**. SONG, RUHUA, (U.S. CLS. 100, 101 AND 102). SN 76-667,229. PUB. 7-10-2007. FILED 10-10-2006.
- 3,310,372. **CRIME SURVIVORS AND DESIGN**. CRIME SURVIVORS, INC., MULTIPLE CLASS, (INT. CLS. 35 AND 41), (U.S. CLS. 100, 101, 102 AND 107). SN 76-668,337. PUB. 7-31-2007. FILED 10-31-2006.
- 3,310,378. **FASHION JEWELRY SUPERSTORE AND DESIGN**. J STEVENS INC., (U.S. CLS. 100, 101 AND 102). SN 76-668,819. PUB. 7-31-2007. FILED 11-13-2006.
- 3,310,381. **DRS DOCTORSRECALLSCHEDULING AND DESIGN**. DOCTORS RECALL SCHEDULING SERVICES, INC., (U.S. CLS. 100, 101 AND 102). SN 76-669,128. PUB. 7-31-2007. FILED 11-15-2006.
- 3,310,411. **INDEPENDENCE MUSIC (BLOCK FORM)**. INDEPENDENCEMUSIC.NET, INC., (U.S. CLS. 100, 101 AND 102). SN 76-671,378. PUB. 7-31-2007. FILED 1-16-2007.
- 3,310,418. **PURE GIFTING (BLOCK FORM)**. NEILL CORPORATION, (U.S. CLS. 100, 101 AND 102). SN 76-672,290. PUB. 7-31-2007. FILED 2-5-2007.
- 3,310,437. **THE BUSINESS SYNDICATE MG A MCGEEVER COMPANY AND DESIGN**. MCGEEVER, LLC, (U.S. CLS. 100, 101 AND 102). SN 77-002,370. PUB. 7-31-2007. FILED 9-19-2006.
- 3,310,439. **DOUBLETAKE DESIGN, INC. (BLOCK FORM)**. DOUBLETAKE DESIGN, INC., (U.S. CLS. 100, 101 AND 102). SN 77-002,580. PUB. 7-31-2007. FILED 9-19-2006.
- 3,310,444. **WOLFGANG'S VAULT AND DESIGN**. NORTON LLC, MULTIPLE CLASS, (INT. CLS. 35 AND 41), (U.S. CLS. 100, 101, 102 AND 107). SN 77-004,006. PUB. 7-31-2007. FILED 9-21-2006.
- 3,310,451. **TAXAMERICA TAX PREPARATION AND DESIGN**. MCMILLAN HERBERT L., (U.S. CLS. 100, 101 AND 102). SN 77-004,517. PUB. 7-31-2007. FILED 9-21-2006.
- 3,310,455. **POWER CREDIT (BLOCK FORM)**. GEORGIA POWER COMPANY, (U.S. CLS. 100, 101 AND 102). SN 77-004,969. PUB. 7-31-2007. FILED 9-22-2006.
- 3,310,469. **MAIN & WALL (BLOCK FORM)**. DAVID N. DEUTSCH & COMPANY LLC, (U.S. CLS. 100, 101 AND 102). SN 77-008,597. PUB. 7-31-2007. FILED 9-27-2006.
- 3,310,470. **3ARTS (BLOCK FORM)**. THE THREE ARTS CLUB OF CHICAGO, (U.S. CLS. 100, 101 AND 102). SN 77-008,610. PUB. 7-31-2007. FILED 9-27-2006.
- 3,310,472. **EXCELERATE STRATEGIES FOR SUCCESS AND DESIGN**. EXCELERATE, INC., (U.S. CLS. 100, 101 AND 102). SN 77-009,110. PUB. 7-31-2007. FILED 9-27-2006.
- 3,310,481. **AFAZE (BLOCK FORM)**. AFAZE OPERATING, INC., (U.S. CLS. 100, 101 AND 102). SN 77-010,775. PUB. 7-31-2007. FILED 9-29-2006.
- 3,310,489. **ONTRAC FOR OMB CLEARANCES AND DESIGN**. MACRO INTERNATIONAL, INC., (U.S. CLS. 100, 101 AND 102). SN 77-011,453. PUB. 7-31-2007. FILED 10-2-2006.
- 3,310,506. **FRANCIS-MUSTOE & COMPANY (BLOCK FORM)**. FRANCIS-MUSTOE & COMPANY, MULTIPLE CLASS, (INT. CLS. 35 AND 36), (U.S. CLS. 100, 101 AND 102). SN 77-014,175. PUB. 7-31-2007. FILED 10-4-2006.
- 3,310,510. **MARKY'S AND DESIGN**. OPTIMUS, INC., (U.S. CLS. 100, 101 AND 102). SN 77-015,028. PUB. 7-31-2007. FILED 10-5-2006.
- 3,310,512. **JOE COOPER (BLOCK FORM)**. JOE COOPER MANAGEMENT COMPANY, LLC, (U.S. CLS. 100, 101 AND 102). SN 77-015,485. PUB. 7-31-2007. FILED 10-6-2006.
- 3,310,514. **JOE COOPER TRUCK CENTER (BLOCK FORM)**. JOE COOPER MANAGEMENT COMPANY, LLC, (U.S. CLS. 100, 101 AND 102). SN 77-015,541. PUB. 7-31-2007. FILED 10-6-2006.
- 3,310,515. **IR2 (STYLIZED)**. IR SQUARED, LLC, (U.S. CLS. 100, 101 AND 102). SN 77-015,550. PUB. 7-31-2007. FILED 10-6-2006.
- 3,310,516 (*See Class 16 for this trademark.*).
- 3,310,529. **1-800-RADIATOR (BLOCK FORM)**. RADIATOR EXPRESS WAREHOUSE, INC., (U.S. CLS. 100, 101 AND 102). SN 77-017,578. PUB. 7-31-2007. FILED 10-10-2006.
- 3,310,536. **CAPUCINES BOULEVARD AND DESIGN**. BOULEVARD DES CAPUCINES, LLC., DBA, "CAPUCINES BOULEVARD", (U.S. CLS. 100, 101 AND 102). SN 77-018,682. PUB. 7-31-2007. FILED 10-11-2006.
- 3,310,537. **WHITE DRUG PHARMACY RX EST. 1884 AND DESIGN**. THRIFTY DRUG STORES, INC., MULTIPLE CLASS, (INT. CLS. 35, 40 AND 41), (U.S. CLS. 100, 101, 102, 103, 106 AND 107). SN 77-018,685. PUB. 7-10-2007. FILED 10-11-2006.
- 3,310,538. **CAPITAL RETAIL GROUP (BLOCK FORM)**. TACK, ROBERT, MULTIPLE CLASS, (INT. CLS. 35 AND 36), (U.S. CLS. 100, 101 AND 102). SN 77-019,221. PUB. 7-31-2007. FILED 10-11-2006.
- 3,310,550. **MISCELLANEOUS DESIGN**. DISCOUNT STEEL, INC., (U.S. CLS. 100, 101 AND 102). SN 77-020,702. PUB. 7-31-2007. FILED 10-13-2006.
- 3,310,559. **ENGINEKITS.COM AND DESIGN**. POWERHOUSE ENGINE COMPONENTS, INC., (U.S. CLS. 100, 101 AND 102). SN 77-022,299. PUB. 7-31-2007. FILED 10-16-2006.
- 3,310,560. **DGA AND DESIGN**. DIGITAL GLOBAL ACCOUNTING INC., (U.S. CLS. 100, 101 AND 102). SN 77-

- 022,798. PUB. 7-31-2007. FILED 10-17-2006.
 3,310,566 (*See Class 4 for this trademark*).
 3,310,580. **PCPOOLS.COM (BLOCK FORM)**. POOL DISTRIBUTION, LLC. (U.S. CLS. 100, 101 AND 102). SN 77-026,311. PUB. 7-31-2007. FILED 10-20-2006.
 3,310,585. **ROBERT SAGE & ASSOCIATES (BLOCK FORM)**. SAGE, MICHAEL R., (U.S. CLS. 100, 101 AND 102). SN 77-026,818. PUB. 7-31-2007. FILED 10-23-2006.
 3,310,590. **SSSSSSSS SUPERIOR SPECIALTIES INC AND DESIGN**. SUPERIOR SPECIALTIES, INC., MULTIPLE CLASS, (INT. CLS. 35 AND 40), (U.S. CLS. 100, 101, 102, 103 AND 106). SN 77-027,830. PUB. 7-31-2007. FILED 10-24-2006.
 3,310,594. **RISK IS OPPORTUNITY (BLOCK FORM)**. SOCIETY OF ACTUARIES, MULTIPLE CLASS, (INT. CLS. 35, 41 AND 42), (U.S. CLS. 100, 101, 102 AND 107). SN 77-028,375. PUB. 7-31-2007. FILED 10-24-2006.
 3,310,602. **HANDS ON ATLANTA AND DESIGN**. HANDS ON ATLANTA, INC., (U.S. CLS. 100, 101 AND 102). SN 77-030,268. PUB. 7-31-2007. FILED 10-26-2006.
 3,310,603 (*See Class 16 for this trademark*).
 3,310,616. **GOLD CIRCUIT (BLOCK FORM)**. INTECHRA LLC, MULTIPLE CLASS, (INT. CLS. 35, 37 AND 40), (U.S. CLS. 100, 101, 102, 103 AND 106). SN 77-032,609. PUB. 7-31-2007. FILED 10-30-2006.
 3,310,618 (*See Class 16 for this trademark*).
 3,310,626. **V AND DESIGN**. VERSAR, INC., MULTIPLE CLASS, (INT. CLS. 35, 37, 42 AND 45), (U.S. CLS. 100, 101, 102, 103 AND 106). SN 77-034,895. PUB. 7-17-2007. FILED 11-2-2006.
 3,310,627. **DEALERS CHOICE AND DESIGN**. BEACON ROOFING SUPPLY, INC., (U.S. CLS. 100, 101 AND 102). SN 77-035,172. PUB. 7-31-2007. FILED 11-2-2006.
 3,310,632. **TEMPLATE PRESS (BLOCK FORM)**. TEMPLATE CONSOLIDATED PRESS, LLC, (U.S. CLS. 100, 101 AND 102). SN 77-036,652. PUB. 7-31-2007. FILED 11-3-2006.
 3,310,649. **SCIMETRIKA AND DESIGN**. SCIMETRIKA, LLC, (U.S. CLS. 100, 101 AND 102). SN 77-038,751. PUB. 7-31-2007. FILED 11-7-2006.
 3,310,659. **EPIC (BLOCK FORM)**. GRIMAC ROYAL FALCON CORP., (U.S. CLS. 100, 101 AND 102). SN 77-041,337. PUB. 7-31-2007. FILED 11-10-2006.
 3,310,664. **R AND DESIGN**. RETROSPECS & CO., AUTHENTIC EARLY AMERICAN EYEWEAR, (U.S. CLS. 100, 101 AND 102). SN 77-041,578. PUB. 7-31-2007. FILED 11-10-2006.
 3,310,684 (*See Class 16 for this trademark*).
 3,310,692. **SAVORY NEW YORK (BLOCK FORM)**. PERRY STREET PRODUCTIONS, LLC, (U.S. CLS. 100, 101 AND 102). SN 77-046,877. PUB. 7-31-2007. FILED 11-17-2006.
 3,310,693. **REAL-TIME LEAD SOLUTIONS (BLOCK FORM)**. LOAN ALLIANCE INC., (U.S. CLS. 100, 101 AND 102). SN 77-047,153. PUB. 7-31-2007. FILED 11-17-2006.
 3,310,695. **LANGUAGE WORKS AND DESIGN**. THE LANGUAGE WORKS, INC., MULTIPLE CLASS, (INT. CLS. 35 AND 41), (U.S. CLS. 100, 101, 102 AND 107). SN 77-047,638. PUB. 7-31-2007. FILED 11-20-2006.
 3,310,696. **PBS PATHOLOGY BUSINESS SOLUTIONS COMMITTED TO THE VIABILITY AND GROWTH OF PATHOLOGY PRACTICES AND DESIGN**. PATHOLOGY BUSINESS SOLUTIONS, INC., (U.S. CLS. 100, 101 AND 102). SN 77-047,758. PUB. 7-31-2007. FILED 11-20-2006.
 3,310,704. **WE KNOW HOSPITALS (BLOCK FORM)**. AMERICAN HOSPITAL ASSOCIATION SOLUTIONS, INC., (U.S. CLS. 100, 101 AND 102). SN 77-048,574. PUB. 7-31-2007. FILED 11-21-2006.
 3,310,713. **CHRISTOPHER COMPANY AND DESIGN**. CHRISTOPHER COMMUNICATIONS, INC., MULTIPLE CLASS, (INT. CLS. 35 AND 40), (U.S. CLS. 100, 101, 102, 103 AND 106). SN 77-049,351. PUB. 7-31-2007. FILED 11-21-2006.
 3,310,720. **ZONE ADVISORS AND DESIGN**. FIELDS, ANDREW M., (U.S. CLS. 100, 101 AND 102). SN 77-050,372. PUB. 7-31-2007. FILED 11-24-2006.
 3,310,723 (*See Class 25 for this trademark*).
 3,310,732. **PALTALK (BLOCK FORM)**. A.V.M. SOFTWARE, INC., MULTIPLE CLASS, (INT. CLS. 35, 38 AND 42), (U.S. CLS. 100, 101, 102 AND 104). SN 77-051,854. PUB. 7-31-2007. FILED 11-28-2006.
 3,310,734. **EXPONENTIAL EDGE INC. AND DESIGN**. EXPONENTIAL EDGE, INC., (U.S. CLS. 100, 101 AND 102). SN 77-052,539. PUB. 7-31-2007. FILED 11-28-2006.
 3,310,735. **SOUTHWEST TRUST COMPANY N.A. (STYLIZED)**. BOK FINANCIAL CORPORATION, MULTIPLE CLASS, (INT. CLS. 35 AND 36), (U.S. CLS. 100, 101 AND 102). SN 77-053,018. PUB. 7-31-2007. FILED 11-29-2006.
 3,310,745. **DTX (BLOCK FORM)**. DETROIT TRADING COMPANY, INC., (U.S. CLS. 100, 101 AND 102). SN 77-053,996. PUB. 7-31-2007. FILED 11-30-2006.
 3,310,746. **BLACK DOG BIKES (BLOCK FORM)**. BLACK-DOGBIKES.COM, LLC, (U.S. CLS. 100, 101 AND 102). SN 77-054,085. PUB. 7-31-2007. FILED 11-30-2006.
 3,310,757. **SWEET & SASSY SALON . SPA . CELEBRATIONS AND DESIGN**. SWEET & SASSY IP, LLC, MULTIPLE CLASS, (INT. CLS. 35, 41 AND 44), (U.S. CLS. 100, 101, 102 AND 107). SN 77-054,880. PUB. 7-10-2007. FILED 12-1-2006.
 3,310,764 (*See Class 1 for this trademark*).
 3,310,770 (*See Class 9 for this trademark*).
 3,310,771. **JUNGLE GEMS EXOTICS (BLOCK FORM)**. GUERRA, DANIEL, (U.S. CLS. 100, 101 AND 102). SN 77-057,482. PUB. 6-26-2007. FILED 12-5-2006.
 3,310,777. **EQUINE SOURCE BOOK LET YOUR HOOVES DO THE WALKING AND DESIGN**. EQUINE SOURCE BOOK, (U.S. CLS. 100, 101 AND 102). SN 77-058,655. PUB. 6-26-2007. FILED 12-7-2006.
 3,310,782. **OHALEE (BLOCK FORM)**. LI, XUEYUAN, (U.S. CLS. 100, 101 AND 102). SN 77-059,505. PUB. 7-31-2007. FILED 12-7-2006.
 3,310,783. **TCC THE COLLABORATIVE COMPANIES AND DESIGN**. THE MARKETING COLLABORATIVE GROUP, INC., (U.S. CLS. 100, 101 AND 102). SN 77-059,521. PUB. 7-31-2007. FILED 12-7-2006.
 3,310,786. **ONEWAY (BLOCK FORM)**. ONEWAY, LLC, (U.S. CLS. 100, 101 AND 102). SN 77-059,768. PUB. 7-31-2007. FILED 12-8-2006.
 3,310,801. **EXHIB-IT! TRADESHOW MARKETING EXPERTS AND DESIGN**. EXHIB-IT! TRADESHOW MARKETING EXPERTS, LLC, MULTIPLE CLASS, (INT. CLS. 35, 37, 39 AND 42), (U.S. CLS. 100, 101, 102, 103, 105 AND 106). SN 77-061,156. PUB. 7-31-2007. FILED 12-11-2006.
 3,310,810. **TICKLED PINK (BLOCK FORM)**. DALY, DIXIE, (U.S. CLS. 100, 101 AND 102). SN 77-062,282. PUB. 7-31-2007. FILED 12-12-2006.
 3,310,813. **ICE CRAFTERS AND DESIGN**. ALICE CONNELLY ENTERPRISES INC., (U.S. CLS. 100, 101 AND 102). SN 77-062,921. PUB. 7-31-2007. FILED 12-12-2006.
 3,310,814. **A BEACON ROOFING SUPPLY COMPANY (BLOCK FORM)**. BEACON ROOFING SUPPLY, INC., (U.S. CLS. 100, 101 AND 102). SN 77-062,989. PUB. 7-31-2007. FILED 12-13-2006.
 3,310,815. **NTMA (BLOCK FORM)**. THE NATIONAL TERRAZZO & MOSAIC ASSOCIATION, INC., (U.S. CLS. 100, 101 AND 102). SN 77-063,092. PUB. 7-31-2007. FILED 12-13-2006.
 3,310,831. **CITI TRENDS AND DESIGN**. CITI TRENDS, INC., (U.S. CLS. 100, 101 AND 102). SN 77-065,044. PUB. 7-31-2007. FILED 12-15-2006.
 3,310,833. **MISCELLANEOUS DESIGN**. SHEA, MARJORIE E., (U.S. CLS. 100, 101 AND 102). SN 77-065,299. PUB. 7-31-2007. FILED 12-15-2006.
 3,310,854 (*See Class 28 for this trademark*).
 3,310,871. **COLORADO DRIVES PHIL LONG SMART! AND DESIGN**. PHIL LONG DEALERSHIPS INC., (U.S. CLS. 100, 101 AND 102). SN 77-067,850. PUB. 7-31-2007. FILED 12-19-2006.
 3,310,872. **GB GIGABUCKS AND DESIGN**. JOHNSON, TIM, (U.S. CLS. 100, 101 AND 102). SN 77-067,858. PUB. 7-31-2007. FILED 12-19-2006.
 3,310,895. **HERCULES TIRE INTERNATIONAL (BLOCK FORM)**. THE HERCULES TIRE & RUBBER COMPANY, (U.S. CLS. 100, 101 AND 102). SN 77-068,689. PUB. 7-31-2007. FILED 12-20-2006.
 3,310,917. **PASS (BLOCK FORM)**. CHIUSOLO, JASON, AND HUBER, TIM, AND STAHL, JOHN, (U.S. CLS. 100, 101 AND 102). SN 77-069,597. PUB. 7-31-2007. FILED 12-21-2006.
 3,310,925. **GIGGLING TOYS BETTER TOYS FOR OUTSTANDING KIDS AND DESIGN**. GIGGLING TOYS, LLC, (U.S. CLS. 100, 101 AND 102). SN 77-069,979. PUB. 7-31-2007.

- FILED 12-21-2006.
- 3,310,930. **RX UNITED DRUGS AUDITIPS AND DESIGN.** AMERICAN ASSOCIATED DRUGGISTS, INC., DBA UNITED DRUGS, (U.S. CLS. 100, 101 AND 102). SN 77-070,349. PUB. 7-31-2007. FILED 12-22-2006.
- 3,310,937. **NCN AND DESIGN.** NATIONAL CARE NETWORK, LP, (U.S. CLS. 100, 101 AND 102). SN 77-070,624. PUB. 7-31-2007. FILED 12-22-2006.
- 3,310,938. **NCN (BLOCK FORM).** NATIONAL CARE NETWORK, LP, (U.S. CLS. 100, 101 AND 102). SN 77-070,627. PUB. 7-31-2007. FILED 12-22-2006.
- 3,310,950. **<DANIWEB> IT DISCUSSION COMMUNITY AND DESIGN.** DANIWEB LLC, MULTIPLE CLASS, (INT. CLS. 35, 38, 41, 42 AND 45), (U.S. CLS. 100, 101, 102, 104 AND 107). SN 77-070,877. PUB. 7-31-2007. FILED 12-22-2006.
- 3,310,959. **GBN (BLOCK FORM).** MONITOR COMPANY GROUP LIMITED PARTNERSHIP, MULTIPLE CLASS, (INT. CLS. 35 AND 41), (U.S. CLS. 100, 101, 102 AND 107). SN 77-070,995. PUB. 7-31-2007. FILED 12-23-2006.
- 3,310,963. **DIVA NIGHT (BLOCK FORM).** FLEET FEET, INCORPORATED, (U.S. CLS. 100, 101 AND 102). SN 77-071,273. PUB. 7-31-2007. FILED 12-26-2006.
- 3,310,972. **GIGACRATE (BLOCK FORM).** GIGACRATE LLC, (U.S. CLS. 100, 101 AND 102). SN 77-071,624. PUB. 7-31-2007. FILED 12-27-2006.
- 3,310,975. **HEALTH INITIATIVE PROJECT (BLOCK FORM).** HEALTH INITIATIVE PROJECT, INC., (U.S. CLS. 100, 101 AND 102). SN 77-071,745. PUB. 7-31-2007. FILED 12-27-2006.
- 3,310,979. **BOUND FOR SUCCESS (BLOCK FORM).** HERBERGER, JENI, (U.S. CLS. 100, 101 AND 102). SN 77-071,867. PUB. 7-31-2007. FILED 12-27-2006.
- 3,310,984. **HPS AND DESIGN.** HOSPITAL PURCHASING SERVICE OF MICHIGAN, (U.S. CLS. 100, 101 AND 102). SN 77-071,991. PUB. 7-31-2007. FILED 12-27-2006.
- 3,310,989. **TOIGO PRO (STYLIZED).** ROBERT A. TOIGO FOUNDATION, (U.S. CLS. 100, 101 AND 102). SN 77-072,077. PUB. 7-31-2007. FILED 12-27-2006.
- 3,310,990. **MISCELLANEOUS DESIGN.** COMMERCE TEMPORARY STAFFING SERVICES LLC, (U.S. CLS. 100, 101 AND 102). SN 77-072,101. PUB. 7-31-2007. FILED 12-27-2006.
- 3,310,995. **BRITEMOVES (BLOCK FORM).** SAEGER, TERRY M., (U.S. CLS. 100, 101 AND 102). SN 77-072,221. PUB. 7-31-2007. FILED 12-27-2006.
- 3,310,997 (*See Class 14 for this trademark*).
- 3,311,006. **PRETTYSLEEK (BLOCK FORM).** BANDI, SANKAR, (U.S. CLS. 100, 101 AND 102). SN 77-072,401. PUB. 7-31-2007. FILED 12-28-2006.
- 3,311,008. **ENERLON (BLOCK FORM).** ENERLON, (U.S. CLS. 100, 101 AND 102). SN 77-072,428. PUB. 7-31-2007. FILED 12-28-2006.
- 3,311,016. **VALUED SALES (BLOCK FORM).** VALUED SALES, INC., (U.S. CLS. 100, 101 AND 102). SN 77-072,497. PUB. 7-31-2007. FILED 12-28-2006.
- 3,311,027. **COMMUNICATION STEWARDS CSTEWARDS BUILDING LEARNING ORGANIZATIONS WITH A SOLID COMMUNICATION FOUNDATION! AND DESIGN.** JAMES D. TERRINONI, MULTIPLE CLASS, (INT. CLS. 35 AND 41), (U.S. CLS. 100, 101, 102 AND 107). SN 77-072,708. PUB. 7-31-2007. FILED 12-28-2006.
- 3,311,031. **MERGERNETWORK (BLOCK FORM).** MARKETPLACE TECHNOLOGIES, (U.S. CLS. 100, 101 AND 102). SN 77-072,847. PUB. 7-31-2007. FILED 12-28-2006.
- 3,311,034. **SAPPHIRE RECRUITING AND DESIGN.** SELECT APPOINTMENTS (HOLDINGS) LIMITED, (U.S. CLS. 100, 101 AND 102). SN 77-072,929. PUB. 7-31-2007. FILED 12-28-2006.
- 3,311,063. **WAR LAWYERS (BLOCK FORM).** ASCENT HOLDINGS, INC., (U.S. CLS. 100, 101 AND 102). SN 77-073,440. PUB. 7-31-2007. FILED 12-29-2006.
- 3,311,087. **LEARN. CALCULATE. COMPARE. (BLOCK FORM).** SPYDERCUBE, INC., MULTIPLE CLASS, (INT. CLS. 35 AND 36), (U.S. CLS. 100, 101 AND 102). SN 77-074,061. PUB. 7-31-2007. FILED 1-1-2007.
- 3,311,095. **JOBELIXIR.COM (BLOCK FORM).** JOBOSAURUS VENTURE HOLDING CO. INC., (U.S. CLS. 100, 101 AND 102). SN 77-074,308. PUB. 7-31-2007. FILED 1-2-2007.
- 3,311,096. **THE JUGGLING FISH (BLOCK FORM).** SALAMANDER HOLDINGS N.V., (U.S. CLS. 100, 101 AND 102). SN 77-074,364. PUB. 7-31-2007. FILED 1-2-2007.
- 3,311,097. **T.H. PALM & COMPANY (BLOCK FORM).** SALAMANDER HOLDINGS N.V., (U.S. CLS. 100, 101 AND 102). SN 77-074,367. PUB. 7-31-2007. FILED 1-2-2007.
- 3,311,114. **NEATSTUFF (BLOCK FORM).** WILLIAM T. CONN, (U.S. CLS. 100, 101 AND 102). SN 77-074,948. PUB. 7-31-2007. FILED 1-3-2007.
- 3,311,118. **MISCELLANEOUS DESIGN.** CHURCH GREEN PROFESSIONAL SERVICES, (U.S. CLS. 100, 101 AND 102). SN 77-075,109. PUB. 7-31-2007. FILED 1-3-2007.
- 3,311,126 (*See Class 9 for this trademark*).
- 3,311,132. **VERETEKK (BLOCK FORM).** INETEKK.COM, INC., (U.S. CLS. 100, 101 AND 102). SN 77-076,350. PUB. 7-31-2007. FILED 1-4-2007.
- 3,311,140. **SOCIAL CONCEPTS (BLOCK FORM).** SOCIAL CONCEPTS, INC., MULTIPLE CLASS, (INT. CLS. 35, 38, 42 AND 45), (U.S. CLS. 100, 101, 102 AND 104). SN 77-076,851. PUB. 7-31-2007. FILED 1-5-2007.
- 3,311,141. **CHERRYTAP (BLOCK FORM).** SOCIAL CONCEPTS, INC., MULTIPLE CLASS, (INT. CLS. 35, 38, 42 AND 45), (U.S. CLS. 100, 101, 102 AND 104). SN 77-076,868. PUB. 7-31-2007. FILED 1-5-2007.
- 3,311,143. **PROJECT F.A.R.M. FIRST-CLASS AMERICAN RURAL MADE (BLOCK FORM).** BUTTERS, MARYJANE, (U.S. CLS. 100, 101 AND 102). SN 77-076,908. PUB. 7-17-2007. FILED 1-5-2007.
- 3,311,145 (*See Class 14 for this trademark*).
- 3,311,148. **SOPHISTICATED, CLASSIC, BEAUTIFUL (BLOCK FORM).** BELISI FASHIONS, INC., (U.S. CLS. 100, 101 AND 102). SN 77-077,078. PUB. 7-31-2007. FILED 1-5-2007.
- 3,311,152. **FLOORS GALORE (BLOCK FORM).** JOSEPH D. D'AGOSTINO, (U.S. CLS. 100, 101 AND 102). SN 77-078,133. PUB. 7-31-2007. FILED 1-8-2007.
- 3,311,155. **MISCELLANEOUS DESIGN.** SUPER PARX, (U.S. CLS. 100, 101 AND 102). SN 77-078,968. PUB. 7-10-2007. FILED 1-9-2007.
- 3,311,164. **CENTER MASS (BLOCK FORM).** CENTER MASS, INC., MULTIPLE CLASS, (INT. CLS. 35 AND 41), (U.S. CLS. 100, 101, 102 AND 107). SN 77-080,019. PUB. 7-31-2007. FILED 1-10-2007.
- 3,311,167. **PREPARING TOMORROW'S WARRIORS RESPECT ALL FEAR NONE CENTER MASS INC. AIMING FOR PERFECTION WE SAVE LIVES AND DESIGN.** CENTER MASS, INC., MULTIPLE CLASS, (INT. CLS. 35 AND 41), (U.S. CLS. 100, 101, 102 AND 107). SN 77-080,049. PUB. 7-31-2007. FILED 1-10-2007.
- 3,311,168. **AQUA SCORE (BLOCK FORM).** AUTHENTICCLICK, INC, MULTIPLE CLASS, (INT. CLS. 35 AND 42), (U.S. CLS. 100, 101 AND 102). SN 77-080,243. PUB. 7-31-2007. FILED 1-10-2007.
- 3,311,174. **EXPRESS TAX LANE POWERED BY LOPEZ TAX SERVICE AND DESIGN.** ROJAS, JOSUE O., AND LOPEZ, CARLOS C., (U.S. CLS. 100, 101 AND 102). SN 77-081,027. PUB. 7-10-2007. FILED 1-11-2007.
- 3,311,177. **ULTA BEAUTY AND DESIGN.** ULTA SALON, COSMETICS & FRAGRANCE, INC., (U.S. CLS. 100, 101 AND 102). SN 77-081,267. PUB. 7-31-2007. FILED 1-11-2007.
- 3,311,178. **ULTA BEAUTY AND DESIGN.** ULTA SALON, COSMETICS & FRAGRANCE, INC., (U.S. CLS. 100, 101 AND 102). SN 77-081,276. PUB. 7-31-2007. FILED 1-11-2007.
- 3,311,183. **QLP AND DESIGN.** QUALITY LOGO PRODUCTS, INC., (U.S. CLS. 100, 101 AND 102). SN 77-081,740. PUB. 7-31-2007. FILED 1-12-2007.
- 3,311,196. **SUITS HER SUITS HIM (BLOCK FORM).** LISA MARIE TAYLOR, (U.S. CLS. 100, 101 AND 102). SN 77-082,768. PUB. 7-31-2007. FILED 1-14-2007.
- 3,311,201. **ESE!! AND DESIGN.** ESELL, LLC, (U.S. CLS. 100, 101 AND 102). SN 77-083,282. PUB. 7-31-2007. FILED 1-15-2007.
- 3,311,204. **CAPTURE, KEEP & GROW (BLOCK FORM).** THE HARMAN GROUP, INC., (U.S. CLS. 100, 101 AND 102). SN 77-083,322. PUB. 7-31-2007. FILED 1-15-2007.
- 3,311,216 (*See Class 9 for this trademark*).
- 3,311,238. **ACTION! MAGAZINE (BLOCK FORM).** ACTION MEDIA, INC., (U.S. CLS. 100, 101 AND 102). SN 77-086,080. PUB. 7-31-2007. FILED 1-18-2007.
- 3,311,239. **ACTION! MAGAZINE AND DESIGN.** ACTION MEDIA, INC., (U.S. CLS. 100, 101 AND 102). SN 77-

- 086,112. PUB. 7-31-2007. FILED 1-18-2007.
- 3,311,245. **HAUTE DOG BOUTIQUE AND DESIGN**. HAUTE DOG BOUTIQUE, INC., (U.S. CLS. 100, 101 AND 102). SN 77-086,596. PUB. 7-10-2007. FILED 1-19-2007.
- 3,311,246. **INITIAL CALL (BLOCK FORM)**. INITIAL CALL, INC., (U.S. CLS. 100, 101 AND 102). SN 77-086,808. PUB. 7-31-2007. FILED 1-19-2007.
- 3,311,249. **BLAIR (BLOCK FORM)**. BLAIR HOLDINGS, INC., (U.S. CLS. 100, 101 AND 102). SN 77-086,960. PUB. 7-31-2007. FILED 1-19-2007.
- 3,311,263. **GOVANTRA (BLOCK FORM)**. GOVANTRA, INC., (U.S. CLS. 100, 101 AND 102). SN 77-088,287. PUB. 7-31-2007. FILED 1-22-2007.
- 3,311,274. **TASTE NAPA VALLEY (BLOCK FORM)**. NAPA VALLEY VINTNERS ASSOCIATION, (U.S. CLS. 100, 101 AND 102). SN 77-089,397. PUB. 7-31-2007. FILED 1-23-2007.
- 3,311,278. **WANTEDPOSTER (BLOCK FORM)**. GOLD KEYS DISTRIBUTION, (U.S. CLS. 100, 101 AND 102). SN 77-089,724. PUB. 7-31-2007. FILED 1-24-2007.
- 3,311,280. **KINDKARD (BLOCK FORM)**. CHESNUT JR., STEVE, (U.S. CLS. 100, 101 AND 102). SN 77-089,755. PUB. 7-31-2007. FILED 1-24-2007.
- 3,311,285. **BLUE SOURCE FURNITURE AND DESIGN**. KEENAN LLC, (U.S. CLS. 100, 101 AND 102). SN 77-090,113. PUB. 7-31-2007. FILED 1-24-2007.
- 3,311,287. **I LV AND DESIGN**. GARZA, RAYNALDO, (U.S. CLS. 100, 101 AND 102). SN 77-090,252. PUB. 7-31-2007. FILED 1-24-2007.
- 3,311,290. **MISCELLANEOUS DESIGN**. BAUMBECK, WILLIAM C., (U.S. CLS. 100, 101 AND 102). SN 77-090,445. PUB. 7-31-2007. FILED 1-24-2007.
- 3,311,291. **ROLLAREBATE (BLOCK FORM)**. OF THE NET, INC., (U.S. CLS. 100, 101 AND 102). SN 77-090,507. PUB. 7-31-2007. FILED 1-24-2007.
- 3,311,297. **VISIONSCAN AND DESIGN**. VISION COMPUTER WORKS, INC., (U.S. CLS. 100, 101 AND 102). SN 77-091,037. PUB. 7-31-2007. FILED 1-25-2007.
- 3,311,311. **MORE PREPARED AND DESIGN**. MORE PREPARED LLC, (U.S. CLS. 100, 101 AND 102). SN 77-092,622. PUB. 7-31-2007. FILED 1-26-2007.
- 3,311,326. **ALL AMERICAN DISH (BLOCK FORM)**. NATIONAL PROGRAMMING SERVICE, LLC, (U.S. CLS. 100, 101 AND 102). SN 77-093,950. PUB. 7-31-2007. FILED 1-29-2007.
- 3,311,329 (*See Class 16 for this trademark*).
- 3,311,339. **MISCELLANEOUS DESIGN**. ADVANCED DATA PROCESSING, INC., (U.S. CLS. 100, 101 AND 102). SN 77-094,448. PUB. 7-31-2007. FILED 1-30-2007.
- 3,311,340. **VISION 2 EXECUTION (BLOCK FORM)**. VISION 2 EXECUTION, LLC, (U.S. CLS. 100, 101 AND 102). SN 77-094,487. PUB. 7-31-2007. FILED 1-30-2007.
- 3,311,344. **DOPI KARAOKE.COM AND DESIGN**. DOPI KARAOKE, INC., (U.S. CLS. 100, 101 AND 102). SN 77-095,053. PUB. 7-31-2007. FILED 1-30-2007.
- 3,311,356. **PAYROLLGURU (BLOCK FORM)**. PAYROLLGURU, INC., MULTIPLE CLASS, (INT. CLS. 35 AND 42), (U.S. CLS. 100, 101 AND 102). SN 77-096,295. PUB. 7-31-2007. FILED 1-31-2007.
- 3,311,358. **KRIS' KITCHEN (BLOCK FORM)**. ONE SIX EIGHT, LLC, DBA KRIS' KITCHEN, (U.S. CLS. 100, 101 AND 102). SN 77-096,409. PUB. 7-31-2007. FILED 2-1-2007.
- 3,311,365. **CHRIS' SQUIRRELS AND MORE (BLOCK FORM)**. SQUIRRELS AND MORE, LLC, (U.S. CLS. 100, 101 AND 102). SN 77-096,757. PUB. 7-31-2007. FILED 2-1-2007.
- 3,311,366. **RETURN ON LIFE (BLOCK FORM)**. ADVISOR INSIGHTS, (U.S. CLS. 100, 101 AND 102). SN 77-096,765. PUB. 7-31-2007. FILED 2-1-2007.
- 3,311,376 (*See Class 5 for this trademark*).
- 3,311,377. **SIENNA TECHNOLOGIES (BLOCK FORM)**. SIENNA TECHNOLOGIES, INC., (U.S. CLS. 100, 101 AND 102). SN 77-097,541. PUB. 7-31-2007. FILED 2-2-2007.
- 3,311,381. **SIENNA ASSOCIATES (BLOCK FORM)**. SIENNA TECHNOLOGIES, INC., (U.S. CLS. 100, 101 AND 102). SN 77-097,626. PUB. 7-31-2007. FILED 2-2-2007.
- 3,311,393. **NATIONAL FITNESS TRADE SHOW (BLOCK FORM)**. WALLY BOYKO PRODUCTIONS, INC., (U.S. CLS. 100, 101 AND 102). SN 77-098,061. PUB. 7-31-2007. FILED 2-2-2007.
- 3,311,398. **THE MAYOR'S CARD AND DESIGN**. ROGERS, JOHN, (U.S. CLS. 100, 101 AND 102). SN 77-098,230. PUB. 7-31-2007. FILED 2-2-2007.
- 3,311,399. **TASTE THE PLACE (BLOCK FORM)**. TEMECULA VALLEY WINEGROWERS ASSOCIATION, (U.S. CLS. 100, 101 AND 102). SN 77-098,235. PUB. 7-31-2007. FILED 2-2-2007.
- 3,311,402. **PLAYFUL EFFORTS INTERACTIVE DESIGN FOR PLAY AND LEARNING AND DESIGN**. SHULMAN, DAVID, (U.S. CLS. 100, 101 AND 102). SN 77-098,299. PUB. 7-31-2007. FILED 2-2-2007.
- 3,311,405. **JIFFY SHIRTS (BLOCK FORM)**. SHIRT SUPPLY AND DECORATION LLC, (U.S. CLS. 100, 101 AND 102). SN 77-098,413. PUB. 7-31-2007. FILED 2-2-2007.
- 3,311,409. **GET READY! (BLOCK FORM)**. HANNAH SAVANNAH, LLC, (U.S. CLS. 100, 101 AND 102). SN 77-098,624. PUB. 7-31-2007. FILED 2-3-2007.
- 3,311,433. **ACCESS CASH (BLOCK FORM)**. ACCESS CASH INTERNATIONAL, LLC, (U.S. CLS. 100, 101 AND 102). SN 77-099,286. PUB. 7-31-2007. FILED 2-5-2007.
- 3,311,441. **FOREVER FLAWLESS (BLOCK FORM)**. FOREVER FLAWLESS, LLC, (U.S. CLS. 100, 101 AND 102). SN 77-099,562. PUB. 7-31-2007. FILED 2-5-2007.
- 3,311,447. **FOCUS THE NATION (BLOCK FORM)**. GREEN HOUSE NETWORK, (U.S. CLS. 100, 101 AND 102). SN 77-099,750. PUB. 7-31-2007. FILED 2-5-2007.
- 3,311,453. **ACTIVE STRATEGIES FOR PASSIVE CANDIDATES (BLOCK FORM)**. QUALIGENCE, INC., (U.S. CLS. 100, 101 AND 102). SN 77-100,109. PUB. 7-31-2007. FILED 2-6-2007.
- 3,311,457. **HEALTHY EYES HEALTHY PEOPLE (BLOCK FORM)**. AMERICAN OPTOMETRIC ASSOCIATION, MULTIPLE CLASS, (INT. CLS. 35 AND 36), (U.S. CLS. 100, 101 AND 102). SN 77-100,484. PUB. 7-31-2007. FILED 2-6-2007.
- 3,311,460. **THE FULTON STORES (BLOCK FORM)**. FULTON OUTFITTERS, INC., (U.S. CLS. 100, 101 AND 102). SN 77-100,665. PUB. 7-31-2007. FILED 2-6-2007.
- 3,311,506. **THE PEDIGREE ADOPTION DRIVE AND DESIGN**. MARS, INCORPORATED, (U.S. CLS. 100, 101 AND 102). SN 77-107,864. PUB. 7-31-2007. FILED 2-14-2007.
- 3,311,507. **MISCELLANEOUS DESIGN**. MARS, INCORPORATED, (U.S. CLS. 100, 101 AND 102). SN 77-107,875. PUB. 7-31-2007. FILED 2-14-2007.
- 3,311,511. **BENETERRA LLC AND DESIGN**. BENETERRA, LLC, MULTIPLE CLASS, (INT. CLS. 35, 39, 40 AND 44), (U.S. CLS. 100, 101, 102, 103, 105 AND 106). SN 77-109,141. PUB. 7-31-2007. FILED 2-16-2007.
- 3,311,520. **LUNA FLOORING GALLERY (BLOCK FORM)**. LUNA CARPET & BLINDS CO., INC., MULTIPLE CLASS, (INT. CLS. 35 AND 37), (U.S. CLS. 100, 101, 102, 103 AND 106). SN 77-110,594. PUB. 7-31-2007. FILED 2-19-2007.
- 3,311,521. **SUREQUOTE (BLOCK FORM)**. LUNA CARPET & BLINDS CO., INC., MULTIPLE CLASS, (INT. CLS. 35 AND 37), (U.S. CLS. 100, 101, 102, 103 AND 106). SN 77-110,625. PUB. 7-31-2007. FILED 2-19-2007.
- 3,311,524. **CYBERWIZE (BLOCK FORM)**. CYBERWIZE.COM, INC., (U.S. CLS. 100, 101 AND 102). SN 77-111,631. PUB. 7-31-2007. FILED 2-20-2007.
- 3,311,525. **BENETERRA LLC (BLOCK FORM)**. BENETERRA, LLC, MULTIPLE CLASS, (INT. CLS. 35, 39, 40 AND 44), (U.S. CLS. 100, 101, 102, 103, 105 AND 106). SN 77-111,881. PUB. 7-31-2007. FILED 2-20-2007.
- 3,311,528. **TRANSFORMING FLEET DATA INTO BUSINESS VALUE (BLOCK FORM)**. AUTOMOTIVE RENTALS, INC., (U.S. CLS. 100, 101 AND 102). SN 77-112,640. PUB. 7-31-2007. FILED 2-21-2007.
- 3,311,530. **CHICAGO BOAT, RV & OUTDOORS SHOW (BLOCK FORM)**. NATIONAL MARINE MANUFACTURERS ASSOCIATION, INC., (U.S. CLS. 100, 101 AND 102). SN 77-113,136. PUB. 7-31-2007. FILED 2-22-2007.
- 3,311,543. **OROLATINA.COM (BLOCK FORM)**. CRE, L.L.C., (U.S. CLS. 100, 101 AND 102). SN 77-116,593. PUB. 7-31-2007. FILED 2-26-2007.
- 3,311,544. **ZOOBILATION (BLOCK FORM)**. INDIANA SOCIETY FOR THE PREVENTION OF CRUELTY TO ANIMALS CORP, (U.S. CLS. 100, 101 AND 102). SN 77-

- 116,715. PUB. 7-31-2007. FILED 2-26-2007.
- 3,311,546. **WWJOL (BLOCK FORM)**. WORLD WIDE JEWELRY ONLINE, INC., (U.S. CLS. 100, 101 AND 102). SN 77-117,128. PUB. 7-31-2007. FILED 2-27-2007.
- 3,311,553. **MISCELLANEOUS DESIGN. OUTDOOR SPORTS MARKETING**, (U.S. CLS. 100, 101 AND 102). SN 77-118,351. PUB. 7-31-2007. FILED 2-28-2007.
- 3,311,557. **LUGGAGE TO GO (BLOCK FORM)**. LUGGAGE TO GO, INC., (U.S. CLS. 100, 101 AND 102). SN 77-120,791. PUB. 7-31-2007. FILED 3-2-2007.
- 3,311,559 (*See Class 16 for this trademark*).
- 3,311,560. **AHAF (BLOCK FORM)**. AMERICAN HEALTH ASSISTANCE FOUNDATION, MULTIPLE CLASS, (INT. CLS. 35, 36 AND 44), (U.S. CLS. 100, 101 AND 102). SN 77-121,330. PUB. 7-31-2007. FILED 3-2-2007.
- 3,311,566. **PRIME PERFORMANCE NUTRITION (BLOCK FORM)**. JA BUTLER COMPANIES INC., (U.S. CLS. 100, 101 AND 102). SN 77-124,364. PUB. 7-31-2007. FILED 3-7-2007.
- 3,311,569. **DUMP IT (BLOCK FORM)**. GAUTAM, RAJESH, (U.S. CLS. 100, 101 AND 102). SN 77-125,136. PUB. 7-31-2007. FILED 3-7-2007.
- 3,311,571. **GET A NEW LEASE ON LIFE (BLOCK FORM)**. AARON INVESTMENT COMPANY, (U.S. CLS. 100, 101 AND 102). SN 77-125,807. PUB. 7-31-2007. FILED 3-8-2007.
- 3,311,572. **EVERYONE'S A LUCKY DOG AT AARON'S (BLOCK FORM)**. AARON INVESTMENT COMPANY, (U.S. CLS. 100, 101 AND 102). SN 77-125,867. PUB. 7-31-2007. FILED 3-8-2007.
- 3,311,573. **LUCKY DOG (BLOCK FORM)**. AARON INVESTMENT COMPANY, (U.S. CLS. 100, 101 AND 102). SN 77-125,933. PUB. 7-31-2007. FILED 3-8-2007.
- 3,311,579. **REDSOUT (BLOCK FORM)**. REDSCOUT, INC., (U.S. CLS. 100, 101 AND 102). SN 77-127,083. PUB. 7-31-2007. FILED 3-9-2007.
- 3,311,593. **PEEKYOU (BLOCK FORM)**. GNITETSKIY, PAVEL V, (U.S. CLS. 100, 101 AND 102). SN 77-132,077. PUB. 7-31-2007. FILED 3-15-2007.
- 3,311,603. **SEMINOLE NATION OF OKLAHOMA (BLOCK FORM)**. THE SEMINOLE NATION OF OKLAHOMA, MULTIPLE CLASS, (INT. CLS. 35 AND 41), (U.S. CLS. 100, 101, 102 AND 107). SN 77-141,145. PUB. 7-31-2007. FILED 3-27-2007.
- 3,311,612. **FLEETFILTER (BLOCK FORM)**. BRENHAM AUTO LTD, (U.S. CLS. 100, 101 AND 102). SN 77-149,701. PUB. 7-31-2007. FILED 4-5-2007.
- 3,311,621. **BEYOND FEBRUARY (BLOCK FORM)**. ALLSTATE INSURANCE COMPANY, (U.S. CLS. 100, 101 AND 102). SN 77-158,897. PUB. 7-31-2007. FILED 4-17-2007.
- 3,311,622. **BEYOND FEBRUARY AND DESIGN**. ALLSTATE INSURANCE COMPANY, (U.S. CLS. 100, 101 AND 102). SN 77-158,900. PUB. 7-31-2007. FILED 4-17-2007.
- 3,311,630 (*See Class 18 for this trademark*).
- 3,311,637. **UP CLOSE AND PERSONAL**. GHERMEZIAN, MARK, (U.S. CLS. 100, 101 AND 102). SN 78-205,886. PUB. 7-31-2007. FILED 1-22-2003.
- 3,311,638. **KECDISEIGN AND DESIGN**. KECDESIGN, LLC, MULTIPLE CLASS, (INT. CLS. 35, 37 AND 42), (U.S. CLS. 100, 101, 102, 103 AND 106). SN 78-209,668. PUB. 7-31-2007. FILED 1-31-2003.
- 3,311,644. **CHAIR SPA AND DESIGN**. OSIM INTERNATIONAL LTD., (U.S. CLS. 100, 101 AND 102). SN 78-299,633. PUB. 7-31-2007. FILED 9-12-2003.
- 3,311,645 (*See Class 7 for this trademark*).
- 3,311,651 (*See Class 9 for this trademark*).
- 3,311,660. **NEXSTEPS (BLOCK FORM)**. AMERICAN SOCIETY OF SAFETY ENGINEERS, (U.S. CLS. 100, 101 AND 102). SN 78-460,137. PUB. 7-31-2007. FILED 8-1-2004.
- 3,311,662. **SOHO VILLAGE THE SHOPPING DISTRICT AT NEW YORK - NEW YORK AND DESIGN**. NEW YORK - NEW YORK HOTEL & CASINO, LLC, (U.S. CLS. 100, 101 AND 102). SN 78-471,345. PUB. 7-31-2007. FILED 8-20-2004.
- 3,311,664 (*See Class 3 for this trademark*).
- 3,311,665 (*See Class 16 for this trademark*).
- 3,311,666 (*See Class 9 for this trademark*).
- 3,311,667. **TARGET TRAINING (BLOCK FORM)**. TARGET TRAINING INTERNATIONAL, INC., (U.S. CLS. 100, 101 AND 102). SN 78-506,285. PUB. 7-31-2007. FILED 10-26-2004.
- 3,311,679. **CHEFTOOLS.COM AND DESIGN**. CHEF TOOLS NETWORK, INC., (U.S. CLS. 100, 101 AND 102). SN 78-547,724. PUB. 7-31-2007. FILED 1-14-2005.
- 3,311,686 (*See Class 25 for this trademark*).
- 3,311,687 (*See Class 9 for this trademark*).
- 3,311,700 (*See Class 9 for this trademark*).
- 3,311,716. **IT'S NICER UP HERE (BLOCK FORM)**. WESTJET AIRLINES LTD., MULTIPLE CLASS, (INT. CLS. 35, 39 AND 43), (U.S. CLS. 100, 101, 102 AND 105). SN 78-630,692. PUB. 7-31-2007. FILED 5-16-2005.
- 3,311,733. **INSIDE. OUTSIDE. ALL AROUND THE HOUSE. (BLOCK FORM)**. SERVICEMASTER BRANDS L.L.C., MULTIPLE CLASS, (INT. CLS. 35 AND 37), (U.S. CLS. 100, 101, 102, 103 AND 106). SN 78-652,787. PUB. 7-31-2007. FILED 6-17-2005.
- 3,311,735. **BI-PRO (BLOCK FORM)**. BI-PRO MARKETING LIMITED, MULTIPLE CLASS, (INT. CLS. 35 AND 39), (U.S. CLS. 100, 101, 102 AND 105). SN 78-653,841. PUB. 7-31-2007. FILED 6-20-2005.
- 3,311,744. **ZIP SELECT (BLOCK FORM)**. WRIGHT EXPRESS CORPORATION, MULTIPLE CLASS, (INT. CLS. 35 AND 36), (U.S. CLS. 100, 101 AND 102). SN 78-660,029. PUB. 7-31-2007. FILED 6-28-2005.
- 3,311,753. **SOUTHERN STATES PBA AND DESIGN**. SOUTHERN STATES POLICE BENEVOLENT ASSOCIATION, INC., MULTIPLE CLASS, (INT. CLS. 35 AND 41), (U.S. CLS. 100, 101, 102 AND 107). SN 78-677,634. PUB. 7-31-2007. FILED 7-25-2005.
- 3,311,767. **V VALLEYLISTS.COM AND DESIGN**. FLANDERS, T. WILSON, (U.S. CLS. 100, 101 AND 102). SN 78-691,232. PUB. 7-31-2007. FILED 8-12-2005.
- 3,311,771 (*See Class 16 for this trademark*).
- 3,311,774. **AIMING HIGH, EXCEEDING EXPECTATIONS (BLOCK FORM)**. ORION SEARCH GROUP, INC., (U.S. CLS. 100, 101 AND 102). SN 78-698,464. PUB. 7-31-2007. FILED 8-23-2005.
- 3,311,776. **TMG E MEDIA AND DESIGN**. TMG-EMEDIA, INC., MULTIPLE CLASS, (INT. CLS. 35 AND 42), (U.S. CLS. 100, 101 AND 102). SN 78-698,998. PUB. 7-31-2007. FILED 8-24-2005.
- 3,311,782. **KISSIMMEE FOUNDED 1883 WWW.KISSIMMEE.ORG WORK. PLAY. VACATION. HOME. AND DESIGN**. CITY OF KISSIMMEE, (U.S. CLS. 100, 101 AND 102). SN 78-701,164. PUB. 7-31-2007. FILED 8-26-2005.
- 3,311,783. **B AND DESIGN**. BRIERLEY & PARTNERS, INC., MULTIPLE CLASS, (INT. CLS. 35 AND 42), (U.S. CLS. 100, 101 AND 102). SN 78-702,055. PUB. 7-31-2007. FILED 8-28-2005.
- 3,311,794. **HTS (BLOCK FORM)**. HTS, LLC, MULTIPLE CLASS, (INT. CLS. 35, 37 AND 41), (U.S. CLS. 100, 101, 102, 103, 106 AND 107). SN 78-710,645. PUB. 7-31-2007. FILED 9-11-2005.
- 3,311,810. **DIRECTORS WORLD (BLOCK FORM)**. CMP ENTERTAINMENT MEDIA, INC., (U.S. CLS. 100, 101 AND 102). SN 78-722,660. PUB. 7-31-2007. FILED 9-28-2005.
- 3,311,812. **ADVANCING LOYALTY (BLOCK FORM)**. BRIERLEY & PARTNERS, INC., MULTIPLE CLASS, (INT. CLS. 35 AND 42), (U.S. CLS. 100, 101 AND 102). SN 78-723,515. PUB. 7-31-2007. FILED 9-29-2005.
- 3,311,813. **YOUR PERSONAL SOMMELIER (BLOCK FORM)**. COURTNEY COCHRAN, MULTIPLE CLASS, (INT. CLS. 35, 41 AND 43), (U.S. CLS. 100, 101, 102 AND 107). SN 78-723,763. PUB. 7-31-2007. FILED 9-29-2005.
- 3,311,822. **CHANNEL CONNECTION (BLOCK FORM)**. AVNET, INC., (U.S. CLS. 100, 101 AND 102). SN 78-730,081. PUB. 4-10-2007. FILED 10-10-2005.
- 3,311,844. **JP JOHNNY PICASSO'S AND DESIGN**. ARCHIBALD, JOHN, JOSEPH, (U.S. CLS. 100, 101 AND 102). SN 78-743,943. PUB. 7-31-2007. FILED 10-31-2005.
- 3,311,850 (*See Class 9 for this trademark*).
- 3,311,852. **FUEL OUTDOOR (BLOCK FORM)**. FUEL OUTDOOR LLC, (U.S. CLS. 100, 101 AND 102). SN 78-749,688. PUB. 7-31-2007. FILED 11-8-2005.
- 3,311,853 (*See Class 25 for this trademark*).
- 3,311,862 (*See Class 4 for this trademark*).
- 3,311,863. **MOLLYGUARD (BLOCK FORM)**. MOLLYGUARD CORPORATION, (U.S. CLS. 100, 101 AND 102). SN 78-761,706. PUB. 7-31-2007. FILED 11-28-2005.

- 3,311,868 (*See Class 25 for this trademark.*)
- 3,311,870. **COMPUAMERICA (BLOCK FORM)**. SHULMAN, JACK A., (U.S. CLS. 100, 101 AND 102). SN 78-766,509. PUB. 7-31-2007. FILED 12-5-2005.
- 3,311,874 (*See Class 16 for this trademark.*)
- 3,311,878. **THE AMERICAN ORTHOPAEDIC ASSOCIATION (BLOCK FORM)**. THE AMERICAN ORTHOPAEDIC ASSOCIATION, (U.S. CLS. 100, 101 AND 102). SN 78-775,913. PUB. 7-31-2007. FILED 12-19-2005.
- 3,311,889. **TOTAL LOGISTIC CONTROL (BLOCK FORM)**. TOTAL LOGISTIC CONTROL LLC, MULTIPLE CLASS, (INT. CLS. 35 AND 39), (U.S. CLS. 100, 101, 102 AND 105). SN 78-783,928. PUB. 2-13-2007. FILED 1-3-2006.
- 3,311,891. **FAXYLADY (BLOCK FORM)**. AIKENS, MAI-LAN, (U.S. CLS. 100, 101 AND 102). SN 78-785,241. PUB. 7-31-2007. FILED 1-4-2006.
- 3,311,893. **VETBIZ AND DESIGN**. U.S. DEPARTMENT OF VETERANS AFFAIRS, MULTIPLE CLASS, (INT. CLS. 35, 36 AND 41), (U.S. CLS. 100, 101, 102 AND 107). SN 78-785,444. PUB. 7-31-2007. FILED 1-5-2006.
- 3,311,894. **UNISOURCE SOLUTIONS (BLOCK FORM)**. UNISOURCE SOLUTIONS, INC., MULTIPLE CLASS, (INT. CLS. 35, 37, 39 AND 42), (U.S. CLS. 100, 101, 102, 103, 105 AND 106). SN 78-785,995. PUB. 7-31-2007. FILED 1-5-2006.
- 3,311,896. **WESTERN ENERGETIX (BLOCK FORM)**. BERRY-HINCKLEY INDUSTRIES, (U.S. CLS. 100, 101 AND 102). SN 78-787,771. PUB. 4-10-2007. FILED 1-9-2006.
- 3,311,898 (*See Class 3 for this trademark.*)
- 3,311,912. **FAMILY READING PARTNERSHIP (BLOCK FORM)**. FAMILY READING PARTNERSHIP, INC., MULTIPLE CLASS, (INT. CLS. 35 AND 41), (U.S. CLS. 100, 101, 102 AND 107). SN 78-800,333. PUB. 6-12-2007. FILED 1-26-2006.
- 3,311,914. **YOUR EQUIPMENT JUST GOT SMARTER (BLOCK FORM)**. SMARTEQUIP, INC., MULTIPLE CLASS, (INT. CLS. 35 AND 37), (U.S. CLS. 100, 101, 102, 103 AND 106). SN 78-800,868. PUB. 7-31-2007. FILED 1-27-2006.
- 3,311,918. **ARLINGDALE FINEST COLLECTOR ITEMS AND DESIGN**. ATLANTIGO LLC, (U.S. CLS. 100, 101 AND 102). SN 78-801,751. PUB. 7-31-2007. FILED 1-29-2006.
- 3,311,919. **HOUSE OF VODOO (BLOCK FORM)**. HEMBCO, INC., (U.S. CLS. 100, 101 AND 102). SN 78-802,921. PUB. 4-17-2007. FILED 1-30-2006.
- 3,311,920. **MARIE LAVEAU'S HOUSE OF VODOO (BLOCK FORM)**. HEMBCO, INC., (U.S. CLS. 100, 101 AND 102). SN 78-802,937. PUB. 4-17-2007. FILED 1-30-2006.
- 3,311,923. **CHEF'S RESOURCE (BLOCK FORM)**. SYNERGY COMPUTING BUSINESS GROUP, INC., (U.S. CLS. 100, 101 AND 102). SN 78-803,721. PUB. 7-31-2007. FILED 1-31-2006.
- 3,311,927. **TURNER EFFECT AND DESIGN**. TURNER MARKETING INCORPORATED, MULTIPLE CLASS, (INT. CLS. 35 AND 42), (U.S. CLS. 100, 101 AND 102). SN 78-806,439. PUB. 7-31-2007. FILED 2-3-2006.
- 3,311,930. **FORT DATA (BLOCK FORM)**. NETWORK OPTIONS, INC., (U.S. CLS. 100, 101 AND 102). SN 78-807,937. PUB. 4-10-2007. FILED 2-6-2006.
- 3,311,934. **AMERIMED CONSULTING (STYLIZED)**. AMERIMED CONSULTING, (U.S. CLS. 100, 101 AND 102). SN 78-810,354. PUB. 7-31-2007. FILED 2-8-2006.
- 3,311,951. **PIXTO-U (BLOCK FORM)**. PIXTO-U, LLC, MULTIPLE CLASS, (INT. CLS. 35 AND 40), (U.S. CLS. 100, 101, 102, 103 AND 106). SN 78-824,449. PUB. 7-31-2007. FILED 2-27-2006.
- 3,311,952. **PIXTO-U AND DESIGN**. PIXTO-U, LLC, MULTIPLE CLASS, (INT. CLS. 35 AND 40), (U.S. CLS. 100, 101, 102, 103 AND 106). SN 78-824,484. PUB. 7-31-2007. FILED 2-27-2006.
- 3,311,953. **PIXTO-U AND DESIGN**. PIXTO-U, LLC, MULTIPLE CLASS, (INT. CLS. 35 AND 40), (U.S. CLS. 100, 101, 102, 103 AND 106). SN 78-824,492. PUB. 7-31-2007. FILED 2-27-2006.
- 3,311,962 (*See Class 16 for this trademark.*)
- 3,311,965 (*See Class 33 for this trademark.*)
- 3,311,975. **WHITE PARCEL AND DESIGN**. WHITE PARCEL, LLC, (U.S. CLS. 100, 101 AND 102). SN 78-837,388. PUB. 7-31-2007. FILED 3-15-2006.
- 3,311,982. **ESPERANZA USA AND DESIGN**. NUEVE ESPERANZA, INC., (U.S. CLS. 100, 101 AND 102). SN 78-838,574. PUB. 7-31-2007. FILED 3-16-2006.
- 3,311,984 (*See Class 9 for this trademark.*)
- 3,311,996. **PARFAIT MODELS (BLOCK FORM)**. THE MODELERS, LLC, (U.S. CLS. 100, 101 AND 102). SN 78-845,969. PUB. 7-31-2007. FILED 3-24-2006.
- 3,311,999. **ALL3SPORTS AND DESIGN**. ALL3SPORTS, INC., (U.S. CLS. 100, 101 AND 102). SN 78-847,255. PUB. 4-17-2007. FILED 3-27-2006.
- 3,312,001 (*See Class 16 for this trademark.*)
- 3,312,010. **THE PERFECT PLACE TO BUILD YOUR BUSINESS (BLOCK FORM)**. PWG HOLDINGS, LLC, (U.S. CLS. 100, 101 AND 102). SN 78-850,039. PUB. 7-31-2007. FILED 3-30-2006.
- 3,312,013 (*See Class 9 for this trademark.*)
- 3,312,018. **NOVIA CARECLINICS (BLOCK FORM)**. NOVIA CARECLINICS, LLC, (U.S. CLS. 100, 101 AND 102). SN 78-852,475. PUB. 7-31-2007. FILED 4-3-2006.
- 3,312,025. **NC AND DESIGN**. NOVIA CARECLINICS, LLC, (U.S. CLS. 100, 101 AND 102). SN 78-854,472. PUB. 7-31-2007. FILED 4-5-2006.
- 3,312,029. **MYNURSE 24 7 AND DESIGN**. HEALTH CONTACT PARTNERS, INC., MULTIPLE CLASS, (INT. CLS. 35 AND 44), (U.S. CLS. 100, 101 AND 102). SN 78-855,073. PUB. 7-31-2007. FILED 4-5-2006.
- 3,312,031. **BE YOUR BEST (BLOCK FORM)**. THINK SMART, S.A., (U.S. CLS. 100, 101 AND 102). SN 78-855,248. PUB. 7-31-2007. FILED 4-6-2006.
- 3,312,032 (*See Class 9 for this trademark.*)
- 3,312,034. **KECDESIGN (BLOCK FORM)**. KECDESIGN, INC. LLC, MULTIPLE CLASS, (INT. CLS. 35, 37 AND 42), (U.S. CLS. 100, 101, 102, 103 AND 106). SN 78-855,969. PUB. 7-31-2007. FILED 4-6-2006.
- 3,312,035 (*See Class 9 for this trademark.*)
- 3,312,052. **AMERICAN EXCHANGE NETWORK (BLOCK FORM)**. BARTER AMERICAS, (U.S. CLS. 100, 101 AND 102). SN 78-861,387. PUB. 7-31-2007. FILED 4-13-2006.
- 3,312,053. **MISCELLANEOUS DESIGN**. ANAWALT LUMBER CO., INC., (U.S. CLS. 100, 101 AND 102). SN 78-861,445. PUB. 7-31-2007. FILED 4-13-2006.
- 3,312,055. **BOARDCOMPASS (BLOCK FORM)**. NATIONAL RESEARCH CORPORATION, (U.S. CLS. 100, 101 AND 102). SN 78-862,485. PUB. 7-31-2007. FILED 4-17-2006.
- 3,312,066. **CONSTANTIN (BLOCK FORM)**. LEON CONSTANTIN CONSULTING, INC., (U.S. CLS. 100, 101 AND 102). SN 78-865,491. PUB. 7-31-2007. FILED 4-20-2006.
- 3,312,072. **SEQUIM LAVENDER FESTIVAL (BLOCK FORM)**. SEQUIM LAVENDER GROWERS ASSOCIATION, MULTIPLE CLASS, (INT. CLS. 35 AND 39), (U.S. CLS. 100, 101, 102 AND 105). SN 78-866,551. PUB. 7-31-2007. FILED 4-21-2006.
- 3,312,073. **CELEBRATE LAVENDER (BLOCK FORM)**. SEQUIM LAVENDER GROWERS ASSOCIATION, (U.S. CLS. 100, 101 AND 102). SN 78-866,573. PUB. 7-31-2007. FILED 4-21-2006.
- 3,312,077. **WE TAKE BRANDS PLACES THEY'VE NEVER BEEN. (BLOCK FORM)**. STRATEGIC SPORTS GROUP, INC., DBA STRATEGIC, (U.S. CLS. 100, 101 AND 102). SN 78-867,533. PUB. 7-31-2007. FILED 4-23-2006.
- 3,312,079. **RALLY WITH SALLY FOR BONE HEALTH AND DESIGN**. ROCHE THERAPEUTICS INC., MULTIPLE CLASS, (INT. CLS. 35 AND 44), (U.S. CLS. 100, 101 AND 102). SN 78-869,633. PUB. 7-31-2007. FILED 4-26-2006.
- 3,312,080. **ISGIE (BLOCK FORM)**. INTERNATIONAL GOLF & COUNTRY CLUB, LLC, (U.S. CLS. 100, 101 AND 102). SN 78-869,636. PUB. 7-31-2007. FILED 4-26-2006.
- 3,312,081. **ISGIE AND DESIGN**. INTERNATIONAL GOLF & COUNTRY CLUB, LLC, (U.S. CLS. 100, 101 AND 102). SN 78-869,655. PUB. 7-31-2007. FILED 4-26-2006.
- 3,312,084. **MARISOL INTERNATIONAL AND DESIGN**. MARISOL INTERNATIONAL LLC, MULTIPLE CLASS, (INT. CLS. 35 AND 39), (U.S. CLS. 100, 101, 102 AND 105). SN 78-870,899. PUB. 7-31-2007. FILED 4-27-2006.
- 3,312,090. **SHOP FRESH (BLOCK FORM)**. NSF INTERNATIONAL, MULTIPLE CLASS, (INT. CLS. 35, 36, 37 AND 42), (U.S. CLS. 100, 101, 102, 103 AND 106). SN 78-871,423. PUB. 7-31-2007. FILED 4-27-2006.
- 3,312,095. **DRESS TO IMPRESS (BLOCK FORM)**. ABDELHAMID KITTANEH, (U.S. CLS. 100, 101 AND 102). SN 78-871,835. PUB. 7-31-2007. FILED 4-28-2006.

- 3,312,104. **SPI (BLOCK FORM)**. SALES PERFORMANCE HOLDING COMPANY, MULTIPLE CLASS, (INT. CLS. 35 AND 41), (U.S. CLS. 100, 101, 102 AND 107). SN 78-873,181. PUB. 7-31-2007. FILED 5-1-2006.
- 3,312,117. **MASTERS OF THE AMERICAN WEST (BLOCK FORM)**. AUTRY NATIONAL CENTER, MULTIPLE CLASS, (INT. CLS. 35 AND 41), (U.S. CLS. 100, 101, 102 AND 107). SN 78-874,815. PUB. 7-31-2007. FILED 5-2-2006.
- 3,312,121. **ADVENTURE NORTH OUTFITTERS AND DESIGN**. GRAND TRAVERSE RESORT AND SPA, LLC, MULTIPLE CLASS, (INT. CLS. 35 AND 41), (U.S. CLS. 100, 101, 102 AND 107). SN 78-875,216. PUB. 7-31-2007. FILED 5-3-2006.
- 3,312,126 (*See Class 19 for this trademark*).
- 3,312,128 (*See Class 19 for this trademark*).
- 3,312,129 (*See Class 19 for this trademark*).
- 3,312,135. **BOND JEWELERS (BLOCK FORM)**. BOND & CO. JEWELERS, INC., (U.S. CLS. 100, 101 AND 102). SN 78-876,706. PUB. 7-31-2007. FILED 5-4-2006.
- 3,312,137 (*See Class 5 for this trademark*).
- 3,312,138. **NEW ENGLAND COFFEE (BLOCK FORM)**. NEW ENGLAND TEA & COFFEE CO., INC., (U.S. CLS. 100, 101 AND 102). SN 78-877,579. PUB. 7-31-2007. FILED 5-5-2006.
- 3,312,140. **S SUBSIDE SPORTS AND DESIGN**. SUBSIDE SPORTS LTD, (U.S. CLS. 100, 101 AND 102). SN 78-877,641. PUB. 7-31-2007. FILED 5-5-2006.
- 3,312,142. **G AND DESIGN**. ADTECH-GESI, LLC, MULTIPLE CLASS, (INT. CLS. 35 AND 42), (U.S. CLS. 100, 101 AND 102). SN 78-877,773. PUB. 7-31-2007. FILED 5-5-2006.
- 3,312,151. **AUNT BEEP (BLOCK FORM)**. TEE, TRACEY S., (U.S. CLS. 100, 101 AND 102). SN 78-878,713. PUB. 7-31-2007. FILED 5-8-2006.
- 3,312,158. **ASHE AND DESIGN**. AMERICAN HOSPITAL ASSOCIATION, (U.S. CLS. 100, 101 AND 102). SN 78-880,352. PUB. 7-31-2007. FILED 5-10-2006.
- 3,312,167. **HIPTIX (BLOCK FORM)**. ROUNDABOUT THEATRE COMPANY, INC., (U.S. CLS. 100, 101 AND 102). SN 78-881,058. PUB. 7-31-2007. FILED 5-11-2006.
- 3,312,173 (*See Class 29 for this trademark*).
- 3,312,185 (*See Class 9 for this trademark*).
- 3,312,187. **S DESIGN AND DESIGN**. SEQUENT LEARNING NETWORKS, INC., MULTIPLE CLASS, (INT. CLS. 35 AND 41), (U.S. CLS. 100, 101, 102 AND 107). SN 78-883,723. PUB. 7-31-2007. FILED 5-15-2006.
- 3,312,190. **TC CITADEL (BLOCK FORM)**. TCSP, INC., (U.S. CLS. 100, 101 AND 102). SN 78-884,083. PUB. 7-31-2007. FILED 5-15-2006.
- 3,312,193. **MARKETREACH AMERICA (BLOCK FORM)**. MARYLAND/ISRAEL DEVELOPMENT CENTER, INC., (U.S. CLS. 100, 101 AND 102). SN 78-884,457. PUB. 7-31-2007. FILED 5-16-2006.
- 3,312,195 (*See Class 18 for this trademark*).
- 3,312,205 (*See Class 9 for this trademark*).
- 3,312,212 (*See Class 3 for this trademark*).
- 3,312,213. **HOUSE WEAR AND DESIGN**. FERVOR, INC., (U.S. CLS. 100, 101 AND 102). SN 78-887,006. PUB. 7-31-2007. FILED 5-18-2006.
- 3,312,218. **KNOWLEDGESEEKERS DIVERSITY SCHOLARSHIP, RECRUITMENT, AND EDUCATION OPPORTUNITY DATABASE AND DESIGN**. AMERICAN LIBRARY ASSOCIATION, MULTIPLE CLASS, (INT. CLS. 35 AND 36), (U.S. CLS. 100, 101 AND 102). SN 78-887,157. PUB. 7-31-2007. FILED 5-18-2006.
- 3,312,219. **WORK INTELLIGENCE BEAUTY SPANISH WATER DOG ASSOCIATION OF AMERICA AND DESIGN**. SPANISH WATER DOG ASSOCIATION OF AMERICA, INC., (U.S. CLS. 100, 101 AND 102). SN 78-887,322. PUB. 7-31-2007. FILED 5-18-2006.
- 3,312,224. **FB FUBONN AND DESIGN**. JINTHAY TRADING CORP., MULTIPLE CLASS, (INT. CLS. 35 AND 36), (U.S. CLS. 100, 101 AND 102). SN 78-888,208. PUB. 7-31-2007. FILED 5-19-2006.
- 3,312,225. **PHONETRACER (BLOCK FORM)**. ASURION CORPORATION, (U.S. CLS. 100, 101 AND 102). SN 78-888,529. PUB. 7-31-2007. FILED 5-21-2006.
- 3,312,226. **ROSIE THE SURVIVOR (BLOCK FORM)**. KOG ENTERPRISES, INC., (U.S. CLS. 100, 101 AND 102). SN 78-888,643. PUB. 7-31-2007. FILED 5-21-2006.
- 3,312,227. **FINDING AND FINANCING OPPORTUNITIES THAT OTHERS MISS (BLOCK FORM)**. OPPORTUNITY FINANCE CORPORATION, (U.S. CLS. 100, 101 AND 102). SN 78-888,939. PUB. 7-31-2007. FILED 5-22-2006.
- 3,312,242. **CARGURUS (BLOCK FORM)**. CARGURUS LLC, MULTIPLE CLASS, (INT. CLS. 35 AND 38), (U.S. CLS. 100, 101, 102 AND 104). SN 78-892,489. PUB. 7-31-2007. FILED 5-25-2006.
- 3,312,243. **YOUR DREAM HOME IN MEXICO (BLOCK FORM)**. BBVA BANCOMER, S.A. INSTITUCION DE BANCA MULTIPLE, GRUPO FINANCIERO BBVA BANCOMER, MULTIPLE CLASS, (INT. CLS. 35 AND 36), (U.S. CLS. 100, 101 AND 102). SN 78-892,837. PUB. 7-31-2007. FILED 5-25-2006.
- 3,312,245. **FOCUSEDMOMENTUM (STYLIZED)**. LYNCH, CECILIA M., (U.S. CLS. 100, 101 AND 102). SN 78-892,987. PUB. 7-31-2007. FILED 5-25-2006.
- 3,312,249 (*See Class 16 for this trademark*).
- 3,312,275 (*See Class 24 for this trademark*).
- 3,312,293. **FASHION WITH A PULSE (BLOCK FORM)**. HEALTHCARE UNIFORM COMPANY, INC., DBA LIFE UNIFORM, (U.S. CLS. 100, 101 AND 102). SN 78-903,147. PUB. 7-31-2007. FILED 6-7-2006.
- 3,312,294. **I2SYSTEMS ENABLED (STYLIZED)**. INTEGRATED ILLUMINATION SYSTEMS, INC., (U.S. CLS. 100, 101 AND 102). SN 78-903,476. PUB. 7-31-2007. FILED 6-8-2006.
- 3,312,296. **LINKS FOR LIFE (BLOCK FORM)**. LINKS FOR LIFE, INC., MULTIPLE CLASS, (INT. CLS. 35, 36, 41 AND 45), (U.S. CLS. 100, 101, 102 AND 107). SN 78-903,859. PUB. 7-31-2007. FILED 6-8-2006.
- 3,312,308. **FASHION ACCESSORIES SHIPPERS ASSOCIATION (BLOCK FORM)**. FASHION ACCESSORIES SHIPPERS ASSOCIATION, INC., (U.S. CLS. 100, 101 AND 102). SN 78-905,731. PUB. 7-31-2007. FILED 6-12-2006.
- 3,312,312. **GOOD CARS FOR PEOPLE WHO NEED CREDIT (BLOCK FORM)**. BYRIDER FRANCHISING, INC., MULTIPLE CLASS, (INT. CLS. 35 AND 36), (U.S. CLS. 100, 101 AND 102). SN 78-906,188. PUB. 7-31-2007. FILED 6-12-2006.
- 3,312,318. **MILK (BLOCK FORM)**. MILK STUDIOS, MULTIPLE CLASS, (INT. CLS. 35 AND 41), (U.S. CLS. 100, 101, 102 AND 107). SN 78-906,894. PUB. 7-31-2007. FILED 6-13-2006.
- 3,312,321. **EPLANS (BLOCK FORM)**. HANLEY-WOOD, LLC, (U.S. CLS. 100, 101 AND 102). SN 78-907,683. PUB. 7-31-2007. FILED 6-14-2006.
- 3,312,335. **VALUE SELECT PACKAGE (BLOCK FORM)**. MIDFIRST BANK, (U.S. CLS. 100, 101 AND 102). SN 78-910,252. PUB. 7-31-2007. FILED 6-16-2006.
- 3,312,350. **W AND DESIGN**. WORLD LOGISTICS SERVICE (U.S.A.), INC., (U.S. CLS. 100, 101 AND 102). SN 78-912,893. PUB. 7-31-2007. FILED 6-21-2006.
- 3,312,352 (*See Class 29 for this trademark*).
- 3,312,363. **ONEGOAL AND DESIGN**. INTERNATIONAL HOCKEY INDUSTRY ASSOCIATION, (U.S. CLS. 100, 101 AND 102). SN 78-915,865. PUB. 7-31-2007. FILED 6-23-2006.
- 3,312,364. **LUTÈGE AND DESIGN**. GUERRIER, LAURENT, (U.S. CLS. 100, 101 AND 102). SN 78-915,926. PUB. 7-31-2007. FILED 6-23-2006.
- 3,312,369 (*See Class 30 for this trademark*).
- 3,312,375. **MICKEY FINE PHARMACY (BLOCK FORM)**. G AND J GROSS, INC., (U.S. CLS. 100, 101 AND 102). SN 78-918,473. PUB. 7-31-2007. FILED 6-28-2006.
- 3,312,376 (*See Class 19 for this trademark*).
- 3,312,380. **CAMCLUB (BLOCK FORM)**. BARRY FRUITMAN, (U.S. CLS. 100, 101 AND 102). SN 78-918,986. PUB. 7-31-2007. FILED 6-28-2006.
- 3,312,383. **BUOYANT DUCK (BLOCK FORM)**. PLANIT ADVERTISING, INC., DBA BUOYANT DUCK, MULTIPLE CLASS, (INT. CLS. 35, 41 AND 42), (U.S. CLS. 100, 101, 102 AND 107). SN 78-919,548. PUB. 7-31-2007. FILED 6-29-2006.
- 3,312,385. **HUF (BLOCK FORM)**. HUFNAGEL, KEITH, (U.S. CLS. 100, 101 AND 102). SN 78-919,900. PUB. 2-20-2007. FILED 6-29-2006.
- 3,312,386. **JUSMEDICO (BLOCK FORM)**. BACH, JAN BJERUM, MULTIPLE CLASS, (INT. CLS. 35, 41 AND 45), (U.S. CLS. 100, 101, 102 AND 107). SN 78-919,901. PUB. 7-31-2007. FILED 6-29-2006.
- 3,312,387. **WINNERS CLUB (BLOCK FORM)**. JACOBS EN-

- TERAINMENT, INC., (U.S. CLS. 100, 101 AND 102). SN 78-919,966. PUB. 7-31-2007. FILED 6-29-2006.
- 3,312,388. **S SCREENVUE AND DESIGN**. SCREENVUE, INC., (U.S. CLS. 100, 101 AND 102). SN 78-920,033. PUB. 7-31-2007. FILED 6-29-2006.
- 3,312,401. **PURELYALPACA AND DESIGN**. BRIAN D SCHIEBER, (U.S. CLS. 100, 101 AND 102). SN 78-922,056. PUB. 7-31-2007. FILED 7-3-2006.
- 3,312,403. **BUCKEYE RESUMES (BLOCK FORM)**. WORTHINGTON CAREER SERVICES LLC, (U.S. CLS. 100, 101 AND 102). SN 78-922,445. PUB. 7-31-2007. FILED 7-5-2006.
- 3,312,405. **NURITKUM SQUARE AND DESIGN**. KOREA IT INDUSTRY PROMOTION AGENCY, MULTIPLE CLASS, (INT. CLS. 35 AND 36), (U.S. CLS. 100, 101 AND 102). SN 78-922,659. PUB. 7-31-2007. FILED 7-5-2006.
- 3,312,414 (*See Class 16 for this trademark*).
- 3,312,415. **UNIVERSAL GAS & ELECTRIC (BLOCK FORM)**. UNIVERSAL ENERGY CORPORATION, MULTIPLE CLASS, (INT. CLS. 35 AND 36), (U.S. CLS. 100, 101 AND 102). SN 78-923,451. PUB. 7-31-2007. FILED 7-6-2006.
- 3,312,418. **COME HOME TO FRANKLIN COUNTY (BLOCK FORM)**. HAMPTON STATE BANK, (U.S. CLS. 100, 101 AND 102). SN 78-923,925. PUB. 7-31-2007. FILED 7-6-2006.
- 3,312,422. **LIVERNOIS MOTORSPORTS (BLOCK FORM)**. LIVERNOIS MOTOR SPORTS, LLC, MULTIPLE CLASS, (INT. CLS. 35 AND 37), (U.S. CLS. 100, 101, 102, 103 AND 106). SN 78-924,416. PUB. 7-31-2007. FILED 7-7-2006.
- 3,312,432. **SALEAMP (BLOCK FORM)**. PAUL KIRCHOFF, (U.S. CLS. 100, 101 AND 102). SN 78-926,358. PUB. 7-31-2007. FILED 7-11-2006.
- 3,312,433. **YOUR MARKETING DEPARTMENT HAS ARRIVED (BLOCK FORM)**. PAUL KIRCHOFF, (U.S. CLS. 100, 101 AND 102). SN 78-926,359. PUB. 7-31-2007. FILED 7-11-2006.
- 3,312,442. **WE TALK BACK! (BLOCK FORM)**. PHONE DIRECTORIES COMPANY, LP, (U.S. CLS. 100, 101 AND 102). SN 78-927,536. PUB. 7-31-2007. FILED 7-12-2006.
- 3,312,443. **COMMUNITY FOOTPRINTS (BLOCK FORM)**. THE RITZ-CARLTON HOTEL COMPANY, L.L.C., (U.S. CLS. 100, 101 AND 102). SN 78-927,616. PUB. 7-31-2007. FILED 7-12-2006.
- 3,312,445. **AT NEWTEK, WE DO IT BETTER. (BLOCK FORM)**. NEWTEK BUSINESS SERVICES, INC., MULTIPLE CLASS, (INT. CLS. 35, 36, 38 AND 42), (U.S. CLS. 100, 101, 102 AND 104). SN 78-927,895. PUB. 7-31-2007. FILED 7-12-2006.
- 3,312,446. **WE'RE MAKING A DIFFERENCE (BLOCK FORM)**. EBS HEALTHCARE, INC., MULTIPLE CLASS, (INT. CLS. 35 AND 41), (U.S. CLS. 100, 101, 102 AND 107). SN 78-927,923. PUB. 7-31-2007. FILED 7-12-2006.
- 3,312,450. **CCE (BLOCK FORM)**. CERTIFIED ASSET EXCHANGE, INC., MULTIPLE CLASS, (INT. CLS. 35 AND 36), (U.S. CLS. 100, 101 AND 102). SN 78-928,398. PUB. 7-31-2007. FILED 7-12-2006.
- 3,312,451. **EPLANS.COM (BLOCK FORM)**. HANLEY-WOOD, LLC, (U.S. CLS. 100, 101 AND 102). SN 78-928,453. PUB. 7-31-2007. FILED 7-13-2006.
- 3,312,453 (*See Class 16 for this trademark*).
- 3,312,468 (*See Class 16 for this trademark*).
- 3,312,477. **HITTAIL (BLOCK FORM)**. CKC COMMUNICATIONS, INCORPORATED, MULTIPLE CLASS, (INT. CLS. 35 AND 42), (U.S. CLS. 100, 101 AND 102). SN 78-931,580. PUB. 7-31-2007. FILED 7-18-2006.
- 3,312,483. **ULTIMATE SWIMMING POOLS (BLOCK FORM)**. ALLIANCE TRADING, INC., (U.S. CLS. 100, 101 AND 102). SN 78-932,250. PUB. 7-31-2007. FILED 7-18-2006.
- 3,312,488. **MISCELLANEOUS DESIGN**. ONEPIN, INC., (U.S. CLS. 100, 101 AND 102). SN 78-933,149. PUB. 7-31-2007. FILED 7-19-2006.
- 3,312,504. **BECAUSE LIFE SHOULDN'T HURT (BLOCK FORM)**. THE CHRONIC PAIN STORE, LLC, (U.S. CLS. 100, 101 AND 102). SN 78-936,155. PUB. 7-31-2007. FILED 7-24-2006.
- 3,312,506 (*See Class 16 for this trademark*).
- 3,312,535. **E AND DESIGN**. ZELBY, LLC, MULTIPLE CLASS, (INT. CLS. 35 AND 42), (U.S. CLS. 100, 101 AND 102). SN 78-942,289. PUB. 7-31-2007. FILED 8-1-2006.
- 3,312,543. **KIDLINK NETWORK AND DESIGN**. UHS OF DELAWARE, INC., (U.S. CLS. 100, 101 AND 102). SN 78-943,795. PUB. 7-31-2007. FILED 8-3-2006.
- 3,312,545. **T2 SUPPLY (BLOCK FORM)**. SCANSOURCE, INC., (U.S. CLS. 100, 101 AND 102). SN 78-943,948. PUB. 7-31-2007. FILED 8-3-2006.
- 3,312,546. **T2SUPPLY AND DESIGN**. SCANSOURCE, INC., (U.S. CLS. 100, 101 AND 102). SN 78-943,958. PUB. 7-31-2007. FILED 8-3-2006.
- 3,312,555. **PHH COLLISION PREVENTION (BLOCK FORM)**. PHH VEHICLE MANAGEMENT SERVICES, LLC, (U.S. CLS. 100, 101 AND 102). SN 78-946,746. PUB. 7-31-2007. FILED 8-7-2006.
- 3,312,559. **ON THE GO SOLUTIONS (BLOCK FORM)**. ON THE GO SOLUTIONS, INC., (U.S. CLS. 100, 101 AND 102). SN 78-948,164. PUB. 4-24-2007. FILED 8-9-2006.
- 3,312,563. **WORLD SHIPPING COUNCIL PARTNERS IN TRADE AND DESIGN**. WORLD SHIPPING COUNCIL, (U.S. CLS. 100, 101 AND 102). SN 78-949,115. PUB. 7-31-2007. FILED 8-10-2006.
- 3,312,569. **CASE SHILLER INDEXES (BLOCK FORM)**. FISERV, INC., (U.S. CLS. 100, 101 AND 102). SN 78-950,361. PUB. 7-31-2007. FILED 8-11-2006.
- 3,312,575. **ENROLLMED (BLOCK FORM)**. C/HCA, INC., (U.S. CLS. 100, 101 AND 102). SN 78-951,337. PUB. 7-31-2007. FILED 8-14-2006.
- 3,312,580. **HANDS ON ATLANTA (BLOCK FORM)**. HANDS ON ATLANTA, INC., (U.S. CLS. 100, 101 AND 102). SN 78-952,585. PUB. 7-31-2007. FILED 8-15-2006.
- 3,312,587. **HEALTHY START PACKAGE (BLOCK FORM)**. PANNELL KERR FORSTER OF TEXAS, P.C., (U.S. CLS. 100, 101 AND 102). SN 78-955,739. PUB. 7-31-2007. FILED 8-18-2006.
- 3,312,588. **CSI AND DESIGN**. CODING SOLUTIONS, INC., MULTIPLE CLASS, (INT. CLS. 35 AND 40), (U.S. CLS. 100, 101, 102, 103 AND 106). SN 78-956,241. PUB. 4-10-2007. FILED 8-21-2006.
- 3,312,589. **PERFORMX (BLOCK FORM)**. PEOPLENET COMMUNICATIONS CORPORATION, (U.S. CLS. 100, 101 AND 102). SN 78-956,390. PUB. 7-31-2007. FILED 8-23-2006.
- 3,312,602. **AUTOPILOT MEDIA (BLOCK FORM)**. AUTOPILOT FRANCHISE SYSTEMS, (U.S. CLS. 100, 101 AND 102). SN 78-958,638. PUB. 7-31-2007. FILED 8-23-2006.
- 3,312,607. **HDTRADER (BLOCK FORM)**. MARCO POLO PUBLICATIONS, INC., (U.S. CLS. 100, 101 AND 102). SN 78-959,780. PUB. 4-24-2007. FILED 8-24-2006.
- 3,312,608. **THE BRAND BEHIND THE BRAND (BLOCK FORM)**. MA CHER (USA), INC., (U.S. CLS. 100, 101 AND 102). SN 78-960,011. PUB. 7-31-2007. FILED 8-24-2006.
- 3,312,609. **RADIUS ADVERTISING (BLOCK FORM)**. RADIUS ADVERTISING, (U.S. CLS. 100, 101 AND 102). SN 78-960,095. PUB. 7-31-2007. FILED 8-24-2006.
- 3,312,614. **HOBBS NEW MEXICO IT ALL HAPPENS HERE AND DESIGN**. CITY OF HOBBS, NEW MEXICO, (U.S. CLS. 100, 101 AND 102). SN 78-960,762. PUB. 7-31-2007. FILED 8-25-2006.
- 3,312,622. **AMERICAN LUMBER STANDARD COMMITTEE, INCORPORATED (BLOCK FORM)**. AMERICAN LUMBER STANDARD COMMITTEE, INCORPORATED, MULTIPLE CLASS, (INT. CLS. 35 AND 42), (U.S. CLS. 100, 101 AND 102). SN 78-961,688. PUB. 7-31-2007. FILED 8-28-2006.
- 3,312,626. **ECKMAN & DANOVITZ AND DESIGN**. ECKMAN & DANOVITZ, MULTIPLE CLASS, (INT. CLS. 35 AND 45), (U.S. CLS. 100, 101 AND 102). SN 78-961,809. PUB. 7-31-2007. FILED 8-28-2006.
- 3,312,632 (*See Class 4 for this trademark*).
- 3,312,647. **BIZCOM HEALTHCARE SOLUTIONS (BLOCK FORM)**. BIZCOM HEALTHCARE SOLUTIONS, INC., MULTIPLE CLASS, (INT. CLS. 35 AND 45), (U.S. CLS. 100, 101 AND 102). SN 78-965,225. PUB. 7-31-2007. FILED 8-31-2006.
- 3,312,649. **MISCELLANEOUS DESIGN**. AUTUMN ENTERPRISES, INC., (U.S. CLS. 100, 101 AND 102). SN 78-965,485. PUB. 4-17-2007. FILED 8-31-2006.
- 3,312,650 (*See Class 9 for this trademark*).
- 3,312,662. **NGI (BLOCK FORM)**. INTELLIGENCE PRESS INC., MULTIPLE CLASS, (INT. CLS. 35 AND 39), (U.S. CLS. 100, 101, 102 AND 105). SN 78-969,147. PUB. 7-31-2007. FILED 9-7-2006.

- 3,312,672. **AUTHENTICALLY COLORADO (BLOCK FORM)**. TOWN OF NEW CASTLE, (U.S. CLS. 100, 101 AND 102). SN 78-970,762. PUB. 7-31-2007. FILED 9-9-2006.
- 3,312,675. **ENERGY PULSE AND DESIGN**. THE SHELTON COMMUNICATIONS GROUP, INC. (U.S. CLS. 100, 101 AND 102). SN 78-971,420. PUB. 7-31-2007. FILED 9-11-2006.
- 3,312,689. **ABSOLUTE AMUSEMENTS (BLOCK FORM)**. EVENT MALL, INC., MULTIPLE CLASS, (INT. CLS. 35, 37 AND 41), (U.S. CLS. 100, 101, 102, 103, 106 AND 107). SN 78-978,034. PUB. 4-24-2007. FILED 7-14-2004.
- 3,312,713 (*See Class 16 for this trademark*).
- 3,312,733 (*See Class 9 for this trademark*).
- 3,312,735 (*See Class 9 for this trademark*).
- 3,312,746 (*See Class 9 for this trademark*).
- 3,312,758 (*See Class 9 for this trademark*).
- 3,312,763 (*See Class 16 for this trademark*).
- 3,312,772 (*See Class 14 for this trademark*).
- 3,312,778. **COMPOSITION (BLOCK FORM)**. COMPOSITION CAPITAL PARTNERS B.V., MULTIPLE CLASS, (INT. CLS. 35 AND 36), (U.S. CLS. 100, 101 AND 102). SN 79-024,631. PUB. 7-31-2007. FILED 2-16-2006.
- 3,312,794 (*See Class 9 for this trademark*).
- 3,312,798. **51 STATE LT AND DESIGN**. UAB "CAUSA FORMALIS", (U.S. CLS. 100, 101 AND 102). SN 79-026,133. PUB. 7-31-2007. FILED 3-17-2006.
- 3,312,830 (*See Class 9 for this trademark*).
- 3,312,850 (*See Class 9 for this trademark*).
- 3,312,876 (*See Class 3 for this trademark*).
- 3,312,896 (*See Class 29 for this trademark*).
- 3,312,908. **JOB BOUNTY HUNTER (BLOCK FORM)**. FLAT RATE RECRUITMENT PTY LTD, (U.S. CLS. 100, 101 AND 102). SN 79-030,578. PUB. 7-31-2007. FILED 9-11-2006.
- 3,312,919 (*See Class 25 for this trademark*).
- 3,312,929. **MISCELLANEOUS DESIGN**. MOSSY ENTERPRISES PTY LTD (ACN: 084441109), MULTIPLE CLASS, (INT. CLS. 35 AND 44), (U.S. CLS. 100, 101 AND 102). SN 79-031,997. PUB. 7-31-2007. FILED 2-14-2006.
- 3,312,936 (*See Class 9 for this trademark*).
- 3,312,937. **MISCELLANEOUS DESIGN**. MEINL BANK AKTIENGESELLSCHAFT, MULTIPLE CLASS, (INT. CLS. 35 AND 36), (U.S. CLS. 100, 101 AND 102). SN 79-032,695. PUB. 7-31-2007. FILED 9-25-2006.
- 3,312,948 (*See Class 9 for this trademark*).
- 3,310,433. **BLACKBURN CAPITAL (BLOCK FORM)**. BLACKBURN CAPITAL LLC, (U.S. CLS. 100, 101 AND 102). SN 77-001,331. PUB. 7-31-2007. FILED 9-18-2006.
- 3,310,435. **MISCELLANEOUS DESIGN**. HOUSING PARTNERSHIP INC., THE, MULTIPLE CLASS, (INT. CLS. 36 AND 41), (U.S. CLS. 100, 101, 102 AND 107). SN 77-001,961. PUB. 7-31-2007. FILED 9-19-2006.
- 3,310,436. **THE HOUSING PARTNERSHIP INC. AND DESIGN**. THE HOUSING PARTNERSHIP INC., MULTIPLE CLASS, (INT. CLS. 36 AND 41), (U.S. CLS. 100, 101, 102 AND 107). SN 77-001,973. PUB. 7-31-2007. FILED 9-19-2006.
- 3,310,445. **COLLEGE GRAD SWEEPS (BLOCK FORM)**. AFFINITY DIRECT, LLC, (U.S. CLS. 100, 101 AND 102). SN 77-004,078. PUB. 7-31-2007. FILED 9-21-2006.
- 3,310,446. **EWORLD REAL ESTATE (BLOCK FORM)**. HERMANDEZ, RICARDO, DBA EWORLD REAL ESTATE, (U.S. CLS. 100, 101 AND 102). SN 77-004,132. PUB. 7-31-2007. FILED 9-21-2006.
- 3,310,465. **THE EDGE SIGNATURE LOAN (BLOCK FORM)**. RENT-A-CENTER WEST, INC., (U.S. CLS. 100, 101 AND 102). SN 77-007,751. PUB. 7-31-2007. FILED 9-26-2006.
- 3,310,484. **SHOP&RAISE (STYLIZED)**. MOMS-FOR-PROFIT, LLC, (U.S. CLS. 100, 101 AND 102). SN 77-011,176. PUB. 7-31-2007. FILED 9-30-2006.
- 3,310,500. **PEOPLE INC WHERE YOUR WORLD OPENS UP. AND DESIGN**. PEOPLE INC., MULTIPLE CLASS, (INT. CLS. 36, 41, 44 AND 45), (U.S. CLS. 100, 101, 102 AND 107). SN 77-013,205. PUB. 7-31-2007. FILED 10-4-2006.
- 3,310,506 (*See Class 35 for this trademark*).
- 3,310,513. **CREATING CAPITAL LIFESTYLES (BLOCK FORM)**. CARROLL, JOHN, SAMUEL, (U.S. CLS. 100, 101 AND 102). SN 77-015,509. PUB. 7-31-2007. FILED 10-6-2006.
- 3,310,519. **LET YOUR HEART MOVE YOUR FEET (BLOCK FORM)**. THE ANDREA RIZZO FOUNDATION, (U.S. CLS. 100, 101 AND 102). SN 77-016,505. PUB. 7-31-2007. FILED 10-8-2006.
- 3,310,535. **FOR THE LOVE OF CHOCOLATE (BLOCK FORM)**. THE FRENCH PASTRY SCHOOL LLC, (U.S. CLS. 100, 101 AND 102). SN 77-018,191. PUB. 7-31-2007. FILED 10-10-2006.
- 3,310,538 (*See Class 35 for this trademark*).
- 3,310,561. **HMONG 500 500 CHURCH PLANTERS 5 YEARS 1 GOD AND DESIGN**. WORLDSERVE MINISTRIES, (U.S. CLS. 100, 101 AND 102). SN 77-023,051. PUB. 7-31-2007. FILED 10-17-2006.
- 3,310,563. **HUNTINGTON FOR SCHOOLS (BLOCK FORM)**. HUNTINGTON BANCSHARES INCORPORATED, MULTIPLE CLASS, (INT. CLS. 36 AND 42), (U.S. CLS. 100, 101 AND 102). SN 77-023,454. PUB. 7-31-2007. FILED 10-18-2006.
- 3,310,571. **HONORING THE PAST PROTECTING THE FUTURE (BLOCK FORM)**. THE SAVINGS BANK LIFE INSURANCE COMPANY OF MASSACHUSETTS, (U.S. CLS. 100, 101 AND 102). SN 77-024,557. PUB. 7-31-2007. FILED 10-19-2006.
- 3,310,586. **TURNBERRY TOWER (BLOCK FORM)**. TRUST NUMBER SR-1, MULTIPLE CLASS, (INT. CLS. 36 AND 37), (U.S. CLS. 100, 101, 102, 103 AND 106). SN 77-027,135. PUB. 7-31-2007. FILED 10-23-2006.
- 3,310,595. **V VANTAGE BUSINESS SUPPORT & INSURANCE SERVICES AND DESIGN**. VANTAGE BUSINESS SUPPORT & INSURANCE SERVICES, (U.S. CLS. 100, 101 AND 102). SN 77-028,554. PUB. 7-31-2007. FILED 10-24-2006.
- 3,310,608. **NATIONAIR (BLOCK FORM)**. NATIONAIR INSURANCE AGENCIES, INC., (U.S. CLS. 100, 101 AND 102). SN 77-031,036. PUB. 7-31-2007. FILED 10-27-2006.
- 3,310,636. **A AQUARIUS FUND DISTRIBUTORS, LLC (STYLIZED)**. AQUARIUS FUND DISTRIBUTORS, LLC, (U.S. CLS. 100, 101 AND 102). SN 77-037,399. PUB. 7-31-2007. FILED 11-6-2006.
- 3,310,655. **NEWHOME WARRANTY MANAGEMENT AND DESIGN**. NEWHOME WARRANTY MANAGEMENT, INC., (U.S. CLS. 100, 101 AND 102). SN 77-039,710. PUB. 7-31-2007. FILED 11-8-2006.
- 3,310,682. **MOGUL MORTGAGE, LLC BUMP-FREE FINANCING AND DESIGN**. MOGUL MORTGAGE, LLC, (U.S. CLS. 100, 101 AND 102). SN 77-045,370. PUB. 7-31-2007. FILED 11-16-2006.
- 3,310,714. **MAGIS IN CONSTANT PURSUIT OF BEING**

- BETTER AND DOING MORE AND DESIGN.** MAGIS GROUP, INC., (U.S. CLS. 100, 101 AND 102). SN 77-049,561. PUB. 7-31-2007. FILED 11-22-2006.
- 3,310,735 (*See Class 35 for this trademark.*).
- 3,310,767. **WEF BROKERAGE SPECIALISTS, LLC (BLOCK FORM).** WEF BROKERAGE SPECIALISTS, LLC, (U.S. CLS. 100, 101 AND 102). SN 77-056,598. PUB. 7-31-2007. FILED 12-4-2006.
- 3,310,774. **CRU TRADING COMPANY AND DESIGN.** CRU TRADING COMPANY, (U.S. CLS. 100, 101 AND 102). SN 77-058,179. PUB. 7-31-2007. FILED 12-6-2006.
- 3,310,775. **OMNI INSURANCE GROUP AND DESIGN.** OMNI INSURANCE GROUP, (U.S. CLS. 100, 101 AND 102). SN 77-058,465. PUB. 7-31-2007. FILED 12-6-2006.
- 3,310,828. **HOMES LAND & COMMERCIAL REALTY GROUP AND DESIGN.** MANASOTA RESIDENTIAL REAL ESTATE INC., (U.S. CLS. 100, 101 AND 102). SN 77-064,862. PUB. 7-31-2007. FILED S.R. 12-14-2006; AM. P.R. 5-9-2007.
- 3,310,830. **IMH (BLOCK FORM).** INVESTORS MORTGAGE HOLDINGS INC., (U.S. CLS. 100, 101 AND 102). SN 77-065,026. PUB. 7-31-2007. FILED 12-15-2006.
- 3,310,881. **WINE FOR EQUALITY (BLOCK FORM).** O'BRIEN FAMILY VINEYARD LLC, (U.S. CLS. 100, 101 AND 102). SN 77-068,399. PUB. 7-31-2007. FILED 12-20-2006.
- 3,310,882. **YIELD PLEDGE (BLOCK FORM).** EVERBANK, (U.S. CLS. 100, 101 AND 102). SN 77-068,402. PUB. 7-31-2007. FILED 12-20-2006.
- 3,310,887. **MARRERO WEALTH (BLOCK FORM).** MARRERO WEALTH MANAGEMENT, LLC, (U.S. CLS. 100, 101 AND 102). SN 77-068,449. PUB. 7-31-2007. FILED 12-20-2006.
- 3,310,889. **M MARRERO WEALTH EST. 1988 AND DESIGN.** MARRERO WEALTH MANAGEMENT, LLC, (U.S. CLS. 100, 101 AND 102). SN 77-068,469. PUB. 7-31-2007. FILED 12-20-2006.
- 3,310,949. **CRYSTAL PEAK LODGE (BLOCK FORM).** VAIL TRADEMARKS, INC., (U.S. CLS. 100, 101 AND 102). SN 77-070,868. PUB. 7-31-2007. FILED 12-22-2006.
- 3,310,951. **PF AND DESIGN.** PLAN LIFE & WEALTH MANAGEMENT, INC., (U.S. CLS. 100, 101 AND 102). SN 77-070,887. PUB. 7-31-2007. FILED 12-22-2006.
- 3,310,976. **I DECIDE TO FIGHT DIABETES (BLOCK FORM).** AMERICAN DIABETES ASSOCIATION, INC., (U.S. CLS. 100, 101 AND 102). SN 77-071,766. PUB. 7-31-2007. FILED 12-27-2006.
- 3,310,987. **MISCELLANEOUS DESIGN.** RISKDOCTOR, INC., (U.S. CLS. 100, 101 AND 102). SN 77-072,054. PUB. 7-31-2007. FILED 12-27-2006.
- 3,310,993. **MISCELLANEOUS DESIGN.** DBSI, INC., MULTIPLE CLASS, (INT. CLS. 36 AND 37), (U.S. CLS. 100, 101, 102, 103 AND 106). SN 77-072,128. PUB. 7-31-2007. FILED 12-27-2006.
- 3,311,015. **POWER 5/5 (BLOCK FORM).** JACKSON CAPITAL MARKETS, (U.S. CLS. 100, 101 AND 102). SN 77-072,495. PUB. 7-31-2007. FILED 12-28-2006.
- 3,311,018. **VALUE CREATION IS OUR OCCUPATION (BLOCK FORM).** PROGRESSIVE GROWTH CORP., (U.S. CLS. 100, 101 AND 102). SN 77-072,511. PUB. 7-31-2007. FILED 12-28-2006.
- 3,311,021. **PAYMINE (BLOCK FORM).** PAYMINE INC., (U.S. CLS. 100, 101 AND 102). SN 77-072,554. PUB. 7-31-2007. FILED 12-28-2006.
- 3,311,025. **ARA (STYLIZED).** APARTMENT REALTY ADVISORS, INC., (U.S. CLS. 100, 101 AND 102). SN 77-072,664. PUB. 7-31-2007. FILED 12-28-2006.
- 3,311,050. **BANKING ON THE CURE (BLOCK FORM).** DIABETES RESEARCH INSTITUTE FOUNDATION, INC., (U.S. CLS. 100, 101 AND 102). SN 77-073,347. PUB. 7-31-2007. FILED 12-29-2006.
- 3,311,052. **TYING HOPE TO THE CURE (BLOCK FORM).** DIABETES RESEARCH INSTITUTE FOUNDATION, INC., (U.S. CLS. 100, 101 AND 102). SN 77-073,360. PUB. 7-31-2007. FILED 12-29-2006.
- 3,311,056. **FALL INTO FASHION (BLOCK FORM).** DIABETES RESEARCH INSTITUTE FOUNDATION, INC., (U.S. CLS. 100, 101 AND 102). SN 77-073,371. PUB. 7-31-2007. FILED 12-29-2006.
- 3,311,058. **PLEASURES OF THE PALATE (BLOCK FORM).** DIABETES RESEARCH INSTITUTE FOUNDATION, INC., (U.S. CLS. 100, 101 AND 102). SN 77-073,384. PUB. 7-31-2007. FILED 12-29-2006.
- 3,311,069. **HELPING CONTRACTORS MASTER MONEY (BLOCK FORM).** DRUML GROUP, INC., (U.S. CLS. 100, 101 AND 102). SN 77-073,711. PUB. 7-31-2007. FILED 12-29-2006.
- 3,311,074. **MORTGAGES THAT MATTER (BLOCK FORM).** JCF ADVISORS, LLC, (U.S. CLS. 100, 101 AND 102). SN 77-073,851. PUB. 7-31-2007. FILED 12-30-2006.
- 3,311,087 (*See Class 35 for this trademark.*).
- 3,311,122. **STERLING HEALTH PLANS. REAL PEOPLE. WISE CHOICES. (BLOCK FORM).** STERLING LIFE INSURANCE COMPANY, (U.S. CLS. 100, 101 AND 102). SN 77-075,509. PUB. 7-31-2007. FILED 1-3-2007.
- 3,311,123. **STERLING HEALTH PLANS. REAL PEOPLE. WISE CHOICES. UNDERWRITTEN BY STERLING LIFE INSURANCE COMPANY (BLOCK FORM).** STERLING LIFE INSURANCE COMPANY, (U.S. CLS. 100, 101 AND 102). SN 77-075,528. PUB. 7-31-2007. FILED 1-3-2007.
- 3,311,126 (*See Class 9 for this trademark.*).
- 3,311,133. **FIRSTACRE (BLOCK FORM).** FIRSTACRE REALTY, LLC, (U.S. CLS. 100, 101 AND 102). SN 77-076,454. PUB. 7-31-2007. FILED 1-4-2007.
- 3,311,185. **WE HELP BUSINESSES STAY IN BUSINESS (STYLIZED).** FINANCIAL CONSULTING & MANAGEMENT, INC., (U.S. CLS. 100, 101 AND 102). SN 77-081,762. PUB. 7-31-2007. FILED 1-12-2007.
- 3,311,202. **APPRAISER QUEST (BLOCK FORM).** DISCOVER APPRAISERS.COM, (U.S. CLS. 100, 101 AND 102). SN 77-083,290. PUB. 7-31-2007. FILED 1-15-2007.
- 3,311,214. **FASHION FOR EVERY BODY (BLOCK FORM).** EATING DISORDERS COALITION OF TENNESSEE, INC., MULTIPLE CLASS, (INT. CLS. 36 AND 41), (U.S. CLS. 100, 101, 102 AND 107). SN 77-084,674. PUB. 7-31-2007. FILED 1-17-2007.
- 3,311,220. **YOUR PATHWAY TO SUCCESS (BLOCK FORM).** ACADEMIC FUNDING FOUNDATION, (U.S. CLS. 100, 101 AND 102). SN 77-085,422. PUB. 7-31-2007. FILED 1-18-2007.
- 3,311,221. **MISCELLANEOUS DESIGN.** ACADEMIC FUNDING FOUNDATION, (U.S. CLS. 100, 101 AND 102). SN 77-085,428. PUB. 7-31-2007. FILED 1-18-2007.
- 3,311,232. **MUSIC FOR MANKIND (BLOCK FORM).** CEOL PRODUCTIONS, (U.S. CLS. 100, 101 AND 102). SN 77-085,725. PUB. 7-31-2007. FILED S.R. 1-18-2007; AM. P.R. 5-10-2007.
- 3,311,236. **CHOOSE WHAT FITS (BLOCK FORM).** MASSACHUSETTS FINANCIAL SERVICES COMPANY, (U.S. CLS. 100, 101 AND 102). SN 77-085,939. PUB. 7-31-2007. FILED 1-18-2007.
- 3,311,251. **PRIME COMMISSION (BLOCK FORM).** TERME BANCORP, INC., (U.S. CLS. 100, 101 AND 102). SN 77-087,022. PUB. 7-31-2007. FILED 1-19-2007.
- 3,311,259. **UN TECHO PARA MI PAIS AND DESIGN.** UN TECHO PARA MI PAIS, (U.S. CLS. 100, 101 AND 102). SN 77-088,094. PUB. 7-31-2007. FILED 1-22-2007.
- 3,311,273. **IMH AND DESIGN.** INVESTORS MORTGAGE HOLDINGS INC., (U.S. CLS. 100, 101 AND 102). SN 77-089,359. PUB. 7-31-2007. FILED 1-23-2007.
- 3,311,288. **"LIFE IS NOT PERFECT, BUT YOUR MORTGAGE SHOULD BE" (BLOCK FORM).** PERFECT MORTGAGE LLC., (U.S. CLS. 100, 101 AND 102). SN 77-090,290. PUB. 7-31-2007. FILED 1-24-2007.
- 3,311,316. **LIVE WITH A SUPERIORITY COMPLEX (BLOCK FORM).** RICHDALE MANAGEMENT, INC., (U.S. CLS. 100, 101 AND 102). SN 77-093,216. PUB. 7-31-2007. FILED 1-29-2007.
- 3,311,320. **BENEFITS4LIFE (BLOCK FORM).** CHILDREN'S LEGAL SERVICES, PLLC, (U.S. CLS. 100, 101 AND 102). SN 77-093,437. PUB. 7-31-2007. FILED 1-29-2007.
- 3,311,349. **THE NEW COST OF A TRANSACTION. (BLOCK FORM).** RT BROKERAGE SERVICES, INC., (U.S. CLS. 100, 101 AND 102). SN 77-095,706. PUB. 7-31-2007. FILED 1-31-2007.
- 3,311,355. **WELTON (BLOCK FORM).** WELTON INVESTMENT CORPORATION, (U.S. CLS. 100, 101 AND 102). SN 77-096,237. PUB. 7-31-2007. FILED 1-31-2007.
- 3,311,371. **NVEXPRESS CREDIT BANK AND DESIGN.** NVE

- BANK, (U.S. CLS. 100, 101 AND 102). SN 77-097,025. PUB. 7-31-2007. FILED 2-1-2007.
- 3,311,372. **PENSIONS MADE EASY (BLOCK FORM)**. DYNAMIC PENSION SERVICES, INC., (U.S. CLS. 100, 101 AND 102). SN 77-097,100. PUB. 7-31-2007. FILED 2-1-2007.
- 3,311,373. **GETTING IT DONE (BLOCK FORM)**. CAPITAL PACIFIC BANK, (U.S. CLS. 100, 101 AND 102). SN 77-097,143. PUB. 7-31-2007. FILED 2-1-2007.
- 3,311,382. **DENALI VISION (BLOCK FORM)**. DIRECT BENEFITS, INC., (U.S. CLS. 100, 101 AND 102). SN 77-097,674. PUB. 7-31-2007. FILED 2-2-2007.
- 3,311,397. **CLEAR DEBT SOLUTION (BLOCK FORM)**. CAPSAW, INC., (U.S. CLS. 100, 101 AND 102). SN 77-098,226. PUB. 7-31-2007. FILED 2-2-2007.
- 3,311,401. **TRIBUTE (BLOCK FORM)**. THE DOCTORS COMPANY, (U.S. CLS. 100, 101 AND 102). SN 77-098,276. PUB. 7-31-2007. FILED 2-2-2007.
- 3,311,403. **SFG A LEGACY OF TRUST AND INNOVATION AND DESIGN**. SCHULTZ FINANCIAL GROUP INCORPORATED, (U.S. CLS. 100, 101 AND 102). SN 77-098,368. PUB. 7-31-2007. FILED 2-2-2007.
- 3,311,411. **MAKING CENTS OF ONLINE GIVING (BLOCK FORM)**. CHANGE ROUND-UP, INC., (U.S. CLS. 100, 101 AND 102). SN 77-098,641. PUB. 7-31-2007. FILED 2-3-2007.
- 3,311,426. **NRDE (BLOCK FORM)**. RENTBUREAU, LLC, (U.S. CLS. 100, 101 AND 102). SN 77-099,010. PUB. 7-31-2007. FILED 2-5-2007.
- 3,311,432. **IT'S TIME TO LIVE! (BLOCK FORM)**. ATURA PROPERTIES LLC, (U.S. CLS. 100, 101 AND 102). SN 77-099,276. PUB. 7-31-2007. FILED 2-5-2007.
- 3,311,436 (*See Class 16 for this trademark*).
- 3,311,445. **CLICK-IT FORWARD (BLOCK FORM)**. CITICASTERS CO., (U.S. CLS. 100, 101 AND 102). SN 77-099,642. PUB. 7-31-2007. FILED 2-5-2007.
- 3,311,457 (*See Class 35 for this trademark*).
- 3,311,458. **OSUGIVING.COM (BLOCK FORM)**. OKLAHOMA STATE UNIVERSITY FOUNDATION, (U.S. CLS. 100, 101 AND 102). SN 77-100,598. PUB. 7-31-2007. FILED 2-6-2007.
- 3,311,483. **IMPERIAL FINANCE & TRADING (BLOCK FORM)**. IMPERIAL FINANCE & TRADING, LLC, (U.S. CLS. 100, 101 AND 102). SN 77-102,502. PUB. 7-31-2007. FILED 2-8-2007.
- 3,311,502. **AMBASSADORS OF CARING (BLOCK FORM)**. EQUITABLE LIFE & CASUALTY INSURANCE COMPANY, (U.S. CLS. 100, 101 AND 102). SN 77-105,592. PUB. 7-31-2007. FILED 2-12-2007.
- 3,311,540. **MERCER HEALTHONLINE (BLOCK FORM)**. MERCER HUMAN RESOURCE CONSULTING, INC., MULTIPLE CLASS, (INT. CLS. 36 AND 42), (U.S. CLS. 100, 101 AND 102). SN 77-115,767. PUB. 7-31-2007. FILED 2-26-2007.
- 3,311,552. **YOUR PREMIER TEAM (BLOCK FORM)**. KRISTI C. ANDERSON, PC, (U.S. CLS. 100, 101 AND 102). SN 77-117,939. PUB. 7-31-2007. FILED 2-28-2007.
- 3,311,556. **SIGN 'N DRIVE (BLOCK FORM)**. TOYOTA MOTOR CREDIT CORPORATION, (U.S. CLS. 100, 101 AND 102). SN 77-119,782. PUB. 7-31-2007. FILED 3-1-2007.
- 3,311,559 (*See Class 16 for this trademark*).
- 3,311,560 (*See Class 35 for this trademark*).
- 3,311,562. **SUNTRUST INVESTMENT EVALUATION PROCESS (BLOCK FORM)**. SUNTRUST BANKS, INC., (U.S. CLS. 100, 101 AND 102). SN 77-122,924. PUB. 7-31-2007. FILED 3-6-2007.
- 3,311,587. **FREE YOURSELF (BLOCK FORM)**. COMMERCEBANK, N.A., (U.S. CLS. 100, 101 AND 102). SN 77-129,848. PUB. 7-31-2007. FILED 3-13-2007.
- 3,311,592. **FREE YOURSELF (STYLIZED)**. COMMERCEBANK, N.A., (U.S. CLS. 100, 101 AND 102). SN 77-131,779. PUB. 7-31-2007. FILED 3-15-2007.
- 3,311,596. **GUARANTEED INCOME ADVANTAGE (BLOCK FORM)**. NORTH AMERICAN COMPANY FOR LIFE AND HEALTH INSURANCE, (U.S. CLS. 100, 101 AND 102). SN 77-133,211. PUB. 7-31-2007. FILED 3-16-2007.
- 3,311,605. **AIG UNITED GUARANTY'S LOT LOAN POLICY (BLOCK FORM)**. AMERICAN INTERNATIONAL GROUP, INC., (U.S. CLS. 100, 101 AND 102). SN 77-145,101. PUB. 7-31-2007. FILED 3-30-2007.
- 3,311,666 (*See Class 9 for this trademark*).
- 3,311,703. **FIRSTFEDONLINE (BLOCK FORM)**. FIRSTFED FINANCIAL CORPORATION, (U.S. CLS. 100, 101 AND 102). SN 78-590,898. PUB. 7-31-2007. FILED 3-18-2005.
- 3,311,712. **MAGNUM CASH ADVANCE YOUR MULTI-PAYMENT PAYDAY LENDER AND DESIGN**. MAGNUM CASH ADVANCE, INCORPORATED, (U.S. CLS. 100, 101 AND 102). SN 78-611,688. PUB. 8-29-2006. FILED 4-19-2005.
- 3,311,728. **MICHIGAN CONSTRUCTION INDUSTRY MUTUAL (BLOCK FORM)**. MICHIGAN CONSTRUCTION INDUSTRY MUTUAL INSURANCE COMPANY, (U.S. CLS. 100, 101 AND 102). SN 78-649,908. PUB. 7-31-2007. FILED 6-14-2005.
- 3,311,743. **YBR AND DESIGN**. YOUR-BEST-RATE FINANCIAL, LLC, (U.S. CLS. 100, 101 AND 102). SN 78-659,054. PUB. 7-31-2007. FILED 6-27-2005.
- 3,311,744 (*See Class 35 for this trademark*).
- 3,311,749. **TRADECAPTURE (BLOCK FORM)**. TRADECAPTURE, INC., (U.S. CLS. 100, 101 AND 102). SN 78-673,160. PUB. 7-31-2007. FILED 7-19-2005.
- 3,311,826. **100 PLUS REALTY GROUP LLC. 100PLUSREALTY.COM AND DESIGN**. 100 PLUS REALTY GROUP, LLC, (U.S. CLS. 100, 101 AND 102). SN 78-731,937. PUB. 7-31-2007. FILED 10-12-2005.
- 3,311,829. **UNITUS (BLOCK FORM)**. UNITUS, INC., (U.S. CLS. 100, 101 AND 102). SN 78-734,554. PUB. 7-31-2007. FILED 10-17-2005.
- 3,311,868 (*See Class 25 for this trademark*).
- 3,311,885. **CHURCHILL FINANCIAL (BLOCK FORM)**. CHURCHILL BRAND HOLDINGS LLC, (U.S. CLS. 100, 101 AND 102). SN 78-780,987. PUB. 7-31-2007. FILED 12-27-2005.
- 3,311,893 (*See Class 35 for this trademark*).
- 3,311,905. **CITY CENTER RETAIL AND DESIGN**. CITY CENTER RETAIL, LLC, MULTIPLE CLASS, (INT. CLS. 36 AND 37), (U.S. CLS. 100, 101, 102, 103 AND 106). SN 78-794,751. PUB. 7-31-2007. FILED 1-19-2006.
- 3,311,907. **GIANT REALTY AND DESIGN**. GIANT MEDIA LLC, (U.S. CLS. 100, 101 AND 102). SN 78-795,767. PUB. 4-10-2007. FILED 1-20-2006.
- 3,311,944. **ALLIED ARTS GUILD (BLOCK FORM)**. WOODSIDE-ATHERTON AUXILIARY FOR CHILDREN, MULTIPLE CLASS, (INT. CLS. 36 AND 43), (U.S. CLS. 100, 101 AND 102). SN 78-816,818. PUB. 7-31-2007. FILED 2-16-2006.
- 3,311,976. **NSA NUESTRA SEÑORA DE LA ASUNCIÓN ENVÍO DE DINERO - ENCOMIENDAS AND DESIGN**. EMPRESA NUESTRA SEÑORA DE LA ASUNCIÓN C.I.S.A., MULTIPLE CLASS, (INT. CLS. 36 AND 39), (U.S. CLS. 100, 101, 102 AND 105). SN 78-837,481. PUB. 7-31-2007. FILED 3-15-2006.
- 3,311,979. **BEST BUY REAL ESTATE (BLOCK FORM)**. BEST BUY REAL ESTATE, (U.S. CLS. 100, 101 AND 102). SN 78-838,045. PUB. 4-10-2007. FILED 3-15-2006.
- 3,311,997. **CHECK 1 2 3 AND DESIGN**. CHARTWAY FINANCIAL SERVICES, LLC, (U.S. CLS. 100, 101 AND 102). SN 78-846,435. PUB. 7-31-2007. FILED 3-27-2006.
- 3,312,001 (*See Class 16 for this trademark*).
- 3,312,003. **JUST SNOOPING.COM AND DESIGN**. SHEILA MOSES, AND MARTY MOSES, (U.S. CLS. 100, 101 AND 102). SN 78-847,981. PUB. 7-31-2007. FILED 3-28-2006.
- 3,312,012. **NORTE AMÉRICA AND DESIGN**. MXGA INC., (U.S. CLS. 100, 101 AND 102). SN 78-850,847. PUB. 7-31-2007. FILED 3-31-2006.
- 3,312,027. **BUENA VIDA AND DESIGN**. MINTO HOLDINGS INC., (U.S. CLS. 100, 101 AND 102). SN 78-854,538. PUB. 7-31-2007. FILED 4-5-2006.
- 3,312,049. **VI PRIVATE JETS (STYLIZED)**. V1 JETS INTERNATIONAL, INC., MULTIPLE CLASS, (INT. CLS. 36 AND 39), (U.S. CLS. 100, 101, 102 AND 105). SN 78-860,665. PUB. 7-31-2007. FILED 4-13-2006.
- 3,312,090 (*See Class 35 for this trademark*).
- 3,312,147. **YOUR GATEWAY TO REAL ESTATE FINANCE (BLOCK FORM)**. ARIMA CAPITAL, LLC, (U.S. CLS. 100, 101 AND 102). SN 78-878,161. PUB. 7-31-2007. FILED 5-5-2006.
- 3,312,162. **DEPOSIT I.T. (BLOCK FORM)**. BANK OF BLUE VALLEY, (U.S. CLS. 100, 101 AND 102). SN 78-880,784. PUB. 7-31-2007. FILED 5-10-2006.
- 3,312,178. **BERKLEY ACCIDENT AND HEALTH (BLOCK**

- FORM**). BERKLEY ACCIDENT AND HEALTH, LLC, (U.S. CLS. 100, 101 AND 102). SN 78-882,666. PUB. 7-31-2007. FILED 5-12-2006.
- 3,312,185 (*See Class 9 for this trademark*).
- 3,312,188. **MISCELLANEOUS DESIGN**. TRADITIONS CAPITAL, LLC, (U.S. CLS. 100, 101 AND 102). SN 78-883,909. PUB. 7-31-2007. FILED 5-15-2006.
- 3,312,210. **THE COINDEXER CLUB AND DESIGN**. APPLAUSE MARKETING GROUP, LLC, MULTIPLE CLASS, (INT. CLS. 36 AND 41), (U.S. CLS. 100, 101, 102 AND 107). SN 78-886,745. PUB. 7-31-2007. FILED 5-18-2006.
- 3,312,215. **RH CAPITAL (BLOCK FORM)**. RH CAPITAL ASSOCIATES LLC, (U.S. CLS. 100, 101 AND 102). SN 78-887,034. PUB. 7-31-2007. FILED 5-18-2006.
- 3,312,218 (*See Class 35 for this trademark*).
- 3,312,224 (*See Class 35 for this trademark*).
- 3,312,238. **ANCHORAGE PLACE PROPERTIES (BLOCK FORM)**. TRUSTEES OF THE CALVERT FAMILY TRUST, THE, (U.S. CLS. 100, 101 AND 102). SN 78-891,921. PUB. 7-31-2007. FILED 5-24-2006.
- 3,312,243 (*See Class 35 for this trademark*).
- 3,312,276. **COMMON GROUND (BLOCK FORM)**. COMMON GROUND COMMUNITY H.D.F.C., INC., MULTIPLE CLASS, (INT. CLS. 36, 41, 43, 44 AND 45), (U.S. CLS. 100, 101, 102 AND 107). SN 78-899,737. PUB. 7-31-2007. FILED 6-2-2006.
- 3,312,296 (*See Class 35 for this trademark*).
- 3,312,312 (*See Class 35 for this trademark*).
- 3,312,339. **COMMISSION OPTIMIZER (BLOCK FORM)**. EZE CASTLE SOFTWARE, INC., MULTIPLE CLASS, (INT. CLS. 36 AND 42), (U.S. CLS. 100, 101 AND 102). SN 78-911,423. PUB. 7-31-2007. FILED 6-19-2006.
- 3,312,357. **ACCESS REVERSE AND DESIGN**. ACCESS REVERSE MORTGAGE CORPORATION, (U.S. CLS. 100, 101 AND 102). SN 78-914,051. PUB. 7-31-2007. FILED 6-22-2006.
- 3,312,393. **VALUE PLUS (BLOCK FORM)**. LANDSCAPE STRUCTURES, INC., (U.S. CLS. 100, 101 AND 102). SN 78-921,094. PUB. 7-31-2007. FILED 6-30-2006.
- 3,312,405 (*See Class 35 for this trademark*).
- 3,312,407. **BICOASTAL LENDING GROUP (BLOCK FORM)**. A AND E FOUNDATION LLC, (U.S. CLS. 100, 101 AND 102). SN 78-922,693. PUB. 7-31-2007. FILED 7-5-2006.
- 3,312,408. **NELLIE MAE A SALLIE MAE STUDENT LOAN COMPANY AND DESIGN**. NELLIE MAE CORPORATION, (U.S. CLS. 100, 101 AND 102). SN 78-922,762. PUB. 7-31-2007. FILED 7-5-2006.
- 3,312,410 (*See Class 9 for this trademark*).
- 3,312,411 (*See Class 9 for this trademark*).
- 3,312,415 (*See Class 35 for this trademark*).
- 3,312,444. **COMMUNITY FOOTPRINTS (BLOCK FORM)**. THE RITZ-CARLTON HOTEL COMPANY, L.L.C., (U.S. CLS. 100, 101 AND 102). SN 78-927,622. PUB. 7-31-2007. FILED 7-12-2006.
- 3,312,445 (*See Class 35 for this trademark*).
- 3,312,450 (*See Class 35 for this trademark*).
- 3,312,472. **ARDOUR CAPITAL INVESTMENTS, LLC AND DESIGN**. ARDOUR CAPITAL PARTNERS, LLC, (U.S. CLS. 100, 101 AND 102). SN 78-931,271. PUB. 7-31-2007. FILED 7-17-2006.
- 3,312,473. **ARDOUR GLOBAL ALTERNATIVE ENERGY INDEXES (BLOCK FORM)**. ARDOUR CAPITAL PARTNERS, LLC, (U.S. CLS. 100, 101 AND 102). SN 78-931,280. PUB. 7-31-2007. FILED 7-17-2006.
- 3,312,506 (*See Class 16 for this trademark*).
- 3,312,510. **PROMISE, DELIVER, ALWAYS (BLOCK FORM)**. TATONKA CAPITAL CORPORATION, (U.S. CLS. 100, 101 AND 102). SN 78-937,839. PUB. 7-31-2007. FILED 7-26-2006.
- 3,312,512. **CCB CREDIT SERVICES AND DESIGN**. CCB CREDIT SERVICES, INC., (U.S. CLS. 100, 101 AND 102). SN 78-938,283. PUB. 7-31-2007. FILED 7-26-2006.
- 3,312,515. **R H AND DESIGN**. ROCKHILL INSURANCE COMPANY, (U.S. CLS. 100, 101 AND 102). SN 78-938,570. PUB. 7-31-2007. FILED 7-27-2006.
- 3,312,519. **NORDICA (STYLIZED)**. ASTOR DEVELOPMENT GROUP, LLC, (U.S. CLS. 100, 101 AND 102). SN 78-939,190. PUB. 7-31-2007. FILED 7-27-2006.
- 3,312,558 (*See Class 16 for this trademark*).
- 3,312,604. **I CAN CAPITAL ASSISTANCE NETWORK AND DESIGN**. CAROLINE C. NEWSOM, (U.S. CLS. 100, 101 AND 102). SN 78-959,090. PUB. 7-31-2007. FILED 8-23-2006.
- 3,312,624. **INSPIRADA AND DESIGN**. SOUTH EDGE, LLC, (U.S. CLS. 100, 101 AND 102). SN 78-961,740. PUB. 7-31-2007. FILED 8-28-2006.
- 3,312,643. **RETIREMENT INTELLIGENCE (BLOCK FORM)**. LOSEY III, WILLIAM A., (U.S. CLS. 100, 101 AND 102). SN 78-964,708. PUB. 7-31-2007. FILED 8-31-2006.
- 3,312,657. **MOUNT SINAI (BLOCK FORM)**. SINAI TEMPLE, DBA MOUNT SINAI MEMORIAL PARK, MULTIPLE CLASS, (INT. CLS. 36, 44 AND 45), (U.S. CLS. 100, 101 AND 102). SN 78-968,182. PUB. 7-31-2007. FILED 9-6-2006.
- 3,312,658. **M AND DESIGN**. SINAI TEMPLE DBA MOUNT SINAI MEMORIAL PARK, MULTIPLE CLASS, (INT. CLS. 36, 44 AND 45), (U.S. CLS. 100, 101 AND 102). SN 78-968,461. PUB. 7-31-2007. FILED 9-6-2006.
- 3,312,677. **EDEPOSIT (BLOCK FORM)**. EDEPOSIT CORPORATION, (U.S. CLS. 100, 101 AND 102). SN 78-971,988. PUB. 7-31-2007. FILED 9-12-2006.
- 3,312,686. **FIGHT FOREVER (BLOCK FORM)**. FIGHT FOREVER FOUNDATION, (U.S. CLS. 100, 101 AND 102). SN 78-974,520. PUB. 7-31-2007. FILED 9-14-2006.
- 3,312,688. **ICELOLLY (BLOCK FORM)**. WALTON, ADRIAN GEORGE, MULTIPLE CLASS, (INT. CLS. 36, 39 AND 43), (U.S. CLS. 100, 101, 102 AND 105). SN 78-977,843. PUB. 4-24-2007. FILED 7-15-2005.
- 3,312,695. **T TENNESSEE STATE BANK "BANKING AT ITS BEST" MEMBER FDIC AND DESIGN**. TENNESSEE STATE BANK, (U.S. CLS. 100, 101 AND 102). SN 78-978,523. PUB. 7-31-2007. FILED 7-12-2006.
- 3,312,733 (*See Class 9 for this trademark*).
- 3,312,735 (*See Class 9 for this trademark*).
- 3,312,765. **SUMMIT PARTNERS VENTURE CAPITAL FUND (STYLIZED)**. SUMMIT PARTNERS LP, (U.S. CLS. 100, 101 AND 102). SN 79-024,183. PUB. 7-31-2007. FILED 4-18-2006.
- 3,312,766. **SUMMIT PARTNERS SUBORDINATED DEBT FUND (STYLIZED)**. SUMMIT PARTNERS LP, (U.S. CLS. 100, 101 AND 102). SN 79-024,184. PUB. 7-31-2007. FILED 4-18-2006.
- 3,312,767. **SUMMIT PARTNERS PRIVATE EQUITY FUND (STYLIZED)**. SUMMIT PARTNERS LP, (U.S. CLS. 100, 101 AND 102). SN 79-024,185. PUB. 7-31-2007. FILED 4-18-2006.
- 3,312,768. **SUMMIT VENTURES (STYLIZED)**. SUMMIT PARTNERS LP, (U.S. CLS. 100, 101 AND 102). SN 79-024,186. PUB. 7-31-2007. FILED 4-18-2006.
- 3,312,769. **SUMMIT PARTNERS (STYLIZED)**. SUMMIT PARTNERS LP, (U.S. CLS. 100, 101 AND 102). SN 79-024,187. PUB. 7-31-2007. FILED 4-18-2006.
- 3,312,778 (*See Class 35 for this trademark*).
- 3,312,781. **CASSA LOMBARDA AND DESIGN**. CASSA LOMBARDA S.P.A., (U.S. CLS. 100, 101 AND 102). SN 79-024,916. PUB. 7-31-2007. FILED 2-16-2006.
- 3,312,794 (*See Class 9 for this trademark*).
- 3,312,865 (*See Class 9 for this trademark*).
- 3,312,868. **CREDITWEST (STYLIZED)**. ALTINBAS HOLDING ANONIM SIRKETI, (U.S. CLS. 100, 101 AND 102). SN 79-029,069. PUB. 7-31-2007. FILED 3-3-2006.
- 3,312,878. **TT TRI-TRADE AND DESIGN**. CENTRAL TANSHI SECURITIES, CO., LTD., MULTIPLE CLASS, (INT. CLS. 36, 38 AND 42), (U.S. CLS. 100, 101, 102 AND 104). SN 79-029,584. PUB. 7-31-2007. FILED 6-16-2006.
- 3,312,896 (*See Class 29 for this trademark*).
- 3,312,917. **OFF PLAN PLANET AND DESIGN**. OFFPLAN-PLANET LTD., (U.S. CLS. 100, 101 AND 102). SN 79-031,254. PUB. 7-31-2007. FILED 11-2-2006.
- 3,312,937 (*See Class 35 for this trademark*).

CLASS 37—CONSTRUCTION AND REPAIR

- 3,310,204 (*See Class 3 for this trademark*).
- 3,310,234 (*See Class 1 for this trademark*).
- 3,310,238 (*See Class 35 for this trademark*).
- 3,310,304. **EMPIRE CONTINENTAL AND DESIGN**. EMPIRE CONTINENTAL MANAGEMENT INC., (U.S. CLS. 100, 103 AND 106). SN 76-658,702. PUB. 1-9-2007. FILED 4-19-2006.
- 3,310,307. **PRIMARY ACOUSTICS AND DESIGN**. PRIMARY

- IP LLC, (U.S. CLS. 100, 103 AND 106). SN 76-659,611. PUB. 7-10-2007. FILED 5-5-2006.
- 3,310,315 (*See Class 35 for this trademark*).
- 3,310,316 (*See Class 35 for this trademark*).
- 3,310,417. **WHISPERING HAWK (BLOCK FORM)**. TALISKER MOUNTAIN INCORPORATED, (U.S. CLS. 100, 103 AND 106). SN 76-672,223. PUB. 7-31-2007. FILED 2-5-2007.
- 3,310,441. **US-1 AND DESIGN**. U.S. SIGNS, INC., MULTIPLE CLASS, (INT. CLS. 37 AND 42), (U.S. CLS. 100, 101, 103 AND 106). SN 77-002,636. PUB. 7-31-2007. FILED 9-19-2006.
- 3,310,449. **CONSTRUCT AND DESIGN**. CONSTRUCT, INC., MULTIPLE CLASS, (INT. CLS. 37 AND 40), (U.S. CLS. 100, 103 AND 106). SN 77-004,507. PUB. 7-31-2007. FILED 9-21-2006.
- 3,310,460. **M & E PAINTING LLC AND DESIGN**. M & E PAINTING, LLC, (U.S. CLS. 100, 103 AND 106). SN 77-006,558. PUB. 7-31-2007. FILED 9-25-2006.
- 3,310,473. **MAKE IT YOUR OWN (BLOCK FORM)**. THE OLSON COMPANY, (U.S. CLS. 100, 103 AND 106). SN 77-009,131. PUB. 7-31-2007. FILED 9-27-2006.
- 3,310,474. **OLSON LIFESTYLE MAKE IT YOUR OWN AND DESIGN**. THE OLSON COMPANY, (U.S. CLS. 100, 103 AND 106). SN 77-009,139. PUB. 7-31-2007. FILED 9-27-2006.
- 3,310,495 (*See Class 7 for this trademark*).
- 3,310,525. **"YOUR PRESCRIPTION FOR A GREAT LOOK" (BLOCK FORM)**. MENDEZ, CHRISTOPHER, (U.S. CLS. 100, 103 AND 106). SN 77-016,946. PUB. 7-31-2007. FILED 10-9-2006.
- 3,310,549 (*See Class 9 for this trademark*).
- 3,310,566 (*See Class 4 for this trademark*).
- 3,310,575 (*See Class 4 for this trademark*).
- 3,310,586 (*See Class 36 for this trademark*).
- 3,310,592. **HELPING PEOPLE COMMUNICATE (BLOCK FORM)**. FORD AUDIO-VIDEO SYSTEMS, INC., (U.S. CLS. 100, 103 AND 106). SN 77-028,126. PUB. 7-31-2007. FILED 10-24-2006.
- 3,310,593. **"YOUR PRESCRIPTION FOR GREAT LOOKING DRAPES & MORE" (BLOCK FORM)**. MENDEZ, CHRISTOPHER, (U.S. CLS. 100, 103 AND 106). SN 77-028,269. PUB. 7-31-2007. FILED 10-24-2006.
- 3,310,616 (*See Class 35 for this trademark*).
- 3,310,626 (*See Class 35 for this trademark*).
- 3,310,684 (*See Class 16 for this trademark*).
- 3,310,700. **GREYHAWK SERVICES (BLOCK FORM)**. GREY-HAWK SERVICES, LLC, (U.S. CLS. 100, 103 AND 106). SN 77-047,921. PUB. 7-31-2007. FILED 11-20-2006.
- 3,310,736. **ALL STAR ELECTRIC SOLUTIONS INC. AND DESIGN**. SANDERS, ROBERT ALAN, (U.S. CLS. 100, 103 AND 106). SN 77-053,302. PUB. 7-31-2007. FILED 11-29-2006.
- 3,310,738. **MISCELLANEOUS DESIGN**. 20/20 GROUP INC., (U.S. CLS. 100, 103 AND 106). SN 77-053,501. PUB. 7-17-2007. FILED 11-29-2006.
- 3,310,742. **N-LINE TRAFFIC MAINTENANCE AND DESIGN**. N-LINE TRAFFIC MAINTENANCE, (U.S. CLS. 100, 103 AND 106). SN 77-053,722. PUB. 7-31-2007. FILED 11-30-2006.
- 3,310,762. **MASTER RADIATOR AND DESIGN**. WATERFORD RADIATOR, INC., (U.S. CLS. 100, 103 AND 106). SN 77-056,090. PUB. 7-31-2007. FILED 12-4-2006.
- 3,310,764 (*See Class 1 for this trademark*).
- 3,310,801 (*See Class 35 for this trademark*).
- 3,310,913. **PROMET MARINE SERVICES AND DESIGN**. PROMET MARINE SERVICE CORPORATION, (U.S. CLS. 100, 103 AND 106). SN 77-069,431. PUB. 7-31-2007. FILED 12-21-2006.
- 3,310,946. **CRYSTAL PEAK LODGE (BLOCK FORM)**. VAIL TRADEMARKS, INC., (U.S. CLS. 100, 103 AND 106). SN 77-070,856. PUB. 7-31-2007. FILED 12-22-2006.
- 3,310,948. **THE MOBILE LAUNDRY SOLUTION (BLOCK FORM)**. DOOR-TO-DOOR DRY CLEANING FRANCHISE SYSTEMS, LLC, MULTIPLE CLASS, (INT. CLS. 37 AND 39), (U.S. CLS. 100, 103, 105 AND 106). SN 77-070,867. PUB. 7-31-2007. FILED 12-22-2006.
- 3,310,956. **FUN IN THE SUN DELGALLO COUNTRY POOLS AND DESIGN**. DELGALLO, FRANK, (U.S. CLS. 100, 103 AND 106). SN 77-070,936. PUB. 7-31-2007. FILED S.R. 12-23-2006; AM. P.R. 4-20-2007.
- 3,310,993 (*See Class 36 for this trademark*).
- 3,311,012. **NO WORRY NETWORK AND DESIGN**. RUTTER COMMUNICATIONS NETWORK, LLC, (U.S. CLS. 100, 103 AND 106). SN 77-072,458. PUB. 7-31-2007. FILED 12-28-2006.
- 3,311,037. **ALL IN A TOUCH AND DESIGN**. ALL IN A TOUCH, (U.S. CLS. 100, 103 AND 106). SN 77-073,024. PUB. 7-31-2007. FILED 12-28-2006.
- 3,311,044. **REGAL HERITAGE HOMES, INC RH AND DESIGN**. REGAL HERITAGE HOMES, INC., (U.S. CLS. 100, 103 AND 106). SN 77-073,181. PUB. 7-31-2007. FILED 12-29-2006.
- 3,311,055. **OMNIFLIGHT (BLOCK FORM)**. OMNIFLIGHT HELICOPTERS, INC., MULTIPLE CLASS, (INT. CLS. 37 AND 39), (U.S. CLS. 100, 103, 105 AND 106). SN 77-073,363. PUB. 7-31-2007. FILED 12-29-2006.
- 3,311,065. **YOUR HOME - YOUR CHOICE (BLOCK FORM)**. GLOVER HOMES, INC., (U.S. CLS. 100, 103 AND 106). SN 77-073,639. PUB. 7-31-2007. FILED 12-29-2006.
- 3,311,110. **LINK SOURCE (BLOCK FORM)**. LINK SOURCE, LLC, MULTIPLE CLASS, (INT. CLS. 37 AND 42), (U.S. CLS. 100, 101, 103 AND 106). SN 77-074,788. PUB. 7-31-2007. FILED 1-3-2007.
- 3,311,115. **ROADSIDEWERX (BLOCK FORM)**. ROADSIDE WERX, L.L.C., MULTIPLE CLASS, (INT. CLS. 37 AND 39), (U.S. CLS. 100, 103, 105 AND 106). SN 77-074,962. PUB. 7-31-2007. FILED 1-3-2007.
- 3,311,128. **AVEENA (BLOCK FORM)**. LYNATE PETTENGILL, (U.S. CLS. 100, 103 AND 106). SN 77-076,289. PUB. 7-31-2007. FILED 1-4-2007.
- 3,311,160. **COAST TO COAST WATER DAMAGE & RESTORATION, INC. AND DESIGN**. COAST TO COAST WATER DAMAGE & RESTORATION, INC., MULTIPLE CLASS, (INT. CLS. 37 AND 40), (U.S. CLS. 100, 103 AND 106). SN 77-079,717. PUB. 7-31-2007. FILED 10-10-2007.
- 3,311,195. **TW AND DESIGN**. TODD WARD LLC, MULTIPLE CLASS, (INT. CLS. 37 AND 42), (U.S. CLS. 100, 101, 103 AND 106). SN 77-082,707. PUB. 7-31-2007. FILED 1-14-2007.
- 3,311,247 (*See Class 9 for this trademark*).
- 3,311,257 (*See Class 9 for this trademark*).
- 3,311,308. **CONFIDENCEPACT (BLOCK FORM)**. MILLER WELDMASTER CORPORATION, MULTIPLE CLASS, (INT. CLS. 37 AND 41), (U.S. CLS. 100, 101, 103, 106 AND 107). SN 77-092,256. PUB. 7-31-2007. FILED 1-26-2007.
- 3,311,336. **CHEM-SERV (BLOCK FORM)**. CHEM-SERV, MULTIPLE CLASS, (INT. CLS. 37 AND 40), (U.S. CLS. 100, 103 AND 106). SN 77-094,418. PUB. 7-31-2007. FILED 1-30-2007.
- 3,311,345. **LONGMEADOW HOME BUILDERS (BLOCK FORM)**. LONGMEADOW HOMES, LLC, (U.S. CLS. 100, 103 AND 106). SN 77-095,281. PUB. 7-31-2007. FILED 1-31-2007.
- 3,311,370. **HYDRA DRY (BLOCK FORM)**. HYDRADRY, INC., (U.S. CLS. 100, 103 AND 106). SN 77-096,978. PUB. 7-31-2007. FILED 2-1-2007.
- 3,311,439. **ACCESS CASH (BLOCK FORM)**. ACCESS CASH INTERNATIONAL, LLC, (U.S. CLS. 100, 103 AND 106). SN 77-099,416. PUB. 7-31-2007. FILED 2-5-2007.
- 3,311,448. **MISCELLANEOUS DESIGN**. GRANT HUFFMAN, LP, (U.S. CLS. 100, 103 AND 106). SN 77-099,751. PUB. 7-31-2007. FILED 2-5-2007.
- 3,311,481. **BRECK STYLE (BLOCK FORM)**. VAIL TRADEMARKS, INC., (U.S. CLS. 100, 103 AND 106). SN 77-102,073. PUB. 7-31-2007. FILED 2-7-2007.
- 3,311,482. **BEACH FRONT LIVING BRECK STYLE (BLOCK FORM)**. VAIL TRADEMARKS, INC., (U.S. CLS. 100, 103 AND 106). SN 77-102,077. PUB. 7-31-2007. FILED 2-7-2007.
- 3,311,499. **GOODFELLOWS SHOESHINE (BLOCK FORM)**. S.L.B. INC., (U.S. CLS. 100, 103 AND 106). SN 77-105,137. PUB. 7-31-2007. FILED 2-12-2007.
- 3,311,520 (*See Class 35 for this trademark*).
- 3,311,521 (*See Class 35 for this trademark*).
- 3,311,634 (*See Class 2 for this trademark*).
- 3,311,638 (*See Class 35 for this trademark*).
- 3,311,710. **DOODIE FREE (BLOCK FORM)**. DOODIE FREE, LLC, (U.S. CLS. 100, 103 AND 106). SN 78-607,090. PUB. 7-31-2007. FILED 4-12-2005.
- 3,311,722. **CLARK FOOD SAFETY AND DESIGN**. CLARK PEST CONTROL OF STOCKTON, INC., MULTIPLE CLASS, (INT. CLS. 37 AND 45), (U.S. CLS. 100, 101, 103 AND 106). SN 78-641,354. PUB. 7-31-2007. FILED 6-1-2005.
- 3,311,733 (*See Class 35 for this trademark*).

3,311,766 (*See Class 9 for this trademark*).
 3,311,794 (*See Class 35 for this trademark*).
 3,311,797. **WATCH.TALK.SURF (BLOCK FORM)**. MULTIBAND SUBSCRIBER SERVICES, INC., MULTIPLE CLASS, (INT. CLS. 37 AND 38), (U.S. CLS. 100, 101, 103, 104 AND 106). SN 78-712,103. PUB. 7-31-2007. FILED 9-13-2005.
 3,311,808. **T AND DESIGN**. YOUNG M.D., SCOTT C., AND JAMES, SULARA, AKA ROBIN, MULTIPLE CLASS, (INT. CLS. 37 AND 45), (U.S. CLS. 100, 101, 103 AND 106). SN 78-721,192. PUB. 7-31-2007. FILED 9-27-2005.
 3,311,821 (*See Class 9 for this trademark*).
 3,311,834. **SK AND DESIGN**. SK CHEMICALS CO., LTD., AND SK NETWORKS CO., LTD., AND SKC CO., LTD., AND SK CORPORATION, AND SK TELECOM CO., LTD., (U.S. CLS. 100, 103 AND 106). SN 78-737,645. PUB. 7-31-2007. FILED 10-20-2005.
 3,311,865 (*See Class 19 for this trademark*).
 3,311,894 (*See Class 35 for this trademark*).
 3,311,905 (*See Class 36 for this trademark*).
 3,311,914 (*See Class 35 for this trademark*).
 3,311,924. **L. A. HYDRO-JET & ROOTER SERVICE, INC. AND DESIGN**. L.A. HYDRO-JET & ROOTER SERVICE, INC., (U.S. CLS. 100, 103 AND 106). SN 78-804,381. PUB. 7-31-2007. FILED 2-1-2006.
 3,311,948. **AMTEC AND DESIGN**. AMTEC, LLC, (U.S. CLS. 100, 103 AND 106). SN 78-821,514. PUB. 7-31-2007. FILED 2-23-2006.
 3,311,990. **ADENUS SOLUTIONS GROUP AND DESIGN**. ADENUS GROUP, LLC, MULTIPLE CLASS, (INT. CLS. 37 AND 42), (U.S. CLS. 100, 101, 103 AND 106). SN 78-844,236. PUB. 7-31-2007. FILED 3-23-2006.
 3,312,024. **MARSDEN AND DESIGN**. MARSDEN BLDG MAINTENANCE, L.L.C., (U.S. CLS. 100, 103 AND 106). SN 78-854,469. PUB. 7-31-2007. FILED 4-5-2006.
 3,312,034 (*See Class 35 for this trademark*).
 3,312,042. **"DON" T CUSS, CALL US" (BLOCK FORM)**. ISKENDERIAN, PHILIP G., (U.S. CLS. 100, 103 AND 106). SN 78-859,292. PUB. 7-31-2007. FILED 4-11-2006.
 3,312,090 (*See Class 35 for this trademark*).
 3,312,231. **THE NORTH END AND DESIGN**. MANDEL GROUP, INC., (U.S. CLS. 100, 103 AND 106). SN 78-890,403. PUB. 7-31-2007. FILED 5-23-2006.
 3,312,255 (*See Class 7 for this trademark*).
 3,312,256 (*See Class 7 for this trademark*).
 3,312,281. **DOCTOR SPEED'S (BLOCK FORM)**. HARRIS, JERY, (U.S. CLS. 100, 103 AND 106). SN 78-901,289. PUB. 7-31-2007. FILED 6-6-2006.
 3,312,311. **IMPRESSIVE BASEMENT SYSTEMS AND DESIGN**. IMPRESSIVE TILE CO. INC., (U.S. CLS. 100, 103 AND 106). SN 78-906,144. PUB. 7-31-2007. FILED 6-12-2006.
 3,312,422 (*See Class 35 for this trademark*).
 3,312,447. **MISCELLANEOUS DESIGN**. SUNMARKS, LLC, (U.S. CLS. 100, 103 AND 106). SN 78-928,070. PUB. 7-31-2007. FILED 7-12-2006.
 3,312,454 (*See Class 7 for this trademark*).
 3,312,469. **HYDROTECH (BLOCK FORM)**. HYDROTECH, INC., MULTIPLE CLASS, (INT. CLS. 37, 40 AND 42), (U.S. CLS. 100, 101, 103 AND 106). SN 78-931,022. PUB. 7-31-2007. FILED 7-17-2006.
 3,312,501. **CENTIMARK . NORTH AMERICA'S ROOFING CONTRACTOR ANY ROOF ANYWHERE ANYTIME AND DESIGN**. CENTIMARK INTERNATIONAL CORPORATION, (U.S. CLS. 100, 103 AND 106). SN 78-935,986. PUB. 7-31-2007. FILED 7-24-2006.
 3,312,502. **MISCELLANEOUS DESIGN**. HYDROTECH, INC., MULTIPLE CLASS, (INT. CLS. 37, 40 AND 42), (U.S. CLS. 100, 101, 103 AND 106). SN 78-935,990. PUB. 7-31-2007. FILED 7-24-2006.
 3,312,517. **ACTION INTEGRATED (BLOCK FORM)**. ACTION ALARM SYSTEMS, INC., MULTIPLE CLASS, (INT. CLS. 37 AND 42), (U.S. CLS. 100, 101, 103 AND 106). SN 78-938,914. PUB. 7-31-2007. FILED 7-27-2006.
 3,312,562. **DVH (BLOCK FORM)**. BB TECHNOLOGIES, INC., MULTIPLE CLASS, (INT. CLS. 37 AND 42), (U.S. CLS. 100, 101, 103 AND 106). SN 78-948,543. PUB. 7-31-2007. FILED 8-9-2006.
 3,312,601. **MPYRE COMPUTER NINJAS (BLOCK FORM)**. JAMES P. STILES, (U.S. CLS. 100, 103 AND 106). SN 78-

958,554. PUB. 7-31-2007. FILED 8-23-2006.
 3,312,616. **DAVE'S SEPTIC SERVICE (BLOCK FORM)**. DAVE'S SEPTIC SERVICE, INC., MULTIPLE CLASS, (INT. CLS. 37 AND 44), (U.S. CLS. 100, 101, 103 AND 106). SN 78-961,142. PUB. 7-31-2007. FILED 8-26-2006.
 3,312,625. **INSPIRADA AND DESIGN**. SOUTH EDGE, LLC, (U.S. CLS. 100, 103 AND 106). SN 78-961,744. PUB. 7-31-2007. FILED 8-28-2006.
 3,312,689 (*See Class 35 for this trademark*).
 3,312,691. **FAIRWOOD (BLOCK FORM)**. ROUSE-FAIRWOOD DEVELOPMENT LIMITED PARTNERSHIP, (U.S. CLS. 100, 103 AND 106). SN 78-978,405. PUB. 7-31-2007. FILED 3-28-2006.
 3,312,693. **FAIRWOOD AND DESIGN**. ROUSE-FAIRWOOD DEVELOPMENT LIMITED PARTNERSHIP, (U.S. CLS. 100, 103 AND 106). SN 78-978,433. PUB. 7-31-2007. FILED 3-28-2006.
 3,312,712 (*See Class 1 for this trademark*).
 3,312,733 (*See Class 9 for this trademark*).
 3,312,736 (*See Class 12 for this trademark*).
 3,312,756 (*See Class 6 for this trademark*).
 3,312,794 (*See Class 9 for this trademark*).
 3,312,799 (*See Class 9 for this trademark*).
 3,312,821 (*See Class 11 for this trademark*).
 3,312,826 (*See Class 6 for this trademark*).
 3,312,834 (*See Class 12 for this trademark*).
 3,312,844 (*See Class 12 for this trademark*).
 3,312,865 (*See Class 9 for this trademark*).
 3,312,879 (*See Class 9 for this trademark*).
 3,312,912 (*See Class 7 for this trademark*).
 3,312,942 (*See Class 7 for this trademark*).
 3,312,948 (*See Class 9 for this trademark*).

CLASS 38—COMMUNICATION

3,310,190. **AOL INSTANT MESSENGER**. AOL LLC, MULTIPLE CLASS, (INT. CLS. 38 AND 39), (U.S. CLS. 100, 101, 104 AND 105). SN 75-460,305. PUB. 12-26-2006. FILED 4-1-1998.
 3,310,194. **INSTANT MESSENGER**. AOL LLC, MULTIPLE CLASS, (INT. CLS. 38 AND 39), (U.S. CLS. 100, 101, 104 AND 105). SN 75-497,543. PUB. 12-26-2006. FILED 6-4-1998.
 3,310,202. **TERRATEL**. TERRA NETWORKS, S.A., (U.S. CLS. 100, 101 AND 104). SN 75-921,809. PUB. 7-31-2007. FILED 2-16-2000.
 3,310,221 (*See Class 9 for this trademark*).
 3,310,237 (*See Class 9 for this trademark*).
 3,310,247 (*See Class 9 for this trademark*).
 3,310,520. **VENTZUS (BLOCK FORM)**. LUCIDO, DANIELLE, (U.S. CLS. 100, 101 AND 104). SN 77-016,654. PUB. 7-31-2007. FILED 10-9-2006.
 3,310,548 (*See Class 9 for this trademark*).
 3,310,581. **C CONVERSENT COMMUNICATIONS AND DESIGN**. ONE COMMUNICATIONS, MULTIPLE CLASS, (INT. CLS. 38 AND 42), (U.S. CLS. 100, 101 AND 104). SN 77-026,334. PUB. 7-31-2007. FILED 10-20-2006.
 3,310,597 (*See Class 9 for this trademark*).
 3,310,598 (*See Class 9 for this trademark*).
 3,310,617. **ROIALTE (BLOCK FORM)**. ROIALTE INTERNATIONALE, INC., (U.S. CLS. 100, 101 AND 104). SN 77-032,783. PUB. 7-31-2007. FILED 10-30-2006.
 3,310,625. **COAST TO COAST AM (BLOCK FORM)**. PREMIERE RADIO NETWORKS, INC., (U.S. CLS. 100, 101 AND 104). SN 77-034,520. PUB. 7-31-2007. FILED 11-1-2006.
 3,310,663. **CJ AND DESIGN**. CJ CORP., (U.S. CLS. 100, 101 AND 104). SN 77-041,565. PUB. 7-31-2007. FILED 11-10-2006.
 3,310,721. **HOTSPOT CONNECT AND DESIGN**. HOTSPOT WIRELESS, INC., (U.S. CLS. 100, 101 AND 104). SN 77-050,480. PUB. 7-31-2007. FILED 11-24-2006.
 3,310,732 (*See Class 35 for this trademark*).
 3,310,770 (*See Class 9 for this trademark*).
 3,310,803. **C CINECANAL AND DESIGN**. LAPTV ATLANTA PARTNERS, (U.S. CLS. 100, 101 AND 104). SN 77-061,614. PUB. 7-10-2007. FILED 12-11-2006.
 3,310,846. **ALIASLINE AND DESIGN**. SAPHONE LLC, (U.S. CLS. 100, 101 AND 104). SN 77-066,808. PUB. 7-17-2007. FILED 12-18-2006.

- 3,310,891. **FROM THE MANHOLE TO THE DESKTOP. (BLOCK FORM)**. MMG HOLDINGS, INC., (U.S. CLS. 100, 101 AND 104). SN 77-068,607. PUB. 7-31-2007. FILED 12-20-2006.
- 3,310,934. **MOMHUB (BLOCK FORM)**. PARENTAL VENTURES LLC, MULTIPLE CLASS, (INT. CLS. 38, 41 AND 42), (U.S. CLS. 100, 101, 104 AND 107). SN 77-070,496. PUB. 7-31-2007. FILED 12-22-2006.
- 3,310,950 (*See Class 35 for this trademark*).
- 3,310,981. **VOOICER (BLOCK FORM)**. NATIONAL TELECOM ASSOCIATES, INC., DBA VOOICER, INC., (U.S. CLS. 100, 101 AND 104). SN 77-071,886. PUB. 7-31-2007. FILED 12-27-2006.
- 3,311,071. **HELPUOTRADE (BLOCK FORM)**. CRAIG W. PINNEY, (U.S. CLS. 100, 101 AND 104). SN 77-073,823. PUB. 7-31-2007. FILED 12-30-2006.
- 3,311,140 (*See Class 35 for this trademark*).
- 3,311,141 (*See Class 35 for this trademark*).
- 3,311,162. **REALLINX (BLOCK FORM)**. REALLINX, INC., (U.S. CLS. 100, 101 AND 104). SN 77-079,832. PUB. 7-31-2007. FILED 1-10-2007.
- 3,311,182. **TECHNOLOGY TO SERVE AND PROTECT (BLOCK FORM)**. APRISS INC., (U.S. CLS. 100, 101 AND 104). SN 77-081,688. PUB. 7-31-2007. FILED 1-12-2007.
- 3,311,203. **KUSI AND DESIGN**. MCKINNON BROADCASTING COMPANY, MULTIPLE CLASS, (INT. CLS. 38 AND 41), (U.S. CLS. 100, 101, 104 AND 107). SN 77-083,308. PUB. 7-31-2007. FILED 1-15-2007.
- 3,311,205. **KUSI NEWS AND DESIGN**. MCKINNON BROADCASTING COMPANY, MULTIPLE CLASS, (INT. CLS. 38 AND 41), (U.S. CLS. 100, 101, 104 AND 107). SN 77-083,323. PUB. 7-31-2007. FILED 1-15-2007.
- 3,311,231. **AOL POINTE (BLOCK FORM)**. AOL LLC, (U.S. CLS. 100, 101 AND 104). SN 77-085,723. PUB. 7-31-2007. FILED 1-18-2007.
- 3,311,235. **QUIZ TIME LOUNGE (BLOCK FORM)**. AOL LLC, (U.S. CLS. 100, 101 AND 104). SN 77-085,846. PUB. 7-31-2007. FILED 1-18-2007.
- 3,311,242. **INDIALOGS.IN (BLOCK FORM)**. HIT FACTORY, INC., (U.S. CLS. 100, 101 AND 104). SN 77-086,388. PUB. 7-31-2007. FILED 1-19-2007.
- 3,311,467. **MISCELLANEOUS DESIGN**. PODCASTPEOPLE, INC., (U.S. CLS. 100, 101 AND 104). SN 77-101,227. PUB. 7-31-2007. FILED 2-7-2007.
- 3,311,486. **BUCKEYE DVR (BLOCK FORM)**. BUCKEYE CABLEVISION, INC., (U.S. CLS. 100, 101 AND 104). SN 77-102,808. PUB. 7-31-2007. FILED 2-8-2007.
- 3,311,535. **HELPUOTRADE.COM GLOBAL COMMUNITY FOR TRADERS & INVESTORS AND DESIGN**. PINNEY, CRAIG W., (U.S. CLS. 100, 101 AND 104). SN 77-114,594. PUB. 7-31-2007. FILED 2-23-2007.
- 3,311,536. **WORD OF MOUTH HELP FOR TRADERS (BLOCK FORM)**. CRAIG W. PINNEY, (U.S. CLS. 100, 101 AND 104). SN 77-114,637. PUB. 7-31-2007. FILED 2-23-2007.
- 3,311,547. **CAMPAIGNBUILDER AND DESIGN**. MESSAGE LOGIX, INC., (U.S. CLS. 100, 101 AND 104). SN 77-117,158. PUB. 7-31-2007. FILED 2-27-2007.
- 3,311,599. **NATV (BLOCK FORM)**. NATIVE AMERICAN TELEVISION, INC., MULTIPLE CLASS, (INT. CLS. 38 AND 41), (U.S. CLS. 100, 101, 104 AND 107). SN 77-135,126. PUB. 7-31-2007. FILED 3-20-2007.
- 3,311,610. **SEAPORTAL (BLOCK FORM)**. FMR CORP., MULTIPLE CLASS, (INT. CLS. 38 AND 42), (U.S. CLS. 100, 101 AND 104). SN 77-149,251. PUB. 7-31-2007. FILED 4-5-2007.
- 3,311,626 (*See Class 9 for this trademark*).
- 3,311,651 (*See Class 9 for this trademark*).
- 3,311,668 (*See Class 9 for this trademark*).
- 3,311,687 (*See Class 9 for this trademark*).
- 3,311,715. **ENVOYCONNECT (BLOCK FORM)**. PAR3 COMMUNICATIONS, INC., (U.S. CLS. 100, 101 AND 104). SN 78-629,937. PUB. 7-31-2007. FILED 5-13-2005.
- 3,311,756. **THE STUDENT DOCTOR NETWORK (BLOCK FORM)**. COASTAL RESEARCH GROUP, MULTIPLE CLASS, (INT. CLS. 38 AND 41), (U.S. CLS. 100, 101, 104 AND 107). SN 78-683,680. PUB. 7-31-2007. FILED 8-2-2005.
- 3,311,797 (*See Class 37 for this trademark*).
- 3,311,908. **ITC INTERSTATE TELECOMMUNICATIONS COOPERATIVE, INC. LONG DISTANCE SIMPLE. HONEST. FLAT. AND DESIGN**. INTERSTATE TELECOMMUNICATIONS COOPERATIVE, INC., (U.S. CLS. 100, 101 AND 104). SN 78-797,133. PUB. 7-31-2007. FILED 1-23-2006.
- 3,312,124. **NICK AND DESIGN**. VIACOM INTERNATIONAL INC., (U.S. CLS. 100, 101 AND 104). SN 78-875,314. PUB. 7-31-2007. FILED 5-3-2006.
- 3,312,146. **PBX PARACHUTE (BLOCK FORM)**. VIRTUALPBX.COM, INC., (U.S. CLS. 100, 101 AND 104). SN 78-878,149. PUB. 7-31-2007. FILED 5-5-2006.
- 3,312,148. **BE LOCAL EVERYWHERE (BLOCK FORM)**. NEXO COMMUNICATIONS, LLC, (U.S. CLS. 100, 101 AND 104). SN 78-878,489. PUB. 7-31-2007. FILED 5-8-2006.
- 3,312,216. **VOPLACE (BLOCK FORM)**. IF BY PHONE LLC, MULTIPLE CLASS, (INT. CLS. 38 AND 41), (U.S. CLS. 100, 101, 104 AND 107). SN 78-887,044. PUB. 7-31-2007. FILED 5-18-2006.
- 3,312,221. **OKUSI (BLOCK FORM)**. PT. OKUSI JAYA, (U.S. CLS. 100, 101 AND 104). SN 78-887,463. PUB. 7-31-2007. FILED 5-19-2006.
- 3,312,242 (*See Class 35 for this trademark*).
- 3,312,381. **SPREAD4U (BLOCK FORM)**. 1338477 ONTARIO LIMITED O/A BLACK DOG UNLIMITED, (U.S. CLS. 100, 101 AND 104). SN 78-918,994. PUB. 7-31-2007. FILED 6-28-2006.
- 3,312,424. **FIELD CONNECT (BLOCK FORM)**. TWENTY FIRST CENTURY COMMUNICATIONS, INC., (U.S. CLS. 100, 101 AND 104). SN 78-924,538. PUB. 7-31-2007. FILED 7-7-2006.
- 3,312,445 (*See Class 35 for this trademark*).
- 3,312,480. **DCI VOICE SOLUTIONS AND DESIGN**. VOICE SOLUTIONS, LLC, (U.S. CLS. 100, 101 AND 104). SN 78-932,006. PUB. 7-31-2007. FILED 7-18-2006.
- 3,312,651. **STORYLINK YOUR CONNECTION TO CREATIVE SUCCESS AND DESIGN**. THE WRITERS COMPUTER STORE, MULTIPLE CLASS, (INT. CLS. 38 AND 39), (U.S. CLS. 100, 101, 104 AND 105). SN 78-966,099. PUB. 7-31-2007. FILED 9-1-2006.
- 3,312,660. **Q QUEPASA (STYLIZED)**. QUEPASA CORPORATION, MULTIPLE CLASS, (INT. CLS. 38, 41 AND 42), (U.S. CLS. 100, 101, 104 AND 107). SN 78-969,070. PUB. 7-31-2007. FILED 9-7-2006.
- 3,312,729 (*See Class 9 for this trademark*).
- 3,312,742 (*See Class 9 for this trademark*).
- 3,312,763 (*See Class 16 for this trademark*).
- 3,312,794 (*See Class 9 for this trademark*).
- 3,312,799 (*See Class 9 for this trademark*).
- 3,312,850 (*See Class 9 for this trademark*).
- 3,312,867 (*See Class 9 for this trademark*).
- 3,312,878 (*See Class 36 for this trademark*).
- 3,312,879 (*See Class 9 for this trademark*).
- 3,312,900. **FUNSPOT (STYLIZED)**. ACCEDO BROADBAND AB, MULTIPLE CLASS, (INT. CLS. 38 AND 41), (U.S. CLS. 100, 101, 104 AND 107). SN 79-030,188. PUB. 7-31-2007. FILED 5-29-2006.
- 3,312,901 (*See Class 9 for this trademark*).
- 3,312,910 (*See Class 9 for this trademark*).
- 3,312,946 (*See Class 9 for this trademark*).

CLASS 39—TRANSPORTATION AND STORAGE

- 3,310,190 (*See Class 38 for this trademark*).
- 3,310,194 (*See Class 38 for this trademark*).
- 3,310,218. **ISG AND DESIGN**. P.S. CLEARANCE CO., INC., (U.S. CLS. 100 AND 105). SN 76-339,351. PUB. 7-31-2007. FILED 11-16-2001.
- 3,310,238 (*See Class 35 for this trademark*).
- 3,310,256 (*See Class 35 for this trademark*).
- 3,310,341 (*See Class 35 for this trademark*).
- 3,310,358. **MISCELLANEOUS DESIGN**. MAMA JIM'S PIZZA, INC., (U.S. CLS. 100 AND 105). SN 76-666,423. PUB. 7-17-2007. FILED 9-21-2006.
- 3,310,566 (*See Class 4 for this trademark*).
- 3,310,575 (*See Class 4 for this trademark*).
- 3,310,603 (*See Class 16 for this trademark*).
- 3,310,728. **CHILE FOR LESS AND DESIGN**. SCHLEIEN,

- BERNARD ALBERTO, MULTIPLE CLASS, (INT. CLS. 39 AND 43), (U.S. CLS. 100, 101 AND 105). SN 77-051,468. PUB. 7-31-2007. FILED 11-27-2006.
- 3,310,747. **MEATHEAD MOVERS AND DESIGN**. MEATHEAD MOVERS, INC., (U.S. CLS. 100 AND 105). SN 77-054,130. PUB. 7-31-2007. FILED 11-30-2006.
- 3,310,755. **AIR COMPASSION FOR VETERANS AND DESIGN**. AIR COMPASSION AMERICA, (U.S. CLS. 100 AND 105). SN 77-054,759. PUB. 6-26-2007. FILED 12-1-2006.
- 3,310,764 (*See Class 1 for this trademark*).
- 3,310,770 (*See Class 9 for this trademark*).
- 3,310,781. **DRIVER SOLUTIONS (BLOCK FORM)**. DRIVER SOLUTIONS, INC., (U.S. CLS. 100 AND 105). SN 77-058,856. PUB. 7-31-2007. FILED 12-7-2006.
- 3,310,801 (*See Class 35 for this trademark*).
- 3,310,820. **RAMUNTO'S BRICK OVEN PIZZA AND DESIGN**. RAMKING, INC., MULTIPLE CLASS, (INT. CLS. 39 AND 43), (U.S. CLS. 100, 101 AND 105). SN 77-064,191. PUB. 7-31-2007. FILED 12-14-2006.
- 3,310,826. **CIRCLE OF LIGHT (BLOCK FORM)**. COMMUNITY UPLIFT MINISTRIES, (U.S. CLS. 100 AND 105). SN 77-064,640. PUB. 7-31-2007. FILED 12-14-2006.
- 3,310,948 (*See Class 37 for this trademark*).
- 3,310,967. **SPECTRUM SOLAR INNOVATIVE ENERGY AND DESIGN**. SPECTRUM SOLAR, LLC, (U.S. CLS. 100 AND 105). SN 77-071,410. PUB. 7-10-2007. FILED 12-26-2006.
- 3,310,999. **MEXICOACH (BLOCK FORM)**. CARLOS SANCHEZ DE LA PENA, (U.S. CLS. 100 AND 105). SN 77-072,294. PUB. 7-31-2007. FILED 12-27-2006.
- 3,311,000. **MEXICOACH (STYLIZED)**. CARLOS SANCHEZ DE LA PENA, (U.S. CLS. 100 AND 105). SN 77-072,300. PUB. 7-31-2007. FILED 12-27-2006.
- 3,311,055 (*See Class 37 for this trademark*).
- 3,311,115 (*See Class 37 for this trademark*).
- 3,311,301. **FORT STORAGE (BLOCK FORM)**. FORT STORAGE, LLC, (U.S. CLS. 100 AND 105). SN 77-091,337. PUB. 7-31-2007. FILED 1-25-2007.
- 3,311,315. **MISCELLANEOUS DESIGN**. ATLANTIC NATION-WIDE TRANSPORTATION SERVICES, INC., (U.S. CLS. 100 AND 105). SN 77-093,200. PUB. 7-17-2007. FILED 1-29-2007.
- 3,311,424. **C CENTRAL HOLIDAYS (STYLIZED)**. CENTRAL HOLIDAYS, INC., (U.S. CLS. 100 AND 105). SN 77-098,973. PUB. 7-31-2007. FILED 2-5-2007.
- 3,311,487. **RESCUE AND DESIGN**. RESCUE, INCORPORATED, (U.S. CLS. 100 AND 105). SN 77-103,432. PUB. 7-31-2007. FILED 2-9-2007.
- 3,311,511 (*See Class 35 for this trademark*).
- 3,311,525 (*See Class 35 for this trademark*).
- 3,311,663 (*See Class 9 for this trademark*).
- 3,311,716 (*See Class 35 for this trademark*).
- 3,311,731 (*See Class 9 for this trademark*).
- 3,311,735 (*See Class 35 for this trademark*).
- 3,311,758. **SWIFT (BLOCK FORM)**. SWIFT TRANSPORTATION CO., INC., (U.S. CLS. 100 AND 105). SN 78-684,537. PUB. 7-31-2007. FILED 8-3-2005.
- 3,311,771 (*See Class 16 for this trademark*).
- 3,311,806. **KINGS AND CORN (BLOCK FORM)**. CHUGACH ADVENTURE GUIDES, LLC, (U.S. CLS. 100 AND 105). SN 78-720,116. PUB. 7-31-2007. FILED 9-26-2005.
- 3,311,825. **ULTRA ALL-INCLUSIVE (BLOCK FORM)**. GORSTEW LIMITED, MULTIPLE CLASS, (INT. CLS. 39 AND 43), (U.S. CLS. 100, 101 AND 105). SN 78-731,689. PUB. 7-31-2007. FILED 10-12-2005.
- 3,311,847 (*See Class 16 for this trademark*).
- 3,311,868 (*See Class 25 for this trademark*).
- 3,311,889 (*See Class 35 for this trademark*).
- 3,311,894 (*See Class 35 for this trademark*).
- 3,311,903. **TAILORED TRAVEL (BLOCK FORM)**. TAILORED TRAVEL, L.L.C., (U.S. CLS. 100 AND 105). SN 78-793,225. PUB. 7-31-2007. FILED 1-17-2006.
- 3,311,929. **EXCELLENCE LUXURY CAR RENTAL AND DESIGN**. EXCELLENCE LUXURY CAR RENTAL, INC., (U.S. CLS. 100 AND 105). SN 78-807,645. PUB. 7-31-2007. FILED 2-6-2006.
- 3,311,970. **REGENT SEVEN SEAS CRUISES (STYLIZED)**. REGENT HOSPITALITY WORLDWIDE, INC., MULTIPLE CLASS, (INT. CLS. 39 AND 43), (U.S. CLS. 100, 101 AND 105). SN 78-834,357. PUB. 7-31-2007. FILED 3-10-2006.
- 3,311,971. **REGENT SEVEN SEAS CRUISES (BLOCK FORM)**. REGENT HOSPITALITY WORLDWIDE, INC., MULTIPLE CLASS, (INT. CLS. 39 AND 43), (U.S. CLS. 100, 101 AND 105). SN 78-834,362. PUB. 7-31-2007. FILED 3-10-2006.
- 3,311,976 (*See Class 36 for this trademark*).
- 3,312,002. **SHIPPERCENTRAL THE ONE SOURCE FOR ALL YOUR LOGISTICS NEEDS AND DESIGN**. SHIPPER CENTRAL, INC., (U.S. CLS. 100 AND 105). SN 78-847,655. PUB. 7-31-2007. FILED 3-28-2006.
- 3,312,037. **FLIGHT EXPRESS AND DESIGN**. KIRCHHOEFER, JOHN D., (U.S. CLS. 100 AND 105). SN 78-857,009. PUB. 7-31-2007. FILED 4-7-2006.
- 3,312,049 (*See Class 36 for this trademark*).
- 3,312,072 (*See Class 35 for this trademark*).
- 3,312,084 (*See Class 35 for this trademark*).
- 3,312,098. **MYMEDSAFE (BLOCK FORM)**. WEBSAFE, INC., (U.S. CLS. 100 AND 105). SN 78-872,464. PUB. 7-31-2007. FILED 4-28-2006.
- 3,312,270. **CARIBBEAN STAR AIRLINES (BLOCK FORM)**. STANFORD FINANCIAL GROUP COMPANY, (U.S. CLS. 100 AND 105). SN 78-898,980. PUB. 7-31-2007. FILED 6-2-2006.
- 3,312,332. **BIOSTORAGE LLC AND DESIGN**. BIOSTORAGE LLC, (U.S. CLS. 100 AND 105). SN 78-909,939. PUB. 7-31-2007. FILED 6-16-2006.
- 3,312,485. **MASON-DIXON RESCUE DOGS, INC. (BLOCK FORM)**. MASON-DIXON RESCUE DOGS, INC., (U.S. CLS. 100 AND 105). SN 78-932,967. PUB. 7-31-2007. FILED 7-19-2006.
- 3,312,491. **IGO CAR SHARING (STYLIZED)**. CENTER FOR NEIGHBORHOOD TECHNOLOGY, (U.S. CLS. 100 AND 105). SN 78-934,004. PUB. 7-31-2007. FILED 7-20-2006.
- 3,312,556. **BIG VAULT PORTABLE SECURE STORAGE (BLOCK FORM)**. TRUCK'N I, INC., DBA TRUCK AND I, (U.S. CLS. 100 AND 105). SN 78-947,299. PUB. 7-31-2007. FILED 8-8-2006.
- 3,312,597. **WWW.WORLDTRAVELVALUE.COM AND DESIGN**. WILLIAM CAMPBELL D/B/A/ LIFETIME COASTAL VACATIONS WORLDWIDE, (U.S. CLS. 100 AND 105). SN 78-958,217. PUB. 7-31-2007. FILED 8-23-2006.
- 3,312,651 (*See Class 38 for this trademark*).
- 3,312,662 (*See Class 35 for this trademark*).
- 3,312,688 (*See Class 36 for this trademark*).
- 3,312,712 (*See Class 1 for this trademark*).
- 3,312,763 (*See Class 16 for this trademark*).
- 3,312,933. **EUROFUN (BLOCK FORM)**. EUROFUN TOURISTIK GMBH, MULTIPLE CLASS, (INT. CLS. 39, 41 AND 43), (U.S. CLS. 100, 101, 105 AND 107). SN 79-032,580. PUB. 7-31-2007. FILED 8-29-2006.

CLASS 40—MATERIAL TREATMENT

- 3,310,232 (*See Class 1 for this trademark*).
- 3,310,234 (*See Class 1 for this trademark*).
- 3,310,325. **PRINTCOMINC. (STYLIZED)**. PRINTCOM, INC., (U.S. CLS. 100, 103 AND 106). SN 76-661,628. PUB. 7-10-2007. FILED 6-15-2006.
- 3,310,345. **H AND DESIGN**. HYPERION ENERGY, L.P., (U.S. CLS. 100, 103 AND 106). SN 76-663,937. PUB. 7-31-2007. FILED 8-1-2006.
- 3,310,428. **MISCELLANEOUS DESIGN**. OREGON ENVIRONMENTAL SYSTEMS, (U.S. CLS. 100, 103 AND 106). SN 77-000,343. PUB. 7-31-2007. FILED 9-15-2006.
- 3,310,449 (*See Class 37 for this trademark*).
- 3,310,522. **UVMAX (BLOCK FORM)**. DVUV, LLC, (U.S. CLS. 100, 103 AND 106). SN 77-016,758. PUB. 7-31-2007. FILED 10-9-2006.
- 3,310,537 (*See Class 35 for this trademark*).
- 3,310,590 (*See Class 35 for this trademark*).
- 3,310,616 (*See Class 35 for this trademark*).
- 3,310,669. **"BATTERIES ARE CHEAP. REPLACING THEM ISN'T!" (BLOCK FORM)**. WISPI.NET, INC., MULTIPLE CLASS, (INT. CLS. 40 AND 42), (U.S. CLS. 100, 101, 103 AND 106). SN 77-042,425. PUB. 7-31-2007. FILED 11-13-2006.
- 3,310,709. **METALLIFE AND DESIGN**. BADGER METAL

TECH, INC., (U.S. CLS. 100, 103 AND 106). SN 77-049,016. PUB. 7-10-2007. FILED 11-21-2006.

3,310,713 (*See Class 35 for this trademark.*).

3,310,764 (*See Class 1 for this trademark.*).

3,310,770 (*See Class 9 for this trademark.*).

3,310,875. **E ELECTRONIC RECYCLERS AND DESIGN.** ELECTRONIC RECYCLERS INTERNATIONAL, INC., (U.S. CLS. 100, 103 AND 106). SN 77-067,931. PUB. 7-31-2007. FILED 12-19-2006.

3,310,906. **S.F.V.I.S.B.F. (STYLIZED).** LOGAN, CHAD J., (U.S. CLS. 100, 103 AND 106). SN 77-069,151. PUB. 7-31-2007. FILED 12-21-2006.

3,310,916. **CO-PRO (BLOCK FORM).** D.B. GROGAN ASSOCIATES, LLC, (U.S. CLS. 100, 103 AND 106). SN 77-069,579. PUB. 7-31-2007. FILED 12-21-2006.

3,310,918. **CO-PRO: ELECTRICITY BY DAY, TRANSPORTATION FUELS BY NIGHT. (BLOCK FORM).** D.B. GROGAN ASSOCIATES, LLC, (U.S. CLS. 100, 103 AND 106). SN 77-069,602. PUB. 7-31-2007. FILED 12-21-2006.

3,311,092. **INTEPROD (BLOCK FORM).** INTEPROD LLC, (U.S. CLS. 100, 103 AND 106). SN 77-074,221. PUB. 7-31-2007. FILED 1-2-2007.

3,311,147. **LUMISMILE (BLOCK FORM).** DEN-MAT CORPORATION, (U.S. CLS. 100, 103 AND 106). SN 77-077,076. PUB. 7-31-2007. FILED 1-5-2007.

3,311,160 (*See Class 37 for this trademark.*).

3,311,309. **EFORMANCE (BLOCK FORM).** HARRINGTON, PERRY E, (U.S. CLS. 100, 103 AND 106). SN 77-092,403. PUB. 7-31-2007. FILED 1-26-2007.

3,311,336 (*See Class 37 for this trademark.*).

3,311,363. **AMA (STYLIZED).** ABBATE, ANTHONY, (U.S. CLS. 100, 103 AND 106). SN 77-096,698. PUB. 7-31-2007. FILED 2-1-2007.

3,311,488. **ROADSIDEINKX (BLOCK FORM).** ROADSIDE WERX, L.L.C., (U.S. CLS. 100, 103 AND 106). SN 77-103,508. PUB. 7-31-2007. FILED 2-9-2007.

3,311,511 (*See Class 35 for this trademark.*).

3,311,525 (*See Class 35 for this trademark.*).

3,311,759 (*See Class 7 for this trademark.*).

3,311,773 (*See Class 12 for this trademark.*).

3,311,780. **THE COLORHAUS (BLOCK FORM).** E.P. GRAPHICS, INC., (U.S. CLS. 100, 103 AND 106). SN 78-699,782. PUB. 7-31-2007. FILED 8-24-2005.

3,311,816 (*See Class 6 for this trademark.*).

3,311,821 (*See Class 9 for this trademark.*).

3,311,865 (*See Class 19 for this trademark.*).

3,311,917. **IMAGE GRAFIX AND DESIGN.** IMAGE GRAFIX, LLC, (U.S. CLS. 100, 103 AND 106). SN 78-801,556. PUB. 7-31-2007. FILED 1-28-2006.

3,311,951 (*See Class 35 for this trademark.*).

3,311,952 (*See Class 35 for this trademark.*).

3,311,953 (*See Class 35 for this trademark.*).

3,311,989 (*See Class 9 for this trademark.*).

3,312,168 (*See Class 1 for this trademark.*).

3,312,185 (*See Class 9 for this trademark.*).

3,312,235 (*See Class 25 for this trademark.*).

3,312,344 (*See Class 20 for this trademark.*).

3,312,431. **THERMO-STONE (BLOCK FORM).** THERMO-STONE USA, LLC, (U.S. CLS. 100, 103 AND 106). SN 78-926,253. PUB. 7-31-2007. FILED 7-10-2006.

3,312,469 (*See Class 37 for this trademark.*).

3,312,498. **EXPERTINT GLASS TINTING EXPERTS AND DESIGN.** DAUGHERTY, P. NORMAN, AND DAUGHERTY, TONYA, (U.S. CLS. 100, 103 AND 106). SN 78-935,863. PUB. 7-31-2007. FILED 7-24-2006.

3,312,502 (*See Class 37 for this trademark.*).

3,312,588 (*See Class 35 for this trademark.*).

3,312,702 (*See Class 16 for this trademark.*).

3,312,712 (*See Class 1 for this trademark.*).

3,312,724 (*See Class 6 for this trademark.*).

3,312,725 (*See Class 6 for this trademark.*).

3,312,808 (*See Class 17 for this trademark.*).

3,312,829 (*See Class 9 for this trademark.*).

3,312,857 (*See Class 11 for this trademark.*).

3,312,905 (*See Class 9 for this trademark.*).

3,312,912 (*See Class 7 for this trademark.*).

3,312,953 (*See Class 1 for this trademark.*).

CLASS 41—EDUCATION AND ENTERTAINMENT

3,310,192. **KRAV MAGA.** KRAV MAGA ASSOCIATION OF AMERICA, INC., (U.S. CLS. 100, 101 AND 107). SN 75-493,869. PUB. 10-26-2004. FILED 6-1-1998.

3,310,200 (*See Class 9 for this trademark.*).

3,310,204 (*See Class 3 for this trademark.*).

3,310,214. **ENGENUITY TECHNOLOGIES AND DESIGN.** ENGENUITY TECHNOLOGIES, INC., MULTIPLE CLASS, (INT. CLS. 41 AND 42), (U.S. CLS. 100, 101 AND 107). SN 76-283,953. PUB. 7-31-2007. FILED 7-12-2001.

3,310,233. **S.O.B. AND DESIGN.** BROOKS, FRAN S., (U.S. CLS. 100, 101 AND 107). SN 76-543,950. PUB. 7-31-2007. FILED 9-10-2003.

3,310,237 (*See Class 9 for this trademark.*).

3,310,246. **MEDIA STAGE (BLOCK FORM).** MEDIA STAGE, INC., (U.S. CLS. 100, 101 AND 107). SN 76-617,672. PUB. 7-31-2007. FILED 10-22-2004.

3,310,249 (*See Class 9 for this trademark.*).

3,310,255 (*See Class 9 for this trademark.*).

3,310,256 (*See Class 35 for this trademark.*).

3,310,258 (*See Class 9 for this trademark.*).

3,310,260 (*See Class 10 for this trademark.*).

3,310,261. **WICHITA THUNDER (BLOCK FORM).** K.H., L.L.C., (U.S. CLS. 100, 101 AND 107). SN 76-644,520. PUB. 4-10-2007. FILED 8-8-2005.

3,310,269. **HELP PROGRAM HELP PROGRAM TEACHING MATH TO ENGLISH LANGUAGE LEARNERS AND DESIGN.** DIGITAL DIRECTIONS INTERNATIONAL, INC., (U.S. CLS. 100, 101 AND 107). SN 76-648,588. PUB. 7-31-2007. FILED 10-17-2005.

3,310,295 (*See Class 16 for this trademark.*).

3,310,296 (*See Class 16 for this trademark.*).

3,310,297 (*See Class 16 for this trademark.*).

3,310,298 (*See Class 16 for this trademark.*).

3,310,299 (*See Class 16 for this trademark.*).

3,310,329 (*See Class 35 for this trademark.*).

3,310,332. **PEO IWS PROGRAM EXECUTIVE OFFICE INTEGRATED WARFARE SYSTEMS AND DESIGN.** DEPARTMENT OF DEFENSE, UNITED STATES NAVY, PROGRAM EXECUTIVE OFFICE INTEGRATED WARFARE SYSTEMS, MULTIPLE CLASS, (INT. CLS. 41 AND 42), (U.S. CLS. 100, 101 AND 107). SN 76-662,755. PUB. 7-31-2007. FILED 7-10-2006.

3,310,341 (*See Class 35 for this trademark.*).

3,310,357. **MODELQUETTE AND DESIGN.** WATKINS, INGA, (U.S. CLS. 100, 101 AND 107). SN 76-666,212. PUB. 7-31-2007. FILED 9-18-2006.

3,310,372 (*See Class 35 for this trademark.*).

3,310,376. **NAUGHTY BY NATURE (BLOCK FORM).** BROWN, VINCENT, (U.S. CLS. 100, 101 AND 107). SN 76-668,735. PUB. 7-31-2007. FILED 11-8-2006.

3,310,385. **KELEE (BLOCK FORM).** RATHBUN, RONALD W., (U.S. CLS. 100, 101 AND 107). SN 76-669,505. PUB. 7-31-2007. FILED 11-24-2006.

3,310,388. **LIVE YOUR YEAR (STYLIZED).** WOODARD PHOTOGRAPHIC, INC., (U.S. CLS. 100, 101 AND 107). SN 76-670,177. PUB. 7-31-2007. FILED 12-11-2006.

3,310,391. **OBEDIENCE WORKS, LLC DOG AND OWNER TRAINING AND DESIGN.** OBEDIENCE WORKS, LLC, (U.S. CLS. 100, 101 AND 107). SN 76-670,390. PUB. 7-10-2007. FILED 12-15-2006.

3,310,395. **LEAK CITY (BLOCK FORM).** CITY OF ATHENS UTILITIES GAS DEPARTMENT, (U.S. CLS. 100, 101 AND 107). SN 76-670,547. PUB. 7-31-2007. FILED 12-19-2006.

3,310,399. **XPEDIENTE (BLOCK FORM).** SPANISH BROADCASTING SYSTEM, INC., (U.S. CLS. 100, 101 AND 107). SN 76-670,755. PUB. 7-31-2007. FILED 12-26-2006.

3,310,400. **RAICES Y RECUERDOS (BLOCK FORM).** SPANISH BROADCASTING SYSTEM, INC., (U.S. CLS. 100, 101 AND 107). SN 76-670,757. PUB. 7-31-2007. FILED 12-26-2006.

3,310,401. **WE ARE I (BLOCK FORM).** CHAMBERLAND, RICHARD, AND STAPLES, JOHN B., (U.S. CLS. 100, 101 AND 107). SN 76-670,760. PUB. 7-31-2007. FILED 12-26-2006.

3,310,403. **PUERTA ASTRAL (BLOCK FORM).** SPANISH BROADCASTING SYSTEM, INC., (U.S. CLS. 100, 101 AND 107). SN 76-670,798. PUB. 7-31-2007. FILED 12-26-2006.

3,310,421. **MUSTANG (BLOCK FORM).** TALISKER MOUN-

- TAIN INCORPORATED, (U.S. CLS. 100, 101 AND 107). SN 76-672,969. PUB. 7-31-2007. FILED 2-21-2007.
- 3,310,422 (*See Class 16 for this trademark*).
- 3,310,424. **TIME WISE PRINCIPLES OF LEAN MANUFACTURING FOR PROCESS INDUSTRIES (BLOCK FORM)**. TIME WISE SOLUTIONS, LLC., (U.S. CLS. 100, 101 AND 107). SN 76-674,391. PUB. 7-31-2007. FILED 3-22-2007.
- 3,310,435 (*See Class 36 for this trademark*).
- 3,310,436 (*See Class 36 for this trademark*).
- 3,310,440. **MISCELLANEOUS DESIGN**. BR CONSULTING, INC., (U.S. CLS. 100, 101 AND 107). SN 77-002,606. PUB. 7-31-2007. FILED 9-19-2006.
- 3,310,444 (*See Class 35 for this trademark*).
- 3,310,452. **PACIFIC SHIPPER (BLOCK FORM)**. COMMONWEALTH BUSINESS MEDIA, INC., (U.S. CLS. 100, 101 AND 107). SN 77-004,569. PUB. 7-31-2007. FILED 9-21-2006.
- 3,310,492. **YARDFLEX (BLOCK FORM)**. COLE, DEBORAH, (U.S. CLS. 100, 101 AND 107). SN 77-011,756. PUB. 7-31-2007. FILED 10-2-2006.
- 3,310,497. **WE ARE ALL SEARCH ENGINES (BLOCK FORM)**. REGENTS OF THE UNIVERSITY OF MINNESOTA, (U.S. CLS. 100, 101 AND 107). SN 77-012,735. PUB. 7-31-2007. FILED 10-4-2006.
- 3,310,500 (*See Class 36 for this trademark*).
- 3,310,505. **GOOD MOOD DIET (BLOCK FORM)**. KLEINER, SUSAN M., (U.S. CLS. 100, 101 AND 107). SN 77-013,886. PUB. 7-31-2007. FILED 10-4-2006.
- 3,310,517. **WHERE ELSE CAN ONE WEEK LAST A LIFE-TIME? (BLOCK FORM)**. ACCELERATED CHRISTIAN EDUCATION, INC., (U.S. CLS. 100, 101 AND 107). SN 77-016,203. PUB. 7-31-2007. FILED 10-6-2006.
- 3,310,518. **7|22 (STYLIZED)**. NORTH POINT MINISTRIES, INC., (U.S. CLS. 100, 101 AND 107). SN 77-016,210. PUB. 7-31-2007. FILED 10-6-2006.
- 3,310,524. **DC DIET COMMUNICATIONS AND DESIGN**. ARAMAKI, ASAKO, MULTIPLE CLASS, (INT. CLS. 41 AND 44), (U.S. CLS. 100, 101 AND 107). SN 77-016,869. PUB. 7-31-2007. FILED 10-9-2006.
- 3,310,530. **MISCELLANEOUS DESIGN**. TRUE COMPANIONS OF NY, INC., MULTIPLE CLASS, (INT. CLS. 41 AND 43), (U.S. CLS. 100, 101 AND 107). SN 77-017,592. PUB. 7-31-2007. FILED 10-10-2006.
- 3,310,532. **ON THE JOB (BLOCK FORM)**. SERGEANTS BENEVOLENT ASSOCIATION, INC., (U.S. CLS. 100, 101 AND 107). SN 77-017,850. PUB. 6-12-2007. FILED 10-10-2006.
- 3,310,534. **U USA GYMNASTICS UNIVERSITY EST. 2004 EXCELLENCE THROUGH EDUCATION AND DESIGN**. UNITED STATES GYMNASTICS FEDERATION, (U.S. CLS. 100, 101 AND 107). SN 77-017,989. PUB. 7-31-2007. FILED 10-10-2006.
- 3,310,537 (*See Class 35 for this trademark*).
- 3,310,552. **UNIVERSITY INSTRUCTORS, UNIVERSITY INSTRUCTORS APPROVED OFFICIAL DOCUMENT AND DESIGN**. UNIVERSITY INSTRUCTORS, INC, (U.S. CLS. 100, 101 AND 107). SN 77-021,178. PUB. 7-31-2007. FILED 10-13-2006.
- 3,310,554. **RECONNECTING THE CIRCLE (BLOCK FORM)**. RECONNECTING THE CIRCLE, INC., (U.S. CLS. 100, 101 AND 107). SN 77-021,432. PUB. 7-31-2007. FILED 10-15-2006.
- 3,310,565. **B A S K O W AND ASSOCIATES AND DESIGN**. JAKI BASKOW, (U.S. CLS. 100, 101 AND 107). SN 77-023,793. PUB. 7-31-2007. FILED 10-18-2006.
- 3,310,569. **GPS-FAST 3D CERTIFIED AND DESIGN**. WEIR, VICTORIA LEE, (U.S. CLS. 100, 101 AND 107). SN 77-024,483. PUB. 7-31-2007. FILED S.R. 10-18-2006; AM. P.R. 5-7-2007.
- 3,310,578. **CLOWN U (BLOCK FORM)**. FEDERATED DEPARTMENT STORES, INC., (U.S. CLS. 100, 101 AND 107). SN 77-025,704. PUB. 7-10-2007. FILED 10-20-2006.
- 3,310,582. **RANCHO FOLCLÓRICO "À PORTUGUESA" (BLOCK FORM)**. ADRIAN NOBRE SIMÕES, (U.S. CLS. 100, 101 AND 107). SN 77-026,465. PUB. 7-31-2007. FILED 10-20-2006.
- 3,310,594 (*See Class 35 for this trademark*).
- 3,310,600. **MISCELLANEOUS DESIGN**. FINE, TINA, (U.S. CLS. 100, 101 AND 107). SN 77-029,765. PUB. 7-31-2007. FILED 10-26-2006.
- 3,310,603 (*See Class 16 for this trademark*).
- 3,310,606. **ST TVI AND DESIGN**. GOLDEN PRODUCTION, INC., (U.S. CLS. 100, 101 AND 107). SN 77-030,840. PUB. 7-31-2007. FILED 10-27-2006.
- 3,310,612. **"RADIO YOU CAN SEE" (BLOCK FORM)**. LEWIS, MICHAEL, (U.S. CLS. 100, 101 AND 107). SN 77-032,120. PUB. 7-31-2007. FILED 10-30-2006.
- 3,310,618 (*See Class 16 for this trademark*).
- 3,310,620. **BODY CONCEPTS A FITNESS & TANNING STUDIO FOR WOMEN HEALTH . FITNESS . LIFESTYLE AND DESIGN**. BODY CONCEPTS FITNESS STUDIO, INC., (U.S. CLS. 100, 101 AND 107). SN 77-033,065. PUB. 7-31-2007. FILED 10-31-2006.
- 3,310,623. **SMILE YOGA (BLOCK FORM)**. PARK JAE WOO, MULTIPLE CLASS, (INT. CLS. 41 AND 44), (U.S. CLS. 100, 101 AND 107). SN 77-033,993. PUB. 7-31-2007. FILED 11-1-2006.
- 3,310,628. **BIG PICTURE TV (BLOCK FORM)**. MORRELL, MARCUS, (U.S. CLS. 100, 101 AND 107). SN 77-035,466. PUB. 7-31-2007. FILED 11-2-2006.
- 3,310,638. **LOCALNEWS1 (BLOCK FORM)**. LOCALNEWS, LLC, (U.S. CLS. 100, 101 AND 107). SN 77-037,517. PUB. 7-31-2007. FILED 11-6-2006.
- 3,310,644. **SHINNY USA (BLOCK FORM)**. SHINNY USA, INC., (U.S. CLS. 100, 101 AND 107). SN 77-038,279. PUB. 7-31-2007. FILED 11-7-2006.
- 3,310,645. **SHINNY USA AND DESIGN**. SHINNY USA, INC., (U.S. CLS. 100, 101 AND 107). SN 77-038,281. PUB. 7-31-2007. FILED 11-7-2006.
- 3,310,646. **SHINNY AND DESIGN**. SHINNY USA, INC., (U.S. CLS. 100, 101 AND 107). SN 77-038,282. PUB. 7-31-2007. FILED 11-7-2006.
- 3,310,648 (*See Class 9 for this trademark*).
- 3,310,653. **DAIKAIJU (BLOCK FORM)**. MITRA, SANTANU, (U.S. CLS. 100, 101 AND 107). SN 77-039,149. PUB. 7-31-2007. FILED 11-7-2006.
- 3,310,657. **MISCELLANEOUS DESIGN**. CAKE, LLC, MULTIPLE CLASS, (INT. CLS. 41 AND 42), (U.S. CLS. 100, 101 AND 107). SN 77-040,386. PUB. 7-17-2007. FILED 11-9-2006.
- 3,310,667. **DEFENSIVE EDGE MARTIAL ARTS ACADEMY SMALL CIRCLE JUJITSU BRAZILIAN JIU-JITSU AND DESIGN**. ALFORD, ARTHUR RICHARD III, (U.S. CLS. 100, 101 AND 107). SN 77-041,906. PUB. 7-31-2007. FILED S.R. 11-10-2006; AM. P.R. 5-21-2007.
- 3,310,671. **FUN SPOT USA (BLOCK FORM)**. SKYCOASTER OF FLORIDA, LLC, (U.S. CLS. 100, 101 AND 107). SN 77-042,508. PUB. 7-31-2007. FILED 11-13-2006.
- 3,310,677. **MOVIE YOGA (BLOCK FORM)**. SPARKS, AUGUSTUS O.B. III, (U.S. CLS. 100, 101 AND 107). SN 77-043,922. PUB. 7-31-2007. FILED 11-14-2006.
- 3,310,688. **GREENE COUNTY ONLINE (BLOCK FORM)**. GREENEVILLE PUBLISHING COMPANY, LLC., (U.S. CLS. 100, 101 AND 107). SN 77-046,427. PUB. 7-31-2007. FILED 11-17-2006.
- 3,310,689. **HPT MAGAZINE AND DESIGN**. MEDIA PUBLISHING HOUSE, LLC, (U.S. CLS. 100, 101 AND 107). SN 77-046,433. PUB. 7-31-2007. FILED 11-17-2006.
- 3,310,695 (*See Class 35 for this trademark*).
- 3,310,697. **NEWSLAUGH (BLOCK FORM)**. ATTEA, THOMAS CHARLES, (U.S. CLS. 100, 101 AND 107). SN 77-047,806. PUB. 7-31-2007. FILED 11-20-2006.
- 3,310,706. **ARTS AWARDS AND DESIGN**. WTC-TRADE MART, L.P., (U.S. CLS. 100, 101 AND 107). SN 77-048,727. PUB. 7-31-2007. FILED 11-21-2006.
- 3,310,726. **MISCELLANEOUS DESIGN**. EXTENSION FOUNDATION, (U.S. CLS. 100, 101 AND 107). SN 77-051,139. PUB. 7-31-2007. FILED 11-27-2006.
- 3,310,729. **THE ARMORY BRAZILIAN JIU JITSU & GRAPPLING TRAINING CENTER AND DESIGN**. IRIMINAGE, INC, (U.S. CLS. 100, 101 AND 107). SN 77-051,501. PUB. 7-17-2007. FILED 11-27-2006.
- 3,310,733. **MUSIC LESSONS ON WHEELS (BLOCK FORM)**. MUSIC LESSONS ON WHEELS, LLC, (U.S. CLS. 100, 101 AND 107). SN 77-052,423. PUB. 7-31-2007. FILED 11-28-2006.
- 3,310,737. **CRINGE (BLOCK FORM)**. SARAH BROWN, (U.S. CLS. 100, 101 AND 107). SN 77-053,339. PUB. 7-31-2007. FILED 11-29-2006.
- 3,310,743. **ONLY THE INSPIRED CAN INSPIRE (BLOCK FORM)**. PIPPIG, UTA, MULTIPLE CLASS, (INT. CLS. 41,

- 44 AND 45), (U.S. CLS. 100, 101 AND 107). SN 77-053,772. PUB. 7-31-2007. FILED 11-30-2006.
- 3,310,757 (*See Class 35 for this trademark*).
- 3,310,759. **H AND DESIGN. THE HARKER SCHOOL**, (U.S. CLS. 100, 101 AND 107). SN 77-055,643. PUB. 7-31-2007. FILED 12-1-2006.
- 3,310,761. **OPTIMAL WELLNESS AND BODY SCULPTING AND DESIGN. OPTIMAL WELLNESS AND BODY SCULPTING, INC.**, (U.S. CLS. 100, 101 AND 107). SN 77-055,948. PUB. 7-31-2007. FILED 12-3-2006.
- 3,310,768. **BAY FIREWORKS (BLOCK FORM). PYRO ENGINEERING, INC.**, (U.S. CLS. 100, 101 AND 107). SN 77-056,662. PUB. 7-31-2007. FILED 12-4-2006.
- 3,310,770 (*See Class 9 for this trademark*).
- 3,310,787 (*See Class 16 for this trademark*).
- 3,310,788. **MS. HEDONISM (BLOCK FORM). VRL INTERNATIONAL LTD.**, (U.S. CLS. 100, 101 AND 107). SN 77-060,498. PUB. 7-31-2007. FILED 12-8-2006.
- 3,310,789. **8TH STREET LATINAS (BLOCK FORM). RK NETMEDIA, INC.**, (U.S. CLS. 100, 101 AND 107). SN 77-060,500. PUB. 7-31-2007. FILED 12-8-2006.
- 3,310,797. **LIBERTY INSIDER (BLOCK FORM). THREE ANGELS BROADCASTING NETWORK, INC.**, (U.S. CLS. 100, 101 AND 107). SN 77-060,965. PUB. 7-31-2007. FILED 12-11-2006.
- 3,310,829. **CHAMPIONS ACADEMY (BLOCK FORM). CHAMPIONS ACADEMY, INC.**, (U.S. CLS. 100, 101 AND 107). SN 77-064,973. PUB. 7-31-2007. FILED 12-15-2006.
- 3,310,836. **PRECUSSIONS (BLOCK FORM). O'KEEFE, MILES J., AND HAWTHORNE, RICHARD C., AND O'KEEFE, JULES**, (U.S. CLS. 100, 101 AND 107). SN 77-065,638. PUB. 7-31-2007. FILED 12-15-2006.
- 3,310,837. **PARLOR RECORDS AND DESIGN. THE PROTOCOL**, (U.S. CLS. 100, 101 AND 107). SN 77-065,664. PUB. 7-31-2007. FILED 12-15-2006.
- 3,310,838. **BANG BUS AND DESIGN. OX IDEAS, INC.**, (U.S. CLS. 100, 101 AND 107). SN 77-065,679. PUB. 7-31-2007. FILED 12-15-2006.
- 3,310,847. **ACROYOGA (BLOCK FORM). ACROYOGA, INC.**, (U.S. CLS. 100, 101 AND 107). SN 77-066,872. PUB. 7-31-2007. FILED 12-18-2006.
- 3,310,849. **VOXFOX (BLOCK FORM). CINDY MILLIGAN**, (U.S. CLS. 100, 101 AND 107). SN 77-067,180. PUB. 7-31-2007. FILED 12-19-2006.
- 3,310,860. **RETRO IN THE METRO (BLOCK FORM). CBS RADIO EAST INC.**, (U.S. CLS. 100, 101 AND 107). SN 77-067,624. PUB. 7-31-2007. FILED 12-19-2006.
- 3,310,862. **ART SMART ADVENTURES (BLOCK FORM). ART SMART ADVENTURES INC.**, (U.S. CLS. 100, 101 AND 107). SN 77-067,653. PUB. 7-31-2007. FILED 12-19-2006.
- 3,310,865. **WE WORK (BLOCK FORM). CLEVELAND VOCATIONAL INDUSTRIES, INC.**, (U.S. CLS. 100, 101 AND 107). SN 77-067,718. PUB. 7-31-2007. FILED 12-19-2006.
- 3,310,880 (*See Class 25 for this trademark*).
- 3,310,885. **PERSONAL CARE MANAGEMENT AND DESIGN. MEDCOST, LLC**, (U.S. CLS. 100, 101 AND 107). SN 77-068,436. PUB. 7-31-2007. FILED 12-20-2006.
- 3,310,893. **ODDS ARE, YOU'RE GONNA LOVE IT HERE (BLOCK FORM). RIH ACQUISITIONS NJ, LLC**, (U.S. CLS. 100, 101 AND 107). SN 77-068,676. PUB. 7-31-2007. FILED 12-20-2006.
- 3,310,898. **TANTSU (BLOCK FORM). DULL, HAROLD**, (U.S. CLS. 100, 101 AND 107). SN 77-068,917. PUB. 7-31-2007. FILED 12-20-2006.
- 3,310,899. **WORLDCONENSEMBLE (BLOCK FORM). GARDNER, KATE**, (U.S. CLS. 100, 101 AND 107). SN 77-069,067. PUB. 7-31-2007. FILED 12-21-2006.
- 3,310,901. **HEALTHWORKS: A WORKSITE WELLNESS PROGRAM (BLOCK FORM). BAPTIST HEALTHCARE SYSTEM, INC.**, MULTIPLE CLASS, (INT. CLS. 41 AND 44), (U.S. CLS. 100, 101 AND 107). SN 77-069,080. PUB. 7-31-2007. FILED 12-21-2006.
- 3,310,902. **F FITNESS RX AND DESIGN. FITNESS RX, INC.**, (U.S. CLS. 100, 101 AND 107). SN 77-069,096. PUB. 7-31-2007. FILED 12-21-2006.
- 3,310,915. **THE SEVEN INTELLIGENCES OF LEADERSHIP (BLOCK FORM). ENLIGHTENMENT, INC.**, (U.S. CLS. 100, 101 AND 107). SN 77-069,478. PUB. 7-31-2007. FILED 12-21-2006.
- 3,310,934 (*See Class 38 for this trademark*).
- 3,310,950 (*See Class 35 for this trademark*).
- 3,310,959 (*See Class 35 for this trademark*).
- 3,310,960. **SLICKFORCE (BLOCK FORM). SLICKFORCE ENTERTAINMENT LLC**, (U.S. CLS. 100, 101 AND 107). SN 77-071,114. PUB. 7-31-2007. FILED 12-25-2006.
- 3,310,968. **SISTERS YOGA (BLOCK FORM). SISTERS YOGA, LLC**, (U.S. CLS. 100, 101 AND 107). SN 77-071,411. PUB. 7-31-2007. FILED 12-26-2006.
- 3,310,974. **211 (BLOCK FORM). OGUDE, CHUKUMA MARCEL**, (U.S. CLS. 100, 101 AND 107). SN 77-071,672. PUB. 7-31-2007. FILED 12-27-2006.
- 3,310,986. **AMERICA'S RACIN' VACATION (BLOCK FORM). INTERNATIONAL MOTOR CONTEST ASSOCIATION, INC.**, (U.S. CLS. 100, 101 AND 107). SN 77-072,051. PUB. 7-31-2007. FILED 12-27-2006.
- 3,311,002. **GRADTRAK (BLOCK FORM). BOB KNIGHT PHOTOMARKETING, INC.**, (U.S. CLS. 100, 101 AND 107). SN 77-072,385. PUB. 7-31-2007. FILED 12-28-2006.
- 3,311,003. **A CASINO FOCUSED ON GAMBLING. IMAGINE THAT. (BLOCK FORM). RIH ACQUISITIONS NJ, LLC**, (U.S. CLS. 100, 101 AND 107). SN 77-072,388. PUB. 7-31-2007. FILED 12-28-2006.
- 3,311,004. **KIDS PLAY GAMES. GROWNUPS GAMBLE. (BLOCK FORM). RIH ACQUISITIONS NJ, LLC**, (U.S. CLS. 100, 101 AND 107). SN 77-072,394. PUB. 7-31-2007. FILED 12-28-2006.
- 3,311,005. **A BETTOR PLACE TO GAMBLE. (BLOCK FORM). RIH ACQUISITIONS NJ, LLC**, (U.S. CLS. 100, 101 AND 107). SN 77-072,396. PUB. 7-31-2007. FILED 12-28-2006.
- 3,311,011. **IT'S EASY HERE. (BLOCK FORM). RIH ACQUISITIONS MS I, LLC**, (U.S. CLS. 100, 101 AND 107). SN 77-072,440. PUB. 7-31-2007. FILED 12-28-2006.
- 3,311,014. **PINK KITTY STUDIOS (BLOCK FORM). ADRIENNE CRAGNOTTI AND LORI MANN**, (U.S. CLS. 100, 101 AND 107). SN 77-072,494. PUB. 7-31-2007. FILED 12-28-2006.
- 3,311,017. **TAKE IT OUTSIDE (BLOCK FORM). HEALTHWORKS FITNESS FOR WOMEN, LLC**, (U.S. CLS. 100, 101 AND 107). SN 77-072,502. PUB. 7-31-2007. FILED 12-28-2006.
- 3,311,027 (*See Class 35 for this trademark*).
- 3,311,040. **THE FAR BOOTCAMP (BLOCK FORM). VERNON J. EDWARDS, CONSULTANT, LLC**, (U.S. CLS. 100, 101 AND 107). SN 77-073,083. PUB. 7-31-2007. FILED 12-29-2006.
- 3,311,041. **SFA (BLOCK FORM). MADEJ, MALGORZATA**, (U.S. CLS. 100, 101 AND 107). SN 77-073,093. PUB. 7-31-2007. FILED 12-29-2006.
- 3,311,042. **SFI (BLOCK FORM). MADEJ, MALGORZATA**, (U.S. CLS. 100, 101 AND 107). SN 77-073,121. PUB. 7-31-2007. FILED 12-29-2006.
- 3,311,049. **SPLOOFUS (BLOCK FORM). MORTON, JUSTIN W.**, (U.S. CLS. 100, 101 AND 107). SN 77-073,301. PUB. 7-31-2007. FILED 12-29-2006.
- 3,311,070. **SOFTWARENESS (BLOCK FORM). SOFTWARENESS, MULTIPLE CLASS, (INT. CLS. 41 AND 42)**, (U.S. CLS. 100, 101 AND 107). SN 77-073,762. PUB. 7-31-2007. FILED 12-30-2006.
- 3,311,076. **NOROMIS (BLOCK FORM). SMARTPHOTOLAB, LLC, DBA NOROMIS**, (U.S. CLS. 100, 101 AND 107). SN 77-073,907. PUB. 7-31-2007. FILED 12-31-2006.
- 3,311,077. **MISCELLANEOUS DESIGN. SMARTPHOTOLAB, LLC D/B/A NOROMIS**, (U.S. CLS. 100, 101 AND 107). SN 77-073,908. PUB. 7-31-2007. FILED 12-31-2006.
- 3,311,078. **CONSCIOUS CONFLICT CONNOISSEURS (BLOCK FORM). JOHN R. SHORDIKE**, (U.S. CLS. 100, 101 AND 107). SN 77-073,921. PUB. 7-31-2007. FILED 12-31-2006.
- 3,311,079. **FIGHTING OUR WAY TO ENLIGHTENMENT (BLOCK FORM). JOHN R. SHORDIKE**, (U.S. CLS. 100, 101 AND 107). SN 77-073,924. PUB. 7-31-2007. FILED 12-31-2006.
- 3,311,080. **MAKING PEACE WITH YOUR LIFE ONE CONFLICT AT A TIME (BLOCK FORM). JOHN R. SHORDIKE**, (U.S. CLS. 100, 101 AND 107). SN 77-073,929. PUB. 7-31-2007. FILED 12-31-2006.
- 3,311,094. **BEANSPROUTS AND DESIGN. BEANSPROUTS INC. OF BROOKLYN**, (U.S. CLS. 100, 101 AND 107). SN 77-074,289. PUB. 7-31-2007. FILED 1-2-2007.
- 3,311,101. **MEDTEX MEDICAL CORPORATION AND DE-**

- SIGN. MEDTEXX MEDICAL CORPORATION**, (U.S. CLS. 100, 101 AND 107). SN 77-074,564. PUB. 7-31-2007. FILED 1-2-2007.
- 3,311,125. **THE NATIONAL ALLIANCE FOR INSURANCE EDUCATION & RESEARCH AND DESIGN**, THE NATIONAL ALLIANCE FOR INSURANCE EDUCATION & RESEARCH, (U.S. CLS. 100, 101 AND 107). SN 77-075,702. PUB. 7-17-2007. FILED 1-4-2007.
- 3,311,127. **HILLBILLY WATER (BLOCK FORM)**, KAPITANELIS, GEORGE, (U.S. CLS. 100, 101 AND 107). SN 77-076,246. PUB. 7-31-2007. FILED 1-4-2007.
- 3,311,131. **ZANIMATION (BLOCK FORM)**, BROWN, JAMES ROBERT, (U.S. CLS. 100, 101 AND 107). SN 77-076,318. PUB. 7-31-2007. FILED 1-4-2007.
- 3,311,157. **13 WEEKS (BLOCK FORM)**, ACCESS NURSES, INC., (U.S. CLS. 100, 101 AND 107). SN 77-079,385. PUB. 7-31-2007. FILED 1-9-2007.
- 3,311,164 (*See Class 35 for this trademark*).
- 3,311,167 (*See Class 35 for this trademark*).
- 3,311,170. **THE FIREZONE (BLOCK FORM)**, BIG RED FUN, INC., (U.S. CLS. 100, 101 AND 107). SN 77-080,472. PUB. 7-31-2007. FILED 1-10-2007.
- 3,311,175. **THERENOW AND DESIGN**, THERENOW, INC., (U.S. CLS. 100, 101 AND 107). SN 77-081,082. PUB. 7-31-2007. FILED 1-11-2007.
- 3,311,180. **THE INTERNATIONAL (BLOCK FORM)**, THE CASTLE PINES GOLF CLUB, INC., (U.S. CLS. 100, 101 AND 107). SN 77-081,321. PUB. 7-31-2007. FILED 1-11-2007.
- 3,311,190. **DATE WITH A PURPOSE (BLOCK FORM)**, AMERICA'S FAMILY COACHES, INC., (U.S. CLS. 100, 101 AND 107). SN 77-082,316. PUB. 7-31-2007. FILED 1-12-2007.
- 3,311,203 (*See Class 38 for this trademark*).
- 3,311,205 (*See Class 38 for this trademark*).
- 3,311,209. **STEPS SEMINAR, TRAINING & EDUCATION PROGRAMS AND DESIGN**, NATIONAL READY MIXED CONCRETE ASSOCIATION, (U.S. CLS. 100, 101 AND 107). SN 77-083,584. PUB. 7-31-2007. FILED 1-16-2007.
- 3,311,212. **TRIPLE-A (BLOCK FORM)**, NATIONAL ASSOCIATION OF PROFESSIONAL BASEBALL LEAGUES, INC., (U.S. CLS. 100, 101 AND 107). SN 77-084,048. PUB. 7-31-2007. FILED 1-16-2007.
- 3,311,214 (*See Class 36 for this trademark*).
- 3,311,215. **QUEPASA (BLOCK FORM)**, QUEPASA CORPORATION, (U.S. CLS. 100, 101 AND 107). SN 77-084,804. PUB. 7-31-2007. FILED 1-17-2007.
- 3,311,222. **FULLY IMMERSSED (BLOCK FORM)**, FULLY IMMERSSED, INC., (U.S. CLS. 100, 101 AND 107). SN 77-085,455. PUB. 7-31-2007. FILED 1-18-2007.
- 3,311,230. **AOL POINTE (BLOCK FORM)**, AOL LLC, (U.S. CLS. 100, 101 AND 107). SN 77-085,719. PUB. 7-31-2007. FILED 1-18-2007.
- 3,311,234. **QUIZ TIME LOUNGE (BLOCK FORM)**, AOL LLC, (U.S. CLS. 100, 101 AND 107). SN 77-085,843. PUB. 7-31-2007. FILED 1-18-2007.
- 3,311,240. **DEFINED FITNESS TRAINING, LLC AND DESIGN**, DEFINED FITNESS TRAINING, LLC, (U.S. CLS. 100, 101 AND 107). SN 77-086,164. PUB. 7-31-2007. FILED 1-18-2007.
- 3,311,244. **LIVE WELL GET HEALTHY, BE HEALTHY, STAY HEALTHY AND DESIGN**, WILKENS MEDICAL GROUP, (U.S. CLS. 100, 101 AND 107). SN 77-086,570. PUB. 7-31-2007. FILED 1-19-2007.
- 3,311,255. **BLUE HOUSE (BLOCK FORM)**, DE VEER, MARLIES, AND BEASLEY, AMY, (U.S. CLS. 100, 101 AND 107). SN 77-087,497. PUB. 7-31-2007. FILED 1-21-2007.
- 3,311,258. **COLORADO CHILL (BLOCK FORM)**, TRIPLE CROWN SPORTS, (U.S. CLS. 100, 101 AND 107). SN 77-087,825. PUB. 7-10-2007. FILED 1-22-2007.
- 3,311,282. **CHICAGO NEIGHBORHOOD DEVELOPMENT AWARDS (BLOCK FORM)**, LOCAL INITIATIVES SUPPORT CORPORATION, (U.S. CLS. 100, 101 AND 107). SN 77-089,927. PUB. 7-31-2007. FILED 1-24-2007.
- 3,311,293. **PERIPHERAL VISION PRODUCTIONS (BLOCK FORM)**, ASSANTI, BRANDON, AND TOIT, KEVIN DU, (U.S. CLS. 100, 101 AND 107). SN 77-090,626. PUB. 7-31-2007. FILED 1-25-2007.
- 3,311,296. **LOCALIST (BLOCK FORM)**, DEETER, THOMAS J., (U.S. CLS. 100, 101 AND 107). SN 77-090,887. PUB. 7-31-2007. FILED 1-25-2007.
- 3,311,298. **HAUTE TRASH (BLOCK FORM)**, HAUTE TRASH: AN ARTIST'S COLLABORATIVE, (U.S. CLS. 100, 101 AND 107). SN 77-091,063. PUB. 7-31-2007. FILED 1-25-2007.
- 3,311,300. **PUSH PLAY (BLOCK FORM)**, BARAN, CHRISTOPHER J., AND RIES, DEREK, AND DE TURRIS, NICHOLAS, AND SCAROLA, STEVEN, (U.S. CLS. 100, 101 AND 107). SN 77-091,334. PUB. 7-31-2007. FILED 1-25-2007.
- 3,311,303. **ROOFER'S SURVIVAL EXTRAVAGANZA (BLOCK FORM)**, ROOFERS' SUCCESS INTERNATIONAL, LLC, (U.S. CLS. 100, 101 AND 107). SN 77-091,510. PUB. 7-31-2007. FILED 1-25-2007.
- 3,311,308 (*See Class 37 for this trademark*).
- 3,311,313 (*See Class 9 for this trademark*).
- 3,311,314. **LADY ROYALE (BLOCK FORM)**, J7 RECORDS, INC., (U.S. CLS. 100, 101 AND 107). SN 77-093,108. PUB. 7-31-2007. FILED 1-29-2007.
- 3,311,317. **NEECHEE (BLOCK FORM)**, WALDROP, MARK A, (U.S. CLS. 100, 101 AND 107). SN 77-093,380. PUB. 7-31-2007. FILED 1-29-2007.
- 3,311,330 (*See Class 6 for this trademark*).
- 3,311,331. **ROCK HOUSE WAY AND DESIGN**, ROCK HOUSE WAY, (U.S. CLS. 100, 101 AND 107). SN 77-094,371. PUB. 7-17-2007. FILED 1-30-2007.
- 3,311,332. **BAPTIST GOLF CLASSIC (BLOCK FORM)**, BAPTIST HEALTHCARE SYSTEM, INC., (U.S. CLS. 100, 101 AND 107). SN 77-094,395. PUB. 7-31-2007. FILED 1-30-2007.
- 3,311,357. **MOBOOGIE (BLOCK FORM)**, MOBOOGIE.NET, LLC, (U.S. CLS. 100, 101 AND 107). SN 77-096,362. PUB. 7-31-2007. FILED 1-31-2007.
- 3,311,359. **THE HARROW PRESS (BLOCK FORM)**, PAGLIASOTTI, DRUANN LYNN, (U.S. CLS. 100, 101 AND 107). SN 77-096,410. PUB. 7-31-2007. FILED 2-1-2007.
- 3,311,360. **OPPORTUNITY BARKS L.L.C. (BLOCK FORM)**, ROZEK, CAROL E., (U.S. CLS. 100, 101 AND 107). SN 77-096,439. PUB. 7-31-2007. FILED 2-1-2007.
- 3,311,392. **KRYTERIUM (BLOCK FORM)**, MICHAEL JOHN CHAVES, AND JOHN ELMIRO DA ROCHA CHAVES, (U.S. CLS. 100, 101 AND 107). SN 77-098,054. PUB. 7-31-2007. FILED 2-2-2007.
- 3,311,396. **HUMMINGBIRD PRODUCTIONS (BLOCK FORM)**, THORNE, ASHIDA ONRAE, (U.S. CLS. 100, 101 AND 107). SN 77-098,204. PUB. 7-31-2007. FILED 2-2-2007.
- 3,311,418. **DARK ROMANCE (STYLIZED)**, WEBB, LIZANNE E., AND KOENIG, JOHN L, (U.S. CLS. 100, 101 AND 107). SN 77-098,821. PUB. 7-31-2007. FILED 2-4-2007.
- 3,311,425 (*See Class 9 for this trademark*).
- 3,311,428. **JUMP ON IN (BLOCK FORM)**, JUMP ON IN, INC., (U.S. CLS. 100, 101 AND 107). SN 77-099,058. PUB. 7-31-2007. FILED 2-5-2007.
- 3,311,442. **OBEY YOUR PASSION (BLOCK FORM)**, DAUBENSPECK, LLOYD ALAN, (U.S. CLS. 100, 101 AND 107). SN 77-099,606. PUB. 7-31-2007. FILED 2-5-2007.
- 3,311,464 (*See Class 9 for this trademark*).
- 3,311,466. **MANUFACTURING THE UAV WORLD (BLOCK FORM)**, COPTERVISION, LLC, AND PATRIOT ANTENNA SYSTEMS, INC., (U.S. CLS. 100, 101 AND 107). SN 77-101,035. PUB. 7-31-2007. FILED 2-6-2007.
- 3,311,476. **ROCKIN' CALIFORNIA SCREAMIN' (BLOCK FORM)**, DISNEY ENTERPRISES, INC., (U.S. CLS. 100, 101 AND 107). SN 77-101,815. PUB. 7-31-2007. FILED 2-7-2007.
- 3,311,477. **ROCKIN' SPACE MOUNTAIN (BLOCK FORM)**, DISNEY ENTERPRISES, INC., (U.S. CLS. 100, 101 AND 107). SN 77-101,816. PUB. 7-31-2007. FILED 2-7-2007.
- 3,311,495. **THE PASSIONATE MOVIEGOER (BLOCK FORM)**, JOE BALTAKE, (U.S. CLS. 100, 101 AND 107). SN 77-104,561. PUB. 7-31-2007. FILED 2-11-2007.
- 3,311,498. **WHITETAIL (BLOCK FORM)**, SNOW TIME, INC., (U.S. CLS. 100, 101 AND 107). SN 77-105,068. PUB. 7-31-2007. FILED 2-12-2007.
- 3,311,500. **MISCELLANEOUS DESIGN**, SNOW TIME, INC., (U.S. CLS. 100, 101 AND 107). SN 77-105,138. PUB. 7-31-2007. FILED 2-12-2007.
- 3,311,501. **WHITETAIL RESORT (BLOCK FORM)**, SNOW TIME, INC., (U.S. CLS. 100, 101 AND 107). SN 77-105,159. PUB. 7-31-2007. FILED 2-12-2007.
- 3,311,517. **LYRICSFLY (STYLIZED)**, BLASZKIEWICZ RAFAŁ G., (U.S. CLS. 100, 101 AND 107). SN 77-110,071. PUB.

- 7-31-2007. FILED 2-16-2007.
- 3,311,519. **HI FI M HIGH FIDELITY MASTERING AND DESIGN**. HIGH FIDELITY MASTERING, (U.S. CLS. 100, 101 AND 107). SN 77-110,256. PUB. 7-31-2007. FILED 2-18-2007.
- 3,311,523. **BIXBY SCHOOL AND DESIGN**. BIXBY & ASSOCIATES, DBA BIXBY SCHOOL, (U.S. CLS. 100, 101 AND 107). SN 77-111,520. PUB. 7-31-2007. FILED 2-20-2007.
- 3,311,526. **TRANSFORMING FLEET DATA INTO BUSINESS VALUE (BLOCK FORM)**. AUTOMOTIVE RENTALS, INC., (U.S. CLS. 100, 101 AND 107). SN 77-112,633. PUB. 7-31-2007. FILED 2-21-2007.
- 3,311,537. **GET THE MOST FROM YOUR TIME, MONEY AND REHAB. LET MOST COME TO YOU! (BLOCK FORM)**. MOBILE ON SITE THERAPY, INC., MULTIPLE CLASS, (INT. CLS. 41 AND 44), (U.S. CLS. 100, 101 AND 107). SN 77-114,745. PUB. 7-31-2007. FILED 2-23-2007.
- 3,311,565. **TECH CONFIDENTIAL (BLOCK FORM)**. THE DEAL, LLC, (U.S. CLS. 100, 101 AND 107). SN 77-124,247. PUB. 7-31-2007. FILED 3-7-2007.
- 3,311,567. **I NIGHT TENNIS AND DESIGN**. SONY ERICSSON MOBILE COMMUNICATIONS AB, (U.S. CLS. 100, 101 AND 107). SN 77-124,673. PUB. 7-31-2007. FILED 3-7-2007.
- 3,311,568. **SEMPER FIREARMS TRAINING (BLOCK FORM)**. GLATTHAR, JOHN NELSON, (U.S. CLS. 100, 101 AND 107). SN 77-125,061. PUB. 7-31-2007. FILED 3-7-2007.
- 3,311,588. **IMPROVING WITH IMPROV (BLOCK FORM)**. ALLENSON, CHARLES, (U.S. CLS. 100, 101 AND 107). SN 77-130,438. PUB. 7-31-2007. FILED 3-14-2007.
- 3,311,599 (*See Class 38 for this trademark*).
- 3,311,600. **MISCELLANEOUS DESIGN**. BLUE CROSS AND BLUE SHIELD OF KANSAS CITY, (U.S. CLS. 100, 101 AND 107). SN 77-136,422. PUB. 7-31-2007. FILED 3-21-2007.
- 3,311,603 (*See Class 35 for this trademark*).
- 3,311,604. **EDUSPAIN (BLOCK FORM)**. ENFOREX ENGLISH FOR EXECUTIVES, S.L., (U.S. CLS. 100, 101 AND 107). SN 77-141,652. PUB. 7-31-2007. FILED 3-27-2007.
- 3,311,609. **INFANTSEE4D (STYLIZED)**. INFANTSEE4D, (U.S. CLS. 100, 101 AND 107). SN 77-146,228. PUB. 7-31-2007. FILED 4-2-2007.
- 3,311,633. **GRAND VIEW MEDIA GROUP**. EBSCO INDUSTRIES, INC., (U.S. CLS. 100, 101 AND 107). SN 78-177,564. PUB. 7-31-2007. FILED 10-23-2002.
- 3,311,640 (*See Class 25 for this trademark*).
- 3,311,650. **KARING FOR KIDS (BLOCK FORM)**. ACCREDO HEALTH GROUP, INC., MULTIPLE CLASS, (INT. CLS. 41 AND 44), (U.S. CLS. 100, 101 AND 107). SN 78-373,104. PUB. 7-31-2007. FILED 2-24-2004.
- 3,311,653 (*See Class 14 for this trademark*).
- 3,311,663 (*See Class 9 for this trademark*).
- 3,311,665 (*See Class 16 for this trademark*).
- 3,311,666 (*See Class 9 for this trademark*).
- 3,311,676. **THE BARNES METHOD PRE-NATAL AND MOMMY & BABY YOGA YOGA FOR TWO AND DESIGN**. BARNES, MARY RYAN, (U.S. CLS. 100, 101 AND 107). SN 78-534,707. PUB. 7-31-2007. FILED 12-17-2004.
- 3,311,687 (*See Class 9 for this trademark*).
- 3,311,690 (*See Class 16 for this trademark*).
- 3,311,695 (*See Class 9 for this trademark*).
- 3,311,696 (*See Class 3 for this trademark*).
- 3,311,700 (*See Class 9 for this trademark*).
- 3,311,724. **GTN (STYLIZED)**. GTN, INC., (U.S. CLS. 100, 101 AND 107). SN 78-641,736. PUB. 7-31-2007. FILED 6-1-2005.
- 3,311,731 (*See Class 9 for this trademark*).
- 3,311,738 (*See Class 16 for this trademark*).
- 3,311,741. **APOLLO ALLIANCE (BLOCK FORM)**. ROGERS, JOEL E., (U.S. CLS. 100, 101 AND 107). SN 78-658,712. PUB. 7-31-2007. FILED 6-27-2005.
- 3,311,753 (*See Class 35 for this trademark*).
- 3,311,754. **DISCOVERY TRAVEL & LIVING VIAJAR Y VIVIR (BLOCK FORM)**. DISCOVERY COMMUNICATIONS, INC., (U.S. CLS. 100, 101 AND 107). SN 78-677,933. PUB. 7-31-2007. FILED 7-25-2005.
- 3,311,756 (*See Class 38 for this trademark*).
- 3,311,786. **AMERICAN JAZZ VENUES (BLOCK FORM)**. AMERICAN JAZZ VENUES CORP., (U.S. CLS. 100, 101 AND 107). SN 78-704,253. PUB. 7-31-2007. FILED 8-31-2005.
- 3,311,793. **NAPA NAPA INSTITUTE OF AUTOMOTIVE TECHNOLOGY AUTOTECH PROFESSIONAL AUTOMOTIVE CAREER TRAINING AND DESIGN**. NATIONAL AUTOMOTIVE PARTS ASSOCIATION, (U.S. CLS. 100, 101 AND 107). SN 78-709,424. PUB. 7-31-2007. FILED 9-8-2005.
- 3,311,794 (*See Class 35 for this trademark*).
- 3,311,813 (*See Class 35 for this trademark*).
- 3,311,827. **ROXY (BLOCK FORM)**. THE BEER GARDEN, INC., (U.S. CLS. 100, 101 AND 107). SN 78-733,178. PUB. 7-31-2007. FILED 10-14-2005.
- 3,311,835. **SK AND DESIGN**. SK CHEMICALS CO., LTD., AND SK NETWORKS CO., LTD., AND SKC CO., LTD., AND SK CORPORATION, AND SK TELECOM CO., LTD., (U.S. CLS. 100, 101 AND 107). SN 78-738,014. PUB. 7-31-2007. FILED 10-21-2005.
- 3,311,841. **RECORDING ARTS DAY ON CAPITOL HILL AND DESIGN**. NATIONAL ACADEMY OF RECORDING ARTS & SCIENCES, INC., (U.S. CLS. 100, 101 AND 107). SN 78-741,128. PUB. 7-31-2007. FILED 10-26-2005.
- 3,311,855. **JUST DRIVE (BLOCK FORM)**. JUST DRIVE, INC., (U.S. CLS. 100, 101 AND 107). SN 78-752,424. PUB. 7-25-2006. FILED 11-11-2005.
- 3,311,868 (*See Class 25 for this trademark*).
- 3,311,883 (*See Class 16 for this trademark*).
- 3,311,888. **INTERNAL DEFENSE SYSTEM AND DESIGN**. INTERNAL DEFENSE SYTEM, INC., (U.S. CLS. 100, 101 AND 107). SN 78-783,149. PUB. 7-31-2007. FILED 12-30-2005.
- 3,311,892. **ICONLOGIC AND DESIGN**. ICONLOGIC, INC., (U.S. CLS. 100, 101 AND 107). SN 78-785,387. PUB. 7-31-2007. FILED 1-5-2006.
- 3,311,893 (*See Class 35 for this trademark*).
- 3,311,912 (*See Class 35 for this trademark*).
- 3,311,932 (*See Class 9 for this trademark*).
- 3,311,933. **KIDZ BUSINESS EXPO "CREATING NEW MINDS FOR THE FUTURE" AND DESIGN**. KIDZ BUSINESS EXPO, (U.S. CLS. 100, 101 AND 107). SN 78-810,243. PUB. 7-31-2007. FILED 2-8-2006.
- 3,311,939 (*See Class 16 for this trademark*).
- 3,311,943 (*See Class 25 for this trademark*).
- 3,311,965 (*See Class 33 for this trademark*).
- 3,311,981. **STOOPID FOOZ (BLOCK FORM)**. GUTIERREZ, ROBERT, (U.S. CLS. 100, 101 AND 107). SN 78-838,426. PUB. 7-31-2007. FILED 3-16-2006.
- 3,311,983. **TEACHERS COLLEGE INNOVATIONS NEW TEACHER ACADEMY (BLOCK FORM)**. THE DORIS DILLON CENTER, (U.S. CLS. 100, 101 AND 107). SN 78-838,825. PUB. 7-31-2007. FILED 3-16-2006.
- 3,311,985. **TEACHERS COLLEGE INNOVATIONS NEW TEACHER FOUNDATIONS (BLOCK FORM)**. THE DORIS DILLON CENTER, (U.S. CLS. 100, 101 AND 107). SN 78-838,990. PUB. 7-31-2007. FILED 3-16-2006.
- 3,311,986. **HARLEMWOODS (BLOCK FORM)**. WOODS, VAN, (U.S. CLS. 100, 101 AND 107). SN 78-840,811. PUB. 7-31-2007. FILED 3-19-2006.
- 3,312,001 (*See Class 16 for this trademark*).
- 3,312,004. **TOPS TOTAL PATIENT SERVICE INSTITUTE (STYLIZED)**. ANDERSON, STEVEN J., (U.S. CLS. 100, 101 AND 107). SN 78-848,125. PUB. 7-31-2007. FILED 3-28-2006.
- 3,312,006. **HYPERSTRIKE (BLOCK FORM)**. HYPERSTRIKE, INC., (U.S. CLS. 100, 101 AND 107). SN 78-848,572. PUB. 7-31-2007. FILED 3-29-2006.
- 3,312,014. **GOLDEN GATES CASINO & POKER PARLOUR (BLOCK FORM)**. GOLDEN MARDI GRAS, INC., (U.S. CLS. 100, 101 AND 107). SN 78-851,727. PUB. 7-31-2007. FILED 3-31-2006.
- 3,312,019. **INSPIRING THE ME IN MEDIA (BLOCK FORM)**. ELGIAMAE CONCEPTS, LLC, (U.S. CLS. 100, 101 AND 107). SN 78-852,515. PUB. 7-31-2007. FILED 4-3-2006.
- 3,312,021. **IT'SMEDIA (BLOCK FORM)**. ELGIAMAE CONCEPTS, LLC, (U.S. CLS. 100, 101 AND 107). SN 78-852,531. PUB. 7-31-2007. FILED 4-3-2006.
- 3,312,032 (*See Class 9 for this trademark*).
- 3,312,060. **WESTERN BEAUTY INSTITUTE (BLOCK FORM)**. SAN FERNANDO BEAUTY ACADEMY, (U.S. CLS. 100, 101 AND 107). SN 78-864,331. PUB. 7-31-2007. FILED 4-19-2006.
- 3,312,065 (*See Class 9 for this trademark*).
- 3,312,086. **KNOWLEDGE CENTER (BLOCK FORM)**. UNI-

- FIED VOICE, DBA INTERNATIONAL INTERIOR DESIGN ASSOCIATION, (U.S. CLS. 100, 101 AND 107). SN 78-870,943. PUB. 7-31-2007. FILED 4-27-2006.
- 3,312,091. **AUSTIN FAMILY (BLOCK FORM)**. K K KEMPER, INC., (U.S. CLS. 100, 101 AND 107). SN 78-871,456. PUB. 7-31-2007. FILED 4-27-2006.
- 3,312,094. **THE VOCALIST STUDIO (BLOCK FORM)**. ROBERT JAMES LUNTE, (U.S. CLS. 100, 101 AND 107). SN 78-871,742. PUB. 7-31-2007. FILED 4-28-2006.
- 3,312,099. **RETROFITNESS GET YOUR HOME IN SHAPE AND DESIGN**. FEDERAL ALLIANCE FOR SAFE HOMES, (U.S. CLS. 100, 101 AND 107). SN 78-872,710. PUB. 7-31-2007. FILED 4-28-2006.
- 3,312,102. **AMERICA STANDING TALL (BLOCK FORM)**. USAGENCY, INC., (U.S. CLS. 100, 101 AND 107). SN 78-872,980. PUB. 7-31-2007. FILED 4-30-2006.
- 3,312,104 (*See Class 35 for this trademark*).
- 3,312,110. **WORLD INSTITUTE FOR NURTURING COMMUNICATION, WINC AND DESIGN**. INTERNATIONAL ASSOCIATION OF INFANT MASSAGE, INC., (U.S. CLS. 100, 101 AND 107). SN 78-873,881. PUB. 7-31-2007. FILED 5-1-2006.
- 3,312,117 (*See Class 35 for this trademark*).
- 3,312,118. **WE TALK AND DESIGN**. GRIMES JR., CHARLES O., (U.S. CLS. 100, 101 AND 107). SN 78-874,869. PUB. 7-31-2007. FILED 5-2-2006.
- 3,312,121 (*See Class 35 for this trademark*).
- 3,312,134. **ASIAN MOON FESTIVAL (BLOCK FORM)**. WISCONSIN ORGANIZATION FOR ASIAN AMERICANS, INC., (U.S. CLS. 100, 101 AND 107). SN 78-876,702. PUB. 7-31-2007. FILED 5-4-2006.
- 3,312,143. **RUBBERBOY (BLOCK FORM)**. SMITH, DANIEL BROWNING, (U.S. CLS. 100, 101 AND 107). SN 78-877,868. PUB. 7-31-2007. FILED 5-5-2006.
- 3,312,153. **MISCELLANEOUS DESIGN**. THIAM, ALIAUNE, (U.S. CLS. 100, 101 AND 107). SN 78-879,123. PUB. 7-31-2007. FILED 5-8-2006.
- 3,312,155 (*See Class 9 for this trademark*).
- 3,312,171. **AIT THE LEARNING SOURCE (BLOCK FORM)**. AGENCY FOR INSTRUCTIONAL TECHNOLOGY, (U.S. CLS. 100, 101 AND 107). SN 78-881,416. PUB. 7-31-2007. FILED 5-11-2006.
- 3,312,183. **CTV.CA (BLOCK FORM)**. CTV INC., (U.S. CLS. 100, 101 AND 107). SN 78-882,935. PUB. 7-31-2007. FILED 5-12-2006.
- 3,312,187 (*See Class 35 for this trademark*).
- 3,312,196 (*See Class 16 for this trademark*).
- 3,312,198 (*See Class 16 for this trademark*).
- 3,312,205 (*See Class 9 for this trademark*).
- 3,312,207. **ENVISION YOUR FUTURE (BLOCK FORM)**. O'SULLIVAN, PATRICIA A., (U.S. CLS. 100, 101 AND 107). SN 78-886,201. PUB. 7-31-2007. FILED 5-17-2006.
- 3,312,209. **WOODLAND PUBLISHING (BLOCK FORM)**. WOODLAND PUBLISHING, INC., (U.S. CLS. 100, 101 AND 107). SN 78-886,739. PUB. 7-31-2007. FILED 5-18-2006.
- 3,312,210 (*See Class 36 for this trademark*).
- 3,312,216 (*See Class 38 for this trademark*).
- 3,312,217 (*See Class 16 for this trademark*).
- 3,312,223. **INVESTORS CAFE (BLOCK FORM)**. INVESTORS CAFE, LLC, (U.S. CLS. 100, 101 AND 107). SN 78-887,627. PUB. 7-31-2007. FILED 5-19-2006.
- 3,312,244. **THE DAILY PAGE (BLOCK FORM)**. ISTHMUS PUBLISHING COMPANY, INC., (U.S. CLS. 100, 101 AND 107). SN 78-892,854. PUB. 7-31-2007. FILED 5-25-2006.
- 3,312,249 (*See Class 16 for this trademark*).
- 3,312,272. **THE SANDLOT RADIO NETWORK (BLOCK FORM)**. SANDLOT RADIO NETWORK, LLC, (U.S. CLS. 100, 101 AND 107). SN 78-899,327. PUB. 7-31-2007. FILED 6-2-2006.
- 3,312,273. **THE SANDLOT EXPERIENCE (BLOCK FORM)**. SANDLOT RADIO NETWORK, LLC, (U.S. CLS. 100, 101 AND 107). SN 78-899,351. PUB. 7-31-2007. FILED 6-2-2006.
- 3,312,276 (*See Class 36 for this trademark*).
- 3,312,278. **RTA AND DESIGN**. RIGHT TRACK ACADEMY, LLC, (U.S. CLS. 100, 101 AND 107). SN 78-899,937. PUB. 7-31-2007. FILED 6-3-2006.
- 3,312,292. **MISCELLANEOUS DESIGN**. RUCKUS HOUSE PARTNERS, LLC, MULTIPLE CLASS, (INT. CLS. 41 AND 43), (U.S. CLS. 100, 101 AND 107). SN 78-902,831. PUB. 7-31-2007. FILED 6-7-2006.
- 3,312,296 (*See Class 35 for this trademark*).
- 3,312,318 (*See Class 35 for this trademark*).
- 3,312,319. **CLINCH MOUNTAIN MUSIC FEST AND DESIGN**. SOUTHWEST VIRGINIA COMMUNITY FOUNDATION, INC., (U.S. CLS. 100, 101 AND 107). SN 78-906,909. PUB. 7-31-2007. FILED 6-13-2006.
- 3,312,327. **GAMMADIDDY (BLOCK FORM)**. BIGOTT, FRANK, (U.S. CLS. 100, 101 AND 107). SN 78-908,495. PUB. 7-31-2007. FILED 6-14-2006.
- 3,312,342. **GOLF NATION (BLOCK FORM)**. GO LOW, LLC, (U.S. CLS. 100, 101 AND 107). SN 78-911,909. PUB. 7-31-2007. FILED 6-20-2006.
- 3,312,343. **DOGS RULE DAY CARE & SCHOOL AND DESIGN**. DOGS RULE-DOG DAYCARE & SCHOOL, MULTIPLE CLASS, (INT. CLS. 41 AND 43), (U.S. CLS. 100, 101 AND 107). SN 78-912,071. PUB. 7-31-2007. FILED 6-20-2006.
- 3,312,346 (*See Class 25 for this trademark*).
- 3,312,348 (*See Class 16 for this trademark*).
- 3,312,349. **CAR-PARAZZI (BLOCK FORM)**. TIPPI DOBROFSKY, (U.S. CLS. 100, 101 AND 107). SN 78-912,845. PUB. 7-31-2007. FILED 6-20-2006.
- 3,312,365. **YOUR PROFESSIONALISM IS KILLING YOU (BLOCK FORM)**. HARBRIDGE, CHRISTINA ANN, (U.S. CLS. 100, 101 AND 107). SN 78-916,375. PUB. 7-31-2007. FILED S.R. 6-25-2006; AM. P.R. 6-22-2007.
- 3,312,366. **LASALLE BANK THEATRE (STYLIZED)**. LASALLE BANK CORPORATION, (U.S. CLS. 100, 101 AND 107). SN 78-916,569. PUB. 7-31-2007. FILED 6-26-2006.
- 3,312,378. **PETER PAN (BLOCK FORM)**. THE NEW YORK RACING ASSOCIATION INC., (U.S. CLS. 100, 101 AND 107). SN 78-918,965. PUB. 7-10-2007. FILED 6-28-2006.
- 3,312,383 (*See Class 35 for this trademark*).
- 3,312,386 (*See Class 35 for this trademark*).
- 3,312,421. **AMERICA'S TOP RECIPE CONTEST AND DESIGN**. ALLRECIPES.COM, INC., (U.S. CLS. 100, 101 AND 107). SN 78-924,234. PUB. 7-31-2007. FILED 7-7-2006.
- 3,312,426. **BLOCK PARTY BASH (BLOCK FORM)**. DISNEY ENTERPRISES, INC., (U.S. CLS. 100, 101 AND 107). SN 78-924,969. PUB. 7-31-2007. FILED 7-7-2006.
- 3,312,434. **THE RIVER (STYLIZED)**. IMPERIAL PALACE OF MISSISSIPPI, LLC, MULTIPLE CLASS, (INT. CLS. 41 AND 43), (U.S. CLS. 100, 101 AND 107). SN 78-926,376. PUB. 7-31-2007. FILED 7-11-2006.
- 3,312,446 (*See Class 35 for this trademark*).
- 3,312,448. **NYC ARTS (BLOCK FORM)**. ALLIANCE FOR THE ARTS, INC., (U.S. CLS. 100, 101 AND 107). SN 78-928,105. PUB. 7-31-2007. FILED 7-12-2006.
- 3,312,464. **TRIKAYA (BLOCK FORM)**. WARD, KRISTINA, AND WARD, CRAIG S., (U.S. CLS. 100, 101 AND 107). SN 78-930,145. PUB. 7-31-2007. FILED 7-14-2006.
- 3,312,467. **DYNESOS (BLOCK FORM)**. ZIMMER GMBH, (U.S. CLS. 100, 101 AND 107). SN 78-930,997. PUB. 7-31-2007. FILED 7-17-2006.
- 3,312,470. **NEWMUSICSERVER (BLOCK FORM)**. NEW ACCESS MUSIC, LP, (U.S. CLS. 100, 101 AND 107). SN 78-931,088. PUB. 7-31-2007. FILED 7-17-2006.
- 3,312,484. **UPHOLDING THE AUTHORITY OF THE BIBLE FROM THE VERY FIRST VERSE (BLOCK FORM)**. ANSWERS IN GENESIS OF KENTUCKY, INC., (U.S. CLS. 100, 101 AND 107). SN 78-932,712. PUB. 7-31-2007. FILED 7-19-2006.
- 3,312,506 (*See Class 16 for this trademark*).
- 3,312,513. **WHEATMARK AND DESIGN**. WHEATMARK, INC., (U.S. CLS. 100, 101 AND 107). SN 78-938,495. PUB. 7-31-2007. FILED 7-26-2006.
- 3,312,521. **POCONO RIDGE (BLOCK FORM)**. VISINSKI, MICHELLE, SANTAY, (U.S. CLS. 100, 101 AND 107). SN 78-939,346. PUB. 7-31-2007. FILED 7-27-2006.
- 3,312,523. **SPORTSBYBROOKS AND DESIGN**. SBB, LLC, (U.S. CLS. 100, 101 AND 107). SN 78-939,392. PUB. 7-31-2007. FILED S.R. 7-27-2006; AM. P.R. 3-15-2007.
- 3,312,525. **R RICHARDSON THE POWER TO SELL AND DESIGN**. RICHARDSON COMPANY, (U.S. CLS. 100, 101 AND 107). SN 78-940,025. PUB. 7-31-2007. FILED 7-28-2006.
- 3,312,531. **THE CURRENT FAKEBOOK (BLOCK FORM)**. MINNESOTA PUBLIC RADIO, (U.S. CLS. 100, 101 AND

- 107). SN 78-941,136. PUB. 4-17-2007. FILED 7-31-2006.
3,312,536 (*See Class 6 for this trademark*).
3,312,537. **DIRTY SOUTH SURF CONTEST (BLOCK FORM)**.
KULCHA SHOK MUZIK, INC., (U.S. CLS. 100, 101 AND
107). SN 78-942,715. PUB. 7-31-2007. FILED S.R. 8-2-2006;
AM. P.R. 6-14-2007.
3,312,538. **MARRIAGE BLUEPRINT (BLOCK FORM)**. DR.
MAX VOGT, (U.S. CLS. 100, 101 AND 107). SN 78-942,905.
PUB. 7-31-2007. FILED 8-2-2006.
3,312,547. **TRUNK MONEY RECORDS (BLOCK FORM)**.
MOUZZON, DEMARCUS, (U.S. CLS. 100, 101 AND 107).
SN 78-944,075. PUB. 7-31-2007. FILED 8-3-2006.
3,312,560. **CLINT BOWYER (BLOCK FORM)**. CLINT, BOW-
YER, (U.S. CLS. 100, 101 AND 107). SN 78-948,452. PUB. 7-
31-2007. FILED 8-9-2006.
3,312,577. **INFORMED CHOICES . . . HEALTHIER LIVES
(BLOCK FORM)**. PRIMARY PHYSICIANS CARE, INC.,
(U.S. CLS. 100, 101 AND 107). SN 78-951,642. PUB. 7-31-
2007. FILED 8-14-2006.
3,312,581 (*See Class 16 for this trademark*).
3,312,593. **TIEWEB (BLOCK FORM)**. JUSTIN DEAN FAZ-
ZARI, (U.S. CLS. 100, 101 AND 107). SN 78-957,935. PUB. 7-
31-2007. FILED 8-22-2006.
3,312,618. **NEBB (BLOCK FORM)**. MARKETING AND CON-
SULTANT SERVICES, INC., (U.S. CLS. 100, 101 AND 107).
SN 78-961,279. PUB. 4-17-2007. FILED 8-27-2006.
3,312,619. **NEBB INSTITUTE (BLOCK FORM)**. MARKETING
AND CONSULTANT SERVICES, INC., (U.S. CLS. 100, 101
AND 107). SN 78-961,282. PUB. 4-17-2007. FILED 8-27-2006.
3,312,630 (*See Class 25 for this trademark*).
3,312,633 (*See Class 25 for this trademark*).
3,312,636. **BODY MIND SPIRIT WORKS (BLOCK FORM)**.
D'ALESSIO, THOMAS D., (U.S. CLS. 100, 101 AND 107). SN
78-963,944. PUB. 7-31-2007. FILED 8-30-2006.
3,312,641. **PROJECT HEADWAY (BLOCK FORM)**. GANT-
THEAD.COM, INC., (U.S. CLS. 100, 101 AND 107). SN 78-
964,616. PUB. 7-31-2007. FILED 8-31-2006.
3,312,642. **[PROJECT.HEADWAY] (STYLIZED)**. GANT-
THEAD.COM, INC., (U.S. CLS. 100, 101 AND 107). SN 78-
964,641. PUB. 7-31-2007. FILED 8-31-2006.
3,312,660 (*See Class 38 for this trademark*).
3,312,663 (*See Class 16 for this trademark*).
3,312,676. **THE BLUES CHURCH AND DESIGN**. SUZANNE
M. THOMAS, (U.S. CLS. 100, 101 AND 107). SN 78-971,949.
PUB. 7-31-2007. FILED 9-12-2006.
3,312,684. **SNOPES (BLOCK FORM)**. BARDAV INC., (U.S.
CLS. 100, 101 AND 107). SN 78-973,969. PUB. 7-31-2007.
FILED 9-13-2006.
3,312,689 (*See Class 35 for this trademark*).
3,312,703 (*See Class 9 for this trademark*).
3,312,704 (*See Class 5 for this trademark*).
3,312,709 (*See Class 25 for this trademark*).
3,312,713 (*See Class 16 for this trademark*).
3,312,742 (*See Class 9 for this trademark*).
3,312,749 (*See Class 7 for this trademark*).
3,312,758 (*See Class 9 for this trademark*).
3,312,763 (*See Class 16 for this trademark*).
3,312,782 (*See Class 9 for this trademark*).
3,312,794 (*See Class 9 for this trademark*).
3,312,826 (*See Class 6 for this trademark*).
3,312,830 (*See Class 9 for this trademark*).
3,312,848 (*See Class 16 for this trademark*).
3,312,850 (*See Class 9 for this trademark*).
3,312,874 (*See Class 9 for this trademark*).
3,312,900 (*See Class 38 for this trademark*).
3,312,926 (*See Class 5 for this trademark*).
3,312,933 (*See Class 39 for this trademark*).
3,310,203. **CYBEAR AND DESIGN**. CYBEAR, INC., (U.S. CLS.
100 AND 101). SN 75-924,893. PUB. 7-31-2007. FILED 2-22-
2000.
3,310,204 (*See Class 3 for this trademark*).
3,310,214 (*See Class 41 for this trademark*).
3,310,217. **ICSMULTIMEDIA TECHNOLOGY DESIGN COM-
MUNICATION AND DESIGN**. INTERACTIVE COMMU-
NICATIONS SOLUTIONS GROUP, INC., (U.S. CLS. 100
AND 101). SN 76-317,142. PUB. 7-31-2007. FILED 9-26-2001.
3,310,222. **DEBIO AND DESIGN**. DEBIOPHARM S.A., MUL-
TIPLE CLASS, (INT. CLS. 42 AND 45), (U.S. CLS. 100 AND
101). SN 76-421,671. PUB. 7-31-2007. FILED 6-11-2002.
3,310,230 (*See Class 7 for this trademark*).
3,310,232 (*See Class 1 for this trademark*).
3,310,234 (*See Class 1 for this trademark*).
3,310,237 (*See Class 9 for this trademark*).
3,310,238 (*See Class 35 for this trademark*).
3,310,247 (*See Class 9 for this trademark*).
3,310,256 (*See Class 35 for this trademark*).
3,310,310 (*See Class 9 for this trademark*).
3,310,332 (*See Class 41 for this trademark*).
3,310,338. **GANTTHEAD (BLOCK FORM)**. HEADSTRONG,
INC., (U.S. CLS. 100 AND 101). SN 76-663,075. PUB. 7-31-
2007. FILED 7-14-2006.
3,310,341 (*See Class 35 for this trademark*).
3,310,348. **IIA MEMBER EXCHANGE (BLOCK FORM)**. THE
INSTITUTE OF INTERNAL AUDITORS, INC., (U.S. CLS.
100 AND 101). SN 76-664,451. PUB. 7-31-2007. FILED 8-10-
2006.
3,310,355 (*See Class 35 for this trademark*).
3,310,377. **TOLLY UP TO SPEC CERTIFIED AND DESIGN**.
THE TOLLY GROUP, INC., (U.S. CLS. 100 AND 101). SN
76-668,757. PUB. 7-31-2007. FILED 11-8-2006.
3,310,434. **MICROFLEX (BLOCK FORM)**. OMNITECH IN-
TERNATIONAL, INC., (U.S. CLS. 100 AND 101). SN 77-
001,589. PUB. 5-15-2007. FILED 9-18-2006.
3,310,441 (*See Class 37 for this trademark*).
3,310,461. **HAPPY PLACES = HAPPY FACES COMMITTED
TO BETTER ENVIRONMENTS FOR CHILDREN AND
DESIGN**. PATRICK-WOUT, HEATHER D., (U.S. CLS. 100
AND 101). SN 77-006,601. PUB. 7-31-2007. FILED 9-25-2006.
3,310,467. **SECURED TECHNOLOGY, L.L.C. (STYLIZED)**.
SECURED TECHNOLOGY, L.L.C., (U.S. CLS. 100 AND
101). SN 77-008,367. PUB. 7-31-2007. FILED 9-27-2006.
3,310,491. **MISCELLANEOUS DESIGN**. ARIAGNO, KERNS,
MANK, WHITE L.L.C., (U.S. CLS. 100 AND 101). SN 77-
011,716. PUB. 7-31-2007. FILED 10-2-2006.
3,310,501. **BOARDEFFECT (BLOCK FORM)**. MRB COMMU-
NICATIONS, INC., (U.S. CLS. 100 AND 101). SN 77-013,252.
PUB. 7-31-2007. FILED 10-4-2006.
3,310,511. **PEERIDOL (BLOCK FORM)**. PATEL, MONABEN,
(U.S. CLS. 100 AND 101). SN 77-015,306. PUB. 7-31-2007.
FILED 10-5-2006.
3,310,531. **APPLIED TACTICS AND DESIGN**. APPLIED
TACTICS, INC., (U.S. CLS. 100 AND 101). SN 77-017,614.
PUB. 7-31-2007. FILED 10-10-2006.
3,310,549 (*See Class 9 for this trademark*).
3,310,563 (*See Class 36 for this trademark*).
3,310,581 (*See Class 38 for this trademark*).
3,310,594 (*See Class 35 for this trademark*).
3,310,599. **REAL-TIME AWARENESS SOLUTIONS (BLOCK
FORM)**. AWAREPOINT CORPORATION, MULTIPLE
CLASS, (INT. CLS. 42 AND 45), (U.S. CLS. 100 AND 101).
SN 77-029,604. PUB. 7-31-2007. FILED 10-26-2006.
3,310,607. **MOPHILLY (BLOCK FORM)**. PHILLIPS, MARK
O., (U.S. CLS. 100 AND 101). SN 77-031,020. PUB. 7-31-2007.
FILED 10-27-2006.
3,310,626 (*See Class 35 for this trademark*).
3,310,641. **PLAYTIME AND DESIGN**. PLAYTIME LLC, (U.S.
CLS. 100 AND 101). SN 77-038,043. PUB. 7-31-2007. FILED
11-6-2006.
3,310,651. **WTP WHITEFORDTAYLORPRESTON LLP AND
DESIGN**. WHITEFORD, TAYLOR & PRESTON L.L.P.,
(U.S. CLS. 100 AND 101). SN 77-038,802. PUB. 7-31-2007.
FILED 11-7-2006.
3,310,657 (*See Class 41 for this trademark*).
3,310,669 (*See Class 40 for this trademark*).
3,310,732 (*See Class 35 for this trademark*).

CLASS 42—SCIENTIFIC AND COMPUTER SERVICES

- 3,310,191. **AOL INSTANT MESSENGER**. AOL LLC, (U.S. CLS.
100 AND 101). SN 75-460,306. PUB. 12-26-2006. FILED 4-1-
1998.
3,310,193. **INSTANT MESSENGER**. AOL LLC, (U.S. CLS. 100
AND 101). SN 75-496,386. PUB. 12-26-2006. FILED 6-4-1998.

- 3,310,754. **BRAINKEEPER AND DESIGN**. BRAINKEEPER, INCORPORATED, (U.S. CLS. 100 AND 101). SN 77-054,694. PUB. 7-31-2007. FILED 12-1-2006.
- 3,310,756 (*See Class 9 for this trademark*).
- 3,310,764 (*See Class 1 for this trademark*).
- 3,310,770 (*See Class 9 for this trademark*).
- 3,310,776. **ML CREATIVE NEW MEDIA DESIGN AND DESIGN**. LEBOWITZ, MATHEW E., (U.S. CLS. 100 AND 101). SN 77-058,636. PUB. 7-31-2007. FILED 12-6-2006.
- 3,310,800. **FUELING BETTER DECISIONS (BLOCK FORM)**. WORLDTELEMETRY, INC., (U.S. CLS. 100 AND 101). SN 77-061,100. PUB. 7-31-2007. FILED 12-11-2006.
- 3,310,801 (*See Class 35 for this trademark*).
- 3,310,866. **MYPRET (BLOCK FORM)**. PRET-A-HABITER LLC, (U.S. CLS. 100 AND 101). SN 77-067,754. PUB. 7-31-2007. FILED 12-19-2006.
- 3,310,878. **360DECISIONS (BLOCK FORM)**. 360DECISIONS, (U.S. CLS. 100 AND 101). SN 77-068,266. PUB. 7-31-2007. FILED 12-20-2006.
- 3,310,894 (*See Class 9 for this trademark*).
- 3,310,919 (*See Class 1 for this trademark*).
- 3,310,921 (*See Class 1 for this trademark*).
- 3,310,927. **IHEALTHSPOT AND DESIGN**. IHEALTHSPOT INC., (U.S. CLS. 100 AND 101). SN 77-070,234. PUB. 7-31-2007. FILED 12-22-2006.
- 3,310,932. **BASELINE AND DESIGN**. BASELINE ENGINEERING, (U.S. CLS. 100 AND 101). SN 77-070,451. PUB. 7-31-2007. FILED 12-22-2006.
- 3,310,934 (*See Class 38 for this trademark*).
- 3,310,944. **BOZARTS (BLOCK FORM)**. BOZARTS, INC., (U.S. CLS. 100 AND 101). SN 77-070,800. PUB. 7-31-2007. FILED 12-22-2006.
- 3,310,950 (*See Class 35 for this trademark*).
- 3,310,961. **SUPERBLOCK (BLOCK FORM)**. SUPERBLOCK, LLC, (U.S. CLS. 100 AND 101). SN 77-071,259. PUB. 7-31-2007. FILED 12-26-2006.
- 3,310,982. **CARESERIES (BLOCK FORM)**. WELLINX, INC., (U.S. CLS. 100 AND 101). SN 77-071,911. PUB. 7-31-2007. FILED 12-27-2006.
- 3,311,028. **ADMISPHERE (BLOCK FORM)**. CENTRAL PENN IT SERVICES, LLC, (U.S. CLS. 100 AND 101). SN 77-072,724. PUB. 7-31-2007. FILED 12-28-2006.
- 3,311,045. **BLOGRHYTHM (BLOCK FORM)**. NICHOLAS RESEARCH ASSOCIATES INTERNATIONAL, INC., (U.S. CLS. 100 AND 101). SN 77-073,222. PUB. 7-31-2007. FILED 12-29-2006.
- 3,311,046 (*See Class 9 for this trademark*).
- 3,311,051. **INVENTLEGAL (BLOCK FORM)**. BERGEN, GRADY K., (U.S. CLS. 100 AND 101). SN 77-073,353. PUB. 7-31-2007. FILED 12-29-2006.
- 3,311,059. **BRIGHTDOOR AND DESIGN**. BRIGHTDOOR SYSTEMS, INC., (U.S. CLS. 100 AND 101). SN 77-073,401. PUB. 7-10-2007. FILED 12-29-2006.
- 3,311,070 (*See Class 41 for this trademark*).
- 3,311,098. **COLLABORATION ARCHITECT (BLOCK FORM)**. HEALTHGATE DATA CORP., (U.S. CLS. 100 AND 101). SN 77-074,405. PUB. 7-31-2007. FILED 1-2-2007.
- 3,311,102. **ZULULOG (BLOCK FORM)**. ZULULOG LLC, (U.S. CLS. 100 AND 101). SN 77-074,566. PUB. 7-31-2007. FILED 1-2-2007.
- 3,311,110 (*See Class 37 for this trademark*).
- 3,311,120. **ALPHALIT (BLOCK FORM)**. GRIFFITH INC, TA ALPHA SYSTEMS, (U.S. CLS. 100 AND 101). SN 77-075,176. PUB. 7-31-2007. FILED 1-3-2007.
- 3,311,136. **CENTURY SUBSEA (BLOCK FORM)**. GEO CENTURY, (U.S. CLS. 100 AND 101). SN 77-076,626. PUB. 7-31-2007. FILED 1-5-2007.
- 3,311,138. **GEO CENTURY (BLOCK FORM)**. GEO CENTURY, (U.S. CLS. 100 AND 101). SN 77-076,667. PUB. 7-31-2007. FILED 1-5-2007.
- 3,311,140 (*See Class 35 for this trademark*).
- 3,311,141 (*See Class 35 for this trademark*).
- 3,311,150. **THE ICONFACTORY (BLOCK FORM)**. THE ICONFACTORY, INC., (U.S. CLS. 100 AND 101). SN 77-077,716. PUB. 7-31-2007. FILED 1-8-2007.
- 3,311,168 (*See Class 35 for this trademark*).
- 3,311,172. **LOVELACE SCIENTIFIC RESOURCES (BLOCK FORM)**. LOVELACE IP, LLC, (U.S. CLS. 100 AND 101). SN 77-080,755. PUB. 7-31-2007. FILED 1-11-2007.
- 3,311,195 (*See Class 37 for this trademark*).
- 3,311,216 (*See Class 9 for this trademark*).
- 3,311,217. **UP2SPECS AND DESIGN**. LANIER, SEAN RICHARD, (U.S. CLS. 100 AND 101). SN 77-085,240. PUB. 7-31-2007. FILED 1-17-2007.
- 3,311,218. **ICCKE AND DESIGN**. INTERNATIONAL CONSORTIUM OF CERTIFIED KNOWLEDGE EXPERTS, (U.S. CLS. 100 AND 101). SN 77-085,292. PUB. 7-31-2007. FILED 1-18-2007.
- 3,311,229. **MYSSHERPA (BLOCK FORM)**. GMG SOLUTIONS, LLC, (U.S. CLS. 100 AND 101). SN 77-085,706. PUB. 7-31-2007. FILED 1-18-2007.
- 3,311,252. **ED3 ENVIRONMENTAL DISCLOSURE DUE DILIGENCE (BLOCK FORM)**. ADVANCED ENVIRONMENTAL DIMENSIONS, LLC, (U.S. CLS. 100 AND 101). SN 77-087,267. PUB. 7-31-2007. FILED 1-20-2007.
- 3,311,268. **BAGBY . INNOVATIVE IDEAS FOR LIGHTING . EST. 1918 AND DESIGN**. S. L. BAGBY CO., (U.S. CLS. 100 AND 101). SN 77-088,879. PUB. 7-31-2007. FILED 1-23-2007.
- 3,311,279. **MISCELLANEOUS DESIGN**. HOBLIN, JASON, (U.S. CLS. 100 AND 101). SN 77-089,744. PUB. 7-31-2007. FILED 1-24-2007.
- 3,311,306. **THE LEGAL ASSISTANT AND DESIGN**. THE LEGAL ASSISTANT, LLC, (U.S. CLS. 100 AND 101). SN 77-092,068. PUB. 7-31-2007. FILED 1-26-2007.
- 3,311,329 (*See Class 16 for this trademark*).
- 3,311,343. **DNA 2.0 (BLOCK FORM)**. DNA 2.0, (U.S. CLS. 100 AND 101). SN 77-094,915. PUB. 7-31-2007. FILED 1-30-2007.
- 3,311,356 (*See Class 35 for this trademark*).
- 3,311,390. **HAVE YOUR WAY WITH THE WEB (BLOCK FORM)**. OPENPAD, INC., (U.S. CLS. 100 AND 101). SN 77-098,002. PUB. 7-31-2007. FILED 2-2-2007.
- 3,311,404. **ASPIRE AND DESIGN**. MAPLE TECHNOLOGIES, LLC, (U.S. CLS. 100 AND 101). SN 77-098,388. PUB. 7-31-2007. FILED 2-2-2007.
- 3,311,450. **CONSUMATING (BLOCK FORM)**. CNET NETWORKS, INC., MULTIPLE CLASS, (INT. CLS. 42 AND 45), (U.S. CLS. 100 AND 101). SN 77-099,811. PUB. 7-31-2007. FILED 2-5-2007.
- 3,311,461. **GOTCODERS (STYLIZED)**. GOTCODERS, INC., (U.S. CLS. 100 AND 101). SN 77-100,759. PUB. 7-31-2007. FILED 2-6-2007.
- 3,311,496 (*See Class 9 for this trademark*).
- 3,311,527. **TRANSFORMING FLEET DATA INTO BUSINESS VALUE (BLOCK FORM)**. AUTOMOTIVE RENTALS, INC., (U.S. CLS. 100 AND 101). SN 77-112,636. PUB. 7-31-2007. FILED 2-21-2007.
- 3,311,540 (*See Class 36 for this trademark*).
- 3,311,563. **CUSTOM PERSPECTIVE (BLOCK FORM)**. CUSTOM PERSPECTIVE DESIGNS, (U.S. CLS. 100 AND 101). SN 77-123,993. PUB. 7-31-2007. FILED 3-7-2007.
- 3,311,610 (*See Class 38 for this trademark*).
- 3,311,616. **SIMULATELITE (BLOCK FORM)**. STAMPINGSIMULATION.COM PTY LTD., (U.S. CLS. 100 AND 101). SN 77-151,401. PUB. 7-31-2007. FILED 4-8-2007.
- 3,311,617. **SIMULATECOMPLETE (BLOCK FORM)**. STAMPINGSIMULATION.COM PTY LTD., (U.S. CLS. 100 AND 101). SN 77-151,404. PUB. 7-31-2007. FILED 4-8-2007.
- 3,311,626 (*See Class 9 for this trademark*).
- 3,311,628. **LIVINGHOME**. HOME PRODUCTS GROUP, INC., (U.S. CLS. 100 AND 101). SN 78-118,387. PUB. 7-31-2007. FILED 3-29-2002.
- 3,311,630 (*See Class 18 for this trademark*).
- 3,311,631 (*See Class 1 for this trademark*).
- 3,311,634 (*See Class 2 for this trademark*).
- 3,311,638 (*See Class 35 for this trademark*).
- 3,311,651 (*See Class 9 for this trademark*).
- 3,311,657. **ARC AND DESIGN**. FLEISCHACKER, STEPHEN J., (U.S. CLS. 100 AND 101). SN 78-447,481. PUB. 7-31-2007. FILED 7-8-2004.
- 3,311,663 (*See Class 9 for this trademark*).
- 3,311,666 (*See Class 9 for this trademark*).
- 3,311,668 (*See Class 9 for this trademark*).
- 3,311,687 (*See Class 9 for this trademark*).
- 3,311,693. **PUREDATA (BLOCK FORM)**. PUREDATA, LLC, (U.S. CLS. 100 AND 101). SN 78-561,553. PUB. 7-31-2007. FILED 2-7-2005.

- 3,311,696 (*See Class 3 for this trademark.*)
3,311,697 (*See Class 9 for this trademark.*)
3,311,700 (*See Class 9 for this trademark.*)
3,311,701 (*See Class 9 for this trademark.*)
3,311,750 (*See Class 5 for this trademark.*)
3,311,759 (*See Class 7 for this trademark.*)
3,311,762. **WORLD CLASS WEB HOSTING (BLOCK FORM).** PAIR NETWORKS, INC., (U.S. CLS. 100 AND 101). SN 78-688,872. PUB. 7-31-2007. FILED 8-9-2005.
3,311,768 (*See Class 10 for this trademark.*)
3,311,776 (*See Class 35 for this trademark.*)
3,311,783 (*See Class 35 for this trademark.*)
3,311,799. **PCM TECHNOLOGIES (BLOCK FORM).** PCM TECHNOLOGIES, INC., (U.S. CLS. 100 AND 101). SN 78-714,812. PUB. 7-31-2007. FILED 9-16-2005.
3,311,812 (*See Class 35 for this trademark.*)
3,311,814. **CHURCH BUTLER AND DESIGN.** SQUARE PEG SOFTWARE, LLC. (U.S. CLS. 100 AND 101). SN 78-725,933. PUB. 7-31-2007. FILED 10-4-2005.
3,311,816 (*See Class 6 for this trademark.*)
3,311,821 (*See Class 9 for this trademark.*)
3,311,849 (*See Class 9 for this trademark.*)
3,311,871 (*See Class 9 for this trademark.*)
3,311,881 (*See Class 9 for this trademark.*)
3,311,883 (*See Class 16 for this trademark.*)
3,311,894 (*See Class 35 for this trademark.*)
3,311,927 (*See Class 35 for this trademark.*)
3,311,935. **I AM GRAPHIC (BLOCK FORM).** THURMOND, SARAH, (U.S. CLS. 100 AND 101). SN 78-810,698. PUB. 7-31-2007. FILED 2-9-2006.
3,311,937. **AMERICAN CTR (BLOCK FORM).** AMERICAN CONSULTING TECHNOLOGY & RESEARCH, INC., (U.S. CLS. 100 AND 101). SN 78-811,561. PUB. 7-31-2007. FILED 2-9-2006.
3,311,980. **ASSURESIGN AND DESIGN.** THIRD PARTY VERIFICATION, INC., (U.S. CLS. 100 AND 101). SN 78-838,186. PUB. 7-31-2007. FILED 3-15-2006.
3,311,989 (*See Class 9 for this trademark.*)
3,311,990 (*See Class 37 for this trademark.*)
3,312,000 (*See Class 9 for this trademark.*)
3,312,013 (*See Class 9 for this trademark.*)
3,312,026. **DOCUMENT CODE ED PLUS (BLOCK FORM).** MEDQUIST IP CORPORATION, (U.S. CLS. 100 AND 101). SN 78-854,491. PUB. 7-31-2007. FILED 4-5-2006.
3,312,034 (*See Class 35 for this trademark.*)
3,312,047. **PRIZEFLIGHT AND DESIGN.** PRIZEFLIGHT L.L.C., (U.S. CLS. 100 AND 101). SN 78-860,413. PUB. 7-31-2007. FILED 4-12-2006.
3,312,059. **THE LENDER'S EDGE (BLOCK FORM).** DEXMA, INC., (U.S. CLS. 100 AND 101). SN 78-864,245. PUB. 7-31-2007. FILED 4-18-2006.
3,312,063. **SPECTRUM BUILDING SYSTEMS, INC. AND DESIGN.** SPECTRUM BUILDING SYSTEMS, INC., (U.S. CLS. 100 AND 101). SN 78-865,087. PUB. 7-31-2007. FILED 4-19-2006.
3,312,090 (*See Class 35 for this trademark.*)
3,312,136. **THE SHEAFFER SYSTEM (BLOCK FORM).** SHEAFFER INTERNATIONAL, LLC, (U.S. CLS. 100 AND 101). SN 78-876,749. PUB. 7-31-2007. FILED 5-4-2006.
3,312,142 (*See Class 35 for this trademark.*)
3,312,172. **THE SHOPPERTRAK EASY STAFFING PLANNER (BLOCK FORM).** SHOPPERTRAK RCT CORPORATION, (U.S. CLS. 100 AND 101). SN 78-881,465. PUB. 7-31-2007. FILED 5-11-2006.
3,312,176. **EPREPARE (BLOCK FORM).** INGEO SYSTEMS, INC., (U.S. CLS. 100 AND 101). SN 78-882,385. PUB. 7-31-2007. FILED 5-12-2006.
3,312,179. **FLORENSICS (BLOCK FORM).** WABEKE, JOHN A., (U.S. CLS. 100 AND 101). SN 78-882,674. PUB. 7-31-2007. FILED 5-12-2006.
3,312,180 (*See Class 9 for this trademark.*)
3,312,185 (*See Class 9 for this trademark.*)
3,312,255 (*See Class 7 for this trademark.*)
3,312,256 (*See Class 7 for this trademark.*)
3,312,259. **WED O RAMA.COM AND DESIGN.** THE KNOT, INC., (U.S. CLS. 100 AND 101). SN 78-896,970. PUB. 7-31-2007. FILED 5-31-2006.
3,312,266. **UNHCEMS (BLOCK FORM).** UNIVERSITY OF NEW HAMPSHIRE, (U.S. CLS. 100 AND 101). SN 78-897,899. PUB. 7-31-2007. FILED 6-1-2006.
3,312,304. **THE ECLIPSE GROUP (BLOCK FORM).** THE ECLIPSE GROUP LLP, (U.S. CLS. 100 AND 101). SN 78-905,116. PUB. 7-31-2007. FILED 6-9-2006.
3,312,325. **PACKAGING POST (BLOCK FORM).** PACKAGING POST, INC., (U.S. CLS. 100 AND 101). SN 78-908,207. PUB. 7-31-2007. FILED 6-14-2006.
3,312,339 (*See Class 36 for this trademark.*)
3,312,351. **DEALER LAW AUTOMOBILE PRACTICE GROUP AND DESIGN.** RAY QUINNEY & NEBEKER, P.C., (U.S. CLS. 100 AND 101). SN 78-913,184. PUB. 7-31-2007. FILED 6-21-2006.
3,312,355. **TEST BOOKING CENTER (BLOCK FORM).** TRAVELZOO INC., (U.S. CLS. 100 AND 101). SN 78-913,730. PUB. 7-31-2007. FILED 6-21-2006.
3,312,383 (*See Class 35 for this trademark.*)
3,312,414 (*See Class 16 for this trademark.*)
3,312,423. **ENS (BLOCK FORM).** ROUX ASSOCIATES, INC., (U.S. CLS. 100 AND 101). SN 78-924,493. PUB. 7-31-2007. FILED 7-7-2006.
3,312,445 (*See Class 35 for this trademark.*)
3,312,469 (*See Class 37 for this trademark.*)
3,312,476 (*See Class 9 for this trademark.*)
3,312,477 (*See Class 35 for this trademark.*)
3,312,482. **APPSNOW (BLOCK FORM).** ADESSO SYSTEMS, INC., (U.S. CLS. 100 AND 101). SN 78-932,201. PUB. 7-31-2007. FILED 7-18-2006.
3,312,494. **A NCGS NATIONAL COIN GRADING SERVICE AND DESIGN.** MELLICK, CARL, AND MELLICK, ELKE, (U.S. CLS. 100 AND 101). SN 78-934,770. PUB. 7-31-2007. FILED 7-21-2006.
3,312,502 (*See Class 37 for this trademark.*)
3,312,517 (*See Class 37 for this trademark.*)
3,312,527. **EIGHT INC. (BLOCK FORM).** EIGHT HOLDING INC., (U.S. CLS. 100 AND 101). SN 78-940,454. PUB. 7-31-2007. FILED 7-28-2006.
3,312,535 (*See Class 35 for this trademark.*)
3,312,562 (*See Class 37 for this trademark.*)
3,312,585 (*See Class 9 for this trademark.*)
3,312,586. **DMAC SOLUTIONS (BLOCK FORM).** REGION VII EDUCATION SERVICE CENTER, (U.S. CLS. 100 AND 101). SN 78-955,608. PUB. 7-31-2007. FILED 8-18-2006.
3,312,600. **LOGICBLOX (BLOCK FORM).** LOGICBLOX, INC., (U.S. CLS. 100 AND 101). SN 78-958,477. PUB. 7-31-2007. FILED 8-23-2006.
3,312,622 (*See Class 35 for this trademark.*)
3,312,623. **INVOICE WAREHOUSE (BLOCK FORM).** PETROSOFT, INC., (U.S. CLS. 100 AND 101). SN 78-961,706. PUB. 7-31-2007. FILED 8-28-2006.
3,312,635. **FISH DOES IT RIGHT (BLOCK FORM).** FISH & RICHARDSON P.C., (U.S. CLS. 100 AND 101). SN 78-963,843. PUB. 7-31-2007. FILED 8-30-2006.
3,312,660 (*See Class 38 for this trademark.*)
3,312,703 (*See Class 9 for this trademark.*)
3,312,712 (*See Class 1 for this trademark.*)
3,312,720 (*See Class 9 for this trademark.*)
3,312,721 (*See Class 9 for this trademark.*)
3,312,723 (*See Class 7 for this trademark.*)
3,312,729 (*See Class 9 for this trademark.*)
3,312,733 (*See Class 9 for this trademark.*)
3,312,748 (*See Class 20 for this trademark.*)
3,312,756 (*See Class 6 for this trademark.*)
3,312,758 (*See Class 9 for this trademark.*)
3,312,763 (*See Class 16 for this trademark.*)
3,312,788 (*See Class 9 for this trademark.*)
3,312,794 (*See Class 9 for this trademark.*)
3,312,799 (*See Class 9 for this trademark.*)
3,312,818 (*See Class 1 for this trademark.*)
3,312,829 (*See Class 9 for this trademark.*)
3,312,830 (*See Class 9 for this trademark.*)
3,312,848 (*See Class 16 for this trademark.*)
3,312,850 (*See Class 9 for this trademark.*)
3,312,857 (*See Class 11 for this trademark.*)
3,312,859 (*See Class 5 for this trademark.*)
3,312,867 (*See Class 9 for this trademark.*)
3,312,878 (*See Class 36 for this trademark.*)
3,312,879 (*See Class 9 for this trademark.*)

3,312,891 (*See Class 9 for this trademark*).
 3,312,894 (*See Class 18 for this trademark*).
 3,312,901 (*See Class 9 for this trademark*).
 3,312,904 (*See Class 9 for this trademark*).
 3,312,912 (*See Class 7 for this trademark*).
 3,312,923 (*See Class 6 for this trademark*).
 3,312,924 (*See Class 6 for this trademark*).
 3,312,926 (*See Class 5 for this trademark*).
 3,312,932 (*See Class 6 for this trademark*).
 3,312,936 (*See Class 9 for this trademark*).
 3,312,946 (*See Class 9 for this trademark*).
 3,312,948 (*See Class 9 for this trademark*).
 3,312,952 (*See Class 1 for this trademark*).
 3,312,967. **DTOOLS (BLOCK FORM)**. DIABETES TOOLS SWEDEN AB, (U.S. CLS. 100 AND 101). SN 79-035,651. PUB. 7-31-2007. FILED 12-29-2006.

CLASS 43—HOTEL AND RESTAURANT SERVICES

3,310,274. **THE REAL CHOW BABY NEW AMERICAN STIR FRY AND DESIGN**. RED RESTAURANT VENTURES, LLC, (U.S. CLS. 100 AND 101). SN 76-649,999. PUB. 7-31-2007. FILED 11-8-2005.
 3,310,275. **Q AND DESIGN**. LOMBARDO, STEPHEN J., (U.S. CLS. 100 AND 101). SN 76-650,226. PUB. 7-31-2007. FILED 11-14-2005.
 3,310,360. **LILA'S (STYLIZED)**. LILA'S RESTAURANT, INC., (U.S. CLS. 100 AND 101). SN 76-666,847. PUB. 7-31-2007. FILED 9-29-2006.
 3,310,362. **HINEY'S AND DESIGN**. VISCAR, INC., (U.S. CLS. 100 AND 101). SN 76-667,116. PUB. 7-31-2007. FILED 10-10-2006.
 3,310,387. **BRASILIA GRILL AND DESIGN**. BRASILIA GRILL INC, (U.S. CLS. 100 AND 101). SN 76-670,165. PUB. 7-31-2007. FILED 12-11-2006.
 3,310,396. **THE RED ELEPHANT PIZZA AND GRILL (BLOCK FORM)**. THE RED ELEPHANT, LLC, (U.S. CLS. 100 AND 101). SN 76-670,606. PUB. 7-31-2007. FILED 12-19-2006.
 3,310,420. **PRESTOFRESCO (BLOCK FORM)**. 1580605 ONTARIO INC., (U.S. CLS. 100 AND 101). SN 76-672,398. PUB. 7-31-2007. FILED 2-6-2007.
 3,310,427. **BAGUETTE FACTORY (BLOCK FORM)**. LEE'S SANDWICHES INTERNATIONA, INC., (U.S. CLS. 100 AND 101). SN 77-000,077. PUB. 7-31-2007. FILED 9-15-2006.
 3,310,530 (*See Class 41 for this trademark*).
 3,310,591 (*See Class 29 for this trademark*).
 3,310,611. **FEAST OF EDEN CREATING FINE FOODS AND DESIGN**. BELLAN, LISA B., (U.S. CLS. 100 AND 101). SN 77-032,061. PUB. 7-31-2007. FILED 10-30-2006.
 3,310,668. **THE BAKE & BREW CAFE' AND DESIGN**. PROPOCO, INC., (U.S. CLS. 100 AND 101). SN 77-042,363. PUB. 7-10-2007. FILED 11-13-2006.
 3,310,728 (*See Class 39 for this trademark*).
 3,310,778. **BEYOND BANQUETS (BLOCK FORM)**. MERRITT HOSPITALITY, LLC, (U.S. CLS. 100 AND 101). SN 77-058,707. PUB. 7-31-2007. FILED 12-7-2006.
 3,310,820 (*See Class 39 for this trademark*).
 3,310,835. **AMOR FIERI STEAKHOUSE DE BRAZIL (BLOCK FORM)**. COPELAND, AL C., (U.S. CLS. 100 AND 101). SN 77-065,386. PUB. 7-31-2007. FILED 12-15-2006.
 3,310,928. **SUBWAY COME SABROSO Y FRESCO. (STYLIZED)**. DOCTOR'S ASSOCIATES INC., (U.S. CLS. 100 AND 101). SN 77-070,239. PUB. 7-31-2007. FILED 12-22-2006.
 3,310,966. **HOLEY SMOKES BBQ (BLOCK FORM)**. WASNEY, DAVID A., (U.S. CLS. 100 AND 101). SN 77-071,409. PUB. 7-31-2007. FILED 12-26-2006.
 3,310,983. **EAT. DRINK. SCORE (BLOCK FORM)**. LYONS GROUP, LTD., (U.S. CLS. 100 AND 101). SN 77-071,936. PUB. 7-31-2007. FILED 12-27-2006.
 3,310,985. **FRESHWAY SUBS & SALADS (BLOCK FORM)**. FRESHWAY FOOD SYSTEMS, INC., (U.S. CLS. 100 AND 101). SN 77-072,050. PUB. 7-31-2007. FILED 12-27-2006.
 3,311,033. **SARAH K'S GOURMET (BLOCK FORM)**. SCHREIFER, SARAH K., (U.S. CLS. 100 AND 101). SN 77-072,861. PUB. 7-31-2007. FILED 12-28-2006.
 3,311,053. **ENERGY KITCHEN AND DESIGN**. ENERGY KITCHEN, INC., (U.S. CLS. 100 AND 101). SN 77-073,361. PUB. 7-31-2007. FILED 12-29-2006.
 3,311,060. **THE CHICKEN BONE (STYLIZED)**. RODENHISER, WILLIAM, (U.S. CLS. 100 AND 101). SN 77-073,416. PUB. 7-31-2007. FILED 12-29-2006.
 3,311,061. **MISCELLANEOUS DESIGN**. RODENHISER, WILLIAM, (U.S. CLS. 100 AND 101). SN 77-073,423. PUB. 7-31-2007. FILED 12-29-2006.
 3,311,104. **CRAIG O'S PIZZA & PASTARIA HOMESTYLE ITALIAN COOKING AND DESIGN**. ROXS, INC., (U.S. CLS. 100 AND 101). SN 77-074,644. PUB. 7-31-2007. FILED 1-2-2007.
 3,311,142. **BOW WOW BUNGALOW (BLOCK FORM)**. SUSIE AGA, (U.S. CLS. 100 AND 101). SN 77-076,905. PUB. 7-31-2007. FILED 1-5-2007.
 3,311,154. **MISCELLANEOUS DESIGN**. PICA POLLOS VICTORINA CORP., (U.S. CLS. 100 AND 101). SN 77-078,643. PUB. 7-31-2007. FILED 1-9-2007.
 3,311,191. **THE SHANNON ROSE IRISH PUB AND DESIGN**. DONEGAL'S IRISH PUB, LLC, (U.S. CLS. 100 AND 101). SN 77-082,385. PUB. 7-31-2007. FILED 1-12-2007.
 3,311,261. **KINGS SMOKEHOUSE & GRILL AND DESIGN**. KINGS SMOKEHOUSE AND GRILL, (U.S. CLS. 100 AND 101). SN 77-088,156. PUB. 7-31-2007. FILED 1-22-2007.
 3,311,283. **MISS KIMBERLY'S (BLOCK FORM)**. MISS KIMBERLY'S DAY CARE CENTER INC., (U.S. CLS. 100 AND 101). SN 77-089,971. PUB. 7-31-2007. FILED 1-24-2007.
 3,311,292. **THE ARTFUL DINER AND DESIGN**. NAMENDORF, ARTHUR R., (U.S. CLS. 100 AND 101). SN 77-090,539. PUB. 7-31-2007. FILED 1-24-2007.
 3,311,302. **SABRI NEHARI (BLOCK FORM)**. SABRI NIHARI, INC., (U.S. CLS. 100 AND 101). SN 77-091,347. PUB. 7-31-2007. FILED 1-25-2007.
 3,311,305. **CREATIVE DINING SERVICES (BLOCK FORM)**. CREATIVE DINING SERVICES, INC., (U.S. CLS. 100 AND 101). SN 77-091,839. PUB. 7-31-2007. FILED 1-26-2007.
 3,311,318. **THE GRILLROOM CHOPHOUSE & WINEBAR AND DESIGN**. CONCEPTS TRADEMARK INC., (U.S. CLS. 100 AND 101). SN 77-093,401. PUB. 7-31-2007. FILED 1-29-2007.
 3,311,353. **SHADE (BLOCK FORM)**. MANHATTAN INN OPERATING COMPANY, LLC, (U.S. CLS. 100 AND 101). SN 77-095,972. PUB. 7-31-2007. FILED 1-31-2007.
 3,311,388. **TOUREEN PET RESORT & SPA (BLOCK FORM)**. TOUREEN BOARDING KENNELS, INC., (U.S. CLS. 100 AND 101). SN 77-097,865. PUB. 7-31-2007. FILED 2-2-2007.
 3,311,395. **LA RYAN AND DESIGN**. FLORES BANQUETS CORPORATION, (U.S. CLS. 100 AND 101). SN 77-098,200. PUB. 7-31-2007. FILED 2-2-2007.
 3,311,410. **RUN AGROUNDS (BLOCK FORM)**. CAFFEINE DREAMS, INC., (U.S. CLS. 100 AND 101). SN 77-098,630. PUB. 7-31-2007. FILED 2-3-2007.
 3,311,459. **GIVE LIFE A SLICE (BLOCK FORM)**. AL'S PIZZA, INC., (U.S. CLS. 100 AND 101). SN 77-100,612. PUB. 7-31-2007. FILED 2-6-2007.
 3,311,531. **TIMES GRILL WORLD FAMOUS HAMBURGERS (BLOCK FORM)**. TIMES GRILL RESTAURANT GROUP, LLC, (U.S. CLS. 100 AND 101). SN 77-113,507. PUB. 7-31-2007. FILED 2-22-2007.
 3,311,611. **HOT STUFF PIZZA AND DESIGN**. HOT STUFF FOODS, LLC, (U.S. CLS. 100 AND 101). SN 77-149,562. PUB. 7-31-2007. FILED 4-5-2007.
 3,311,623. **QUALITY MYRON'S DELICATESSEN FIRST AND DESIGN**. ISLE OF CAPRI CASINOS, INC., (U.S. CLS. 100 AND 101). SN 77-165,998. PUB. 7-31-2007. FILED 4-26-2007.
 3,311,648. **FIFTH ALARM FIREHOUSE PUB BYRON ILLINOIS AND DESIGN**. FIFTH ALARM, INC., (U.S. CLS. 100 AND 101). SN 78-357,308. PUB. 7-31-2007. FILED 1-26-2004.
 3,311,656. **HOMETOWN BUFFET AND DESIGN**. BUFFETS, INC., (U.S. CLS. 100 AND 101). SN 78-442,222. PUB. 7-31-2007. FILED 6-28-2004.
 3,311,658. **PAZZALUNA AND DESIGN**. 350 MARKET STREET, INC., (U.S. CLS. 100 AND 101). SN 78-450,662. PUB. 7-31-2007. FILED 7-14-2004.
 3,311,688 (*See Class 30 for this trademark*).
 3,311,696 (*See Class 3 for this trademark*).
 3,311,716 (*See Class 35 for this trademark*).

- 3,311,721 (*See Class 3 for this trademark*).
3,311,737. **JUAN VALDEZ (STYLIZED)**. FEDERACION NACIONAL DE CAFETEROS DE COLOMBIA, AKA NATIONAL FEDERATION OF COFFEE GROWER OF COLOMBIA, (U.S. CLS. 100 AND 101). SN 78-654,656. PUB. 7-31-2007. FILED 6-20-2005.
3,311,739. **VEGAS.COM AND DESIGN**. VEGAS.COM, LLC, (U.S. CLS. 100 AND 101). SN 78-656,252. PUB. 7-31-2007. FILED 6-22-2005.
3,311,790. **SUPERSAVER-HOTELS.COM (BLOCK FORM)**. SCHUMACHER PAINTING INC., (U.S. CLS. 100 AND 101). SN 78-707,143. PUB. 4-24-2007. FILED 9-6-2005.
3,311,813 (*See Class 35 for this trademark*).
3,311,817. **SONIO'S CAFE & ROTISSERIE AND DESIGN**. ARETOS, YIORGO, (U.S. CLS. 100 AND 101). SN 78-727,445. PUB. 7-31-2007. FILED 10-5-2005.
3,311,825 (*See Class 39 for this trademark*).
3,311,833. **PARAMOUNT AND DESIGN**. SIGNATURE CHEF COMPANY, LLC, (U.S. CLS. 100 AND 101). SN 78-737,638. PUB. 4-24-2007. FILED 10-20-2005.
3,311,868 (*See Class 25 for this trademark*).
3,311,913. **ROADRUNNER DINER (BLOCK FORM)**. LAGUNA DEVELOPMENT CORPORATION, (U.S. CLS. 100 AND 101). SN 78-800,478. PUB. 4-10-2007. FILED 1-26-2006.
3,311,941. **PANORAMA CITY (BLOCK FORM)**. PANORAMA CITY, (U.S. CLS. 100 AND 101). SN 78-815,782. PUB. 7-31-2007. FILED 2-15-2006.
3,311,944 (*See Class 36 for this trademark*).
3,311,956. **LA CASA QUE CANTA (BLOCK FORM)**. BALDASARI, JACQUES V., (U.S. CLS. 100 AND 101). SN 78-827,213. PUB. 7-31-2007. FILED 3-2-2006.
3,311,965 (*See Class 33 for this trademark*).
3,311,970 (*See Class 39 for this trademark*).
3,311,971 (*See Class 39 for this trademark*).
3,312,028. **MOCHALISA'S CAFFÈ AND DESIGN**. SERIANNI, MICHAEL, A., (U.S. CLS. 100 AND 101). SN 78-854,640. PUB. 7-31-2007. FILED 4-5-2006.
3,312,041. **SELDOM BLUES PLAY HERE AND DESIGN**. SELDOM BLUES, LLC, (U.S. CLS. 100 AND 101). SN 78-859,100. PUB. 7-31-2007. FILED 4-11-2006.
3,312,050. **SAINTE CLAIRE (BLOCK FORM)**. LARKSPUR HOTELS, LLC, (U.S. CLS. 100 AND 101). SN 78-861,304. PUB. 7-31-2007. FILED 4-13-2006.
3,312,069. **SPOONFUL AND DESIGN**. COOKING DEVELOPMENT LIMITED, (U.S. CLS. 100 AND 101). SN 78-866,128. PUB. 7-31-2007. FILED 4-20-2006.
3,312,130. **BAKED ON THE BRICKS (BLOCK FORM)**. PIZZA HAUS, INC., (U.S. CLS. 100 AND 101). SN 78-875,794. PUB. 7-31-2007. FILED 5-3-2006.
3,312,197. **SOUTHERN MANOR LIVING CENTERS (BLOCK FORM)**. SOUTHERN MANOR LIVING CENTERS, LLC, (U.S. CLS. 100 AND 101). SN 78-885,431. PUB. 7-31-2007. FILED 5-17-2006.
3,312,271. **KERRI OUT FOOD AND DESIGN**. NEW ENGLAND BROADCASTING AND ENTERTAINMENT CO., INC., (U.S. CLS. 100 AND 101). SN 78-899,322. PUB. 7-31-2007. FILED 6-2-2006.
3,312,276 (*See Class 36 for this trademark*).
3,312,292 (*See Class 41 for this trademark*).
3,312,322. **THE STICKHOUSE GRILLE (BLOCK FORM)**. ASHEVILLE RESTAURANT GROUP, LLC, (U.S. CLS. 100 AND 101). SN 78-907,783. PUB. 7-31-2007. FILED 6-14-2006.
3,312,329. **LATCHKEY CHILD SERVICES, INC. AND DESIGN**. LATCHKEY CHILD SERVICES, INC., (U.S. CLS. 100 AND 101). SN 78-909,230. PUB. 7-31-2007. FILED 6-15-2006.
3,312,340. **LOLLICUP AND DESIGN**. LOLLICUP USA INC., (U.S. CLS. 100 AND 101). SN 78-911,685. PUB. 7-31-2007. FILED 6-19-2006.
3,312,343 (*See Class 41 for this trademark*).
3,312,352 (*See Class 29 for this trademark*).
3,312,420. **SAM'S ITALIAN FOODS AND DESIGN**. SAM'S ITALIAN FOODS, (U.S. CLS. 100 AND 101). SN 78-924,174. PUB. 7-31-2007. FILED 7-7-2006.
3,312,434 (*See Class 41 for this trademark*).
3,312,456. **CALIFORNIA STYLE DELI AND DESIGN**. RABA INC., (U.S. CLS. 100 AND 101). SN 78-928,652. PUB. 7-31-2007. FILED 7-13-2006.
3,312,459. **CORNERSTONE G.R.L.LL DIVINE GRILLING & CATERING AND DESIGN**. COX, MARVIN K., (U.S. CLS. 100 AND 101). SN 78-928,913. PUB. 7-10-2007. FILED 7-13-2006.
3,312,479. **BELEZA (BLOCK FORM)**. ULLIO, RICCARDO, (U.S. CLS. 100 AND 101). SN 78-931,947. PUB. 7-31-2007. FILED 7-18-2006.
3,312,492. **BONDI AND DESIGN**. BONDI LIFESAVER HOLDINGS PTY LTD, (U.S. CLS. 100 AND 101). SN 78-934,080. PUB. 7-31-2007. FILED 7-20-2006.
3,312,507. **VINEA IBERICOS & VINOS (BLOCK FORM)**. AREAS, S.A., (U.S. CLS. 100 AND 101). SN 78-936,929. PUB. 7-31-2007. FILED 7-25-2006.
3,312,516. **PERKATORY COFFEE HOUSE "A HELLUVA HEAVENLY CUP OF COFFEE" AND DESIGN**. MORETTI, PATRICIA B., (U.S. CLS. 100 AND 101). SN 78-938,853. PUB. 7-31-2007. FILED 7-27-2006.
3,312,526. **BIG APPLE BAR AND DESIGN**. NEW YORK-NEW YORK HOTEL & CASINO, LLC, (U.S. CLS. 100 AND 101). SN 78-940,314. PUB. 7-31-2007. FILED 7-28-2006.
3,312,590. **ORANGE MOOSE (BLOCK FORM)**. ARROWHEAD LODGE, INC., (U.S. CLS. 100 AND 101). SN 78-957,313. PUB. 4-10-2007. FILED 8-22-2006.
3,312,621 (*See Class 30 for this trademark*).
3,312,633 (*See Class 25 for this trademark*).
3,312,670. **OBAR AND DESIGN**. TJM DEVELOPMENT GP, LLC, (U.S. CLS. 100 AND 101). SN 78-970,359. PUB. 7-31-2007. FILED 9-8-2006.
3,312,688 (*See Class 36 for this trademark*).
3,312,719 (*See Class 32 for this trademark*).
3,312,817. **ACCOR AS GUESTS OF THE EARTH, WE WELCOME THE WORLD AND DESIGN**. ACCOR, (U.S. CLS. 100 AND 101). SN 79-027,186. PUB. 7-31-2007. FILED 5-17-2006.
3,312,869. **LATE ROOMS .COM AND DESIGN**. LATE ROOMS LTD, (U.S. CLS. 100 AND 101). SN 79-029,142. PUB. 7-31-2007. FILED 8-1-2006.
3,312,896 (*See Class 29 for this trademark*).
3,312,933 (*See Class 39 for this trademark*).

CLASS 44—MEDICAL, BEAUTY AND AGRICULTURAL SERVICES

- 3,310,201. **ESMARTIMAGING (BLOCK FORM)**. GALPERIN, MICHAEL, (U.S. CLS. 100 AND 101). SN 75-860,124. PUB. 7-31-2007. FILED 12-13-1999.
3,310,236. **VISTACARE EXCELLENCE WITHOUT EXCEPTION. AND DESIGN**. VISTACARE, INC., (U.S. CLS. 100 AND 101). SN 76-560,563. PUB. 7-31-2007. FILED 10-28-2003.
3,310,260 (*See Class 10 for this trademark*).
3,310,448. **PNHSOURCE (BLOCK FORM)**. ALEXION PHARMACEUTICALS, INC., (U.S. CLS. 100 AND 101). SN 77-004,279. PUB. 7-31-2007. FILED 9-21-2006.
3,310,466. **CHAVEZ RANCH CR AND DESIGN**. LOS CABALLOS DEL VALLE, INC., (U.S. CLS. 100 AND 101). SN 77-007,761. PUB. 7-31-2007. FILED 9-26-2006.
3,310,485. **MOW MY LAWN (BLOCK FORM)**. GEIER, WILLIAM A., (U.S. CLS. 100 AND 101). SN 77-011,181. PUB. 7-31-2007. FILED 9-30-2006.
3,310,490. **THE ART AND SCIENCE OF VISION (BLOCK FORM)**. INVISION EYECARE, INC., (U.S. CLS. 100 AND 101). SN 77-011,485. PUB. 7-31-2007. FILED 10-2-2006.
3,310,500 (*See Class 36 for this trademark*).
3,310,524 (*See Class 41 for this trademark*).
3,310,568. **SPA SOLE SO GOOD AND DESIGN**. HELEN LUO LLC., (U.S. CLS. 100 AND 101). SN 77-023,895. PUB. 6-26-2007. FILED 10-18-2006.
3,310,579. **MISCELLANEOUS DESIGN**. INSIGHT HEALTH CORP., (U.S. CLS. 100 AND 101). SN 77-025,770. PUB. 7-31-2007. FILED 10-20-2006.
3,310,610. **"THE GROOMING SUITE" (BLOCK FORM)**. PERAZA, DIANE, (U.S. CLS. 100 AND 101). SN 77-032,036. PUB. 7-31-2007. FILED 10-30-2006.
3,310,613. **PACIFICASPINE (BLOCK FORM)**. MARK SIMONSON, MD, (U.S. CLS. 100 AND 101). SN 77-032,146. PUB. 7-31-2007. FILED S.R. 10-30-2006; AM. P.R. 6-27-2007.
3,310,614. **SPINETEAMSPOKANE (BLOCK FORM)**. DAN DIBBLE, MD, (U.S. CLS. 100 AND 101). SN 77-032,159.

- PUB. 7-31-2007. FILED S.R. 10-30-2006; AM. P.R. 6-27-2007.
3,310,623 (*See Class 41 for this trademark*).
- 3,310,643. **FLUSH RENTALS WWW.FLUSHRENTALS.COM AND DESIGN**. SAN DIEGO PORTABLE RENTALS LLC, (U.S. CLS. 100 AND 101). SN 77-038,130. PUB. 7-31-2007. FILED 11-7-2006.
- 3,310,661. **HEARTSONG AND DESIGN**. HEARTSONG, INC., (U.S. CLS. 100 AND 101). SN 77-041,373. PUB. 7-31-2007. FILED 11-10-2006.
- 3,310,666. **RENEW AND DESIGN**. WYETH, (U.S. CLS. 100 AND 101). SN 77-041,719. PUB. 7-31-2007. FILED 11-10-2006.
- 3,310,670. **NEW ENGLAND ORTHOPEDIC SPECIALISTS AND DESIGN**. NEW ENGLAND ORTHOPEDIC SPECIALISTS, (U.S. CLS. 100 AND 101). SN 77-042,503. PUB. 7-31-2007. FILED 11-13-2006.
- 3,310,743 (*See Class 41 for this trademark*).
- 3,310,756 (*See Class 9 for this trademark*).
- 3,310,757 (*See Class 35 for this trademark*).
- 3,310,760. **ENLIGHTENED DENTISTRY (BLOCK FORM)**. BRAND, IDELLE, S., (U.S. CLS. 100 AND 101). SN 77-055,926. PUB. 7-31-2007. FILED 12-2-2006.
- 3,310,901 (*See Class 41 for this trademark*).
- 3,310,910. **LE MEDSPA AND DESIGN**. STIEFLER, PAULE, (U.S. CLS. 100 AND 101). SN 77-069,231. PUB. 7-31-2007. FILED 12-21-2006.
- 3,310,919 (*See Class 1 for this trademark*).
- 3,310,921 (*See Class 1 for this trademark*).
- 3,310,929. **ASSISTING HANDS HOME CARE AND DESIGN**. ASSISTING HANDS HOME CARE, LLC, (U.S. CLS. 100 AND 101). SN 77-070,335. PUB. 7-31-2007. FILED 12-22-2006.
- 3,310,943. **MANCINI GIUFFRE SALON (BLOCK FORM)**. MANCINI GIUFFRE SALON, LTD, (U.S. CLS. 100 AND 101). SN 77-070,716. PUB. 7-31-2007. FILED 12-22-2006.
- 3,311,043. **HYPERFORMANCE RELAXATION (BLOCK FORM)**. FOX, JESSICA L, AND FOX, TRAVIS W, (U.S. CLS. 100 AND 101). SN 77-073,174. PUB. 7-31-2007. FILED 12-29-2006.
- 3,311,100. **CLOSECARE (BLOCK FORM)**. TERRY L. JACOBSON, MD, PLLC, (U.S. CLS. 100 AND 101). SN 77-074,515. PUB. 7-31-2007. FILED 1-2-2007.
- 3,311,111. **6 WEEKS TO A NEW YOU! (BLOCK FORM)**. PERSONAL NEWTRITION, LLC, (U.S. CLS. 100 AND 101). SN 77-074,827. PUB. 7-31-2007. FILED 1-3-2007.
- 3,311,151 (*See Class 3 for this trademark*).
- 3,311,193. **MG BEAUTY (BLOCK FORM)**. GREEN, MINDY L., (U.S. CLS. 100 AND 101). SN 77-082,465. PUB. 7-31-2007. FILED 1-12-2007.
- 3,311,206. **WORKING HOOF (BLOCK FORM)**. TUCKER, JOHN E., (U.S. CLS. 100 AND 101). SN 77-083,332. PUB. 7-31-2007. FILED 1-15-2007.
- 3,311,219. **DIABETES AMERICA (BLOCK FORM)**. DIABETES AMERICA, INC., (U.S. CLS. 100 AND 101). SN 77-085,403. PUB. 7-31-2007. FILED 1-18-2007.
- 3,311,228. **FS GREEN PLAN SOLUTIONS ON-FARM DISCOVERY (BLOCK FORM)**. GROWMARK, INC., (U.S. CLS. 100 AND 101). SN 77-085,698. PUB. 7-31-2007. FILED 1-18-2007.
- 3,311,241. **FS GREEN PLAN SOLUTIONS (BLOCK FORM)**. GROWMARK, INC., (U.S. CLS. 100 AND 101). SN 77-086,298. PUB. 7-31-2007. FILED 1-19-2007.
- 3,311,266. **APHASIA REHABILITATION WITH RE-LEARNING USING CONSTRAINT PRINCIPLES (ARRC-P) (BLOCK FORM)**. ADVANCED RECOVERY REHABILITATION CENTER, (U.S. CLS. 100 AND 101). SN 77-088,403. PUB. 7-31-2007. FILED 1-22-2007.
- 3,311,350. **REGAL NAILS (BLOCK FORM)**. REGAL NAILS, L.L.C., (U.S. CLS. 100 AND 101). SN 77-095,746. PUB. 7-31-2007. FILED 1-31-2007.
- 3,311,368. **VISUALDXHEALTH (BLOCK FORM)**. LOGICAL IMAGES, INC., (U.S. CLS. 100 AND 101). SN 77-096,912. PUB. 7-31-2007. FILED 2-1-2007.
- 3,311,497. **HOMETOWNMD YOUR PERSONAL PHYSICIAN AND DESIGN**. JON E. HEMSTREET M.D. P.A., (U.S. CLS. 100 AND 101). SN 77-104,934. PUB. 7-31-2007. FILED 2-12-2007.
- 3,311,511 (*See Class 35 for this trademark*).
- 3,311,525 (*See Class 35 for this trademark*).
- 3,311,537 (*See Class 41 for this trademark*).
- 3,311,559 (*See Class 16 for this trademark*).
- 3,311,560 (*See Class 35 for this trademark*).
- 3,311,631 (*See Class 1 for this trademark*).
- 3,311,650 (*See Class 41 for this trademark*).
- 3,311,680. **YCARE (BLOCK FORM)**. STEINER MARKS LIMITED, (U.S. CLS. 100 AND 101). SN 78-551,408. PUB. 10-11-2005. FILED 1-21-2005.
- 3,311,696 (*See Class 3 for this trademark*).
- 3,311,726. **MEDEXPRESS (BLOCK FORM)**. MEDEXPRESS URGENT CARE HOLDING CO., INC., (U.S. CLS. 100 AND 101). SN 78-647,080. PUB. 4-24-2007. FILED S.R. 6-9-2005; AM. P.R. 1-16-2007.
- 3,311,736. **DMS (BLOCK FORM)**. KUHTZ, LEE C., (U.S. CLS. 100 AND 101). SN 78-654,272. PUB. 7-31-2007. FILED 6-20-2005.
- 3,311,750 (*See Class 5 for this trademark*).
- 3,311,763. **LIFECHECK LABORATORY AND DESIGN**. LIFE-CHECK LABORATORY, LLC, (U.S. CLS. 100 AND 101). SN 78-690,088. PUB. 7-31-2007. FILED 8-10-2005.
- 3,311,857. **CANCERQUEST (BLOCK FORM)**. EMORY UNIVERSITY, (U.S. CLS. 100 AND 101). SN 78-753,562. PUB. 7-31-2007. FILED 11-14-2005.
- 3,311,902. **NOBELSMILE (STYLIZED)**. NOBEL BIOCARE SERVICES AG, (U.S. CLS. 100 AND 101). SN 78-792,699. PUB. 7-31-2007. FILED 1-17-2006.
- 3,311,995. **TR AND DESIGN**. WEST COAST TANNING, LLC, (U.S. CLS. 100 AND 101). SN 78-845,963. PUB. 7-31-2007. FILED 3-24-2006.
- 3,312,029 (*See Class 35 for this trademark*).
- 3,312,040. **UTAH VALLEY PEDIATRICS, LC (BLOCK FORM)**. UTAH VALLEY PEDIATRICS, L.C., (U.S. CLS. 100 AND 101). SN 78-858,603. PUB. 7-31-2007. FILED 4-11-2006.
- 3,312,079 (*See Class 35 for this trademark*).
- 3,312,083. **FRIENDS WITH DIABETES (BLOCK FORM)**. AGAMATRIX, INC., (U.S. CLS. 100 AND 101). SN 78-870,508. PUB. 7-31-2007. FILED 4-26-2006.
- 3,312,093. **K KENNY COLE SALON (STYLIZED)**. WILLIAMS, NIKKI N., (U.S. CLS. 100 AND 101). SN 78-871,715. PUB. 7-31-2007. FILED 4-27-2006.
- 3,312,105. **PRAIRIE CARDIOVASCULAR THE DOCTORS OF PRAIRIE (BLOCK FORM)**. PRAIRIE CARDIOVASCULAR CONSULTANTS, LTD., (U.S. CLS. 100 AND 101). SN 78-873,215. PUB. 7-31-2007. FILED 5-1-2006.
- 3,312,180 (*See Class 9 for this trademark*).
- 3,312,236 (*See Class 5 for this trademark*).
- 3,312,240. **FINALLY PAIN RELIEF AFTER SURGERY (BLOCK FORM)**. DAHLINGER, ERIC F., (U.S. CLS. 100 AND 101). SN 78-892,427. PUB. 7-31-2007. FILED 5-25-2006.
- 3,312,241. **LET THE HEALING BEGIN (BLOCK FORM)**. DAHLINGER, ERIC F., (U.S. CLS. 100 AND 101). SN 78-892,432. PUB. 7-31-2007. FILED 5-25-2006.
- 3,312,276 (*See Class 36 for this trademark*).
- 3,312,282 (*See Class 14 for this trademark*).
- 3,312,389. **URBANA (BLOCK FORM)**. URBANA CITYSPA & TEABAR, INC, (U.S. CLS. 100 AND 101). SN 78-920,577. PUB. 7-31-2007. FILED 6-30-2006.
- 3,312,414 (*See Class 16 for this trademark*).
- 3,312,439. **AGING BACKWARDS (BLOCK FORM)**. AGING BACKWARDS, LLC, (U.S. CLS. 100 AND 101). SN 78-927,239. PUB. 7-31-2007. FILED 7-11-2006.
- 3,312,511. **SPA LAS PALMAS AND DESIGN**. KSL RLP HOLDINGS, LLC, (U.S. CLS. 100 AND 101). SN 78-937,983. PUB. 7-31-2007. FILED 7-26-2006.
- 3,312,540. **HEELING HEARTS (BLOCK FORM)**. CHENNY TROUPE, INC., (U.S. CLS. 100 AND 101). SN 78-943,244. PUB. 4-24-2007. FILED 8-2-2006.
- 3,312,582. **EATSTRONG PERFORMANCE NUTRITION FOR THE ACTIVE BODY AND DESIGN**. PACHELLA, SOPHIE, (U.S. CLS. 100 AND 101). SN 78-953,850. PUB. 4-17-2007. FILED 8-16-2006.
- 3,312,594. **SUITABILITY (BLOCK FORM)**. EASTER SEAL SOCIETY OF SUPERIOR CALIFORNIA, (U.S. CLS. 100 AND 101). SN 78-957,978. PUB. 7-31-2007. FILED 8-22-2006.
- 3,312,616 (*See Class 37 for this trademark*).
- 3,312,657 (*See Class 36 for this trademark*).
- 3,312,658 (*See Class 36 for this trademark*).
- 3,312,667. **CHILD SAFE HOPE AND HEALING FOR SEXUALLY ABUSED CHILDREN AND DESIGN**. ALAMO CHIL-

DREN'S ADVOCACY CENTER, INC., MULTIPLE CLASS, (INT. CLS. 44 AND 45), (U.S. CLS. 100 AND 101). SN 78-969,906. PUB. 7-31-2007. FILED 9-8-2006.
 3,312,704 (See Class 5 for this trademark).
 3,312,735 (See Class 9 for this trademark).
 3,312,788 (See Class 9 for this trademark).
 3,312,851. **MISCELLANEOUS DESIGN**. KIM, KWANG HO, (U.S. CLS. 100 AND 101). SN 79-028,480. PUB. 7-31-2007. FILED 3-9-2006.
 3,312,859 (See Class 5 for this trademark).
 3,312,921 (See Class 5 for this trademark).
 3,312,929 (See Class 35 for this trademark).

CLASS 45—PERSONAL AND LEGAL SERVICES

3,310,222 (See Class 42 for this trademark).
 3,310,227 (See Class 9 for this trademark).
 3,310,305. **SAFEHAVEN (BLOCK FORM)**. NEW BRAUNFELS UTILITIES, (U.S. CLS. 100 AND 101). SN 76-659,098. PUB. 7-31-2007. FILED 4-26-2006.
 3,310,341 (See Class 35 for this trademark).
 3,310,349. **SURF CITY ANIMAL RESPONSE TEAM SCART AND DESIGN**. SURF CITY ANIMAL RESPONSE TEAM (SCART), (U.S. CLS. 100 AND 101). SN 76-664,577. PUB. 7-31-2007. FILED 8-14-2006.
 3,310,500 (See Class 36 for this trademark).
 3,310,523. **RIDE TO REMEMBER 9-11 (BLOCK FORM)**. RIDE TO REMEMBER 9-11, (U.S. CLS. 100 AND 101). SN 77-016,781. PUB. 7-31-2007. FILED 10-9-2006.
 3,310,599 (See Class 42 for this trademark).
 3,310,621. **ZUBAROO (BLOCK FORM)**. ZUBAROO, (U.S. CLS. 100 AND 101). SN 77-033,800. PUB. 7-31-2007. FILED 10-31-2006.
 3,310,626 (See Class 35 for this trademark).
 3,310,672. **MISCELLANEOUS DESIGN**. THE EPISCOPAL CHURCH, (U.S. CLS. 100 AND 101). SN 77-042,945. PUB. 7-31-2007. FILED 11-13-2006.
 3,310,681. **MACROTEC SECURITY CORP AND DESIGN**. MACROTEC SECURITY CORP., (U.S. CLS. 100 AND 101). SN 77-044,989. PUB. 7-17-2007. FILED 11-15-2006.
 3,310,743 (See Class 41 for this trademark).
 3,310,798. **DIVORCE WITHOUT DISHONOR (BLOCK FORM)**. LAW OFFICES OF MICHAEL A. MASTRACCI LLC, (U.S. CLS. 100 AND 101). SN 77-061,056. PUB. 7-31-2007. FILED 12-11-2006.
 3,310,809. **SRG SECURITY RESOURCES GROUP (BLOCK FORM)**. FDM, INC., TA SECURITY RESOURCES GROUP, (U.S. CLS. 100 AND 101). SN 77-062,224. PUB. 7-31-2007. FILED 12-12-2006.
 3,310,892. **AMERICA'S PROTECTOR OF CHILDREN (BLOCK FORM)**. CHILD SHIELD U.S.A., INC., (U.S. CLS. 100 AND 101). SN 77-068,672. PUB. 7-31-2007. FILED 12-20-2006.
 3,310,935. **MISCELLANEOUS DESIGN**. CHILD SHIELD U.S.A., INC., (U.S. CLS. 100 AND 101). SN 77-070,509. PUB. 7-31-2007. FILED 12-22-2006.
 3,310,950 (See Class 35 for this trademark).
 3,310,957. **THE MARRYING GUY (BLOCK FORM)**. THE MARRYING GUY, (U.S. CLS. 100 AND 101). SN 77-070,952. PUB. 7-31-2007. FILED 12-23-2006.
 3,310,970. **MARRYING GUY (BLOCK FORM)**. THE MARRYING GUY, (U.S. CLS. 100 AND 101). SN 77-071,535. PUB. 7-31-2007. FILED 12-27-2006.
 3,310,973. **L2 CHURCH AND DESIGN**. MASTER'S BIBLE CHURCH, (U.S. CLS. 100 AND 101). SN 77-071,668. PUB. 7-31-2007. FILED 12-27-2006.
 3,311,073 (See Class 16 for this trademark).
 3,311,075. **REALFUL (BLOCK FORM)**. REALFUL, LLC., (U.S. CLS. 100 AND 101). SN 77-073,869. PUB. 7-31-2007. FILED 12-31-2006.
 3,311,086. **LATE NIGHT SHOTS (BLOCK FORM)**. LNS MEDIA CORPORATION, (U.S. CLS. 100 AND 101). SN 77-074,028. PUB. 7-31-2007. FILED 1-1-2007.
 3,311,135. **THE LAW FIRM WHERE EVERYBODY KNOWS YOUR NAME (BLOCK FORM)**. CLOCK TOWER LAW GROUP LLC, (U.S. CLS. 100 AND 101). SN 77-076,603. PUB.

7-31-2007. FILED 1-5-2007.
 3,311,140 (See Class 35 for this trademark).
 3,311,141 (See Class 35 for this trademark).
 3,311,269 (See Class 20 for this trademark).
 3,311,275 (See Class 20 for this trademark).
 3,311,319. **IUS JURIS (BLOCK FORM)**. IUS JURIS, LLC, (U.S. CLS. 100 AND 101). SN 77-093,422. PUB. 7-31-2007. FILED 1-29-2007.
 3,311,347. **WARM UP AMERICA! (BLOCK FORM)**. WARM UP AMERICA! FOUNDATION, (U.S. CLS. 100 AND 101). SN 77-095,505. PUB. 7-31-2007. FILED 1-31-2007.
 3,311,364 (See Class 16 for this trademark).
 3,311,400. **TWIN LAKES FELLOWSHIP (BLOCK FORM)**. FIRST PRESBYTERIAN CHURCH, JACKSON MISSISSIPPI, (U.S. CLS. 100 AND 101). SN 77-098,240. PUB. 7-31-2007. FILED 2-2-2007.
 3,311,450 (See Class 42 for this trademark).
 3,311,471. **1-800-ARRESTO.COM (BLOCK FORM)**. LACHEEN, DANIEL, (U.S. CLS. 100 AND 101). SN 77-101,476. PUB. 7-31-2007. FILED 2-7-2007.
 3,311,522. **LITIGEX (BLOCK FORM)**. LITIGEX INC., (U.S. CLS. 100 AND 101). SN 77-110,743. PUB. 7-31-2007. FILED 2-19-2007.
 3,311,696 (See Class 3 for this trademark).
 3,311,701 (See Class 9 for this trademark).
 3,311,713. **FRONTLINE MINISTRIES AND DESIGN**. KUCERA, PATRICK S., (U.S. CLS. 100 AND 101). SN 78-628,917. PUB. 7-31-2007. FILED 5-12-2005.
 3,311,722 (See Class 37 for this trademark).
 3,311,757. **DAREDEVIL STRATEGIES (BLOCK FORM)**. LEVINE, ALISON, (U.S. CLS. 100 AND 101). SN 78-683,992. PUB. 7-31-2007. FILED 8-2-2005.
 3,311,808 (See Class 37 for this trademark).
 3,311,861. **ONE OF A KIND PETS (BLOCK FORM)**. HOLLAND OIL COMPANY, (U.S. CLS. 100 AND 101). SN 78-759,407. PUB. 7-31-2007. FILED 11-22-2005.
 3,311,868 (See Class 25 for this trademark).
 3,311,969. **HEALING CIRCLES (BLOCK FORM)**. COMFORT ZONE CAMP, INC., (U.S. CLS. 100 AND 101). SN 78-834,128. PUB. 7-31-2007. FILED 3-10-2006.
 3,312,032 (See Class 9 for this trademark).
 3,312,054. **VIRTUALPETADOPTIONS.COM (BLOCK FORM)**. PET FOOD EXPRESS, LTD., (U.S. CLS. 100 AND 101). SN 78-861,778. PUB. 7-31-2007. FILED 4-14-2006.
 3,312,184. **CLARKE SECURITY AND DESIGN**. CLARKE SECURITY, INC., (U.S. CLS. 100 AND 101). SN 78-883,218. PUB. 7-31-2007. FILED 5-15-2006.
 3,312,264. **STAR BABIES (BLOCK FORM)**. PHILLIPS, PAMELA, (U.S. CLS. 100 AND 101). SN 78-897,570. PUB. 7-31-2007. FILED 5-31-2006.
 3,312,276 (See Class 36 for this trademark).
 3,312,296 (See Class 35 for this trademark).
 3,312,382. **CONGREGATION OF OUR LORD (BLOCK FORM)**. CONGREGATION OF OUR LORD, INC., (U.S. CLS. 100 AND 101). SN 78-919,283. PUB. 7-31-2007. FILED 6-28-2006.
 3,312,386 (See Class 35 for this trademark).
 3,312,475. **PROVIDENCE AND DESIGN**. PROVIDENCE PRESBYTERIAN CHURCH (PCA), (U.S. CLS. 100 AND 101). SN 78-931,310. PUB. 7-31-2007. FILED 7-17-2006.
 3,312,554. **STAES (BLOCK FORM)**. GRACE HILL SETTLEMENT HOUSE, (U.S. CLS. 100 AND 101). SN 78-946,606. PUB. 7-31-2007. FILED 8-7-2006.
 3,312,626 (See Class 35 for this trademark).
 3,312,647 (See Class 35 for this trademark).
 3,312,657 (See Class 36 for this trademark).
 3,312,658 (See Class 36 for this trademark).
 3,312,666. **LAZERPRINT (BLOCK FORM)**. GLOBAL TEL*LINK CORPORATION, (U.S. CLS. 100 AND 101). SN 78-969,882. PUB. 7-31-2007. FILED 9-8-2006.
 3,312,667 (See Class 44 for this trademark).
 3,312,799 (See Class 9 for this trademark).

* * * * *

SECTION 2.—PRIOR UNITED STATES CLASSIFICATION

COLLECTIVE MEMBERSHIP MARKS

CLASS 200—COLLECTIVE MEMBERSHIP
3,310,272 (*See Class 25 for this trademark*).

3,312,284. **SIGMA ALPHA (BLOCK FORM)**. SIGMA ALPHA

SORORITY, SN 78-901,932. PUB. 7-31-2007. FILED 6-6-2006.

3,312,596. **BBV UNUS SUPRA OMNIS AND DESIGN**. ELEMENT LIMITED CORP., SN 78-958,178. PUB. 7-31-2007. FILED 8-23-2006.

* * * * *

TRADEMARK REGISTRATIONS ISSUED UNDER SECTION 1(d)

The following marks have registered on the Principal Register pursuant to the intent-to-use provisions of Section 1(d) of the Trademark Act of 1946, as amended.

SECTION 1.— INTERNATIONAL CLASSIFICATION

The short titles associated below with the international class numbers are terms designed merely for quick identification and are not an official part of the international classification. The full names of international classes are given in section 6.1 of the trademark rules of practice.

The designation "U.S. Cl." appearing in this section refers to the U.S. class in effect prior to Sep. 1, 1973 rather than the international class which applies to applications filed on or after that date. For adoption of international classification see notice in the OFFICIAL GAZETTE of Jun. 26, 1973 (911 O.G. TM 210).

Application in more than one class

3,312,979. XENOGEN CORPORATION, ALAMEDA, CA. SN 75-621,123. PUB. 4-10-2001, FILED 8-7-1998.

XENOGEN

CLASS 1—CHEMICALS

FOR DNA FOR SCIENTIFIC, LABORATORY AND RESEARCH USE; GENETICALLY-ENGINEERED BIOLOGICAL CELLS, VIRUSES, PATHOGENS, AND LIGHT-EMITTING CELLS FOR SCIENTIFIC, LABORATORY AND RESEARCH USE; REAGENTS AND AN INSTRUCTION MANUAL SOLD AS A UNIT FOR SCIENTIFIC; LABORATORY AND RESEARCH USE (U.S. CLS. 1, 5, 6, 10, 26 AND 46).

FIRST USE 12-0-2000; IN COMMERCE 12-0-2000.

CLASS 9—ELECTRICAL AND SCIENTIFIC APPARATUS

FOR LIGHT IMAGING SYSTEM, NAMELY, A CAMERA AND SPECIMEN CHAMBER; SOFTWARE TO ACQUIRE, STORE, ARCHIVE, RETRIEVE, TRACK, COORDINATE AND ANALYZE IMAGES; SOFTWARE, NAMELY, DATABASES IN THE FIELDS OF IMAGE ACQUISITION, IMAGE PROCESSING, IMAGE ANALYSIS, IMAGE ARCHIVAL, IMAGE RETRIEVAL, GENOMICS, PROTEOMICS AND INFOMATICS (U.S. CLS. 21, 23, 26, 36 AND 38).

FIRST USE 4-0-2000; IN COMMERCE 4-0-2000.

3,312,980. DEVLIN, DANIEL P., DBA SHERPA JAVA AND TEA COOPERATIVE, FRISCO, CO. SN 75-867,467. PUB. 11-20-2001, FILED 12-10-1999.

SHERPAJAVA COFFEE WITH AN ALTITUDE

NO CLAIM IS MADE TO THE EXCLUSIVE RIGHT TO USE "COFFEE", APART FROM THE MARK AS SHOWN.

TM 966

CLASS 30—STAPLE FOODS

FOR COFFEE, TEA, AND ESPRESSO BEVERAGES, GROUND AND WHOLE BEAN COFFEE, DARK ROAST WHOLE BEAN COFFEE, AND COFFEE BLENDS, NAMELY BLENDED GROUND COFFEE BEANS AND BLENDED WHOLE COFFEE BEANS, READY-TO-DRINK COFFEE AND READY-TO-DRINK COFFEE BASED BEVERAGES (U.S. CL. 46).

FIRST USE 11-12-1999; IN COMMERCE 5-15-2007.

CLASS 42—SCIENTIFIC AND COMPUTER SERVICES

FOR RESTAURANT, CAFÉ, AND COFFEE HOUSE SERVICES FEATURING COFFEE AND ESPRESSO BEVERAGES (U.S. CLS. 100 AND 101).

FIRST USE 11-12-1999; IN COMMERCE 5-15-2007.

3,312,981. STRATATECH CORPORATION, MADISON, WI. SN 75-928,861. PUB. 4-13-2004, FILED 2-26-2000.

NIKS

CLASS 1—CHEMICALS

FOR MANUFACTURED HUMAN SKIN CELLS FOR SCIENTIFIC, LABORATORY OR MEDICAL RESEARCH USE (U.S. CLS. 1, 5, 6, 10, 26 AND 46).

FIRST USE 4-17-2007; IN COMMERCE 4-17-2007.

CLASS 5—PHARMACEUTICALS

FOR MANUFACTURED HUMAN SKIN CELLS FOR MEDICAL OR CLINICAL USE (U.S. CLS. 6, 18, 44, 46, 51 AND 52).

FIRST USE 4-17-2007; IN COMMERCE 4-17-2007.

3,312,982. DISCOVERY COMMUNICATIONS, INC., DBA THE DISCOVERY CHANNEL, BETHESDA, MD. SN 75-983,599. PUB. 7-25-2006, FILED 3-13-1996.

DISCOVERY KIDS

OWNER OF U.S. REG. NOS. 883,953, 1,602,072, AND OTHERS.

NO CLAIM IS MADE TO THE EXCLUSIVE RIGHT TO USE "KIDS", APART FROM THE MARK AS SHOWN.

CLASS 38—COMMUNICATION

FOR CABLE TELEVISION NETWORK BROADCASTING (U.S. CLS. 100, 101 AND 104).

FIRST USE 4-1-1997; IN COMMERCE 4-1-1997.

CLASS 41—EDUCATION AND ENTERTAINMENT

FOR EDUCATIONAL AND ENTERTAINMENT SERVICES, NAMELY, PRODUCTION OF AUDIO-VISUAL WORKS AND TELEVISION PROGRAMS IN THE FIELD OF EDUCATIONAL INSTRUCTION; AND PROVIDING ON-LINE INFORMATION ON TELEVISION PROGRAMMING, ART AND HISTORY (U.S. CLS. 100, 101 AND 107).

FIRST USE 4-1-1997; IN COMMERCE 4-1-1997.

CLASS 42—SCIENTIFIC AND COMPUTER SERVICES

FOR PROVIDING ON-LINE INFORMATION ON SCIENCE, HEALTH AND MATHEMATICS (U.S. CLS. 100 AND 101).

FIRST USE 4-1-1997; IN COMMERCE 4-1-1997.

CLASS 41—EDUCATION AND ENTERTAINMENT

FOR ENTERTAINMENT SERVICES IN THE NATURE OF PLANNING, PRODUCTION AND DISTRIBUTION OF LIVE OR RECORDED AUDIO, VISUAL OR AUDIO-VISUAL MATERIAL FOR BROADCASTING BY TELEVISION OR THROUGH FILM OR VIDEOTAPE; ENTERTAINMENT SERVICES PROVIDED BY MEANS OF THE INTERNET NAMELY, ARRANGING OF MUSICAL ENTERTAINMENT, ARRANGING OF PRESENTATIONS FOR ENTERTAINMENT PURPOSES, AUDIO ENTERTAINMENT SERVICES, AUDIO-VISUAL DISPLAY PRESENTATION SERVICES FOR ENTERTAINMENT PURPOSES, ARRANGING ENTERTAINMENT IN THE FORM OF RECORDED MUSIC AND TELEVISION PROGRAMMES; PLANNING, PRODUCTION AND DISTRIBUTION OF TELEVISION PROGRAMS AND FILMS; ENTERTAINMENT SERVICES, NAMELY, A CONTINUING NEWS SHOW DISTRIBUTED OVER TELEVISION, SATELLITE AUDIO AND VIDEO; ENTERTAINMENT INFORMATION SERVICES PROVIDED BY MEANS OF THE INTERNET RELATING TO MUSIC, AUDIO VISUAL DISPLAYS, VIDEO ENTERTAINMENT, FILM; TELEVISION; PROVIDING ENTERTAINMENT SERVICES IN THE FIELD OF TELEVISION BROADCAST, SPORTING AND CULTURAL ACTIVITIES VIA ELECTRONIC AND DIGITAL INTERACTIVE MEDIA; INFORMATION PROVIDED ON-LINE FROM A COMPUTER DATABASE OR FROM THE INTERNET IN THE FIELD OF TELEVISION, ENTERTAINMENT, CULTURAL AND SPORTING ACTIVITIES (U.S. CLS. 100, 101 AND 107).

FIRST USE 11-17-2004; IN COMMERCE 11-17-2004.

3,312,988. STAR TELEVISION PRODUCTIONS LIMITED, ROAD TOWN, TORTOLA, BR. VIRGIN ISLANDS. SN 76-185,172. PUB. 11-12-2002, FILED 12-21-2000.

3,312,989. LOGIS MARKET, S.A., 08902 L'HOSPITALET DE LLOBREGAT, SPAIN. SN 76-191,600. PUB. 5-27-2003, FILED 1-8-2001.



CLASS 38—COMMUNICATION

FOR TELEVISION BROADCASTING SERVICES; DIGITAL TELEVISION TRANSMISSION SERVICES; PROVIDING TELECOMMUNICATIONS CONNECTIONS IN THE FORM OF LINKS TO COMPUTER DATABASES AND THE INTERNET; PROVIDING COMPUTER CONNECTIONS IN THE FORM OF LINKS TO COMPUTER DATABASES AND THE INTERNET; TRANSMISSION OF TELEVISION PROGRAMS; OPERATION OF EARTH-TO-SATELLITE TRANSMITTERS FOR TRANSMISSION OF SIGNALS TO SATELLITE; BROADCASTING TELEVISION PROGRAMS BY SATELLITE; OPERATION OF SATELLITE-TO-EARTH RECEIVING AERIALS; FREQUENCY CONVERSION OF MICROWAVE SIGNALS RELAYED BY SATELLITE; DISTRIBUTION OF TELEVISION BY SATELLITE; OPERATION OF TELEVISION CABLE NETWORKS; OPERATION OF CABLE NETWORK COMMUNICATIONS SYSTEMS; VIDEOTEXT AND TELETXT TRANSMISSION SERVICES; TRANSMISSION (FOR OTHERS) OF DATA AND OF INFORMATION VIA CABLE, AND COMMUNICATIONS SATELLITE; PROVIDING ON-LINE CHAT ROOMS FOR THE INTERCHANGE OF DATA IN THE FIELD OF TELEVISION AND ENTERTAINMENT BY ELECTRONIC MEANS; PROVISION OF INFORMATION ABOUT TELECOMMUNICATIONS SERVICES FOR BUSINESS OR DOMESTIC PURPOSES FROM A COMPUTER-STORED DATA BANK; PROVIDING INFORMATION AND ADVISORY SERVICES RELATING TO ALL THE AFORESAID SERVICES (U.S. CLS. 100, 101 AND 104).

FIRST USE 11-17-2004; IN COMMERCE 11-17-2004.

PRIORITY CLAIMED UNDER SEC. 44(D) ON SPAIN APPLICATION NO. 2354701, FILED 10-31-2000, REG. NO. 2354701-4, DATED 5-7-2001, EXPIRES 10-31-2010.

PRIORITY CLAIMED UNDER SEC. 44(D) ON SPAIN APPLICATION NO. 2354700, FILED 10-31-2000, REG. NO. 2354700-6, DATED 12-20-2001, EXPIRES 10-31-2010.

CLASS 35—ADVERTISING AND BUSINESS

FOR DISSEMINATION OF ADVERTISING FOR OTHERS VIA AN ON-LINE ELECTRONIC COMMUNICATION NETWORK; BUSINESS MARKETING CONSULTATION SERVICES; BUSINESS NETWORKING; COOPERATIVE ADVERTISING AND MARKETING; COMPUTERIZED DATA BASE MANAGEMENT; COMMERCIAL INFORMATION AND DIRECTORY AGENCY; FOREIGN TRADE INFORMATION AND CONSULTATION; PROMOTING RELATIONS BETWEEN SUPPLIERS AND CUSTOMERS BY PROVIDING INTERMEDIATING SERVICES BETWEEN CUSTOMERS AND SUPPLIERS, NAMELY WAREHOUSE STORAGE BROKERAGE, PERSONNEL PLACEMENT AND RECRUITMENT BROKERAGE, AND BUSINESS BROKERAGE IN RELATION TO ALL KINDS OF PRODUCTS USED IN WAREHOUSING AND STORAGE (U.S. CLS. 100, 101 AND 102).

FIRST USE 10-26-2000; IN COMMERCE 1-29-2007.

CLASS 38—COMMUNICATION

FOR TELECOMMUNICATION SERVICES NAMELY, TELECOMMUNICATIONS AND COMMUNICATIONS DATA DELIVERY VIA COMPUTER TERMINALS AND VIA GLOBAL COMPUTER NETWORKS IN THE FIELDS OF LOGISTICAL HANDLING, STORAGE AND WAREHOUSE STORAGE BROKERAGE OF GOODS, AND INFORMATION ON PERSONNEL PLACEMENT AND RECRUITMENT, ELECTRONIC TRANSMISSION OF DATA AND DOCUMENTS VIA COMPUTER TERMINALS AND VIA GLOBAL COMPUTER NETWORKS IN THE FIELDS OF LOGISTICAL HANDLING, STORAGE AND WAREHOUSE STORAGE BROKERAGE OF GOODS, AND INFORMATION ON PERSONNEL PLACEMENT AND RECRUITMENT ELECTRONIC TRANSMISSION OF MESSAGES AND DATA IN THE FIELDS OF LOGISTICAL HANDLING, STORAGE AND WAREHOUSE STORAGE BROKERAGE OF GOODS, AND INFORMATION ON PERSONNEL PLACEMENT AND RECRUITMENT (U.S. CLS. 100, 101 AND 104).

FIRST USE 10-26-2000; IN COMMERCE 1-29-2007.

CLASS 38—COMMUNICATION

FOR TELECOMMUNICATION SERVICES, NAMELY, TELECOMMUNICATIONS AND COMMUNICATIONS DATA DELIVERY VIA COMPUTER TERMINALS AND VIA GLOBAL COMPUTER NETWORKS IN THE FIELDS OF LOGISTICAL HANDLING, STORAGE AND WAREHOUSE STORAGE BROKERAGE OF GOODS, AND INFORMATION ON PERSONNEL PLACEMENT AND RECRUITMENT, ELECTRONIC TRANSMISSION OF DATA AND DOCUMENTS VIA COMPUTER TERMINALS AND VIA GLOBAL COMPUTER NETWORKS IN THE FIELDS OF LOGISTICAL HANDLING, STORAGE AND WAREHOUSE STORAGE BROKERAGE OF GOODS, AND INFORMATION ON PERSONNEL PLACEMENT AND RECRUITMENT, ELECTRONIC TRANSMISSION OF MESSAGES AND DATA IN THE FIELDS OF LOGISTICAL HANDLING, STORAGE AND WAREHOUSE STORAGE BROKERAGE OF GOODS, AND INFORMATION ON PERSONNEL PLACEMENT AND RECRUITMENT (U.S. CLS. 100, 101 AND 104).

FIRST USE 10-31-2000; IN COMMERCE 1-29-2007.

3,312,990. LOGIS MARKET, S.A., 08902 L'HOSPITALET DE LLOBREGAT, SPAIN. SN 76-191,601. PUB. 5-27-2003, FILED 1-8-2001.

3,312,992. ROBERTSON, MAUREEN M., DBA ROUTE 66 FROZEN CUSTARD & DINER, EAU CLAIRE, WI. SN 76-207,531. PUB. 6-11-2002, FILED 2-12-2001.



PRIORITY CLAIMED UNDER SEC. 44(D) ON SPAIN APPLICATION NO. 2354703, FILED 10-31-2000, REG. NO. 2354703-0, DATED 5-7-2001, EXPIRES 10-31-2010.

PRIORITY CLAIMED UNDER SEC. 44(D) ON SPAIN APPLICATION NO. 2354702, FILED 10-31-2000, REG. NO. 2354702-2, DATED 12-20-2001, EXPIRES 10-31-2010.

CLASS 35—ADVERTISING AND BUSINESS

FOR DISSEMINATION OF ADVERTISING FOR OTHERS VIA AN ON-LINE ELECTRONIC COMMUNICATION NETWORK; BUSINESS MARKETING CONSULTATION SERVICES; BUSINESS NETWORKING; COOPERATIVE ADVERTISING AND MARKETING; COMPUTERIZED DATABASE MANAGEMENT; COMMERCIAL INFORMATION AND DIRECTORY AGENCY; FOREIGN TRADE INFORMATION AND CONSULTATION; PROMOTING RELATIONS BETWEEN SUPPLIERS AND CUSTOMERS BY PROVIDING INTERMEDIATING SERVICES BETWEEN CUSTOMERS AND SUPPLIERS, NAMELY WAREHOUSE STORAGE BROKERAGE, PERSONNEL PLACEMENT AND RECRUITMENT BROKERAGE, AND BUSINESS BROKERAGE IN RELATION TO ALL KINDS OF PRODUCTS USED IN WAREHOUSING AND STORAGE (U.S. CLS. 100, 101 AND 102).

FIRST USE 10-31-2000; IN COMMERCE 1-29-2007.



NO CLAIM IS MADE TO THE EXCLUSIVE RIGHT TO USE "ROUTE 66" AND "FROZEN CUSTARD & DINER", APART FROM THE MARK AS SHOWN.

CLASS 30—STAPLE FOODS

FOR FROZEN CUSTARD (U.S. CL. 46).
FIRST USE 8-29-2003; IN COMMERCE 11-11-2004.

CLASS 42—SCIENTIFIC AND COMPUTER SERVICES

FOR RESTAURANT SERVICES (U.S. CLS. 100 AND 101).
FIRST USE 8-29-2003; IN COMMERCE 11-11-2004.

3,312,996. RENESAS TECHNOLOGY CORP., CHIYODA-KU, TOKYO, JAPAN. SN 76-305,844. PUB. 2-1-2005, FILED 8-28-2001.



PRIORITY CLAIMED UNDER SEC. 44(D) ON JAPAN APPLICATION NO. 2001-68927, FILED 7-30-2001, REG. NO. 4613540, DATED 10-18-2002, EXPIRES 10-18-2012.
OWNER OF U.S. REG. NOS. 2,012,287 AND 2,016,317.

CLASS 9—ELECTRICAL AND SCIENTIFIC APPARATUS

FOR CD-ROM, ELECTRONIC CIRCUITS RECORDED WITH PROGRAMS FOR DEVELOPING AND DESIGNING OF SEMICONDUCTOR AND DEVICES, INTEGRATED CIRCUITS, CPUS, ELECTRONIC CIRCUITS (U.S. CLS. 21, 23, 26, 36 AND 38).
FIRST USE 12-30-2003; IN COMMERCE 12-30-2003.

CLASS 42—SCIENTIFIC AND COMPUTER SERVICES

FOR RESEARCH, DEVELOPING, DESIGNING, AND MAINTENANCE FOR OTHERS OF SEMI-CONDUCTORS AND DEVICES, INTEGRATED CIRCUITS, CPUS, MICROCONTROLLERS, AND ELECTRONIC CIRCUITS (U.S. CLS. 100 AND 101).
FIRST USE 1-25-2007; IN COMMERCE 1-25-2007.

3,312,998. WHITE, DAVID L., SHORT HILLS, NJ. SN 76-346,167. PUB. 1-30-2007, FILED 12-7-2001.

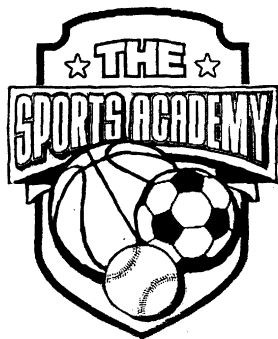

NO CLAIM IS MADE TO THE EXCLUSIVE RIGHT TO USE "SPORTS" AND THE DEPICTION OF THE BASKETBALL, SOCCER BALL AND BASEBALL CLASS 41, APART FROM THE MARK AS SHOWN.

THE MARK CONSISTS OF THE SPORTS ACADEMY IN STYLIZED LETTERING AND STYLIZED DESIGN OF A SHIELD WITH BANNER, STARS, BASKETBALL, BASEBALL AND SOCCER BALL.

CLASS 41—EDUCATION AND ENTERTAINMENT

FOR PROVIDING FACILITIES FOR RECREATION ACTIVITIES AND SPORTS TOURNAMENTS, NAMELY FOOTBALL, BASKETBALL, BASEBALL, SOCCER, ICE HOCKEY, FIELD HOCKEY, LACROSSE, TRACK AND FIELD, RUGBY, SWIMMING, DIVING, ARCHERY, BOWLING, BIKE RACING, GYMNASTICS, GOLF, CLIMBING, RUNNING, SKIING, TENNIS, BADMINTON, PING-PONG, HIKING, WEIGHT TRAINING, WRESTLING, MARTIAL ARTS, AEROBIC EXERCISE, ARCHERY, DARTS, SNOWBOARDING, FISHING, EQUESTRIAN EVENTS, AND CHEERLEADING (U.S. CLS. 100, 101 AND 107).
FIRST USE 12-7-2001; IN COMMERCE 12-7-2001.

CLASS 42—SCIENTIFIC AND COMPUTER SERVICES

FOR PROVIDING SOCIAL FUNCTION FACILITIES FOR SPECIAL OCCASIONS, NAMELY, CHILDREN'S PARTIES (U.S. CLS. 100 AND 101).
FIRST USE 12-7-2001; IN COMMERCE 12-7-2001.

3,313,000. MJW CORPORATION, INC., AMHERST, NY. SN 76-374,241. PUB. 11-4-2003, FILED 2-21-2002.

SITE-WISE

CLASS 9—ELECTRICAL AND SCIENTIFIC APPARATUS

FOR COMPUTER PROGRAM FOR ORGANIZING, CATALOGING AND RETRIEVING DIGITAL IMAGES AND OTHER RELATED INFORMATION, NAMELY MAPS, FLOOR PLANS, DIAGRAMS, ELEVATIONAL DRAWINGS AND ELECTRICAL, AND PLUMBING SYSTEM DATA FOR BUILDINGS OR FACILITIES (U.S. CLS. 21, 23, 26, 36 AND 38).
FIRST USE 5-31-2001; IN COMMERCE 5-31-2001.

CLASS 37—CONSTRUCTION AND REPAIR

FOR PROVIDING ON-LINE CONSTRUCTION INFORMATION RELATING TO BUILDINGS AND FACILITIES, NAMELY DIGITAL IMAGES, AND OTHER RELATED INFORMATION, NAMELY, MAPS, FLOOR PLANS, DIAGRAMS, ELEVATIONAL DRAWINGS AND ELECTRICAL, AND PLUMBING SYSTEM DATA FOR BUILDINGS OR FACILITIES (U.S. CLS. 100, 103 AND 106).
FIRST USE 5-31-2001; IN COMMERCE 5-31-2001.

CLASS 39—TRANSPORTATION AND STORAGE

FOR ELECTRONIC STORAGE ON A GLOBAL COMPUTER NETWORK OF DIGITAL IMAGES, AND OTHER RELATED INFORMATION, NAMELY, MAPS, FLOOR PLANS, DIAGRAMS, ELEVATIONAL DRAWINGS AND ELECTRICAL, AND PLUMBING SYSTEM DATA FOR BUILDINGS OR FACILITIES (U.S. CLS. 100 AND 105).
FIRST USE 5-31-2001; IN COMMERCE 5-31-2001.

CLASS 42—SCIENTIFIC AND COMPUTER SERVICES

FOR COMPUTER SERVICES, NAMELY, MAINTAINING WEB SITES AND COMPUTER SOFTWARE FOR OTHERS OVER A GLOBAL COMPUTER NETWORK, SUCH WEB SITES AND COMPUTER SOFTWARE FEATURING DIGITAL IMAGES, AND OTHER RELATED INFORMATION, NAMELY, MAPS, FLOOR PLANS, DIAGRAMS, ELEVATED DRAWINGS AND ELECTRICAL, AND PLUMBING SYSTEM DATA FOR BUILDINGS OR FACILITIES (U.S. CLS. 100 AND 101).
FIRST USE 5-31-2001; IN COMMERCE 5-31-2001.

3,313,002. MECALUX, S.A., 08902 BARCELONA, SPAIN. SN 76-405,940. PUB. 5-25-2004, FILED 5-10-2002.

MECALUX LOGIS MARKET

CLASS 35—ADVERTISING AND BUSINESS

FOR INTERMEDDLING SERVICES BETWEEN SUPPLIERS AND CUSTOMERS, NAMELY CARGO HANDLING BROKERAGE, WAREHOUSE STORAGE BROKERAGE, PERSONNEL PLACEMENT AND RECRUITMENT BROKERAGE, LOGISTICS MANAGEMENT IN THE FIELD OF FREIGHT HANDLING AND WAREHOUSE STORE (U.S. CLS. 100, 101 AND 102).
FIRST USE 1-29-2007; IN COMMERCE 1-29-2007.

CLASS 38—COMMUNICATION

FOR PROVIDING ELECTRONIC TELECOMMUNICATIONS AND COMMUNICATION TRANSMISSIONS VIA COMPUTER TERMINALS AND VIA GLOBAL COMPUTER NETWORKS, NAMELY PROVIDING AN ELECTRONIC DATABASE AND DIRECTORY OF LINKS TO A VARIETY OF PRODUCTS, SERVICES AND INFORMATION FOR USE IN LOGISTICAL HANDLING, STORAGE AND WAREHOUSE STORAGE BROKERAGE OF GOODS, AND INFORMATION ON PERSONNEL PLACEMENT AND RECRUITMENT (U.S. CLS. 100, 101 AND 104).
FIRST USE 1-29-2007; IN COMMERCE 1-29-2007.

3,313,011. RJ FEDER & ASSOCIATES, INC., CALABASAS, CA. SN 76-457,803. PUB. 1-13-2004, FILED 10-11-2002.

SERVICE BEYOND EXPECTATION

CLASS 16—PAPER GOODS AND PRINTED MATTER

FOR PRINTED MATERIALS, NAMELY, BOOKS, MAGAZINES, PAMPHLETS AND DECALS, CONTAINING INFORMATION ABOUT RESTAURANTS, HOTELS, ENTERTAINMENT, TRAVEL AND LEISURE ACTIVITIES (U.S. CLS. 2, 5, 22, 23, 29, 37, 38 AND 50).
FIRST USE 4-2-2007; IN COMMERCE 4-2-2007.

CLASS 35—ADVERTISING AND BUSINESS

FOR BUSINESS CONSULTING SERVICES IN THE FIELD OF CUSTOMER SERVICE; PROVIDING CUSTOMER SERVICE RATING SERVICES FOR OTHERS; PROVIDING AN INTERACTIVE WEB SITE FEATURING INFORMATION IN THE FIELD OF CUSTOMER SERVICE; PROVIDING RATING INFORMATION ABOUT HOTELS AND RESTAURANTS (U.S. CLS. 100, 101 AND 102).
FIRST USE 4-2-2007; IN COMMERCE 4-2-2007.

CLASS 39—TRANSPORTATION AND STORAGE

FOR PROVIDING TRAVEL INFORMATION SERVICES (U.S. CLS. 100 AND 105).
FIRST USE 4-2-2007; IN COMMERCE 4-2-2007.

CLASS 41—EDUCATION AND ENTERTAINMENT

FOR TRAINING SERVICES IN THE FIELD OF CUSTOMER SERVICE; PROVIDING INFORMATION ABOUT ENTERTAINMENT, CULTURAL AND LEISURE ACTIVITIES AND SERVICES (U.S. CLS. 100, 101 AND 107).
FIRST USE 4-2-2007; IN COMMERCE 4-2-2007.

CLASS 42—SCIENTIFIC AND COMPUTER SERVICES

FOR PROVIDING QUALITY ASSURANCE SERVICES IN THE FIELD OF CUSTOMER SERVICE (U.S. CLS. 100 AND 101).
FIRST USE 4-2-2007; IN COMMERCE 4-2-2007.

3,313,014. BOSTON SCIENTIFIC CORPORATION, LOS GATOS, CA. SN 76-471,570. PUB. 12-6-2005, FILED 11-19-2002.

POLARCATH

CLASS 10—MEDICAL APPARATUS

FOR MEDICAL DEVICES, NAMELY, CATHETERS AND INFLATORS IN THE TREATMENT OF VASCULAR DISEASES (U.S. CLS. 26, 39 AND 44).
FIRST USE 3-10-2002; IN COMMERCE 3-10-2002.

CLASS 44—MEDICAL, BEAUTY AND AGRICULTURAL SERVICES

FOR SURGICAL PROCEDURES FOR THE TREATMENT OF VASCULAR DISEASES (U.S. CLS. 100 AND 101).
FIRST USE 4-3-2002; IN COMMERCE 4-3-2002.

3,313,023. SPRADLIN, MATTHEW, DALLAS, TX. SN 76-518,706. PUB. 8-31-2004, FILED 5-12-2003.

THE THUNDERPUSSIES

OWNER OF U.S. REG. NO. 2,684,706.

CLASS 9—ELECTRICAL AND SCIENTIFIC APPARATUS

FOR MOTION PICTURE FILES, VIDEO TAPES AND DVD'S FEATURING EPISODIC ADVENTURES OF A GROUP OF WOMEN WHO ARE DETECTIVES (U.S. CLS. 21, 23, 26, 36 AND 38).
FIRST USE 10-31-2006; IN COMMERCE 10-31-2006.

CLASS 16—PAPER GOODS AND PRINTED MATTER

FOR COMIC BOOKS FEATURING EPISODIC ADVENTURES OF A GROUP OF WOMEN WHO ARE DETECTIVES (U.S. CLS. 2, 5, 22, 23, 29, 37, 38 AND 50).
FIRST USE 10-31-2006; IN COMMERCE 10-31-2006.

CLASS 41—EDUCATION AND ENTERTAINMENT

FOR ENTERTAINMENT SERVICES, NAMELY, PROVIDING A SERIES OF SHOWS FEATURING EPISODIC ADVENTURES OF A GROUP OF WOMEN WHO ARE DETECTIVES VIA THE INTERNET (U.S. CLS. 100, 101 AND 107).
FIRST USE 10-31-2006; IN COMMERCE 10-31-2006.

3,313,025. STRATHMORE PARTNERS LP, CONCORD, NH. SN 76-522,346. PUB. 8-31-2004, FILED 6-5-2003.

3,313,036. ABERDEEN PLASTICS, INC., MATAWAN, NJ. SN 76-549,096. PUB. 8-22-2006, FILED 10-6-2003.

ROZZANO

CLASS 29—MEATS AND PROCESSED FOODS

FOR GRILLED AND ROASTED VEGETABLES; JARRED CUT VEGETABLES; MARINATED VEGETABLES; PROCESSED OLIVES; OILS, NAMELY, OLIVE AND VEGETABLE OILS; APPETIZERS, NAMELY, TAPENADES OF TOMATOES, PEPPERS, ONIONS AND/OR OLIVES; TAPENADES OF TOMATOES, PEPPERS, ONIONS AND/OR OLIVE BRUSCHETTA, CHEESE AND ITALIAN SAUSAGE; AND FROZEN MEATBALL (U.S. CL. 46).

FIRST USE 6-25-2003; IN COMMERCE 6-25-2003.

CLASS 30—STAPLE FOODS

FOR ITALIAN BISCUITS AND COOKIES; PASTA; PASTA SAUCES; PIZZA (U.S. CL. 46).

FIRST USE 8-4-2004; IN COMMERCE 8-4-2004.

3,313,033. KUSMIK, BILL, DBA THE HEAT EXCHANGE, FORT COLLINS, CO. SN 76-537,849. PUB. 8-31-2004, FILED 8-15-2003.

FRUGAL

CLASS 11—ENVIRONMENTAL CONTROL APPARATUS

FOR FURNACES, HOT WATER HEATERS, AIR CONDITIONERS, HUMIDIFIERS, DEHUMIDIFIERS, WALK-IN COOLERS, FIREPLACES, AND EXHAUST VENTS AND COMBUSTION AIR VENTS FOR GAS APPLIANCES (U.S. CLS. 13, 21, 23, 31 AND 34).

FIRST USE 12-15-2003; IN COMMERCE 2-24-2004.

CLASS 37—CONSTRUCTION AND REPAIR

FOR INSTALLATION AND REPAIR OF FURNACES, AIR CONDITIONERS, ELECTRICAL HEATING AND AIR CONDITIONING SYSTEMS, PLUMBING, FIREPLACES, AIR CONDITIONERS, WATER HEATERS AND WALK-IN COOLERS; AND AIR DUCT CLEANING (U.S. CLS. 100, 103 AND 106).

FIRST USE 12-15-2003; IN COMMERCE 2-24-2004.

3,313,035. HENKEL CORPORATION, GULPH MILLS, PA. SN 76-545,085. PUB. 8-31-2004, FILED 9-3-2003.

ORB

CLASS 2—PAINTS

FOR SEALER COATINGS FOR USE IN THE AUTOMOTIVE INDUSTRY (U.S. CLS. 6, 11 AND 16).

FIRST USE 8-30-2006; IN COMMERCE 8-30-2006.

CLASS 17—RUBBER GOODS

FOR ACOUSTIC PRODUCTS, NAMELY, SOUND ABSORBERS AND DIFFUSERS USED AS SOUND DEADENING MATERIALS; ADHESIVES FOR USE IN THE AUTOMOTIVE INDUSTRY (U.S. CLS. 1, 5, 12, 13, 35 AND 50).

FIRST USE 6-15-2006; IN COMMERCE 6-15-2006.

TRAXX

CLASS 9—ELECTRICAL AND SCIENTIFIC APPARATUS

FOR STORAGE RACKS FOR VIDEO AND AUDIO CASSETTES, COMPACT DISCS, DVDS; STACKABLE STORAGE DRAWERS FOR VIDEO AND AUDIO CASSETTES, COMPACT DISCS, DVDS (U.S. CLS. 21, 23, 26, 36 AND 38).

FIRST USE 12-1-2003; IN COMMERCE 12-1-2003.

CLASS 20—FURNITURE AND ARTICLES NOT OTHERWISE CLASSIFIED

FOR NON-METAL STACKABLE STORAGE DRAWERS (U.S. CLS. 2, 13, 22, 25, 32 AND 50).

FIRST USE 12-1-2003; IN COMMERCE 12-1-2003.

3,313,037. PIPEDREAM PRODUCTS, INC., CHATSWORTH, CA. SN 76-550,808. PUB. 5-31-2005, FILED 10-10-2003.



CLASS 3—COSMETICS AND CLEANING PREPARATIONS

FOR PERFUME, SOAPS, BODY LOTIONS, MASSAGE OIL, MASSAGE LOTIONS, SHOWER GEL, MASSAGE CREAM, DUSTING POWDER, BUBBLE BATH AND KITS COMPRISED OF ONE OR MORE OF EACH OF THE AFOREMENTIONED GOODS (U.S. CLS. 1, 4, 6, 50, 51 AND 52).

FIRST USE 8-1-2006; IN COMMERCE 8-1-2006.

CLASS 5—PHARMACEUTICALS

FOR WATER-BASED PERSONAL LUBRICANTS, WATER-BASED NON-MEDICATED PERSONAL LUBRICANT JELLIES, JAMS, BUTTER AND PUDDINGS ALL FOR USE ON THE SKIN (U.S. CLS. 6, 18, 44, 46, 51 AND 52).

FIRST USE 8-1-2006; IN COMMERCE 8-1-2006.

3,313,044. NRX GLOBAL CORP., TORONTO, ONTARIO M5H 3S5, CANADA. SN 76-565,885. PUB. 11-8-2005, FILED 12-10-2003.

VIP

THE MARK CONSISTS OF STANDARD CHARACTERS

WITHOUT CLAIM TO ANY PARTICULAR FONT, STYLE, SIZE, OR COLOR.

PRIORITY CLAIMED UNDER SEC. 44(D) ON CANADA APPLICATION NO. 1181172, FILED 6-10-2003.

CLASS 9—ELECTRICAL AND SCIENTIFIC APPARATUS

FOR SOFTWARE FOR AUDITING, COLLECTING, STORING, ORGANIZING, CREATING, MODIFYING, PROCESSING, RETRIEVING AND DISPLAYING OF DATA RELATING TO MANAGEMENT, MAINTENANCE, REPAIR AND OPERATION OF INDUSTRIAL ASSETS (U.S. CLS. 21, 23, 26, 36 AND 38).
FIRST USE 11-30-2002; IN COMMERCE 11-30-2002.

CLASS 42—SCIENTIFIC AND COMPUTER SERVICES

FOR CUSTOM SOFTWARE DEVELOPMENT AND INTEGRATION IN CONNECTION WITH SOFTWARE FOR AUDITING, COLLECTING, STORING, ORGANIZING, CREATING, MODIFYING, PROCESSING, RETRIEVING AND DISPLAYING OF DATA RELATING TO MANAGEMENT, MAINTENANCE, REPAIR AND OPERATION OF INDUSTRIAL ASSETS AND THE INTEGRATION OF SUCH DATA AND SOFTWARE FUNCTIONALITY INTO OTHER EXISTING SOFTWARE AND WORK PROCESSES (U.S. CLS. 100 AND 101).
FIRST USE 11-30-2002; IN COMMERCE 11-30-2002.

3,313,046. NEW CENTURY SNACKS, LLC, COMMERCE, CA. SN 76-568,784. PUB. 8-2-2005, FILED 1-2-2004.

TASTE OASIS

THE MARK CONSISTS OF STANDARD CHARACTERS WITHOUT CLAIM TO ANY PARTICULAR FONT, STYLE, SIZE, OR COLOR.

CLASS 29—MEATS AND PROCESSED FOODS

FOR PROCESSED NUTS, DRIED FRUITS, PROCESSED FRUITS, PROCESSED EDIBLE SUNFLOWER SEEDS AND KERNELS, PROCESSED EDIBLE PUMPKIN SEEDS AND KERNELS, SNACK MIX CONSISTING PRIMARILY OF PROCESSED FRUITS, PROCESSED NUTS AND/OR RAISINS, CANDIED NUTS AND FRUITS (U.S. CL. 46).
FIRST USE 3-12-2004; IN COMMERCE 3-12-2004.

CLASS 30—STAPLE FOODS

FOR CHOCOLATE COVERED NUTS AND FRUITS, YOGURT COVERED NUTS AND FRUITS, CANDIES, RICE CRACKERS, PRETZELS, CRACKERS, WHEAT-BASED SNACK FOOD, SNACK MIX CONSISTING PRIMARILY OF CRACKERS, PRETZELS, CANDIED NUTS AND/OR POPPED POPCORN (U.S. CL. 46).
FIRST USE 3-12-2004; IN COMMERCE 3-12-2004.

3,313,049. DIVINE PHYSICS HOLISTIC LIFESTYLES, INC., CENTENNIAL, CO. SN 76-581,215. PUB. 8-30-2005, FILED 3-16-2004.

FOR THE SPIRIT OF WELLNESS AND THE WELLNESS OF THE SPIRIT

THE MARK CONSISTS OF STANDARD CHARACTERS WITHOUT CLAIM TO ANY PARTICULAR FONT, STYLE, SIZE, OR COLOR.

CLASS 35—ADVERTISING AND BUSINESS

FOR RETAIL STORE SERVICES FEATURING PRODUCTS FOR HEALTH, NUTRITION, WELLNESS, COSMETICS AND LITERATURE CONCERNING THESE TOPICS (U.S. CLS. 100, 101 AND 102).
FIRST USE 5-0-2005; IN COMMERCE 5-0-2005.

CLASS 41—EDUCATION AND ENTERTAINMENT

FOR EDUCATIONAL SERVICES IN THE NATURE OF SEMINARS AND WORKSHOPS PROVIDING INFORMATION, EDUCATION AND TRAINING IN THE FIELDS OF MEDICINE, SOCIAL, RELIGIOUS, SPIRITUAL, POLITICAL, ENVIRONMENTAL, HEALTH AND WELLNESS AND CULTURAL ISSUES; MEDITATION INSTRUCTION (U.S. CLS. 100, 101 AND 107).
FIRST USE 5-0-2005; IN COMMERCE 5-0-2005.

CLASS 44—MEDICAL, BEAUTY AND AGRICULTURAL SERVICES

FOR MASSAGE; CHIROPRACTIC SERVICES; NUTRITIONAL AND HOLISTIC MEDICAL SERVICES, MEDICAL SERVICES FEATURING HOMEOPATHY AND ENERGY-BASED MEDICINE; PSYCHOLOGICAL COUNSELING; AND HEALTH SPA SERVICES FOR HEALTH AND WELLNESS OF THE BODY AND SPIRIT (U.S. CLS. 100 AND 101).
FIRST USE 5-0-2005; IN COMMERCE 5-0-2005.

3,313,051. BASIC TRADEMARK S.A., LUXEMBOURG, LUXEMBOURG. SN 76-583,990. PUB. 10-4-2005, FILED 3-30-2004.

KAPPA

THE MARK CONSISTS OF STANDARD CHARACTERS WITHOUT CLAIM TO ANY PARTICULAR FONT, STYLE, SIZE, OR COLOR.

CLASS 9—ELECTRICAL AND SCIENTIFIC APPARATUS

FOR OPTICAL APPARATUS AND INSTRUMENTS, NAMELY, EYE GLASSES, SUNGLASSES, SPECTACLES, FRAMES; SPECTACLES IN THE NATURE OF GOGGLES (U.S. CLS. 21, 23, 26, 36 AND 38).
FIRST USE 0-0-1967; IN COMMERCE 0-0-1981.

CLASS 18—LEATHER GOODS

FOR BAGS, NAMELY, TRAVEL BAGS AND LUGGAGE; DUFFEL BAGS; HAND BAGS, KNAPSACKS, RUCKSACKS, SCHOOL BAGS; SHOULDER BAGS; SUITCASES, BRIEFCASES; ALL-PURPOSE SPORT BAGS; PURSES, DRAWSTRING POUCHES, WALLETS; UMBRELLAS (U.S. CLS. 1, 2, 3, 22 AND 41).

FIRST USE 0-0-1967; IN COMMERCE 0-0-1981.

CLASS 24—FABRICS

FOR TOWELS (U.S. CLS. 42 AND 50).

FIRST USE 0-0-1967; IN COMMERCE 0-0-1981.

CLASS 25—CLOTHING

FOR SPORTSWEAR, NAMELY SPORTS UNIFORMS AND JERSEYS, SWIMWEAR, UNDERWEAR; PANTS, TROUSERS, JEANS, SHORTS, JACKETS, COATS, OVERCOATS, RAINCOATS, HOSIERY, SWEATERS, CARDIGANS, FLEECE AND POLAR FLEECE TOPS AND BOTTOMS, TRAINING AND TRACK SUITS, SHIRTS, WOVEN SHIRTS, SWEAT SHIRTS, POLO SHIRTS, T-SHIRTS, TANK TOPS, TOPS, CUT AND SEW TOPS, DRESSES, SKIRTS, GOWNS, SOCKS; ROBES; BANDS, NAMELY SWEAT BANDS, WRIST BANDS; SCARVES; GLOVES; HEADWEAR, NAMELY, HATS, CAPS, AND HEAD BANDS; BELTS; FOOTWEAR, NAMELY, SHOES, BOOTS, SANDALS, SLIPPERS, SPORT AND ATHLETIC SHOES (U.S. CLS. 22 AND 39).

FIRST USE 0-0-1967; IN COMMERCE 0-0-1981.

CLASS 28—TOYS AND SPORTING GOODS

FOR GYMNASTIC AND SPORTING GOODS AND EQUIPMENT, NAMELY BALLS FOR GAMES, NAMELY FOOTBALLS, SOCCER BALLS, BASKETBALLS, GOLF BALLS; BODY BOARDS, PROTECTIVE PADDING FOR PLAYING FOOTBALL, SOCCER, RUGBY, NAMELY, BODY GUARDS, HAND GUARDS, SHIN GUARDS ALL FOR ATHLETIC USE; GLOVES FOR GAMES, NAMELY FOOTBALL GLOVES, GOALKEEPERS' GLOVES, RUGBY GLOVES AND GOLF GLOVES (U.S. CLS. 22, 23, 38 AND 50).

FIRST USE 0-0-1967; IN COMMERCE 0-0-1981.

3,313,053. LIFESTYLE TECHNOLOGIES, LLC, NEW YORK, NY. SN 76-588,430. PUB. 1-16-2007, FILED 4-22-2004.

ROADMAP

OWNER OF U.S. REG. NO. 1,194,940.

CLASS 35—ADVERTISING AND BUSINESS

FOR PROVIDING A WEBSITE FEATURING INFORMATION ABOUT PRODUCTS IN THE FIELDS OF CAREER COUNSELING, CAREER DEVELOPMENT AND EMPLOYMENT OPPORTUNITIES, NAMELY, CAREER ASSESSMENT TESTS, VOCATIONAL SURVEYS, INFORMATIONAL GUIDES AND REFERENCE MATERIALS, AND REPORTS ON CAREER DEVELOPMENT AND EMPLOYMENT TRENDS IN A WIDE VARIETY OF INDUSTRIES; INFORMATIONAL SERVICES IN THE NATURE OF INFORMATION AND LINKS TO WEBSITES FOR LOCAL CAREER DEVELOPMENT RESOURCES AND EMPLOYMENT OPPORTUNITIES (U.S. CLS. 100, 101 AND 102).

FIRST USE 8-0-2006; IN COMMERCE 8-0-2006.

CLASS 41—EDUCATION AND ENTERTAINMENT

FOR DOCUMENTARY FILM PRODUCTION; PROVIDING A WEB SITE FEATURING INFORMATION ABOUT EDUCATIONAL ASSESSMENT, EDUCATIONAL COUNSELING, CAREER COUNSELING; CAREER APTITUDE, VOCATIONAL TESTING, EDUCATIONAL COUNSELING, CAREER APTITUDE AND VOCATIONAL TESTING, AND TRENDS IN EDUCATION AND EMPLOYMENT FOR A WIDE VARIETY OF INDUSTRIES; INFORMATIONAL SERVICES IN THE NATURE OF INFORMATION AND LINKS TO WEBSITES FOR LOCAL EDUCATIONAL RESOURCES AND LEARNING CENTERS, AND INFORMATION AND LINKS TO WEBSITES FOR EDUCATIONAL OPPORTUNITIES (U.S. CLS. 100, 101 AND 107).

FIRST USE 8-0-2006; IN COMMERCE 8-0-2006.

3,313,059. THE HAPPIEST BABY, INC., PACIFIC PALISADES, CA. SN 76-597,165. PUB. 8-1-2006, FILED 6-11-2004.

THE FAST FOOD RULE

THE MARK CONSISTS OF STANDARD CHARACTERS WITHOUT CLAIM TO ANY PARTICULAR FONT, STYLE, SIZE, OR COLOR.

NO CLAIM IS MADE TO THE EXCLUSIVE RIGHT TO USE FAST FOOD, APART FROM THE MARK AS SHOWN.

CLASS 9—ELECTRICAL AND SCIENTIFIC APPARATUS

FOR PRE-RECORDED VIDEOS, VIDEOCASSETTES, DVDS, AUDIOCASSETTES, AND CDS FEATURING INFORMATION ON INFANT AND TODDLER DEVELOPMENT AND PARENTING SKILLS (U.S. CLS. 21, 23, 26, 36 AND 38).

FIRST USE 5-1-2006; IN COMMERCE 5-1-2006.

CLASS 41—EDUCATION AND ENTERTAINMENT

FOR PRODUCTION OF FEATURE FILMS, DOCUMENTARY FILMS, TELEVISION PROGRAMS, AND PROVIDING PUBLIC SPEAKERS ON THE SUBJECT OF INFANT AND TODDLER DEVELOPMENT AND PARENTING SKILLS (U.S. CLS. 100, 101 AND 107).

FIRST USE 5-1-2006; IN COMMERCE 5-1-2006.

3,313,071. STRATEGIC HEALTHCARE INITIATIVES, INC., ADDISON, TX. SN 76-608,468. PUB. 11-15-2005, FILED 8-24-2004.



CLASS 41—EDUCATION AND ENTERTAINMENT

FOR EDUCATIONAL SERVICES, NAMELY OBESITY AVOIDANCE AND WEIGHT REDUCTION INSTRUCTION AND TRAINING (U.S. CLS. 100, 101 AND 107).
FIRST USE 4-0-2006; IN COMMERCE 4-0-2006.

CLASS 44—MEDICAL, BEAUTY AND AGRICULTURAL SERVICES

FOR MEDICAL SERVICES, NAMELY OBESITY AVOIDANCE AND WEIGHT REDUCTION CONSULTATION, PLANNING, AND SUPERVISION (U.S. CLS. 100 AND 101).
FIRST USE 4-0-2006; IN COMMERCE 4-0-2006.

3,313,072. BDMETRICS, INC., BALTIMORE, MD. SN 76-608,711. PUB. 5-30-2006, FILED 8-26-2004.

CONVERTING COMMUNITIES INTO COMMERCE

THE MARK CONSISTS OF STANDARD CHARACTERS WITHOUT CLAIM TO ANY PARTICULAR FONT, STYLE, SIZE, OR COLOR.

CLASS 35—ADVERTISING AND BUSINESS

FOR PROVIDING A FORUM FOR BUSINESS NETWORKING TO FACILITATE BUSINESS TO BUSINESS TRANSACTIONS AND TO ALLOW PARTICIPANTS TO DEFINE THEIR OWN CUSTOM NETWORKING SEARCHES, NAMELY, PROVIDING ONLINE BUSINESS INFORMATION IN THE NATURE OF CUSTOMIZED RECOMMENDATIONS FOR BUSINESS OPPORTUNITIES BASED ON INPUT PROVIDED BY THE USER; PROVIDING INTELLIGENT ANALYSIS OF NEW BUSINESS OPPORTUNITIES BY INTRODUCING NEW POTENTIAL CUSTOMERS AND/OR MARKETS IN WHICH TO SELL GOODS OR SERVICES, NAMELY, BUSINESS ANALYSIS OF USERS' TECHNOLOGIES AND PRODUCTS TO GENERATE MATCHES WITH COMPANIES HAVING COMPLEMENTARY TECHNOLOGIES AND PRODUCTS (U.S. CLS. 100, 101 AND 102).
FIRST USE 11-11-2004; IN COMMERCE 11-11-2004.

CLASS 38—COMMUNICATION

FOR PROVIDING A WEBSITE VIA A GLOBAL COMPUTER NETWORK TO FACILITATE THE EXCHANGE OF BUSINESS, FINANCIAL AND TECHNOLOGY INFORMATION ON A WIDE VARIETY OF GOODS AND SERVICES, NAMELY, ONLINE ELECTRONIC EXCHANGE OF DATA STORED IN DATABASES REGARDING INFORMATION TO ENABLE USERS TO IDENTIFY PROFITABLE CUSTOMERS, MARKETS AND BUSINESS DEALS VIA THE INTERNET (U.S. CLS. 100, 101 AND 104).

FIRST USE 11-11-2004; IN COMMERCE 11-11-2004.

3,313,074. ARVEDA, LLC, DBA STROMGREN SUPPORTS, HAYS, KS. SN 76-610,549. PUB. 7-18-2006, FILED 9-3-2004.

PERMALITE

THE MARK CONSISTS OF STANDARD CHARACTERS WITHOUT CLAIM TO ANY PARTICULAR FONT, STYLE, SIZE, OR COLOR.

CLASS 25—CLOTHING

FOR FOOTBALL COMPRESSION SHIRTS (U.S. CLS. 22 AND 39).
FIRST USE 10-0-2003; IN COMMERCE 10-0-2003.

CLASS 28—TOYS AND SPORTING GOODS

FOR FOOTBALL GIRDLES (U.S. CLS. 22, 23, 38 AND 50).
FIRST USE 10-0-2003; IN COMMERCE 10-0-2003.

3,313,077. SPECTRUM ORGANIC PRODUCTS, INC., PETALUMA, CA. SN 76-613,059. PUB. 8-30-2005, FILED 9-20-2004.

THE TASTE OF GOODNESS

THE MARK CONSISTS OF STANDARD CHARACTERS WITHOUT CLAIM TO ANY PARTICULAR FONT, STYLE, SIZE, OR COLOR.

CLASS 5—PHARMACEUTICALS

FOR NUTRITIONAL SUPPLEMENTS AND NUTRITIONAL OILS FOR THERAPEUTIC AND HEALTH BENEFIT PURPOSES (U.S. CLS. 6, 18, 44, 46, 51 AND 52).
FIRST USE 3-0-2005; IN COMMERCE 3-0-2005.

CLASS 29—MEATS AND PROCESSED FOODS

FOR EDIBLE OILS, VEGETABLE OILS, COOKING OILS, OLIVE OIL, VEGETABLE BASED SPREADS, VEGETABLE OIL SPRAYS, SHORTENINGS, SALAD OILS (U.S. CL. 46).
FIRST USE 8-0-2005; IN COMMERCE 8-0-2005.

CLASS 30—STAPLE FOODS

FOR SALAD DRESSINGS AND VINAIGRETTE (U.S. CL. 46).
FIRST USE 8-0-2005; IN COMMERCE 8-0-2005.

3,313,084. ACULINK MORTGAGE SOLUTIONS, LLC, TAMPA, FL. SN 76-621,510. PUB. 12-19-2006, FILED 11-19-2004.

ACULINK

THE MARK CONSISTS OF STANDARD CHARACTERS WITHOUT CLAIM TO ANY PARTICULAR FONT, STYLE, SIZE, OR COLOR.

CLASS 36—INSURANCE AND FINANCIAL

FOR REAL ESTATE MANAGEMENT SERVICES, NAMELY, APPRAISALS, OBTAINING TITLE INSURANCE, AND REAL ESTATE VALUATION (U.S. CLS. 100, 101 AND 102).

FIRST USE 9-27-2004; IN COMMERCE 2-21-2005.

CLASS 42—SCIENTIFIC AND COMPUTER SERVICES

FOR REAL ESTATE SERVICES, NAMELY, REAL ESTATE SETTLEMENT SERVICES; PREPARATION AND RECORDING OF REAL ESTATE DOCUMENTS AND TITLE SEARCHES; REAL ESTATE INSPECTION SERVICES (U.S. CLS. 100 AND 101).

FIRST USE 9-27-2004; IN COMMERCE 2-21-2005.

3,313,094. FULCRUM INDUSTRIES, INC., SACRAMENTO, CA. SN 76-624,591. PUB. 12-20-2005, FILED 12-16-2004.

WORKWISE

CLASS 8—HAND TOOLS

FOR HAND OPERATED TOOLS FOR WOOD WORKING, METAL WORKING AND TRANSPORTATION OF OBJECTS, NAMELY, HAMMERS, SAWS, DRILLS, CHISELS, SCREWDRIVERS, SHARPENERS, NON-METAL DOOR SUPPORTS TO LIFT DOORS AND ENABLE HINGE ATTACHMENT, KNIVES, PLANES, PLIERS, WRENCHES, AND RATCHETS (U.S. CLS. 23, 28 AND 44).

FIRST USE 6-26-2006; IN COMMERCE 6-26-2006.

CLASS 20—FURNITURE AND ARTICLES NOT OTHERWISE CLASSIFIED

FOR WORKPLACE FURNITURE, NAMELY, DESKS, CHAIRS, BENCHES, PARTITIONS, TOOL CABINETS, AND FREE STANDING TOOL RACKS (U.S. CLS. 2, 13, 22, 25, 32 AND 50).

FIRST USE 6-26-2006; IN COMMERCE 6-26-2006.

CLASS 35—ADVERTISING AND BUSINESS

FOR RETAIL STORE SERVICES FEATURING HAND TOOLS, FURNITURE, COMPUTERS, AND COMPUTER SOFTWARE (U.S. CLS. 100, 101 AND 102).

FIRST USE 6-26-2006; IN COMMERCE 6-26-2006.

3,313,097. TERRELL PUBLISHING COMPANY, KANSAS CITY, MO. SN 76-625,855. PUB. 4-11-2006, FILED 12-27-2004.



NO CLAIM IS MADE TO THE EXCLUSIVE RIGHT TO USE "VINTAGE VEGAS", APART FROM THE MARK AS SHOWN.

CLASS 16—PAPER GOODS AND PRINTED MATTER

FOR INDIVIDUAL NOTE CARDS, MATTED PRINTS, PHOTO ALBUMS, AND POSTCARDS (U.S. CLS. 2, 5, 22, 23, 29, 37, 38 AND 50).

FIRST USE 8-16-2004; IN COMMERCE 4-26-2005.

CLASS 20—FURNITURE AND ARTICLES NOT OTHERWISE CLASSIFIED

FOR PHOTO FRAMES AND FRAMING PRINT SETS COMPRISING PICTURE FRAMES, GLASS FOR USE IN FRAMING, AND PRINTS (U.S. CLS. 2, 13, 22, 25, 32 AND 50).

FIRST USE 8-18-2004; IN COMMERCE 4-26-2005.

3,313,101. EL BATAL CORPORATION, DBA GRIP TIGHT TOOLS, HILLSIDE, NJ. SN 76-629,079. PUB. 8-8-2006, FILED 1-24-2005.



NO CLAIM IS MADE TO THE EXCLUSIVE RIGHT TO USE "TOOLS", APART FROM THE MARK AS SHOWN.

CLASS 7—MACHINERY

FOR ELECTRIC POWER TOOLS, NAMELY, DRILLS, ANGLE GRINDERS, ELECTRIC HOLE SAWS, CIRCULAR SAWS, JIGSAWS, RECIPROCATING SAWS AND SANDERS; ELECTRIC POWER SAW BLADES FOR CIRCULAR SAWS, JIGSAWS, RECIPROCATING SAWS AND HOLE SAWS; POWER DRILL BITS FOR DRILLING METAL, MASONRY, GRANITE, GLASS AND WOOD; SHARPENING STONES; TILE CUTTING MACHINES; HYDRAULIC JACKS, CUTTING AND GRINDING ABRASIVE DISCS FOR POWER TOOLS USED TO CUT AND GRIND METAL OR MASONRY (U.S. CLS. 13, 19, 21, 23, 31, 34 AND 35).

FIRST USE 12-21-2004; IN COMMERCE 2-28-2005.

CLASS 8—HAND TOOLS

FOR HAND TOOLS, NAMELY, NAIL AND SOCKET SETS, HAMMERS, SCREWDRIVERS, WRENCHES, SAWS, PLIERS, UTILITY KNIVES, TAPS, SCRAPERS, TROWELS, WOOD AND PLASTIC FLOATS AND HAWKS; BLADES FOR HAND SAWS; TOOL POUCHES FOR ATTACHMENT TO TOOL BELTS; TOOL BELTS; TOOL APRONS; TOOL HOLDERS (U.S. CLS. 23, 28 AND 44).

FIRST USE 12-21-2004; IN COMMERCE 2-28-2005.

CLASS 9—ELECTRICAL AND SCIENTIFIC APPARATUS

FOR MEASURING TOOLS, NAMELY, RULERS, MEASURING TAPES AND CARPENTERS'S LEVELS; PROTECTIVE EQUIPMENT, NAMELY, PROTECTIVE MASKS, WORK GLOVES, HELMETS AND EYE GOGGLES (U.S. CLS. 21, 23, 26, 36 AND 38).

FIRST USE 12-21-2004; IN COMMERCE 2-28-2005.

3,313,102. TOHO CO., LTD., NISHI-KU, HIROSHIMA-SHI, HIROSHIMA, JAPAN. SN 76-630,086. PUB. 4-18-2006, FILED 1-31-2005.



THE STYLIZED JAPANESE CHARACTER IN THE MARK HAS A MEANING OF TREASURE IN ENGLISH.

THE NON-LATIN CHARACTERS IN THE MARK TRANSLITERATE TO TAKARA AND THIS MEANS TREASURE IN ENGLISH.

CLASS 14—JEWELRY

FOR HANDCRAFT DECORATIVE BEADS USED IN THE MANUFACTURE OF JEWELRY (U.S. CLS. 2, 27, 28 AND 50).

FIRST USE 7-1-2000; IN COMMERCE 7-1-2005.

CLASS 26—FANCY GOODS

FOR HANDCRAFT DECORATIVE BEADS FOR USE ON CLOTHING, PURSES AND BAGS (U.S. CLS. 37, 39, 40, 42 AND 50).

FIRST USE 7-1-2000; IN COMMERCE 7-1-2005.

3,313,108. BUTLER TECHNOLOGY AND CAREER DEVELOPMENT SCHOOLS, FAIRFIELD TOWNSHIP, OH. SN 76-632,535. PUB. 6-20-2006, FILED 3-2-2005.



NO CLAIM IS MADE TO THE EXCLUSIVE RIGHT TO USE "TECH" AND "LAW ENFORCEMENT INSTITUTE", APART FROM THE MARK AS SHOWN.

CLASS 16—PAPER GOODS AND PRINTED MATTER

FOR PAPER COURSEWORK MATERIALS, NAMELY, COURSE CATALOGS, COURSE CURRICULA, HAND-OUTS, PRESENTATIONS, AND PROPOSALS TO PROVIDE TRAINING TO OFFICIALS AND PERSONNEL, ALL IN THE FIELD OF LAW ENFORCEMENT AND PUBLIC SAFETY (U.S. CLS. 2, 5, 22, 23, 29, 37, 38 AND 50).

FIRST USE 1-20-2005; IN COMMERCE 1-20-2005.

CLASS 41—EDUCATION AND ENTERTAINMENT

FOR PROVIDING EDUCATIONAL SERVICES, NAMELY, CONDUCTING CLASSES, WORKSHOPS, AND SEMINARS, ALL IN THE FIELD OF LAW ENFORCEMENT AND PUBLIC SAFETY (U.S. CLS. 100, 101 AND 107).

FIRST USE 1-20-2005; IN COMMERCE 1-20-2005.

3,313,109. GOODWAY PLASTIC PRODUCTS LIMITED, KWUN TONG, KOWLOON, HONG KONG. SN 76-632,882. PUB. 6-20-2006, FILED 3-8-2005.



PRIORITY CLAIMED UNDER SEC. 44(D) ON HONG KONG APPLICATION NO. 300367876, FILED 2-7-2005, REG. NO. 300367876, DATED 2-7-2005, EXPIRES 2-7-2015.

CLASS 7—MACHINERY

FOR ELECTRIC FOOD PROCESSORS; ELECTRIC FRUIT PEELERS; EXTRUSION MACHINES FOR FOOD, NAMELY ELECTRIC JUICERS; ELECTRIC MIXERS FOR HOUSEHOLD PURPOSES; ELECTRIC FOOD BLENDERS; HAND-OPERATED CUTTING INSTRUMENTS FOR HOUSEHOLD AND KITCHEN PURPOSES, NAMELY POWER FOOD PROCESSORS; ELECTRIC PUMPS AND VALVES FOR USE IN FOOD PROCESSORS; APPARATUS AND MACHINES FOR MINCING, GRINDING OR PRESSING FOOD, NAMELY MINCERS, COFFEE GRINDERS, PEPPER MILLS, SESAME MILLS, SALT MILLS (U.S. CLS. 13, 19, 21, 23, 31, 34 AND 35).

FIRST USE 2-15-2006; IN COMMERCE 2-15-2006.

CLASS 21—HOUSEWARES AND GLASS

FOR NON-ELECTRIC HAND-OPERATED APPARATUS AND MACHINES FOR FOOD PROCESSING, NAMELY HAND-OPERATED FOOD GRINDERS; NON-ELECTRIC MIXERS FOR HOUSEHOLD PURPOSES; HOUSEHOLD GRATERS; CONTAINERS FOR HOUSEHOLD USE, NOT OF PRECIOUS METAL; HOUSEHOLD UTENSILS, NAMELY COFFEE GRINDERS, MEAT MINCERS, PEPPER MILLS, SESAME MILLS, SALT MILLS, HEALTHY JUICERS, MINI SLICERS; SHOWER RACKS; SHAMPOO RACKS; TOILET UTENSILS, NAMELY KITCHEN TOWEL HOLDERS (U.S. CLS. 2, 13, 23, 29, 30, 33, 40 AND 50).

FIRST USE 2-15-2006; IN COMMERCE 2-15-2006.

3,313,114. NIEN MADE ENTERPRISE CO., LTD., TAI-CHUNG, TAIWAN. SN 76-634,606. PUB. 8-1-2006, FILED 3-30-2005.

PRESCRIPTION WOOD CONDITIONING

THE MARK CONSISTS OF STANDARD CHARACTERS WITHOUT CLAIM TO ANY PARTICULAR FONT, STYLE, SIZE, OR COLOR.

NO CLAIM IS MADE TO THE EXCLUSIVE RIGHT TO USE "WOOD CONDITIONING" WITH REGARD TO THE GOODS IDENTIFIED IN INTERNATIONAL CLASSES 19 AND 20, APART FROM THE MARK AS SHOWN.

CLASS 19—NON-METALLIC BUILDING MATERIALS

FOR NON METAL AND NON TEXTILES OUTDOOR BLINDS, NON METAL JALOUSIES, NON-METAL WINDOW SHUTTERS, NONMETAL WINDOWS, NON METAL DOORS (U.S. CLS. 1, 12, 33 AND 50).

FIRST USE 2-3-2007; IN COMMERCE 2-3-2007.

CLASS 20—FURNITURE AND ARTICLES NOT OTHERWISE CLASSIFIED

FOR WINDOW BLINDS, INDOOR WINDOW BLINDS, WINDOW SHADES, VENETIAN BLINDS, CURTAIN RODS, CURTAIN RAILS, NON METAL CURTAIN RINGS, NON TEXTILE MATERIAL CURTAIN HOLDS, CURTAIN HOOKS, DRAPERY HARDWARE, NAMELY, CURTAIN RINGS WITH A ROLLING MECHANISM (U.S. CLS. 2, 13, 22, 25, 32 AND 50).

FIRST USE 2-3-2007; IN COMMERCE 2-3-2007.

CLASS 24—FABRICS

FOR CURTAINS, NET CURTAINS, WINDOW CURTAINS, CURTAIN FABRICS, CURTAINS MADE OF TEXTILE OR PLASTICS, CURTAIN FOR SHOWERS, CURTAIN HOLDERS OF TEXTILE MATERIALS, CURTAIN MADE OF TEXTILE MATERIALS, CURTAIN TIE-BACKS OF TEXTILE (U.S. CLS. 42 AND 50).

FIRST USE 2-3-2007; IN COMMERCE 2-3-2007.

3,313,115. INSTITUTE OF MANAGEMENT ACCOUNTANTS, MONTVALE, NJ. SN 76-634,929. PUB. 7-4-2006, FILED 4-4-2005.

INSTITUTE OF MANAGEMENT ACCOUNTANTS

ADVANCING THE PROFESSION

THE MARK CONSISTS OF STANDARD CHARACTERS

WITHOUT CLAIM TO ANY PARTICULAR FONT, STYLE, SIZE, OR COLOR.

NO CLAIM IS MADE TO THE EXCLUSIVE RIGHT TO USE "INSTITUTE OF MANAGEMENT ACCOUNTANTS", APART FROM THE MARK AS SHOWN.

CLASS 35—ADVERTISING AND BUSINESS

FOR ASSOCIATION SERVICES, NAMELY PROMOTING THE INTERESTS OF MANAGEMENT ACCOUNTANTS; PROMOTING PUBLIC AWARENESS OF THE NEED FOR MANAGEMENT ACCOUNTANTS AND OF THE NEED FOR EDUCATIONAL PROGRAMS IN THE FIELDS OF MANAGEMENT ACCOUNTING AND FINANCIAL MANAGEMENT (U.S. CLS. 100, 101 AND 102).

FIRST USE 12-0-2005; IN COMMERCE 12-0-2005.

CLASS 41—EDUCATION AND ENTERTAINMENT

FOR EDUCATIONAL PROGRAMS IN THE FINANCIAL MANAGEMENT AND MANAGEMENT ACCOUNTING FIELDS, NAMELY EDUCATIONAL RESEARCH, ARRANGING AND CONDUCTING EDUCATIONAL CONFERENCES, EDUCATIONAL DEMONSTRATIONS AND EDUCATIONAL TESTING (U.S. CLS. 100, 101 AND 107).

FIRST USE 12-0-2005; IN COMMERCE 12-0-2005.

3,313,117. HARTMAN HOUSE, CALABASAS, CA. SN 76-635,350. PUB. 2-27-2007, FILED 4-8-2005.

**CLASS 35—ADVERTISING AND BUSINESS**

FOR CHARITABLE SERVICES, NAMELY, ORGANIZING AND CONDUCTING VOLUNTEER PROGRAMS AND COMMUNITY SERVICE PROJECTS, COORDINATING OF THE PROCUREMENT AND DISTRIBUTION OF FOOD DONATIONS FROM MANUFACTURERS, WHOLESALERS, RETAILERS, AND GOVERNMENT AGENCIES TO ORGANIZATIONS PROVIDING FREE FOOD TO NEEDY PEOPLE (U.S. CLS. 100, 101 AND 102).

FIRST USE 1-0-2004; IN COMMERCE 1-0-2004.

CLASS 36—INSURANCE AND FINANCIAL

FOR CHARITABLE FUNDRAISING AND SCHOLARSHIP SERVICES (U.S. CLS. 100, 101 AND 102).

FIRST USE 1-0-2004; IN COMMERCE 1-0-2004.

CLASS 41—EDUCATION AND ENTERTAINMENT

FOR CHARITABLE SERVICES, NAMELY, PROVIDING TOYS TO NEEDY CHILDREN (U.S. CLS. 100, 101 AND 107).

FIRST USE 1-0-2004; IN COMMERCE 1-0-2004.

CLASS 45—PERSONAL AND LEGAL SERVICES

FOR CHARITABLE SERVICES, NAMELY, PROVIDING CLOTHING TO NEEDY PERSONS (U.S. CLS. 100 AND 101).

FIRST USE 1-0-2004; IN COMMERCE 1-0-2004.

3,313,121. VP FOOTWEAR, INC., S. EL MONTE, CA. SN 76-635,993. PUB. 8-22-2006, FILED 4-12-2005.



THE MARK CONSISTS OF "FIVESTARPET" AND DESIGN, WHEREIN THE STYLIZED "FIVESTARPET" IS INCORPORATED WITH A MISCELLANEOUS DESIGN COMPRISING OF FIVE STARS.

CLASS 18—LEATHER GOODS

FOR WALKING AND DOG CONTROL ITEMS, NAMELY, LEASHES, LEASH HOOKS, COLLARS, TIE OUT CHAIN AND CABLES, AND CLOTH ROBES FOR PETS (U.S. CLS. 1, 2, 3, 22 AND 41).

FIRST USE 4-6-2007; IN COMMERCE 4-6-2007.

CLASS 28—TOYS AND SPORTING GOODS

FOR PET TOYS (U.S. CLS. 22, 23, 38 AND 50).
FIRST USE 4-6-2006; IN COMMERCE 4-6-2006.

3,313,122. ISHIDA CO., LTD., KYOTO-SHI, KYOTO 606-8392, JAPAN. SN 76-636,480. PUB. 1-17-2006, FILED 4-19-2005.

**CLASS 7—MACHINERY**

FOR PACKAGING MACHINES; MACHINES, NAMELY, ARTICLE CASE PACKER; MACHINES FOR APPLYING SEASONING TO FOODS; BAG MAKING MACHINES (U.S. CLS. 13, 19, 21, 23, 31, 34 AND 35).

FIRST USE 11-30-2004; IN COMMERCE 11-30-2004.

CLASS 9—ELECTRICAL AND SCIENTIFIC APPARATUS

FOR AUTOMATIC WEIGHERS, COMBINATION WEIGHERS, CHECKWEIGHERS; SEAL CHECKER FOR FLEXIBLE BAG LEAK DETECTION; METAL DETECTORS; INSPECTION DEVICES, NAMELY, X-RAYS, USED IN INDUSTRIAL APPLICATIONS; PARTS FOR THE AFORESAID GOODS; COMPUTERS, COMPUTER SOFTWARE AND DISPLAY SCREENS FOR CONTROLLING AUTOMATED PACKAGING SYSTEMS AND OPERATING WEIGHING, INSPECTION, BAG MAKING, AND CASE PACKING EQUIPMENT IN PACKAGING SYSTEMS (U.S. CLS. 21, 23, 26, 36 AND 38).

FIRST USE 11-30-2004; IN COMMERCE 11-30-2004.

3,313,128. SUBURBAN PROPANE, L.P., WHIPPANY, NJ. SN 76-637,243. PUB. 7-25-2006, FILED 4-27-2005.



OWNER OF U.S. REG. NOS. 2,583,709, 2,668,867, AND OTHERS.

NO CLAIM IS MADE TO THE EXCLUSIVE RIGHT TO USE "PROPANE TANKS", "RESIDENTIAL" AND "COMMERCIAL", APART FROM THE MARK AS SHOWN.

CLASS 35—ADVERTISING AND BUSINESS

FOR FRANCHISING, NAMELY, OFFERING TECHNICAL ASSISTANCE IN THE ESTABLISHMENT AND/OR OPERATION OF RETAIL AND WHOLESALE DISTRIBUTORSHIPS AND RETAIL STORES FEATURING PROPANE GAS AND PROPANE RELATED EQUIPMENT (U.S. CLS. 100, 101 AND 102).

FIRST USE 10-0-2005; IN COMMERCE 10-0-2005.

CLASS 39—TRANSPORTATION AND STORAGE

FOR PICK-UP AND DELIVERY OF PROPANE GAS CYLINDERS TO HOMES (U.S. CLS. 100 AND 105).

FIRST USE 3-0-2005; IN COMMERCE 3-0-2005.

3,313,138. DUCKWALL-ALCO STORES, INC., ABILENE, KS. SN 76-640,291. PUB. 5-23-2006, FILED 6-6-2005.

COTTAGE STREET**CLASS 20—FURNITURE AND ARTICLES NOT OTHERWISE CLASSIFIED**

FOR FURNITURE FOR HOUSE, OFFICE, AND GARDEN (U.S. CLS. 2, 13, 22, 25, 32 AND 50).

FIRST USE 4-0-1999; IN COMMERCE 4-0-2005.

CLASS 21—HOUSEWARES AND GLASS

FOR GARDENING GLOVES AND BASKETS OF WICKER, STRAW AND WOOD (U.S. CLS. 2, 13, 23, 29, 30, 33, 40 AND 50).

FIRST USE 4-0-1999; IN COMMERCE 4-0-2005.

CLASS 25—CLOTHING

FOR CLOTHING, NAMELY, PANTS, SHIRTS, TOPS, SWEATERS, SKIRTS, SHORTS, DRESSES, SHIRTS, UNDERWEAR, SOCKS, SWIM WEAR, JACKETS, COATS, BOOTS, SHOES, AND SANDALS (U.S. CLS. 22 AND 39).

FIRST USE 4-0-1999; IN COMMERCE 4-0-2005.

CLASS 26—FANCY GOODS

FOR DECORATIVE ARTICLES, NAMELY, SILK FLOWERS AND CENTERPIECES, GARLANDS, WREATHS AND WALL HANGINGS MADE OF SILK FLOWERS (U.S. CLS. 37, 39, 40, 42 AND 50).

FIRST USE 4-0-1999; IN COMMERCE 4-0-2005.

3,313,140. AGE GROUP, LTD., NEW YORK, NY. SN 76-640,294. PUB. 7-18-2006, FILED 6-6-2005.

3,313,214. JEWELEX NEW YORK LTD., NEW YORK, NY. SN 76-661,906. PUB. 11-7-2006, FILED 6-21-2006.

PUPPY'S FIRST

THE MARK CONSISTS OF STANDARD CHARACTERS WITHOUT CLAIM TO ANY PARTICULAR FONT, STYLE, SIZE, OR COLOR.

NO CLAIM IS MADE TO THE EXCLUSIVE RIGHT TO USE "PUPPY'S", APART FROM THE MARK AS SHOWN.

CLASS 18—LEATHER GOODS

FOR LEASHES AND COLLARS FOR ANIMALS; PET CARRYING CASES; PET CLOTHING (U.S. CLS. 1, 2, 3, 22 AND 41).

FIRST USE 6-30-2005; IN COMMERCE 6-30-2005.

CLASS 20—FURNITURE AND ARTICLES NOT OTHERWISE CLASSIFIED

FOR PET BEDS, PET PILLOWS AND BLANKETS (U.S. CLS. 2, 13, 22, 25, 32 AND 50).

FIRST USE 6-30-2005; IN COMMERCE 6-30-2005.

CLASS 28—TOYS AND SPORTING GOODS

FOR PET TOYS (U.S. CLS. 22, 23, 38 AND 50).

FIRST USE 6-30-2005; IN COMMERCE 6-30-2005.

3,313,144. AETREX WORLDWIDE INC., TEANECK, NJ. SN 76-641,541. PUB. 7-25-2006, FILED 6-23-2005.

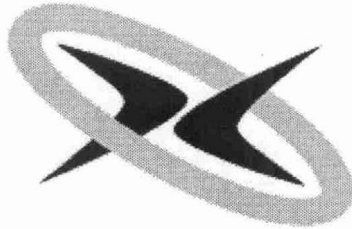

THE MARK CONSISTS OF CHEVRONS THAT FORM THE STYLIZED LETTER X WHICH IS SURROUNDED BY A CIRCULAR DESIGN.

CLASS 10—MEDICAL APPARATUS

FOR ORTHOTICS FOR FEET (U.S. CLS. 26, 39 AND 44).

FIRST USE 5-1-2005; IN COMMERCE 5-1-2005.

CLASS 25—CLOTHING

FOR INSOLES, SHOES, BOOTS, SOCKS, SLIPPERS, SHIRTS, PANTS, JACKETS, HATS, CAPS, SHORTS, GLOVES, SWEAT SUITS, HEAD WEAR, HEAD BANDS, T-SHIRTS, SKIRTS, JACKETS, RAINWEAR, VESTS, SWEATERS, TANK TOPS, TURTLENECKS, VISORS AND WRIST BANDS (U.S. CLS. 22 AND 39).

FIRST USE 5-1-2005; IN COMMERCE 5-1-2005.

PERFEKT MEMORIES

THE MARK CONSISTS OF STANDARD CHARACTERS WITHOUT CLAIM TO ANY PARTICULAR FONT, STYLE, SIZE, OR COLOR.

OWNER OF U.S. REG. NOS. 2,852,182 AND 3,088,082.

CLASS 14—JEWELRY

FOR JEWELRY, NAMELY, GOLD, PLATINUM, TITANIUM AND SILVER JEWELRY; AND GOLD, PLATINUM, TITANIUM AND SILVER JEWELRY WITH PRECIOUS STONES, NAMELY DIAMONDS, RUBIES, EMERALDS, SAPPHIRES, AND SEMI-PRECIOUS COLORED STONES EMBEDDED THEREIN, AND PEARLS EMBEDDED THEREIN (U.S. CLS. 2, 27, 28 AND 50).

FIRST USE 6-25-2006; IN COMMERCE 6-25-2006.

CLASS 35—ADVERTISING AND BUSINESS

FOR DISTRIBUTORSHIPS IN THE FIELD OF JEWELRY (U.S. CLS. 100, 101 AND 102).

FIRST USE 6-25-2006; IN COMMERCE 6-25-2006.

3,313,222. VERDE REALTY OPERATING PARTNERSHIP L.P., EL PASO, TX. SN 76-664,938. PUB. 11-14-2006, FILED 8-22-2006.

VERDE CORPORATE REALTY SERVICES

THE MARK CONSISTS OF STANDARD CHARACTERS WITHOUT CLAIM TO ANY PARTICULAR FONT, STYLE, SIZE, OR COLOR.

NO CLAIM IS MADE TO THE EXCLUSIVE RIGHT TO USE "CORPORATE REALTY SERVICES", APART FROM THE MARK AS SHOWN.

THE TERM "VERDE" TRANSLATES INTO ENGLISH AS "GREEN".

CLASS 36—INSURANCE AND FINANCIAL

FOR REAL ESTATE MANAGEMENT SERVICES; REAL ESTATE INVESTMENT OF COMMERCIAL PROPERTIES; MORTGAGE BANKING AND MORTGAGE PROCUREMENT FOR OTHERS; CONSTRUCTION FINANCING FOR HOMEBUILDERS; INSURANCE UNDERWRITING FOR HOMEBUYERS IN THE FIELDS OF HOME AND AUTO INSURANCE; TITLE INSURANCE UNDERWRITING IN THE FIELD OF REAL ESTATE; FINANCIAL SERVICES, NAMELY, PROVIDING CONSTRUCTION LOAN FINANCING FOR HOMEBUILDERS (U.S. CLS. 100, 101 AND 102).

FIRST USE 6-1-2005; IN COMMERCE 6-1-2005.

CLASS 37—CONSTRUCTION AND REPAIR

FOR LAND DEVELOPMENT SERVICES, NAMELY, PLANNING AND LAYING OUT OF RESIDENTIAL AND/OR COMMERCIAL COMMUNITIES, RETAIL, INDUSTRIAL AND DISTRIBUTION SPACE, AND APARTMENTS; COMMERCIAL REAL ESTATE PROPERTY DEVELOPMENT (U.S. CLS. 100, 103 AND 106).

FIRST USE 6-1-2005; IN COMMERCE 6-1-2005.

3,313,224. VERDE REALTY OPERATING PARTNERSHIP L.P., EL PASO, TX. SN 76-665,436. PUB. 11-14-2006, FILED 8-31-2006.



VERDE CORPORATE REALTY SERVICES

OWNER OF U.S. REG. NO. 3,042,588.
NO CLAIM IS MADE TO THE EXCLUSIVE RIGHT TO USE "CORPORATE REALTY SERVICES", APART FROM THE MARK AS SHOWN.
THE TERM "VERDE" TRANSLATES INTO ENGLISH AS "GREEN".

CLASS 36—INSURANCE AND FINANCIAL

FOR REAL ESTATE MANAGEMENT SERVICES; REAL ESTATE INVESTMENT OF COMMERCIAL PROPERTIES; MORTGAGE BANKING AND MORTGAGE PROCUREMENT FOR OTHERS; CONSTRUCTION FINANCING FOR HOMEBUILDERS; INSURANCE UNDERWRITING FOR HOMEBUYERS IN THE FIELDS OF HOME AND AUTO INSURANCE; TITLE INSURANCE UNDERWRITING IN THE FIELD OF REAL ESTATE; FINANCIAL SERVICES, NAMELY, PROVIDING CONSTRUCTION LOAN FINANCING FOR HOMEBUILDERS (U.S. CLS. 100, 101 AND 102).
FIRST USE 6-1-2005; IN COMMERCE 6-1-2005.

CLASS 37—CONSTRUCTION AND REPAIR

FOR LAND DEVELOPMENT SERVICES, NAMELY, PLANNING AND LAYING OUT OF RESIDENTIAL AND/OR COMMERCIAL COMMUNITIES, RETAIL, INDUSTRIAL AND DISTRIBUTION SPACE, AND APARTMENTS; COMMERCIAL REAL ESTATE PROPERTY DEVELOPMENT (U.S. CLS. 100, 103 AND 106).
FIRST USE 6-1-2005; IN COMMERCE 6-1-2005.

3,313,236. JOHNSTON FARMS, L.L.C., HIGLEY, AZ. SN 76-975,727. PUB. 1-27-2004, FILED 10-1-2001.

AGRITOPIA

CLASS 29—MEATS AND PROCESSED FOODS

FOR SOUPS; PICKLES; PROCESSED OLIVES; PRESERVED FRUITS; JAMS; JELLIES; DRIED FRUITS; CHEESE; EGGS; MILK; CREAM; FRESH CHICKEN, TURKEY, PORK AND BEEF; JERKY; BACON; SAUSAGES; POTATO CHIPS; DRIED VEGETABLES; DRIED FRUIT; DRIED MUSHROOMS; HERBS; FROZEN MEAT, FISH, POULTRY AND PROCESSED VEGETABLES (U.S. CL. 46).
FIRST USE 3-31-2007; IN COMMERCE 3-31-2007.

CLASS 30—STAPLE FOODS

FOR SALSAS; TOMATO SAUCE; PASTA SAUCE; BBQ SAUCE; MUSTARDS; DRY MIXES OF HERBS AND PROCESSED HERBS; SALAD DRESSINGS; VINEGAR; FLAVORED SIMPLE SYRUPS; HONEY; COFFEE BEANS; TEA LEAVES; HERBAL TEA; PASTA; BREADS; MUFFINS; ROLLS; COOKIES; CAKES; PIES; BAKERY DESERTS; CROUTONS; BAKERY MIXES; CANDY; CORN CHIPS; MEAL CONSISTING PRIMARILY OF FROZEN PASTA AND RICE; ICE CREAM; SORBETS; BREAKFAST CEREALS; GRANOLAS; PROCESSED HERBS (U.S. CL. 46).
FIRST USE 3-31-2007; IN COMMERCE 3-31-2007.

CLASS 43—HOTEL AND RESTAURANT SERVICES

FOR RESTAURANT SERVICES AND CATERING SERVICES (U.S. CLS. 100 AND 101).
FIRST USE 3-31-2007; IN COMMERCE 3-31-2007.

3,313,241. BEVERAGE PARTNERS WORLDWIDE (NORTH AMERICA), ATLANTA, GA. SN 77-001,494. PUB. 4-24-2007, FILED 9-18-2006.



THE COLOR(S) ORANGE, RED AND WHITE IS/ARE CLAIMED AS A FEATURE OF THE MARK.

THE MARK CONSISTS OF A FLAME DESIGN WITH AN ORANGE OUTER SECTION, A RED MIDSECTION AND A WHITE INNER SECTION.

CLASS 30—STAPLE FOODS

FOR TEA; BEVERAGES MADE OF TEA; ICED TEA; GREEN TEA; TEA WITH FRUIT FLAVORINGS (U.S. CL. 46).
FIRST USE 11-6-2006; IN COMMERCE 11-6-2006.

CLASS 32—LIGHT BEVERAGES

FOR ENERGY DRINKS (U.S. CLS. 45, 46 AND 48).
FIRST USE 11-6-2006; IN COMMERCE 11-6-2006.

3,313,272. SONG, DA, SAN LEANDRO, CA. SN 77-011,375. PUB. 5-8-2007, FILED 10-1-2006.

EZstudio

THE MARK CONSISTS OF STANDARD CHARACTERS WITHOUT CLAIM TO ANY PARTICULAR FONT, STYLE, SIZE, OR COLOR.

CLASS 9—ELECTRICAL AND SCIENTIFIC APPARATUS

FOR LIGHTING DEVICES FOR TAKING PICTURES; PORTABLE PHOTOGRAPHY EQUIPMENT, NAMELY, REFLECTORS, TRIPODS, LIGHT STANDS AND SUPPORTS AND BAGS SPECIALLY ADAPTED FOR THESE GOODS (U.S. CLS. 21, 23, 26, 36 AND 38).
FIRST USE 6-1-2006; IN COMMERCE 8-1-2006.

CLASS 11—ENVIRONMENTAL CONTROL APPARATUS

FOR ELECTRIC LIGHT BULBS; ELECTRIC LIGHTING FIXTURES; FILTERS FOR PHOTOGRAPHIC, CINEMATOGRAPHIC, VIDEO AND PERFORMING ARTS LIGHTING; LIGHT DIFFUSERS; LIGHT REFLECTORS; LIGHTING DEVICES FOR SHOWCASES (U.S. CLS. 13, 21, 23, 31 AND 34).

FIRST USE 6-1-2006; IN COMMERCE 8-1-2006.

3,313,277. SECOND CHANCE MOTORS, INC., MARIETTA, GA. SN 77-013,191. PUB. 5-15-2007, FILED 10-4-2006.

SECOND CHANCE

THE MARK CONSISTS OF STANDARD CHARACTERS WITHOUT CLAIM TO ANY PARTICULAR FONT, STYLE, SIZE, OR COLOR.

CLASS 35—ADVERTISING AND BUSINESS

FOR AUTOMOBILE DEALERSHIPS; PROVIDING INFORMATION ABOUT AUTOMOBILES FOR SALE BY MEANS OF THE INTERNET (U.S. CLS. 100, 101 AND 102).

FIRST USE 4-30-2002; IN COMMERCE 4-30-2002.

CLASS 36—INSURANCE AND FINANCIAL

FOR FINANCING RELATING TO AUTOMOBILES (U.S. CLS. 100, 101 AND 102).

FIRST USE 4-30-2002; IN COMMERCE 4-30-2002.

3,313,278. GORILLA GLUE COMPANY, THE, CINCINNATI, OH. SN 77-013,697. PUB. 3-20-2007, FILED 10-4-2006.

**FOR THE TOUGHEST JOBS ON
PLANET EARTH**

THE MARK CONSISTS OF STANDARD CHARACTERS WITHOUT CLAIM TO ANY PARTICULAR FONT, STYLE, SIZE, OR COLOR.

OWNER OF U.S. REG. NO. 2,324,135.

CLASS 1—CHEMICALS

FOR ADHESIVES OTHER THAN FOR STATIONERY OR HOUSEHOLD PURPOSES (U.S. CLS. 1, 5, 6, 10, 26 AND 46).

FIRST USE 3-0-2007; IN COMMERCE 3-0-2007.

CLASS 16—PAPER GOODS AND PRINTED MATTER

FOR ADHESIVE TAPES FOR STATIONERY, HOUSEHOLD, OR DO-IT-YOURSELF PURPOSES; ADHESIVES FOR STATIONERY OR HOUSEHOLD PURPOSES (U.S. CLS. 2, 5, 22, 23, 29, 37, 38 AND 50).

FIRST USE 3-0-2007; IN COMMERCE 3-0-2007.

CLASS 17—RUBBER GOODS

FOR ADHESIVE TAPES FOR INDUSTRIAL OR COMMERCIAL PURPOSES (U.S. CLS. 1, 5, 12, 13, 35 AND 50).

FIRST USE 3-0-2007; IN COMMERCE 3-0-2007.

3,313,282. SOLE MATTERS, LLC, CHATTANOOGA, TN. SN 77-015,701. PUB. 5-15-2007, FILED 10-6-2006.

FOR A WALKABLE WORLD

THE MARK CONSISTS OF STANDARD CHARACTERS WITHOUT CLAIM TO ANY PARTICULAR FONT, STYLE, SIZE, OR COLOR.

CLASS 25—CLOTHING

FOR FOOTWEAR (U.S. CLS. 22 AND 39).

FIRST USE 8-28-2007; IN COMMERCE 8-28-2007.

CLASS 35—ADVERTISING AND BUSINESS

FOR RETAIL STORES FEATURING A WIDE VARIETY OF CONSUMER GOODS OF OTHERS, FOOTWEAR, SHOES, SOCKS, AND RELATED ACCESSORIES (U.S. CLS. 100, 101 AND 102).

FIRST USE 8-28-2007; IN COMMERCE 8-28-2007.

3,313,294. DE NOVO ENTERPRISES, L.L.C., HILLSBOROUGH, NJ. SN 77-023,637. PUB. 5-15-2007, FILED 10-18-2006.

TRAVELRIFIC

THE MARK CONSISTS OF STANDARD CHARACTERS WITHOUT CLAIM TO ANY PARTICULAR FONT, STYLE, SIZE, OR COLOR.

CLASS 38—COMMUNICATION

FOR PODCASTING SERVICES (U.S. CLS. 100, 101 AND 104).

FIRST USE 5-14-2007; IN COMMERCE 5-14-2007.

CLASS 41—EDUCATION AND ENTERTAINMENT

FOR ON-LINE JOURNALS, NAMELY, BLOGS FEATURING INFORMATION ON TRAVEL (U.S. CLS. 100, 101 AND 107).

FIRST USE 5-14-2007; IN COMMERCE 5-14-2007.

3,313,303. SCRATCH CONCEPTS, INC., GREENVILLE, SC. SN 77-029,207. PUB. 5-29-2007, FILED 10-25-2006.

3,313,355. BIOSCALE, INC., CAMBRIDGE, MA. SN 78-138,751. PUB. 2-24-2004, FILED 6-25-2002.

SCRATCH

THE MARK CONSISTS OF STANDARD CHARACTERS WITHOUT CLAIM TO ANY PARTICULAR FONT, STYLE, SIZE, OR COLOR.

CLASS 39—TRANSPORTATION AND STORAGE

FOR FOOD DELIVERY (U.S. CLS. 100 AND 105).
FIRST USE 4-9-2007; IN COMMERCE 4-9-2007.

CLASS 43—HOTEL AND RESTAURANT SERVICES

FOR FOOD PREPARATION (U.S. CLS. 100 AND 101).
FIRST USE 4-9-2007; IN COMMERCE 4-9-2007.

3,313,350. LP STYLE, LLC, NEW YORK, NY. SN 77-975,020.
PUB. 3-13-2007, FILED 9-15-2006.



THE MARK CONSISTS OF A STYLIZED LOWER-CASE LP CONSTRUCTED EXCLUSIVELY FROM BASIC GEOMETRIC FORMS.

CLASS 18—LEATHER GOODS

FOR WOMEN'S HANDBAGS (U.S. CLS. 1, 2, 3, 22 AND 41).
FIRST USE 3-21-2007; IN COMMERCE 3-21-2007.

CLASS 25—CLOTHING

FOR WOMEN'S CLOTHING, NAMELY, DRESSES, TUNICS, SKIRTS, PANTS, JACKETS, COATS, AND EVENING WEAR, NAMELY, EVENING DRESSES AND EVENING GOWNS (U.S. CLS. 22 AND 39).
FIRST USE 4-10-2007; IN COMMERCE 4-10-2007.

BIOSCALE

CLASS 1—CHEMICALS

FOR DIAGNOSTIC REAGENTS FOR SCIENTIFIC USE (U.S. CLS. 1, 5, 6, 10, 26 AND 46).
FIRST USE 5-17-2007; IN COMMERCE 5-17-2007.

CLASS 9—ELECTRICAL AND SCIENTIFIC APPARATUS

FOR BIO-MOLECULAR SENSING SYSTEMS AND MICROELECTRONIC MECHANICAL SYSTEMS COMPRISED OF FUNCTIONALIZED BIOCHIPS THAT PERMIT CAPTURE OF ANALYTICS FOR MEASUREMENT, MINIATURE SENSORS COMPRISED OF MICROELECTROMECHANICAL RESONANT STRUCTURES FOR TESTING SAMPLES FOR USE IN FOOD AND WATER TESTING, MEDICAL DIAGNOSTICS, ENVIRONMENTAL MONITORING, PHARMACEUTICALS AND THERAPEUTICS DEVELOPMENT AND PRODUCTION AS WELL AS MATERIALS CHARACTERIZATION; MODULAR COMPONENTS FOR FLUIDIC TRANSPORT AND DELIVERY OF SAMPLES TO SENSORS, NAMELY, FLUID CHANNELS, VALVES, FILTERS, CONCENTRATORS, SEPARATORS AND PUMPS; ELECTRONICS, NAMELY, PRINTED CIRCUIT BOARDS FOR EXCITATION AND SENSING OF MOTION OF THE MICROSTRUCTURES AND MICROPROCESSOR-BASED CONTROLLERS FOR ACQUIRING AND PROCESSING SENSOR OUTPUT AND CONTROLLING SYSTEM OPERATION; ELECTRICAL COMPONENTS, NAMELY, CONNECTORS, CABLES, HEATERS, THERMOELECTRIC COOLERS AND TEMPERATURE SENSORS FOR INTERFACING BIOCHIPS TO SYSTEMS AND ENVIRONMENTAL CONTROLS; COMPUTER SOFTWARE FOR OPERATING BIO-MOLECULAR SENSING SYSTEMS AND GRAPHICAL USER INTERFACE SOFTWARE ALL FOR USE IN THE FIELDS OF BIOLOGICAL, CHEMICAL AND BIOCHEMICAL SENSING (U.S. CLS. 21, 23, 26, 36 AND 38).

FIRST USE 5-17-2007; IN COMMERCE 5-17-2007.

CLASS 10—MEDICAL APPARATUS

FOR MEDICAL EQUIPMENT IN THE NATURE OF A BIO-MOLECULAR SENSING SYSTEM AND MICROELECTRONIC MECHANICAL SYSTEM COMPRISED OF FUNCTIONALIZED BIOCHIPS THAT PERMIT CAPTURE OF ANALYTICS FOR MEASUREMENT, MEDICAL EQUIPMENT IN THE NATURE OF MICROELECTROMECHANICAL SYSTEM RESONATING STRUCTURES AND SENSORS FOR USE IN THE ANALYSIS OF PHYSIOLOGICAL FLUIDS, SOLIDS, AEROSOLS AND GASES SUCH AS RAW AND PROCESSED BLOOD, LYMPH, SALIVA, URINE, STOOL, BREATH AND FLATULENCE; MEDICAL EQUIPMENT, NAMELY MODULAR COMPONENTS FOR FLUIDIC TRANSPORT, AND DELIVERY OF SAMPLES TO SENSORS FOR USE IN POINT OF CARE DIAGNOSIS AS WELL AS LABORATORY TESTING (U.S. CLS. 26, 39 AND 44).

FIRST USE 5-17-2007; IN COMMERCE 5-17-2007.

CLASS 42—SCIENTIFIC AND COMPUTER SERVICES

FOR DESIGN OF BIOMOLECULAR SENSING SYSTEMS (U.S. CLS. 100 AND 101).
FIRST USE 12-15-2003; IN COMMERCE 12-15-2003.

3,313,367. GITTENS, GARY A., JAMAICA, NY. SN 78-196,053. PUB. 4-6-2004, FILED 12-18-2002.



NO CLAIM IS MADE TO THE EXCLUSIVE RIGHT TO USE "GEMSTONE", "INC. SEMIPRECIOUS GEMSTONE TREES & BELTS" AND THE DESCRIPTIVE DESIGN OF THE CRYSTAL GEMSTONES, APART FROM THE MARK AS SHOWN.

CLASS 14—JEWELRY

FOR SEMIPRECIOUS GEMSTONE JEWELRY (U.S. CLS. 2, 27, 28 AND 50). FIRST USE 12-23-2003; IN COMMERCE 12-23-2004.

CLASS 35—ADVERTISING AND BUSINESS

FOR ON-LINE AND RETAIL STORE SERVICES FEATURING SEMIPRECIOUS GEMSTONE JEWELRY, BELTS, AND BUCKLES (U.S. CLS. 100, 101 AND 102). FIRST USE 6-11-2003; IN COMMERCE 6-11-2003.

CLASS 40—MATERIAL TREATMENT

FOR CUSTOM MANUFACTURING OF SEMIPRECIOUS GEMSTONE JEWELRY, BELTS OF WOOD AND SEMIPRECIOUS STONES, AND BUCKLES (U.S. CLS. 100, 103 AND 106). FIRST USE 12-23-2003; IN COMMERCE 12-23-2004.

3,313,370. MDE MEDIZINTECHNIK GMBH, SCHAFFHAUSEN, SWITZERLAND. SN 78-214,595. PUB. 3-14-2006, FILED 2-13-2003.

BEAUTYLIGHT

THE MARK CONSISTS OF STANDARD CHARACTERS WITHOUT CLAIM TO ANY PARTICULAR FONT, STYLE, SIZE, OR COLOR.

PRIORITY CLAIMED UNDER SEC. 44(D) ON SWITZERLAND APPLICATION NO. 20027177, FILED 8-19-2002, REG. NO. 507962, DATED 2-19-2003, EXPIRES 8-19-2012.

PRIORITY CLAIMED UNDER SEC. 44(D) ON SWITZERLAND APPLICATION NO. 20027177, FILED 8-19-2002.

CLASS 5—PHARMACEUTICALS

FOR LIGHT MODIFYING PHARMACEUTICAL PREPARATIONS AND PHARMACEUTICAL PREPARATIONS USED IN PHOTODYNAMIC THERAPY, NAMELY, PHOTOFRIN, 5-AMINOLEVULANIC ACID, HEMATOPORPHYRIN, VERTERORFIN, CHLORINES, PHTHALDODYANINES, PHENOTHIANZINE, BENZOPORPHYRIN DERIVATIVE MONO ACID-A, 1-PHENYLALANIN, PLENOSOL, HYALYRON ACID, BOTOLIMUM ACID, KINETIN, HYDROQUINONE, TRETINOIN, DEXTAMETHASONE, HYDROPHILIC OINTMENT, ASCORBIC ACID, ACCEROLA ACID AND COLLAGENE (U.S. CLS. 6, 18, 44, 46, 51 AND 52). FIRST USE 3-27-2007; IN COMMERCE 3-27-2007.

CLASS 10—MEDICAL APPARATUS

FOR MEDICAL STIMULATION DEVICES FOR PHOTODYNAMIC THERAPY HAVING A LASER AND/OR SEMICONDUCTOR DIODES FOR EMITTING LIGHT RADIATION TO ACTIVATE LIGHT-ACTIVABLE SUBSTANCES ABSORBED INTO TISSUE AND AN ELECTROMAGNETIC WAVE RADIATOR FOR CONCURRENTLY EMITTING ELECTROMAGNETIC RADIATION ONTO THE TISSUE, AND PARTS AND ACCESSORIES THEREFOR, FOR THE TREATMENT OF DERMATOLOGICAL DISEASES AND CONDITIONS, INFLAMMATORY DISEASES AND CONDITIONS, AND LONG TERM CHRONIC DISEASES AND CONDITIONS (U.S. CLS. 26, 39 AND 44). FIRST USE 3-27-2007; IN COMMERCE 3-27-2007.

3,313,373. MONTAGE HOTELS & RESORTS, LLC, HENDERSON, NV. SN 78-229,344. PUB. 4-19-2005, FILED 3-24-2003.



CLASS 41—EDUCATION AND ENTERTAINMENT

FOR EXERCISE TRAINING SERVICES AND THE PROVISION OF EXERCISE FACILITIES (U.S. CLS. 100, 101 AND 107). FIRST USE 4-2-2007; IN COMMERCE 4-2-2007.

CLASS 44—MEDICAL, BEAUTY AND AGRICULTURAL SERVICES

FOR HEALTH SPA SERVICES, NAMELY, COSMETIC BODY CARE SERVICES (U.S. CLS. 100 AND 101). FIRST USE 4-2-2007; IN COMMERCE 4-2-2007.

3,313,375. CATERPILLAR INC., PEORIA, IL. SN 78-246,116.
PUB. 2-24-2004, FILED 5-6-2003.

EQUIPPED TO PLAY

CLASS 25—CLOTHING

FOR CLOTHING FOR CHILDREN, NAMELY, SHIRTS, T-SHIRTS, PANTS, AND JACKETS, FOOTWEAR, HEADGEAR FOR CHILDREN, NAMELY CAPS (U.S. CLS. 22 AND 39).

FIRST USE 10-31-2006; IN COMMERCE 10-31-2006.

CLASS 28—TOYS AND SPORTING GOODS

FOR TOY VEHICLES AND ACCESSORIES THEREFOR, RIDE-ON TOY VEHICLES, BATTERY OPERATED RIDE-ON TOYS, RADIO CONTROLLED TOY VEHICLES, CONSTRUCTION TOYS, ACTION SKILL GAMES, HAND-HELD UNITS FOR ELECTRIC GAMES, JIGSAW PUZZLES, BOARD GAMES, CARD GAMES, BUILDING GAMES, KITES, ROLE-PLAYING GAMES, CONSTRUCTION SITE THEMED PLAYSETS (U.S. CLS. 22, 23, 38 AND 50).

FIRST USE 7-31-2004; IN COMMERCE 7-31-2004.

CLASS 41—EDUCATION AND ENTERTAINMENT

FOR PLAYGROUNDS COMPRISING A SIMULATED CONSTRUCTION SITE INCLUDING CHILD-SIZE RIDE-ON TRACTORS, EXCAVATORS AND LOADERS (U.S. CLS. 100, 101 AND 107).

FIRST USE 4-14-2004; IN COMMERCE 4-14-2004.

3,313,379. COSMETICS LIMITED, NASSAU, BAHAMAS. SN 78-251,219. PUB. 3-14-2006, FILED 5-17-2003.

STEINER

OWNER OF U.S. REG. NO. 644,288.

CLASS 3—COSMETICS AND CLEANING PREPARATIONS

FOR NON-MEDICATED PREPARATIONS FOR THE HAIR; COSMETICS (U.S. CLS. 1, 4, 6, 50, 51 AND 52).

FIRST USE 9-30-2006; IN COMMERCE 9-30-2006.

CLASS 41—EDUCATION AND ENTERTAINMENT

FOR EDUCATIONAL SERVICES IN THE NATURE OF HAIRDRESSING AND BEAUTY SCHOOLS; TRAINING SERVICES IN THE FIELD OF HAIRDRESSING, BEAUTY THERAPY, BEAUTY PRODUCTS, NATURAL HEALTH, MASSAGE, AROMATHERAPY (U.S. CLS. 100, 101 AND 107).

FIRST USE 1-31-2003; IN COMMERCE 1-31-2003.

3,313,396. END-OF-LIFE CHOICES, DENVER, CO. SN 78-283,966. PUB. 12-12-2006, FILED 8-6-2003.

END-OF-LIFE CHOICES

NO CLAIM IS MADE TO THE EXCLUSIVE RIGHT TO USE "END OF LIFE", APART FROM THE MARK AS SHOWN.

CLASS 35—ADVERTISING AND BUSINESS

FOR NONPROFIT ASSOCIATION OF PEOPLE WHO SUPPORT OPTIONS AND DIGNITY FOR THE TERMINALLY ILL; PROMOTING PUBLIC AWARENESS ABOUT ADVANCE HEALTH CARE PLANNING, EMERGENCY CARE, NURSING HOME PLACEMENT, END-OF-LIFE PLANNING, AND THE DRAFTING OF ADVANCE HEALTH CARE DIRECTIVES, LIVING WILLS, AND HEALTH CARE POWERS OF ATTORNEY (U.S. CLS. 100, 101 AND 102).

FIRST USE 7-9-2003; IN COMMERCE 7-9-2003.

CLASS 42—SCIENTIFIC AND COMPUTER SERVICES

FOR DRAFTING OF ADVANCE HEALTH CARE DIRECTIVES, LIVING WILLS, AND HEALTH CARE POWERS OF ATTORNEY (U.S. CLS. 100 AND 101).

FIRST USE 7-9-2003; IN COMMERCE 7-9-2003.

3,313,406. HARRIS CORPORATION, MELBOURNE, FL. SN 78-321,722. PUB. 7-12-2005, FILED 10-31-2003.

ASSURED COMMUNICATIONS

NO CLAIM IS MADE TO THE EXCLUSIVE RIGHT TO USE "COMMUNICATIONS", APART FROM THE MARK AS SHOWN.

CLASS 9—ELECTRICAL AND SCIENTIFIC APPARATUS

FOR RADIO AND TELEVISION TRANSMISSION SYSTEMS COMPRISING TRANSMITTERS, EXCITERS, ANTENNAS, MICROPHONES, SPEAKERS, MONITORS, SIGNAL MIXERS, AUDIO AND VIDEO SIGNAL ENCODERS AND DECODERS AND EDITING EQUIPMENT, NAMELY, SIGNAL PROCESSORS; BROADCAST STUDIO AUTOMATION SOFTWARE; BROADCAST STUDIO CONSOLES; TRANSMITTERS, RECEIVERS, REPEATERS AND ANTENNAS FOR SATELLITE COMMUNICATIONS; COMPUTER OPERATED NETWORK SYSTEMS COMPRISING COMPUTER HARDWARE AND SOFTWARE FOR TRANSMITTING DATA BETWEEN COMPUTERS CONNECTED IN A NETWORK AND FOR MANAGING THE COMPUTERS AND THE TRANSMISSION OF THE DATA ON SAID NETWORK; GLOBAL POSITIONING EQUIPMENT COMPRISING DATA PROCESSORS AND DISPLAYS, COMPUTERS AND COMPUTER SOFTWARE FOR CONVERTING IMAGES INTO DATA, AND FOR ANALYZING, DISPLAYING AND PRINTING THE DATA IN THE FIELD OF TWO AND THREE DIMENSIONAL IMAGE EXTRACTION, MANIPULATION, DISPLAY, AND GEOGRAPHIC REGISTRATION; WIRELESS LOCAL AREA NETWORK TRANSMITTERS AND RECEIVERS; DATA ENCRYPTION HARDWARE AND SOFTWARE; COMPUTER SOFTWARE FOR TELECOMMUNICATIONS NETWORK MANAGEMENT AND OPERATIONAL SYSTEMS SUPPORT; RADIO FREQUENCY AND MICROWAVE COMMUNICATIONS TRANSMITTERS, RECEIVERS, TRANSCEIVERS AND ANTENNAS (U.S. CLS. 21, 23, 26, 36 AND 38).

FIRST USE 2-18-2005; IN COMMERCE 2-18-2005.

CLASS 37—CONSTRUCTION AND REPAIR

FOR TELECOMMUNICATIONS SYSTEM MAINTENANCE AND REPAIR SERVICES, NAMELY MAINTENANCE AND REPAIR OF RADIO, TELEVISION AND DIGITAL COMMUNICATIONS EQUIPMENT FOR OTHERS (U.S. CLS. 100, 103 AND 106).

FIRST USE 12-31-2003; IN COMMERCE 12-31-2003.

CLASS 42—SCIENTIFIC AND COMPUTER SERVICES

FOR TELECOMMUNICATIONS SYSTEM DESIGN SERVICES, NAMELY, DESIGN OF RADIO, TELEVISION AND DIGITAL COMMUNICATIONS EQUIPMENT FOR OTHERS; DESIGN AND INTEGRATION OF COMPUTER SYSTEMS AND NETWORKS FOR OTHERS; DESIGN AND INTEGRATION OF COMMUNICATION SYSTEMS AND DISPLAY SYSTEMS FOR OTHERS; DESIGN OF BROADCAST STUDIOS FOR OTHERS (U.S. CLS. 100 AND 101).

FIRST USE 1-31-2005; IN COMMERCE 1-31-2005.

3,313,414. AMP'D MOBILE, INC., LOS ANGELES, CA. SN 78-348,502. PUB. 5-10-2005, FILED 1-6-2004.

AMP'D LIVE

THE MARK CONSISTS OF STANDARD CHARACTERS WITHOUT CLAIM TO ANY PARTICULAR FONT, STYLE, SIZE, OR COLOR.

CLASS 9—ELECTRICAL AND SCIENTIFIC APPARATUS

FOR DOWNLOADABLE RING TONES, VIDEO CONTENT AND AUDIO CONTENT, IMAGES, GRAPHICS AND MUSIC VIA THE INTERNET, WIRED AND WIRELESS NETWORKS FOR USE IN DOWNLOADING TO WIRELESS AND HANDHELD DEVICES (U.S. CLS. 21, 23, 26, 36 AND 38).

FIRST USE 12-15-2005; IN COMMERCE 12-15-2005.

CLASS 38—COMMUNICATION

FOR COMMUNICATION SERVICES, NAMELY, TRANSMISSION OF VOICE, DATA, IMAGES, GRAPHICS, VIDEO CONTENT AND AUDIO CONTENT VIA THE INTERNET, WIRED AND WIRELESS NETWORKS TO WIRELESS AND HANDHELD DEVICES (U.S. CLS. 100, 101 AND 104).

FIRST USE 12-15-2005; IN COMMERCE 12-15-2005.

3,313,432. RENHARD, DJI, SEATTLE, WA. SN 78-379,426. PUB. 3-1-2005, FILED 3-5-2004.

ROSERED REGALIA

THE MARK CONSISTS OF STANDARD CHARACTERS WITHOUT CLAIM TO ANY PARTICULAR FONT, STYLE, SIZE, OR COLOR.

CLASS 25—CLOTHING

FOR WOMEN'S CLOTHING, NAMELY, JACKETS, RAINWEAR (U.S. CLS. 22 AND 39).

FIRST USE 12-23-2005; IN COMMERCE 5-20-2006.

CLASS 35—ADVERTISING AND BUSINESS

FOR COMPUTERIZED ON-LINE RETAIL STORE FEATURING WOMEN'S CLOTHING, NAMELY, JACKETS, RAINWEAR (U.S. CLS. 100, 101 AND 102).

FIRST USE 11-30-2004; IN COMMERCE 11-30-2004.

3,313,444. B.A.S.S. (IP), LLC, BRISTOL, CT. SN 78-402,658. PUB. 9-13-2005, FILED 4-15-2004.

BASSMASTER CLASSIC

THE MARK CONSISTS OF STANDARD CHARACTERS WITHOUT CLAIM TO ANY PARTICULAR FONT, STYLE, SIZE, OR COLOR.

OWNER OF U.S. REG. NOS. 1,050,964, 1,986,282, AND OTHERS.

CLASS 25—CLOTHING

FOR T-SHIRTS, SWEATSHIRTS, HOODED SWEATSHIRTS, FLEECE VESTS AND COATS, NYLON PULL-OVER JACKETS, ZIP-UP JACKETS, PARKAS, POLO SHIRTS, BUTTON-UP DRESS SHIRTS, VESTS, TANK TOPS, CAPS, HATS, VISORS, SUN VISORS (U.S. CLS. 22 AND 39).

FIRST USE 0-0-1973; IN COMMERCE 0-0-1973.

CLASS 26—FANCY GOODS

FOR CLOTH PATCHES FOR CLOTHING, EMBROIDERED PATCHES FOR CLOTHING, ORNAMENTAL CLOTH PATCHES (U.S. CLS. 37, 39, 40, 42 AND 50).

FIRST USE 0-0-1973; IN COMMERCE 0-0-1973.

3,313,455. NADICENT TECHNOLOGIES LLC, GLASTONBURY, CT. SN 78-429,063. PUB. 7-26-2005, FILED 6-2-2004.



OWNER OF U.S. REG. NO. 3,217,790.

NO CLAIM IS MADE TO THE EXCLUSIVE RIGHT TO USE "TECHNOLOGIES" AND "BUSINESS", APART FROM THE MARK AS SHOWN.

THE MARK CONSISTS IN PART OF A FANCIFUL REPRESENTATION OF A RIVER THAT FORMS THE LETTER "N".

CLASS 35—ADVERTISING AND BUSINESS

FOR ELECTRONIC RETAILING VIA THE INTERNET, WHOLESALE DISTRIBUTORSHIP SERVICES IN THE FIELDS OF ELECTRICAL EQUIPMENT, TESTING AND MEASURING EQUIPMENT, COMMUNICATION AND DATA PRODUCTS; DISTRIBUTORSHIP SERVICES IN THE FIELD OF COMPUTERS, COMPUTER PERIPHERALS, COMPUTER COMPONENTS, COMPUTER MONITORS, SOFTWARE, COMPUTER ACCESSORIES, COMPUTER SUPPLIES, NOTEBOOK COMPUTERS, CD ROM DRIVES, PRINTERS, DISK DRIVES, DISK CONTROLLER BOARDS, DATA AND PRINTER CARTRIDGES, DISKETTES, IMAGING EQUIPMENT, JOYSTICKS, KEYBOARDS, MEMORY, MODEMS, MOTHERBOARDS, COMPUTER MOUSE PRODUCTS, MULTIMEDIA EQUIPMENT, NETWORK EQUIPMENT, OPTICAL DRIVES, OVERHEAD PROJECTORS, PC CARDS, POWER PROTECTION EQUIPMENT, PRINTER ACCESSORIES, RECORDABLE CDS, REMOVABLE STORAGE EQUIPMENT, SPEAKERS, TAPE DRIVES, TELEPHONE EQUIPMENT, VIDEO CARDS, VIDEO CONFERENCING EQUIPMENT AND CALCULATORS; SALES CHANNEL AND BUSINESS DEVELOPMENT CONSULTING SERVICES (U.S. CLS. 100, 101 AND 102).
FIRST USE 11-10-2003; IN COMMERCE 10-29-2004.

CLASS 37—CONSTRUCTION AND REPAIR

FOR REPAIR AND INSTALLATION OF SCIENTIFIC, ELECTRONIC, TEST, SIGNALING, MEASUREMENT, BIOLOGICAL AND CHEMICAL ANALYTICAL, OPTICAL, AND TELECOMMUNICATION EQUIPMENT; REPAIR AND INSTALLATION OF COMPUTER HARDWARE (U.S. CLS. 100, 103 AND 106).
FIRST USE 11-10-2003; IN COMMERCE 8-27-2004.

CLASS 42—SCIENTIFIC AND COMPUTER SERVICES

FOR ENGINEERING CONSULTING, CALIBRATION, CONFIGURATION AND INTEGRATION SERVICES FOR TELECOMMUNICATIONS, COMPUTERS SYSTEMS AND DATA NETWORKING (U.S. CLS. 100 AND 101).
FIRST USE 11-10-2003; IN COMMERCE 8-27-2004.

3,313,467. BIOTAGE AB, UPPSALA, SWEDEN. SN 78-444,962. PUB. 7-25-2006, FILED 7-1-2004.

EVOLUTE

THE MARK CONSISTS OF STANDARD CHARACTERS WITHOUT CLAIM TO ANY PARTICULAR FONT, STYLE, SIZE, OR COLOR.

CLASS 1—CHEMICALS

FOR CHEMICALS FOR SEPARATION AND PURIFICATION OF TRACE CHEMICAL SPECIES, ALL BEING SOLID PHASE AND ALL FOR USE IN INDUSTRY, SCIENCE, PHOTOGRAPHY, AGRICULTURE, HORTICULTURE AND FORESTRY (U.S. CLS. 1, 5, 6, 10, 26 AND 46).
FIRST USE 11-30-2004; IN COMMERCE 11-30-2004.

CLASS 9—ELECTRICAL AND SCIENTIFIC APPARATUS

FOR TUBES, CONTAINERS, RESERVOIRS AND COLUMNS FOR SCIENTIFIC USE (U.S. CLS. 21, 23, 26, 36 AND 38).
FIRST USE 11-30-2004; IN COMMERCE 11-30-2004.

3,313,470. IOVATION INC., PORTLAND, OR. SN 78-449,912. PUB. 6-7-2005, FILED 7-13-2004.

IOVATION

THE MARK CONSISTS OF STANDARD CHARACTERS WITHOUT CLAIM TO ANY PARTICULAR FONT, STYLE, SIZE, OR COLOR.

CLASS 9—ELECTRICAL AND SCIENTIFIC APPARATUS

FOR FRAUD DETECTION SOFTWARE (U.S. CLS. 21, 23, 26, 36 AND 38).
FIRST USE 6-1-2004; IN COMMERCE 6-1-2004.

CLASS 42—SCIENTIFIC AND COMPUTER SERVICES

FOR COMPUTER SERVICES, NAMELY ACTING AS AN APPLICATION SERVICE PROVIDER BY HOSTING COMPUTER SOFTWARE APPLICATIONS FOR FRAUD DETECTION; COMPUTER SOFTWARE DEVELOPMENT; AND INSTALLATION AND MAINTENANCE OF FRAUD DETECTION SOFTWARE (U.S. CLS. 100 AND 101).
FIRST USE 6-1-2004; IN COMMERCE 6-1-2004.

3,313,502. RSC EQUIPMENT RENTAL, INC., SCOTTSDALE, AZ. SN 78-492,574. PUB. 5-16-2006, FILED 9-30-2004.

RSC EQUIPMENT RENTAL

THE MARK CONSISTS OF STANDARD CHARACTERS WITHOUT CLAIM TO ANY PARTICULAR FONT, STYLE, SIZE, OR COLOR.

OWNER OF U.S. REG. NOS. 2,028,379 AND 2,264,049.
NO CLAIM IS MADE TO THE EXCLUSIVE RIGHT TO USE "EQUIPMENT RENTAL", APART FROM THE MARK AS SHOWN.

CLASS 37—CONSTRUCTION AND REPAIR

FOR RENTAL AND LEASING SERVICES IN CONNECTION WITH EQUIPMENT AND TOOLS USED BY CONTRACTORS, INDUSTRIAL AND PETROLEUM FACILITY OWNERS AND OTHERS IN THE FIELDS OF CONSTRUCTION, INDUSTRIAL FACILITY OPERATION, PETROLEUM EXPLORATION, PETROLEUM PRODUCTS AND PETROLEUM REFINING, NAMELY, BACKHOES, DOZERS, EXCAVATORS, SKID-STEER LOADERS, SWEEPERS, TRACTORS, TRENCHERS, WHEEL LOADERS; AERIAL WORK PLATFORMS, NAMELY, LIFTS; AIR TOOLS, NAMELY, SAWS, HAMMERS, IMPACT WRENCHES, RIVET BUSTERS, ROCK DRILLS, AND SCABBLERS, NAMELY, CONCRETE BREAKERS; AIR COMPRESSORS; COMPACTION EQUIPMENT, NAMELY, PLATE COMPACTORS, RAMMERS, RIDE-ON ROLLERS, AND WALK-BEHIND ROLLERS; CONCRETE AND MASONRY EQUIPMENT, NAMELY, MIXERS, SAWS, BUCKETS, BUGGIES, VIBRATORS, GRINDERS, CONCRETE WORKING HAND TOOLS, TROWELS AND WHEELBARROWS; DEMOLITION EQUIPMENT, NAMELY, HYDRAULIC BREAKERS, BREAKER AND CHIPPING HAMMERS, AND CUT-OFF SAWS; ELECTRIC EQUIPMENT, NAMELY, DRILLS, DEMOLITION AND ROTARY HAMMERS, FLOOR, CEILING AND ANGLE GRINDERS, SANDERS, SAWS, LIGHTING EQUIPMENT, NAMELY, LIGHTS, LIGHT STANDS AND LIGHT TOWERS; WATER PUMPS; WELDERS; BRUSH CHIPPERS; FANS; BLOWERS; HYDROSTATIC TEST PUMPS; INDUSTRIAL VACUUM CLEANERS; LADDERS; POSTHOLE DIGGERS; PRESSURE WASHERS; RUG AND FLOOR EQUIPMENT; SCAFFOLDING; SEWER SNAKES; STUMP GRINDERS; TRANSITS; LEVELS; WET AND DRY VACUUM CLEANERS (U.S. CLS. 100, 103 AND 106).

FIRST USE 1-31-2004; IN COMMERCE 1-31-2004.

CLASS 39—TRANSPORTATION AND STORAGE

FOR RENTAL OF FORKLIFTS, MATERIAL HANDLING, NAMELY, ELECTRIC AND HYDRAULIC PALLET JACKS, CHAIN COME-A-LONGS, CHAIN HOISTS, MANUAL AND HYDRAULIC JACKS, AND MATERIAL LIFTS; CARRYDECK CRANES; BOOM TRUCKS, DUMP TRUCKS, WATER TRUCKS, TRAILERS AND UTILITY VEHICLES (U.S. CLS. 100 AND 105).

FIRST USE 1-31-2004; IN COMMERCE 1-31-2004.

CLASS 40—MATERIAL TREATMENT

FOR RENTAL OF PORTABLE AND TOWABLE GENERATORS, AND HEATERS (U.S. CLS. 100, 103 AND 106).

FIRST USE 1-31-2004; IN COMMERCE 1-31-2004.

CLASS 44—MEDICAL, BEAUTY AND AGRICULTURAL SERVICES

FOR RENTAL OF LAWN AND GARDEN EQUIPMENT, NAMELY, LAWNMOWERS, GRASS CUTTERS, LEAF BLOWERS AND HEDGE TRIMMERS (U.S. CLS. 100 AND 101).

FIRST USE 1-31-2004; IN COMMERCE 1-31-2004.

3,313,507. WISHES & MORE, FRIDLEY, MN. SN 78-502,233. PUB. 7-11-2006, FILED 10-19-2004.

WISHES & MORE

THE MARK CONSISTS OF STANDARD CHARACTERS

WITHOUT CLAIM TO ANY PARTICULAR FONT, STYLE, SIZE, OR COLOR.

CLASS 36—INSURANCE AND FINANCIAL

FOR CHARITABLE FUNDRAISING SERVICES; PROVIDING EDUCATIONAL SCHOLARSHIPS; DONATING MONEY TO PROVIDE FOR THE EXPENSES INCURRED FOR MEMORIALS AND FUNERAL EXPENSES (U.S. CLS. 100, 101 AND 102).

FIRST USE 12-6-2004; IN COMMERCE 12-6-2004.

CLASS 45—PERSONAL AND LEGAL SERVICES

FOR CHARITABLE SERVICES, NAMELY GRANTING WISHES OF CHILDREN FIGHTING A TERMINAL OR LIFE-THREATENING CONDITION (U.S. CLS. 100 AND 101).

FIRST USE 12-6-2004; IN COMMERCE 12-6-2004.

3,313,515. EDUCAP INC., MCLEAN, VA. SN 78-509,269. PUB. 9-26-2006, FILED 11-1-2004.

LIVE TO LEARN

THE MARK CONSISTS OF STANDARD CHARACTERS WITHOUT CLAIM TO ANY PARTICULAR FONT, STYLE, SIZE, OR COLOR.

CLASS 36—INSURANCE AND FINANCIAL

FOR EDUCATIONAL LOAN SERVICES; FINANCING OF GOODS AND SERVICES RELATED TO EDUCATION; RESEARCH IN THE AREA OF FINANCIAL RESOURCES FOR KINDERGARTEN THROUGH GRADE 12, COLLEGE, UNIVERSITY AND ADULT EDUCATION; COLLEGE SAVINGS PLANS; PROVIDING SCHOLARSHIPS FOR EDUCATION, MANAGEMENT OF CORPORATE FINANCIAL RESOURCES FOR USE IN EDUCATION, TRAINING AND RECRUITMENT; PROVIDING INFORMATION IN THE FIELD OF FINANCIAL SCHOLARSHIPS AND FELLOWSHIPS PROGRAMS, NAMELY ASSISTING INDIVIDUALS VIA A GLOBAL COMPUTER NETWORK TO RESEARCH AVAILABLE FINANCIAL SCHOLARSHIPS AND FELLOWSHIP PROGRAMS TO DETERMINE THE REQUIREMENTS TO QUALIFY AND APPLY (U.S. CLS. 100, 101 AND 102).

FIRST USE 3-31-2005; IN COMMERCE 3-31-2005.

CLASS 41—EDUCATION AND ENTERTAINMENT

FOR PROVIDING INFORMATION IN THE FIELD OF SCHOLAR AND ACADEMIC HONORS PROGRAMS, NAMELY, ASSISTING INDIVIDUALS VIA A GLOBAL COMPUTER NETWORK TO RESEARCH AVAILABLE SCHOLAR AND ACADEMIC HONORS PROGRAMS TO DETERMINE THE REQUIREMENTS TO QUALIFY AND APPLY (U.S. CLS. 100, 101 AND 107).

FIRST USE 3-31-2005; IN COMMERCE 3-31-2005.

3,313,517. QUINTILES TRANSNATIONAL CORP., DURHAM, NC. SN 78-510,810. PUB. 2-21-2006, FILED 11-3-2004.

SCEPTER

THE MARK CONSISTS OF STANDARD CHARACTERS WITHOUT CLAIM TO ANY PARTICULAR FONT, STYLE, SIZE, OR COLOR.

CLASS 41—EDUCATION AND ENTERTAINMENT

FOR PROVIDING MEDICAL EDUCATION SERVICES TO HEALTH CARE PROFESSIONALS, NAMELY, ARRANGING AND CONDUCTING NATIONAL SYMPOSIA, SYMPOSIA WITH PANELS OF MEDICAL SPEAKERS, TELECONFERENCES, CONFERENCES, MEETINGS, SEMINARS, CONTINUING EDUCATION COURSES AND WORKSHOPS IN THE FIELD OF HEALTH CARE, AND DISTRIBUTING COURSE MATERIALS IN CONNECTION THEREWITH; DISSEMINATION OF EDUCATIONAL MATERIALS IN THE NATURE OF THE REPORTS OF PROCEEDINGS OF MEDICAL EDUCATION PROGRAMS; TRAINING SERVICES IN THE FIELD OF CLINICAL MEDICINE IN ALL THERAPEUTIC AREAS FOR FACULTY FOR PARTICIPATION IN MEDICAL EDUCATION SERVICES (U.S. CLS. 100, 101 AND 107).

FIRST USE 5-0-2005; IN COMMERCE 5-0-2005.

CLASS 44—MEDICAL, BEAUTY AND AGRICULTURAL SERVICES

FOR PROVIDING MEDICAL INFORMATION IN THE FIELDS OF HEALTH CARE, PUBLIC HEALTH, PHARMACEUTICALS, PHARMACOGENOMICS BY ELECTRONIC AND NON-ELECTRONIC MEANS (U.S. CLS. 100 AND 101).

FIRST USE 5-0-2005; IN COMMERCE 5-0-2005.

3,313,522. VERISMA SYSTEMS, INC., PUEBLO, CO. SN 78-518,906. PUB. 1-16-2007, FILED 11-17-2004.

VERISMA

THE MARK CONSISTS OF STANDARD CHARACTERS WITHOUT CLAIM TO ANY PARTICULAR FONT, STYLE, SIZE, OR COLOR.

CLASS 9—ELECTRICAL AND SCIENTIFIC APPARATUS

FOR COMPUTER SOFTWARE FOR USE IN COMPLYING WITH HEALTHCARE AND PRIVACY LAWS, REGULATIONS, AND GUIDELINES; COMPUTER SOFTWARE FOR USE IN COMPLYING WITH REGULATORY REQUIREMENTS IN THE FIELDS OF HEALTHCARE AND CORPORATE COMPLIANCE; COMPUTER SOFTWARE FOR USE IN PROCESSING AND MANAGING THE RELEASE OF HEALTHCARE AND MEDICAL INFORMATION; COMPUTER SOFTWARE FOR USE IN PROCESSING AND MANAGING THE RELEASE OF HEALTHCARE, MEDICAL AND CORPORATE INFORMATION IN COMPLIANCE WITH LAWS, REGULATIONS, AND GUIDELINES; COMPUTER SOFTWARE FOR THE COLLECTION, EDITING, SEARCHING, ORGANIZING, MODIFYING, BOOK MARKING, TRANSMISSION, STORAGE AND SHARING OF MEDICAL AND HEALTHCARE DATA AND INFORMATION (U.S. CLS. 21, 23, 26, 36 AND 38).

FIRST USE 7-31-2005; IN COMMERCE 7-31-2005.

CLASS 35—ADVERTISING AND BUSINESS

FOR MANAGED CARE SERVICES, NAMELY, ELECTRONIC PROCESSING OF HEALTH CARE INFORMATION; INTERACTIVE RECORD KEEPING SERVICES FOR USE IN RISK MANAGEMENT AND REGULATORY COMPLIANCE BY PROFESSIONALS IN THE MEDICAL FIELD; LICENSING OF COMPUTER SOFTWARE; BILLING AND ACCOUNTING SERVICES; DATA PROCESSING SERVICES; COLLECTION, PREPARATION, COMPOSITION, STORAGE, PROCESSING, ACQUISITION AND PROVISION OF BUSINESS INFORMATION, DATA, STATISTICS AND INDICES (U.S. CLS. 100, 101 AND 102).

FIRST USE 7-31-2005; IN COMMERCE 7-31-2005.

CLASS 36—INSURANCE AND FINANCIAL

FOR ELECTRONIC PAYMENT DATA IN THE FIELD OF HEALTHCARE (U.S. CLS. 100, 101 AND 102).

FIRST USE 7-31-2005; IN COMMERCE 7-31-2005.

CLASS 39—TRANSPORTATION AND STORAGE

FOR STORAGE OF ELECTRONIC MEDIA, NAMELY, IMAGES AND TEXT DATA; STORAGE SERVICES FOR ARCHIVING DATABASES, IMAGES AND OTHER ELECTRONIC MEDIA AND DATA (U.S. CLS. 100 AND 105).

FIRST USE 7-31-2005; IN COMMERCE 7-31-2005.

CLASS 42—SCIENTIFIC AND COMPUTER SERVICES

FOR PROVIDING ONLINE NON-DOWNLOADABLE COMPUTER SOFTWARE FOR USE IN COMPLYING WITH HEALTHCARE AND PRIVACY LAWS, REGULATIONS, AND GUIDELINES; PROVIDING ONLINE NON-DOWNLOADABLE COMPUTER SOFTWARE FOR USE IN COMPLYING WITH REGULATORY REQUIREMENTS IN THE FIELDS OF HEALTHCARE AND CORPORATE COMPLIANCE; PROVIDING ONLINE NON-DOWNLOADABLE COMPUTER SOFTWARE FOR USE IN PROCESSING AND MANAGING THE RELEASE OF HEALTHCARE AND MEDICAL INFORMATION; NON-DOWNLOADABLE COMPUTER SOFTWARE FOR USE IN PROCESSING AND MANAGING THE RELEASE OF HEALTHCARE, MEDICAL AND CORPORATE INFORMATION IN COMPLIANCE WITH LAWS, REGULATIONS, AND GUIDELINES; CONSULTING SERVICES IN THE FIELD OF DESIGN, SELECTION, IMPLEMENTATION AND USE OF COMPUTER HARDWARE AND SOFTWARE SYSTEMS FOR OTHERS; CONSULTING SERVICES IN THE FIELDS OF HEALTHCARE AND PRIVACY LAWS, REGULATIONS, AND REQUIREMENTS; LICENSING OF INTELLECTUAL PROPERTY (U.S. CLS. 100 AND 101).

FIRST USE 7-31-2005; IN COMMERCE 7-31-2005.

CLASS 44—MEDICAL, BEAUTY AND AGRICULTURAL SERVICES

FOR MAINTAINING FILES AND RECORDS CONCERNING THE MEDICAL CONDITION OF INDIVIDUALS AND THE PAYMENT FOR HEALTHCARE; PROVIDING MEDICAL AND HEALTHCARE INFORMATION CONCERNING INDIVIDUALS VIA ELECTRONIC AND OPTICAL COMMUNICATIONS NETWORKS; CONSULTING SERVICES IN THE FIELD OF HEALTHCARE (U.S. CLS. 100 AND 101).

FIRST USE 7-31-2005; IN COMMERCE 7-31-2005.

3,313,533. STUART LEVINE & ASSOCIATES, LLC, JERICHO, NY. SN 78-533,584. PUB. 9-6-2005, FILED 12-16-2004.

CUT TO THE CHASE

3,313,528. THERAGEAR INTERNATIONAL LTD., MISSION, BRITISH COLUMBIA, CANADA. SN 78-530,164. PUB. 4-4-2006, FILED 12-9-2004.

THE MARK CONSISTS OF STANDARD CHARACTERS WITHOUT CLAIM TO ANY PARTICULAR FONT, STYLE, SIZE, OR COLOR.

CLASS 16—PAPER GOODS AND PRINTED MATTER

FOR BOOKS, PAMPHLETS AND WORKBOOKS IN THE FIELD OF LEADERSHIP TRAINING (U.S. CLS. 2, 5, 22, 23, 29, 37, 38 AND 50).

FIRST USE 11-6-2006; IN COMMERCE 2-22-2007.

THERAGEAR**CLASS 41—EDUCATION AND ENTERTAINMENT**

FOR EDUCATION AND TRAINING, NAMELY CLASSES AND WORKSHOPS IN THE FIELD OF LEADERSHIP TRAINING (U.S. CLS. 100, 101 AND 107).

FIRST USE 11-6-2006; IN COMMERCE 2-22-2007.

THE MARK CONSISTS OF STANDARD CHARACTERS WITHOUT CLAIM TO ANY PARTICULAR FONT, STYLE, SIZE, OR COLOR.

CLASS 10—MEDICAL APPARATUS

FOR MEDICAL PATIENT TREATMENT CHAIRS, EXERCISE MACHINES FOR THERAPEUTIC PURPOSES, NAMELY, GRAVITY EXERCISE MACHINES FOR THERAPEUTIC TREATMENT OF BACKS, CHEMICALLY ACTIVATED HOT AND COLD GEL PACKS FOR MEDICAL PURPOSES, DEFORMABLE PUTTY-LIKE MATERIAL FOR USE IN THERAPEUTIC EXERCISE OF THE FINGERS, HANDS, WRISTS AND FOREARMS, AND ORTHOPEDIC SUPPORTS (U.S. CLS. 26, 39 AND 44).

FIRST USE 6-30-2005; IN COMMERCE 6-30-2005.

CLASS 20—FURNITURE AND ARTICLES NOT OTHERWISE CLASSIFIED

FOR ERGONOMIC OFFICE CHAIRS, CHAIR PADS, NAMELY, ERGONOMIC SITTING PADS, BODY SUPPORT PILLOWS, AND NECK SUPPORT PILLOWS (U.S. CLS. 2, 13, 22, 25, 32 AND 50).

FIRST USE 6-30-2005; IN COMMERCE 6-30-2005.

CLASS 28—TOYS AND SPORTING GOODS

FOR EXERCISE EQUIPMENT, NAMELY, FREE WEIGHTS, DUMBBELLS, BALANCE BOARDS, MEDICINE BALLS, RESISTANCE BALLS, EXERCISE PLATFORMS, CORE TRAINING BOARDS, EXERCISE MATS, RESISTANCE BANDS, RESISTANCE TUBES, AND EXERCISE PULLEYS (U.S. CLS. 22, 23, 38 AND 50).

FIRST USE 4-30-2005; IN COMMERCE 4-30-2005.

3,313,558. SCHOEPP, ALEXANDRA, RICHMOND, VA. SN 78-557,118. PUB. 8-1-2006, FILED 1-31-2005.



THE COLOR(S) DARK BLUE, LIGHT BLUE, AND YELLOW IS/ARE CLAIMED AS A FEATURE OF THE MARK.

THE COLOR DARK BLUE APPEARS AS OUTLINE FOR THE COLORED LETTER "I" AND IN THE CORE OF THE COLORED LETTER "I"; THE COLOR LIGHT BLUE APPEARS ON THE LEFT AND RIGHT SIDES OF THE COLORED LETTER "I"; THE COLOR YELLOW APPEARS IN THE CROWN DESIGN AND THE LETTERS "Y" AND "S"

THE MARK CONSISTS OF A STYLIZED LETTER Y AND LETTER S LOCATED WITHIN THE BODY OF A LOWER-CASE LETTER I.

CLASS 25—CLOTHING

FOR CLOTHING, NAMELY SHIRTS, SWEATSHIRTS, SWEAT JACKETS, SWEATPANTS, SWEATBANDS, SPORTS COATS, SPORTS JERSEYS, SPORTS JACKETS, TURTLENECKS, VESTS, TANK TOPS, SHORTS, LEGGINGS, JEANS, PANTS, TROUSERS, SWEATERS, BLOUSES, DRESSES, JACKETS, COATS, BLAZERS, BATHROBES, SWIMWEAR, NECKTIES, GLOVES, MITTENS, SCARVES, SHAWLS, SOCKS, BELTS, SUSPENDERS; FOOTWEAR; HEADWEAR (U.S. CLS. 22 AND 39).
FIRST USE 10-31-2005; IN COMMERCE 10-31-2005.

CLASS 35—ADVERTISING AND BUSINESS

FOR ONLINE RETAIL STORE SERVICES FEATURING CONSUMER GOODS (U.S. CLS. 100, 101 AND 102).
FIRST USE 10-31-2005; IN COMMERCE 10-31-2005.

CLASS 45—PERSONAL AND LEGAL SERVICES

FOR PERSONAL SERVICES, NAMELY PROVIDING INFORMATION REGARDING, AND IN THE NATURE OF, ONLINE DATING, INTRODUCTION, AND SOCIAL NETWORKING SERVICES (U.S. CLS. 100 AND 101).
FIRST USE 10-31-2005; IN COMMERCE 10-31-2005.

3,313,562. HOEY, GARY P., PELHAM, NH. SN 78-561,835.
PUB. 6-6-2006, FILED 2-7-2005.

WAZOO

THE MARK CONSISTS OF STANDARD CHARACTERS WITHOUT CLAIM TO ANY PARTICULAR FONT, STYLE, SIZE, OR COLOR.

CLASS 9—ELECTRICAL AND SCIENTIFIC APPARATUS

FOR PRERECORDED AUDIOTAPES, VIDEOTAPES, AND COMPACT DISCS FEATURING MUSIC BY INDIVIDUAL ARTISTS OR GROUPS AND COMPILATIONS OF MUSIC BY A PLURALITY OF INDIVIDUAL ARTISTS OR GROUPS (U.S. CLS. 21, 23, 26, 36 AND 38).
FIRST USE 4-25-2006; IN COMMERCE 8-22-2006.

CLASS 35—ADVERTISING AND BUSINESS

FOR MUSIC LICENSING (U.S. CLS. 100, 101 AND 102).
FIRST USE 2-1-2006; IN COMMERCE 2-1-2006.

CLASS 41—EDUCATION AND ENTERTAINMENT

FOR MUSIC PRODUCTION SERVICES; PRODUCTION OF MOVIE MUSICAL SOUNDTRACKS (U.S. CLS. 100, 101 AND 107).
FIRST USE 2-1-2006; IN COMMERCE 2-1-2006.

3,313,565. HAMBERGER INDUSTRIEWERKE GMBH, STEPHANSKIRCHEN, FED REP GERMANY. SN 78-566,889.
PUB. 5-9-2006, FILED 2-14-2005.

CORKETT

THE MARK CONSISTS OF STANDARD CHARACTERS WITHOUT CLAIM TO ANY PARTICULAR FONT, STYLE, SIZE, OR COLOR.

CLASS 19—NON-METALLIC BUILDING MATERIALS

FOR BUILDING MATERIALS, NAMELY, PARQUET FLOORING MADE OF CORK (U.S. CLS. 1, 12, 33 AND 50).
FIRST USE 5-6-2002; IN COMMERCE 5-6-2002.

CLASS 27—FLOOR COVERINGS

FOR CORK FOR USE AS A FLOOR COVERING (U.S. CLS. 19, 20, 37, 42 AND 50).
FIRST USE 5-6-2002; IN COMMERCE 5-6-2002.

3,313,569. KIJJI INTERNATIONAL LIMITED, DUBLIN, IRELAND. SN 78-569,984. PUB. 6-20-2006, FILED 2-17-2005.

kijiji

THE COLOR(S) BLUE, ORANGE, RED, GREEN AND PURPLE IS/ARE CLAIMED AS A FEATURE OF THE MARK.

THE WORD KIJJI IS BLUE. THE CIRCLES ARE, FROM LEFT TO RIGHT, ORANGE, RED, BLUE, GREEN AND PURPLE.

THE FOREIGN WORDING IN THE MARK TRANSLATES INTO ENGLISH AS VILLAGE.

CLASS 35—ADVERTISING AND BUSINESS

FOR PROVIDING AN ON-LINE COMPUTER DATABASE AND ON-LINE SEARCHABLE DATABASE FEATURING CLASSIFIED LISTINGS (U.S. CLS. 100, 101 AND 102).
FIRST USE 2-28-2005; IN COMMERCE 2-28-2005.

CLASS 42—SCIENTIFIC AND COMPUTER SERVICES

FOR COMPUTER SERVICES, NAMELY, HOSTING ONLINE WEB FACILITIES FOR OTHERS FOR ORGANIZING AND CONDUCTING ONLINE MEETINGS, GATHERINGS, AND INTERACTIVE DISCUSSIONS; COMPUTER SERVICES IN THE NATURE OF PROVIDING CUSTOMIZED WEB PAGES FEATURING USER-DEFINED INFORMATION, PERSONAL PROFILES AND INFORMATION (U.S. CLS. 100 AND 101).

FIRST USE 2-28-2005; IN COMMERCE 2-28-2005.

3,313,581. MICHAEL DAVID WARD PRODUCTIONS, INC., SANTA ROSA, CA. SN 78-577,939. PUB. 2-7-2006, FILED 3-1-2005.

TENCAT

3,313,579. ANDERSEN STERILIZERS, INC., HAW RIVER, NC. SN 78-576,274. PUB. 7-25-2006, FILED 2-28-2005.

THE MARK CONSISTS OF STANDARD CHARACTERS WITHOUT CLAIM TO ANY PARTICULAR FONT, STYLE, SIZE, OR COLOR.

CLASS 16—PAPER GOODS AND PRINTED MATTER

FOR BOOKS FEATURING HUMOR AND CHILDREN'S STORIES (U.S. CLS. 2, 5, 22, 23, 29, 37, 38 AND 50).

FIRST USE 10-2-2006; IN COMMERCE 10-2-2006.

CLASS 25—CLOTHING

FOR T-SHIRTS (U.S. CLS. 22 AND 39).

FIRST USE 10-2-2006; IN COMMERCE 10-2-2006.

EOGAS 4

3,313,590. GEN PLUS LLC, ENCINO, CA. SN 78-582,554. PUB. 1-31-2006, FILED 3-8-2005.

THE MARK CONSISTS OF STANDARD CHARACTERS WITHOUT CLAIM TO ANY PARTICULAR FONT, STYLE, SIZE, OR COLOR.

OWNER OF U.S. REG. NOS. 3,012,331 AND 3,022,164.

NO CLAIM IS MADE TO THE EXCLUSIVE RIGHT TO USE "EOGAS", APART FROM THE MARK AS SHOWN.

CLASS 5—PHARMACEUTICALS

FOR STERILIZING GAS IN THE NATURE OF ETHYLENE OXIDE FOR MEDICAL, DENTAL AND VETERINARY USE (U.S. CLS. 6, 18, 44, 46, 51 AND 52).

FIRST USE 7-28-2006; IN COMMERCE 7-28-2006.

CLASS 10—MEDICAL APPARATUS

FOR MEDICAL STERILIZING APPARATUS, NAMELY, STERILIZER ENCLOSURES FOR MEDICAL, DENTAL AND VETERINARY PRODUCTS (U.S. CLS. 26, 39 AND 44).

FIRST USE 3-31-2006; IN COMMERCE 3-31-2006.

GEN PLUS

THE MARK CONSISTS OF STANDARD CHARACTERS WITHOUT CLAIM TO ANY PARTICULAR FONT, STYLE, SIZE, OR COLOR.

CLASS 9—ELECTRICAL AND SCIENTIFIC APPARATUS

FOR PRERECORDED DIGITAL VIDEO DISKS FEATURING PHYSICAL EDUCATION AND PHYSICAL FITNESS TRAINING (U.S. CLS. 21, 23, 26, 36 AND 38).

FIRST USE 11-29-2006; IN COMMERCE 1-6-2007.

CLASS 35—ADVERTISING AND BUSINESS

FOR PROVIDING ON-LINE INFORMATION IN THE FIELDS OF EMPLOYMENT, RECRUITMENT, CAREERS, PERSONAL ISSUES RELATED TO CAREERS AND WORK LIFE, JOB RESOURCES, JOB LISTINGS AND RESUMES; PROVIDING ON-LINE INTERACTIVE EMPLOYMENT COUNSELING AND RECRUITMENT SERVICES; PROVIDING ON-LINE EMPLOYMENT PLACEMENT SERVICES, NAMELY, RESUME MATCHING SERVICES VIA THE INTERNET (U.S. CLS. 100, 101 AND 102).

FIRST USE 12-1-2005; IN COMMERCE 12-1-2005.

CLASS 41—EDUCATION AND ENTERTAINMENT

FOR EDUCATIONAL SERVICES, NAMELY, CONDUCTING CLASSES, SEMINARS AND WORKSHOPS ON THE INTERNET IN THE FIELDS OF MARKETING, NAMELY, PERSONAL AND BUSINESS MARKETING, RESUME WRITING; EDUCATIONAL SERVICES, NAMELY, CONDUCTING CLASSES, SEMINARS AND WORKSHOPS ON THE INTERNET IN THE FIELD OF BUSINESS, NAMELY, LEARNING HOW TO ESTABLISH AND RUN A SMALL BUSINESS, STRATEGIES FOR FINDING EMPLOYMENT; EDUCATIONAL SERVICES, NAMELY, CONDUCTING CLASSES, SEMINARS AND WORKSHOPS ON THE INTERNET IN THE FIELD OF HEALTH, NAMELY, STAYING FIT OVER FIFTY, AND DISTRIBUTING COURSE MATERIALS IN CONNECTION WITH ALL OF THE ABOVE (U.S. CLS. 100, 101 AND 107).

FIRST USE 4-5-2007; IN COMMERCE 4-5-2007.

CLASS 45—PERSONAL AND LEGAL SERVICES

FOR DATING SERVICES VIA THE INTERNET (U.S. CLS. 100 AND 101).

FIRST USE 6-10-2005; IN COMMERCE 6-10-2005.

3,313,602. BEAUTYMASTER, INC., COMPTON, CA. SN 78-588,470. PUB. 7-25-2006, FILED 3-16-2005.

Sarah COLLECTION

THE MARK CONSISTS OF STANDARD CHARACTERS WITHOUT CLAIM TO ANY PARTICULAR FONT, STYLE, SIZE, OR COLOR.

NO CLAIM IS MADE TO THE EXCLUSIVE RIGHT TO USE "COLLECTION", APART FROM THE MARK AS SHOWN.

THE NAME "SARAH" IDENTIFIES A LIVING INDIVIDUAL WHOSE CONSENT IS OF RECORD.

CLASS 3—COSMETICS AND CLEANING PREPARATIONS

FOR COSMETICS, HAIR LOTIONS, PERFUMERY (U.S. CLS. 1, 4, 6, 50, 51 AND 52).

FIRST USE 3-31-2005; IN COMMERCE 3-31-2005.

CLASS 26—FANCY GOODS

FOR HAIR ACCESSORIES, NAMELY, HAIR CLIPS, HAIR PINS, HAIR BANDS, HAIR EXTENSIONS, HAIR RIBBONS, HAIR BRAIDS (U.S. CLS. 37, 39, 40, 42 AND 50).

FIRST USE 2-11-2005; IN COMMERCE 2-11-2005.

3,313,615. SUNRISE SENIOR LIVING, INC., MCLEAN, VA. SN 78-596,211. PUB. 6-13-2006, FILED 3-28-2005.

CONDOS FOR LIFE

THE MARK CONSISTS OF STANDARD CHARACTERS WITHOUT CLAIM TO ANY PARTICULAR FONT, STYLE, SIZE, OR COLOR.

NO CLAIM IS MADE TO THE EXCLUSIVE RIGHT TO USE "CONDOS", APART FROM THE MARK AS SHOWN.

CLASS 35—ADVERTISING AND BUSINESS

FOR MANAGEMENT AND ADMINISTRATION OF RETIREMENT, INDEPENDENT LIVING, ASSISTED LIVING, SKILLED NURSING, NURSING HOME AND LONG TERM FACILITIES FOR OTHERS (U.S. CLS. 100, 101 AND 102).

FIRST USE 7-13-2006; IN COMMERCE 7-13-2006.

CLASS 36—INSURANCE AND FINANCIAL

FOR MANAGEMENT AND LEASING OF REAL ESTATE; CONDOMINIUM MANAGEMENT AND LEASING SERVICES (U.S. CLS. 100, 101 AND 102).

FIRST USE 7-13-2006; IN COMMERCE 7-13-2006.

CLASS 43—HOTEL AND RESTAURANT SERVICES

FOR RETIREMENT HOMES; PROVIDING INDEPENDENT LIVING, ASSISTED LIVING, AND LONG TERM CARE FACILITIES AND SERVICES, NAMELY RESPITE CARE AND ELDER CARE DAY CARE SERVICES; HOME CARE AND ADULT CARE IN THE NATURE OF MEAL PREPARATION (U.S. CLS. 100 AND 101).

FIRST USE 7-13-2006; IN COMMERCE 7-13-2006.

CLASS 44—MEDICAL, BEAUTY AND AGRICULTURAL SERVICES

FOR NURSING HOMES AND SKILLED NURSING CARE (U.S. CLS. 100 AND 101).

FIRST USE 7-13-2006; IN COMMERCE 7-13-2006.

3,313,617. CVS PHARMACY, INC., WOONSOCKET, RI. SN 78-597,435. PUB. 7-25-2006, FILED 3-29-2005.

3,313,619. COLONIAL HOLDINGS, INC., NEW KENT, VA. SN 78-597,907. PUB. 8-22-2006, FILED 3-30-2005.

THE RICHEST GRAND SLAM IN SPORTS

ALL KIDS CAN

THE MARK CONSISTS OF STANDARD CHARACTERS WITHOUT CLAIM TO ANY PARTICULAR FONT, STYLE, SIZE, OR COLOR.

CLASS 35—ADVERTISING AND BUSINESS

FOR PROMOTING SPORTS COMPETITIONS IN THE FIELD OF HORSE RACING (U.S. CLS. 100, 101 AND 102). FIRST USE 4-30-2006; IN COMMERCE 4-30-2006.

CLASS 41—EDUCATION AND ENTERTAINMENT

FOR ENTERTAINMENT SERVICES, NAMELY, HORSE RACING SERVICES, AND OFFERING A SERIES OF THOROUGHBRED HORSE RACES ON A TURF SURFACE (U.S. CLS. 100, 101 AND 107). FIRST USE 4-30-2006; IN COMMERCE 4-30-2006.

THE MARK CONSISTS OF STANDARD CHARACTERS WITHOUT CLAIM TO ANY PARTICULAR FONT, STYLE, SIZE, OR COLOR.

NO CLAIM IS MADE TO THE EXCLUSIVE RIGHT TO USE "KIDS", APART FROM THE MARK AS SHOWN.

CLASS 35—ADVERTISING AND BUSINESS

FOR PROMOTING PUBLIC AWARENESS OF THE NEED FOR CHILDREN'S HEALTH AND WELLNESS AND THE ISSUES AFFECTING CHILDREN WITH DISABILITIES (U.S. CLS. 100, 101 AND 102).

FIRST USE 3-1-2006; IN COMMERCE 3-1-2006.

CLASS 36—INSURANCE AND FINANCIAL

FOR PHILANTHROPIC SERVICES CONCERNING MONETARY DONATIONS TO NON-PROFIT ORGANIZATIONS IN THE FIELD OF CHILDREN'S HEALTH AND WELLNESS AND CHILDREN WITH DISABILITIES; CHARITABLE FUND RAISING SERVICES IN THE FIELD OF CHILDREN'S HEALTH AND WELLNESS AND CHILDREN WITH DISABILITIES (U.S. CLS. 100, 101 AND 102).

FIRST USE 3-1-2006; IN COMMERCE 3-1-2006.

CLASS 41—EDUCATION AND ENTERTAINMENT

FOR EDUCATIONAL SERVICES, NAMELY, CONDUCTING WORKSHOPS AND EXHIBITS AT CONFERENCES IN THE FIELD OF CHILDREN'S HEALTH AND WELLNESS AND CHILDREN WITH DISABILITIES; PUBLICATION OF IN-STORE BROCHURES AND PUBLICATIONS, NAMELY MAGAZINES AND FLYERS, IN THE FIELD OF CHILDREN'S HEALTH AND WELLNESS AND CHILDREN WITH DISABILITIES (U.S. CLS. 100, 101 AND 107).

FIRST USE 3-1-2006; IN COMMERCE 3-1-2006.

CLASS 44—MEDICAL, BEAUTY AND AGRICULTURAL SERVICES

FOR PROVIDING ON-LINE NEWS AND INFORMATION ABOUT CHILDREN'S HEALTH AND WELLNESS AND CHILDREN WITH DISABILITIES (U.S. CLS. 100 AND 101).

FIRST USE 3-1-2006; IN COMMERCE 3-1-2006.

3,313,631. ABBA TECHNOLOGIES CORPORATION, MIAMI, FL. SN 78-607,278. PUB. 7-18-2006, FILED 4-12-2005.

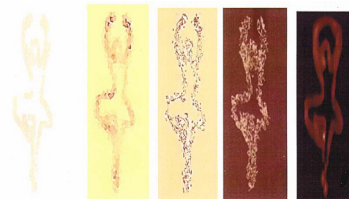

Coppelia
creamery

NO CLAIM IS MADE TO THE EXCLUSIVE RIGHT TO USE CREAMERY, APART FROM THE MARK AS SHOWN.

THE COLOR(S) WHITE, YELLOW, BROWN, GOLD AND BLACK IS/ARE CLAIMED AS A FEATURE OF THE MARK.

THE MARK IS COMPOSED OF COLORED IMAGES TOGETHER WITH THE STYLIZED WORDS COPPELIA CREAMERY. THE COLORED IMAGES ARE COMPOSED OF FIVE SIDE-BY-SIDE COLORED IMAGES OF A BALLERINA. FROM LEFT TO RIGHT, THE FIRST IMAGE HAS A WHITE BACKGROUND AND THE BALLERINA APPEARS IN LIGHT YELLOW OR GOLD COLOR; THE SECOND IMAGE INCLUDES A YELLOW BACKGROUND WITH A LIGHT BROWN IMAGE OF A BALLERINA; THE THIRD IMAGE INCLUDES A YELLOW/LIGHT BROWN BACKGROUND WITH A MEDIUM BROWN IMAGE OF A BALLERINA; THE FOURTH IMAGE INCLUDES A DARK BROWN BACKGROUND WITH AN OFF WHITE IMAGE OF A BALLERINA; THE FIFTH IMAGE INCLUDES A BLACK BACKGROUND WITH A YELLOW/ORANGE IMAGE OF BALLERINA.

CLASS 29—MEATS AND PROCESSED FOODS

FOR SOYBEAN MILK, SOY BASED FOOD BEVERAGES USED AS MILK SUBSTITUTES, AND MILK, ALL FOR CONSUMPTION ON OR OFF THE PREMISES (U.S. CL. 46).

FIRST USE 3-28-2007; IN COMMERCE 3-28-2007.

CLASS 30—STAPLE FOODS

FOR ICE CREAM, ICE MILK, FROZEN YOGURT AND FROZEN CONFECTIONS, ALL FOR CONSUMPTION ON OR OFF THE PREMISES (U.S. CL. 46).

FIRST USE 3-28-2007; IN COMMERCE 3-28-2007.

3,313,635. TC LICENSE, LTD., HUMMELSTOWN, PA. SN 78-608,589. PUB. 8-29-2006, FILED 4-14-2005.

3SIXTY

THE MARK CONSISTS OF STANDARD CHARACTERS WITHOUT CLAIM TO ANY PARTICULAR FONT, STYLE, SIZE, OR COLOR.

CLASS 9—ELECTRICAL AND SCIENTIFIC APPARATUS

FOR COMPUTER HARDWARE AND SOFTWARE FOR USE IN THE TRANSPORTATION INDUSTRY THAT ALLOWS BROKERS, SHIPPERS AND CARRIERS TO MANAGE AND TRACK FREIGHT LOAD AND TRUCK INFORMATION FROM CUSTOMER DEMAND TO POST DELIVERY AUDIT; COMPUTER SOFTWARE THAT PROVIDES ACCESS TO A FREIGHT MATCHING DATABASE FOR LOAD AND TRUCK INFORMATION, AUTOMATES THE ORDERING, TRACKING AND REPORTING OF PICK-UPS AND DELIVERIES OF GOODS, CREATING AND SENDING INVOICES, PROCESSING PAYMENTS, AND RECORDING ACCOUNTS RECEIVABLE AND ACCOUNTS PAYABLE; COMPUTER SOFTWARE AND HARDWARE THAT ALLOWS MONITORING AND MANAGING DISPATCH AND LOCATION OF TRACTORS, TRAILERS, CONTAINERS, RAILCARS, INTER MODAL CONTAINERS, AUTOMOBILES AND AIRPLANES; COMPUTER HARDWARE AND SOFTWARE FOR USE IN THE TRANSPORTATION INDUSTRY, NAMELY, FOR AUTOMATED METER READING, SECURITY MONITORING, ENVIRONMENTAL MONITORING, FACILITY MONITORING, AND POINT-OF-SALE MONITORING, AND TRACKING COMPLIANCE AND INSURANCE INFORMATION; COMPUTER SOFTWARE THAT PROVIDES INFORMATION TO THE TRANSPORTATION INDUSTRY, VIA A COMPUTER NETWORK FEATURING STATE VEHICULAR REGISTRATION AND RENEWALS, TITLE TRANSFERS, INFORMATION ENSURING THAT LIENS ON VEHICLES ARE PROPERLY RECORDED AND PERFECTED FOR THE LIEN HOLDER, INFORMATION CORRECTING IMPROPERLY TITLED VEHICLES AND LOCATING LOST TITLES, INFORMATION FOR PREPARATION, ANALYSIS, AND REPORTING OF INTERSTATE FUEL AND MILEAGE TAX RETURNS, AND INFORMATION FOR PREPARATION, ANALYSIS, AND REPORTING FOR AUDITS FROM STATE AND FEDERAL AGENCIES (U.S. CLS. 21, 23, 26, 36 AND 38).

FIRST USE 1-0-2006; IN COMMERCE 1-0-2006.

CLASS 35—ADVERTISING AND BUSINESS

FOR PROVIDING BUSINESS MANAGEMENT SERVICES AND BUSINESS INFORMATION MANAGEMENT SERVICES TO THE TRANSPORTATION INDUSTRY THAT ALLOWS BROKERS, SHIPPERS AND CARRIERS TO MANAGE AND TRACK FREIGHT LOAD AND TRUCK INFORMATION FROM CUSTOMER DEMAND TO POST DELIVERY AUDIT; PROVIDING TRANSPORTATION INDUSTRY BUSINESS INFORMATION MANAGEMENT SERVICES, NAMELY, PROVIDING INTEGRATED TRACKING AND MANAGEMENT OF COMMERCIAL TRANSACTIONS IN THE TRUCKING INDUSTRY THROUGH THE USE OF A GLOBAL COMPUTER NETWORK AND A FREIGHT MATCHING DATABASE FOR LOAD AND TRUCK INFORMATION AND COMPLIANCE AND INSURANCE INFORMATION; PROVIDING BUSINESS INFORMATION MANAGEMENT SERVICES TO THE TRANSPORTATION INDUSTRY, NAMELY, STATE VEHICULAR REGISTRATION AND RENEWALS, TITLE TRANSFER, ENSURING THAT LIENS ON VEHICLES ARE PROPERLY RECORDED AND PERFECTED FOR THE LIEN HOLDER, INFORMATION CORRECTING IMPROPERLY TITLED VEHICLES AND LOCATING LOST TITLES, PREPARATION, ANALYSIS, AND REPORTING OF INTERSTATE FUEL AND MILEAGE TAX RETURNS, AND PREPARATION, ANALYSIS, AND REPORTING FOR AUDITS FROM STATE AND FEDERAL AGENCIES (U.S. CLS. 100, 101 AND 102).

FIRST USE 1-0-2006; IN COMMERCE 1-0-2006.

CLASS 39—TRANSPORTATION AND STORAGE

FOR PROVIDING ONLINE COMPUTER DATABASES TO THE TRANSPORTATION INDUSTRY THAT ALLOW BROKERS, SHIPPERS AND CARRIERS TO MANAGE AND TRACK LOAD AND VEHICLE FROM CUSTOMER DEMAND TO POST DELIVERY AUDIT; PROVIDING ONLINE COMPUTER DATABASES, FEATURING INFORMATION TO FACILITATE THE EXCHANGE OF INFORMATION IN THE TRANSPORTATION INDUSTRY, INCLUDING INSURANCE AND COMPLIANCE INFORMATION, SCHEDULING, SHIPPING, SHIPMENT AND FREIGHT INFORMATION, ARRANGEMENT FOR SHIPMENTS AND PREPARATION OF ORDERS FOR SHIPMENT BETWEEN SHIPPERS AND CARRIERS; BROKERAGE OF FREIGHT SHIPPING AND DELIVERY SERVICES (U.S. CLS. 100 AND 105).

FIRST USE 1-0-2006; IN COMMERCE 1-0-2006.

3,313,639. ALLPAX PRODUCTS, INC., COVINGTON, LA. SN 78-610,064. PUB. 1-17-2006, FILED 4-15-2005.

ABRS FLEX

THE MARK CONSISTS OF STANDARD CHARACTERS WITHOUT CLAIM TO ANY PARTICULAR FONT, STYLE, SIZE, OR COLOR.

NO CLAIM IS MADE TO THE EXCLUSIVE RIGHT TO USE "ABRS", APART FROM THE MARK AS SHOWN.

CLASS 7—MACHINERY

FOR INDUSTRIAL AUTOMATED ROBOTICS FOR CONTROL, LOADING, AND UNLOADING RETORTS, STERILIZERS AND AUTOCLAVES, AND BASKETS, SHUTTLES AND CONVEYORS THEREFORE; AUTOMATED CONTAINER AND PACKAGING LOADING AND UNLOADING MACHINES; AUTOMATED HANDLING AND LOADING SYSTEMS, EQUIPMENT AND CONTROLS, NAMELY, INDUSTRIAL ROBOTS FOR USE IN LOADING AND UNLOADING STERILIZERS AND AUTOCLAVES NOT FOR MEDICAL USE; CONTAINER AND PACKAGE LOADING AND UNLOADING MACHINES COMPRISED OF INDEXERS, TRANSPORT AND LOADING SHUTTLES, BASKET TIPPERS, AND CONVEYORS THEREFORE; LOADING MACHINERY FOR STERILIZERS, AUTOCLAVES AND BASKETS; AUTOMATED CAN, POUCH AND CONTAINER LOADING AND UNLOADING MACHINERY AND INDUSTRIAL DRONES FOR LOADING AND UNLOADING MATERIALS, MATERIAL HANDLING SHUTTLES, CARTS, PALLETS, AND BASKETS THEREFORE, AUTOMATED CASE PACKING MACHINERY FOR BOTTLES, JARS, CANS, POUCHES, VIALS, BOXES AND OTHER TYPES OF CONTAINERS CONTAINING PHARMACEUTICALS, FOODSTUFFS, AND PERISHABLES (U.S. CLS. 13, 19, 21, 23, 31, 34 AND 35).

FIRST USE 7-1-2005; IN COMMERCE 7-1-2005.

CLASS 11—ENVIRONMENTAL CONTROL APPARATUS

FOR NON-MEDICAL AUTOCLAVES, RETORTS AND STERILIZERS; PHARMACEUTICAL, LABORATORY, INDUSTRIAL, AND SCIENTIFIC STERILIZERS, RETORTS AND AUTOCLAVES AND SOFTWARE SOLD AS A UNIT WITH AUTOCLAVES, RETORTS AND STERILIZERS FOR USE IN THE TREATMENT OF CONTAINERIZED FOODSTUFFS AND/OR PHARMACEUTICALS (U.S. CLS. 13, 21, 23, 31 AND 34).

FIRST USE 7-1-2005; IN COMMERCE 7-1-2005.

3,313,641. PANSCOPIC CORPORATION, SAN FRANCISCO, CA. SN 78-610,315. PUB. 8-15-2006, FILED 4-15-2005.

JASPERSOFT

THE MARK CONSISTS OF STANDARD CHARACTERS WITHOUT CLAIM TO ANY PARTICULAR FONT, STYLE, SIZE, OR COLOR.

CLASS 9—ELECTRICAL AND SCIENTIFIC APPARATUS

FOR COMPUTER PROGRAMS FOR DEFINING AND GENERATING REPORTS AND GRAPHICAL DISPLAYS OF DATA, FOR BUSINESS, ENTERTAINMENT, SCIENTIFIC, TECHNICAL, COMMERCIAL, EDUCATIONAL AND PERSONAL COMPUTING USES, BUT EXCLUDING THE FIELD OF INTEGRATED CIRCUIT DESIGN (U.S. CLS. 21, 23, 26, 36 AND 38).

FIRST USE 4-15-2005; IN COMMERCE 4-15-2005.

CLASS 41—EDUCATION AND ENTERTAINMENT

FOR EDUCATIONAL, INSTRUCTIONAL AND TRAINING SERVICES, NAMELY CONDUCTING CLASSES, SEMINARS AND TRAINING RELATED TO THE DEFINING OF REPORTS AND GRAPHICAL DISPLAYS OF DATA, BUT EXCLUDING THE FIELD OF INTEGRATED CIRCUIT DESIGN (U.S. CLS. 100, 101 AND 107).

FIRST USE 4-15-2005; IN COMMERCE 4-15-2005.

CLASS 42—SCIENTIFIC AND COMPUTER SERVICES

FOR DESIGN AND DEVELOPMENT OF COMPUTER SOFTWARE FOR OTHERS; TECHNICAL SUPPORT SERVICES AND CONSULTING SERVICES, NAMELY, TROUBLESHOOTING OF COMPUTER SOFTWARE PROBLEMS IN RELATION TO THE DEVELOPMENT AND GENERATION OF INTERACTIVE REPORTS AND GRAPHICAL DISPLAYS OF DATA; BUT EXCLUDING THE FIELD OF INTEGRATED CIRCUIT DESIGN (U.S. CLS. 100 AND 101).

FIRST USE 4-15-2005; IN COMMERCE 4-15-2005.

3,313,646. APTANA, INC., SAN FRANCISCO, CA. SN 78-610,852. PUB. 9-12-2006, FILED 4-18-2005.

AFLAX

THE MARK CONSISTS OF STANDARD CHARACTERS WITHOUT CLAIM TO ANY PARTICULAR FONT, STYLE, SIZE, OR COLOR.

CLASS 9—ELECTRICAL AND SCIENTIFIC APPARATUS

FOR COMPUTER SOFTWARE FOR USE IN DEVELOPING SOFTWARE APPLICATIONS; COMPILER SOFTWARE; COMPUTER SOFTWARE DEVELOPMENT TOOLS; COMPUTER SOFTWARE FOR CONVERTING DATA (U.S. CLS. 21, 23, 26, 36 AND 38).

FIRST USE 11-30-2005; IN COMMERCE 11-30-2005.

CLASS 42—SCIENTIFIC AND COMPUTER SERVICES

FOR COMPUTER SOFTWARE CONSULTATION (U.S. CLS. 100 AND 101).

FIRST USE 11-30-2005; IN COMMERCE 11-30-2005.

3,313,663. HEIL & LAMBERT LLC, WALNUT CREEK, CA. SN 78-619,208. PUB. 8-29-2006, FILED 4-28-2005.

SIMPLYSMART

THE MARK CONSISTS OF STANDARD CHARACTERS WITHOUT CLAIM TO ANY PARTICULAR FONT, STYLE, SIZE, OR COLOR.

CLASS 16—PAPER GOODS AND PRINTED MATTER

FOR PLASTIC VACUUM PACKAGING BAGS; PLASTIC PACKAGING BAGS (U.S. CLS. 2, 5, 22, 23, 29, 37, 38 AND 50).

FIRST USE 8-19-2005; IN COMMERCE 8-19-2005.

CLASS 21—HOUSEWARES AND GLASS

FOR BOWLS; CANISTERS (U.S. CLS. 2, 13, 23, 29, 30, 33, 40 AND 50).
FIRST USE 3-8-2006; IN COMMERCE 3-8-2006.

3,313,671. ZIMMERMAN ASSOCIATES, INC., FAIRFAX, VA. SN 78-622,066. PUB. 1-24-2006, FILED 5-4-2005.

BIOSAR 30

THE MARK CONSISTS OF STANDARD CHARACTERS WITHOUT CLAIM TO ANY PARTICULAR FONT, STYLE, SIZE, OR COLOR.

OWNER OF U.S. REG. NO. 2,231,108.

NO CLAIM IS MADE TO THE EXCLUSIVE RIGHT TO USE "30", APART FROM THE MARK AS SHOWN.

CLASS 9—ELECTRICAL AND SCIENTIFIC APPARATUS

FOR REMOTE SENSING DEVICES, NAMELY, SENSING DEVICES FOR SENSING TERRESTRIAL BIOMASS (U.S. CLS. 21, 23, 26, 36 AND 38).

FIRST USE 7-0-2006; IN COMMERCE 7-0-2006.

CLASS 42—SCIENTIFIC AND COMPUTER SERVICES

FOR REMOTE SENSING SERVICES, NAMELY, SERVICES IN THE NATURE OF SENSING TERRESTRIAL BIOMASS (U.S. CLS. 100 AND 101).

FIRST USE 7-0-2006; IN COMMERCE 7-0-2006.

3,313,687. S-LCD CORPORATION, ASAN-SI, CHUNG-CHEONGNAM-DO, REPUBLIC OF KOREA. SN 78-626,752. PUB. 3-6-2007, FILED 5-10-2005.



THE MARK CONSISTS OF THE LETTERS "S-LCD" UNDERNEATH A SERIES OF FIVE ARROWS EACH POINTING TO THE RIGHT.

CLASS 9—ELECTRICAL AND SCIENTIFIC APPARATUS

FOR TFT-LCD (THIN-FILM TRANSISTOR-LIQUID CRYSTAL DISPLAY) PANEL; PDP (PLASMA DISPLAY PANEL); LCD (LIQUID CRYSTAL DISPLAY) MONITOR; TELESCOPES; VIDEO CAMERAS; CAMCORDERS; EYEGASSES; CASH REGISTERS; DRY CELLS; ELECTRIC BATTERIES; ELECTRIC FLAT IRONS; TELEPHONE SETS; TELEVISION RECEIVERS, NAMELY, TELEVISION SETS; RADIO PAGERS; PORTABLE APPARATUS FOR TRANSMISSION OF COMMUNICATION; VIDEO DISC PLAYERS; COMPACT DISC PLAYERS; DIGITAL VERSATILE DISC (DVD) PLAYERS; MPEG AUDIO LAYER-3 (MP3) PLAYERS; MODEMS; HEADPHONES; BLANK OPTICAL DISCS; ELECTRONIC PHOTOCOPIERS; ELECTRONIC AGENDAS; COMPUTERS; COMPUTER MONITORS; DISK DRIVES FOR COMPUTERS; PRINTERS FOR USE WITH COMPUTERS; COMPUTER KEYBOARDS; CLOSED CIRCUIT BOARDS; POCKET CALCULATORS; BLANK COMPACT DISCS INTENDED FOR RECORDING; PDA (PERSONAL DIGITAL ASSISTANTS); SEMI-CONDUCTORS AND STRUCTURE SEMI-CONDUCTOR WAFERS; INTEGRATED CIRCUITS (U.S. CLS. 21, 23, 26, 36 AND 38).

FIRST USE 4-19-2005; IN COMMERCE 9-18-2005.

CLASS 11—ENVIRONMENTAL CONTROL APPARATUS

FOR DENTAL OVENS; WATER PURIFIERS FOR HOUSEHOLD PURPOSES; GAS RANGES; ELECTRIC KITCHEN RANGES AND OVENS; BIDETS; GAS STOVES; FURNACE BOILERS FOR HOUSEHOLD PURPOSES; STEAM AND ELECTRIC RADIATORS FOR HEATING BUILDINGS; GAS REFRIGERATORS; AIR CONDITIONERS; GAS LAMPS; HUMIDIFIERS; ROOM COOLERS FOR HOUSEHOLD PURPOSES, NAMELY, ELECTRIC FANS AND CEILING FANS; ELECTRIC REFRIGERATORS; ELECTRIC REFRIGERATING SHOWCASES; ELECTRIC STOVES; ELECTRIC LAUNDRY DRYERS; AUTOCLAVES; ELECTRIC DEEP FLYERS; ELECTRIC COFFEEPOTS; ELECTRIC COOKERS; ELECTRIC TOASTERS; MICROWAVE RANGES; INCANDESCENT LAMPS (U.S. CLS. 13, 21, 23, 31 AND 34).

FIRST USE 4-19-2005; IN COMMERCE 9-18-2005.

3,313,695. THE PROCTER & GAMBLE COMPANY, CINCINNATI, OH. SN 78-629,445. PUB. 1-31-2006, FILED 5-13-2005.

PRO-HEALTH

THE MARK CONSISTS OF STANDARD CHARACTERS WITHOUT CLAIM TO ANY PARTICULAR FONT, STYLE, SIZE, OR COLOR.

CLASS 3—COSMETICS AND CLEANING PREPARATIONS

FOR TOOTHPASTE (U.S. CLS. 1, 4, 6, 50, 51 AND 52).
FIRST USE 7-26-2006; IN COMMERCE 7-26-2006.

CLASS 21—HOUSEWARES AND GLASS

FOR ELECTRIC TOOTHBRUSHES (U.S. CLS. 2, 13, 23, 29, 30, 33, 40 AND 50).
FIRST USE 3-5-2007; IN COMMERCE 3-5-2007.

3,313,709. RAZORGATOR INTERACTIVE GROUP, INC., BEVERLY HILLS, CA. SN 78-638,870. PUB. 9-5-2006, FILED 5-27-2005.

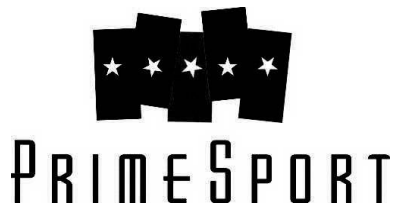

CLASS 35—ADVERTISING AND BUSINESS

FOR TICKET AGENCY SERVICES AND ADVERTISING AND PROMOTIONAL SERVICES IN THE FIELDS OF THEATER, CONCERTS, SPORTING EVENTS, PARTIES AND SPECIAL EVENTS OF OTHERS, AND EVENT MANAGEMENT FOR OTHERS (U.S. CLS. 100, 101 AND 102).

FIRST USE 9-0-2005; IN COMMERCE 9-0-2005.

CLASS 39—TRANSPORTATION AND STORAGE

FOR TRAVEL SERVICES, NAMELY ARRANGING TRAVEL TOURS, RETAIL AND WHOLESALE TRAVEL AGENCY SERVICES, NAMELY, MAKING RESERVATIONS AND BOOKINGS FOR TRANSPORTATION AND TRAVEL BOOKING AGENCY SERVICES (U.S. CLS. 100 AND 105).

FIRST USE 9-0-2005; IN COMMERCE 9-0-2005.

CLASS 43—HOTEL AND RESTAURANT SERVICES

FOR RETAIL AND WHOLESALE TRAVEL AGENCY SERVICES, NAMELY, MAKING RESERVATIONS AND BOOKING FOR TEMPORARY LODGING AND MAKING RESERVATIONS AND BOOKINGS FOR RESTAURANTS AND MEALS (U.S. CLS. 100 AND 101).

FIRST USE 9-0-2005; IN COMMERCE 9-0-2005.

3,313,710. THE BEAR STEARNS COMPANIES INC., NEW YORK, NY. SN 78-639,089. PUB. 8-22-2006, FILED 5-27-2005.

BEARXPLORER

THE MARK CONSISTS OF STANDARD CHARACTERS WITHOUT CLAIM TO ANY PARTICULAR FONT, STYLE, SIZE, OR COLOR.

CLASS 9—ELECTRICAL AND SCIENTIFIC APPARATUS

FOR COMPUTER SOFTWARE FOR SECURITIES RESEARCH, INVESTMENT ANALYSIS, PORTFOLIO RISK AND EXPOSURE ANALYSIS, AND FINANCIAL PORTFOLIO MANAGEMENT (U.S. CLS. 21, 23, 26, 36 AND 38).

FIRST USE 11-0-2005; IN COMMERCE 11-0-2005.

CLASS 36—INSURANCE AND FINANCIAL

FOR FINANCIAL ANALYSIS SERVICES PROVIDED VIA THE INTERNET, NAMELY, SECURITIES RESEARCH, AND ANALYSIS OF INVESTMENTS, PORTFOLIO RISK AND EXPOSURE; FINANCIAL MANAGEMENT SERVICES PROVIDED VIA THE INTERNET, NAMELY, MANAGEMENT OF FINANCIAL PORTFOLIOS (U.S. CLS. 100, 101 AND 102).

FIRST USE 11-0-2005; IN COMMERCE 11-0-2005.

CLASS 42—SCIENTIFIC AND COMPUTER SERVICES

FOR PROVIDING ONLINE NON-DOWNLOADABLE SOFTWARE FOR RESEARCHING SECURITIES, ANALYZING INVESTMENTS, PORTFOLIO RISK AND EXPOSURE, AND MANAGING FINANCIAL PORTFOLIOS (U.S. CLS. 100 AND 101).

FIRST USE 11-0-2005; IN COMMERCE 11-0-2005.

3,313,724. BLISTEX INC., OAK BROOK, IL. SN 78-645,245. PUB. 2-21-2006, FILED 6-7-2005.

TRUST THE GREEN. TRUST GLYSOMED.

THE MARK CONSISTS OF STANDARD CHARACTERS WITHOUT CLAIM TO ANY PARTICULAR FONT, STYLE, SIZE, OR COLOR.

OWNER OF U.S. REG. NO. 2,313,492.

CLASS 3—COSMETICS AND CLEANING PREPARATIONS

FOR NON-MEDICATED TOPICAL PREPARATIONS FOR HUMAN USE FOR DRYNESS, MOISTURIZATION, BURNING, ITCHING, COLD SORES, FOR CLEANSING THE SKIN, FOR SKIN AND LIP CARE PROTECTION, HAND, BODY, AND FACE CREAMS AND LOTIONS, AND NON-MEDICATED SUNSCREEN PREPARATIONS (U.S. CLS. 1, 4, 6, 50, 51 AND 52).

FIRST USE 4-17-2007; IN COMMERCE 4-17-2007.

CLASS 5—PHARMACEUTICALS

FOR MEDICATED TOPICAL PREPARATIONS FOR HUMAN USE FOR DRYNESS, MOISTURIZATION, BURNING, ITCHING, COLD SORES, FOR SKIN AND LIP CARE PROTECTION, MEDICATED HAND, BODY, AND FACE CREAMS AND LOTIONS, TOPICAL ANALGESIC PREPARATIONS, TOPICAL ANTIBIOTIC PREPARATIONS, AND MEDICATED SUNSCREEN PREPARATIONS (U.S. CLS. 6, 18, 44, 46, 51 AND 52).

FIRST USE 4-17-2007; IN COMMERCE 4-17-2007.

3,313,742. SUPRESS PRODUCTS LLC, SAN RAFAEL, CA. SN 78-652,073. PUB. 9-12-2006, FILED 6-16-2005.

SUPRESS

THE MARK CONSISTS OF STANDARD CHARACTERS WITHOUT CLAIM TO ANY PARTICULAR FONT, STYLE, SIZE, OR COLOR.

CLASS 6—METAL GOODS

FOR BUILDING MATERIALS MADE OF METAL, SPECIFICALLY, METAL CHANNELS, PANELS, AND SUPPORT STRUCTURES FOR FLOORS, WALLS, AND CEILINGS (U.S. CLS. 2, 12, 13, 14, 23, 25 AND 50).
FIRST USE 9-30-2005; IN COMMERCE 9-30-2005.

CLASS 19—NON-METALLIC BUILDING MATERIALS

FOR BUILDING MATERIALS MADE OF GYPSUM, PAPER, ADHESIVES, AND/OR WOOD, SPECIFICALLY, PANELS FOR WALLS, FLOORS, AND CEILINGS, NAMELY DRYWALL AND FLOORING (U.S. CLS. 1, 12, 33 AND 50).
FIRST USE 9-30-2005; IN COMMERCE 9-30-2005.

3,313,751. FNF INTELLECTUAL PROPERTY HOLDINGS, INC., JACKSONVILLE, FL. SN 78-655,390. PUB. 7-25-2006, FILED 6-21-2005.

FNTG

THE MARK CONSISTS OF STANDARD CHARACTERS WITHOUT CLAIM TO ANY PARTICULAR FONT, STYLE, SIZE, OR COLOR.

CLASS 35—ADVERTISING AND BUSINESS

FOR AUCTIONEERING SERVICES FOR REAL ESTATE FORECLOSURES; BUSINESS SERVICES, NAMELY PREPARATION OF NON-LEGAL DOCUMENTS; AND PROVIDING COMMERCIAL AND BUSINESS INFORMATION (U.S. CLS. 100, 101 AND 102).
FIRST USE 10-0-2005; IN COMMERCE 10-0-2005.

CLASS 36—INSURANCE AND FINANCIAL

FOR TITLE INSURANCE SERVICES, NAMELY AGENCY, BROKERAGE, UNDERWRITING, CONSULTANCY AND INFORMATION SERVICES FOR REAL PROPERTY LOCATED WITHIN AND OUTSIDE OF THE UNITED STATES, INSURANCE SERVICES, NAMELY AGENCY, BROKERAGE, UNDERWRITING, CONSULTANCY AND INFORMATION SERVICES FOR PROPERTY, CASUALTY AND HEALTH INSURANCE, AND COORDINATION OF SUCH INSURANCE TRANSACTIONS BETWEEN AGENTS, REAL ESTATE EVALUATION SERVICES, DEFAULT TITLE INSURANCE SERVICES, PROPERTY TAX PAYMENT SERVICES, PROPERTY TAX DELINQUENCY PROCESSING SERVICES, FINANCIAL DISBURSEMENT PROCESSING SERVICES, REAL ESTATE ESCROW AND IMPOUNDING SERVICES, CREDIT REPORTING SERVICES, EVALUATION OF REAL ESTATE FOR PURPOSES OF FLOOD HAZARD DETERMINATION AND CERTIFICATION, PROPERTY VALUATION AND APPRAISAL SERVICES AND BROKER-PRICING OPINION SERVICES IN THE FIELD OF REAL ESTATE VALUATION, REAL ESTATE LOAN DEFAULT MANAGEMENT SERVICES, TRUST MANAGEMENT SERVICES, TRUSTEE'S SALE GUARANTEE SERVICES, REAL ESTATE RECONVEYANCE SERVICES, MORTGAGE LENDING SERVICES, REAL ESTATE MANAGEMENT SERVICES FOR THE COORDINATION OF REAL ESTATE OWNED, "REO", TRANSACTIONS FOR LENDERS AND SERVICERS, FINANCIAL DISCLOSURE REPORTING SERVICES, REAL ESTATE AGENCY SERVICES, NAMELY ACTING AS A QUALIFIED INTERMEDIARY FOR TAX-DEFERRED EXCHANGES FOR REAL PROPERTY AND PERSONAL PROPERTY ON OR USED IN CONNECTION WITH SUCH REAL PROPERTY, PROVIDING FINANCIAL INFORMATION, REAL ESTATE SERVICES FOR TIMESHARE AND RESORT PROPERTIES, NAMELY UNDERWRITING TITLE INSURANCE, UNDERWRITING TITLE INSURANCE POLICIES, ESCROW SERVICES AND REAL ESTATE LISTINGS FOR RESALE, AND FORECLOSURE SERVICES; COMMERCIAL FINANCE SERVICES, NAMELY SERVICES FOR ORIGINATING, FUNDING, SECURITIZING AND SERVICING NON-CANCELABLE EQUIPMENT LEASES FOR OTHERS (U.S. CLS. 100, 101 AND 102).
FIRST USE 10-0-2005; IN COMMERCE 10-2-2005.

CLASS 42—SCIENTIFIC AND COMPUTER SERVICES

FOR REAL ESTATE CLOSING AND SETTLEMENT SERVICES; REAL ESTATE INSPECTION SERVICES TO DETERMINE A PROPERTY'S CONDITION, VERIFICATION OF OCCUPANCY AND INTERVIEW OF BORROWER; SERVICES FOR ORIGINATING, CLOSING AND SERVICING REAL ESTATE TRANSACTIONS FOR OTHERS, NAMELY TITLE SEARCH SERVICES IN THE NATURE OF DUE DILIGENCE AND RESEARCH SERVICES DESIGNED TO RESOLVE AND RETRIEVE MISSING OR DEFECTIVE DOCUMENTS AND TO OBTAIN CERTIFIED COPIES OF DOCUMENTS AND CHAIN-OF-TITLE VERIFICATION; LEGAL SERVICES IN THE FIELD OF REAL ESTATE; FLOOD HAZARD CERTIFICATION AND REGULATORY REVIEW FOR PURPOSES OF DETERMINING COMPLIANCE THEREWITH; LEGAL RECORDATION OF PROPERTY AND FINANCIAL DOCUMENTS; AND LEGAL ADVISORY SERVICES FOR THE COORDINATION OF REAL ESTATE OWNED, "REO", TRANSACTIONS FOR LENDERS AND SERVICERS; LEGAL DOCUMENT PREPARATION SERVICES; MORTGAGE ASSIGNMENT AND RELEASE PREPARATION SERVICES (U.S. CLS. 100 AND 101).
FIRST USE 10-0-2005; IN COMMERCE 10-0-2005.

3,313,759. BROWNELLS, MONTEZUMA, IA. SN 78-659,210.
PUB. 10-24-2006, FILED 6-27-2005.

FRICTION DEFENSE

THE MARK CONSISTS OF STANDARD CHARACTERS WITHOUT CLAIM TO ANY PARTICULAR FONT, STYLE, SIZE, OR COLOR.

NO CLAIM IS MADE TO THE EXCLUSIVE RIGHT TO USE "FRICTION", APART FROM THE MARK AS SHOWN.

CLASS 3—COSMETICS AND CLEANING PREPARATIONS

FOR GUN CLEANING PREPARATIONS, NAMELY, DEGREASING PREPARATIONS FOR USE ON GUNS (U.S. CLS. 1, 4, 6, 50, 51 AND 52).

FIRST USE 2-7-2006; IN COMMERCE 2-7-2006.

CLASS 4—LUBRICANTS AND FUELS

FOR GUNSMITHING PRODUCTS, NAMELY, GUN BARREL OILS AND GUN LUBRICANTS (U.S. CLS. 1, 6 AND 15).

FIRST USE 2-7-2006; IN COMMERCE 2-7-2006.

CLASS 13—FIREARMS

FOR GUN CLEANING PRODUCTS, NAMELY, CLEANING BRUSHES, MOPS, AND PATCHES, AND PRINTED MATERIALS ABOUT GUN CLEANING SOLD AS A UNIT; GUN CLEANING KITS CONSISTING PRIMARILY OF CLEANING BRUSHES, MOPS, PATCHES, GUN BARREL OILS, GUN LUBRICANTS, SOLVENTS, COMBINATION GUN POLISH, AND BLUING COMPOSITION, AND PRINTED MATERIALS ABOUT GUN CLEANING SOLD AS A UNIT (U.S. CLS. 2 AND 9).

FIRST USE 2-7-2006; IN COMMERCE 2-7-2006.

3,313,764. STERLING SERVICES GROUP, L.C., EUDORA, KS. SN 78-660,238. PUB. 10-24-2006, FILED 6-28-2005.

ROOM OPTIMIZATION

THE MARK CONSISTS OF STANDARD CHARACTERS WITHOUT CLAIM TO ANY PARTICULAR FONT, STYLE, SIZE, OR COLOR.

NO CLAIM IS MADE TO THE EXCLUSIVE RIGHT TO USE "ROOM", APART FROM THE MARK AS SHOWN.

CLASS 35—ADVERTISING AND BUSINESS

FOR HEALTH CARE FACILITY MANAGEMENT SERVICES DIRECTED TO IMPROVING EFFICIENCY AND QUALITY IN THE CLEANING OF PATIENTS' ROOMS IN HOSPITAL AND HEALTHCARE RELATED FACILITIES (U.S. CLS. 100, 101 AND 102).

FIRST USE 6-0-2005; IN COMMERCE 6-0-2005.

CLASS 37—CONSTRUCTION AND REPAIR

FOR CONSULTING SERVICES DIRECTED TO IMPROVING EFFICIENCY AND QUALITY IN THE CLEANING OF PATIENTS ROOMS IN HOSPITAL AND HEALTHCARE RELATED FACILITIES (U.S. CLS. 100, 103 AND 106).

FIRST USE 6-0-2005; IN COMMERCE 6-0-2005.

3,313,770. PORTALCAST, INC., IRVINE, CA. SN 78-662,501.
PUB. 9-26-2006, FILED 7-1-2005.



CLASS 35—ADVERTISING AND BUSINESS

FOR RETAIL MUSIC AND VIDEO STORES FEATURING PRE-RECORDED AUDIO AND VIDEO CASSETTE TAPES, COMPACT DISCS, DVDS, CD ROMS, AND LASER DISKS; ON-LINE RETAIL STORE SERVICES FEATURING DOWNLOADABLE PRE-RECORDED MUSIC AND VIDEO; STAND ALONE KIOSK SERVICES FEATURING AUDIO-VIDEO DISPLAYS THAT VEND, PLAY, EXHIBIT AND DISPLAY AUDIO, VIDEO, MOTION PICTURE AND DIGITAL MEDIA PROGRAMMING; FRANCHISING SERVICES, NAMELY, OFFERING TECHNICAL AND BUSINESS MANAGEMENT ASSISTANCE IN THE ESTABLISHMENT AND OPERATION OF A NETWORK OF FILM AND VIDEO VIEWING DEVICES AT BUSINESS LOCATIONS (U.S. CLS. 100, 101 AND 102).

FIRST USE 2-8-2007; IN COMMERCE 2-8-2007.

CLASS 38—COMMUNICATION

FOR STREAMING OF AUDIO AND VIDEO MATERIAL ON THE INTERNET, PAY-PER-VIEW TELEVISION TRANSMISSION SERVICES (U.S. CLS. 100, 101 AND 104).

FIRST USE 2-8-2007; IN COMMERCE 2-8-2007.

CLASS 41—EDUCATION AND ENTERTAINMENT

FOR MOTION PICTURE FILM PRODUCTION; VIDEO PRODUCTION SERVICES; AND AUDIO RECORDING AND PRODUCTION, ALL FOR VIEWING BY THE PUBLIC (U.S. CLS. 100, 101 AND 107).

FIRST USE 2-8-2007; IN COMMERCE 2-8-2007.

3,313,771. ADVANCED SEMICONDUCTOR MANUFACTURING CORPORATION LIMITED, SHANGHAI, CHINA. SN 78-662,627. PUB. 9-12-2006, FILED 7-1-2005.



CLASS 9—ELECTRICAL AND SCIENTIFIC APPARATUS

FOR RECORDED COMPUTER PROGRAMS FOR USE IN DATABASE MANAGEMENT IN THE FIELD OF FABRICATION AND MANUFACTURE OF PARTS OF SEMICONDUCTORS, NAMELY, CHIPS; SEMI-CONDUCTOR DEVICES; GERMANIUM SILICON WAFERS, SILICON WAFERS, SILICON SLICER WAFERS, INTEGRATED CIRCUITS, PHOTO MASKS, COMPUTER INTERFACE BOARDS, MICROPROCESSORS, COMPUTERS FOR TESTING SEMICONDUCTOR APPARATUS AND INTEGRATED CIRCUITS, POWER ELEMENTS OF SEMICONDUCTORS IN THE NATURE OF CONDUCTING FRAMES, ELECTRIC WIRES, INTEGRATED CIRCUIT CARDS, BLANK SMART CARDS, PROBES FOR TESTING INTEGRATED CIRCUITS, ELECTRONIC CARD READERS FOR DATA PROCESSING EQUIPMENT AND FIBER OPTICS (U.S. CLS. 21, 23, 26, 36 AND 38).

FIRST USE 6-0-2005; IN COMMERCE 4-0-2006.

CLASS 40—MATERIAL TREATMENT

FOR FOUNDRY SERVICES, NAMELY, CUSTOM MANUFACTURE OF SEMICONDUCTOR DEVICES, GERMANIUM SILICON WAFERS, SILICON WAFERS, SILICON SLICER WAFERS INTEGRATED CIRCUITS, PHOTO MASKS, COMPUTER INTERFACE BOARDS, MICROPROCESSORS, COMPUTERS FOR TESTING SEMICONDUCTOR APPARATUS AND INTEGRATED CIRCUITS, POWER ELEMENTS OF SEMICONDUCTORS IN THE NATURE OF CONDUCTING FRAMES, ELECTRIC WIRES, INTEGRATED CIRCUIT CARDS, BLANK SMART CARDS, PROBES FOR TESTING INTEGRATED CIRCUITS, ELECTRONIC CARD READERS FOR DATA PROCESSING EQUIPMENT AND FIBER OPTICS FOR CUSTOMERS; MANUFACTURING AND FOUNDRY SERVICES OF SEMICONDUCTOR, SILICON WAFERS AND INTEGRATED CIRCUITS FOR CUSTOMERS; ETCHING SERVICE OF SEMICONDUCTOR, SILICON WAFERS AND INTEGRATED CIRCUITS FOR CUSTOMERS; ASSEMBLY SERVICES OF INTEGRATED CIRCUIT PHOTO MASKS, INTEGRATED CIRCUIT WAFERS, ELECTRON WAFERS AND COMPUTER WAFERS FOR CUSTOMERS (U.S. CLS. 100, 103 AND 106).

FIRST USE 6-0-2005; IN COMMERCE 4-0-2006.

3,313,779. ORIENTAL MOTOR CO., LTD., TOKYO, JAPAN. SN 78-667,664. PUB. 1-23-2007, FILED 7-11-2005.



NO CLAIM IS MADE TO THE EXCLUSIVE RIGHT TO USE "LINEAR MOTION", APART FROM THE MARK AS SHOWN.

CLASS 7—MACHINERY

FOR AC MOTORS AND DC MOTORS NOT INCLUDING THOSE FOR LAND VEHICLES AND PARTS THEREFOR; STEPPING MOTORS, SERVO MOTORS; POWER TRANSMISSIONS AND GEARING FOR MACHINES NOT FOR LAND VEHICLES; LINEAR ACTUATORS; LINEAR ACTUATOR SYSTEMS COMPRISING, ACTUATORS, CONTROLLERS, MONITORS, DATA EDITING SOFTWARE, INPUT INTERFACES, SENSORS, AND BATTERIES SOLD AS A UNIT (U.S. CLS. 13, 19, 21, 23, 31, 34 AND 35).

FIRST USE 10-1-2001; IN COMMERCE 10-1-2001.

CLASS 9—ELECTRICAL AND SCIENTIFIC APPARATUS

FOR PARTS FOR A LINEAR ACTUATOR SYSTEM, NAMELY, ELECTRICAL CONTROLLERS (U.S. CLS. 21, 23, 26, 36 AND 38).

FIRST USE 10-1-2001; IN COMMERCE 10-1-2001.

3,313,780. BAILEY GROUP, INC., THE, PLYMOUTH MEETING, PA. SN 78-667,988. PUB. 12-5-2006, FILED 7-11-2005.

FORESIGHT

THE MARK CONSISTS OF STANDARD CHARACTERS WITHOUT CLAIM TO ANY PARTICULAR FONT, STYLE, SIZE, OR COLOR.

CLASS 16—PAPER GOODS AND PRINTED MATTER

FOR NEWSLETTERS IN THE FIELDS OF ADVERTISING, CORPORATE AND BRAND IDENTITY, PRODUCT DEVELOPMENT, INDUSTRIAL DESIGN, DESIGN OF CORPORATE COMMUNICATIONS, GRAPHIC ART DESIGN, RETAIL ENVIRONMENT DESIGN, PACKAGING DESIGN, GRAPHIC AND STRUCTURAL DESIGN (U.S. CLS. 2, 5, 22, 23, 29, 37, 38 AND 50).

FIRST USE 11-27-2006; IN COMMERCE 11-27-2006.

CLASS 41—EDUCATION AND ENTERTAINMENT

FOR PROVIDING NEWSLETTERS VIA EMAIL IN THE FIELDS OF ADVERTISING, CORPORATE AND BRAND IDENTITY, PRODUCT DEVELOPMENT, INDUSTRIAL DESIGN, DESIGN OF CORPORATE COMMUNICATIONS, GRAPHIC ART DESIGN, RETAIL ENVIRONMENT DESIGN, PACKAGING DESIGN, GRAPHIC AND STRUCTURAL DESIGN (U.S. CLS. 100, 101 AND 107).

FIRST USE 6-29-2006; IN COMMERCE 6-29-2006.

3,313,790. PHILD CO., LTD., KYOTO CITY, KYOTO PREF., JAPAN. SN 78-673,199. PUB. 10-17-2006, FILED 7-19-2005.



OWNER OF U.S. REG. NO. 2,582,900.
THE MARK CONSISTS OF A STYLIZED LETTER "P" AND THE STYLIZED WORD "PHITEN".

CLASS 18—LEATHER GOODS

FOR CLOTHING FOR DOMESTIC PETS; BAGS, NAMELY, SHOULDER BAGS, BRIEFCASES, SUITCASES, CARRY-ON BAGS, HANDBAGS, BOSTON BAGS, BACKPACKS, RUCKSACKS, GARMENT BAGS FOR TRAVEL AND BELT BAGS (U.S. CLS. 1, 2, 3, 22 AND 41).
FIRST USE 7-19-2005; IN COMMERCE 7-19-2005.

CLASS 20—FURNITURE AND ARTICLES NOT OTHERWISE CLASSIFIED

FOR CUSHIONS, JAPANESE FLOOR CUSHIONS, PILLOWS, MATTRESSES (U.S. CLS. 2, 13, 22, 25, 32 AND 50).
FIRST USE 7-19-2005; IN COMMERCE 7-19-2005.

3,313,792. RESTRADE, LLC, NEW YORK, NY. SN 78-673,726. PUB. 8-22-2006, FILED 7-19-2005.

RESCUE BEAUTY LOUNGE

THE MARK CONSISTS OF STANDARD CHARACTERS WITHOUT CLAIM TO ANY PARTICULAR FONT, STYLE, SIZE, OR COLOR.

OWNER OF U.S. REG. NO. 2,758,105.
NO CLAIM IS MADE TO THE EXCLUSIVE RIGHT TO USE "BEAUTY", APART FROM THE MARK AS SHOWN.

CLASS 3—COSMETICS AND CLEANING PREPARATIONS

FOR PRE-MOISTENED COSMETIC WIPES; LIP GLOSS; NAIL POLISH; NAIL POLISH REMOVER WIPES; MAKE-UP REMOVER WIPES (U.S. CLS. 1, 4, 6, 50, 51 AND 52).

FIRST USE 8-0-2000; IN COMMERCE 8-0-2000.

CLASS 8—HAND TOOLS

FOR CUTICLE NIPPERS; NAIL CLIPPERS; SCISSORS; NAIL SCISSORS; CUTICLE SCISSORS; CUTICLE PUSHERS; NAIL FILES; FOOT FILES; TWEEZERS; MANICURE IMPLEMENTS NAMELY MANICURE STICKS (U.S. CLS. 23, 28 AND 44).

FIRST USE 8-0-2000; IN COMMERCE 8-0-2000.

3,313,802. SILVER SPRING REALTY, LLC, SILVER SPRING, MD. SN 78-676,850. PUB. 7-25-2006, FILED 7-23-2005.

Sowing American Prosperity

THE MARK CONSISTS OF STANDARD CHARACTERS WITHOUT CLAIM TO ANY PARTICULAR FONT, STYLE, SIZE, OR COLOR.

CLASS 16—PAPER GOODS AND PRINTED MATTER

FOR PRINTED MATTER AND TEACHING MATERIALS NAMELY, PUBLICATIONS AND INSTRUCTIONAL MATERIALS IN THE FIELDS OF-1) OBTAINING MORTGAGES, 2) BUYING AND SELLING REAL ESTATE, 3) UNDERSTANDING SETTLEMENTS, PROPERTY MANAGEMENT, INVESTMENTS 4) COUNSELING FOR CREDIT MANAGEMENT, CAREER DEVELOPMENT AND MULTI-CULTURAL AND LEADERSHIP AWARENESS (U.S. CLS. 2, 5, 22, 23, 29, 37, 38 AND 50).

FIRST USE 11-25-2006; IN COMMERCE 2-15-2007.

CLASS 36—INSURANCE AND FINANCIAL

FOR FINANCIAL AND REAL ESTATE SERVICES NAMELY, MORTGAGE LENDING, MORTGAGE BROKERAGE AND MORTGAGE BANKING, LEASING OF REAL ESTATE, REAL ESTATE BROKERAGE, PROPERTY MANAGEMENT, REAL ESTATE INVESTMENTS (U.S. CLS. 100, 101 AND 102).

FIRST USE 2-1-2004; IN COMMERCE 2-1-2004.

CLASS 41—EDUCATION AND ENTERTAINMENT

FOR EDUCATIONAL AND ENTERTAINMENT SERVICES NAMELY PROVIDING TRAINING THROUGH RADIO PROGRAMMING, WEBSITE, SEMINARS, LECTURES ABOUT REAL ESTATE PURCHASE AND INVESTMENT, CREDIT MANAGEMENT, CAREER DEVELOPMENT, MULTI-CULTURAL AND LEADERSHIP AWARENESS (U.S. CLS. 100, 101 AND 107).

FIRST USE 11-15-2006; IN COMMERCE 2-4-2007.

3,313,804. STELOR PRODUCTIONS, LLC, DARNESTOWN, MD. SN 78-678,744. PUB. 8-15-2006, FILED 7-26-2005.

PIXKEY

THE MARK CONSISTS OF STANDARD CHARACTERS WITHOUT CLAIM TO ANY PARTICULAR FONT, STYLE, SIZE, OR COLOR.

CLASS 9—ELECTRICAL AND SCIENTIFIC APPARATUS

FOR DOWNLOADABLE COMPUTER COMMUNICATION SOFTWARE FOR ACCESSING ELECTRONICALLY ACTIVATED ACCESS CONTROL MECHANISMS, ELECTRONIC LOCKS, AND COMPUTERS (U.S. CLS. 21, 23, 26, 36 AND 38).

FIRST USE 6-7-2005; IN COMMERCE 4-1-2007.

CLASS 42—SCIENTIFIC AND COMPUTER SERVICES

FOR PROVIDING TEMPORARY USE OF NON-DOWNLOADABLE COMPUTER COMMUNICATION SOFTWARE FOR ACCESSING ELECTRONICALLY ACTIVATED ACCESS CONTROL MECHANISMS, ELECTRONIC LOCKS, AND COMPUTERS (U.S. CLS. 100 AND 101).
FIRST USE 6-7-2005; IN COMMERCE 4-1-2007.

3,313,805. RADER, GEORGE, CANTON, OH. SN 78-679,592.
PUB. 10-24-2006, FILED 7-27-2005.



NO CLAIM IS MADE TO THE EXCLUSIVE RIGHT TO USE "FOOD", APART FROM THE MARK AS SHOWN.

CLASS 29—MEATS AND PROCESSED FOODS

FOR HOT DOGS, SAUSAGES, AND POTATO CHIPS (U.S. CL. 46).
FIRST USE 1-1-2007; IN COMMERCE 1-1-2007.

CLASS 30—STAPLE FOODS

FOR CORN CHIPS (U.S. CL. 46).
FIRST USE 1-1-2007; IN COMMERCE 1-1-2007.

3,313,815. GENERAL ELECTRIC COMPANY, SCHNECTADY, NY. SN 78-683,277. PUB. 9-5-2006, FILED 8-2-2005.

PREDICT, DIAGNOSE, INFORM
& TREAT

THE MARK CONSISTS OF STANDARD CHARACTERS WITHOUT CLAIM TO ANY PARTICULAR FONT, STYLE, SIZE, OR COLOR.

CLASS 1—CHEMICALS

FOR CHEMICALS AND CHEMICAL REAGENTS FOR USE IN INDUSTRY, SCIENCE AND RESEARCH (U.S. CLS. 1, 5, 6, 10, 26 AND 46).
FIRST USE 4-30-2004; IN COMMERCE 4-30-2004.

CLASS 5—PHARMACEUTICALS

FOR PHARMACEUTICALS, NAMELY, MEDICAL IMAGING AGENTS AND RADIOPHARMACEUTICALS; DIAGNOSTIC REAGENTS FOR MEDICAL USE (U.S. CLS. 6, 18, 44, 46, 51 AND 52).
FIRST USE 4-30-2004; IN COMMERCE 4-30-2004.

CLASS 9—ELECTRICAL AND SCIENTIFIC APPARATUS

FOR SOFTWARE FOR MEDICAL IMAGING EQUIPMENT FOR USE IN STORING, ANALYZING, DISPLAYING AND MANAGING MEDICAL DATA FOR USE IN HOSPITALS, HEALTHCARE CLINICS, PHYSICIAN OFFICES, AND HEALTHCARE RESEARCH AND DEVELOPMENT INSTITUTIONS; SOFTWARE FOR PERSONALIZED HEALTHCARE, NAMELY, SOFTWARE FOR STORING, ANALYZING, DISPLAYING AND MANAGING DATA FOR USE IN PREDICTING, DIAGNOSING, INFORMING AND TREATING HUMAN AND ANIMAL PATIENTS FOR USE IN THE HEALTHCARE AND VETERINARY INDUSTRIES (U.S. CLS. 21, 23, 26, 36 AND 38).
FIRST USE 4-30-2004; IN COMMERCE 4-30-2004.

CLASS 10—MEDICAL APPARATUS

FOR PATIENT MONITORING, PREDICTIVE, DIAGNOSTIC, THERAPEUTIC AND SURGICAL APPARATUS, NAMELY, MEDICAL DIAGNOSTIC IMAGING APPARATUS FOR DISPLAYING DIAGNOSTIC IMAGES, X-RAY AND RADIOLOGICAL APPARATUS, X-RAY TUBES FOR MEDICAL USE, COMPUTER TOMOGRAPHY APPARATUS, MAGNETIC RESONANCE IMAGING APPARATUS, POSITRON EMISSION TOMOGRAPHY APPARATUS, SPECTROSCOPIC APPARATUS, ULTRASONIC MEDICAL APPARATUS, NUCLEAR MEDICAL APPARATUS, RADIATION THERAPY APPARATUS, MEDICAL INTERVENTION APPARATUS, MAGNETIC GRADIENT COILS, FETAL PULSE AND VITAL SIGNS MONITORS, BONE DENSITOMETERS, AND COMPONENT PARTS OF ALL THE FOREGOING (U.S. CLS. 26, 39 AND 44).
FIRST USE 4-30-2004; IN COMMERCE 4-30-2004.

3,313,820. JOHN BRIAN LOSH, INC., SEATTLE, WA. SN 78-686,075. PUB. 7-25-2006, FILED 8-4-2005.



OWNER OF U.S. REG. NOS. 2,273,437 AND 2,707,157.
THE MARK CONSISTS OF A LION'S HEAD IN A CIRCLE, WITH THE TEXT "REGENTS".

CLASS 16—PAPER GOODS AND PRINTED MATTER

FOR DIRECTORY AND MAGAZINE ABOUT THE REAL ESTATE INDUSTRY (U.S. CLS. 2, 5, 22, 23, 29, 37, 38 AND 50).
FIRST USE 8-16-2004; IN COMMERCE 0-0-2004.

CLASS 35—ADVERTISING AND BUSINESS

FOR PROVIDING REAL ESTATE BROKER REFERRALS (U.S. CLS. 100, 101 AND 102).
FIRST USE 8-16-2004; IN COMMERCE 8-16-2004.

CLASS 36—INSURANCE AND FINANCIAL

FOR PROVIDING REAL ESTATE INFORMATION ON THE SUBJECT OF REAL ESTATE BROKERS AND LISTINGS, EXCLUDING REFERRALS (U.S. CLS. 100, 101 AND 102).

FIRST USE 8-16-2004; IN COMMERCE 8-16-2004.

3,313,834. HERSHEY CHOCOLATE & CONFECTIONERY CORPORATION, WHEAT RIDGE, CO. SN 78-692,859. PUB. 10-31-2006, FILED 8-15-2005.



3,313,823. DELSENER/SLATER ENTERPRISES, LTD., HOUSTON, TX. SN 78-686,633. PUB. 3-14-2006, FILED 8-5-2005.

ACROSS THE NARROWS

THE MARK CONSISTS OF STANDARD CHARACTERS WITHOUT CLAIM TO ANY PARTICULAR FONT, STYLE, SIZE, OR COLOR.

NO CLAIM IS MADE TO THE EXCLUSIVE RIGHT TO USE "LOW GLYCEMIC INDEX", APART FROM THE MARK AS SHOWN.

THE MARK CONSISTS OF TWO CONCENTRIC CIRCLES INBETWEEN WHICH ARE PRINTED THE WORDS LOW GLYCEMIC INDEX. A CHECK MARK IS PLACED WITHIN THE CENTER MOST CIRCLE AND EXTENDS OUTSIDE THE OUTER CIRCLE.

CLASS 5—PHARMACEUTICALS

FOR DIETARY AND NUTRITIONAL FOOD SUPPLEMENT SNACK BARS, NUTRITIONAL ENERGY SNACK BARS, AND MEAL REPLACEMENT BARS, ALL FEATURING A LYCEUM INDEX RATING OF LESS THAN 55 (U.S. CLS. 6, 18, 44, 46, 51 AND 52).

FIRST USE 9-7-2005; IN COMMERCE 9-7-2005.

CLASS 30—STAPLE FOODS

FOR CANDY FEATURING A LYCEUM INDEX RATING OF LESS THAN 55; GRAIN BASED SNACK BARS, NAMELY NUTRITIONAL ENERGY SNACK BARS, FEATURING A ALCHEMIC INDEX RATING OF LESS THAN 55 ALSO CONTAINING SOY (U.S. CL. 46).

FIRST USE 9-7-2005; IN COMMERCE 9-7-2005.

CLASS 35—ADVERTISING AND BUSINESS

FOR PROMOTING A VARIETY OF LIVE ENTERTAINMENT EVENTS FOR OTHERS AND PROMOTING MERCHANDISE RELATED THERETO; BUSINESS MANAGEMENT AND PROMOTING THE SPECIAL EVENTS OF OTHERS, ALL IN THE FIELD OF MUSICAL, THEATRICAL, EDUCATIONAL, CULTURAL, AND FAMILY/VARIETY TOURS AND PRESENTATIONS; BUSINESS OPERATION AND BUSINESS MANAGEMENT OF ENTERTAINMENT VENUES FOR OTHERS; RETAIL STORE SERVICES FEATURING ARTIST AND TOUR-RELATED MERCHANDISE AND COLLECTIBLES; PROMOTING TICKET SALES AND VIP PRIVILEGES FOR LIVE ENTERTAINMENT EVENTS FOR OTHERS (U.S. CLS. 100, 101 AND 102).

FIRST USE 10-1-2005; IN COMMERCE 10-1-2005.

3,313,835. T-SQUARE EXPRESS, INC., MIAMI, FL. SN 78-696,311. PUB. 7-4-2006, FILED 8-19-2005.



NO CLAIM IS MADE TO THE EXCLUSIVE RIGHT TO USE "IMAGING", APART FROM THE MARK AS SHOWN.

THE COLOR(S) BLACK, RED, ORANGE, BLUE AND GREEN IS/ARE CLAIMED AS A FEATURE OF THE MARK.

THE COLORS RED, ORANGE, BLUE AND GREEN APPEAR IN THE "I" DESIGN IN THE MARK; AND THE COLOR BLACK APPEARS IN THE WORDING "MIX IMAGING".

CLASS 41—EDUCATION AND ENTERTAINMENT

FOR PRODUCTION OF LIVE ENTERTAINMENT EVENTS, NAMELY, LIVE CONCERTS, FESTIVALS, THEATRICAL SHOWS, EDUCATIONAL AND CULTURAL EVENTS, AND SHOWS FOR THE ENTERTAINMENT OF CHILDREN; ENTERTAINMENT SERVICES IN THE NATURE OF ORGANIZING MUSICAL, THEATRICAL, EDUCATIONAL, CULTURAL, AND FAMILY/VARIETY TOURS AND PRESENTATIONS (U.S. CLS. 100, 101 AND 107).

FIRST USE 10-1-2005; IN COMMERCE 10-1-2005.

CLASS 16—PAPER GOODS AND PRINTED MATTER

FOR PRINTED PAPER AND VINYL SIGNS, POSTERS, PHOTOGRAPHS, POINT-OF-PURCHASE SIGNAGE, BANNERS (U.S. CLS. 2, 5, 22, 23, 29, 37, 38 AND 50).

FIRST USE 8-31-2005; IN COMMERCE 8-31-2005.

CLASS 40—MATERIAL TREATMENT

FOR DIGITAL ENHANCEMENT, PHOTO FINISHING, RESTORATION AND DIGITIZING INTO A COMPUTER READABLE MEDIA; FINISHING SERVICES, NAMELY, LAMINATING AND MOUNTING OF PAPER AND VINYL SIGNS, POSTERS, PHOTOGRAPHS AND BANNERS ON SUBSTRATES; AUTOMATED CUSTOM CUT-OUTS OF MOUNTED MATERIALS, PRINTING AND MOUNTING OF ADHESIVE-BACKED CAST PVC FILM FOR WRAPPING COMMERCIAL VEHICLES FOR ADVERTISING OR OTHER PROMOTIONAL PURPOSES (U.S. CLS. 100, 103 AND 106).

FIRST USE 8-31-2005; IN COMMERCE 8-31-2005.

CLASS 41—EDUCATION AND ENTERTAINMENT

FOR DIGITAL IMAGING SERVICES (U.S. CLS. 100, 101 AND 107).

FIRST USE 8-31-2005; IN COMMERCE 8-31-2005.

CLASS 42—SCIENTIFIC AND COMPUTER SERVICES

FOR COMPUTER GRAPHICS AND PRINTING SERVICES, AND GRAPHIC ART DESIGN (U.S. CLS. 100 AND 101).

FIRST USE 8-31-2005; IN COMMERCE 8-31-2005.

3,313,841. ALASKA STRUCTURES, INC., ANCHORAGE, AK. SN 78-698,877. PUB. 5-23-2006, FILED 8-23-2005.



THE COLOR(S) BLUE, ORANGE, WHITE, AND BLACK IS/ARE CLAIMED AS A FEATURE OF THE MARK.

THE MARK CONSISTS OF THE PHRASE BLU-MED IN BLUE LETTERS, EXCEPT THAT THE HYPHEN IS IN THE FORM OF AN ORANGE BAR, WHICH ORANGE BAR IS THE MIDDLE OF THREE BARS OF EQUAL SIZE ALIGNED ONE ABOVE THE OTHER, THE TOP AND BOTTOM BARS BEING WHITE IN COLOR, ALL ENCLOSED IN A RECTANGLE OF BLACK.

CLASS 35—ADVERTISING AND BUSINESS

FOR TRANSPORTATION LOGISTIC SERVICES, NAMELY, ARRANGING THE TRANSPORTATION OF GOODS FOR OTHERS IN THE NATURE OF ARRANGING SHIPPING AND TRANSPORTING OF SUPPLIES, EQUIPMENT, AND OTHER GOODS IN RESPONSE TO DISASTERS AND EMERGENCIES (U.S. CLS. 100, 101 AND 102).

FIRST USE 4-30-2005; IN COMMERCE 4-30-2005.

CLASS 37—CONSTRUCTION AND REPAIR

FOR SUPPLY AND ERECTION OF MOBILE MEDICAL, HOSPITAL AND SURGICAL TREATMENT FACILITIES ON AN ON-DEMAND BASIS BY SUBSCRIPTION (U.S. CLS. 100, 103 AND 106).

FIRST USE 4-30-2005; IN COMMERCE 4-30-2005.

CLASS 42—SCIENTIFIC AND COMPUTER SERVICES

FOR TECHNICAL CONSULTING SERVICES REGARDING THE DESIGN AND IMPLEMENTATION OF MOBILE MEDICAL, HOSPITAL, AND SURGICAL TREATMENT FACILITIES (U.S. CLS. 100 AND 101).

FIRST USE 4-30-2005; IN COMMERCE 4-30-2005.

3,313,842. DBC ASSOCIATES, LLC, ATLANTA, GA. SN 78-698,935. PUB. 9-12-2006, FILED 8-23-2005.

SCENTAROME

THE MARK CONSISTS OF STANDARD CHARACTERS WITHOUT CLAIM TO ANY PARTICULAR FONT, STYLE, SIZE, OR COLOR.

CLASS 1—CHEMICALS

FOR FRAGRANCES FOR USE IN MANUFACTURING PERSONAL CARE PRODUCTS, HOUSEHOLD PRODUCTS, INDUSTRIAL PRODUCTS, CLEANING PRODUCTS, DEODORIZERS, SOAPS, PERFUMES, LOTIONS, COSMETICS, CANDLES AND CREAMS (U.S. CLS. 1, 5, 6, 10, 26 AND 46).

FIRST USE 12-31-2005; IN COMMERCE 1-31-2006.

CLASS 3—COSMETICS AND CLEANING PREPARATIONS

FOR ESSENTIAL OILS FOR USE IN THE MANUFACTURE OF PERSONAL CARE PRODUCTS, HOUSEHOLD PRODUCTS, INDUSTRIAL PRODUCTS, CLEANING PRODUCTS, DEODORIZERS, SOAPS, PERFUMES, LOTIONS, COSMETICS, CANDLES AND CREAMS (U.S. CLS. 1, 4, 6, 50, 51 AND 52).

FIRST USE 12-31-2005; IN COMMERCE 1-31-2006.

3,313,851. BLUE CROSS AND BLUE SHIELD ASSOCIATION, CHICAGO, IL. SN 78-701,074. PUB. 1-16-2007, FILED 8-26-2005.

BLUE DISTINCTION

THE MARK CONSISTS OF STANDARD CHARACTERS WITHOUT CLAIM TO ANY PARTICULAR FONT, STYLE, SIZE, OR COLOR.

OWNER OF U.S. REG. NOS. 554,488, 1,426,942, AND OTHERS.

CLASS 35—ADVERTISING AND BUSINESS

FOR ASSESSING HEALTHCARE SERVICE PROVIDER PERFORMANCE, PROVIDING CENTERS FOR EXCELLENCE PROGRAMS, PROVIDING SPECIALTY CARE CENTERS, NAMELY, CONDUCTING A QUALITY MEASUREMENT, IMPROVEMENT AND ASSURANCE SURVEYS IN HOSPITALS TO DETERMINE SERVICE QUALITY (U.S. CLS. 100, 101 AND 102).

FIRST USE 6-5-2006; IN COMMERCE 6-5-2006.

CLASS 36—INSURANCE AND FINANCIAL

FOR ORGANIZATION AND ADMINISTRATION OF PRE-PAID, PREFERRED PROVIDER ORGANIZATION, HEALTH MAINTENANCE ORGANIZATION, EXCLUSIVE PROVIDER ORGANIZATION, AND POINT OF SERVICE HEALTHCARE PLANS (U.S. CLS. 100, 101 AND 102).

FIRST USE 6-5-2006; IN COMMERCE 6-5-2006.

CLASS 44—MEDICAL, BEAUTY AND AGRICULTURAL SERVICES

FOR HEALTHCARE SERVICES AND COMPREHENSIVE HEALTHCARE BENEFITS PROGRAMS, INCLUDING THOSE RENDERED THROUGH A HEALTH MAINTENANCE ORGANIZATION AND PREFERRED PROVIDER ORGANIZATION, NAMELY PHYSICIAN, DENTAL, HOSPITAL, HOME HEALTH CARE, PREVENTATIVE HEALTHCARE TREATMENT, PHYSICAL THERAPY AND DISPENSING OF PHARMACEUTICALS SERVICES; HEALTHCARE CONSULTING SERVICES (U.S. CLS. 100 AND 101).

FIRST USE 6-5-2006; IN COMMERCE 6-5-2006.

3,313,856. OILS BY NATURE, INC., SOLON, OH. SN 78-703,231. PUB. 7-25-2006, FILED 8-30-2005.

Oils by Nature

THE MARK CONSISTS OF STANDARD CHARACTERS WITHOUT CLAIM TO ANY PARTICULAR FONT, STYLE, SIZE, OR COLOR.

NO CLAIM IS MADE TO THE EXCLUSIVE RIGHT TO USE "OILS", APART FROM THE MARK AS SHOWN.

CLASS 1—CHEMICALS

FOR BOTANICAL EXTRACTS FOR USE IN MAKING COSMETICS; CHEMICAL ADDITIVES FOR USE IN THE MANUFACTURE OF COSMETICS (U.S. CLS. 1, 5, 6, 10, 26 AND 46).

FIRST USE 4-10-2002; IN COMMERCE 4-10-2002.

CLASS 3—COSMETICS AND CLEANING PREPARATIONS

FOR BATH OILS FOR COSMETIC PURPOSES; BODY AND BEAUTY CARE COSMETICS; COCOA BUTTER FOR COSMETIC PURPOSES; COSMETIC CREAMS FOR SKIN CARE; COSMETIC OILS; COSMETICS (U.S. CLS. 1, 4, 6, 50, 51 AND 52).

FIRST USE 4-10-2002; IN COMMERCE 4-10-2002.

3,313,857. OILS BY NATURE, INC., SOLON, OH. SN 78-703,253. PUB. 8-8-2006, FILED 8-30-2005.



NO CLAIM IS MADE TO THE EXCLUSIVE RIGHT TO USE "INC.", APART FROM THE MARK AS SHOWN.

THE COLOR(S) GREEN, BLUE AND WHITE IS/ARE CLAIMED AS A FEATURE OF THE MARK.

THE MARK CONSISTS OF THREE GREEN AND WHITE LEAVES ATTACHED TO A SINGLE STEM ABOVE THE WORDING OILSBYNATUREINC. THE DOT OVER THE "I" IN "OILS" IS A GREEN AND WHITE TEAR DROP. THE WORDS "OILS" AND "NATURE" ARE BLUE AND THE WORDS "BY" AND "INC." ARE GREEN.

CLASS 1—CHEMICALS

FOR BOTANICAL EXTRACTS FOR USE IN MAKING COSMETICS; CHEMICAL ADDITIVES FOR USE IN THE MANUFACTURE OF COSMETICS (U.S. CLS. 1, 5, 6, 10, 26 AND 46).

FIRST USE 4-10-2002; IN COMMERCE 4-10-2002.

CLASS 3—COSMETICS AND CLEANING PREPARATIONS

FOR BATH OILS FOR COSMETIC PURPOSES; BODY AND BEAUTY CARE COSMETICS; COCOA BUTTER FOR COSMETIC PURPOSES; COSMETIC CREAMS FOR SKIN CARE; COSMETIC OILS; COSMETICS (U.S. CLS. 1, 4, 6, 50, 51 AND 52).

FIRST USE 4-10-2002; IN COMMERCE 4-10-2002.

3,313,858. THRONEBURG, JAMES L., STATESVILLE, NC. SN 78-703,553. PUB. 5-16-2006, FILED 8-30-2005.



OWNER OF U.S. REG. NOS. 1,119,696, 2,355,257, AND OTHERS.

THE MARK CONSISTS OF THE WORDS THORLOS MILES OF SMILES WITH A REPRESENTATION OF A "SMILE" BESIDE THE WORDS MILES OF SMILES AND UNDER THORLOS.

CLASS 25—CLOTHING

FOR MEN'S, WOMEN'S AND CHILDREN'S SOCKS, SHOES AND FOOTWEAR SYSTEMS COMPRISING SOCKS AND SHOES (U.S. CLS. 22 AND 39).

FIRST USE 5-3-2005; IN COMMERCE 5-3-2005.

CLASS 35—ADVERTISING AND BUSINESS

FOR RETAIL STORE SERVICES AND ON-LINE RETAIL STORE SERVICES VIA THE INTERNET FEATURING MEN'S, WOMEN'S AND CHILDREN'S SOCKS, SHOES AND FOOTWEAR SYSTEMS COMPRISING SOCKS AND SHOES (U.S. CLS. 100, 101 AND 102).

FIRST USE 5-3-2005; IN COMMERCE 5-3-2005.

3,313,859. THRONEBURG, JAMES L., STATESVILLE, NC. SN 78-703,995. PUB. 12-26-2006, FILED 8-31-2005.

THORLOS FOOT FRIENDLY

THE MARK CONSISTS OF STANDARD CHARACTERS WITHOUT CLAIM TO ANY PARTICULAR FONT, STYLE, SIZE, OR COLOR.

OWNER OF U.S. REG. NOS. 1,119,696, 2,355,257, AND OTHERS.

NO CLAIM IS MADE TO THE EXCLUSIVE RIGHT TO USE "FOOT FRIENDLY", APART FROM THE MARK AS

SHOWN.

CLASS 25—CLOTHING

FOR MEN'S, WOMEN'S AND CHILDREN'S SOCKS, SHOES AND FOOTWEAR SYSTEMS COMPRISING SOCKS AND SHOES (U.S. CLS. 22 AND 39).

FIRST USE 2-19-2007; IN COMMERCE 2-19-2007.

CLASS 35—ADVERTISING AND BUSINESS

FOR RETAIL STORE SERVICES AND ON-LINE RETAIL STORE SERVICES VIA THE INTERNET FEATURING MEN'S, WOMEN'S AND CHILDREN'S SOCKS, SHOES AND FOOTWEAR SYSTEMS COMPRISING SOCKS AND SHOES (U.S. CLS. 100, 101 AND 102).

FIRST USE 11-1-2005; IN COMMERCE 11-1-2005.

3,313,861. CURTIS PACKAGING CORPORATION, SANDY HOOK, CT. SN 78-705,376. PUB. 9-5-2006, FILED 9-1-2005.

CURTCHROME

THE MARK CONSISTS OF STANDARD CHARACTERS WITHOUT CLAIM TO ANY PARTICULAR FONT, STYLE, SIZE, OR COLOR.

THE NAME(S), PORTRAIT(S), AND/OR SIGNATURE(S) SHOWN IN THE MARK DOES NOT IDENTIFY A PARTICULAR LIVING INDIVIDUAL.

CLASS 40—MATERIAL TREATMENT

FOR PRINTING AND CUSTOM MANUFACTURE OF CARTONS AND OF PACKAGING FOR OTHERS (U.S. CLS. 100, 103 AND 106).

FIRST USE 12-17-2004; IN COMMERCE 12-17-2004.

CLASS 42—SCIENTIFIC AND COMPUTER SERVICES

FOR CUSTOM DESIGN OF CARTONS AND OF PACKAGING FOR OTHERS (U.S. CLS. 100 AND 101).

FIRST USE 12-17-2004; IN COMMERCE 12-17-2004.

3,313,862. JIANGSU EVER-GLORY INTERNATIONAL GROUP CORPORATION, NANJING, CHINA. SN 78-705,740. PUB. 10-17-2006, FILED 9-1-2005.

EsC'ela V

THE MARK CONSISTS OF STYLIZED ESC'ELA V IN FONT NAME MONOTYPE CORSIVA.

THE FOREIGN WORDING IN THE MARK TRANSLATES INTO ENGLISH AS "THIS IS LIFE".

CLASS 3—COSMETICS AND CLEANING PREPARATIONS

FOR BATH OILS FOR COSMETIC PURPOSES, BODY AND BEAUTY CARE COSMETICS; COSMETICS; COSMETIC SOAPS, FACIAL BEAUTY MASKS, HAIR SHAMPOO, LIPSTICKS, MAKE-UP KITS COMPRISED OF LIPSTICKS, LIP GLOSS, NAIL POLISH, PERFUMES AND COSMETIC CREAMS; NAIL POLISH, PERFUMES, TOOTH PASTE (U.S. CLS. 1, 4, 6, 50, 51 AND 52).

FIRST USE 10-21-2006; IN COMMERCE 10-21-2006.

CLASS 18—LEATHER GOODS

FOR ANIMAL SKINS, BRIEFCASES, BACKPACKS, CARRY-ON BAGS, COSMETIC BAGS SOLD EMPTY, DUFFEL BAGS, SUITCASES AND WALLETS, TRAVEL BAGS, UMBRELLAS (U.S. CLS. 1, 2, 3, 22 AND 41).

FIRST USE 10-21-2006; IN COMMERCE 10-21-2006.

CLASS 25—CLOTHING

FOR BELTS, BELTS MADE OF LEATHER, COATS FOR MEN AND WOMEN, FOOTWEAR FOR MEN AND WOMEN, GLOVES, HATS, HEAD WEAR, INFANT AND TODDLER ONE PIECE CLOTHING, SCARVES, SOCKS, TIES (U.S. CLS. 22 AND 39).

FIRST USE 10-21-2006; IN COMMERCE 10-21-2006.

3,313,869. PANTHERS HOCKEY LLLP, DBA SUNRISE SPORTS & ENTERTAINMENT, SUNRISE, FL. SN 78-708,959. PUB. 8-29-2006, FILED 9-8-2005.



NO CLAIM IS MADE TO THE EXCLUSIVE RIGHT TO USE SPORTS & ENTERTAINMENT, APART FROM THE MARK AS SHOWN.

CLASS 35—ADVERTISING AND BUSINESS

FOR BUSINESS AND ADVERTISING SERVICES, NAMELY HOSTING AND CONDUCTING BUSINESS CONVENTIONS, TRADE SHOWS AND EXHIBITIONS FOR OTHERS IN A WIDE RANGE OF INDUSTRIES AND INTEREST AREAS; PROMOTING BUSINESS CONVENTIONS, SPORTS AND ENTERTAINMENT EVENTS, TRADE SHOWS AND EXHIBITIONS FOR OTHERS IN A WIDE RANGE OF INDUSTRIES AND INTEREST AREAS, INCLUDING VIA THE INTERNET; BUSINESS CONSULTING AND MANAGEMENT SERVICES FOR ARENAS, CONVENTION CENTERS, STADIUMS, THEATRES AND GENERAL PURPOSE FACILITIES; BUSINESS MANAGEMENT SERVICES, RELATING TO FACILITIES MANAGEMENT OF TECHNICAL OPERATIONS; CONCESSION STANDS FEATURING FOOD AND SOUVENIRS; BUSINESS AND EVENT MANAGEMENT OF MUSICAL, THEATRICAL, SPORTS AND FAMILY/VARIETY TOURS AND PRESENTATIONS; MANAGEMENT OF PROFESSIONAL ATHLETES, PROFESSIONAL SPORTS GROUPS AND MEDIA TALENT; BUSINESS MANAGEMENT IN THE NATURE OF SECURING NAMING RIGHTS SPONSORSHIPS AGREEMENTS FOR PROFESSIONAL SPORTS AND COLLEGE ARENAS; RETAIL STORE SERVICES FEATURING SPORTS, ARTIST AND TOUR-RELATED MERCHANDISE, APPAREL, COLLECTIBLES AND MEMORABILIA; ADVERTISING, NAMELY, PROMOTING TICKET SALES AND "VIP" PRIVILEGES FOR LIVE ENTERTAINMENT EVENTS; ADVERTISING, NAMELY, PROMOTING THE SALE OF FANTASY SPORTS AND ENTERTAINMENT PACKAGES; OPERATING SPORTS, ENTERTAINMENT, CONVENTION AND EXHIBITION ARENAS FOR OTHERS (U.S. CLS. 100, 101 AND 102).

FIRST USE 6-13-2005; IN COMMERCE 0-0-2005.

CLASS 41—EDUCATION AND ENTERTAINMENT

FOR HOSTING AND CONDUCTING SPORTS AND ENTERTAINMENT EVENTS IN THE NATURE OF HOCKEY, AND BASKETBALL GAMES, MUSIC CONCERTS AND LIVE PERFORMANCES; EDUCATION AND ENTERTAINMENT SERVICES, NAMELY ORGANIZING CONVENTIONS AND EXHIBITIONS IN THE NATURE OF SPORTING EVENTS, MUSICAL AND DRAMATIC PERFORMANCES AND OTHER GENERAL ENTERTAINMENT; PROVIDING STADIUM SUITES FOR ENTERTAINMENT EVENT VIEWING PURPOSES (U.S. CLS. 100, 101 AND 107).

FIRST USE 6-13-2005; IN COMMERCE 0-0-2005.

CLASS 43—HOTEL AND RESTAURANT SERVICES

FOR LEASING OF ARENA FACILITIES FOR SPORTS, CONVENTIONS AND EXHIBITIONS (U.S. CLS. 100 AND 101).

FIRST USE 6-13-2005; IN COMMERCE 0-0-2005.

3,313,882. TRILEGIANT CORPORATION, NORWALK, CT.
SN 78-713,708. PUB. 9-5-2006, FILED 9-15-2005.



NO CLAIM IS MADE TO THE EXCLUSIVE RIGHT TO USE "VINEYARD", APART FROM THE MARK AS SHOWN.

THE COLOR(S) WOOD-GRAIN SAGE GREEN, PURPLE, GREEN AND BLACK IS/ARE CLAIMED AS A FEATURE OF THE MARK.

THE MARK CONSISTS OF THE STYLIZED WORDS "VINEYARD" IN BLACK AND WOOD-GRAIN SAGE GREEN AND "DIRECT" IN BLACK ALONE, TOGETHER WITH AND BELOW A CLUSTER OF PURPLE GRAPES, IN THE CENTER OF A WOOD-GRAIN SAGE GREEN BROKEN CIRCLE WITH A GREEN LEAF PROTRUDING FROM THE UPPER RIGHT SIDE OF THE CIRCLE.

CLASS 35—ADVERTISING AND BUSINESS

FOR ADMINISTERING A CONSUMER MEMBERSHIP PROGRAM ENABLING PARTICIPANTS TO OBTAIN DISCOUNTS AND INFORMATION ON WINE AND WINE RELATED PRODUCTS AND SERVICES; AND ARRANGING FOR CONSUMERS TO OBTAIN DISCOUNTS ON WINE PURCHASES MADE ONLINE BY COMPUTER, BY MAIL ORDER, BY TELEPHONE AND BY OTHER RETAIL MEANS; PROVIDING INFORMATION ABOUT WINE PURCHASING (U.S. CLS. 100, 101 AND 102).

FIRST USE 6-26-2006; IN COMMERCE 6-26-2006.

CLASS 41—EDUCATION AND ENTERTAINMENT

FOR PROVIDING INFORMATION ON WINE CLASSES AND WINERY TOURS (U.S. CLS. 100, 101 AND 107).

FIRST USE 6-26-2006; IN COMMERCE 6-26-2006.

CLASS 43—HOTEL AND RESTAURANT SERVICES

FOR PROVIDING INFORMATION IN THE FIELD OF WINE, WINE TASTINGS, AND WINE RECIPES (U.S. CLS. 100 AND 101).

FIRST USE 6-26-2006; IN COMMERCE 6-26-2006.

3,313,884. LENTIGEN CORPORATION, BALTIMORE, MD.
SN 78-714,078. PUB. 4-25-2006, FILED 9-15-2005.

LentiMax

THE MARK CONSISTS OF STANDARD CHARACTERS WITHOUT CLAIM TO ANY PARTICULAR FONT, STYLE, SIZE, OR COLOR.

CLASS 5—PHARMACEUTICALS

FOR DIAGNOSTIC PREPARATIONS FOR CLINICAL OR MEDICAL LABORATORY USE; DIAGNOSTIC REAGENTS FOR CLINICAL OR MEDICAL LABORATORY USE (U.S. CLS. 6, 18, 44, 46, 51 AND 52).

FIRST USE 4-3-2006; IN COMMERCE 4-3-2006.

CLASS 40—MATERIAL TREATMENT

FOR CONTRACT MANUFACTURING IN THE FIELD OF BIOCHEMICALS, INCLUDING LENTIVIRAL VECTORS (U.S. CLS. 100, 103 AND 106).

FIRST USE 4-3-2006; IN COMMERCE 4-3-2006.

CLASS 42—SCIENTIFIC AND COMPUTER SERVICES

FOR DEVELOPMENT OF NEW TECHNOLOGY FOR OTHERS IN THE FIELD OF DRUG DISCOVERY AND VALIDATION, GENE EXPRESSION AND DELIVERY, GENOMICS RESEARCH (U.S. CLS. 100 AND 101).

FIRST USE 4-3-2006; IN COMMERCE 4-3-2006.

3,313,889. WHAT I LIKE ABOUT JEW LLC, NEW YORK, NY.
SN 78-715,031. PUB. 6-6-2006, FILED 9-16-2005.

What I Like About Jew

THE MARK CONSISTS OF STANDARD CHARACTERS WITHOUT CLAIM TO ANY PARTICULAR FONT, STYLE, SIZE, OR COLOR.

CLASS 25—CLOTHING

FOR HEADGEAR, NAMELY, HATS, CAPS, AND VISORS; JACKETS; T-SHIRTS (U.S. CLS. 22 AND 39).

FIRST USE 4-1-1998; IN COMMERCE 4-1-1998.

CLASS 41—EDUCATION AND ENTERTAINMENT

FOR ENTERTAINMENT IN THE NATURE OF ON-GOING LIVE THEATRICAL PERFORMANCES AND TELEVISION PROGRAMS IN THE FIELDS OF COMEDY, VARIETY, AND MUSIC; PROVIDING INFORMATION IN THE FIELDS OF COMEDY, VARIETY ENTERTAINMENT, AND MUSIC, ALL ONLINE VIA A GLOBAL COMPUTER NETWORK; ENTERTAINMENT SERVICES, NAMELY, COMMENTARY AND INFORMATION ABOUT THE FIELDS OF COMEDY AND POP CULTURE VIA EMAILED NEWSLETTERS, ON-GOING TELEVISION PROGRAMS, ON-GOING RADIO PROGRAMS AND ON-LINE GLOBAL COMPUTER NETWORK (U.S. CLS. 100, 101 AND 107).

FIRST USE 4-1-1998; IN COMMERCE 4-1-1998.

3,313,896. GLOBAL SECOND LANGUAGE, INC., SAN RAMON, CA. SN 78-717,827. PUB. 2-13-2007, FILED 9-21-2005.

GLOBAL 2ND LANGUAGE

THE MARK CONSISTS OF STANDARD CHARACTERS WITHOUT CLAIM TO ANY PARTICULAR FONT, STYLE, SIZE, OR COLOR.

NO CLAIM IS MADE TO THE EXCLUSIVE RIGHT TO USE "GLOBAL" AND "LANGUAGE", APART FROM THE MARK AS SHOWN.

CLASS 35—ADVERTISING AND BUSINESS

FOR BUSINESS CONSULTATION IN THE FIELD OF CROSS-CULTURAL COMMUNICATIONS (U.S. CLS. 100, 101 AND 102).

FIRST USE 9-21-2005; IN COMMERCE 9-21-2005.

CLASS 41—EDUCATION AND ENTERTAINMENT

FOR DEVELOPMENT AND DISSEMINATION OF EDUCATIONAL MATERIALS OF OTHERS IN THE FIELD OF LANGUAGE AND CROSS-CULTURAL COMMUNICATION; EDUCATION SERVICES, NAMELY PROVIDING TRAINING, CLASSES, SEMINARS AND WORKSHOPS IN THE FIELD OF LANGUAGE ACROSS-CULTURAL COMMUNICATIONS; PROVIDING ONLINE TRAINING IN THE FIELD OF LANGUAGE AND CROSS-CULTURAL COMMUNICATIONS; LANGUAGE TRANSLATION; LANGUAGE INTERPRETING (U.S. CLS. 100, 101 AND 107).

FIRST USE 9-21-2005; IN COMMERCE 9-21-2005.

3,313,906. F3, LLC, LA CANADA FLINTRIDGE, CA. SN 78-723,762. PUB. 9-12-2006, FILED 9-29-2005.

Fumps

THE MARK CONSISTS OF STANDARD CHARACTERS WITHOUT CLAIM TO ANY PARTICULAR FONT, STYLE, SIZE, OR COLOR.

CLASS 9—ELECTRICAL AND SCIENTIFIC APPARATUS

FOR PRE-RECORDED VIDEO CASSETTES AND DVD'S, AUDIO CASSETTES, AND COMPUTER SOFTWARE FOR CHILDREN'S ENTERTAINMENT AND EDUCATIONAL PURPOSES (U.S. CLS. 21, 23, 26, 36 AND 38).

FIRST USE 4-15-2007; IN COMMERCE 1-15-2007.

CLASS 41—EDUCATION AND ENTERTAINMENT

FOR ENTERTAINMENT SERVICES, NAMELY, A CHILDREN'S TELEVISION SERIES, LIVE PERFORMANCES FEATURING COSTUMED CHARACTERS; PRODUCTION OF TELEVISION PROGRAMS AND A TELEVISION SERIES, THEATRICAL PRODUCTIONS; PRODUCTION OF SOUND RECORDINGS, PRODUCTION OF VIDEO RECORDINGS AND VIDEO DISC RECORDINGS, PRODUCTION OF FILMS, PRODUCTION OF COMPACT DISCS AND CD ROMS (U.S. CLS. 100, 101 AND 107).

FIRST USE 4-15-2007; IN COMMERCE 4-15-2007.

3,313,909. GUTHRIE, JANICE M., SOUTHFIELD, MI. SN 78-724,842. PUB. 6-6-2006, FILED 10-2-2005.

Just Say Know

THE MARK CONSISTS OF STANDARD CHARACTERS WITHOUT CLAIM TO ANY PARTICULAR FONT, STYLE, SIZE, OR COLOR.

CLASS 21—HOUSEWARES AND GLASS

FOR MUGS (U.S. CLS. 2, 13, 23, 29, 30, 33, 40 AND 50).

FIRST USE 11-23-2005; IN COMMERCE 12-3-2006.

CLASS 25—CLOTHING

FOR T-SHIRTS (U.S. CLS. 22 AND 39).

FIRST USE 11-23-2005; IN COMMERCE 1-19-2007.

3,313,913. THRONEBURG, JAMES L., STATESVILLE, NC. SN 78-726,808. PUB. 4-25-2006, FILED 10-5-2005.



OWNER OF U.S. REG. NOS. 2,110,029, 2,355,257, AND OTHERS.

THE MARK CONSISTS OF THE WORD THORLOS IN AN OVAL DESIGN.

CLASS 25—CLOTHING

FOR MEN'S, WOMEN'S AND CHILDREN'S SOCKS, SHOES, INSOLES AND FOOT BEDS FOR SHOES, AND FOOTWEAR SYSTEMS COMPRISING SOCKS AND SHOES (U.S. CLS. 22 AND 39).

FIRST USE 3-1-2006; IN COMMERCE 3-1-2006.

CLASS 35—ADVERTISING AND BUSINESS

FOR RETAIL STORE SERVICES AND ON-LINE RETAIL STORE SERVICES VIA THE INTERNET FEATURING MEN'S, WOMEN'S AND CHILDREN'S SOCKS, SHOES, INSOLES AND FOOT BEDS FOR SHOES, AND FOOTWEAR SYSTEMS COMPRISING SOCKS AND SHOES (U.S. CLS. 100, 101 AND 102).

FIRST USE 8-12-2005; IN COMMERCE 8-12-2005.

3,313,923. THE COCA-COLA COMPANY, ATLANTA, GA. SN 78-731,401. PUB. 1-24-2006, FILED 10-12-2005.



OWNER OF U.S. REG. NOS. 22,406, 1,972,602, AND OTHERS.

NO CLAIM IS MADE TO THE EXCLUSIVE RIGHT TO USE "COMPANY" OR "NETWORK", APART FROM THE MARK AS SHOWN.

CLASS 16—PAPER GOODS AND PRINTED MATTER

FOR PRINTED NEWSLETTERS ON THE SUBJECTS OF BEVERAGE INDUSTRY INTERESTS AND CURRENT GOVERNMENTAL ISSUES FACING THE BEVERAGE INDUSTRY FOR EMPLOYEES, SHAREHOLDERS, BOTTLERS, CUSTOMERS, SUPPLIERS AND CONSUMERS (U.S. CLS. 2, 5, 22, 23, 29, 37, 38 AND 50).

FIRST USE 2-9-2006; IN COMMERCE 2-9-2006.

CLASS 35—ADVERTISING AND BUSINESS

FOR ASSOCIATION SERVICES, NAMELY A GRASS-ROOTS NETWORK PROMOTING THE INTERESTS OF THE BEVERAGE INDUSTRY (U.S. CLS. 100, 101 AND 102).

FIRST USE 2-9-2006; IN COMMERCE 2-9-2006.

CLASS 41—EDUCATION AND ENTERTAINMENT

FOR PROVIDING NEWSLETTERS VIA EMAIL FOR EMPLOYEES, SHAREHOLDERS, BOTTLERS, CUSTOMERS, SUPPLIERS AND CONSUMERS IN THE FIELD OF BEVERAGE INDUSTRY INTERESTS AND CURRENT GOVERNMENTAL ISSUES FACING THE BEVERAGE INDUSTRY (U.S. CLS. 100, 101 AND 107).

FIRST USE 2-9-2006; IN COMMERCE 2-9-2006.

3,313,917. GALLIANO MARINE SERVICE, LLC, GALLIANO, LA. SN 78-728,148. PUB. 1-9-2007, FILED 10-6-2005.

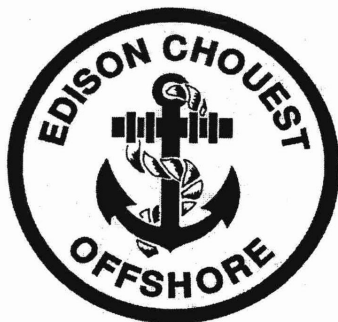

NO CLAIM IS MADE TO THE EXCLUSIVE RIGHT TO USE "OFFSHORE", APART FROM THE MARK AS SHOWN.

THE NAME(S), PORTRAIT(S), AND/OR SIGNATURE(S) SHOWN IN THE MARK IDENTIFIES EDISON CHOUEST, SR., WHOSE CONSENT(S) TO REGISTER IS SUBMITTED.

CLASS 35—ADVERTISING AND BUSINESS

FOR INTEGRATED TRANSPORTATION LOGISTICS, NAMELY, THE ACQUISITION, PLANNING AND SCHEDULING OF MARITIME SHIPMENTS (U.S. CLS. 100, 101 AND 102).

FIRST USE 1-1-2000; IN COMMERCE 1-1-2000.

CLASS 39—TRANSPORTATION AND STORAGE

FOR MARITIME VESSEL SERVICES, NAMELY, THE LOADING AND DISCHARGE OF CARGOES AND MATERIALS OF ALL TYPES, AND THE PROVISION OF MATERIAL HANDLING SERVICES, NAMELY, THE STORING, LOADING AND SHIPMENT OF MATERIALS TO PRIVATE AND PUBLIC CUSTOMERS (U.S. CLS. 100 AND 105).

FIRST USE 1-1-2000; IN COMMERCE 1-1-2000.

3,313,935. TRILEGIANT CORPORATION, NORWALK, CT. SN 78-738,212. PUB. 3-6-2007, FILED 10-21-2005.

SAVOR THE VALUE

THE MARK CONSISTS OF STANDARD CHARACTERS WITHOUT CLAIM TO ANY PARTICULAR FONT, STYLE, SIZE, OR COLOR.

CLASS 35—ADVERTISING AND BUSINESS

FOR ADMINISTERING A CONSUMER MEMBERSHIP PROGRAM ENABLING PARTICIPANTS TO OBTAIN DISCOUNTS AND INFORMATION ON WINE AND WINE RELATED PRODUCTS BY TELEPHONE, ONLINE; AND ARRANGING FOR CONSUMERS TO OBTAIN DISCOUNTS IN WINE PURCHASES MADE ONLINE, MAIL ORDER, AND TELEPHONE (U.S. CLS. 100, 101 AND 102).

FIRST USE 6-26-2006; IN COMMERCE 6-26-2006.

CLASS 40—MATERIAL TREATMENT

FOR PROVIDING INFORMATION ABOUT WINE RECIPES (U.S. CLS. 100, 103 AND 106).
FIRST USE 6-26-2006; IN COMMERCE 6-26-2006.

CLASS 41—EDUCATION AND ENTERTAINMENT

FOR PROVIDING INFORMATION ABOUT WINE TASTINGS, WINE CLASSES AND WINE TOURS (U.S. CLS. 100, 101 AND 107).
FIRST USE 6-26-2006; IN COMMERCE 6-26-2006.

3,313,937. WORKING CHEMICAL SOLUTIONS, INC., EL DORADO, AR. SN 78-739,113. PUB. 9-5-2006, FILED 10-24-2005.

Kennel Guard

THE MARK CONSISTS OF STANDARD CHARACTERS WITHOUT CLAIM TO ANY PARTICULAR FONT, STYLE, SIZE, OR COLOR.

CLASS 3—COSMETICS AND CLEANING PREPARATIONS

FOR ALL-PURPOSE CLEANERS (U.S. CLS. 1, 4, 6, 50, 51 AND 52).
FIRST USE 10-31-2005; IN COMMERCE 10-31-2005.

CLASS 5—PHARMACEUTICALS

FOR HOUSEHOLD DEODORANTS (U.S. CLS. 6, 18, 44, 46, 51 AND 52).
FIRST USE 10-31-2005; IN COMMERCE 10-31-2005.

3,313,939. CAPTAIN HOPE'S KIDS, DALLAS, TX. SN 78-739,254. PUB. 12-19-2006, FILED 10-24-2005.

CAPTAIN HOPE'S KIDS

THE MARK CONSISTS OF STANDARD CHARACTERS WITHOUT CLAIM TO ANY PARTICULAR FONT, STYLE, SIZE, OR COLOR.

NO CLAIM IS MADE TO THE EXCLUSIVE RIGHT TO USE "KIDS", APART FROM THE MARK AS SHOWN. "CAPTAIN HOPE" DOES NOT IDENTIFY A LIVING INDIVIDUAL.

CLASS 35—ADVERTISING AND BUSINESS

FOR CHARITABLE SERVICES, NAMELY, PROVIDING FOR THE CRITICAL NEEDS OF HOMELESS CHILDREN BY COLLECTING AND DISTRIBUTING CONSUMER GOODS SUCH AS CLOTHING, FOOD, DIAPERS, PERSONAL CARE ITEMS, TOILETRIES, SCHOOL SUPPLIES, RECREATIONAL EQUIPMENT, TOYS, AND MEDICATIONS; PROMOTING PUBLIC AWARENESS OF THE NEEDS OF HOMELESS CHILDREN; PROVIDING INFORMATION ABOUT NEEDED GOODS, SERVICES, AND ACTIVITIES BENEFITING HOMELESS CHILDREN (U.S. CLS. 100, 101 AND 102).
FIRST USE 1-0-2001; IN COMMERCE 1-0-2001.

CLASS 36—INSURANCE AND FINANCIAL

FOR CHARITABLE FUNDRAISING; PROVIDING ONLINE DONATION COLLECTION INFORMATION FOR THE BENEFIT OF HOMELESS CHILDREN (U.S. CLS. 100, 101 AND 102).
FIRST USE 1-0-2001; IN COMMERCE 1-0-2001.

3,313,946. TUDOR PLACE FOUNDATION, INC., WASHINGTON, DC. SN 78-740,967. PUB. 9-5-2006, FILED 10-26-2005.



TUDOR PLACE

HISTORIC HOUSE AND GARDEN

NO CLAIM IS MADE TO THE EXCLUSIVE RIGHT TO USE "TUDOR PLACE HISTORIC HOUSE AND GARDEN", APART FROM THE MARK AS SHOWN.

CLASS 16—PAPER GOODS AND PRINTED MATTER

FOR PRINTED MATERIAL AND PUBLICATIONS, NAMELY, NEWSLETTERS AND BOOKLETS IN THE FIELD OF HISTORY, DECORATIVE ARTS, HORTICULTURE AND LANDSCAPE HISTORY; POSTCARDS AND NOTECARDS (U.S. CLS. 2, 5, 22, 23, 29, 37, 38 AND 50).
FIRST USE 6-0-2001; IN COMMERCE 6-0-2001.

CLASS 20—FURNITURE AND ARTICLES NOT OTHERWISE CLASSIFIED

FOR FURNITURE MADE OF WOOD, NAMELY, CHESTS, TABLES, CHAIRS, BOOKCASES, SOFAS (U.S. CLS. 2, 13, 22, 25, 32 AND 50).
FIRST USE 9-0-2001; IN COMMERCE 9-0-2001.

CLASS 39—TRANSPORTATION AND STORAGE

FOR TOUR CONDUCTING SERVICES (U.S. CLS. 100 AND 105).
FIRST USE 6-0-2001; IN COMMERCE 6-0-2001.

CLASS 41—EDUCATION AND ENTERTAINMENT

FOR ENTERTAINMENT SERVICES, NAMELY, LIVE CONCERTS AND MUSICAL PERFORMANCES; EDUCATIONAL SERVICES, NAMELY, LECTURES, WORKSHOPS, GUIDED TOURS OF AN HISTORICAL SITE, FAIRS AND CLASSES, ALL IN THE FIELD OF HISTORY (U.S. CLS. 100, 101 AND 107).
FIRST USE 6-0-2001; IN COMMERCE 6-0-2001.

3,313,954. RUBBERMAID INCORPORATED, ATLANTA, GA. SN 78-742,760. PUB. 9-12-2006, FILED 10-28-2005.

RUBBERMAID

THE MARK CONSISTS OF STANDARD CHARACTERS WITHOUT CLAIM TO ANY PARTICULAR FONT, STYLE, SIZE, OR COLOR.

OWNER OF U.S. REG. NOS. 637,038, 2,283,068, AND OTHERS.

CLASS 6—METAL GOODS

FOR METAL HOUSEHOLD STEP LADDERS (U.S. CLS. 2, 12, 13, 14, 23, 25 AND 50).
FIRST USE 3-1-2006; IN COMMERCE 3-1-2006.

CLASS 12—VEHICLES

FOR NON-MOTORIZED GARDEN CARTS (U.S. CLS. 19, 21, 23, 31, 35 AND 44).
FIRST USE 2-1-2006; IN COMMERCE 2-1-2006.

3,313,962. NOMURA, NAOHIRA, NEW YORK, NY. SN 78-745,124. PUB. 10-10-2006, FILED 11-2-2005.

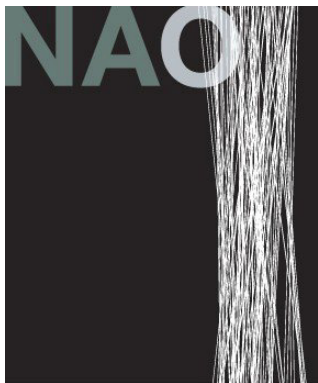

NO CLAIM IS MADE TO THE EXCLUSIVE RIGHT TO USE THE PICTORIAL REPRESENTATION OF THE HAIR, APART FROM THE MARK AS SHOWN.

THE COLOR(S) GREY, SILVER, AND BLACK IS/ARE CLAIMED AS A FEATURE OF THE MARK.

THE COLOR GREY APPEARS IN THE LETTERS NA; THE COLOR SILVER, APPEARS IN THE LETTER O AND IN THE STRANDS OF HAIR; AND THE COLOR BLACK APPEARS IN THE BACKGROUND RECTANGULAR DESIGN.

CLASS 3—COSMETICS AND CLEANING PREPARATIONS

FOR HAIR CARE LOTIONS; HAIR CONDITIONERS; HAIR CREAMS; HAIR GELS; HAIR MOUSSES; HAIR NOURISHERS; HAIR POMADES; HAIR SHAMPOO; HAIR SPRAY; HAIR STYLING GEL; HAIR STYLING PREPARATIONS; HAIR STYLING SPRAY (U.S. CLS. 1, 4, 6, 50, 51 AND 52).
FIRST USE 5-8-2006; IN COMMERCE 5-8-2006.

CLASS 44—MEDICAL, BEAUTY AND AGRICULTURAL SERVICES

FOR HAIR CUTTING; HAIR STYLING; HAIRDRESSING SALONS (U.S. CLS. 100 AND 101).
FIRST USE 5-8-2006; IN COMMERCE 5-8-2006.

3,313,971. MARKETSPACE COMMUNICATIONS, LLC, CRANBERRY TOWNSHIP, PA. SN 78-747,329. PUB. 7-11-2006, FILED 11-4-2005.



NO CLAIM IS MADE TO THE EXCLUSIVE RIGHT TO USE "MARKETSPACE COMMUNICATIONS", APART FROM THE MARK AS SHOWN.

THE COLOR(S) THE PANTONE COLORS USED IN THE MARK ARE RETRO YELLOW GREEN: PMS 397 AND BLUE TEAL: PMS 3145 IS/ARE CLAIMED AS A FEATURE OF THE MARK.

THE MARK CONSISTS OF A TELESCOPIC IMAGE OF PORTIONS OF THREE RETRO YELLOW GREEN BALLS AGAINST A BLUE TEAL BACKGROUND IS LOCATED ABOVE THE "A" IN THE BLUE TEAL WORD "MARKET" AND THE WORDS "SPACE" AND "COMMUNICATIONS" ARE RETRO YELLOW GREEN IN COLOR.

CLASS 35—ADVERTISING AND BUSINESS

FOR ADVERTISING AND MARKETING; BUSINESS CONSULTATION AND MANAGEMENT REGARDING MARKETING ACTIVITIES AND LAUNCHING OF NEW PRODUCTS; DEVELOPMENT OF MARKETING STRATEGIES AND CONCEPTS; GENERAL BUSINESS MERCHANDISING SERVICES, NAMELY, MARKETING (U.S. CLS. 100, 101 AND 102).
FIRST USE 10-1-2005; IN COMMERCE 8-31-2006.

CLASS 42—SCIENTIFIC AND COMPUTER SERVICES

FOR DESIGNING WEBSITES FOR ADVERTISING PURPOSES; GRAPHIC ART DESIGN; GRAPHIC DESIGN SERVICES (U.S. CLS. 100 AND 101).
FIRST USE 10-1-2005; IN COMMERCE 8-31-2006.

3,313,980. SUMMIT LABORATORIES, INC., HARVEY, IL. SN 78-749,312. PUB. 7-18-2006, FILED 11-8-2005.

DR. FRED SUMMIT

THE MARK CONSISTS OF STANDARD CHARACTERS WITHOUT CLAIM TO ANY PARTICULAR FONT, STYLE, SIZE, OR COLOR.

OWNER OF U.S. REG. NOS. 549,398, 828,884, AND 1,141,468.

THE NAME "DR. FRED SUMMIT" DOES NOT IDENTIFY A LIVING INDIVIDUAL.

CLASS 3—COSMETICS AND CLEANING PREPARATIONS

FOR DEPILATORIES; DEPILATORY CREAMS; EXFOLIANTS FOR SKIN; HAIR CARE PREPARATIONS; HAIR CONDITIONERS; SKIN CREAMS; SKIN MOISTURIZER; SKIN TONERS; SKIN WHITENING CREAMS (U.S. CLS. 1, 4, 6, 50, 51 AND 52).

FIRST USE 1-26-2006; IN COMMERCE 1-26-2006.

CLASS 5—PHARMACEUTICALS

FOR HAIR GROWTH STIMULANTS; RUBBING ALCOHOL (U.S. CLS. 6, 18, 44, 46, 51 AND 52).

FIRST USE 1-26-2006; IN COMMERCE 1-26-2006.

3,314,008. FLEETCOR TECHNOLOGIES OPERATING COMPANY, LLC, NORCROSS, GA. SN 78-752,620. PUB. 12-5-2006, FILED 11-11-2005.

FLEETSOURCE

THE MARK CONSISTS OF STANDARD CHARACTERS WITHOUT CLAIM TO ANY PARTICULAR FONT, STYLE, SIZE, OR COLOR.

CLASS 35—ADVERTISING AND BUSINESS

FOR RETAIL GASOLINE SUPPLY SERVICES FOR MOTOR VEHICLE FLEET OWNERS; PREPARING BUSINESS REPORTS FOR THE TRANSPORTATION AND VEHICLE FLEET INDUSTRIES; BILLING AND DATA PROCESSING SERVICES FOR THE TRANSPORTATION AND VEHICLE FLEET INDUSTRIES; BUSINESS MANAGEMENT, INVENTORY CONTROL, AND BOOKKEEPING FOR TRANSPORTATION AND VEHICLE FLEET INDUSTRIES; AND WHOLESALE DISTRIBUTORSHIPS FEATURING MOTOR VEHICLE FUELS, LUBRICANTS, AND PETROLEUM PRODUCTS (U.S. CLS. 100, 101 AND 102).

FIRST USE 1-1-2007; IN COMMERCE 1-1-2007.

CLASS 36—INSURANCE AND FINANCIAL

FOR PROVIDING PAYMENT SERVICES FOR PURCHASING MOTOR FUELS, PETROLEUM PRODUCTS AND FOR VEHICLE MAINTENANCE (U.S. CLS. 100, 101 AND 102).

FIRST USE 1-1-2007; IN COMMERCE 1-1-2007.

CLASS 37—CONSTRUCTION AND REPAIR

FOR MOTOR FUEL AND VEHICLE MAINTENANCE SERVICES TO VEHICLE FLEET OWNERS IN THE NATURE OF AUTOMOBILE SERVICE STATIONS (U.S. CLS. 100, 103 AND 106).

FIRST USE 1-1-2007; IN COMMERCE 1-1-2007.

3,314,007. FLEETCOR TECHNOLOGIES OPERATING COMPANY, LLC, NORCROSS, GA. SN 78-752,612. PUB. 11-14-2006, FILED 11-11-2005.



THE MARK CONSISTS OF THE THREE SQUARE DESIGN NEXT TO THE TERM FLEETSOURCE.

CLASS 35—ADVERTISING AND BUSINESS

FOR RETAIL GASOLINE SUPPLY SERVICES FOR MOTOR VEHICLE FLEET OWNERS; PREPARING BUSINESS REPORTS FOR THE TRANSPORTATION AND VEHICLE FLEET INDUSTRIES; BILLING AND DATA PROCESSING SERVICES FOR THE TRANSPORTATION AND VEHICLE FLEET INDUSTRIES; BUSINESS MANAGEMENT, INVENTORY CONTROL, AND BOOKKEEPING FOR TRANSPORTATION AND VEHICLE FLEET INDUSTRIES; AND WHOLESALE DISTRIBUTORSHIPS FEATURING MOTOR VEHICLE FUELS, LUBRICANTS, AND PETROLEUM PRODUCTS (U.S. CLS. 100, 101 AND 102).

FIRST USE 1-1-2007; IN COMMERCE 1-1-2007.

CLASS 36—INSURANCE AND FINANCIAL

FOR PROVIDING PAYMENT CARD SERVICES FOR PURCHASING MOTOR FUELS, PETROLEUM PRODUCTS AND FOR VEHICLE MAINTENANCE (U.S. CLS. 100, 101 AND 102).

FIRST USE 1-1-2007; IN COMMERCE 1-1-2007.

CLASS 37—CONSTRUCTION AND REPAIR

FOR MOTOR FUEL AND VEHICLE MAINTENANCE SERVICES TO VEHICLE FLEET OWNERS IN THE NATURE OF AUTOMOBILE SERVICE STATIONS (U.S. CLS. 100, 103 AND 106).

FIRST USE 1-1-2007; IN COMMERCE 1-1-2007.

3,314,009. FLEETCOR TECHNOLOGIES OPERATING COMPANY, LLC, NORCROSS, GA. SN 78-752,629. PUB. 12-5-2006, FILED 11-11-2005.

THE FIRST AND ONLY SOURCE FOR GROWING YOUR FLEET BUSINESS

THE MARK CONSISTS OF STANDARD CHARACTERS WITHOUT CLAIM TO ANY PARTICULAR FONT, STYLE, SIZE, OR COLOR.

CLASS 35—ADVERTISING AND BUSINESS

FOR RETAIL GASOLINE SUPPLY SERVICES FOR MOTOR VEHICLE FLEET OWNERS; PREPARING BUSINESS REPORTS FOR THE TRANSPORTATION AND VEHICLE FLEET INDUSTRIES; BILLING AND DATA PROCESSING SERVICES FOR THE TRANSPORTATION AND VEHICLE FLEET INDUSTRIES; BUSINESS MANAGEMENT, INVENTORY CONTROL, AND BOOKKEEPING FOR TRANSPORTATION AND VEHICLE FLEET INDUSTRIES; AND WHOLESALE DISTRIBUTORSHIPS FEATURING MOTOR VEHICLE FUELS, LUBRICANTS, AND PETROLEUM PRODUCTS (U.S. CLS. 100, 101 AND 102).

FIRST USE 1-1-2007; IN COMMERCE 1-1-2007.

CLASS 36—INSURANCE AND FINANCIAL

FOR PROVIDING PAYMENT SERVICES FOR PURCHASING MOTOR FUELS, PETROLEUM PRODUCTS AND OTHER VEHICLE RELATED GOODS AND SERVICES (U.S. CLS. 100, 101 AND 102).
FIRST USE 1-1-2007; IN COMMERCE 1-1-2007.

CLASS 37—CONSTRUCTION AND REPAIR

FOR MOTOR FUEL AND VEHICLE MAINTENANCE SERVICES TO VEHICLE FLEET OWNERS IN THE NATURE OF AUTOMOBILE SERVICE STATIONS (U.S. CLS. 100, 103 AND 106).
FIRST USE 1-1-2007; IN COMMERCE 1-1-2007.

CLASS 25—CLOTHING

FOR CLOTHING, NAMELY, APRONS, ASCOTS, ATHLETIC FOOTWEAR, ATHLETIC SHOES, ATHLETIC UNIFORMS, BANDANAS, BASEBALL CAPS, BATH SLIPPERS, BATHING CAPS, BATHING SUITS, BATHING TRUNKS, BATHROBES, BEACH COVER-UPS, BEACH SHOES, BEACHWEAR, BEANIES, BELTS, BERETS, BERMUDA SHORTS, BIKINIS, BLAZERS, BLOUSES, BODY SHAPERS, BODY SUITS, BOXER SHORTS, BRAS, BRASSIERES, BRIEFS, CAMP SHIRTS, CAPS, CARDIGANS, CHEF'S HATS, WRAP-AROUNDS, COATS, COLLARS, CROP TOPS, CUFFS, DENIM JACKETS, EAR MUFFS, GOLF SHIRTS, GYM SHORTS, HALTER TOPS, HATS, HEAD BANDS, HEADWEAR, INFANTWEAR, JACKETS, JEANS, JOGGING SUITS, LEATHER JACKETS, LEG WARMERS, LEGGINGS, LIGHT-REFLECTING JACKETS, LINGERIE, LOUNGEWEAR, MOCK TURTLE-NECK SWEATERS, MONEY BELTS, MUFFLERS, NECK BANDS, NECKWEAR, NIGHT SHIRTS, PAJAMAS, PANTIES, PANTS, POLO SHIRTS, PONCHOS, PULLOVERS, RAIN JACKETS, SANDALS, SASHES, SCARVES, SHAWLS, SHIRTS, SHOES, SHORTS, SLEEP SHIRTS, SLEEPWEAR, SLIPPERS, SNEAKERS, SOCKS, SPORT COATS, SPORT SHIRTS, SUN VISORS, SWEAT BANDS, SWEAT PANTS, SWEAT SHIRTS, SWEAT SHORTS, SWEAT SUITS, SWEATERS, SWEATSOCKS, SWIM CAPS, SWIM TRUNKS, SWIM WEAR, SWIMMING CAPS, SWIMSUITS, TANK TOPS, T-SHIRTS, VISORS, V-NECK SWEATERS, WIND RESISTANT JACKETS, WRIST BANDS, AND WRISTBANDS CONTAINING A COOLING SUBSTANCE TO COOL THE WEARER (U.S. CLS. 22 AND 39).
FIRST USE 12-30-2005; IN COMMERCE 12-30-2005.

3,314,034. FIESTA PALMS, LLC, LAS VEGAS, NV. SN 78-759,219. PUB. 8-1-2006, FILED 11-22-2005.

CLASS 43—HOTEL AND RESTAURANT SERVICES

FOR HOTEL SERVICES (U.S. CLS. 100 AND 101).
FIRST USE 12-30-2005; IN COMMERCE 12-30-2005.



3,314,035. FIESTA PALMS, LLC, LAS VEGAS, NV. SN 78-759,228. PUB. 8-1-2006, FILED 11-22-2005.

THE CRIB SUITE PALMS LAS VEGAS

OWNER OF U.S. REG. NO. 2,773,483.
NO CLAIM IS MADE TO THE EXCLUSIVE RIGHT TO USE "LAS VEGAS" AS TO INTERNATIONAL CLASSES 25 AND 43 AND "SUITE" AS TO INTERNATIONAL CLASS 43, APART FROM THE MARK AS SHOWN.

THE MARK CONSISTS OF THE WORDS "THE CRIB" WITH THE WORD "SUITE" SIDEWAYS RIGHT AFTER THE WORD "CRIB" IN SMALLER FONT AND THE WORDS "PALMS LAS VEGAS" UNDER THE WORDS "THE CRIB SUITE" IN SMALLER FONT. THE DESIGN HAS THE APPEARANCE OF A STENCIL THAT HAS BEEN SPRAY PAINTED OVER AND GIVES THE EFFECT THAT THE WORDS REMAINED AFTER THE STENCIL WAS REMOVED.

THE MARK CONSISTS OF STANDARD CHARACTERS WITHOUT CLAIM TO ANY PARTICULAR FONT, STYLE, SIZE, OR COLOR.

OWNER OF U.S. REG. NO. 2,773,483.
NO CLAIM IS MADE TO THE EXCLUSIVE RIGHT TO USE "LAS VEGAS" AS TO INTERNATIONAL CLASSES 25 OR 43 OR "SUITE" AS TO INTERNATIONAL CLASS 43, APART FROM THE MARK AS SHOWN.

CLASS 25—CLOTHING

FOR CLOTHING, NAMELY, APRONS, ASCOTS, ATHLETIC FOOTWEAR, ATHLETIC SHOES, ATHLETIC UNIFORMS, BANDANAS, BASEBALL CAPS, BATH SLIPPERS, BATHING CAPS, BATHING SUITS, BATHING TRUNKS, BATHROBES, BEACH COVER-UPS, BEACH SHOES, BEACHWEAR, BEANIES, BELTS, BERTS, BERMUDA SHORTS, BIKINIS, BLAZERS, BLOUSES, BODY SHAPERS, BODY SUITS, BOXER SHORTS, BRAS, BRASSIERES, BRIEFS, CAMP SHIRTS, CAPS, CARDIGANS, CHEF'S HATS, WRAP-AROUNDS, COATS, COLLARS, CROP TOPS, CUFFS, DENIM JACKETS, EAR MUFFS, GOLF SHIRTS, GYM SHORTS, HALTER TOPS, HATS, HEAD BANDS, HEADWEAR, INFANTWEAR, JACKETS, JEANS, JOGGING SUITS, LEATHER JACKETS, LEG WARMERS, LEGGINGS, LIGHT-REFLECTING JACKETS, LINGERIE, LOUNGEWEAR, MOCK TURTLE-NECK SWEATERS, MONEY BELTS, MUFFLERS, NECK BANDS, NECKWEAR, NIGHT SHIRTS, PAJAMAS, PANTIES, PANTS, POLO SHIRTS, PONCHOS, PULLOVERS, RAIN JACKETS, SANDALS, SASHES, SCARVES, SHAWLS, SHIRTS, SHOES, SHORTS, SLEEP SHIRTS, SLEEPWEAR, SLIPPERS, SNEAKERS, SOCKS, SPORT COATS, SPORT SHIRTS, SUN VISORS, SWEAT BANDS, SWEAT PANTS, SWEAT SHIRTS, SWEAT SHORTS, SWEAT SUITS, SWEATERS, SWEATSOCKS, SWIM CAPS, SWIM TRUNKS, SWIM WEAR, SWIMMING CAPS, SWIMSUITS, TANK TOPS, T-SHIRTS, VISORS, V-NECK SWEATERS, WIND RESISTANT JACKETS, WRIST BANDS, AND WRISTBANDS CONTAINING A COOLING SUBSTANCE TO COOL THE WEARER (U.S. CLS. 22 AND 39).
FIRST USE 12-30-2005; IN COMMERCE 12-30-2005.

CLASS 43—HOTEL AND RESTAURANT SERVICES

FOR HOTEL SERVICES (U.S. CLS. 100 AND 101).
FIRST USE 12-30-2005; IN COMMERCE 12-30-2005.

3,314,036. PAN PACIFIC MEDIA INC., SAN FRANCISCO, CA. SN 78-759,739. PUB. 8-8-2006, FILED 11-22-2005.

XVN

THE MARK CONSISTS OF STANDARD CHARACTERS WITHOUT CLAIM TO ANY PARTICULAR FONT, STYLE, SIZE, OR COLOR.

CLASS 35—ADVERTISING AND BUSINESS

FOR DISSEMINATION OF ADVERTISING OF THE GOODS AND SERVICES OF OTHERS VIA A GLOBAL COMMUNICATIONS NETWORK (U.S. CLS. 100, 101 AND 102).
FIRST USE 6-1-2006; IN COMMERCE 6-1-2006.

CLASS 38—COMMUNICATION

FOR ELECTRONIC TRANSMISSION OF ADULT ORIENTED ENTERTAINMENT IN THE NATURE OF STREAMING AUDIO, STREAMING VIDEO, AND STREAMING MEDIA TRANSMITTED VIA A GLOBAL COMMUNICATIONS NETWORK (U.S. CLS. 100, 101 AND 104).
FIRST USE 6-1-2006; IN COMMERCE 6-1-2006.

3,314,045. TTR-IP, INC., HOUSTON, TX. SN 78-761,380. PUB. 8-8-2006, FILED 11-28-2005.



THE COLORS PURPLE, GREEN AND WHITE ARE CLAIMED AS FEATURES OF THE MARK.

THE MARK CONSISTS OF A PURPLE CIRCLE, A LETTER "T" THAT APPEARS ON THE TOP AND THE LETTER "R" THAT APPEARS ON THE RIGHT HAND SIDE IN THE COLOR WHITE, AND THE "T" THAT APPEARS ON THE BOTTOM IS GREEN.

CLASS 35—ADVERTISING AND BUSINESS

FOR FRANCHISING, NAMELY, OFFERING TECHNICAL ASSISTANCE IN THE ESTABLISHMENT AND/OR OPERATION OF RESTAURANT, WINE BAR AND RETAIL STORE; RETAIL STORE SERVICES FEATURING WINE AND WINE-RELATED GOODS (U.S. CLS. 100, 101 AND 102).
FIRST USE 4-1-2006; IN COMMERCE 4-1-2006.

CLASS 43—HOTEL AND RESTAURANT SERVICES

FOR RESTAURANT AND WINE BAR SERVICES (U.S. CLS. 100 AND 101).
FIRST USE 4-1-2006; IN COMMERCE 4-1-2006.

3,314,048. ATSTAFF, INC., DURHAM, NC. SN 78-761,719. PUB. 9-5-2006, FILED 11-28-2005.

CLAIRVIA

THE MARK CONSISTS OF STANDARD CHARACTERS WITHOUT CLAIM TO ANY PARTICULAR FONT, STYLE, SIZE, OR COLOR.

CLASS 9—ELECTRICAL AND SCIENTIFIC APPARATUS

FOR COMPUTER SOFTWARE FOR SCHEDULING MANAGEMENT (U.S. CLS. 21, 23, 26, 36 AND 38).
FIRST USE 1-0-2006; IN COMMERCE 1-0-2006.

CLASS 38—COMMUNICATION

FOR PROVIDING A PORTAL WEBSITE FOR CLIENTS TO ACCESS SECURE WEBSITES WHERE THEY CAN CONDUCT ONLINE SCHEDULING AND STAFFING (U.S. CLS. 100, 101 AND 104).
FIRST USE 1-0-2006; IN COMMERCE 1-0-2006.

CLASS 41—EDUCATION AND ENTERTAINMENT

FOR TRAINING IN THE USE OF SCHEDULING AND STAFFING SOFTWARE SYSTEMS (U.S. CLS. 100, 101 AND 107).

FIRST USE 1-0-2006; IN COMMERCE 1-0-2006.

CLASS 42—SCIENTIFIC AND COMPUTER SERVICES

FOR COMPUTER SERVICES, NAMELY: PROVIDING CUSTOMIZED COMPUTER SOFTWARE INSTALLATION AND CONFIGURATION SERVICES; PROVIDING ON-SITE TECHNICAL ASSISTANCE TO CLIENTS IN INSTALLING SOFTWARE; HOSTING THE WEBSITES OF OTHERS ON A COMPUTER SERVER FOR A GLOBAL COMPUTER NETWORK; PROVIDING CONSULTATION IN THE FIELD OF DESIGN, SELECTION, IMPLEMENTATION AND USE OF COMPUTER HARDWARE AND SOFTWARE SYSTEMS FOR AUTOMATED SCHEDULING AND STAFFING; PROVIDING TECHNICAL CONSULTATION TO OPTIMIZE SCHEDULING AND STAFFING SOFTWARE PERFORMANCE IN CLIENT'S UNIQUE NETWORK ENVIRONMENT; PROVIDING SYSTEM INTEGRATION CONSULTATION TO INTERFACE CLIENT SYSTEM TO OTHER SOFTWARE PRODUCTS AND CUSTOM DESIGN OF INTEGRATION SOFTWARE (U.S. CLS. 100 AND 101).

FIRST USE 1-0-2006; IN COMMERCE 1-0-2006.

3,314,078. PROFESSIONAL BOWLERS ASSOCIATION LLC, SEATTLE, WA. SN 78-765,910. PUB. 10-24-2006, FILED 12-2-2005.



OWNER OF U.S. REG. NOS. 846,434, 2,641,049, AND OTHERS.

NO CLAIM IS MADE TO THE EXCLUSIVE RIGHT TO USE "EST. 1958" AND "ASSOCIATION", APART FROM THE MARK AS SHOWN.

SEC. 2(F) AS TO "PROFESSIONAL BOWLERS ASSOCIATION".

CLASS 25—CLOTHING

FOR CLOTHING, NAMELY, T-SHIRTS, SHIRTS, SWEAT SHIRTS AND HATS (U.S. CLS. 22 AND 39).

FIRST USE 12-9-2005; IN COMMERCE 12-9-2005.

CLASS 35—ADVERTISING AND BUSINESS

FOR ASSOCIATION SERVICES, NAMELY, PROMOTING THE INTERESTS OF BOWLERS; ADVERTISING AND PROMOTION OF BOWLING; RETAIL STORE SERVICES FEATURING BOWLING EQUIPMENT AND BOWLING CLOTHING; COMPUTERIZED ONLINE RETAIL STORE SERVICES FEATURING BOWLING EQUIPMENT AND BOWLING CLOTHING; AND DISTRIBUTORSHIPS FEATURING BOWLING EQUIPMENT AND BOWLING CLOTHING; ARRANGING AND CONDUCTING TRADE SHOWS IN THE FIELD OF BOWLING PRODUCTS AND SERVICES (U.S. CLS. 100, 101 AND 102).

FIRST USE 12-9-2005; IN COMMERCE 12-9-2005.

CLASS 41—EDUCATION AND ENTERTAINMENT

FOR PROVIDING INTERACTIVE ONLINE GAMES; INSTRUCTION IN THE FIELD OF BOWLING; PROVIDING EDUCATIONAL CLASSES AND SEMINARS IN THE FIELD OF BOWLING; ENTERTAINMENT IN THE NATURE OF BOWLING TOURNAMENTS AND COMPETITIONS; PROVIDING INFORMATION IN THE FIELD OF BOWLING; ORGANIZATION OF BOWLING TOURNAMENTS (U.S. CLS. 100, 101 AND 107).

FIRST USE 12-9-2005; IN COMMERCE 12-9-2005.

3,314,050. LEVINE, BLASZAK, BLOCK & BOOTHBY LLP, WASHINGTON, DC. SN 78-761,890. PUB. 8-15-2006, FILED 11-28-2005.

INSIDE WIRE

THE MARK CONSISTS OF STANDARD CHARACTERS WITHOUT CLAIM TO ANY PARTICULAR FONT, STYLE, SIZE, OR COLOR.

CLASS 16—PAPER GOODS AND PRINTED MATTER

FOR NEWSLETTERS IN THE FIELD OF TELECOMMUNICATIONS AND INFORMATION TECHNOLOGY (U.S. CLS. 2, 5, 22, 23, 29, 37, 38 AND 50).

FIRST USE 2-2-2006; IN COMMERCE 2-2-2006.

CLASS 41—EDUCATION AND ENTERTAINMENT

FOR PROVIDING NEWSLETTERS IN THE FIELD OF TELECOMMUNICATIONS AND INFORMATION TECHNOLOGY VIA E-MAIL (U.S. CLS. 100, 101 AND 107).

FIRST USE 2-2-2006; IN COMMERCE 2-2-2006.

3,314,097. J SQUARED SALES INC., ALBERTSON, NY. SN 78-768,489. PUB. 8-1-2006, FILED 12-7-2005.

MASTER BRANDS

THE MARK CONSISTS OF STANDARD CHARACTERS WITHOUT CLAIM TO ANY PARTICULAR FONT, STYLE, SIZE, OR COLOR.

NO CLAIM IS MADE TO THE EXCLUSIVE RIGHT TO USE "BRANDS", APART FROM THE MARK AS SHOWN.

CLASS 29—MEATS AND PROCESSED FOODS

FOR DRIED BEANS; SOUP MIXES (U.S. CL. 46).
FIRST USE 1-18-2006; IN COMMERCE 1-18-2006.

CLASS 30—STAPLE FOODS

FOR ENRICHED RICE; RICE; SPICES; SUGARED BEANS (U.S. CL. 46).
FIRST USE 1-18-2006; IN COMMERCE 1-18-2006.

CLASS 28—TOYS AND SPORTING GOODS

FOR EXERCISE EQUIPMENT FOR ECCENTRIC STRENGTH TRAINING FOR FITNESS, NAMELY, ERGOMETERS, MOTORIZED EXERCISE MACHINES FOR UPPER BODY TRAINING USING ROTATIONAL MOTION, AND MOTORIZED EXERCISE MACHINES FOR LOWER BODY TRAINING USING RECIPROCAL MOTION (U.S. CLS. 22, 23, 38 AND 50).
FIRST USE 3-14-2003; IN COMMERCE 7-30-2005.

3,314,102. JUNO MANUFACTURING, INC., DES PLAINES, IL. SN 78-769,151. PUB. 8-22-2006, FILED 12-8-2005.

3,314,132. AAIPHARMA, INC., WILMINGTON, NC. SN 78-774,604. PUB. 11-21-2006, FILED 12-15-2005.

ALARI

THE MARK CONSISTS OF STANDARD CHARACTERS WITHOUT CLAIM TO ANY PARTICULAR FONT, STYLE, SIZE, OR COLOR.

CLASS 9—ELECTRICAL AND SCIENTIFIC APPARATUS

FOR ELECTRIC VOLTAGE TRANSFORMERS; LIGHTING BALLASTS; ELECTRIC LIGHT SWITCHES; ELECTRIC LIGHT DIMMERS; ELECTRIC LIGHT INTENSITY CONTROLLERS; ELECTRIC WIRE AND CABLE HARNESSES AND MOUNTING BRACKETS (U.S. CLS. 21, 23, 26, 36 AND 38).
FIRST USE 7-1-2006; IN COMMERCE 7-1-2006.

CLASS 11—ENVIRONMENTAL CONTROL APPARATUS

FOR ELECTRIC LIGHTING FIXTURES; FLUORESCENT LIGHTING FIXTURES; LIGHTING FIXTURES; LAMPS; FLUORESCENT LAMPS; LAMP REFLECTORS; LIGHTING TRACKS; SOCKETS FOR ELECTRIC LIGHTS; STRUCTURAL COMPONENTS, FITTINGS AND PARTS OF ELECTRIC LIGHTING FIXTURES, NAMELY, TRIMS, MOUNTS, HANGERS, POSITIONERS, BAFFLES, AND LAMP FITTINGS (U.S. CLS. 13, 21, 23, 31 AND 34).
FIRST USE 7-1-2006; IN COMMERCE 7-1-2006.

3,314,121. ECCENTRON, LLC, DENVER, CO. SN 78-773,165. PUB. 8-22-2006, FILED 12-14-2005.

go ahead. resist.

THE MARK CONSISTS OF STANDARD CHARACTERS WITHOUT CLAIM TO ANY PARTICULAR FONT, STYLE, SIZE, OR COLOR.

CLASS 10—MEDICAL APPARATUS

FOR ECCENTRIC STRENGTH TRAINING EXERCISE MACHINE FOR REHABILITATION PURPOSES (U.S. CLS. 26, 39 AND 44).
FIRST USE 3-14-2003; IN COMMERCE 7-30-2005.

IT'S THE CHEMISTRY

THE MARK CONSISTS OF STANDARD CHARACTERS WITHOUT CLAIM TO ANY PARTICULAR FONT, STYLE, SIZE, OR COLOR.

CLASS 40—MATERIAL TREATMENT

FOR MANUFACTURING OF PHARMACEUTICALS FOR OTHERS (U.S. CLS. 100, 103 AND 106).
FIRST USE 2-28-2006; IN COMMERCE 2-28-2006.

CLASS 42—SCIENTIFIC AND COMPUTER SERVICES

FOR PRODUCT DEVELOPMENT FOR OTHERS OF PHARMACEUTICALS (U.S. CLS. 100 AND 101).
FIRST USE 2-28-2006; IN COMMERCE 2-28-2006.

3,314,138. WASHINGTON SHOE COMPANY, KENT, WA. SN 78-775,483. PUB. 8-22-2006, FILED 12-16-2005.

WEAR A BIG SMILE

CLASS 18—LEATHER GOODS

FOR UMBRELLAS (U.S. CLS. 1, 2, 3, 22 AND 41).
FIRST USE 6-1-1999; IN COMMERCE 6-1-1999.

CLASS 25—CLOTHING

FOR BOOTS; SNOW BOOTS; RUBBER BOOTS; RAIN BOOTS; SHOES; CLOGS; SANDALS; MOCCASINS; SLIPPERS; FOOTWEAR; RAIN COATS; T-SHIRTS; SWEAT-SHIRTS; HATS; RAIN HATS; AND HEADWEAR (U.S. CLS. 22 AND 39).
FIRST USE 6-1-1999; IN COMMERCE 6-1-1999.

3,314,164. KERNEX MICROSYSTEMS (INDIA) LTD, HYDERABAD, INDIA. SN 78-778,855. PUB. 8-22-2006, FILED 12-22-2005.

3,314,194. COMMUNITY REINVESTMENT FUND, INC., MINNEAPOLIS, MN. SN 78-784,976. PUB. 10-24-2006, FILED 1-4-2006.

TRAIN SHIELD

THE MARK CONSISTS OF STANDARD CHARACTERS WITHOUT CLAIM TO ANY PARTICULAR FONT, STYLE, SIZE, OR COLOR.

CLASS 9—ELECTRICAL AND SCIENTIFIC APPARATUS

FOR COMPUTER CHIPSET FOR USE IN TRANSMITTING DATA TO AND FROM A CENTRAL PROCESSING UNIT (U.S. CLS. 21, 23, 26, 36 AND 38).

FIRST USE 3-15-2006; IN COMMERCE 4-21-2006.

CLASS 42—SCIENTIFIC AND COMPUTER SERVICES

FOR SCIENTIFIC RESEARCH AND DEVELOPMENT (U.S. CLS. 100 AND 101).

FIRST USE 3-15-2006; IN COMMERCE 4-21-2006.

3,314,180. LAWLEY, SUSAN MARC, CEDAR GROVE, NJ. SN 78-782,377. PUB. 8-22-2006, FILED 12-29-2005.

Keepsake Conversations

THE MARK CONSISTS OF STANDARD CHARACTERS WITHOUT CLAIM TO ANY PARTICULAR FONT, STYLE, SIZE, OR COLOR.

CLASS 16—PAPER GOODS AND PRINTED MATTER

FOR PRINTED INSTRUCTIONAL AND EDUCATIONAL TEACHING MATERIALS AND MAGAZINES IN THE FIELD OF CREATIVE WRITING (U.S. CLS. 2, 5, 22, 23, 29, 37, 38 AND 50).

FIRST USE 4-12-2003; IN COMMERCE 4-12-2003.

CLASS 41—EDUCATION AND ENTERTAINMENT

FOR EDUCATIONAL SERVICES, NAMELY, CONDUCTING CLASSES, SEMINARS, CONFERENCES AND WORKSHOPS IN THE FIELD OF CREATIVE WRITING (U.S. CLS. 100, 101 AND 107).

FIRST USE 3-10-2003; IN COMMERCE 3-10-2003.

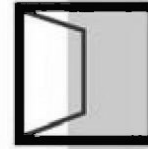

THE MARK CONSISTS OF A DRAWING OF AN OPEN DOOR.

CLASS 35—ADVERTISING AND BUSINESS

FOR BUSINESS CONSULTING SERVICES TO LENDERS IN THE FIELDS OF COMMUNITY AND ECONOMIC DEVELOPMENT LENDING AND SPONSORING OF NEW MARKET TAX CREDIT INCENTIVES (U.S. CLS. 100, 101 AND 102).

FIRST USE 12-31-2005; IN COMMERCE 12-31-2005.

CLASS 36—INSURANCE AND FINANCIAL

FOR FINANCIAL SERVICES, NAMELY, PROVIDING CAPITAL THROUGH THE OPERATION OF A SECONDARY MARKET FOR LOANS, INCLUDING COMMUNITY AND ECONOMIC DEVELOPMENT LOANS; FINANCIAL SERVICES, NAMELY, PROVIDING INVESTORS WITH ASSET-BACKED SECURITIES (U.S. CLS. 100, 101 AND 102).

FIRST USE 12-28-2005; IN COMMERCE 12-28-2005.

CLASS 41—EDUCATION AND ENTERTAINMENT

FOR PROVIDING TRAINING TO LENDERS IN THE FIELDS OF COMMUNITY AND ECONOMIC DEVELOPMENT LENDING AND SPONSORING OF NEW MARKET TAX CREDIT INCENTIVES (U.S. CLS. 100, 101 AND 107).

FIRST USE 12-28-2005; IN COMMERCE 12-28-2005.

3,314,200. A REFRESHING DISCOVERY INC., RALEIGH, NC. SN 78-785,575. PUB. 11-21-2006, FILED 1-5-2006.

CARADERMA

THE MARK CONSISTS OF STANDARD CHARACTERS WITHOUT CLAIM TO ANY PARTICULAR FONT, STYLE, SIZE, OR COLOR.

CLASS 3—COSMETICS AND CLEANING PREPARATIONS

FOR FOAMING FACIAL CLEANSER AND MOISTURIZING CREAM; NON-MEDICATED ACNE CREAM FOR TREATMENT OF VARIETIES OF ACNE INCLUDING ROSEACEA (U.S. CLS. 1, 4, 6, 50, 51 AND 52).

FIRST USE 6-12-2006; IN COMMERCE 6-12-2006.

CLASS 5—PHARMACEUTICALS

FOR ACNE MEDICATED CREAM FOR TREATMENT OF VARIETIES OF ACNE INCLUDING ROSEACEA (U.S. CLS. 6, 18, 44, 46, 51 AND 52).

FIRST USE 6-12-2006; IN COMMERCE 6-12-2006.

3,314,203. PRESS-SENSE LTD., OR AKIVA, ISRAEL. SN 78-786,386. PUB. 8-29-2006, FILED 1-6-2006.

PRESS-SENSE

THE MARK CONSISTS OF STANDARD CHARACTERS WITHOUT CLAIM TO ANY PARTICULAR FONT, STYLE, SIZE, OR COLOR.

CLASS 9—ELECTRICAL AND SCIENTIFIC APPARATUS

FOR COMPUTER SOFTWARE FOR USE IN THE MANAGEMENT, PRODUCTION AND INTEGRATION OF PRINT HOUSE OPERATIONS (U.S. CLS. 21, 23, 26, 36 AND 38).

FIRST USE 9-0-2001; IN COMMERCE 9-0-2001.

CLASS 42—SCIENTIFIC AND COMPUTER SERVICES

FOR INSTALLATION, REPAIR AND MAINTENANCE OF COMPUTER SOFTWARE FOR USE IN THE MANAGEMENT, PRODUCTION AND INTEGRATION OF PRINT HOUSE OPERATIONS (U.S. CLS. 100 AND 101).

FIRST USE 9-0-2001; IN COMMERCE 9-0-2001.

3,314,206. STRATEGICOM, INC., BOZEMAN, MT. SN 78-787,018. PUB. 7-11-2006, FILED 1-7-2006.

FLYING HORSE COMMUNICATION

THE MARK CONSISTS OF STANDARD CHARACTERS WITHOUT CLAIM TO ANY PARTICULAR FONT, STYLE, SIZE, OR COLOR.

NO CLAIM IS MADE TO THE EXCLUSIVE RIGHT TO USE "COMMUNICATION", APART FROM THE MARK AS SHOWN.

CLASS 35—ADVERTISING AND BUSINESS

FOR BUSINESS ORGANIZATION AND MANAGEMENT CONSULTING SERVICES; BUSINESS MARKETING CONSULTING SERVICES; ADVERTISING, MARKETING AND PROMOTION SERVICES; MARKET RESEARCH; PUBLIC RELATIONS; GOVERNMENT RELATIONS; CONCEPT AND BRAND DEVELOPMENT AND MANAGEMENT FOR OTHERS; STRATEGIC PLANNING FOR PUBLIC AND PRIVATE SECTOR CLIENTS (U.S. CLS. 100, 101 AND 102).

FIRST USE 12-16-2005; IN COMMERCE 7-1-2006.

CLASS 41—EDUCATION AND ENTERTAINMENT

FOR MOTION PICTURE FILM PRODUCTION; PRODUCTION OF TELEVISION PROGRAMS FOR OTHERS; MARKETING AND DISTRIBUTION OF FILMS AND TELEVISION PROGRAMS FOR OTHERS (U.S. CLS. 100, 101 AND 107).

FIRST USE 12-16-2005; IN COMMERCE 7-1-2006.

CLASS 42—SCIENTIFIC AND COMPUTER SERVICES

FOR DESIGN AND CREATION OF WEBSITES FOR OTHERS; GRAPHIC DESIGN SERVICES (U.S. CLS. 100 AND 101).

FIRST USE 12-16-2005; IN COMMERCE 7-1-2006.

3,314,210. ENVIRONMENTAL DATA RESOURCES, INC., MILFORD, CT. SN 78-788,074. PUB. 8-8-2006, FILED 1-10-2006.

SAME DAY SANBORNS

THE MARK CONSISTS OF STANDARD CHARACTERS WITHOUT CLAIM TO ANY PARTICULAR FONT, STYLE, SIZE, OR COLOR.

OWNER OF U.S. REG. NOS. 2,330,541, 2,346,303, AND 2,356,664.

CLASS 16—PAPER GOODS AND PRINTED MATTER

FOR MAPS AND REPORTS PERTAINING TO THE ENVIRONMENTAL FIELD (U.S. CLS. 2, 5, 22, 23, 29, 37, 38 AND 50).

FIRST USE 2-1-2007; IN COMMERCE 2-1-2007.

CLASS 42—SCIENTIFIC AND COMPUTER SERVICES

FOR ENVIRONMENTAL RISK ASSESSMENT SERVICES AND ENVIRONMENTAL DATABASE SEARCH SERVICES (U.S. CLS. 100 AND 101).

FIRST USE 2-1-2007; IN COMMERCE 2-1-2007.

3,314,218. NER DATA PRODUCTS, INC., GLASSBORO, NJ. SN 78-789,123. PUB. 10-17-2006, FILED 1-11-2006.

PRINT4

THE MARK CONSISTS OF STANDARD CHARACTERS WITHOUT CLAIM TO ANY PARTICULAR FONT, STYLE, SIZE, OR COLOR.

CLASS 37—CONSTRUCTION AND REPAIR

FOR MAINTENANCE, SERVICING AND REPAIR SERVICES FOR PRINTERS AND FOR PRINTER PARTS AND RELATED ACCESSORIES (U.S. CLS. 100, 103 AND 106).

FIRST USE 1-10-2005; IN COMMERCE 1-10-2005.

CLASS 42—SCIENTIFIC AND COMPUTER SERVICES

FOR TECHNOLOGICAL SUPPORT SERVICES, NAMELY, TROUBLESHOOTING OF PROBLEMS ASSOCIATED WITH COMPUTER PRINTER DEVICES (U.S. CLS. 100 AND 101).

FIRST USE 1-10-2005; IN COMMERCE 1-10-2005.

3,314,222. WHITESPACE SOFTWARE, LLC, SKANEATELES, NY. SN 78-790,095. PUB. 4-10-2007, FILED 1-12-2006.

WEDGE MANAGEMENT

THE MARK CONSISTS OF STANDARD CHARACTERS WITHOUT CLAIM TO ANY PARTICULAR FONT, STYLE, SIZE, OR COLOR.

NO CLAIM IS MADE TO THE EXCLUSIVE RIGHT TO USE "MANAGEMENT", APART FROM THE MARK AS SHOWN.

CLASS 35—ADVERTISING AND BUSINESS

FOR BUSINESS CONSULTING SERVICES IN THE FIELD OF MANAGING BUSINESS ASSETS, MARKETING AND BUSINESS MODEL DEVELOPMENT (U.S. CLS. 100, 101 AND 102).

FIRST USE 11-22-2005; IN COMMERCE 11-22-2005.

CLASS 36—INSURANCE AND FINANCIAL

FOR FINANCIAL AND INVESTMENT CONSULTATION IN THE FIELD OF MANAGING BUSINESS ASSETS (U.S. CLS. 100, 101 AND 102).

FIRST USE 11-22-2005; IN COMMERCE 11-22-2005.

3,314,234. CENTRAL GARDEN & PET COMPANY, WALNUT CREEK, CA. SN 78-792,490. PUB. 9-5-2006, FILED 1-16-2006.

BIOCUBE

THE MARK CONSISTS OF STANDARD CHARACTERS WITHOUT CLAIM TO ANY PARTICULAR FONT, STYLE, SIZE, OR COLOR.

CLASS 11—ENVIRONMENTAL CONTROL APPARATUS

FOR AQUARIUM FILTRATION APPARATUS (U.S. CLS. 13, 21, 23, 31 AND 34).

FIRST USE 6-19-2006; IN COMMERCE 6-19-2006.

CLASS 16—PAPER GOODS AND PRINTED MATTER

FOR AQUARIUMS AND AQUARIUM ACCESSORIES, NAMELY, AQUARIUM TANKS; AQUARIUM STANDS; AQUARIUM CANOPIES; AQUARIUM COVERS; AQUARIUM HOODS (U.S. CLS. 2, 5, 22, 23, 29, 37, 38 AND 50).

FIRST USE 6-19-2006; IN COMMERCE 6-19-2006.

3,314,253. ST. CHARLES TRADING, INC., BATAVIA, IL. SN 78-794,702. PUB. 9-12-2006, FILED 1-19-2006.

BATAVIA MILLS

THE MARK CONSISTS OF STANDARD CHARACTERS WITHOUT CLAIM TO ANY PARTICULAR FONT, STYLE, SIZE, OR COLOR.

NO CLAIM IS MADE TO THE EXCLUSIVE RIGHT TO USE "MILLS", APART FROM THE MARK AS SHOWN.

CLASS 29—MEATS AND PROCESSED FOODS

FOR DRIED FRUITS; PROCESSED COCONUT; PROCESSED EDIBLE SEEDS (U.S. CL. 46).

FIRST USE 2-27-2006; IN COMMERCE 2-27-2006.

CLASS 30—STAPLE FOODS

FOR BAKING SPICES; FLOUR; PROCESSED GRAINS (U.S. CL. 46).

FIRST USE 10-30-2006; IN COMMERCE 4-11-2007.

3,314,266. NATIONAL APARTMENT EXCHANGE, LLC, AUSTIN, TX. SN 78-796,250. PUB. 9-12-2006, FILED 1-20-2006.

NAEX

THE MARK CONSISTS OF STANDARD CHARACTERS WITHOUT CLAIM TO ANY PARTICULAR FONT, STYLE, SIZE, OR COLOR.

CLASS 35—ADVERTISING AND BUSINESS

FOR ADVERTISING AND PUBLICITY SERVICES, NAMELY, PROVIDING A WEB SITE WHEREBY SELLERS LIST REAL ESTATE, AND LOCATE AND RECEIVE BIDS FROM MULTIPLE COMPETITIVE SOURCES ON REAL ESTATE, AND WHEREBY BUYERS IDENTIFY AND BID ON REAL ESTATE; REAL ESTATE AUCTIONS (U.S. CLS. 100, 101 AND 102).

FIRST USE 1-26-2007; IN COMMERCE 1-26-2007.

CLASS 36—INSURANCE AND FINANCIAL

FOR REAL ESTATE SERVICES, NAMELY, CONDUCTING A REAL ESTATE EXCHANGE; AND PROVIDING SALES INFORMATION IN THE NATURE OF REAL ESTATE MARKET QUOTATIONS AND ORDERS; REAL ESTATE SERVICES, NAMELY LISTING OF REAL ESTATE FOR QUOTATION AND SALE AND FOR INFORMATION PURPOSES, AND CLASSIFICATION, ANALYSIS AND REPORTING THEREOF; PROVIDING INVESTMENT INFORMATION IN THE NATURE OF AN APARTMENT EXCHANGE INDEX VIA ELECTRONIC MEANS; REAL ESTATE ACQUISITION, NAMELY, REAL ESTATE BROKERAGE SERVICES; OPERATING MARKETPLACES FOR SELLERS OF REAL ESTATE; REAL ESTATE VALUATION SERVICES; FINANCIAL INVESTMENT IN THE FIELD OF REAL ESTATE; INFORMATION RELATED TO OWNERS, BROKER/DEALERS, REGULATORS AND OTHER REAL ESTATE MARKET PARTICIPANTS; INFORMATION RELATED TO TRANSACTIONS AND REGULATION OF REAL ESTATE MARKETS PROVIDED BY MEANS OF A GLOBAL COMPUTER INFORMATION NETWORK; PROVIDING ONLINE COMPUTER DATABASES FOR CONDUCTING REAL ESTATE EXCHANGE AND BROKERAGE (U.S. CLS. 100, 101 AND 102).

FIRST USE 1-26-2007; IN COMMERCE 1-26-2007.

CLASS 42—SCIENTIFIC AND COMPUTER SERVICES

FOR PROVIDING ONLINE NON-DOWNLOADABLE SOFTWARE FOR DATABASE MANAGEMENT IN THE FIELD OF REAL ESTATE TRANSACTIONS (U.S. CLS. 100 AND 101).

FIRST USE 1-26-2007; IN COMMERCE 1-26-2007.

3,314,268. INTELLIGENT RESULTS, INC., BELLEVUE, WA. SN 78-797,244. PUB. 9-12-2006, FILED 1-23-2006.

PREDIGY

THE MARK CONSISTS OF STANDARD CHARACTERS WITHOUT CLAIM TO ANY PARTICULAR FONT, STYLE, SIZE, OR COLOR.

CLASS 9—ELECTRICAL AND SCIENTIFIC APPARATUS

FOR COMPUTER SOFTWARE, NAMELY, PROGRAMS TO CONTROL, ORGANIZE, ANALYZE AND REPORT INFORMATION FLOW OF STRUCTURED AND UNSTRUCTURED BUSINESS DATA (U.S. CLS. 21, 23, 26, 36 AND 38).

FIRST USE 6-30-2006; IN COMMERCE 6-30-2006.

CLASS 42—SCIENTIFIC AND COMPUTER SERVICES

FOR COMPUTER SERVICES, NAMELY, THE AUTOMATION OF DATA COLLECTION AND ANALYSIS FOR CONVERSION OF UNSTRUCTURED AND STRUCTURED BUSINESS DATA INTO STATISTICAL INFORMATION (U.S. CLS. 100 AND 101).

FIRST USE 7-31-2006; IN COMMERCE 7-31-2006.

3,314,302. SIMON VOLKOV, INC., ORANGE, CA. SN 78-805,266. PUB. 10-17-2006, FILED 2-2-2006.

YOCCAR

THE MARK CONSISTS OF STANDARD CHARACTERS WITHOUT CLAIM TO ANY PARTICULAR FONT, STYLE, SIZE, OR COLOR.

CLASS 35—ADVERTISING AND BUSINESS

FOR ONLINE RETAIL STORE SERVICES FEATURING PARTS AND ACCESSORIES FOR MOTORIZED VEHICLES (U.S. CLS. 100, 101 AND 102).

FIRST USE 8-0-2005; IN COMMERCE 8-0-2005.

CLASS 41—EDUCATION AND ENTERTAINMENT

FOR ONLINE EDUCATIONAL SERVICES, NAMELY, PROVIDING INSTRUCTIONAL VIDEOS FEATURING AUTOMOTIVE PARTS INSTALLATION, COOKING, HOME IMPROVEMENT AND HEALTH AND FITNESS TRAINING VIA THE INTERNET (U.S. CLS. 100, 101 AND 107).

FIRST USE 8-0-2005; IN COMMERCE 8-0-2005.

3,314,307. BELL SPORTS, INC., IRVING, TX. SN 78-806,692. PUB. 8-8-2006, FILED 2-3-2006.

RACE. WIN. LIVE.

THE MARK CONSISTS OF STANDARD CHARACTERS WITHOUT CLAIM TO ANY PARTICULAR FONT, STYLE, SIZE, OR COLOR.

CLASS 9—ELECTRICAL AND SCIENTIFIC APPARATUS

FOR AUTO RACING HELMETS (U.S. CLS. 21, 23, 26, 36 AND 38).

FIRST USE 2-0-2007; IN COMMERCE 2-0-2007.

CLASS 25—CLOTHING

FOR BELTS; CAPS; FOOTWEAR; GLOVES; HATS; HEADWEAR; JACKETS; PANTS; SHIRTS; SHOES; SHORTS; SOCKS; SWEATERS; VESTS; WIND RESISTANT JACKETS (U.S. CLS. 22 AND 39).

FIRST USE 7-0-2006; IN COMMERCE 7-0-2006.

3,314,311. LEMON VISION PRODUCTIONS LLC, TEMECULA, CA. SN 78-807,812. PUB. 9-19-2006, FILED 2-6-2006.

3,314,329. SHEFA FRANCHISES, LTD., MIAMI, FL. SN 78-810,015. PUB. 11-21-2006, FILED 2-8-2006.

LITTLE BUDS

THE MARK CONSISTS OF STANDARD CHARACTERS WITHOUT CLAIM TO ANY PARTICULAR FONT, STYLE, SIZE, OR COLOR.

CLASS 9—ELECTRICAL AND SCIENTIFIC APPARATUS

FOR PRE-RECORDED CHILDREN'S CDS, DVDS, AND VIDEO TAPES FEATURING ENTERTAINMENT AND EDUCATIONAL PROGRAMS (U.S. CLS. 21, 23, 26, 36 AND 38).

FIRST USE 1-26-2006; IN COMMERCE 1-26-2006.

CLASS 16—PAPER GOODS AND PRINTED MATTER

FOR CHILDREN'S BOOKS SERIES (U.S. CLS. 2, 5, 22, 23, 29, 37, 38 AND 50).

FIRST USE 1-26-2006; IN COMMERCE 1-26-2006.

3,314,320. FRANCE, JOHN, MR., WESTLAKE, OH. SN 78-809,141. PUB. 9-19-2006, FILED 2-7-2006.

Jolt Mobile

THE MARK CONSISTS OF STANDARD CHARACTERS WITHOUT CLAIM TO ANY PARTICULAR FONT, STYLE, SIZE, OR COLOR.

NO CLAIM IS MADE TO THE EXCLUSIVE RIGHT TO USE MOBILE, APART FROM THE MARK AS SHOWN.

CLASS 9—ELECTRICAL AND SCIENTIFIC APPARATUS

FOR TELEPHONES, CELLULAR AND MOBILE TELEPHONES, AND APPARATUS, CONNECTORS AND HEADSETS FOR THE FOREGOING (U.S. CLS. 21, 23, 26, 36 AND 38).

FIRST USE 3-1-2006; IN COMMERCE 3-1-2006.

CLASS 38—COMMUNICATION

FOR TELECOMMUNICATIONS SERVICES, NAMELY, LOCAL AND LONG DISTANCE TRANSMISSION OF VOICE, DATA AND GRAPHICS BY MEANS OF TELEPHONE, TELEGRAPHIC, CABLE AND SATELLITE TRANSMISSIONS (U.S. CLS. 100, 101 AND 104).

FIRST USE 3-1-2006; IN COMMERCE 3-1-2006.

AROMA ESPRESSO BAR

THE MARK CONSISTS OF STANDARD CHARACTERS WITHOUT CLAIM TO ANY PARTICULAR FONT, STYLE, SIZE, OR COLOR.

NO CLAIM IS MADE TO THE EXCLUSIVE RIGHT TO USE "ESPRESSO BAR", APART FROM THE MARK AS SHOWN.

CLASS 29—MEATS AND PROCESSED FOODS

FOR MILK-BASED BEVERAGES CONTAINING COFFEE (U.S. CL. 46).

FIRST USE 7-1-2006; IN COMMERCE 7-1-2006.

CLASS 30—STAPLE FOODS

FOR COFFEE, TEA, COCOA, CHOCOLATE AND ESPRESSO BEVERAGES AND BEVERAGES WITH OR WITHOUT MILK MADE WITH A BASE OF COFFEE, COCOA, CHOCOLATE AND ESPRESSO; BAKED GOODS; MUFFINS, COOKIES, CAKES, PASTRIES, BREADS AND SANDWICHES (U.S. CL. 46).

FIRST USE 7-1-2006; IN COMMERCE 7-1-2006.

CLASS 32—LIGHT BEVERAGES

FOR BEVERAGES, NAMELY SODAS, SOFT DRINKS AND FRUIT JUICES (U.S. CLS. 45, 46 AND 48).

FIRST USE 7-1-2006; IN COMMERCE 7-1-2006.

3,314,334. GULF PACIFIC, INC., HOUSTON, TX. SN 78-811,072. PUB. 9-19-2006, FILED 2-9-2006.



NO CLAIM IS MADE TO THE EXCLUSIVE RIGHT TO USE "TEXAS BRAND RICE", APART FROM THE MARK AS SHOWN.

THE STIPPLING IS FOR SHADING PURPOSES ONLY. THE MARK CONSISTS OF A MAN ON A HORSE AND A FIVE POINTED STAR.

CLASS 29—MEATS AND PROCESSED FOODS

FOR DRIED BEANS (U.S. CL. 46).

FIRST USE 6-1-2007; IN COMMERCE 6-1-2007.

CLASS 30—STAPLE FOODS

FOR RICE (U.S. CL. 46).

FIRST USE 6-1-2007; IN COMMERCE 6-1-2007.

CLASS 31—NATURAL AGRICULTURAL PRODUCTS

FOR RAW BEANS (U.S. CLS. 1 AND 46).

FIRST USE 6-1-2007; IN COMMERCE 6-1-2007.

3,314,336. TELSEY ADVISORY GROUP LLC, NEW YORK, NY. SN 78-811,590. PUB. 5-15-2007, FILED 2-9-2006.

THE MARK CONSISTS OF THE STYLIZED LETTERS T WITH AN INVERTED V AND THE LETTER G.

CLASS 9—ELECTRICAL AND SCIENTIFIC APPARATUS

FOR DOWNLOADABLE PUBLICATIONS, NAMELY, BROCHURES, REPORTS, BOOKLETS AND RESEARCH REPORTS IN THE FIELD OF FINANCIAL INVESTMENTS (U.S. CLS. 21, 23, 26, 36 AND 38).
FIRST USE 8-18-2006; IN COMMERCE 8-18-2006.

CLASS 16—PAPER GOODS AND PRINTED MATTER

FOR PUBLICATIONS, NAMELY, BROCHURES, REPORTS, BOOKLETS AND RESEARCH REPORTS IN THE FIELD OF FINANCIAL INVESTMENTS (U.S. CLS. 2, 5, 22, 23, 29, 37, 38 AND 50).
FIRST USE 9-14-2006; IN COMMERCE 9-14-2006.

CLASS 35—ADVERTISING AND BUSINESS

FOR BUSINESS CONSULTATION SERVICES, NAMELY, ARRANGING AND CONDUCTING BUSINESS CONFERENCES; AND PROVIDING INFORMATION ON BUSINESS, CONSUMER AND ECONOMIC TRENDS (U.S. CLS. 100, 101 AND 102).
FIRST USE 9-6-2006; IN COMMERCE 9-6-2006.

CLASS 36—INSURANCE AND FINANCIAL

FOR FINANCIAL SERVICES, NAMELY, PREPARING INVESTMENT RESEARCH REPORTS; PROVIDING FINANCIAL INFORMATION, NAMELY, FINANCIAL ANALYSIS AND CONSULTATION IN THE NATURE OF PROVIDING FINANCIAL MODELS AND ANALYSIS, INVESTMENT RANKINGS AND ANALYSIS, INDUSTRY RESEARCH, COMPANY VALUATIONS AND ANALYSIS (U.S. CLS. 100, 101 AND 102).
FIRST USE 9-14-2006; IN COMMERCE 9-14-2006.

CLASS 41—EDUCATION AND ENTERTAINMENT

FOR ARRANGING AND CONDUCTING INVESTMENT CONFERENCES (U.S. CLS. 100, 101 AND 107).
FIRST USE 9-6-2006; IN COMMERCE 9-6-2006.

NO CLAIM IS MADE TO THE EXCLUSIVE RIGHT TO USE "MATH", APART FROM THE MARK AS SHOWN.

CLASS 9—ELECTRICAL AND SCIENTIFIC APPARATUS

FOR PRERECORDED AUDIO AND VIDEO RECORDINGS FEATURING INSTRUCTION IN MATHEMATICS (U.S. CLS. 21, 23, 26, 36 AND 38).
FIRST USE 4-0-2006; IN COMMERCE 6-0-2006.

CLASS 16—PAPER GOODS AND PRINTED MATTER

FOR PRINTED MATERIALS, NAMELY, BOOKS, MANUALS, WORKBOOKS, TEST AND ANSWER SHEETS, ALL PERTAINING TO THE FIELD OF MATHEMATICS; POSTERS, PAPER STICKERS, SCHOOL WRITING BOOKS AND NOTEBOOKS, FOLDERS, PENCILS, FLASH CARDS (U.S. CLS. 2, 5, 22, 23, 29, 37, 38 AND 50).
FIRST USE 2-0-2005; IN COMMERCE 12-0-2006.

CLASS 18—LEATHER GOODS

FOR BACKPACKS, TOTE BAGS, SCHOOL BAGS (U.S. CLS. 1, 2, 3, 22 AND 41).
FIRST USE 2-0-2006; IN COMMERCE 6-0-2006.

CLASS 25—CLOTHING

FOR CLOTHING, NAMELY, T-SHIRTS AND SWEATSHIRTS; HATS (U.S. CLS. 22 AND 39).
FIRST USE 2-0-2006; IN COMMERCE 6-0-2006.

CLASS 28—TOYS AND SPORTING GOODS

FOR BOARD GAMES, CARD GAMES (U.S. CLS. 22, 23, 38 AND 50).
FIRST USE 6-0-2006; IN COMMERCE 6-0-2006.

CLASS 35—ADVERTISING AND BUSINESS

FOR FRANCHISE SERVICES, NAMELY, OFFERING TECHNICAL AND BUSINESS MANAGEMENT ASSISTANCE IN THE ESTABLISHMENT AND OPERATION OF EDUCATIONAL CENTERS FOR MATHEMATICS INSTRUCTION (U.S. CLS. 100, 101 AND 102).
FIRST USE 5-1-2007; IN COMMERCE 5-1-2007.

CLASS 41—EDUCATION AND ENTERTAINMENT

FOR EDUCATIONAL SERVICES, NAMELY, COURSES IN THE INSTRUCTION OF MATHEMATICS, PROVIDING TUTORING SESSIONS IN THE FIELD OF MATHEMATICS, AND CONDUCTING DISTANCE LEARNING AND INSTRUCTION IN THE FIELD OF MATHEMATICS AT ALL LEVELS, INCLUDING PRIMARY, SECONDARY, COLLEGE, GRADUATE AND POST-GRADUATE; EDUCATIONAL TESTING (U.S. CLS. 100, 101 AND 107).
FIRST USE 1-0-2007; IN COMMERCE 1-0-2007.

3,314,350. SOCRATIC SOLUTIONS, INC., MIAMI, FL. SN 78-814,390. PUB. 9-5-2006, FILED 2-14-2006.

THE MARK CONSISTS OF STANDARD CHARACTERS WITHOUT CLAIM TO ANY PARTICULAR FONT, STYLE, SIZE, OR COLOR.

3,314,410. FMR CORP., BOSTON, MA. SN 78-824,455. PUB. 6-6-2006, FILED 2-27-2006.

THE MARK CONSISTS OF STANDARD CHARACTERS WITHOUT CLAIM TO ANY PARTICULAR FONT, STYLE,

SIZE, OR COLOR.

OWNER OF U.S. REG. NOS. 1,543,851, 3,002,881, AND OTHERS.

NO CLAIM IS MADE TO THE EXCLUSIVE RIGHT TO USE "HR", APART FROM THE MARK AS SHOWN.

CLASS 35—ADVERTISING AND BUSINESS

FOR BUSINESS MANAGEMENT SERVICES IN THE FIELD OF HUMAN RESOURCES; BUSINESS CONSULTATION AND ANALYSIS SERVICES IN THE FIELD OF HUMAN RESOURCES (U.S. CLS. 100, 101 AND 102).

FIRST USE 3-0-2007; IN COMMERCE 3-0-2007.

CLASS 36—INSURANCE AND FINANCIAL

FOR FINANCIAL SERVICES, NAMELY, INVESTMENT MANAGEMENT SERVICES; SECURITIES BROKERAGE SERVICES; RETIREMENT FUND INVESTMENT SERVICES; PROVIDING FINANCIAL INFORMATION IN THE FIELD OF RETIREMENT PLANNING AND IN THE FIELD OF EMPLOYEE BENEFITS; ADMINISTRATION OF RETIREMENT PLANS; ADMINISTRATION OF EMPLOYEE BENEFIT PLANS; ADMINISTRATION OF EMPLOYEE HEALTH AND WELFARE PLANS; ADMINISTRATION OF HEALTH SAVINGS PLANS (U.S. CLS. 100, 101 AND 102).

FIRST USE 3-0-2007; IN COMMERCE 3-0-2007.

3,314,420. FARMS INTERNATIONAL, INC., KNIFE RIVER, MN. SN 78-827,477. PUB. 5-15-2007, FILED 3-2-2006.

DOING GOOD THAT IS GOOD!

THE MARK CONSISTS OF STANDARD CHARACTERS WITHOUT CLAIM TO ANY PARTICULAR FONT, STYLE, SIZE, OR COLOR.

CLASS 36—INSURANCE AND FINANCIAL

FOR PROVIDING AN INTERNET WEBSITE REGARDING HOW INDIVIDUALS AND ORGANIZATIONS CAN DONATE MONEY, AND AT WHICH DONORS CAN DONATE, TO A NON-PROFIT 501(C)(3) MISSION WHICH CARRIES OUT OVERSEAS CHRISTIAN MISSIONS THROUGH USE OF BIBLICAL STEWARDSHIP (U.S. CLS. 100, 101 AND 102).

FIRST USE 8-1-2005; IN COMMERCE 8-1-2005.

CLASS 45—PERSONAL AND LEGAL SERVICES

FOR PROVIDING AN INTERNET WEBSITE REGARDING THE WORK OF A NON-PROFIT 501(C)(3) MISSION WHICH CARRIES OUT OVERSEAS CHRISTIAN MISSIONS THROUGH USE OF BIBLICAL STEWARDSHIP (U.S. CLS. 100 AND 101).

FIRST USE 8-1-2005; IN COMMERCE 8-1-2005.

3,314,422. EMBROIDERY CENTRAL, INC., LOGAN, UT. SN 78-827,882. PUB. 10-24-2006, FILED 3-2-2006.

PolySelect

THE MARK CONSISTS OF STANDARD CHARACTERS WITHOUT CLAIM TO ANY PARTICULAR FONT, STYLE, SIZE, OR COLOR.

CLASS 23—YARNS AND THREADS

FOR EMBROIDERY THREAD; FLAX THREAD AND YARN; LINEN THREAD; MIXED SPUN THREADS AND YARNS; PLASTIC THREAD; PLASTIC THREAD FOR TEXTILE USE; REGENERATED FIBER THREAD AND YARN; SEWING THREAD; SEWING THREAD AND YARN; SEWING THREAD FOR TEXTILE USE; SPUN THREAD; SYNTHETIC FIBER THREAD AND YARN; SYNTHETIC THREAD; THREAD; THREAD FOR TEXTILE USE; THREADS AND YARNS; TWISTED MIXED THREAD AND YARN; TWISTED THREAD; TWISTED THREADS AND YARNS; NEEDLEPOINT KITS, CONSISTING OF THREAD (U.S. CL. 43).

FIRST USE 3-2-2006; IN COMMERCE 10-1-2006.

CLASS 26—FANCY GOODS

FOR THREAD SPOOLS FOR HOLDING SEWING THREADS (U.S. CLS. 37, 39, 40, 42 AND 50).

FIRST USE 3-2-2006; IN COMMERCE 10-1-2006.

3,314,429. MTOCLEAN, INC., INDEPENDENCE, OH. SN 78-828,943. PUB. 11-7-2006, FILED 3-3-2006.

MTOclean

THE MARK CONSISTS OF STANDARD CHARACTERS WITHOUT CLAIM TO ANY PARTICULAR FONT, STYLE, SIZE, OR COLOR.

OWNER OF U.S. REG. NOS. 3,130,999 AND 3,131,074.

CLASS 35—ADVERTISING AND BUSINESS

FOR FRANCHISE SERVICES, NAMELY, OFFERING TECHNICAL AND BUSINESS MANAGEMENT ASSISTANCE IN THE ESTABLISHMENT AND OPERATION OF BUSINESSES ENGAGED IN COMMERCIAL AND RESIDENTIAL CLEANING, MAID AND JANITORIAL SERVICES, AND WINDOW WASHING, AND CARPET, UPHOLSTERY AND DRAPERY CLEANING (U.S. CLS. 100, 101 AND 102).

FIRST USE 6-30-2006; IN COMMERCE 6-30-2006.

CLASS 37—CONSTRUCTION AND REPAIR

FOR AIR DUCT CLEANING SERVICES; CARPET AND RUG CLEANING; CLEANING OF BUILDING EXTERIOR SURFACES; CLEANING OF INDUSTRIAL PREMISES; CLEANING OF RESIDENTIAL HOUSES; CLEANING OF WOOD AND STONE FLOORS, UPHOLSTERY AND DRAPES; JANITORIAL SERVICES; MAID SERVICES; WINDOW CLEANING (U.S. CLS. 100, 103 AND 106).

FIRST USE 6-30-2006; IN COMMERCE 6-30-2006.

3,314,434. TAKKLE, INC., NEW YORK, NY. SN 78-830,189. PUB. 1-9-2007, FILED 3-6-2006.

3,314,444. BELLSOUTH INTELLECTUAL PROPERTY CORPORATION, WILMINGTON, DE. SN 78-832,152. PUB. 9-5-2006, FILED 3-8-2006.

TAKKLE

THE MARK CONSISTS OF STANDARD CHARACTERS WITHOUT CLAIM TO ANY PARTICULAR FONT, STYLE, SIZE, OR COLOR.

CLASS 38—COMMUNICATION

FOR PROVIDING ON-LINE CHAT ROOMS AND ELECTRONIC BULLETIN BOARDS FOR TRANSMISSION OF MESSAGES AMONG AMATEUR ATHLETES IN THE FIELD OF SPORTS AND GENERAL INTEREST (U.S. CLS. 100, 101 AND 104).

FIRST USE 3-14-2006; IN COMMERCE 3-14-2006.

CLASS 41—EDUCATION AND ENTERTAINMENT

FOR ENTERTAINMENT SERVICES, NAMELY, PROVIDING A WEB SITE FEATURING INFORMATION REGARDING AMATEUR ATHLETE SPORTING EVENTS, PERFORMANCE STATISTICS, PHOTOS, VIDEOS, AND PERSONAL PROFILES (U.S. CLS. 100, 101 AND 107).

FIRST USE 3-14-2006; IN COMMERCE 3-14-2006.

CLASS 45—PERSONAL AND LEGAL SERVICES

FOR ONLINE SOCIAL NETWORKING SERVICES FOR AMATEUR ATHLETES (U.S. CLS. 100 AND 101).

FIRST USE 3-14-2006; IN COMMERCE 3-14-2006.

3,314,443. BELLSOUTH INTELLECTUAL PROPERTY CORPORATION, WILMINGTON, DE. SN 78-832,145. PUB. 9-5-2006, FILED 3-8-2006.

DETECT. PREVENT. CURE.

THE MARK CONSISTS OF STANDARD CHARACTERS WITHOUT CLAIM TO ANY PARTICULAR FONT, STYLE, SIZE, OR COLOR.

CLASS 41—EDUCATION AND ENTERTAINMENT

FOR EMPLOYEE ASSISTANCE PROGRAM, NAMELY, PROVIDING EDUCATIONAL WORKSHOPS AND SEMINARS TO EMPLOYEES ON THE SUBJECT OF CANCER (U.S. CLS. 100, 101 AND 107).

FIRST USE 8-1-2001; IN COMMERCE 8-1-2001.

CLASS 44—MEDICAL, BEAUTY AND AGRICULTURAL SERVICES

FOR EMPLOYEE ASSISTANCE PROGRAM, NAMELY, PROVIDING MEDICAL CONSULTATION AND INFORMATION TO EMPLOYEES ON CANCER (U.S. CLS. 100 AND 101).

FIRST USE 8-1-2001; IN COMMERCE 8-1-2001.

LIFE COUNTS TODAY AND ON
THE JOURNEY TOMORROW

THE MARK CONSISTS OF STANDARD CHARACTERS WITHOUT CLAIM TO ANY PARTICULAR FONT, STYLE, SIZE, OR COLOR.

CLASS 41—EDUCATION AND ENTERTAINMENT

FOR EMPLOYEE ASSISTANCE PROGRAM, NAMELY, PROVIDING EDUCATIONAL WORKSHOPS AND SEMINARS TO EMPLOYEES ON THE SUBJECT OF CANCER (U.S. CLS. 100, 101 AND 107).

FIRST USE 8-1-2001; IN COMMERCE 8-1-2001.

CLASS 44—MEDICAL, BEAUTY AND AGRICULTURAL SERVICES

FOR EMPLOYEE ASSISTANCE PROGRAM, NAMELY, PROVIDING MEDICAL CONSULTATION AND INFORMATION TO EMPLOYEES ON CANCER (U.S. CLS. 100 AND 101).

FIRST USE 8-1-2001; IN COMMERCE 8-1-2001.

3,314,454. AMEI TECHNOLOGIES, INC., WILMINGTON, DE. SN 78-834,578. PUB. 10-31-2006, FILED 3-10-2006.

MAKING LIFE BETTER THROUGH
INNOVATIONS IN HEALING

THE MARK CONSISTS OF STANDARD CHARACTERS WITHOUT CLAIM TO ANY PARTICULAR FONT, STYLE, SIZE, OR COLOR.

CLASS 35—ADVERTISING AND BUSINESS

FOR DISTRIBUTORSHIP SERVICES FEATURING ORTHOPEDIC, MEDICAL AND PHYSICAL THERAPY PRODUCTS AND EQUIPMENT (U.S. CLS. 100, 101 AND 102).

FIRST USE 3-0-2006; IN COMMERCE 8-23-2006.

CLASS 41—EDUCATION AND ENTERTAINMENT

FOR EDUCATIONAL SERVICES, NAMELY, PROVIDING TRAINING FOR OTHERS ON THE APPLICATION AND REMOVAL OF MEDICAL EQUIPMENT (U.S. CLS. 100, 101 AND 107).

FIRST USE 3-0-2006; IN COMMERCE 8-23-2006.

3,314,463. CALSOTA SUPPLY, LLC, ST. PAUL, MN. SN 78-836,679. PUB. 5-15-2007, FILED 3-14-2006.

AVIGARD

THE MARK CONSISTS OF STANDARD CHARACTERS WITHOUT CLAIM TO ANY PARTICULAR FONT, STYLE, SIZE, OR COLOR.

CLASS 6—METAL GOODS

FOR METALLIC NETS USED ON AND IN MONUMENTS, BUILDINGS AND OTHER STRUCTURES TO PREVENT ACCESS OR PERCHING BY BIRDS (U.S. CLS. 2, 12, 13, 14, 23, 25 AND 50).
FIRST USE 9-2-2006; IN COMMERCE 9-2-2006.

CLASS 22—CORDAGE AND FIBERS

FOR COMMERCIAL NETS USED ON AND IN MONUMENTS, BUILDINGS AND OTHER STRUCTURES TO PREVENT ACCESS OR PERCHING BY BIRDS; NON-METALLIC NETS USED ON AND IN MONUMENTS, BUILDINGS AND OTHER STRUCTURES TO PREVENT ACCESS OR PERCHING BY BIRDS (U.S. CLS. 1, 2, 7, 19, 22, 42 AND 50).
FIRST USE 9-2-2006; IN COMMERCE 9-2-2006.

3,314,474. HACHETTE BOOK GROUP USA, INC., NEW YORK, NY. SN 78-842,936. PUB. 4-17-2007, FILED 3-22-2006.



T W E L V E

THE MARK CONSISTS OF NUMBER 12 WITH THE WORD TWELVE UNDERNEATH IT IN A SQUARE.

CLASS 9—ELECTRICAL AND SCIENTIFIC APPARATUS

FOR PRE-RECORDED CASSETTES AND DISCS FEATURING FICTION AND NON-FICTION BOOKS ON A VARIETY OF TOPICS (U.S. CLS. 21, 23, 26, 36 AND 38).
FIRST USE 3-7-2007; IN COMMERCE 3-7-2007.

CLASS 16—PAPER GOODS AND PRINTED MATTER

FOR PRINTED MATTER, NAMELY, FICTION AND NON-FICTION BOOKS ON A VARIETY OF TOPICS (U.S. CLS. 2, 5, 22, 23, 29, 37, 38 AND 50).
FIRST USE 3-7-2007; IN COMMERCE 3-7-2007.

CLASS 41—EDUCATION AND ENTERTAINMENT

FOR PUBLISHING SERVICES, NAMELY, PUBLICATION OF BOOKS AND PUBLICATION OF ELECTRONIC BOOKS AND BOOK EXCERPTS (U.S. CLS. 100, 101 AND 107).
FIRST USE 3-7-2007; IN COMMERCE 3-7-2007.

3,314,475. BELLE TIRE DISTRIBUTORS, INC., ALLEN PARK, MI. SN 78-842,998. PUB. 11-7-2006, FILED 3-22-2006.

NITRO-NIZE

THE MARK CONSISTS OF STANDARD CHARACTERS WITHOUT CLAIM TO ANY PARTICULAR FONT, STYLE, SIZE, OR COLOR.

CLASS 35—ADVERTISING AND BUSINESS

FOR RETAIL AUTOMOBILE PARTS AND ACCESSORIES STORES (U.S. CLS. 100, 101 AND 102).
FIRST USE 4-17-2006; IN COMMERCE 4-17-2006.

CLASS 37—CONSTRUCTION AND REPAIR

FOR AUTOMOBILE REPAIR AND MAINTENANCE (U.S. CLS. 100, 103 AND 106).
FIRST USE 4-17-2006; IN COMMERCE 4-17-2006.

3,314,479. COLORTYME, INC., PLANO, TX. SN 78-843,976. PUB. 11-14-2006, FILED 3-23-2006.

YOUR HOMETOWN COLORTYME

THE MARK CONSISTS OF STANDARD CHARACTERS WITHOUT CLAIM TO ANY PARTICULAR FONT, STYLE, SIZE, OR COLOR.

OWNER OF U.S. REG. NOS. 1,872,515, 2,054,385, AND OTHERS.

CLASS 35—ADVERTISING AND BUSINESS

FOR RETAIL STORE SERVICES FEATURING HOME ENTERTAINMENT PRODUCTS, CONSUMER ELECTRONICS, HOME APPLIANCES, FURNITURE, HOME FURNISHINGS, AND COMPUTERS (U.S. CLS. 100, 101 AND 102).
FIRST USE 1-0-2006; IN COMMERCE 1-0-2006.

CLASS 36—INSURANCE AND FINANCIAL

FOR CONSUMER LENDING SERVICES (U.S. CLS. 100, 101 AND 102).
FIRST USE 12-0-2006; IN COMMERCE 12-0-2006.

CLASS 37—CONSTRUCTION AND REPAIR

FOR RENTAL, LEASING, LEASE PURCHASING AND RENTAL-TO-OWN OF HOME APPLIANCES, NAMELY, WASHERS AND DRYERS (U.S. CLS. 100, 103 AND 106).
FIRST USE 1-0-2006; IN COMMERCE 1-0-2006.

CLASS 39—TRANSPORTATION AND STORAGE

FOR RENTAL, LEASING, LEASE PURCHASING AND RENTAL-TO-OWN OF HOME APPLIANCES, NAMELY, REFRIGERATORS (U.S. CLS. 100 AND 105).
FIRST USE 1-0-2006; IN COMMERCE 1-0-2006.

CLASS 41—EDUCATION AND ENTERTAINMENT

FOR RENTAL, LEASING, LEASE PURCHASING AND RENTAL-TO-OWN OF HOME ENTERTAINMENT PRODUCTS AND CONSUMER ELECTRONICS, NAMELY, TELEVISIONS, STEREOS, CAMERAS, CAMCORDERS, DVD PLAYERS AND VIDEO GAME CONSOLES (U.S. CLS. 100, 101 AND 107).
FIRST USE 1-0-2006; IN COMMERCE 1-0-2006.

CLASS 42—SCIENTIFIC AND COMPUTER SERVICES

FOR RENTAL, LEASING, LEASE PURCHASING AND RENTAL-TO-OWN OF COMPUTERS (U.S. CLS. 100 AND 101).
FIRST USE 1-0-2006; IN COMMERCE 1-0-2006.

CLASS 43—HOTEL AND RESTAURANT SERVICES

FOR RENTAL, LEASING, LEASE PURCHASING AND RENTAL-TO-OWN OF FURNITURE; RENTAL, LEASING, LEASE PURCHASING AND RENTAL-TO-OWN OF HOME FURNISHINGS, NAMELY, HOME ENTERTAINMENT CENTERS AND DECORATIVE ACCESSORIES; RENTAL, LEASING, LEASE PURCHASING AND RENTAL-TO-OWN OF HOME APPLIANCES, NAMELY, OVENS AND RANGES (U.S. CLS. 100 AND 101).
FIRST USE 1-0-2006; IN COMMERCE 1-0-2006.

3,314,480. FL FOOD LION, INC., SALISBURY, NC. SN 78-845,122. PUB. 3-20-2007, FILED 3-24-2006.



OWNER OF U.S. REG. NOS. 1,427,887, 2,810,339, AND OTHERS.
NO CLAIM IS MADE TO THE EXCLUSIVE RIGHT TO USE FOOD AND BABY, APART FROM THE MARK AS SHOWN.

CLASS 35—ADVERTISING AND BUSINESS

FOR RETAIL GROCERY STORE SERVICES FEATURING BONUS INCENTIVE PROGRAMS FOR CUSTOMERS TO RECEIVE DISCOUNTS AND DISCOUNT COUPONS ON BABY PRODUCTS (U.S. CLS. 100, 101 AND 102).
FIRST USE 4-0-2006; IN COMMERCE 4-0-2006.

CLASS 44—MEDICAL, BEAUTY AND AGRICULTURAL SERVICES

FOR PROVIDING INFORMATION ON INFANT HEALTH (U.S. CLS. 100 AND 101).
FIRST USE 4-0-2006; IN COMMERCE 4-0-2006.

3,314,495. WESTERFIELD, DINAH BIRD, XENIA, OH. SN 78-850,811. PUB. 11-21-2006, FILED 3-31-2006.

BAKER-BIRD WINERY

THE MARK CONSISTS OF STANDARD CHARACTERS WITHOUT CLAIM TO ANY PARTICULAR FONT, STYLE, SIZE, OR COLOR.

CLASS 33—WINES AND SPIRITS

FOR WINES (U.S. CLS. 47 AND 49).
FIRST USE 11-1-2006; IN COMMERCE 11-1-2006.

CLASS 40—MATERIAL TREATMENT

FOR WINERY SERVICES (U.S. CLS. 100, 103 AND 106).
FIRST USE 11-1-2006; IN COMMERCE 11-1-2006.

3,314,498. 1138, INC., OVERLAND PARK, KS. SN 78-852,669. PUB. 1-2-2007, FILED 4-3-2006.

VALIDITY SCREENING SOLUTIONS

THE MARK CONSISTS OF STANDARD CHARACTERS WITHOUT CLAIM TO ANY PARTICULAR FONT, STYLE, SIZE, OR COLOR.
NO CLAIM IS MADE TO THE EXCLUSIVE RIGHT TO USE "SCREENING SOLUTIONS", APART FROM THE MARK AS SHOWN.

CLASS 44—MEDICAL, BEAUTY AND AGRICULTURAL SERVICES

FOR PROVIDING DRUG TESTING SERVICES IN THE FIELD OF PRE-EMPLOYMENT, SECURITY CLEARANCE, VOLUNTEER WORKERS, CONTRACTOR AND TENANT CHECKS (U.S. CLS. 100 AND 101).
FIRST USE 6-20-2006; IN COMMERCE 6-20-2006.

CLASS 45—PERSONAL AND LEGAL SERVICES

FOR PROVIDING BACKGROUND SCREENING SERVICES IN THE FIELD OF PRE-EMPLOYMENT, SECURITY CLEARANCE, VOLUNTEER WORKERS, CONTRACTOR AND TENANT CHECKS (U.S. CLS. 100 AND 101).

FIRST USE 6-20-2006; IN COMMERCE 6-20-2006.

3,314,499. DREAMWORKS ANIMATION L.L.C., GLENDALE, CA. SN 78-852,803. PUB. 9-5-2006, FILED 4-3-2006.



OWNER OF U.S. REG. NOS. 2,326,951, 2,665,088, AND OTHERS.

THE MARK CONSISTS OF A BOY FISHING IN THE MOON TO THE LEFT OF THE WORD DREAMWORKS.

CLASS 9—ELECTRICAL AND SCIENTIFIC APPARATUS

FOR COMPUTER PERIPHERAL, NAMELY VIDEO GAME CARTRIDGES, PRERECORDED AUDIO CASSETTES FEATURING MOTION PICTURE SOUNDTRACKS, PRERECORDED VIDEO CASSETTES FEATURING ANIMATED MOTION PICTURES, PRERECORDED AUDIO TAPES FEATURING MOTION PICTURE SOUNDTRACKS, PRERECORDED VIDEO TAPES FEATURING ANIMATED MOTION PICTURES, PRERECORDED DISCS FEATURING MUSIC AND MOTION PICTURE SOUND TRACKS; MAGNETS AND SUNGLASSES (U.S. CLS. 21, 23, 26, 36 AND 38).

FIRST USE 5-1-2005; IN COMMERCE 5-1-2005.

CLASS 16—PAPER GOODS AND PRINTED MATTER

FOR PAPER PARTY DECORATIONS; PAPER PARTY SUPPLIES, NAMELY, PAPER PARTY HATS, PAPER NAPKINS, PAPER PLACE MATS, GIFTWRAPPING PAPER AND GIFT WRAPPING RIBBONS, PAPER GIFT WRAP BOWS, PAPER TABLE CLOTHS AND PAPER PARTY BAGS; CHILDREN'S ACTIVITY BOOKS, CHILDREN'S STORYBOOKS, COLORING BOOKS, BOOK MARKS, LOOSE LEAF BINDERS, STATIONERY-TYPE PORTFOLIOS, SPIRAL BOUND NOTEBOOKS, NOTE PADS AND WRITING PADS, DAILY PLANNERS, CALENDARS, SCRAPBOOK ALBUMS, STICKER ALBUMS, STICKERS, DECALS, STAMP PADS AND INKING PADS, RUBBER STAMPS, HEAT APPLIED APPLIQUES MADE OF PAPER, TEMPORARY TATTOOS, SLATEBOARDS FOR WRITING, PENCILS, PENS, PENCIL ERASERS, DECORATIVE PENCIL-TOP ORNAMENTS, PEN CASES AND PENCIL CASES, PEN BOXES AND PENCIL BOXES, PENCIL SHARPENERS, CHALK, MARKERS, POSTERS, TRADING CARDS, GREETING CARDS, PAINTING SETS FOR CHILDREN; ARTS AND CRAFTS PAINT KITS; STUDY KITS, CONSISTING OF PENCIL ERASERS, DRAWING RULERS, PENCIL SHARPENERS AND PENCIL CASE; STATIONERY PACKS CONSISTING OF WRITING PAPER, ENVELOPES, MARKERS, AND STENCILS; AND ACTIVITY KITS CONSISTING OF STICKERS AND STAMPS (U.S. CLS. 2, 5, 22, 23, 29, 37, 38 AND 50).

FIRST USE 5-1-2005; IN COMMERCE 5-1-2005.

CLASS 25—CLOTHING

FOR SHIRTS AND TOPS, DRESSES, SKIRTS, PANTS, JEANS, SHORTS, ROMPERS, SWEATSHIRTS, CAPS AND HATS, GLOVES, TIES, COATS AND JACKETS, HOSIERY, SHOES, BOOTS, SLIPPERS, PAJAMAS, ROBES, SLEEPSHIRTS, SLEEPWEAR, UNDERWEAR, HALLOWEEN COSTUMES (U.S. CLS. 22 AND 39).

FIRST USE 5-1-2006; IN COMMERCE 5-1-2006.

CLASS 28—TOYS AND SPORTING GOODS

FOR ACTION FIGURES AND ACCESSORIES THEREFOR, BATHTUB TOYS, KITES, BOARD GAMES, COSTUME MASKS, HAND-HELD UNIT FOR PLAYING ELECTRONIC GAMES, DOLLS, DOLL ACCESSORIES, DOLL CLOTHING, BEAN BAG DOLLS, BENDABLE PLAY FIGURES, FLYING DISCS, INFLATABLE VINYL PLAY FIGURES, JIGSAW PUZZLES, PLUSH TOYS, PUPPETS, RIDE-ON TOYS, SKATEBOARDS, BALLOONS, ROLLERSKATES, TOY BANKS, WATER SQUIRTING TOYS, STUFFED TOYS, CHRISTMAS TREE ORNAMENTS; AND PLAYING CARDS (U.S. CLS. 22, 23, 38 AND 50).

FIRST USE 5-1-2005; IN COMMERCE 5-1-2005.

CLASS 41—EDUCATION AND ENTERTAINMENT

FOR ENTERTAINMENT SERVICES IN THE NATURE OF THE PRODUCTION OF MOTION PICTURES, TELEVISION PROGRAMS, LASER DISCS, AND VIDEO AND AUDIO TAPES (U.S. CLS. 100, 101 AND 107).

FIRST USE 3-31-2006; IN COMMERCE 3-31-2006.

3,314,508. SOCRATIC SOLUTIONS, INC., MIAMI, FL. SN 78-856,793. PUB. 9-5-2006, FILED 4-7-2006.

GRAB MATH BY THE TAIL

THE MARK CONSISTS OF STANDARD CHARACTERS WITHOUT CLAIM TO ANY PARTICULAR FONT, STYLE, SIZE, OR COLOR.

CLASS 9—ELECTRICAL AND SCIENTIFIC APPARATUS

FOR PRERECORDED AUDIO AND VIDEO RECORDINGS FEATURING INSTRUCTION IN MATHEMATICS (U.S. CLS. 21, 23, 26, 36 AND 38).

FIRST USE 4-0-2006; IN COMMERCE 6-0-2006.

CLASS 16—PAPER GOODS AND PRINTED MATTER

FOR PRINTED MATERIALS, NAMELY, BOOKS, MANUALS, WORKBOOKS, TEST AND ANSWER SHEETS, ALL PERTAINING TO THE FIELD OF MATHEMATICS; POSTERS, PAPER STICKERS, SCHOOL WRITING BOOKS AND NOTEBOOKS, FOLDERS, PENCILS, FLASH CARDS (U.S. CLS. 2, 5, 22, 23, 29, 37, 38 AND 50).

FIRST USE 2-0-2005; IN COMMERCE 12-0-2006.

CLASS 18—LEATHER GOODS

FOR BACKPACKS, TOTE BAGS, SCHOOL BAGS (U.S. CLS. 1, 2, 3, 22 AND 41).

FIRST USE 2-0-2006; IN COMMERCE 6-0-2006.

CLASS 25—CLOTHING

FOR CLOTHING, NAMELY, T-SHIRTS AND SWEAT-SHIRTS; HATS (U.S. CLS. 22 AND 39).
FIRST USE 2-0-2006; IN COMMERCE 6-0-2006.

CLASS 28—TOYS AND SPORTING GOODS

FOR STUFFED TOY ANIMALS, BOARD GAMES, CARD GAMES (U.S. CLS. 22, 23, 38 AND 50).
FIRST USE 6-0-2006; IN COMMERCE 6-0-2006.

CLASS 35—ADVERTISING AND BUSINESS

FOR FRANCHISE SERVICES, NAMELY, OFFERING TECHNICAL AND BUSINESS MANAGEMENT ASSISTANCE IN THE ESTABLISHMENT AND OPERATION OF EDUCATIONAL CENTERS FOR MATHEMATICS INSTRUCTION (U.S. CLS. 100, 101 AND 102).
FIRST USE 1-0-2007; IN COMMERCE 1-0-2007.

CLASS 41—EDUCATION AND ENTERTAINMENT

FOR EDUCATIONAL SERVICES, NAMELY, COURSES IN THE INSTRUCTION OF MATHEMATICS, PROVIDING TUTORING SESSIONS IN THE FIELD OF MATHEMATICS, AND CONDUCTING DISTANCE LEARNING AND INSTRUCTION IN THE FIELD OF MATHEMATICS AT ALL LEVELS, INCLUDING PRIMARY, SECONDARY, COLLEGE, GRADUATE AND POST-GRADUATE; EDUCATIONAL TESTING (U.S. CLS. 100, 101 AND 107).
FIRST USE 1-0-2007; IN COMMERCE 1-0-2007.

3,314,518. LES SCHWAB WAREHOUSE CENTER, INC., PRINEVILLE, OR. SN 78-860,854. PUB. 11-21-2006, FILED 4-13-2006.

YOU ARE THE REASON

THE MARK CONSISTS OF STANDARD CHARACTERS WITHOUT CLAIM TO ANY PARTICULAR FONT, STYLE, SIZE, OR COLOR.

CLASS 35—ADVERTISING AND BUSINESS

FOR RETAIL STORE SERVICES FOR LAND VEHICLE AND BOAT PARTS AND ACCESSORIES (U.S. CLS. 100, 101 AND 102).
FIRST USE 9-0-2005; IN COMMERCE 9-0-2005.

CLASS 37—CONSTRUCTION AND REPAIR

FOR LAND VEHICLE REPAIR AND MAINTENANCE (U.S. CLS. 100, 103 AND 106).
FIRST USE 9-0-2005; IN COMMERCE 9-0-2005.

3,314,538. HARBINGER TECHNOLOGIES GROUP, MCLEAN, VA. SN 78-868,676. PUB. 11-21-2006, FILED 4-25-2006.

UniTran

THE MARK CONSISTS OF STANDARD CHARACTERS WITHOUT CLAIM TO ANY PARTICULAR FONT, STYLE, SIZE, OR COLOR.

CLASS 9—ELECTRICAL AND SCIENTIFIC APPARATUS

FOR COMPUTER PROGRAMS FOR SEARCHING THE CONTENTS OF COMPUTERS AND COMPUTER NETWORKS BY REMOTE CONTROL; COMPUTER SEARCH ENGINE SOFTWARE; COMPUTER SOFTWARE FOR APPLICATION AND DATABASE INTEGRATION; COMPUTER SOFTWARE FOR COMMUNICATING WITH USERS OF HAND-HELD COMPUTERS; COMPUTER SOFTWARE FOR TRANSLITERATED WORD SEARCHING; ENTERPRISE SOFTWARE IN THE NATURE OF A DATABASE FOR NON-TRANSACTIONAL DATA AND A SEARCH ENGINE FOR DATABASE CONTENT (U.S. CLS. 21, 23, 26, 36 AND 38).
FIRST USE 6-15-2006; IN COMMERCE 6-15-2006.

CLASS 42—SCIENTIFIC AND COMPUTER SERVICES

FOR COMPUTER SERVICE, NAMELY, ACTING AS AN APPLICATION SERVICE PROVIDER IN THE FIELD OF KNOWLEDGE MANAGEMENT TO HOST COMPUTER APPLICATION SOFTWARE FOR SEARCHING AND RETRIEVING INFORMATION FROM DATABASES AND COMPUTER NETWORKS; COMPUTER SERVICES, NAMELY, PROVIDING SEARCH ENGINES FOR OBTAINING DATA ON A GLOBAL COMPUTER NETWORK; PROVIDING CUSTOMIZED ON-LINE WEB PAGES FEATURING USER-DEFINED INFORMATION, WHICH INCLUDES SEARCH ENGINES AND ON-LINE WEB LINKS TO OTHER WEB SITES; PROVIDING SPECIFIC INFORMATION AS REQUESTED BY CUSTOMERS VIA THE INTERNET (U.S. CLS. 100 AND 101).
FIRST USE 6-15-2006; IN COMMERCE 6-15-2006.

3,314,555. HEALING PATHS, LLC, RESTON, VA. SN 78-875,370. PUB. 1-23-2007, FILED 5-3-2006.

SMILE

THE MARK CONSISTS OF STANDARD CHARACTERS WITHOUT CLAIM TO ANY PARTICULAR FONT, STYLE, SIZE, OR COLOR.

CLASS 41—EDUCATION AND ENTERTAINMENT

FOR EDUCATION SERVICES, NAMELY, CONDUCTING CLASSES, SEMINARS, CONFERENCES, WORKSHOPS AND INDIVIDUAL, PERSONAL LESSONS IN THE FIELDS OF SPIRITUALITY, HEALING AND WELLNESS (U.S. CLS. 100, 101 AND 107).
FIRST USE 6-29-2007; IN COMMERCE 6-29-2007.

CLASS 44—MEDICAL, BEAUTY AND AGRICULTURAL SERVICES

FOR COUNSELING SERVICES IN THE FIELDS OF HEALING AND WELLNESS (U.S. CLS. 100 AND 101).
FIRST USE 6-29-2007; IN COMMERCE 6-29-2007.

CLASS 45—PERSONAL AND LEGAL SERVICES

FOR COUNSELING SERVICES IN THE FIELD OF SPIRITUALITY (U.S. CLS. 100 AND 101).
FIRST USE 6-29-2007; IN COMMERCE 6-29-2007.

3,314,556. OHIO FARMERS INSURANCE COMPANY, WESTFIELD CENTER, OH. SN 78-875,704. PUB. 12-12-2006, FILED 5-3-2006.

WesCare

THE MARK CONSISTS OF STANDARD CHARACTERS WITHOUT CLAIM TO ANY PARTICULAR FONT, STYLE, SIZE, OR COLOR.

CLASS 35—ADVERTISING AND BUSINESS

FOR INSURANCE CLAIMS AUDITING SERVICES; CONSULTING TO COMPANIES IN THE AREA OF MEDICAL CARE MANAGEMENT, NAMELY, PROVIDING MEDICAL REFERRALS, MEDICAL PRE-CERTIFICATION, PROVIDING CONSUMER INFORMATION SERVICES AND REFERRALS TO COMPANIES AND EMPLOYEES IN THE FIELDS OF MEDICAL SERVICES, MEDICAL EQUIPMENT AND DRUG PRESCRIPTIONS (U.S. CLS. 100, 101 AND 102).

FIRST USE 5-1-2006; IN COMMERCE 5-1-2006.

CLASS 36—INSURANCE AND FINANCIAL

FOR INSURANCE SERVICES, NAMELY, WRITING WORKERS' COMPENSATION INSURANCE POLICIES; ADMINISTRATION AND PROCESSING OF INSURANCE CLAIMS FOR CLIENTS; CONSULTING TO COMPANIES IN THE AREA OF RISK CONTROL (U.S. CLS. 100, 101 AND 102).

FIRST USE 5-1-2006; IN COMMERCE 5-1-2006.

CLASS 41—EDUCATION AND ENTERTAINMENT

FOR CONSULTING TO COMPANIES IN THE AREA OF TRANSITIONING EMPLOYEES BACK TO WORK, NAMELY, CAREER COUNSELING (U.S. CLS. 100, 101 AND 107).

FIRST USE 5-1-2006; IN COMMERCE 5-1-2006.

CLASS 42—SCIENTIFIC AND COMPUTER SERVICES

FOR LEGAL SERVICES, NAMELY, MANAGING LITIGATION; CONSULTING TO COMPANIES IN THE AREA OF MANAGING LITIGATION, NAMELY, LITIGATION CONSULTANCY AND LITIGATION SUPPORT SERVICES (U.S. CLS. 100 AND 101).

FIRST USE 5-1-2006; IN COMMERCE 5-1-2006.

CLASS 44—MEDICAL, BEAUTY AND AGRICULTURAL SERVICES

FOR CONSULTING TO COMPANIES IN THE AREA OF TRANSITIONING EMPLOYEES BACK TO WORK, NAMELY, PSYCHOLOGICAL COUNSELING AND PHYSICAL THERAPY (U.S. CLS. 100 AND 101).
FIRST USE 5-1-2006; IN COMMERCE 5-1-2006.

CLASS 45—PERSONAL AND LEGAL SERVICES

FOR CONSULTING TO COMPANIES IN THE AREA OF INVESTIGATING FRAUD, NAMELY, FRAUD INVESTIGATION IN THE FIELD OF INSURANCE (U.S. CLS. 100 AND 101).

FIRST USE 5-1-2006; IN COMMERCE 5-1-2006.

3,314,561. BIG BRASS, LAKE FOREST, CA. SN 78-877,475. PUB. 12-26-2006, FILED 5-5-2006.

BIG BRASS

THE MARK CONSISTS OF STANDARD CHARACTERS WITHOUT CLAIM TO ANY PARTICULAR FONT, STYLE, SIZE, OR COLOR.

NO CLAIM IS MADE TO THE EXCLUSIVE RIGHT TO USE "BRASS" IN CLASS 35, APART FROM THE MARK AS SHOWN.

CLASS 25—CLOTHING

FOR BEANIES; CAPS; HATS; JACKETS; PANTS; SWEAT SHIRTS; T-SHIRTS (U.S. CLS. 22 AND 39).
FIRST USE 6-1-2006; IN COMMERCE 6-1-2006.

CLASS 35—ADVERTISING AND BUSINESS

FOR RETAIL STORES FEATURING CLOTHING AND MUSICAL MERCHANDISE, NAMELY MOUTHPIECES, INSTRUMENT CASES, INSTRUMENT BAGS, MUSIC STANDS, AND INSTRUMENTS (U.S. CLS. 100, 101 AND 102).

FIRST USE 6-1-2006; IN COMMERCE 6-1-2006.

3,314,571. JJ TRADING COMPANY LLC, BOISE, ID. SN 78-879,643. PUB. 12-5-2006, FILED 5-9-2006.



NO CLAIM IS MADE TO THE EXCLUSIVE RIGHT TO USE "GEMSTONE DIRECT", APART FROM THE MARK AS SHOWN.

THE APPLICANT CLAIMS COLOR AS A FEATURE OF THE MARK, NAMELY, BLUE, YELLOW, GREEN, PURPLE, RED, GRAY, ORANGE, BLACK AND WHITE.

THE MARK CONSISTS OF EIGHT COLORED BALLS WITH A LETTER FROM THE WORD GEMSTONE IN EACH BALL. A BLUE SWOOPING LINE THROUGH THE GEM-

STONE COLORED BALLS WITH A BLUE BALL ABOVE THE LINE. THE COLOR BLUE APPEARS BEHIND THE LETTERS G AND THE FINAL E. THE COLOR YELLOW APPEARS BEHIND THE FIRST LETTER E. THE COLOR GREEN APPEARS BEHIND THE LETTER M. THE COLOR PURPLE APPEARS BEHIND THE LETTER S. THE COLOR RED APPEARS BEHIND THE LETTER T. THE COLOR GRAY APPEARS BEHIND THE LETTER O. THE COLOR ORANGE APPEARS BEHIND THE LETTER N. THE COLOR WHITE APPEARS IN THE BACKGROUND AND AS HIGHLIGHTING ON THE SPHERES AND THE SWOOPING LINE. THE LETTERS APPEAR IN BLACK.

CLASS 14—JEWELRY

FOR (BASED ON USE IN COMMERCE) BRACELETS; JEWELRY; JEWELRY CHAINS; PRECIOUS GEMSTONES; SEMI-PRECIOUS GEMSTONES; (BASED ON INTENT TO USE) BEADS FOR USE IN THE MANUFACTURE OF JEWELRY; COSTUME JEWELRY; IDENTIFICATION BRACELETS; JEWELRY BOXES OF PRECIOUS METAL; JEWELRY CASES OF PRECIOUS METAL; JEWELRY CASKETS OF PRECIOUS METAL; JEWELRY FOR THE HEAD; JEWELRY PINS FOR USE ON HATS; JEWELRY WATCHES; JEWELRY, NAMELY, AMULETS; JEWELRY, NAMELY, CROSSES; LAPEL PINS; PINS BEING JEWELRY; RINGS BEING JEWELRY (U.S. CLS. 2, 27, 28 AND 50).

FIRST USE 12-1-2005; IN COMMERCE 12-1-2005.

CLASS 35—ADVERTISING AND BUSINESS

FOR (BASED ON USE IN COMMERCE) VENDING IN THE FIELD OF JEWELRY; (BASED ON INTENT TO USE) MAIL ORDER SERVICES FEATURING JEWELRY; RETAIL JEWELRY STORES; STREET VENDOR SERVICES FEATURING JEWELRY; WHOLESALE STORES FEATURING JEWELRY (U.S. CLS. 100, 101 AND 102).

FIRST USE 12-1-2005; IN COMMERCE 12-1-2005.

3,314,576. COMPOUND PROFIT CORP., MCKINNEY, TX. SN 78-881,114. PUB. 3-20-2007, FILED 5-11-2006.

COMPOUND PROFIT

THE MARK CONSISTS OF STANDARD CHARACTERS WITHOUT CLAIM TO ANY PARTICULAR FONT, STYLE, SIZE, OR COLOR.

CLASS 35—ADVERTISING AND BUSINESS

FOR BUSINESS MARKETING SERVICES, NAMELY, PROVIDING TELEMARKETING AND DIRECT MAIL ADVERTISING FOR BUSINESSES (U.S. CLS. 100, 101 AND 102).

FIRST USE 4-23-2006; IN COMMERCE 4-23-2006.

CLASS 36—INSURANCE AND FINANCIAL

FOR FINANCIAL SERVICES, NAMELY, ACCOUNTS RECEIVABLE FINANCING, BUSINESS FINANCE PROCUREMENT SERVICES, SALES FINANCING, EQUIPMENT FINANCING AND CAPITAL FINANCING (U.S. CLS. 100, 101 AND 102).

FIRST USE 4-23-2006; IN COMMERCE 4-23-2006.

3,314,579. MARKEL, HEATHER J, NEW YORK, NY. SN 78-881,760. PUB. 6-5-2007, FILED 5-11-2006.

Mrs. Matrimony

THE MARK CONSISTS OF STANDARD CHARACTERS WITHOUT CLAIM TO ANY PARTICULAR FONT, STYLE, SIZE, OR COLOR.

CLASS 41—EDUCATION AND ENTERTAINMENT

FOR ON-LINE JOURNALS, NAMELY, BLOGS IN THE FIELD OF WEDDINGS AND WEDDING PLANNING; PROVIDING ON-LINE PUBLICATIONS IN THE NATURE OF NEWSLETTER AND ARTICLES IN THE FIELD OF WEDDINGS AND WEDDING PLANNING (U.S. CLS. 100, 101 AND 107).

FIRST USE 12-15-2005; IN COMMERCE 12-15-2005.

CLASS 45—PERSONAL AND LEGAL SERVICES

FOR PROVIDING ADVICE TO WOMEN IN THE FIELD OF PERSONAL SUPPORT SERVICES RELATED TO COPING WITH EMOTIONAL STRESS OF WEDDING PLANNING AND TRANSITIONING FROM SINGLEHOOD TO MARRIAGE; AS WELL AS MARRIAGE COUNSELING (U.S. CLS. 100 AND 101).

FIRST USE 12-15-2005; IN COMMERCE 12-15-2005.

3,314,587. SOUTHEASTERN GUIDE DOGS, INC., PALMETTO, FL. SN 78-883,795. PUB. 2-27-2007, FILED 5-15-2006.



OWNER OF U.S. REG. NO. 1,774,486.

THE COLOR(S) BLUE AND WHITE IS/ARE CLAIMED AS A FEATURE OF THE MARK.

THE MARK CONSISTS OF A SLANTED QUADRILATERAL BACKGROUND, IN BLUE, SURROUNDING A SILHOUETTE OF A DOG, WITH A GUIDE ATTACHED TO ITS NECK, AND A HAND HOLDING THE GUIDE, IN BLUE AND WHITE.

CLASS 41—EDUCATION AND ENTERTAINMENT

FOR PROVIDING TRAINING OF GUIDE DOGS FOR THE BLIND (U.S. CLS. 100, 101 AND 107).

FIRST USE 3-9-2007; IN COMMERCE 3-9-2007.

CLASS 44—MEDICAL, BEAUTY AND AGRICULTURAL SERVICES

FOR CHARITABLE SERVICES, NAMELY, PROVIDING GUIDE DOGS FOR THE BLIND (U.S. CLS. 100 AND 101).

FIRST USE 3-9-2007; IN COMMERCE 3-9-2007.

3,314,595. LIFE TIME PARADIGM, LLC, IRVINE, CA. SN 78-885,355. PUB. 1-16-2007, FILED 5-17-2006.

BANK OF YOU PARADIGM

THE MARK CONSISTS OF STANDARD CHARACTERS WITHOUT CLAIM TO ANY PARTICULAR FONT, STYLE, SIZE, OR COLOR.

NO CLAIM IS MADE TO THE EXCLUSIVE RIGHT TO USE "PARADIGM", APART FROM THE MARK AS SHOWN.

CLASS 36—INSURANCE AND FINANCIAL

FOR FINANCIAL SERVICES, NAMELY, CONSULTING SERVICES IN THE FIELD OF FINANCE, MORTGAGE BANKING, REAL ESTATE INVESTMENT, FINANCIAL PLANNING IN THE NATURE OF MORTGAGE PLANNING, AND FINANCIAL PLANNING; MORTGAGE BANKING SERVICES, NAMELY, ORIGINATION, ACQUISITION, SERVICING AND BROKERAGE OF MORTGAGE LOANS (U.S. CLS. 100, 101 AND 102).

FIRST USE 7-0-2007; IN COMMERCE 7-0-2007.

CLASS 41—EDUCATION AND ENTERTAINMENT

FOR SEMINARS, TRAINING AND CLASSES IN THE FIELDS OF FINANCE, MORTGAGE BANKING, REAL ESTATE INVESTMENT, FINANCIAL PLANNING IN THE NATURE OF MORTGAGE PLANNING, AND FINANCIAL PLANNING (U.S. CLS. 100, 101 AND 107).

FIRST USE 7-0-2007; IN COMMERCE 7-0-2007.

3,314,610. LANE BRYANT PURCHASING CORP., REYNOLDSBURG, OH. SN 78-889,310. PUB. 9-19-2006, FILED 5-22-2006.

LANE BRYANT LIFESTYLES

THE MARK CONSISTS OF STANDARD CHARACTERS WITHOUT CLAIM TO ANY PARTICULAR FONT, STYLE, SIZE, OR COLOR.

OWNER OF U.S. REG. NOS. 633,237, 1,363,867, AND OTHERS.

NO CLAIM IS MADE TO THE EXCLUSIVE RIGHT TO USE "LIFESTYLES", APART FROM THE MARK AS SHOWN.

CLASS 16—PAPER GOODS AND PRINTED MATTER

FOR CATALOGUES FEATURING BED AND BATH ACCESSORIES, CANDLES AND ACCESSORIES, COLLECTIBLES, ELECTRONICS, WINDOW TREATMENTS AND COVERINGS, FLOOR COVERINGS, GARDEN DÉCOR AND ACCESSORIES, HOLIDAY ORNAMENTS AND DECORATIONS, HOME FURNISHINGS AND DÉCOR, OFFICE FURNISHINGS, DÉCOR AND ACCESSORIES, HOUSEHOLD LAUNDRY PRODUCTS, KITCHENWARE AND ACCESSORIES, LINEN PRODUCTS, LUGGAGE, PERSONAL CARE AND AROMATHERAPY PRODUCTS, PICTURE FRAMES, SPORTS RELATED GIFTS, STATIONERY PRODUCTS, AND WALL ART (U.S. CLS. 2, 5, 22, 23, 29, 37, 38 AND 50).

FIRST USE 9-27-2006; IN COMMERCE 9-27-2006.

CLASS 35—ADVERTISING AND BUSINESS

FOR ON-LINE RETAIL STORE SERVICES AND MAIL ORDER CATALOG SERVICES FEATURING BED AND BATH ACCESSORIES, CANDLES AND ACCESSORIES, COLLECTIBLES, ELECTRONICS, WINDOW TREATMENTS AND COVERINGS, FLOOR COVERINGS, GARDEN DÉCOR AND ACCESSORIES, HOLIDAY ORNAMENTS AND DECORATIONS, HOME FURNISHINGS AND DÉCOR, OFFICE FURNISHINGS, DÉCOR AND ACCESSORIES, HOUSEHOLD LAUNDRY PRODUCTS, KITCHENWARE AND ACCESSORIES, LINEN PRODUCTS, LUGGAGE, PERSONAL CARE AND AROMATHERAPY PRODUCTS, PICTURE FRAMES, SPORTS RELATED GIFTS, STATIONERY PRODUCTS, AND WALL ART (U.S. CLS. 100, 101 AND 102).

FIRST USE 9-27-2006; IN COMMERCE 9-27-2006.

3,314,634. LINING SPORTS (SHANGHAI) COMPANY LIMITED, PUDONG, CHINA. SN 78-896,312. PUB. 1-9-2007, FILED 5-30-2006.

THE NAME NING LI IDENTIFIES A LIVING INDIVIDUAL WHOSE CONSENT IS OF RECORD.

THE MARK CONSISTS OF THE CHINESE CHARACTERS OF THE NAME OF THE LIVING INDIVIDUAL, NING LI. THE FIRST SYMBOL OF THE MARK BEING THE SURNAME LI, AND THE SECOND SYMBOL OF THE MARK BEING THE FIRST NAME NING.

THE FOREIGN WORDING IN THE MARK TRANSLATES INTO ENGLISH AS LI, NING.

CLASS 18—LEATHER GOODS

FOR ALL PURPOSE SPORT BAGS; ALL-PURPOSE ATHLETIC BAGS; ALL-PURPOSE CARRYING BAGS; ATHLETIC BAGS; ATTACHE CASES; BACKPACKS; BAGS AND HOLDALLS FOR SPORTS CLOTHING; BARREL BAGS; BEACH BAGS; BILLFOLDS; BOOK BAGS; BOSTON BAGS; BRIEFBAGS; BUMBAGS; CARRY-ALL BAGS; CARRY-ON BAGS; CARRYING CASES; COIN PURSES; CREDIT CARD CASES; DAYPACKS; DUFFEL BAGS; FANNY PACKS; FELT POUCHES; GARMENT BAGS FOR TRAVEL; GYM BAGS; HANDBAGS; HAVERSACKS; HIKING BAGS; HIKING RUCKSACKS; KEY CASES; KNAPSACKS; LUGGAGE; OVERNIGHT BAGS; POCKETBOOKS; POUCHES OF LEATHER; PURSES; RUCKSACKS; SCHOOL BAGS; SHOE BAGS FOR TRAVEL; SHOULDER BAGS; SPORTS BAGS; SPORTS PACKS; SUIT BAGS; SUITCASES; TOTE BAGS; WAIST BAGS; WALLETTS (U.S. CLS. 1, 2, 3, 22 AND 41).

FIRST USE 11-10-2006; IN COMMERCE 11-10-2006.

CLASS 25—CLOTHING

FOR ANKLE BOOTS; ATHLETIC FOOTWEAR; ATHLETIC UNIFORMS; BASEBALL CAPS; BASEBALL SHOES; BASKETBALL SNEAKERS; BATH SLIPPERS; BATHING CAPS; BATHING SUITS; BATHROBES; BEACH COVERUPS; BEACH FOOTWEAR; BEACHWEAR; BEANIES; BELTS; BICYCLING GLOVES; BLAZERS; BLOUSES; BOOTS; CAMISOLES; CANVAS SHOES; CAPS; CARDIGANS; CLIMBING BOOTS; COATS; COVERUPS; DENIM JACKETS; DRESSES; DUNGAREES; FOOTBALL SHOES; FOOTWEAR; FROCKS; GLOVES; GOLF CAPS; GOLF SHIRTS; GOLF SHOES; GOLF TROUSERS; GREATCOATS; GYM SHORTS; GYMNAS-TIC SHOES; HALTER TOPS; HANDBALL SHOES; HATS; HEAD SCARVES; HEAD SWEATBANDS; HEADBANDS; HEADWEAR; HEAVY JACKETS; HIKING BOOTS; HOSIERY; JACKETS; JEANS; JOGGING OUTFITS; JUMPERS; JUMPSUITS; KNICKERS; LEOTARDS; MOUNTAINEER-ING BOOTS; NECKWEAR; OVER COATS; OVERALLS; PANTIES; PANTS; PANTSUITS; PANTYHOSE; PULL-OVERS; RAIN COATS; RAIN JACKETS; RUBBER SHOES; RUGBY SHOES; RUNNING SHOES; SANDALS; SCARVES; SHIRTS; SHOES; SHORTS; SKI WEAR; SKIRTS; SKORTS; SKULL CAPS; SKULLIES; SLIPPERS; SMOCKS; SNEAKERS; SNOW SUITS; SOCCER SHOES; SOCKS AND STOCKINGS; SUITS; SUN VISORS; SWEAT SUITS; SWEATBANDS; SWEATERS; SWEATSOCKS; SWIM CAPS; SWIM WEAR; SWIMSUITS; T-SHIRTS; TANK TOPS; TENNIS SHOES; TENNIS WEAR; THONGS; TIES; TIGHTS; TOPCOATS; TRACK AND FIELD SHOES; TRACKSUITS; TRAINING SHOES; TROUSERS; UNDER-SHIRTS; UNDERWEAR; UNIFORMS; UNITARDS; VESTS; VOLLEYBALL SHOES; WOMEN'S SHOES; WORK SHOES AND BOOTS; WRISTBANDS (U.S. CLS. 22 AND 39).

FIRST USE 11-10-2006; IN COMMERCE 11-10-2006.

CLASS 28—TOYS AND SPORTING GOODS

FOR ARM GUARDS FOR ATHLETIC USE; BADMIN-TON RACKET STRINGS; BADMINTON RACKETS; BAD-MINTON SHUTTLECOCKS; BAGS FOR SKATEBOARDS; BASEBALL BATS; BASEBALL GLOVES; BASKET BALLS; BEACH BALLS; CASES FOR TENNIS BALLS; CHEST PROTECTORS FOR SPORTS; ELBOW GUARDS FOR ATHLETIC USE; EXERCISE MACHINES; FOOT BALLS; GOLF BAG COVERS; GOLF BAGS; GOLF BALLS; GOLF CLUB BAGS; GOLF CLUBS; GOLF GLOVES; KNEE GUARDS FOR ATHLETIC USE; LEG GUARDS FOR ATHLETIC USE; PLAYGROUND BALLS; RACKET BALLS; RACKET CASES; RACKETS; RACKETS AND STRINGS FOR RACKETS; RACQUET BALL GLOVES; RACQUET BALL RACKET COVERS; RACQUET BALL RACKET STRINGS; RACQUET BALL RACKETS; RACQUET BALLS; ROLLER SKATES; RUBBER BALLS; SHIN GUARDS FOR ATHLETIC USE; SHUTTLECOCKS FOR BADMINTON; SKATEBOARDS; SOCCER BALL KNEE PADS; SOCCER BALLS; SOFTBALL BATS; SPORT BALLS; SWIMMING BOARDS; TABLE TENNIS BALLS; TABLE TENNIS RACKETS; TENNIS BALLS; TENNIS RACKET COVERS; TENNIS RACKET STRINGS; TENNIS RACKETS; VOLLEY BALLS; WEIGHT LIFTING BELTS; WORK-OUT GLOVES (U.S. CLS. 22, 23, 38 AND 50).

FIRST USE 11-10-2006; IN COMMERCE 11-10-2006.

3,314,636. LINING SPORTS (SHANGHAI) COMPANY LIM-ITED, PUDONG, SHANGHAI, CHINA. SN 78-896,532. PUB. 1-9-2007, FILED 5-31-2006.

李 宁

THE NAME NING LI IDENTIFIES A LIVING INDIVI-DUAL WHOSE CONSENT IS OF RECORD.

THE MARK CONSISTS OF THE CHINESE CHARACTERS OF THE NAME OF THE LIVING INDIVIDUAL, NING LI. THE FIRST CHARACTER OF THE MARK BEING THE SURNAME, LI, AND THE SECOND CHARACTER OF THE MARK BEING THE FIRST NAME, NING.

CLASS 18—LEATHER GOODS

FOR ALL PURPOSE SPORT BAGS; ALL-PURPOSE ATHLETIC BAGS; ALL-PURPOSE CARRYING BAGS; ATHLETIC BAGS; ATTACHE CASES; BACKPACKS; BAGS AND HOLDALLS FOR SPORTS CLOTHING; BARREL BAGS; BEACH BAGS; BILLFOLDS; BOOK BAGS; BOSTON BAGS; BRIEF BAGS; BUMBAGS; CARRY-ALL BAGS; CARRY-ON BAGS; CARRYING CASES; COIN PURSES; CREDIT CARD CASES; DAY PACKS; DUFFEL BAGS; FANNY PACKS; FELT POUCHES; GARMENT BAGS FOR TRAVEL; GYM BAGS; HAND-BAGS; HAVERSACKS; HIKING BAGS; HIKING RUCK-SACKS; KEY CASES; KNAPSACKS; LUGGAGE; OVERNIGHT BAGS; POCKETBOOKS; POUCHES OF LEATHER; PURSES; RUCKSACKS; SCHOOL BAGS; SHOE BAGS FOR TRAVEL; SHOULDER BAGS; SPORTS BAGS; SPORTS PACKS; SUIT BAGS; SUITCASES; TOTE BAGS; WAIST BAGS; WALLET (U.S. CLS. 1, 2, 3, 22 AND 41).

FIRST USE 11-10-2006; IN COMMERCE 11-10-2006.

CLASS 25—CLOTHING

FOR ANKLE BOOTS; ATHLETIC FOOTWEAR; ATHLETIC UNIFORMS; BASEBALL CAPS; BASEBALL SHOES; BASKETBALL SNEAKERS; BATH SLIPPERS; BATHING CAPS; BATHING SUITS; BATHROBES; BEACH COVERUPS; BEACH FOOTWEAR; BEACHWEAR; BEANIES; BELTS; BICYCLING GLOVES; BLAZERS; BLOUSES; BOOTS; CAMISOLES; CANVAS SHOES; CAPS; CARDIGANS; CLIMBING BOOTS; COATS; COVERUPS; DENIM JACKETS; DRESSES; DUNGAREES; FOOTBALL SHOES; FOOTWEAR; FROCKS; GLOVES; GOLF CAPS; GOLF SHIRTS; GOLF SHOES; GOLF TROUSERS; GREATCOATS; GYM SHORTS; GYMNAS-TIC SHOES; HALTER TOPS; HANDBALL SHOES; HATS; HEAD SCARVES; HEAD SWEATBANDS; HEADBANDS; HEADWEAR; HEAVY JACKETS; HIKING BOOTS; HOSIERY; JACKETS; JEANS; JOGGING OUTFITS; JUMPERS; JUMPSUITS; KNICKERS; LEOTARDS; MOUNTAINEER-ING BOOTS; NECKWEAR; OVER COATS; OVERALLS; PANTIES; PANTS; PANTSUITS; PANTYHOSE; PULL-OVERS; RAIN COATS; RAIN JACKETS; RUBBER SHOES; RUGBY SHORTS; RUNNING SHOES; SANDALS; SCARVES; SHIRTS; SHOES; SHORTS; SKI WEAR; SKIRTS; SKORTS; SKULL CAPS; SKULLIES; SLIPPERS; SMOCKS; SNEAKERS; SNOW SUITS; SOCCER SHOES; SOCKS AND STOCKINGS; SUITS; SUN VISORS; SWEAT SUITS; SWEATBANDS; SWEATERS; SWEATSOCKS; SWIM CAPS; SWIM TRUNKS; SWIMSUITS; T-SHIRTS; TANK TOPS; TENNIS SHOES; TENNIS WEAR; THONGS; TIES; TIGHTS; TOPCOATS; TRACK AND FIELD SHOES; TRACK SUITS; TRAINING SHOES; TROUSERS; UN-DERSHIRTS; UNDERWEAR; UNIFORMS; UNITARDS; VESTS; VOLLEYBALL SHOES; WOMEN'S SHOES; WORK SHOES AND BOOTS; WRIST-BANDS (U.S. CLS. 22 AND 39).

FIRST USE 11-10-2006; IN COMMERCE 11-10-2006.

CLASS 28—TOYS AND SPORTING GOODS

FOR ARM GUARDS FOR ATHLETIC USE; BADMINTON RACKET STRINGS; BADMINTON RACKETS; BADMINTON SHUTTLECOCKS; BAGS FOR SKATEBOARDS; BASEBALL BATS; BASEBALL GLOVES; BASKET BALLS; BEACH BALLS; CASES FOR TENNIS BALLS; CHEST PROTECTORS FOR SPORTS; ELBOW GUARDS FOR ATHLETIC USE; EXERCISE MACHINES; FOOTBALLS; GOLF BAG COVERS; GOLF BAGS; GOLF BALLS; GOLF CLUB BAGS; GOLF CLUBS; GOLF GLOVES; KNEE GUARDS FOR ATHLETIC USE; LEG GUARDS FOR ATHLETIC USE; PLAYGROUND BALLS; RACKET BALLS; RACKET CASES; RACKETS; RACKETS AND STRINGS FOR RACKETS; RACQUET BALL GLOVES; RACQUET BALL RACKET COVERS; RACQUET BALL RACKET STRINGS; RACQUET BALL RACKETS; RACQUET BALLS; ROLLER SKATES; RUBBER BALLS; SHIN GUARDS FOR ATHLETIC USE; SHUTTLECOCKS FOR BADMINTON; SKATEBOARDS; SOCCER BALL KNEE PADS; SOCCER BALLS; SOFTBALL BATS; SPORT BALLS; SWIMMING BOARDS; TABLE TENNIS BALLS; TABLE TENNIS RACKETS; TENNIS BALLS; TENNIS RACKET COVERS; TENNIS RACKET STRINGS; TENNIS RACKETS; VOLLEY BALLS; WEIGHT LIFTING BELTS; WORK-OUT GLOVES (U.S. CLS. 22, 23, 38 AND 50).
FIRST USE 11-10-2006; IN COMMERCE 11-10-2006.

3,314,671. CORN, MARCY, SANTEE, CA. SN 78-903,262. PUB. 1-2-2007, FILED 6-7-2006.

dojogirl

CLASS 25—CLOTHING

FOR HATS; MARTIAL ARTS UNIFORMS; SHORTS; SPORTS BRA; SWEAT PANTS; SWEAT SHIRTS; SWEAT-BANDS; T-SHIRTS; TANK TOPS (U.S. CLS. 22 AND 39).
FIRST USE 10-6-2006; IN COMMERCE 10-6-2006.

CLASS 28—TOYS AND SPORTING GOODS

FOR BODY PROTECTORS FOR MARTIAL ARTS AND BOXING; SHIN GUARDS FOR ATHLETIC USE (U.S. CLS. 22, 23, 38 AND 50).
FIRST USE 7-10-2007; IN COMMERCE 7-10-2007.

3,314,653. APEX PEST CONTROL, INC., MERRITT ISLAND, FL. SN 78-899,460. PUB. 2-13-2007, FILED 6-2-2006.

3,314,713. DINOUR, DAVID, MERRICK, NY. SN 78-914,154. PUB. 2-13-2007, FILED 6-22-2006.

Your Dream is Possible

PIPELINE

THE MARK CONSISTS OF STANDARD CHARACTERS WITHOUT CLAIM TO ANY PARTICULAR FONT, STYLE, SIZE, OR COLOR.

CLASS 19—NON-METALLIC BUILDING MATERIALS

FOR PEST CONTROL SYSTEM COMPOSED OF POLY-ETHYLENE PIPES AND TUBES INSTALLED WITHIN A BUILDING FOR DISTRIBUTING PESTICIDE (U.S. CLS. 1, 12, 33 AND 50).
FIRST USE 9-1-2006; IN COMMERCE 9-1-2006.

CLASS 37—CONSTRUCTION AND REPAIR

FOR PEST CONTROL SERVICES; PEST AND TERMITE CONTROL; INSTALLATION OF PIPES AND TUBES FOR DISTRIBUTING PESTICIDE WITHIN A BUILDING; EXTERMINATION OF VERMIN (U.S. CLS. 100, 103 AND 106).
FIRST USE 9-1-2006; IN COMMERCE 9-1-2006.

THE MARK CONSISTS OF STANDARD CHARACTERS WITHOUT CLAIM TO ANY PARTICULAR FONT, STYLE, SIZE, OR COLOR.

CLASS 39—TRANSPORTATION AND STORAGE

FOR ARRANGING TRAVEL TOURS, COORDINATING TRAVEL ARRANGEMENTS FOR INDIVIDUALS AND FOR GROUPS, ORGANIZATION OF TRAVEL, ORGANIZATION OF EXCURSIONS, SIGHTSEEING TOURS, HOLIDAYS, TOURS AND TRAVEL, TRAVEL AGENCY SERVICES, NAMELY, MAKING RESERVATIONS AND BOOKINGS FOR TRANSPORTATION, TRAVEL AND TOUR INFORMATION SERVICE, TRAVEL AND TOUR TICKET RESERVATION SERVICE, TRAVEL BOOKING AGENCIES (U.S. CLS. 100 AND 105).
FIRST USE 5-10-2007; IN COMMERCE 5-10-2007.

CLASS 43—HOTEL AND RESTAURANT SERVICES

FOR PROVIDING TRAVEL LODGING INFORMATION SERVICES AND TRAVEL LODGING BOOKING AGENCY SERVICES FOR TRAVELERS, TRAVEL AGENCY SERVICES, NAMELY, MAKING RESERVATIONS AND BOOKING FOR TEMPORARY LODGING, TRAVEL AGENCY SERVICES, NAMELY, MAKING RESERVATIONS AND BOOKINGS FOR RESTAURANTS AND MEALS (U.S. CLS. 100 AND 101).
FIRST USE 5-10-2007; IN COMMERCE 5-10-2007.

3,314,717. ELEGANT PUBLISHING, INC., BARRINGTON, RI. SN 78-915,784. PUB. 3-6-2007, FILED 6-23-2006.

3,314,732. ROYALE INTERIORS, LTD., TUCSON, AZ. SN 78-920,326. PUB. 2-13-2007, FILED 6-29-2006.

PLATINUM LIST

THE MARK CONSISTS OF STANDARD CHARACTERS WITHOUT CLAIM TO ANY PARTICULAR FONT, STYLE, SIZE, OR COLOR.

NO CLAIM IS MADE TO THE EXCLUSIVE RIGHT TO USE "LIST", APART FROM THE MARK AS SHOWN.

CLASS 16—PAPER GOODS AND PRINTED MATTER

FOR DIRECTORIES OF BUSINESSES THAT FEATURE WEDDING RELATED GOODS AND SERVICES, WHERE SAID DIRECTORY IS FEATURED AS PART OF A MAGAZINE (U.S. CLS. 2, 5, 22, 23, 29, 37, 38 AND 50).

FIRST USE 2-1-2006; IN COMMERCE 2-1-2006.

CLASS 35—ADVERTISING AND BUSINESS

FOR ON-LINE BUSINESS DIRECTORIES FEATURING BUSINESSES THAT PROVIDE WEDDING RELATED GOODS AND SERVICES (U.S. CLS. 100, 101 AND 102).

FIRST USE 2-1-2006; IN COMMERCE 2-1-2006.

3,314,726. SOVEREIGN BANK, WYOMISSING, PA. SN 78-917,907. PUB. 3-13-2007, FILED 6-27-2006.

HR@HAND

THE MARK CONSISTS OF STANDARD CHARACTERS WITHOUT CLAIM TO ANY PARTICULAR FONT, STYLE, SIZE, OR COLOR.

CLASS 35—ADVERTISING AND BUSINESS

FOR PROVIDING INFORMATION DIRECTLY AND VIA THE INTERNET IN THE FIELD OF HUMAN RESOURCES; CONSULTING SERVICES IN THE FIELD OF HUMAN RESOURCES (U.S. CLS. 100, 101 AND 102).

FIRST USE 8-31-2006; IN COMMERCE 8-31-2006.

CLASS 36—INSURANCE AND FINANCIAL

FOR PROVIDING INFORMATION DIRECTLY AND VIA THE INTERNET IN THE FIELD OF EMPLOYEE BENEFITS; CONSULTING SERVICE IN THE FIELD OF EMPLOYEE BENEFITS MANAGEMENT (U.S. CLS. 100, 101 AND 102).

FIRST USE 8-31-2006; IN COMMERCE 8-31-2006.

CLOSET TRENDS

THE MARK CONSISTS OF STANDARD CHARACTERS WITHOUT CLAIM TO ANY PARTICULAR FONT, STYLE, SIZE, OR COLOR.

NO CLAIM IS MADE TO THE EXCLUSIVE RIGHT TO USE "CLOSET", APART FROM THE MARK AS SHOWN.

CLASS 20—FURNITURE AND ARTICLES NOT OTHERWISE CLASSIFIED

FOR CLOSET AND STORAGE SPACE SYSTEMS FOR RESIDENTIAL AND COMMERCIAL APPLICATIONS, COMPRISED OF CABINETS, SHELVES, DRAWERS, FILE DRAWERS, DRAWER DIVIDERS, CUBBIES, HAMPERS, BASKETS, PULL-OUT STORAGE UNITS, COUNTER TOPS, DESK TOPS, WALL BEDS, HANGER RACKS, DISPLAY RACKS (U.S. CLS. 2, 13, 22, 25, 32 AND 50).

FIRST USE 10-1-2006; IN COMMERCE 10-1-2006.

CLASS 37—CONSTRUCTION AND REPAIR

FOR CUSTOM CONSTRUCTION AND INSTALLATION OF CLOSETS AND STORAGE SPACE SYSTEMS (U.S. CLS. 100, 103 AND 106).

FIRST USE 10-1-2006; IN COMMERCE 10-1-2006.

3,314,733. ROYALE INTERIORS, LTD., TUCSON, AZ. SN 78-920,356. PUB. 2-13-2007, FILED 6-29-2006.



NO CLAIM IS MADE TO THE EXCLUSIVE RIGHT TO USE "CLOSET" OR "CUSTOM CLOSETS AND CABINETRY", APART FROM THE MARK AS SHOWN.

THE MARK CONSISTS OF THE STYLIZED WORDS "CLOSET TRENDS" INCLUDING A STYLIZED CLOTHES HANGER THE END OF WHICH FORMS THE CROSSING ELEMENT OF THE "T" IN "TRENDS".

CLASS 20—FURNITURE AND ARTICLES NOT OTHERWISE CLASSIFIED

FOR CLOSET AND STORAGE SPACE SYSTEMS FOR RESIDENTIAL AND COMMERCIAL APPLICATIONS, COMPRISED OF CABINETS, SHELVES, DRAWERS, FILE DRAWERS, DRAWER DIVIDERS, CUBBIES, HAMPERS, BASKETS, PULL-OUT STORAGE UNITS, COUNTER TOPS, DESK TOPS, WALL BEDS, HANGER RACKS, DISPLAY RACKS (U.S. CLS. 2, 13, 22, 25, 32 AND 50).

FIRST USE 10-1-2006; IN COMMERCE 10-1-2006.

CLASS 37—CONSTRUCTION AND REPAIR

FOR CUSTOM CONSTRUCTION AND INSTALLATION OF CLOSETS AND STORAGE SPACE SYSTEMS (U.S. CLS. 100, 103 AND 106).

FIRST USE 10-1-2006; IN COMMERCE 10-1-2006.

3,314,743. HELPGUEST TECHNOLOGIES, INC., DELMAR, NY. SN 78-924,524. PUB. 2-13-2007, FILED 7-7-2006.

HelpGuest

THE MARK CONSISTS OF STANDARD CHARACTERS WITHOUT CLAIM TO ANY PARTICULAR FONT, STYLE, SIZE, OR COLOR.

CLASS 9—ELECTRICAL AND SCIENTIFIC APPARATUS

FOR COMPUTER E-COMMERCE SOFTWARE TO ALLOW ACCESS TO AN ON-LINE SERVICES MARKETPLACE; COMPUTER E-COMMERCE SOFTWARE FOR FACILITATING REAL-TIME ON-LINE PURCHASE OF KNOWLEDGE BY END USERS FROM KNOWLEDGE PROVIDERS OVER AN ON-LINE WEB SITE ACCESSED THROUGH A GLOBAL COMPUTER NETWORK; COMPUTER E-COMMERCE SOFTWARE FOR FACILITATING ACCESS AND SHARING OF COMPUTER RESOURCES IN VIRTUAL PRIVATE NETWORKS ESTABLISHED BY A REAL-TIME ON-LINE KNOWLEDGE SHARING SERVICE (U.S. CLS. 21, 23, 26, 36 AND 38).

FIRST USE 11-1-2004; IN COMMERCE 11-1-2004.

CLASS 35—ADVERTISING AND BUSINESS

FOR ON-LINE TRADING SERVICES PROVIDED TO OTHERS TO FACILITATE REAL-TIME ON-LINE PURCHASE OF KNOWLEDGE BY END USERS FROM KNOWLEDGE PROVIDERS OVER AN ON-LINE WEB SITE ACCESSED THROUGH A GLOBAL COMPUTER NETWORK; PROVIDING AN ON-LINE SERVICES MARKETPLACE FOR OTHERS TO BUY AND SELL KNOWLEDGE AS REAL-TIME SERVICE OFFERINGS; AN ON-LINE TRADING SERVICE PROVIDED TO OTHERS FOR FACILITATING REAL-TIME KNOWLEDGE SHARING RELATIONSHIPS BY ESTABLISHING VIRTUAL PRIVATE NETWORKS WITH ACCESS AND SHARING OF COMPUTER RESOURCES BETWEEN KNOWLEDGE PROVIDERS AND END USERS (U.S. CLS. 100, 101 AND 102).

FIRST USE 11-1-2004; IN COMMERCE 11-1-2004.

3,314,754. GROSSBERG, JEFFREY, CHICAGO, IL. SN 78-929,598. PUB. 2-27-2007, FILED 7-14-2006.

GREEN WORLD

THE MARK CONSISTS OF STANDARD CHARACTERS WITHOUT CLAIM TO ANY PARTICULAR FONT, STYLE, SIZE, OR COLOR.

CLASS 36—INSURANCE AND FINANCIAL

FOR ADVICE RELATING TO INVESTMENTS; ASSESSMENT AND MANAGEMENT OF REAL ESTATE; BUILDING MANAGEMENT; EQUITY CAPITAL INVESTMENT; FACILITATING AND ARRANGING FOR THE FINANCING OF REAL ESTATE AND COMPANIES; FINANCIAL INVESTMENT IN THE FIELD OF REAL ESTATE AND COMPANIES; FINANCIAL PORTFOLIO MANAGEMENT; FINANCIAL VALUATION OF PERSONAL PROPERTY AND REAL ESTATE; FINANCING OF INDUSTRIAL ACTIVITIES; FUND INVESTMENT CONSULTATION; FUNDS INVESTMENT; INVESTMENT BROKERAGE; INVESTMENT SERVICES, NAMELY ASSET ACQUISITION, CONSULTATION, DEVELOPMENT AND MANAGEMENT SERVICES; LEASING OF APARTMENTS; LEASING OF OFFICE SPACE; LEASING OF REAL ESTATE; LEASING OR RENTING OF BUILDINGS; PROJECT FINANCING; REAL ESTATE ACQUISITION SERVICES; REAL ESTATE AGENCIES; REAL ESTATE BROKERAGE; REAL ESTATE INVESTMENT; REAL ESTATE MANAGEMENT; REAL ESTATE PROCUREMENT FOR OTHERS; VENTURE CAPITAL SERVICES, NAMELY, PROVIDING FINANCING TO EMERGING AND START-UP COMPANIES (U.S. CLS. 100, 101 AND 102).

FIRST USE 2-28-2007; IN COMMERCE 2-28-2007.

CLASS 37—CONSTRUCTION AND REPAIR

FOR BUILDING CONSTRUCTION AND REPAIR; BUILDING INSPECTION; BUILDING RESTORATION; CONSTRUCTION AND RENOVATION OF BUILDINGS; CONSTRUCTION AND REPAIR OF BUILDINGS; CONSTRUCTION CONSULTANCY; CONSTRUCTION MANAGEMENT; CONSTRUCTION PLANNING; CONSTRUCTION, MAINTENANCE AND RENOVATION OF PROPERTY; CUSTOM CONSTRUCTION AND BUILDING RENOVATION; CUSTOM CONSTRUCTION OF HOMES; REAL ESTATE DEVELOPMENT; RESIDENTIAL AND BUILDING CONSTRUCTION CONSULTING; RESIDENTIAL AND COMMERCIAL BUILDING CONSTRUCTION (U.S. CLS. 100, 103 AND 106).

FIRST USE 2-28-2007; IN COMMERCE 2-28-2007.

3,314,759. UNITED STATES POSTAL SERVICE, WASHINGTON, DC. SN 78-930,952. PUB. 11-7-2006, FILED 7-17-2006.

MILI-PAC

THE MARK CONSISTS OF STANDARD CHARACTERS WITHOUT CLAIM TO ANY PARTICULAR FONT, STYLE, SIZE, OR COLOR.

CLASS 16—PAPER GOODS AND PRINTED MATTER

FOR ENVELOPES, AND PAPER AND CARDBOARD BOXES FOR PACKAGING AND SHIPPING (U.S. CLS. 2, 5, 22, 23, 29, 37, 38 AND 50).

FIRST USE 11-0-2003; IN COMMERCE 11-0-2003.

CLASS 35—ADVERTISING AND BUSINESS

FOR SORTING, HANDLING, AND RECEIVING PACKAGES, DOCUMENTS, LETTERS AND ADVERTISEMENTS (U.S. CLS. 100, 101 AND 102).

FIRST USE 11-0-2003; IN COMMERCE 11-0-2003.

CLASS 39—TRANSPORTATION AND STORAGE

FOR PICKUP, TRANSPORTATION AND DELIVERY OF PACKAGES, DOCUMENTS, LETTERS AND ADVERTISEMENTS BY VARIOUS MODES OF TRANSPORTATION (U.S. CLS. 100 AND 105).

FIRST USE 11-0-2003; IN COMMERCE 11-0-2003.

3,314,787. CONNOLLY CONSULTING ASSOCIATES, INC., WILTON, CT. SN 78-941,137. PUB. 3-27-2007, FILED 7-31-2006.

RETRIEVER

THE MARK CONSISTS OF STANDARD CHARACTERS WITHOUT CLAIM TO ANY PARTICULAR FONT, STYLE, SIZE, OR COLOR.

CLASS 9—ELECTRICAL AND SCIENTIFIC APPARATUS

FOR RECOVERY AUDITING SOFTWARE (U.S. CLS. 21, 23, 26, 36 AND 38).

FIRST USE 8-5-2004; IN COMMERCE 9-30-2004.

CLASS 35—ADVERTISING AND BUSINESS

FOR RECOVERY AUDIT SERVICES, NAMELY, REVIEWING ACCOUNTS PAYABLE, PURCHASING SYSTEMS AND MEDICAL CLAIMS BILLING SYSTEMS TO DETECT LOST PROFITS THROUGH OVERPAYMENTS, MISCALCULATIONS, MISSED DISCOUNTS, PRICING ERRORS, DUPLICATE PAYMENTS, INCORRECT INVOICES AND MISSED CREDITS, SALES AND USE TAX LIABILITIES AND PAYMENTS, CONTRACT COMPLIANCE, AND PROVIDING CONSULTATIVE PROCEDURE-TO-PAY PROCESS IMPROVEMENT RECOMMENDATIONS (U.S. CLS. 100, 101 AND 102).

FIRST USE 8-5-2004; IN COMMERCE 9-30-2004.

3,314,788. CONNOLLY CONSULTING ASSOCIATES, INC., WILTON, CT. SN 78-941,138. PUB. 3-27-2007, FILED 7-31-2006.

DECIPHER

THE MARK CONSISTS OF STANDARD CHARACTERS WITHOUT CLAIM TO ANY PARTICULAR FONT, STYLE, SIZE, OR COLOR.

CLASS 9—ELECTRICAL AND SCIENTIFIC APPARATUS

FOR RECOVERY AUDITING SOFTWARE (U.S. CLS. 21, 23, 26, 36 AND 38).

FIRST USE 8-5-2004; IN COMMERCE 9-30-2004.

CLASS 35—ADVERTISING AND BUSINESS

FOR RECOVERY AUDIT SERVICES, NAMELY, REVIEWING ACCOUNTS PAYABLE, PURCHASING SYSTEMS AND MEDICAL CLAIMS BILLING SYSTEMS TO DETECT LOST PROFITS THROUGH OVERPAYMENTS, MISCALCULATIONS, MISSED DISCOUNTS, PRICING ERRORS, DUPLICATE PAYMENTS, INCORRECT INVOICES AND MISSED CREDITS, SALES AND USE TAX LIABILITIES AND PAYMENTS, CONTRACT COMPLIANCE, AND PROVIDING CONSULTATIVE PROCEDURE-TO-PAY PROCESS IMPROVEMENT RECOMMENDATIONS (U.S. CLS. 100, 101 AND 102).

FIRST USE 8-5-2004; IN COMMERCE 9-30-2004.

3,314,791. BURNS, TAMMI S, STAYTON, OR. SN 78-941,791. PUB. 3-13-2007, FILED 7-31-2006.

BREAK THE CHAIN

THE MARK CONSISTS OF STANDARD CHARACTERS WITHOUT CLAIM TO ANY PARTICULAR FONT, STYLE, SIZE, OR COLOR.

CLASS 16—PAPER GOODS AND PRINTED MATTER

FOR STICKERS (U.S. CLS. 2, 5, 22, 23, 29, 37, 38 AND 50).

FIRST USE 7-20-2007; IN COMMERCE 7-20-2007.

CLASS 25—CLOTHING

FOR HEADGEAR, NAMELY, HATS, VISORS, CAPS, STOCKING CAPS; SHIRTS (U.S. CLS. 22 AND 39).

FIRST USE 6-21-2007; IN COMMERCE 6-21-2007.

3,314,798. DAVID HARSH, EDMONDS, WA. SN 78-944,108. PUB. 4-10-2007, FILED 8-3-2006.



NO CLAIM IS MADE TO THE EXCLUSIVE RIGHT TO USE "MUSIC", APART FROM THE MARK AS SHOWN.

THE MARK CONSISTS OF A SPIRAL TO THE LEFT, WITH THREE SECTIONS OF THE SPIRAL, FOLLOWED BY THREE WORDS ON THE RIGHT WHICH SAY "THREE STRANDS MUSIC."

CLASS 9—ELECTRICAL AND SCIENTIFIC APPARATUS

FOR AUDIO RECORDINGS FEATURING ORIGINAL MUSIC; VIDEO RECORDINGS FEATURING PERFORMANCE AND INSTRUCTION OF MUSICAL INSTRUMENTS (U.S. CLS. 21, 23, 26, 36 AND 38).

FIRST USE 11-18-2006; IN COMMERCE 11-18-2006.

CLASS 41—EDUCATION AND ENTERTAINMENT

FOR CONDUCTING WORKSHOPS AND SEMINARS IN GUITAR PLAYING, RELIGIOUS WORSHIP, SONGWRITING; ENTERTAINMENT, NAMELY, LIVE MUSIC CONCERTS (U.S. CLS. 100, 101 AND 107).

FIRST USE 11-18-2006; IN COMMERCE 11-18-2006.

3,314,815. MERCY MINISTRIES OF AMERICA, INC., NASHVILLE, TN. SN 78-950,382. PUB. 3-27-2007, FILED 8-11-2006.

VALUING EVERY YOUNG WOMAN'S FUTURE

THE MARK CONSISTS OF STANDARD CHARACTERS WITHOUT CLAIM TO ANY PARTICULAR FONT, STYLE, SIZE, OR COLOR.

CLASS 43—HOTEL AND RESTAURANT SERVICES

FOR ELEEMOSYNARY SERVICES, NAMELY PROVIDING FOOD AND TEMPORARY HOUSING SHELTER TO WOMEN IN NEED (U.S. CLS. 100 AND 101).

FIRST USE 4-30-2006; IN COMMERCE 4-30-2006.

CLASS 44—MEDICAL, BEAUTY AND AGRICULTURAL SERVICES

FOR ELEEMOSYNARY SERVICES, NAMELY PROVIDING PSYCHOLOGICAL COUNSELING TO WOMEN IN NEED (U.S. CLS. 100 AND 101).

FIRST USE 4-30-2006; IN COMMERCE 4-30-2006.

CLASS 45—PERSONAL AND LEGAL SERVICES

FOR ELEEMOSYNARY SERVICES, NAMELY PROVIDING GRIEF COUNSELING, CLOTHING, AND COUNSELING REGARDING ADOPTION PLACEMENT SERVICES TO WOMEN IN NEED (U.S. CLS. 100 AND 101).

FIRST USE 4-30-2006; IN COMMERCE 4-30-2006.

3,314,826. RAZOR & TIE DIRECT, L.L.C., NEW YORK, NY. SN 78-953,444. PUB. 4-10-2007, FILED 8-16-2006.

MUSICSPACEKIDS

THE MARK CONSISTS OF STANDARD CHARACTERS

WITHOUT CLAIM TO ANY PARTICULAR FONT, STYLE, SIZE, OR COLOR.

OWNER OF U.S. REG. NOS. 3,055,244 AND 3,103,456.

CLASS 35—ADVERTISING AND BUSINESS

FOR ONLINE RETAIL STORE SERVICES PROVIDED VIA A GLOBAL COMPUTER NETWORK FEATURING DVDS, MOVIES, MUSIC, COMPACT DISCS, BOOKS, MAGAZINES, POSTERS, CLOTHING, TOYS, GAMES AND COMPUTER, VIDEO AND ELECTRONIC GAMES (U.S. CLS. 100, 101 AND 102).

FIRST USE 7-31-2001; IN COMMERCE 7-31-2001.

CLASS 41—EDUCATION AND ENTERTAINMENT

FOR PROVIDING A WEB SITE CONTAINING INFORMATION AND CONTENT ON MOVIES, VIDEOS, MUSIC, TOYS, GAMES AND ELECTRONIC GAMES (U.S. CLS. 100, 101 AND 107).

FIRST USE 7-31-2001; IN COMMERCE 7-31-2001.

3,314,851. FIA CARD SERVICES, NATIONAL ASSOCIATION, WILMINGTON, DE. SN 78-959,588. PUB. 3-6-2007, FILED 8-24-2006.

WorldPoints 

OWNER OF U.S. REG. NOS. 2,896,210 AND 3,169,724.

THE MARK CONSISTS OF THE WORD WORLDPOINTS WITH A DESIGN CONTAINING FOUR "W'S IN A CIRCULAR DESIGN.

CLASS 35—ADVERTISING AND BUSINESS

FOR PROMOTING THE SALE OF CREDIT CARD ACCOUNTS THROUGH THE ADMINISTRATION OF INCENTIVE AWARD PROGRAMS (U.S. CLS. 100, 101 AND 102).

FIRST USE 6-0-2006; IN COMMERCE 6-0-2006.

CLASS 36—INSURANCE AND FINANCIAL

FOR BANKING AND FINANCIAL SERVICES, NAMELY, PROVIDING CREDIT CARD, AND STORED VALUE SMART CARD SERVICES; ELECTRONIC FUNDS TRANSFER SERVICES, ELECTRONIC BILL PAYMENT SERVICES; CASH DISBURSEMENTS SERVICES, AND CREDIT CARD TRANSACTION AUTHORIZATION AND SETTLEMENT SERVICES; VALUE EXCHANGE SERVICES, NAMELY, THE SECURE EXCHANGE OF MONETARY VALUE, NAMELY, ELECTRONIC CASH, OVER PUBLIC COMPUTER NETWORKS TO FACILITATE ELECTRONIC COMMERCE; SMART CARDS SERVICES FOR EXCHANGING MONETARY VALUE, AND ELECTRONIC CASH SERVICES, NAMELY, CURRENCY EXCHANGE IN A SECURE ENVIRONMENT OVER GLOBAL ELECTRONIC COMMUNICATIONS NETWORKS (U.S. CLS. 100, 101 AND 102).

FIRST USE 6-0-2006; IN COMMERCE 6-0-2006.

3,314,874. SUNTRUST BANKS, INC., ORLANDO, FL. SN 78-966,945. PUB. 3-6-2007, FILED 9-5-2006.

3,314,885. ALLIANCE FLOORING, INC., CHATTANOOGA, TN. SN 78-970,138. PUB. 4-24-2007, FILED 9-8-2006.

SunTrust Rewards

THE MARK CONSISTS OF STANDARD CHARACTERS WITHOUT CLAIM TO ANY PARTICULAR FONT, STYLE, SIZE, OR COLOR.

NO CLAIM IS MADE TO THE EXCLUSIVE RIGHT TO USE "REWARDS", APART FROM THE MARK AS SHOWN.

CLASS 35—ADVERTISING AND BUSINESS

FOR PROMOTING THE GOODS AND SERVICES OF OTHERS BY ADMINISTRATING OF A PROGRAM THROUGH WHICH USERS OF CREDIT AND DEBIT CARDS AND OTHER BANKING SERVICES ARE AWARDED POINTS BASED UPON USE AND REDEEMABLE FOR CASH BACK, TRAVEL, MERCHANDISE FOR A VARIETY OF GOODS AND SERVICES AND DISCOUNTS AND UPGRADES FOR BANK PRODUCTS AND SERVICES (U.S. CLS. 100, 101 AND 102).

FIRST USE 2-5-2007; IN COMMERCE 2-5-2007.

CLASS 36—INSURANCE AND FINANCIAL

FOR BANKING SERVICES (U.S. CLS. 100, 101 AND 102).

FIRST USE 2-5-2007; IN COMMERCE 2-5-2007.

3,314,875. SUNTRUST BANKS, INC., ORLANDO, FL. SN 78-966,949. PUB. 3-6-2007, FILED 9-5-2006.

SunPoints

THE MARK CONSISTS OF STANDARD CHARACTERS WITHOUT CLAIM TO ANY PARTICULAR FONT, STYLE, SIZE, OR COLOR.

CLASS 35—ADVERTISING AND BUSINESS

FOR PROMOTING THE GOODS AND SERVICES OF OTHERS BY ADMINISTRATING OF A PROGRAM THROUGH WHICH USERS OF CREDIT AND DEBIT CARDS AND OTHER BANKING SERVICES ARE AWARDED POINTS BASED UPON USE AND REDEEMABLE FOR CASH BACK, TRAVEL, MERCHANDISE FOR A VARIETY OF GOODS AND SERVICES AND DISCOUNTS AND UPGRADES FOR BANK PRODUCTS AND SERVICES (U.S. CLS. 100, 101 AND 102).

FIRST USE 2-5-2007; IN COMMERCE 2-5-2007.

CLASS 36—INSURANCE AND FINANCIAL

FOR BANKING SERVICES (U.S. CLS. 100, 101 AND 102).

FIRST USE 2-5-2007; IN COMMERCE 2-5-2007.

ECOCHOICE

THE MARK CONSISTS OF STANDARD CHARACTERS WITHOUT CLAIM TO ANY PARTICULAR FONT, STYLE, SIZE, OR COLOR.

CLASS 19—NON-METALLIC BUILDING MATERIALS

FOR CERAMIC ENAMEL TILES; CERAMIC TILES; CERAMIC TILES FOR FLOORING AND FACING; CERAMIC TILES FOR FLOORING AND LINING; CERAMIC TILES FOR TILE FLOORS AND COVERINGS; FLOOR BOARDS; FLOOR TILES OF WOOD; LAMINATE FLOORING; TILES OF CLAY, GLASS, GYPSUM, CERAMIC OR EARTHENWARE; VINYL TILES; WOOD TILE FLOORS; WOODEN FLOORING (U.S. CLS. 1, 12, 33 AND 50).

FIRST USE 12-6-2006; IN COMMERCE 12-6-2006.

CLASS 27—FLOOR COVERINGS

FOR CARPETING; CARPETS (U.S. CLS. 19, 20, 37, 42 AND 50).

FIRST USE 12-6-2006; IN COMMERCE 12-6-2006.

3,314,899. HY-KO PRODUCTS COMPANY, NORTHFIELD, OH. SN 78-978,580. PUB. 7-18-2006, FILED 11-18-2004.

THE JINGLE KEY CENTER

THE MARK CONSISTS OF STANDARD CHARACTERS WITHOUT CLAIM TO ANY PARTICULAR FONT, STYLE, SIZE, OR COLOR.

NO CLAIM IS MADE TO THE EXCLUSIVE RIGHT TO USE "KEY CENTER", APART FROM THE MARK AS SHOWN.

CLASS 35—ADVERTISING AND BUSINESS

FOR RETAIL STORE SERVICES, NAMELY, RETAIL KIOSKS FEATURING REPLACEMENT KEYS THAT ARE MADE ON-SITE (U.S. CLS. 100, 101 AND 102).

FIRST USE 12-1-2006; IN COMMERCE 12-1-2006.

CLASS 40—MATERIAL TREATMENT

FOR LOCKSMITHING SERVICES, NAMELY, CUSTOM FABRICATION OF KEYS OR LOCKS (U.S. CLS. 100, 103 AND 106).

FIRST USE 12-1-2006; IN COMMERCE 12-1-2006.

OCTOBER 16, 2007

U.S. PATENT AND TRADEMARK OFFICE

TM 1039

3,314,913. OXFORD UNIVERSITY PRESS, INC., NEW YORK, NY. SN 78-978,915. PUB. 9-26-2006, FILED 2-6-2006.

CLASS 41—EDUCATION AND ENTERTAINMENT

FOR PROVIDING ON-LINE, NON-DOWNLOADABLE MONOGRAPHS, BOOKS AND JOURNALS IN THE FIELD OF LAW (U.S. CLS. 100, 101 AND 107).
FIRST USE 12-31-1998; IN COMMERCE 12-31-1998.

OCEANA

CLASS 42—SCIENTIFIC AND COMPUTER SERVICES

FOR PROVIDING AN ON-LINE COMPUTER DATABASE IN THE FIELD OF LEGAL INFORMATION AND LEGAL RESEARCH (U.S. CLS. 100 AND 101).
FIRST USE 12-31-1998; IN COMMERCE 12-31-1998.

THE MARK CONSISTS OF STANDARD CHARACTERS WITHOUT CLAIM TO ANY PARTICULAR FONT, STYLE, SIZE, OR COLOR.

OWNER OF U.S. REG. NOS. 2,209,108 AND 2,377,390.

* * * * *

SECTION 2.— INTERNATIONAL CLASSIFICATION

The short titles associated below with the international class numbers are terms designed merely for quick identification and are not an official part of the international classification. The full names of international classes are given in section 6.1 of the trademark rules of practice.

The designation "U.S. Cl." appearing in this section refers to the U.S. class in effect prior to Sep. 1, 1973 rather than the international class which applies to applications filed on or after that date. For adoption of international classification see notice in the OFFICIAL GAZETTE of Jun. 26, 1973 (911 O.G. TM 210).

Application in one class

CLASS 1—CHEMICALS

3,313,155. PRECISION LABORATORIES, INC., WAUKEGAN, IL. SN 76-644,133. PUB. 10-31-2006, FILED 8-3-2005.



THE COLOR(S) GREEN AND BLACK IS/ARE CLAIMED AS A FEATURE OF THE MARK.

THE MARK CONSISTS OF THE TERM SYNC WITH AN IMAGE LIKE A BLADE OF GRASS EXTENDING THROUGH IT. THE COLOR GREEN APPEARS IN THE BLADE OF GRASS. THE COLOR BLACK APPEARS IN THE TERM SYNC.

FOR AGRICULTURAL CHEMICALS, NAMELY, ADJUVANTS FOR TURF FUNGICIDES (U.S. CLS. 1, 5, 6, 10, 26 AND 46).

FIRST USE 10-0-2005; IN COMMERCE 10-0-2005.

3,313,261. HERCULES INCORPORATED, WILMINGTON, DE. SN 77-006,873. PUB. 3-6-2007, FILED 9-25-2006.

DIMENSION

THE MARK CONSISTS OF STANDARD CHARACTERS WITHOUT CLAIM TO ANY PARTICULAR FONT, STYLE, SIZE, OR COLOR.

FOR CHEMICALS FOR USE IN THE PULP AND PAPER INDUSTRY; CHEMICALS FOR USE IN THE TISSUE CONVERTING INDUSTRY (U.S. CLS. 1, 5, 6, 10, 26 AND 46).

FIRST USE 7-11-2007; IN COMMERCE 7-11-2007.

CLASS 1—(Continued).

3,313,386. AJINOMOTO CO., INC., CHUO-KU, TOKYO, JAPAN. SN 78-263,731. PUB. 7-13-2004, FILED 6-18-2003.

AMISOFT

FOR SURFACE ACTIVE COMPOUNDS FOR GENERAL USE IN THE INDUSTRIAL ARTS, NAMELY, AS WETTING, SPREADING, EMULSIFYING, DISPERSING AND PENETRATING AGENTS MADE FROM ACYL GLUTAMATE (U.S. CLS. 1, 5, 6, 10, 26 AND 46).

FIRST USE 10-31-1972; IN COMMERCE 12-31-1992.

3,313,387. PPG INDUSTRIES OHIO, INC., CLEVELAND, OH. SN 78-263,752. PUB. 2-17-2004, FILED 6-18-2003.

THE "PER"-FECT SOLUTION FOR YOUR DRYCLEANING NEEDS

FOR CHEMICALS FOR USE IN DRY CLEANING (U.S. CLS. 1, 5, 6, 10, 26 AND 46).

FIRST USE 5-31-2006; IN COMMERCE 5-31-2006.

3,313,389. WESTERN FARM SERVICE, INC., FRESNO, CA. SN 78-267,986. PUB. 2-24-2004, FILED 6-27-2003.

QUAD-9

FOR FERTILIZER, WATER-SOLUBLE FOLIAR NUTRITIONAL FERTILIZER, WATER-SOLUBLE FOLIAR NUTRITIONAL FERTILIZER OF MICRONUTRIENTS, FOLIAR FERTILIZER, LOW PH FOLIAR NUTRIENT, LOW CHLORIDE SUSPENSION FOLIAR FERTILIZER (U.S. CLS. 1, 5, 6, 10, 26 AND 46).

FIRST USE 7-0-2003; IN COMMERCE 2-0-2007.

CLASS 1—(Continued).

3,313,433. EPS TECHNOLOGIES, INC., MANKATO, MN. SN 78-383,109. PUB. 8-30-2005, FILED 3-12-2004.

CLASS 1—(Continued).

3,313,479. CHILLICOTHE PAPER INC., CHILLICOTHE, OH. SN 78-472,233. PUB. 12-13-2005, FILED 8-24-2004.

PINNACLE PRIME

CFD

THE MARK CONSISTS OF STANDARD CHARACTERS WITHOUT CLAIM TO ANY PARTICULAR FONT, STYLE, SIZE, OR COLOR.

NO CLAIM IS MADE TO THE EXCLUSIVE RIGHT TO USE "PRIME", APART FROM THE MARK AS SHOWN.

FOR BLEACHED WOOD PULP FOR MANUFACTURING PURPOSES (U.S. CLS. 1, 5, 6, 10, 26 AND 46).

FIRST USE 4-23-1976; IN COMMERCE 4-23-1976.

THE MARK CONSISTS OF STANDARD CHARACTERS WITHOUT CLAIM TO ANY PARTICULAR FONT, STYLE, SIZE, OR COLOR.

FOR LIQUID-BASED CATALYSTS FOR USE IN REDUCING ENVIRONMENTAL EMISSIONS (U.S. CLS. 1, 5, 6, 10, 26 AND 46).

FIRST USE 11-29-2004; IN COMMERCE 5-16-2007.

3,313,559. ECONET, INC., LACEY, WA. SN 78-558,230. PUB. 10-3-2006, FILED 2-1-2005.

3,313,434. EPS TECHNOLOGIES, INC., MANKATO, MN. SN 78-383,277. PUB. 2-28-2006, FILED 3-12-2004.

**CHANGING FLAME
DYNAMICS**

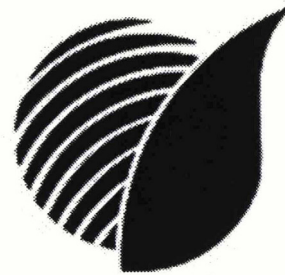

ECONET

THE MARK CONSISTS OF STANDARD CHARACTERS WITHOUT CLAIM TO ANY PARTICULAR FONT, STYLE, SIZE, OR COLOR.

FOR LIQUID BASED CATALYSTS FOR USE IN REDUCING ENVIRONMENTAL EMISSIONS (U.S. CLS. 1, 5, 6, 10, 26 AND 46).

FIRST USE 3-11-2004; IN COMMERCE 5-16-2007.

FOR CHEMICAL ADDITIVES AND BOTANICAL EXTRACTS USED IN THE MANUFACTURE OF COSMETICS, LOTIONS, MEDICATIONS, PHARMACEUTICALS, NUTRICEUTICALS, DIETING AIDS, SUNSCREEN, SKIN REPAIR PREPARATIONS, AFTER SUN EXPOSURE PREPARATIONS, COSMETICS WITH PHARMACEUTICAL PROPERTIES, ANTISEPTICS, DIETARY SUPPLEMENTS, HEALTH FOODS, HEALTH DRINKS, MEDICAL DRINKS AND VETERINARY DIETARY SUPPLEMENTS (U.S. CLS. 1, 5, 6, 10, 26 AND 46).

FIRST USE 4-6-2004; IN COMMERCE 4-6-2004.

CLASS 1—(Continued).

3,313,560. 1,4 GROUP, INC., MERIDIAN, ID. SN 78-559,301. PUB. 9-19-2006, FILED 2-2-2005.

Sprout Torch

THE MARK CONSISTS OF STANDARD CHARACTERS WITHOUT CLAIM TO ANY PARTICULAR FONT, STYLE, SIZE, OR COLOR.

NO CLAIM IS MADE TO THE EXCLUSIVE RIGHT TO USE "SPROUT", APART FROM THE MARK AS SHOWN.

FOR CHEMICAL PLANT GROWTH REGULATORS FOR AGRICULTURAL USE, NAMELY INHIBITORS OF THE GROWTH OF POTATO SPROUTS (U.S. CLS. 1, 5, 6, 10, 26 AND 46).

FIRST USE 5-16-2005; IN COMMERCE 5-16-2005.

3,313,614. MISSISSIPPI LIME COMPANY, ST. LOUIS, MO. SN 78-596,149. PUB. 9-12-2006, FILED 3-28-2005.

CALCARB

THE MARK CONSISTS OF STANDARD CHARACTERS WITHOUT CLAIM TO ANY PARTICULAR FONT, STYLE, SIZE, OR COLOR.

FOR CALCIUM CARBONATE FOR INDUSTRIAL APPLICATIONS NOT INCLUDING THE MANUFACTURE OF GOODS INTENDED FOR HUMAN OR ANIMAL INGESTION (U.S. CLS. 1, 5, 6, 10, 26 AND 46).

FIRST USE 1-0-2007; IN COMMERCE 1-0-2007.

CLASS 1—(Continued).

3,313,860. AMCOL INTERNATIONAL CORPORATION, ARLINGTON HEIGHTS, IL. SN 78-704,430. PUB. 8-8-2006, FILED 8-31-2005.

SEFRONITE

THE MARK CONSISTS OF STANDARD CHARACTERS WITHOUT CLAIM TO ANY PARTICULAR FONT, STYLE, SIZE, OR COLOR.

FOR PURIFIED AND MODIFIED MONTMORILLONITE CLAYS FOR USE IN THE MANUFACTURE OF PHARMACEUTICAL PRODUCTS FOR THE TREATMENT OF VIRAL AND INFECTIOUS DISEASES (U.S. CLS. 1, 5, 6, 10, 26 AND 46).

FIRST USE 11-9-2006; IN COMMERCE 11-9-2006.

3,313,866. POLYONE CORPORATION, AVON LAKE, OH. SN 78-707,166. PUB. 9-5-2006, FILED 9-6-2005.



FOR CONCENTRATES AND COMPOUNDS, CONTAINING NON-METALLIC MINERALS OR MINERAL COMPOSITIONS, FOR USE IN THE MANUFACTURE OF PLASTIC MOLDED OR PLASTIC EXTRUDED ARTICLES (U.S. CLS. 1, 5, 6, 10, 26 AND 46).

FIRST USE 1-26-2007; IN COMMERCE 1-26-2007.

3,313,902. MIDWEST INDUSTRIAL SUPPLY, INC., CANTON, OH. SN 78-720,511. PUB. 10-10-2006, FILED 9-26-2005.

MULCHGARD

THE MARK CONSISTS OF STANDARD CHARACTERS WITHOUT CLAIM TO ANY PARTICULAR FONT, STYLE, SIZE, OR COLOR.

FOR CHEMICAL SPRAYS FOR TREATING AND BINDING MULCH FIBERS TO PREVENT LOSS DUE TO WIND AND RAIN EROSION (U.S. CLS. 1, 5, 6, 10, 26 AND 46).

FIRST USE 6-0-2006; IN COMMERCE 6-0-2006.

CLASS 1—(Continued).

3,313,915. KOST USA, INC., MASON, OH. SN 78-727,362. PUB. 8-15-2006, FILED 10-5-2005.



NO CLAIM IS MADE TO THE EXCLUSIVE RIGHT TO USE "ANTI-CONSUMPTION ADDITIVE", APART FROM THE MARK AS SHOWN.

FOR CHEMICAL BITTERING AGENT TO PREVENT INGESTION OF TOXIC SUBSTANCES (U.S. CLS. 1, 5, 6, 10, 26 AND 46).

FIRST USE 3-31-2006; IN COMMERCE 3-31-2006.

3,314,052. ALLERGAN, INC., IRVINE, CA. SN 78-761,997. PUB. 8-1-2006, FILED 11-28-2005.

SPHERECOL

THE MARK CONSISTS OF STANDARD CHARACTERS WITHOUT CLAIM TO ANY PARTICULAR FONT, STYLE, SIZE, OR COLOR.

FOR COLLAGEN, COLLAGEN BEADS, MICROCARRIERS, AND BIOPOLYMERS USED FOR CELL CULTURE AND TISSUE ENGINEERING FOR SCIENTIFIC AND RESEARCH USE (U.S. CLS. 1, 5, 6, 10, 26 AND 46).

FIRST USE 12-30-2005; IN COMMERCE 2-28-2006.

3,314,139. ASHLAND LICENSING AND INTELLECTUAL PROPERTY LLC, DUBLIN, OH. SN 78-775,838. PUB. 8-1-2006, FILED 12-19-2005.

INVARITORC

THE MARK CONSISTS OF STANDARD CHARACTERS WITHOUT CLAIM TO ANY PARTICULAR FONT, STYLE, SIZE, OR COLOR.

FOR TRANSMISSION FLUID (U.S. CLS. 1, 5, 6, 10, 26 AND 46).

FIRST USE 1-23-2007; IN COMMERCE 1-23-2007.

CLASS 1—(Continued).

3,314,541. HOWARD JOHNSON'S ENTERPRISES, INC., MILWAUKEE, WI. SN 78-869,133. PUB. 12-5-2006, FILED 4-25-2006.

PET-GUARD

THE MARK CONSISTS OF STANDARD CHARACTERS WITHOUT CLAIM TO ANY PARTICULAR FONT, STYLE, SIZE, OR COLOR.

FOR ICE AND SNOW MELTING PREPARATION (U.S. CLS. 1, 5, 6, 10, 26 AND 46).

FIRST USE 8-31-2006; IN COMMERCE 8-31-2006.

3,314,651. VERTELLUS SPECIALTIES INC., INDIANAPOLIS, IN. SN 78-899,355. PUB. 12-26-2006, FILED 6-2-2006.

VERTELLUS

THE MARK CONSISTS OF STANDARD CHARACTERS WITHOUT CLAIM TO ANY PARTICULAR FONT, STYLE, SIZE, OR COLOR.

FOR CHEMICAL INTERMEDIATES AND ADDITIVES FOR USE IN THE AGRO-CHEMICAL, PHARMACEUTICAL, NUTRITION, HUMAN AND ANIMAL HEALTH, PERSONAL CARE, INDUSTRIAL AND ELECTRONICS INDUSTRIES (U.S. CLS. 1, 5, 6, 10, 26 AND 46).

FIRST USE 7-11-2006; IN COMMERCE 10-1-2006.

3,314,672. E. I. DU PONT DE NEMOURS AND COMPANY, WILMINGTON, DE. SN 78-903,419. PUB. 12-19-2006, FILED 6-8-2006.

STATMEDIA

THE MARK CONSISTS OF STANDARD CHARACTERS WITHOUT CLAIM TO ANY PARTICULAR FONT, STYLE, SIZE, OR COLOR.

FOR PRE-MEASURED ENRICHMENT MEDIA IN DISSOLVABLE PACKETS FOR USE IN THE TESTING OF FOOD AND ENVIRONMENTAL SAMPLES FOR PRESENCE OF MICROORGANISMS (U.S. CLS. 1, 5, 6, 10, 26 AND 46).

FIRST USE 12-7-2006; IN COMMERCE 12-7-2006.

CLASS 1—(Continued).

3,314,708. ELLIS, MITCHELL, WILMER, AL. SN 78-912,647.
PUB. 1-2-2007, FILED 6-20-2006.

PRO-WET

THE MARK CONSISTS OF STANDARD CHARACTERS WITHOUT CLAIM TO ANY PARTICULAR FONT, STYLE, SIZE, OR COLOR.

FOR FERTILIZERS FOR AGRICULTURAL USE, NAMELY, LIQUID SOLUBLE FERTILIZER AND WETTING AGENTS (U.S. CLS. 1, 5, 6, 10, 26 AND 46).

FIRST USE 4-18-2007; IN COMMERCE 4-18-2007.

CLASS 1—(Continued).

3,314,784. CARRUBBA, INC., MILFORD, CT. SN 78-940,833.
PUB. 3-20-2007, FILED 7-31-2006.

DEOPLEX

THE MARK CONSISTS OF STANDARD CHARACTERS WITHOUT CLAIM TO ANY PARTICULAR FONT, STYLE, SIZE, OR COLOR.

FOR FERMENTED VEGETABLE PROTEIN ENZYME FOR USE IN INDUSTRIAL, COMMERCIAL, PERSONAL, AND HOUSEHOLD CLEANING AND DEODORIZING PRODUCTS (U.S. CLS. 1, 5, 6, 10, 26 AND 46).

FIRST USE 7-1-2006; IN COMMERCE 7-31-2006.

3,314,748. BRK BRANDS, INC., AURORA, IL. SN 78-925,499.
PUB. 3-6-2007, FILED 7-10-2006.

TUNDRA

THE MARK CONSISTS OF STANDARD CHARACTERS WITHOUT CLAIM TO ANY PARTICULAR FONT, STYLE, SIZE, OR COLOR.

FOR AEROSOL FIRE SUPPRESSANT (U.S. CLS. 1, 5, 6, 10, 26 AND 46).

FIRST USE 12-31-2006; IN COMMERCE 12-31-2006.

3,314,800. MISSISSIPPI LIME COMPANY, ST. LOUIS, MO. SN 78-944,471. PUB. 3-27-2007, FILED 8-3-2006.

MAGNUM FILL

THE MARK CONSISTS OF STANDARD CHARACTERS WITHOUT CLAIM TO ANY PARTICULAR FONT, STYLE, SIZE, OR COLOR.

NO CLAIM IS MADE TO THE EXCLUSIVE RIGHT TO USE "FILL", APART FROM THE MARK AS SHOWN.

FOR CALCIUM CARBONATE (U.S. CLS. 1, 5, 6, 10, 26 AND 46).

FIRST USE 12-0-2006; IN COMMERCE 12-0-2006.

3,314,755. VERTELLUS SPECIALTIES INC., INDIANAPOLIS, IN. SN 78-930,023. PUB. 12-26-2006, FILED 7-14-2006.



FOR CHEMICAL INTERMEDIATES AND ADDITIVES FOR USE IN THE AGRO-CHEMICAL, PHARMACEUTICAL, NUTRITION, HUMAN AND ANIMAL HEALTH, PERSONAL CARE, INDUSTRIAL AND ELECTRONICS INDUSTRIES (U.S. CLS. 1, 5, 6, 10, 26 AND 46).

FIRST USE 7-11-2006; IN COMMERCE 10-1-2006.

CLASS 2—PAINTS

3,313,173. DONGGUAN DABAO CHEMICAL PRODUCTS CO., LTD., DONGGUAN CITY, GUANGDONG, CHINA. SN 76-650,036. PUB. 1-16-2007, FILED 11-9-2005.



STIPPLING IS FOR SHADING PURPOSES ONLY AND IS NOT A FEATURE OF THE MARK.

FOR PAINTS, COLORING PIGMENTS, DYESTUFFS, ANTIRUST PAINTS, THINNERS FOR PAINTS, THICKENERS FOR PAINTS, AGGLUTINANTS FOR PAINTS, SICCATIVES FOR PAINTS, SOLVENTS FOR PAINTS, THINNERS FOR LACQUERS (U.S. CLS. 6, 11 AND 16).

FIRST USE 9-2-1995; IN COMMERCE 8-15-2006.

CLASS 2—(Continued).

3,313,200. BIKE BRITE, INC., MENTOR, OH. SN 76-657,849.
PUB. 12-5-2006, FILED 4-4-2006.

MOTO MASK

THE MARK CONSISTS OF STANDARD CHARACTERS WITHOUT CLAIM TO ANY PARTICULAR FONT, STYLE, SIZE, OR COLOR.

FOR SPRAY ON LIQUID COATING FOR PROTECTION OF PAINTED SURFACES ON VEHICLES (U.S. CLS. 6, 11 AND 16).

FIRST USE 2-3-2007; IN COMMERCE 2-3-2007.

3,313,645. COMPUTERIZED SECURITY SYSTEMS, INC., TROY, MI. SN 78-610,742. PUB. 1-17-2006, FILED 4-18-2005.

EHC

THE MARK CONSISTS OF STANDARD CHARACTERS WITHOUT CLAIM TO ANY PARTICULAR FONT, STYLE, SIZE, OR COLOR.

FOR PROTECTIVE COATING FOR DOOR HARDWARE (U.S. CLS. 6, 11 AND 16).

FIRST USE 8-6-2006; IN COMMERCE 8-6-2006.

3,313,688. SUN CHEMICAL CORPORATION, PARSIPPANY, NJ. SN 78-627,048. PUB. 1-31-2006, FILED 5-10-2005.

MARATHON

THE MARK CONSISTS OF STANDARD CHARACTERS WITHOUT CLAIM TO ANY PARTICULAR FONT, STYLE, SIZE, OR COLOR.

FOR PRINTING INKS (U.S. CLS. 6, 11 AND 16).
FIRST USE 6-0-2005; IN COMMERCE 6-0-2005.

CLASS 2—(Continued).

3,313,827. FAUX EFFECTS INTERNATIONAL, INC., VERO BEACH, FL. SN 78-690,725. PUB. 8-8-2006, FILED 8-11-2005.

RsSandstone

FOR INTERIOR AND EXTERIOR GLAZES, DECORATIVE FINISHES AND PAINTS (U.S. CLS. 6, 11 AND 16).
FIRST USE 10-27-2005; IN COMMERCE 10-27-2005.

3,313,945. NANOSHINE, INC., EVERETT, WA. SN 78-740,882.
PUB. 7-4-2006, FILED 10-26-2005.



THE MARK CONSISTS OF NANOSHINE LETTERS WITH REVERSED SUN BURST ON TOP AND BOTTOM OF NAME.

FOR CLEAR COATING PROTECTANT FOR VEHICLES (U.S. CLS. 6, 11 AND 16).

FIRST USE 11-4-2005; IN COMMERCE 11-4-2005.

3,313,963. HYPERSEAL, INC., RANCHO MIRAGE, CA. SN 78-745,338. PUB. 8-29-2006, FILED 11-2-2005.

HYPERZINC MARINE

THE MARK CONSISTS OF STANDARD CHARACTERS WITHOUT CLAIM TO ANY PARTICULAR FONT, STYLE, SIZE, OR COLOR.

NO CLAIM IS MADE TO THE EXCLUSIVE RIGHT TO USE "MARINE", APART FROM THE MARK AS SHOWN.

FOR CORROSION INHIBITING PAINT TYPE COATINGS FOR COMMERCIAL AND PROFESSIONAL MARINE USE (U.S. CLS. 6, 11 AND 16).

FIRST USE 10-0-2006; IN COMMERCE 10-0-2006.

CLASS 2—(Continued).

3,314,060. SUN CHEMICAL CORPORATION, PARSIPPANY, NJ. SN 78-764,136. PUB. 8-1-2006, FILED 11-30-2005.

FREEDOM

THE MARK CONSISTS OF STANDARD CHARACTERS WITHOUT CLAIM TO ANY PARTICULAR FONT, STYLE, SIZE, OR COLOR.

OWNER OF U.S. REG. NO. 1,626,522.
FOR PRINTING INKS (U.S. CLS. 6, 11 AND 16).
FIRST USE 5-16-1989; IN COMMERCE 8-30-1989.

3,314,277. SUN CHEMICAL CORPORATION, PARSIPPANY, NJ. SN 78-799,639. PUB. 8-1-2006, FILED 1-25-2006.

STREAMLINE

THE MARK CONSISTS OF STANDARD CHARACTERS WITHOUT CLAIM TO ANY PARTICULAR FONT, STYLE, SIZE, OR COLOR.

FOR INK JET PRINTING INK; PRINTING INKS, COATINGS, PIGMENTS, AND DISPERSIONS FOR USE IN THE GRAPHIC ARTS INDUSTRY (U.S. CLS. 6, 11 AND 16).

FIRST USE 7-0-2004; IN COMMERCE 2-0-2006.

CLASS 3—COSMETICS AND CLEANING PREPARATIONS

3,313,015. J&J TECHNOLOGY, LLC, NASHVILLE, TN. SN 76-501,897. PUB. 6-29-2004, FILED 3-28-2003.

RENUIT

FOR CLEANING PRODUCTS, NAMELY, EXTERIOR WOOD CLEANER FOR DECKS, FENCES, LAWN FURNITURE, AND BUILDINGS, INTERIOR WOOD AND FLOOR CLEANER, ALUMINUM AND VINYL SIDING CLEANER, CONCRETE AND ASPHALT CLEANER, MOLD AND MILDEW CLEANER, MULTI PURPOSE CLEANER FOR HOUSEHOLD, COMMERCIAL AND INDUSTRIAL USE, ALL PURPOSE DEGREASING PREPARATIONS NOT FOR USE IN MANUFACTURING PROCESSES FOR USE IN THE HOUSEHOLD, COMMERCIAL AND INDUSTRIAL FIELDS, HOUSE WASH, SUPER METAL POLISH, CLEANING PREPARATIONS FOR USE ON MARINE VEHICLES, CARPET CLEANERS, FLOOR CLEANERS, SPOT AND SPRAY CLEANERS FOR CLOTHING AND FABRICS (U.S. CLS. 1, 4, 6, 50, 51 AND 52).

FIRST USE 1-0-2005; IN COMMERCE 1-0-2005.

CLASS 3—(Continued).

3,313,020. GABET, RENEE A., LIGONIER, IN. SN 76-515,185. PUB. 4-6-2004, FILED 5-19-2003.

RIDE THE SPIRIT

FOR COSMETIC AND TOILET PREPARATIONS AND PERSONAL CARE PRODUCTS NAMELY, PERFUME, PERFUME ESSENCE, COLOGNE, AFTERSHAVE, AND SHOWER GEL (U.S. CLS. 1, 4, 6, 50, 51 AND 52).
FIRST USE 2-20-2007; IN COMMERCE 2-20-2007.

3,313,032. PALMA POLONIO, MARIA AMPARO, 28109 ALCOBENDAS (MADRID), SPAIN. SN 76-531,413. PUB. 1-18-2005, FILED 7-21-2003.

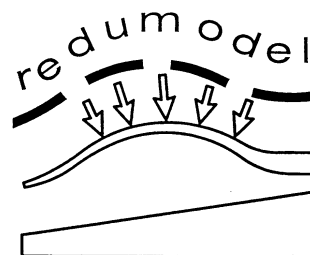

FOR PERFUME, COSMETICS AND BEAUTY GOODS, NAMELY, ANTI-CELLULITE CREAMS AND LOTIONS (U.S. CLS. 1, 4, 6, 50, 51 AND 52).

FIRST USE 12-31-1997; IN COMMERCE 12-31-1997.

3,313,131. MITSUBISHI GAS CHEMICAL COMPANY, INC., CHIYODA-KU, TOKYO, JAPAN. SN 76-638,512. PUB. 9-12-2006, FILED 5-12-2005.

BLU-ELM

FOR RESIST STRIPPING PREPARATIONS CONTAINING HYDROGEN PEROXIDE FOR SEMICONDUCTOR INTEGRATED CIRCUITS; CLEANING PREPARATIONS USED FOR THE REMOVAL OF POLYMER AND RESIST FROM SEMICONDUCTOR INTEGRATED CIRCUITS; CLEANING PREPARATIONS USED FOR THE REMOVAL OF SIDEWALL POLYMER FROM SEMICONDUCTOR INTEGRATED CIRCUITS (U.S. CLS. 1, 4, 6, 50, 51 AND 52).

FIRST USE 7-0-2003; IN COMMERCE 7-0-2003.

CLASS 3—(Continued).

3,313,133. LAMOON, INC., WESTMINSTER, CA. SN 76-639,537. PUB. 5-9-2006, FILED 5-25-2005.



PRÉCISION

OWNER OF U.S. REG. NO. 2,566,713.
FOR COSMETIC NAIL CARE PRODUCTS, NAMELY, ARTIFICIAL NAILS AND NAIL POLISH; NAIL TREATMENT PRODUCTS, NAMELY, NAIL POLISH TOP COAT, NAIL POLISH BASE COAT, NAIL POLISH TOP SEALING COAT, CUTICLE CONDITIONING OIL, CUTICLE REMOVING PREPARATIONS, ACRYLIC POWDER FOR AFFIXING ARTIFICIAL NAILS, ACRYLIC POWDER FOR USE AS NAIL RIDGE FILLERS IN MAINTAINING ARTIFICIAL NAILS, AND UV GELS AND UV POWDERS FOR MAKING ARTIFICIAL NAILS; ALL OF FOREGOING FOR SALE NOT THROUGH RETAIL OUTLETS (U.S. CLS. 1, 4, 6, 50, 51 AND 52).
FIRST USE 6-0-2005; IN COMMERCE 6-0-2005.

3,313,228. ALPHA TECH PET INC., LEXINGTON, MA. SN 76-665,765. PUB. 5-22-2007, FILED 9-8-2006.

LAUNDRAPET

THE MARK CONSISTS OF STANDARD CHARACTERS WITHOUT CLAIM TO ANY PARTICULAR FONT, STYLE, SIZE, OR COLOR.
FOR PREMIUM PET FACILITY LAUNDRY DETERGENT FOR USE IN ANIMAL SHELTERS, KENNELS, VETERINARY FACILITIES, HUMANE SOCIETIES, ETC (U.S. CLS. 1, 4, 6, 50, 51 AND 52).
FIRST USE 8-29-2006; IN COMMERCE 8-29-2006.

3,313,309. SUPRE, INC., DALLAS, TX. SN 77-030,747. PUB. 5-29-2007, FILED 10-27-2006.

Romp

THE MARK CONSISTS OF STANDARD CHARACTERS WITHOUT CLAIM TO ANY PARTICULAR FONT, STYLE, SIZE, OR COLOR.
FOR TANNING LOTION (U.S. CLS. 1, 4, 6, 50, 51 AND 52).
FIRST USE 12-1-2006; IN COMMERCE 12-1-2006.

CLASS 3—(Continued).

3,313,336. AHOLD LICENSING SA, GENEVA, SWITZERLAND. SN 77-064,963. PUB. 5-1-2007, FILED 12-15-2006.

FRUITY FUN

THE MARK CONSISTS OF STANDARD CHARACTERS WITHOUT CLAIM TO ANY PARTICULAR FONT, STYLE, SIZE, OR COLOR.
FOR LIQUID SOAPS (U.S. CLS. 1, 4, 6, 50, 51 AND 52).
FIRST USE 3-25-2007; IN COMMERCE 3-25-2007.

3,313,357. VICTORIA'S SECRET STORES BRAND MANAGEMENT, INC., REYNOLDSBURG, OH. SN 78-140,638. PUB. 5-20-2003, FILED 7-2-2002.

LUMINOUSPHERES

THE MARK CONSISTS OF STANDARD CHARACTERS WITHOUT CLAIM TO ANY PARTICULAR FONT, STYLE, SIZE, OR COLOR.
FOR PERSONAL CARE PRODUCTS, NAMELY, AFTERSHAVE, ANTIPERSPIRANT, ARTIFICIAL NAILS, ASTRINGENT FOR THE FACE, ASTRINGENT FOR THE SKIN, BATH BEADS, BATH OIL, BATH SALTS, BLUSH, BODY GLITTER, BODY OIL, BODY SCRUB, BUBBLE BATH, COLOGNE, CREAM FOR THE BODY, CREAM FOR THE CUTICLES, CREAM FOR THE EYES, CREAM FOR THE FACE, CREAM FOR THE HANDS, DEODORANT, ESSENTIAL OILS, EXFOLIATORS FOR THE SKIN, EYE GELS, EYE MAKEUP PENCILS, EYE SHADOW, FACE HIGHLIGHTER, FACIAL MASKS, FACE MIST, FACE SCRUB, FOOT SOAK, FOUNDATION, FRAGRANT BODY MIST, FRAGRANT BODY SPLASH, HAIR CONDITIONER, HAIR DYES, HAIR GLITTER, HAIR HIGHLIGHTER, HAIR MASCARA, HAIR POMADE, HAIR RINSES, HAIR REMOVING CREAMS, HAIR SHAMPOO, HAIR SPRAY, HAIR STRAIGHTENER, HAIR STYLING GEL, HAIR STYLING MOUSSE, LOTION FOR THE BODY, LOTION FOR THE FACE, LOTION FOR THE HANDS, LIP BALM, LIP GLOSS, LIP LINER, LIP MAKEUP PENCILS, LIPSTICK, MAKEUP FOR THE BODY, MAKEUP FOR THE FACE, MAKEUP REMOVER, MASCARA, NAIL CORRECTOR PENS, NAIL POLISH, NAIL POLISH REMOVER, NAIL STENCILS,

CLASS 3—(Continued).

NON-MEDICATED BLEMISH STICK, NON-MEDICATED CLEANSER FOR THE FACE, NON-MEDICATED FOOT SPRAY, NON-MEDICATED MOOD ENHANCING MASSAGE OINTMENT, NON-MEDICATED MOOD ENHANCING SKIN CREAM, OIL BLOTTER SHEETS FOR THE SKIN, PERFUME, POWDER FOR THE BODY, POWDER FOR THE FACE, POWDER FOR THE FEET, PUMICE STONES FOR PERSONAL USE, SALT SCRUBS FOR THE SKIN, SHAVING CREAM, SHOWER GEL, SKIN BRONZING CREAM, SOAP FOR THE BODY, SOAP FOR THE FACE, SOAP FOR THE HANDS, SUN BLOCK FOR THE BODY, SUN BLOCK FOR THE FACE, SUNTAN LOTION FOR THE BODY, SUNTAN LOTION FOR THE FACE, SUNLESS TANNING LOTION FOR THE BODY, SUNLESS TANNING LOTION FOR THE FACE, PRE-SUNTANNING LOTION FOR THE BODY, PRESUNTANNING LOTION OR THE FACE, POST-SUNTANNING LOTION FOR THE BODY, POST-SUNTANNING LOTION FOR THE FACE AND TALCUM POWDER ALL FEATURING A SPECIAL BLEND OF INGREDIENTS (U.S. CLS. 1, 4, 6, 50, 51 AND 52).

FIRST USE 8-1-2006; IN COMMERCE 8-1-2006.

3,313,362. PHILOSOPHY, INC., PHOENIX, AZ. SN 78-178,890. PUB. 12-30-2003, FILED 10-28-2002.

PORTABLE THERAPY

NO CLAIM IS MADE TO THE EXCLUSIVE RIGHT TO USE "PORTABLE", APART FROM THE MARK AS SHOWN. FOR FRAGRANCES, NAMELY, PERFUME; FACE AND BODY CREAM; HAIR CARE PRODUCTS, NAMELY, SHAMPOO; BATH CARE PRODUCTS, NAMELY, GEL, AND BUBBLE BATH (U.S. CLS. 1, 4, 6, 50, 51 AND 52).

FIRST USE 2-13-2007; IN COMMERCE 2-13-2007.

3,313,380. NEW PHAZE PACKAGING, INC., CHATSWORTH, CA. SN 78-253,737. PUB. 1-20-2004, FILED 5-23-2003.

MOTO-BALM

OWNER OF U.S. REG. NO. 2,642,162. FOR SUN SCREEN AND SUN BLOCK PREPARATIONS FOR USE ON THE SKIN (U.S. CLS. 1, 4, 6, 50, 51 AND 52).

FIRST USE 11-0-2003; IN COMMERCE 11-0-2003.

CLASS 3—(Continued).

3,313,392. GROUP LOTUS, PLC, NORFOLK, UNITED KINGDOM. SN 78-269,444. PUB. 7-5-2005, FILED 7-1-2003.

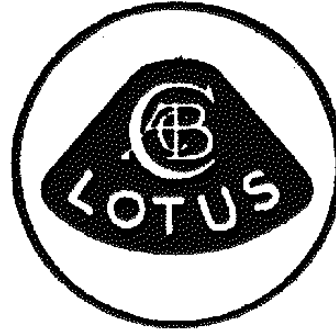

NO CLAIM IS MADE TO THE EXCLUSIVE RIGHT TO USE "LOTUS", APART FROM THE MARK AS SHOWN.

FOR NON-MEDICATED SKIN PRODUCTS AND FRAGRANCES, NAMELY, COLOGNE, AFTER SHAVE, PERFUME, DEODORANT, SKIN LOTION AND SHAVING CREAM (U.S. CLS. 1, 4, 6, 50, 51 AND 52).

FIRST USE 5-0-2006; IN COMMERCE 5-0-2006.

3,313,407. UNILEVER SUPPLY CHAIN, INC., CLINTON, CT. SN 78-323,545. PUB. 8-10-2004, FILED 11-5-2003.

ANTI-FLAT

THE MARK CONSISTS OF STANDARD CHARACTERS WITHOUT CLAIM TO ANY PARTICULAR FONT, STYLE, SIZE, OR COLOR.

FOR HAIR CARE PRODUCTS, NAMELY, SHAMPOO AND CONDITIONER (U.S. CLS. 1, 4, 6, 50, 51 AND 52).

FIRST USE 6-18-2006; IN COMMERCE 6-18-2006.

CLASS 3—(Continued).

3,313,427. UNILEVER SUPPLY CHAIN, INC., CLINTON, CT. SN 78-373,654. PUB. 9-6-2005, FILED 2-25-2004.

SUNSILK

THE MARK CONSISTS OF STANDARD CHARACTERS WITHOUT CLAIM TO ANY PARTICULAR FONT, STYLE, SIZE, OR COLOR.

OWNER OF U.S. REG. NO. 2,594,734. FOR HAIR CARE PRODUCTS, NAMELY, SHAMPOO AND CONDITIONER (U.S. CLS. 1, 4, 6, 50, 51 AND 52). FIRST USE 6-18-2006; IN COMMERCE 6-18-2006.

CLASS 3—(Continued).

3,313,458. NEW VISION USA, INC., SCOTTSDALE, AZ. SN 78-431,997. PUB. 10-25-2005, FILED 6-8-2004.



OWNER OF U.S. REG. NOS. 2,006,337, 2,033,825, AND 2,351,498.

NO CLAIM IS MADE TO THE EXCLUSIVE RIGHT TO USE "SPA", APART FROM THE MARK AS SHOWN. FOR COSMETICS AND PERSONAL CARE PREPARATIONS, NAMELY, SKIN LOTIONS, SKIN CLEANSERS, MOISTURIZERS, SUNSCREENS, SHAMPOO AND HAIR CONDITIONER (U.S. CLS. 1, 4, 6, 50, 51 AND 52). FIRST USE 9-4-2003; IN COMMERCE 6-8-2000.

3,313,451. BOOTS RETAIL HOLDINGS (USA) INC., STAMFORD, CT. SN 78-423,984. PUB. 10-11-2005, FILED 5-24-2004.



OWNER OF U.S. REG. NO. 2,133,895. THE MARK CONSISTS OF NO 7 IN SPECIAL STYLIZED FORM.

FOR NON-MEDICATED TOILET PREPARATIONS, NAMELY, FACIAL MOISTURIZERS AND FACE MASKS; COSMETICS (U.S. CLS. 1, 4, 6, 50, 51 AND 52). FIRST USE 2-7-2005; IN COMMERCE 5-0-2005.

3,313,459. ARAMIS INC., NEW YORK, NY. SN 78-434,643. PUB. 11-30-2004, FILED 6-14-2004.

ARAMIS ALWAYS

THE MARK CONSISTS OF STANDARD CHARACTERS WITHOUT CLAIM TO ANY PARTICULAR FONT, STYLE, SIZE, OR COLOR.

FOR PERFUME, COLOGNE, AFTERSHAVE (U.S. CLS. 1, 4, 6, 50, 51 AND 52). FIRST USE 11-30-2005; IN COMMERCE 11-30-2005.

CLASS 3—(Continued).

3,313,460. CLINICAL-BASIC SKIN CARE, INC., O'FALLON, MO. SN 78-436,442. PUB. 9-27-2005, FILED 6-16-2004.

SHARRONTHEBLENDER

THE MARK CONSISTS OF STANDARD CHARACTERS WITHOUT CLAIM TO ANY PARTICULAR FONT, STYLE, SIZE, OR COLOR.

FOR NON-MEDICATED SKIN CARE PREPARATIONS; SKIN CARE PRODUCTS, NAMELY, NON-MEDICATED HAND, BODY AND FACIAL CREAMS, LOTIONS, GELS, CLARIFIERS, CLEANSERS, CONDITIONERS, EMOLLIENTS, MOISTURIZERS, SOAPS, TEXTURIZERS, AND TONERS (U.S. CLS. 1, 4, 6, 50, 51 AND 52).

FIRST USE 5-10-2005; IN COMMERCE 5-10-2005.

3,313,472. ESTEE LAUDER INC., NEW YORK, NY. SN 78-458,906. PUB. 10-4-2005, FILED 7-29-2004.

**ESTÉE LAUDER
Cyber  White**

OWNER OF U.S. REG. NOS. 530,305, 1,297,116, AND OTHERS.

THE NAME ESTEE LAUDER SHOWN IN THE MARK DOES NOT IDENTIFY A PARTICULAR LIVING INDIVIDUAL.

THE MARK CONSISTS OF THE WORDS ESTEE LAUDER CYBER WHITE AND A STAR DESIGN.

FOR NON-MEDICATED SKINCARE PREPARATIONS, NAMELY, CLEANSER, LOTION, CREME, TONER AND EXFOLIATOR FOR THE FACE (U.S. CLS. 1, 4, 6, 50, 51 AND 52).

FIRST USE 12-31-2005; IN COMMERCE 12-31-2005.

3,313,476. BIOELEMENTS, INC., COLORADO SPRINGS, CO. SN 78-464,979. PUB. 12-26-2006, FILED 8-10-2004.

LIP BUFF

THE MARK CONSISTS OF STANDARD CHARACTERS WITHOUT CLAIM TO ANY PARTICULAR FONT, STYLE, SIZE, OR COLOR.

NO CLAIM IS MADE TO THE EXCLUSIVE RIGHT TO USE "LIP", APART FROM THE MARK AS SHOWN.

FOR NON-MEDICATED LIP EXFOLIATOR AND LIP MOISTURIZER (U.S. CLS. 1, 4, 6, 50, 51 AND 52).

FIRST USE 1-0-2005; IN COMMERCE 1-0-2005.

CLASS 3—(Continued).

3,313,483. ELYSEE SCIENTIFIC COSMETICS, INC., VERONA, WI. SN 78-480,357. PUB. 8-30-2005, FILED 9-8-2004.

COLLABOOST

THE MARK CONSISTS OF STANDARD CHARACTERS WITHOUT CLAIM TO ANY PARTICULAR FONT, STYLE, SIZE, OR COLOR.

FOR FACIAL AND BODY GEL, CREAM AND LOTION (U.S. CLS. 1, 4, 6, 50, 51 AND 52).

FIRST USE 7-6-2004; IN COMMERCE 7-6-2004.

3,313,555. QUALITY COSMETICS CORP., SOUTH PLAINFIELD, NJ. SN 78-551,256. PUB. 3-14-2006, FILED 1-20-2005.

Lethal Plump

THE MARK CONSISTS OF STANDARD CHARACTERS WITHOUT CLAIM TO ANY PARTICULAR FONT, STYLE, SIZE, OR COLOR.

FOR COSMETICS FOR LIPS, NAMELY, LIP STICK, LIP ENHANCER, LIP PLUMPER, LIP STAIN, LIP GLOSS, LIP SALVE, LIP BALM, LIP MOISTURIZER (U.S. CLS. 1, 4, 6, 50, 51 AND 52).

FIRST USE 1-1-2006; IN COMMERCE 1-1-2006.

3,313,586. L'OREAL USA CREATIVE, INC., NEW YORK, NY. SN 78-581,637. PUB. 3-6-2007, FILED 3-7-2005.

**NYMPHAEA ALBA UV
SHIELD**

THE MARK CONSISTS OF STANDARD CHARACTERS WITHOUT CLAIM TO ANY PARTICULAR FONT, STYLE, SIZE, OR COLOR.

NO CLAIM IS MADE TO THE EXCLUSIVE RIGHT TO USE "NYMPHAEA ALBA" OR "UV", APART FROM THE MARK AS SHOWN.

FOR NON-MEDICATED SKIN CARE PREPARATIONS, NAMELY, A MOISTURIZING LOTION WITH SUNSCREEN (U.S. CLS. 1, 4, 6, 50, 51 AND 52).

FIRST USE 10-1-2006; IN COMMERCE 10-1-2006.

CLASS 3—(Continued).

3,313,600. HENKEL KGAA, DUESSELDORF, FED REP GERMANY. SN 78-586,697. PUB. 7-4-2006, FILED 3-14-2005.

CLASS 3—(Continued).

3,313,669. MYSTIC TAN, INC., FARMERS BRANCH, TX. SN 78-621,660. PUB. 8-22-2006, FILED 5-3-2005.

IN 2 SPA

THE MARK CONSISTS OF STANDARD CHARACTERS WITHOUT CLAIM TO ANY PARTICULAR FONT, STYLE, SIZE, OR COLOR.

OWNER OF U.S. REG. NO. 2,925,733.
NO CLAIM IS MADE TO THE EXCLUSIVE RIGHT TO USE "SPA", APART FROM THE MARK AS SHOWN.
FOR NON-MEDICATED SKIN CARE PREPARATIONS (U.S. CLS. 1, 4, 6, 50, 51 AND 52).
FIRST USE 7-20-2005; IN COMMERCE 7-25-2005.

MYSTICGLO

THE MARK CONSISTS OF STANDARD CHARACTERS WITHOUT CLAIM TO ANY PARTICULAR FONT, STYLE, SIZE, OR COLOR.

FOR SKIN CREAM (U.S. CLS. 1, 4, 6, 50, 51 AND 52).
FIRST USE 3-0-2005; IN COMMERCE 3-0-2005.

3,313,691. COEUR À COEUR FASHION BEAUTY PRODUCTS, EDEN PRAIRIE, MN. SN 78-627,815. PUB. 2-14-2006, FILED 5-11-2005.

Coeur À Coeur Fashion Beauty Products

THE MARK CONSISTS OF STANDARD CHARACTERS WITHOUT CLAIM TO ANY PARTICULAR FONT, STYLE, SIZE, OR COLOR.

NO CLAIM IS MADE TO THE EXCLUSIVE RIGHT TO USE "FASHION BEAUTY PRODUCTS", APART FROM THE MARK AS SHOWN.

THE ENGLISH TRANSLATION OF THE "COEUR À COEUR" IS "HEART TO HEART."

FOR SHAMPOO, CONDITIONERS AND BEAUTY PRODUCTS, NAMELY, BODY AND BEAUTY CARE COSMETICS, AND BODY AND BEAUTY CARE PREPARATIONS (U.S. CLS. 1, 4, 6, 50, 51 AND 52).

FIRST USE 8-28-2006; IN COMMERCE 8-28-2006.

3,313,666. TRACI SCOTT, L.L.C., HOUSTON, TX. SN 78-620,314. PUB. 1-31-2006, FILED 4-29-2005.

REAL HAIR AND SOUL CARE

THE MARK CONSISTS OF STANDARD CHARACTERS WITHOUT CLAIM TO ANY PARTICULAR FONT, STYLE, SIZE, OR COLOR.

FOR HAIR CARE PRODUCTS, NAMELY, HAIR SHAMPOOS, HAIR CONDITIONERS, HAIR RINSES, HAIR STYLING PREPARATIONS, HAIR STYLING SPRAY, HAIR SPRAY, HAIR GELS, HAIR MOUSSES, HAIR NOURISHERS, HAIR RELAXING PREPARATIONS, HAIR STRAIGHTENING PREPARATIONS, HAIR WAVING LOTION, HAIR CARE CREAMS, HAIR CARE LOTIONS, HAIR DRESSINGS FOR MEN, HAIR EMOLLIENTS, HAIR EXFOLIANTS, HAIR COLOR, HAIR COLOR REMOVERS, HAIR BLEACHING PREPARATIONS, HAIR FROSTS, HAIR LIGHTENERS, HAIR LACQUERS, HAIR OILS, HAIR POMADES, HAIR TONICS, HAIR-WASHING POWDER; ESSENTIAL OILS FOR PERSONAL USE (U.S. CLS. 1, 4, 6, 50, 51 AND 52).
FIRST USE 4-17-2007; IN COMMERCE 4-17-2007.

3,313,694. THE PROCTER & GAMBLE COMPANY, CINCINNATI, OH. SN 78-628,884. PUB. 8-29-2006, FILED 5-12-2005.

WINTER SOLUTION

THE MARK CONSISTS OF STANDARD CHARACTERS WITHOUT CLAIM TO ANY PARTICULAR FONT, STYLE, SIZE, OR COLOR.

NO CLAIM IS MADE TO THE EXCLUSIVE RIGHT TO USE "SOLUTION", APART FROM THE MARK AS SHOWN.

FOR FABRIC SOFTENER (U.S. CLS. 1, 4, 6, 50, 51 AND 52).

FIRST USE 9-30-2005; IN COMMERCE 9-30-2005.

CLASS 3—(Continued).

3,313,706. BATH & BODY WORKS, INC., REYNOLDSBURG, OH. SN 78-637,214. PUB. 9-5-2006, FILED 5-25-2005.

TIRAMISU VENEZIANO

THE MARK CONSISTS OF STANDARD CHARACTERS WITHOUT CLAIM TO ANY PARTICULAR FONT, STYLE, SIZE, OR COLOR.

THE ENGLISH TRANSLATION OF THE WORD VENEZIANO IN THE MARK IS "VENETIAN".

FOR PERSONAL CARE PRODUCTS, NAMELY, BATH MILK, BATH POWDER, BATH SALTS, BATH NON-MEDICATED BODY SOAKS, BATH SUGAR, BODY BUFF, BODY CREAM, BODY LOTION, BODY MILK, BODY POLISH, BODY SCRUB, BODY SOUFFLE, BODY WASH, EAU DE TOILETTE, EFFERVESCENT BATH CUBES, FACE MASKS, NAMELY, FACIAL BEAUTY MASKS; FACIAL CLEANSER, NON-MEDICATED FOOT CREAM; NON-MEDICATED FOOT LOTION, FRAGRANT BODY SPRAY, HAND CREAM, HAND LOTION, HONEY BATH GEL; LIP BALM, LIP GLOSS, SALT BODY SCRUB, SHOWER GEL, SOAP FOR THE BODY, SOAP FOR THE FACE, SOAP FOR THE HANDS, SUGAR BODY (U.S. CLS. 1, 4, 6, 50, 51 AND 52).

FIRST USE 9-30-2005; IN COMMERCE 9-30-2005.

3,313,740. HORMELL, MICHELLE ROARK, DENVER, CO. SN 78-651,628. PUB. 9-12-2006, FILED 6-15-2005.

Phinomenal

THE MARK CONSISTS OF STANDARD CHARACTERS WITHOUT CLAIM TO ANY PARTICULAR FONT, STYLE, SIZE, OR COLOR.

FOR PERFUMES AND COSMETICS, NAMELY, FRAGRANCE, PERFUME OIL, PERFUME SOLID, COLOGNE, TOILET SPRAY, COSMETICS, MAKEUP, LIPSTICK (U.S. CLS. 1, 4, 6, 50, 51 AND 52).

FIRST USE 9-30-2005; IN COMMERCE 11-30-2006.

3,313,752. KLINGER ADVANCED AESTHETICS, INC., NORWALK, CT. SN 78-655,722. PUB. 3-7-2006, FILED 6-22-2005.

OPTI-MOLOGIST

THE MARK CONSISTS OF STANDARD CHARACTERS WITHOUT CLAIM TO ANY PARTICULAR FONT, STYLE, SIZE, OR COLOR.

FOR EYE CREME (U.S. CLS. 1, 4, 6, 50, 51 AND 52).

FIRST USE 4-0-2006; IN COMMERCE 4-0-2006.

CLASS 3—(Continued).

3,313,810. PURONYX, INC., SAN DIEGO, CA. SN 78-682,634. PUB. 8-22-2006, FILED 8-1-2005.

BELLY ITCH

THE MARK CONSISTS OF STANDARD CHARACTERS WITHOUT CLAIM TO ANY PARTICULAR FONT, STYLE, SIZE, OR COLOR.

NO CLAIM IS MADE TO THE EXCLUSIVE RIGHT TO USE "BELLY", APART FROM THE MARK AS SHOWN.

FOR SKIN LOTIONS (U.S. CLS. 1, 4, 6, 50, 51 AND 52).

FIRST USE 1-6-2006; IN COMMERCE 3-16-2006.

3,313,850. U.S. NONWOVENS CORP., BRENTWOOD, NY. SN 78-701,057. PUB. 6-20-2006, FILED 8-26-2005.

PERFECTO

THE MARK CONSISTS OF STANDARD CHARACTERS WITHOUT CLAIM TO ANY PARTICULAR FONT, STYLE, SIZE, OR COLOR.

THE ENGLISH TRANSLATION OF THE WORD "PERFECTO" IN THE MARK IS "PERFECT".

FOR HOUSEHOLD CLEANING AND LAUNDRY CARE PRODUCTS, SPECIFICALLY LAUNDRY DETERGENT (U.S. CLS. 1, 4, 6, 50, 51 AND 52).

FIRST USE 2-12-2007; IN COMMERCE 2-12-2007.

3,313,907. FUSION BRANDS INTERNATIONAL SRL, BELLEVILLE, ST., MICHAEL, BARBADOS. SN 78-724,173. PUB. 9-19-2006, FILED 9-30-2005.

TOPICAL-INJECTABLES

THE MARK CONSISTS OF STANDARD CHARACTERS WITHOUT CLAIM TO ANY PARTICULAR FONT, STYLE, SIZE, OR COLOR.

FOR NON-MEDICATED SKIN CARE PREPARATIONS (U.S. CLS. 1, 4, 6, 50, 51 AND 52).

FIRST USE 3-1-2006; IN COMMERCE 3-1-2006.

CLASS 3—(Continued).

3,313,953. VICTORIA'S SECRET STORES BRAND MANAGEMENT, INC., REYNOLDSBURG, OH. SN 78-742,523. PUB. 1-16-2007, FILED 10-28-2005.

CLASS 3—(Continued).

3,313,957. U.S. KINGKING, LLC, BENTONVILLE, AR. SN 78-743,819. PUB. 8-1-2006, FILED 10-31-2005.

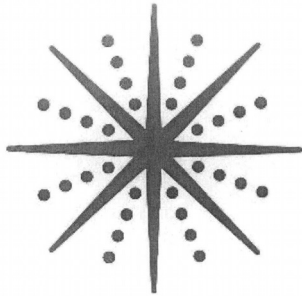

NO CLAIM IS MADE TO THE EXCLUSIVE RIGHT TO USE "SPA", APART FROM THE MARK AS SHOWN.

THE COLOR(S) BLACK IS/ARE CLAIMED AS A FEATURE OF THE MARK.

THE MARK CONSISTS OF "SPA ELEGANCE" IN BLACK. FOR BATH BEADS; BATH CRYSTALS; BATH FOAM; BATH FOAMS; BATH GEL; BATH GELS; BATH LOTION; BATH MILKS; BATH OIL; BATH OILS; BATH OILS FOR COSMETIC PURPOSES; BATH SALTS; BATH SOAPS IN LIQUID, SOLID OR GEL FORM; BATHING LOTIONS; BUBBLE BATH; FOAM BATH; LIQUID BATH SOAPS; POTPOURRI (U.S. CLS. 1, 4, 6, 50, 51 AND 52).

FIRST USE 1-1-2006; IN COMMERCE 10-1-2006.

3,313,981. PHILOSOPHY, INC., PHOENIX, AZ. SN 78-749,329. PUB. 12-26-2006, FILED 11-8-2005.

FOR BLUSH, BODY GLITTER, CREAM FOR THE CUTICLES, CREAM FOR THE EYES, CREAM FOR THE FEET, EXFOLIATING PREPARATIONS FOR THE SKIN, EYE GELS, EYE MAKEUP PENCILS, EYE MASKS, EYE SHADOW, FACE MASKS, FACE MIST, FACE SCRUB, NON-MEDICATED FOOT SOAKS, FACE TONERS, FOUNDATION, HAIR CONDITIONER, HAIR DYES, HAIR GLITTER, HAIR MASCARA, HAIR RINSES, HAIR SHAMPOO, HAIR SPRAY, HAIR STYLING GEL, HAIR STYLING MOUSSE, LOTION FOR THE FEET, LIP BALM, LIP GLOSS, LIP LINER, LIP MAKEUP PENCILS, LIPSTICK, MAKEUP FOR THE BODY, MAKEUP FOR THE FACE, MAKEUP REMOVER, MASCARA, MASSAGE CREAM, MASSAGE LOTION, MASSAGE OIL, NAIL POLISH, NAIL POLISH REMOVER, NON-MEDICATED BLEMISH STICK, NON-MEDICATED FOOT SPRAY, OIL BLOTTING SHEETS FOR THE SKIN, POWDER FOR THE FACE, POWDER FOR THE FEET, SKIN BRONZING CREAM, SUN BLOCK FOR THE BODY, SUN BLOCK FOR THE FACE, SUNTAN LOTION FOR THE BODY, SUNTAN LOTION FOR THE FACE, SUNLESS TANNING LOTION FOR THE BODY, SUNLESS TANNING LOTION FOR THE FACE, PRE-SUNTANNING LOTION FOR THE BODY, PRE-SUNTANNING LOTION FOR THE FACE, POST-SUNTANNING LOTION FOR THE BODY, POST-SUNTANNING LOTION FOR THE FACE (U.S. CLS. 1, 4, 6, 50, 51 AND 52).
FIRST USE 4-21-2006; IN COMMERCE 4-21-2006.

DO YOU WANT TO BE THE BEFORE OR AFTER?

THE MARK CONSISTS OF STANDARD CHARACTERS WITHOUT CLAIM TO ANY PARTICULAR FONT, STYLE, SIZE, OR COLOR.

FOR SKIN CARE KITS CONTAINING NON-MEDICATED SKIN CARE PREPARATIONS, NAMELY, CONDITIONER, EXFOLIANTS, AND SKIN CLARIFIER (U.S. CLS. 1, 4, 6, 50, 51 AND 52).
FIRST USE 3-12-2007; IN COMMERCE 3-12-2007.

CLASS 3—(Continued).

3,313,988. SHAMBAN, AVA T., SANTA MONICA, CA. SN 78-749,800. PUB. 9-5-2006, FILED 11-8-2005.

AVA MD EXTREME SPECIALIST

THE MARK CONSISTS OF STANDARD CHARACTERS WITHOUT CLAIM TO ANY PARTICULAR FONT, STYLE, SIZE, OR COLOR.

NO CLAIM IS MADE TO THE EXCLUSIVE RIGHT TO USE "MD", APART FROM THE MARK AS SHOWN.

FOR COSMETICS; FACE CREAM; FACE LOTION; FACIAL CLEANSER; FACIAL TONER; FACE MASK; EYE CREAM; FACE SERUM; NECK CREAM; NECK LOTION; LIP TREATMENT, NAMELY, NON-MEDICATED LIP CARE PREPARATIONS; BODY LOTION; HAND CREAM; CUTICLE CREAM; MAKEUP; FACE POWDER; CONCEALER; LIP COLOR; LIP GLOSS; LIP STICK; CHEEK COLOR; EYE SHADOW; LIP PENCIL; EYE PENCIL; EYEBROW PENCIL; MASCARA; BODY OIL; NIGHT CREAM; EYE MAKEUP; EYELINER; FACIAL SCRUB; SKIN MOISTURIZER; SKIN CLARIFIERS; SUNSCREEN PREPARATIONS; WRINKLE REMOVING SKIN CARE PREPARATIONS; SKIN PEELS; PRIMERS, NAMELY, FACE PRIMER, LIP PRIMER, EYE PRIMER, LASH PRIMER, AND BROW PRIMER; FOOT CREAM; BODY EXFOLIATOR; BATH AND SHOWER GEL AND SOAP (U.S. CLS. 1, 4, 6, 50, 51 AND 52).

FIRST USE 8-22-2006; IN COMMERCE 8-22-2006.

3,313,997. PLAYTEX MARKETING CORP., NEW YORK, NY. SN 78-750,648. PUB. 1-23-2007, FILED 11-9-2005.

PLAYTEX PETALS

THE MARK CONSISTS OF STANDARD CHARACTERS WITHOUT CLAIM TO ANY PARTICULAR FONT, STYLE, SIZE, OR COLOR.

OWNER OF U.S. REG. NOS. 2,628,693, 2,834,730, AND OTHERS.

FOR FEMININE CARE PRODUCTS, NAMELY, DISPOSABLE WIPES IMPREGNATED WITH CHEMICALS OR COMPOUNDS FOR PERSONAL HYGIENE (U.S. CLS. 1, 4, 6, 50, 51 AND 52).

FIRST USE 5-0-2006; IN COMMERCE 5-0-2006.

CLASS 3—(Continued).

3,314,012. CONAIR CORPORATION, STAMFORD, CT. SN 78-753,508. PUB. 8-8-2006, FILED 11-14-2005.

CORAL THERAPY

THE MARK CONSISTS OF STANDARD CHARACTERS WITHOUT CLAIM TO ANY PARTICULAR FONT, STYLE, SIZE, OR COLOR.

NO CLAIM IS MADE TO THE EXCLUSIVE RIGHT TO USE "THERAPY", APART FROM THE MARK AS SHOWN, FOR HAIR CARE PREPARATIONS; HAIR STYLING PREPARATIONS (U.S. CLS. 1, 4, 6, 50, 51 AND 52).

FIRST USE 4-1-2006; IN COMMERCE 4-1-2006.

3,314,014. SUDZZFX, INC., OXNARD, CA. SN 78-753,762. PUB. 7-18-2006, FILED 11-14-2005.

CHIZEL

THE MARK CONSISTS OF STANDARD CHARACTERS WITHOUT CLAIM TO ANY PARTICULAR FONT, STYLE, SIZE, OR COLOR.

FOR HAIR STYLING GEL; HAIR STYLING SPRAY (U.S. CLS. 1, 4, 6, 50, 51 AND 52).

FIRST USE 1-23-2006; IN COMMERCE 1-23-2006.

3,314,025. PLANK LLC, CHARLESTOWN, MA. SN 78-756,363. PUB. 7-25-2006, FILED 11-17-2005.

COR

THE MARK CONSISTS OF STANDARD CHARACTERS WITHOUT CLAIM TO ANY PARTICULAR FONT, STYLE, SIZE, OR COLOR.

FOR FACIAL CLEANSING BAR SOAP, SHAMPOO, TOOTHPASTE (U.S. CLS. 1, 4, 6, 50, 51 AND 52).

FIRST USE 2-6-2007; IN COMMERCE 2-6-2007.

CLASS 3—(Continued).

3,314,031. TARGET BRANDS, INC., MINNEAPOLIS, MN. SN 78-757,917. PUB. 1-2-2007, FILED 11-21-2005.

Teravita

THE MARK CONSISTS OF STANDARD CHARACTERS WITHOUT CLAIM TO ANY PARTICULAR FONT, STYLE, SIZE, OR COLOR.

FOR BEAUTY MASK, LIP BALM, BATH GEL, SKIN MOISTURIZER, BEAUTY SERUM, BODY OIL, EYE CREAM, BODY SCRUB, BODY WASH, BAR SOAP, BODY POLISH, SKIN MOISTURIZER IN THE NATURE OF BODY MOISTURE SPRAY, BODY LOTION, HAND CREAM, BODY BUTTER, MASSAGE OIL (U.S. CLS. 1, 4, 6, 50, 51 AND 52).

FIRST USE 3-6-2006; IN COMMERCE 3-6-2006.

3,314,053. CORAL HEAD, INC., GARDENA, CA. SN 78-762,009. PUB. 8-1-2006, FILED 11-28-2005.

ENJOY THE RIDE

THE MARK CONSISTS OF STANDARD CHARACTERS WITHOUT CLAIM TO ANY PARTICULAR FONT, STYLE, SIZE, OR COLOR.

OWNER OF U.S. REG. NOS. 2,221,130, 2,396,673, AND 2,475,043.

FOR SUNCARE PRODUCTS, NAMELY, SUNSCREEN AND SUN BLOCK PREPARATIONS; TANNING LOTIONS, CREAMS, OILS, SPRAYS, AND STICKS; AFTER SUN CREAMS AND LOTIONS; SKIN MOISTURIZERS AND LIP BALM; PATCHES CONTAINING SUN SCREEN AND SUN BLOCK FOR USE ON THE SKIN (U.S. CLS. 1, 4, 6, 50, 51 AND 52).

FIRST USE 6-9-2006; IN COMMERCE 6-9-2006.

3,314,057. CONCEPT LABORATORIES, INC., CHICAGO, IL. SN 78-763,439. PUB. 9-5-2006, FILED 11-30-2005.

Advanced Clinicals

THE MARK CONSISTS OF STANDARD CHARACTERS WITHOUT CLAIM TO ANY PARTICULAR FONT, STYLE, SIZE, OR COLOR.

FOR NON-MEDICATED SKIN CARE PREPARATIONS (U.S. CLS. 1, 4, 6, 50, 51 AND 52).

FIRST USE 6-21-2006; IN COMMERCE 6-21-2006.

CLASS 3—(Continued).

3,314,149. ORALABS, INC., PARKER, CO. SN 78-776,895. PUB. 8-22-2006, FILED 12-20-2005.



NO CLAIM IS MADE TO THE EXCLUSIVE RIGHT TO USE "SURFERS CHOICE", APART FROM THE MARK AS SHOWN.

THE MARK CONSISTS OF A FROG WEARING SUNGLASSES ON TOP OF A SURFBOARD CONTAINING THE STYLIZED WORDS ROYAL SUNFROG SURFERS CHOICE. FOR SUNSCREEN AND LIP BALM (U.S. CLS. 1, 4, 6, 50, 51 AND 52).

FIRST USE 4-30-2004; IN COMMERCE 4-30-2004.

3,314,191. BLUE Q CORPORATION, PITTSFIELD, MA. SN 78-784,819. PUB. 8-29-2006, FILED 1-4-2006.

GET REAL

THE MARK CONSISTS OF STANDARD CHARACTERS WITHOUT CLAIM TO ANY PARTICULAR FONT, STYLE, SIZE, OR COLOR.

FOR BATH AND BODY PRODUCTS, NAMELY, SOAP, BODY WASH, BATH AND SHOWER GEL, SHAMPOO, BODY LOTION, HAND LOTION AND NON-MEDICATED LIP BALM (U.S. CLS. 1, 4, 6, 50, 51 AND 52).

FIRST USE 2-17-2006; IN COMMERCE 2-17-2006.

3,314,279. COLLECTIVE WELLBEING LLC, IRWINDALE, CA. SN 78-800,260. PUB. 9-26-2006, FILED 1-26-2006.

CATEGORY 5

THE MARK CONSISTS OF STANDARD CHARACTERS WITHOUT CLAIM TO ANY PARTICULAR FONT, STYLE, SIZE, OR COLOR.

FOR FACE CARE PRODUCTS, NAMELY, ANTI-AGING SERUM, FACE CREAM, FACE CLEANSER, EXFOLIATOR, EYE CREAM (U.S. CLS. 1, 4, 6, 50, 51 AND 52).

FIRST USE 3-1-2007; IN COMMERCE 3-1-2007.

CLASS 3—(Continued).

3,314,287. Y.Z.Y. INC, MIAMI, FL. SN 78-802,135. PUB. 8-29-2006, FILED 1-30-2006.

KOKOLOCO

THE MARK CONSISTS OF STANDARD CHARACTERS WITHOUT CLAIM TO ANY PARTICULAR FONT, STYLE, SIZE, OR COLOR.

FOR BEAUTY CREAMS FOR BODY CARE; BEAUTY LOTIONS; BODY SPRAY USED AS A PERSONAL DEODORANT AND AS FRAGRANCE; DEODORANTS AND ANTIPERSPIRANTS; EAU DE COLOGNE; EAU DE PERFUME; HAND CREAM; PERFUMED SOAPS; PERSONAL DEODORANTS (U.S. CLS. 1, 4, 6, 50, 51 AND 52).
FIRST USE 1-30-2006; IN COMMERCE 1-30-2006.

3,314,299. PLANK LLC, CHARLESTOWN, MA. SN 78-805,038. PUB. 7-25-2006, FILED 2-2-2006.

FOAM...RINSE...GLOW

THE MARK CONSISTS OF STANDARD CHARACTERS WITHOUT CLAIM TO ANY PARTICULAR FONT, STYLE, SIZE, OR COLOR.

FOR FACIAL CLEANSERS (U.S. CLS. 1, 4, 6, 50, 51 AND 52).
FIRST USE 2-6-2007; IN COMMERCE 2-6-2007.

3,314,319. Y.Z.Y. INC, MIAMI, FL. SN 78-809,124. PUB. 8-29-2006, FILED 2-7-2006.

SHIMON BOUSKILA

THE MARK CONSISTS OF STANDARD CHARACTERS WITHOUT CLAIM TO ANY PARTICULAR FONT, STYLE, SIZE, OR COLOR.

THE NAME SHOWN IN THE MARK DOES IDENTIFY A PARTICULAR LIVING INDIVIDUAL WHOSE CONSENT IS OF RECORD.

FOR BEAUTY CREAMS FOR BODY CARE; BEAUTY LOTIONS; BODY SPRAY USED AS A PERSONAL DEODORANT AND AS FRAGRANCE; COSMETIC CREAMS FOR SKIN CARE; DEODORANT FOR PERSONAL USE; DEODORANTS AND ANTIPERSPIRANTS; EAU DE COLOGNE; EAU DE PERFUME; HAND CREAMS; HAND LOTIONS; PERFUME; PERFUMED SOAPS; PERSONAL DEODORANTS (U.S. CLS. 1, 4, 6, 50, 51 AND 52).
FIRST USE 1-30-2006; IN COMMERCE 1-30-2006.

CLASS 3—(Continued).

3,314,356. NOXELL CORPORATION, HUNT VALLEY, MD. SN 78-815,206. PUB. 10-10-2006, FILED 2-15-2006.

TRUSHINE

THE MARK CONSISTS OF STANDARD CHARACTERS WITHOUT CLAIM TO ANY PARTICULAR FONT, STYLE, SIZE, OR COLOR.

FOR COSMETICS (U.S. CLS. 1, 4, 6, 50, 51 AND 52).
FIRST USE 11-27-2006; IN COMMERCE 11-27-2006.

3,314,388. DRANE, RODERICK, BLOOMFIELD HILLS, MI. SN 78-820,130. PUB. 10-3-2006, FILED 2-21-2006.

VYNT

THE MARK CONSISTS OF STANDARD CHARACTERS WITHOUT CLAIM TO ANY PARTICULAR FONT, STYLE, SIZE, OR COLOR.

FOR BODY OILS; DEODORANTS FOR BODY CARE (U.S. CLS. 1, 4, 6, 50, 51 AND 52).
FIRST USE 12-31-2006; IN COMMERCE 12-31-2006.

3,314,413. CAL TAN, LLC, LOS ANGELES, CA. SN 78-825,715. PUB. 10-10-2006, FILED 2-28-2006.

GUILTY PLEASURE

THE MARK CONSISTS OF STANDARD CHARACTERS WITHOUT CLAIM TO ANY PARTICULAR FONT, STYLE, SIZE, OR COLOR.

FOR COSMETIC SUN-TANNING PREPARATIONS; SELF-TANNING PREPARATIONS; SKIN GELS FOR ACCELERATING, ENHANCING OR EXTENDING TANS; SUN TAN GEL; SUN TAN LOTION; SUN TAN OIL; SUNTAN CREAMS; TANNING CREAMS (U.S. CLS. 1, 4, 6, 50, 51 AND 52).
FIRST USE 10-1-2006; IN COMMERCE 10-1-2006.

CLASS 3—(Continued).

3,314,423. THOMPSON CENTER ARMS COMPANY INC., ROCHESTER, NH. SN 78-828,169. PUB. 8-22-2006, FILED 3-3-2006.

T17

THE MARK CONSISTS OF STANDARD CHARACTERS WITHOUT CLAIM TO ANY PARTICULAR FONT, STYLE, SIZE, OR COLOR.

FOR CLEANING PREPARATIONS FOR FIREARMS (U.S. CLS. 1, 4, 6, 50, 51 AND 52).

FIRST USE 6-30-2006; IN COMMERCE 6-30-2006.

3,314,455. BUSSON, MARC, H. MARSEILLE, FRANCE. SN 78-834,812. PUB. 12-5-2006, FILED 3-10-2006.



THE MARK CONSISTS OF TEXT "LE LOUIS D'OR" ON TOP OF THE PROFILE FACE OF A KING CAPPED OF A CROWN.

THE FOREIGN WORDING IN THE MARK TRANSLATES INTO ENGLISH AS GOLD LOUIS.

FOR ALMOND SOAPS; ANTI-BACTERIAL SOAP; ANTIBACTERIAL SKIN SOAPS; ASTRINGENTS FOR COSMETIC PURPOSES; BATH OILS FOR COSMETIC PURPOSES; BATH SOAPS IN LIQUID, SOLID OR GEL FORM; BLEACHING PREPARATIONS FOR COSMETIC PURPOSES; BODY AND BEAUTY CARE COSMETICS; BODY CREAM SOAP; CHALK FOR COSMETIC USE; CLEANER FOR COSMETIC BRUSHES; CLEANSING CREAMS; COCOA BUTTER FOR COSMETIC PURPOSES; COLORING PREPARATIONS FOR COSMETIC PURPOSES; CONCEALERS; COSMETIC BALLS; COSMETIC CREAMS; COSMETIC CREAMS FOR SKIN CARE; COSMETIC FACIAL BLOTTING PAPERS; COSMETIC MILKS; COSMETIC OILS; COSMETIC OILS FOR THE EPIDERMIS; COSMETIC PADS; COSMETIC PENCILS; COSMETIC PREPARATIONS AGAINST SUNBURN; COSMETIC PREPARATIONS FOR BODY CARE; COSMETIC PREPARATIONS FOR SKIN RENEWAL; COSMETIC PREPARATIONS FOR THE CARE OF MOUTH AND TEETH; COSMETIC PRODUCTS IN THE FORM OF AEROSOLS FOR SKIN CARE; COSMETIC PRODUCTS IN THE FORM OF AEROSOLS FOR SKINCARE; COSMETIC ROUGES; COSMETIC SOAPS; COSMETIC SUN-PROTECTING PREPARATIONS; COSMETIC SUN-TANNING PREPARATIONS; COSMETIC SUNTAN LOTIONS; COSMETICS; COSMETICS NAMELY, COMPACTS; COTTON BALLS FOR COSMETIC PURPOSES; COTTON BUDS FOR COSMETIC PURPOSES; COTTON FOR COSMETIC

CLASS 3—(Continued).

PURPOSES; COTTON PUFFS FOR COSMETIC PURPOSES; COTTON STICKS FOR COSMETIC PURPOSES; COTTON SWABS FOR COSMETIC PURPOSES; CREAM SOAPS; DECORATIVE TRANSFERS AND SKIN JEWELS FOR COSMETIC PURPOSES; DEODORANT SOAP; DETERGENT SOAP; DISINFECTANT SOAPS; DISINFECTING PERFUMED SOAPS; EYE COMPRESSES FOR COSMETIC PURPOSES; FACE CREAMS FOR COSMETIC USE; FOAMS CONTAINING COSMETICS AND SUNSCREENS; FOUNDATION; GAUZE FOR COSMETIC PURPOSES; GRANULATED SOAPS; HAND SOAPS; HENNA FOR COSMETIC PURPOSES; INDUSTRIAL SOAP; LAUNDRY SOAP; LIQUID BATH SOAPS; LIQUID SOAP; LIQUID SOAP USED IN FOOT BATH; LIQUID SOAPS; LIQUID SOAPS FOR HANDS AND FACE; LIQUID SOAPS FOR HANDS, FACE AND BODY; MAKE-UP KITS COMPRISED OF CREAM, SOAPS, LIPSTICK; MEDICATED SOAP; MEDICATED SOAPS; NAIL VARNISH FOR COSMETIC PURPOSES; NUTRITIONAL OILS FOR COSMETIC PURPOSES; PENCILS FOR COSMETIC PURPOSES; PERFUME OILS FOR THE MANUFACTURE OF COSMETIC PREPARATIONS; PERFUMED SOAP; PERFUMED SOAPS; PETROLEUM JELLY FOR COSMETIC PURPOSES; PRE-MOISTENED COSMETIC TISSUES; PRE-MOISTENED COSMETIC TOWELETTS; PRE-MOISTENED COSMETIC WIPES; ROSE OIL FOR COSMETIC PURPOSES; SADDLE SOAP; SHAMPOOS; SHAVING SOAP; SKIN SOAP; SOAP POWDER; SOAPS; SOAPS AND DETERGENTS; SOAPS FOR BODY CARE; SOAPS FOR HOUSEHOLD USE; SOAPS FOR PERSONAL USE; SOAPS FOR TOILET PURPOSES; TOILET SOAP; TOILET SOAPS; TONERS; TOPICAL SKIN SPRAYS FOR COSMETIC PURPOSES; WATERLESS SOAP (U.S. CLS. 1, 4, 6, 50, 51 AND 52).

FIRST USE 4-1-2007; IN COMMERCE 4-1-2007.

3,314,468. ALTERNA HOLDINGS CORPORATION, CENTURY CITY, CA. SN 78-839,405. PUB. 11-21-2006, FILED 3-16-2006.

RADIANT SMOOTHING LOTION

THE MARK CONSISTS OF STANDARD CHARACTERS WITHOUT CLAIM TO ANY PARTICULAR FONT, STYLE, SIZE, OR COLOR.

NO CLAIM IS MADE TO THE EXCLUSIVE RIGHT TO USE "SMOOTHING LOTION", APART FROM THE MARK AS SHOWN.

FOR HAIR CARE PREPARATIONS, NAMELY, STYLING LOTIONS, GELS, GLAZES, TONICS, MOUSSES, STYLING FOAMS, HAIR SPRAYS, HAIR BALMS, WAXES, AND POMADES (U.S. CLS. 1, 4, 6, 50, 51 AND 52).

FIRST USE 7-31-2006; IN COMMERCE 7-31-2006.

CLASS 3—(Continued).

3,314,494. BELLEZZA PRODUCTS, LLC, MANAKIN SABOT, VA. SN 78-850,580. PUB. 1-16-2007, FILED 3-30-2006.

Hydrolyze^H Under Eye Treatment

NO CLAIM IS MADE TO THE EXCLUSIVE RIGHT TO USE "UNDER EYE TREATMENT", APART FROM THE MARK AS SHOWN.
FOR ANTI-WRINKLE EYE TREATMENT CREAM (U.S. CLS. 1, 4, 6, 50, 51 AND 52).
FIRST USE 8-3-2007; IN COMMERCE 8-3-2007.

3,314,506. THE PROCTER & GAMBLE COMPANY, CINCINNATI, OH. SN 78-855,915. PUB. 11-21-2006, FILED 4-6-2006.

HELLO HYDRATION

THE MARK CONSISTS OF STANDARD CHARACTERS WITHOUT CLAIM TO ANY PARTICULAR FONT, STYLE, SIZE, OR COLOR.
NO CLAIM IS MADE TO THE EXCLUSIVE RIGHT TO USE "HYDRATION", APART FROM THE MARK AS SHOWN.
FOR HAIR CARE PREPARATIONS (U.S. CLS. 1, 4, 6, 50, 51 AND 52).
FIRST USE 6-30-2006; IN COMMERCE 6-30-2006.

3,314,521. L'OREAL USA CREATIVE, INC., NEW YORK, NY. SN 78-861,783. PUB. 2-13-2007, FILED 4-14-2006.

GRIT WAX

THE MARK CONSISTS OF STANDARD CHARACTERS WITHOUT CLAIM TO ANY PARTICULAR FONT, STYLE, SIZE, OR COLOR.
NO CLAIM IS MADE TO THE EXCLUSIVE RIGHT TO USE "WAX", APART FROM THE MARK AS SHOWN.
FOR HAIR STYLING PREPARATION (U.S. CLS. 1, 4, 6, 50, 51 AND 52).
FIRST USE 1-0-2007; IN COMMERCE 1-0-2007.

CLASS 3—(Continued).

3,314,524. AVON PRODUCTS, INC., NEW YORK, NY. SN 78-862,930. PUB. 10-3-2006, FILED 4-17-2006.

BOHISTA

THE MARK CONSISTS OF STANDARD CHARACTERS WITHOUT CLAIM TO ANY PARTICULAR FONT, STYLE, SIZE, OR COLOR.
FOR BODY LOTION; EAU DE TOILETTE; EYE SHADOWS; LIP GLOSS (U.S. CLS. 1, 4, 6, 50, 51 AND 52).
FIRST USE 8-4-2006; IN COMMERCE 8-24-2006.

3,314,563. AVON PRODUCTS, INC., NEW YORK, NY. SN 78-877,792. PUB. 10-3-2006, FILED 5-5-2006.

GLOW XPERT

THE MARK CONSISTS OF STANDARD CHARACTERS WITHOUT CLAIM TO ANY PARTICULAR FONT, STYLE, SIZE, OR COLOR.
OWNER OF U.S. REG. NO. 2,620,101.
FOR COSMETICS, NAMELY, LIQUID FACIAL SHIMMER (U.S. CLS. 1, 4, 6, 50, 51 AND 52).
FIRST USE 12-14-2006; IN COMMERCE 12-14-2006.

3,314,597. HUGGER MUGGER YOGA PRODUCTS, SALT LAKE CITY, UT. SN 78-885,622. PUB. 12-19-2006, FILED 5-17-2006.

puremat

THE MARK CONSISTS OF STANDARD CHARACTERS WITHOUT CLAIM TO ANY PARTICULAR FONT, STYLE, SIZE, OR COLOR.
FOR CLEANER FOR USE ON EXERCISE EQUIPMENT (U.S. CLS. 1, 4, 6, 50, 51 AND 52).
FIRST USE 3-30-2006; IN COMMERCE 3-30-2006.

CLASS 3—(Continued).

3,314,602. HARRIS-LEE, PATRICIA, JERSEY CITY, NJ. SN 78-887,286. PUB. 3-13-2007, FILED 5-18-2006.



THE COLOR(S) BLACK, PURPLE AND WHITE IS/ARE CLAIMED AS A FEATURE OF THE MARK.

THE COLOR(S) BLACK APPEARS IN THE BACKGROUND OF THE MARK AND ALL THE WORDING, SYMBOLS AND DESIGNS ARE IN PURPLE AND WHITE. FOR BODY AND BEAUTY CARE COSMETICS (U.S. CLS. 1, 4, 6, 50, 51 AND 52).

FIRST USE 6-1-2006; IN COMMERCE 6-11-2007.

3,314,614. L'OREAL, PARIS, FRANCE. SN 78-889,996. PUB. 12-19-2006, FILED 5-23-2006.

TIGHTLY WOUND

THE MARK CONSISTS OF STANDARD CHARACTERS WITHOUT CLAIM TO ANY PARTICULAR FONT, STYLE, SIZE, OR COLOR.

FOR HAIR STYLING PREPARATIONS (U.S. CLS. 1, 4, 6, 50, 51 AND 52).

FIRST USE 1-0-2007; IN COMMERCE 1-0-2007.

3,314,643. UNISOURCE INSTITUTIONAL SUPPLY CORPORATION, PHILADELPHIA, PA. SN 78-897,384. PUB. 1-2-2007, FILED 5-31-2006.

Flora Fresh

FOR BEAUTY AND BATH SOAP, SHAMPOO, TOOTH-PASTE AND SHAVING CREAM SOLD TO INSTITUTIONS, NAMELY, HOTELS, PRISONS AND HOSPITALS (U.S. CLS. 1, 4, 6, 50, 51 AND 52).

FIRST USE 7-1-2006; IN COMMERCE 7-1-2006.

CLASS 3—(Continued).

3,314,668. CAROL'S DAUGHTER HOLDINGS, LLC, NEW YORK, NY. SN 78-902,492. PUB. 1-9-2007, FILED 6-7-2006.

Candy Paint

THE MARK CONSISTS OF STANDARD CHARACTERS WITHOUT CLAIM TO ANY PARTICULAR FONT, STYLE, SIZE, OR COLOR.

FOR COSMETICS (U.S. CLS. 1, 4, 6, 50, 51 AND 52). FIRST USE 12-1-2006; IN COMMERCE 12-1-2006.

3,314,686. AESTHETICALLY WRIGHT I LTD. PARTNERSHIP, PLANO, TX. SN 78-907,057. PUB. 2-27-2007, FILED 6-13-2006.

PRÉVIA

THE MARK CONSISTS OF STANDARD CHARACTERS WITHOUT CLAIM TO ANY PARTICULAR FONT, STYLE, SIZE, OR COLOR.

THE ENGLISH TRANSLATION OF THE FOREIGN WORD "PREVIA" IN THE MARK IS "PREVIOUS".

FOR BEAUTY CREAMS; BEAUTY LOTIONS; BEAUTY MASKS; BODY AND BEAUTY CARE COSMETICS; COSMETIC CREAMS FOR SKIN CARE; NON-MEDICATED SKIN CARE PREPARATIONS; SKIN ABRASIVE PREPARATIONS; SKIN CLEANSERS; SKIN CLEANSING LOTION; SKIN CONDITIONERS; SKIN CREAM; SKIN LIGHTENERS; SKIN LOTIONS; SKIN MOISTURIZER; SKIN SOAP; SKIN TONERS; WRINKLE REMOVING SKIN CARE PREPARATIONS (U.S. CLS. 1, 4, 6, 50, 51 AND 52).

FIRST USE 7-0-2007; IN COMMERCE 7-0-2007.

3,314,801. BEAUMONT PRODUCTS, INC., KENNESAW, GA. SN 78-945,344. PUB. 3-13-2007, FILED 8-4-2006.

BRILLIANT

THE MARK CONSISTS OF STANDARD CHARACTERS WITHOUT CLAIM TO ANY PARTICULAR FONT, STYLE, SIZE, OR COLOR.

FOR METAL POLISH (U.S. CLS. 1, 4, 6, 50, 51 AND 52). FIRST USE 4-25-2007; IN COMMERCE 4-25-2007.

CLASS 3—(Continued).

3,314,810. OVERRIDE COSMETICS, LLC, NEW YORK, NY.
SN 78-949,141. PUB. 11-21-2006, FILED 8-10-2006.

MANUAL OVERRIDE

THE MARK CONSISTS OF STANDARD CHARACTERS WITHOUT CLAIM TO ANY PARTICULAR FONT, STYLE, SIZE, OR COLOR.

FOR COSMETICS (U.S. CLS. 1, 4, 6, 50, 51 AND 52).
FIRST USE 9-21-2006; IN COMMERCE 9-21-2006.

CLASS 3—(Continued).

3,314,828. ANTONIA'S FLOWERS, INC., OSTERVILLE, MA.
SN 78-954,244. PUB. 4-17-2007, FILED 8-17-2006.

SOGNI DEL MARE

THE MARK CONSISTS OF STANDARD CHARACTERS WITHOUT CLAIM TO ANY PARTICULAR FONT, STYLE, SIZE, OR COLOR.

THE FOREIGN WORDING IN THE MARK TRANSLATES INTO ENGLISH AS DREAMS OF THE SEA.

FOR BODY CREAMS; BODY LOTIONS; BODY POWDER; BODY SPRAY USED AS A PERSONAL DEODORANT AND AS FRAGRANCE; BODY SPRAYS; FRAGRANCES FOR PERSONAL USE; PERFUME; PERFUMED CREAMS; PERFUMED POWDERS; PERFUMED SOAPS; PERFUMED TALCUM POWDER (U.S. CLS. 1, 4, 6, 50, 51 AND 52).

FIRST USE 11-28-2006; IN COMMERCE 11-28-2006.

3,314,837. C.B. FLEET INVESTMENT CORPORATION, WILMINGTON, DE. SN 78-956,246. PUB. 4-3-2007, FILED 8-21-2006.

3,314,827. MARS, INCORPORATED, MCLEAN, VA. SN 78-953,544. PUB. 4-3-2007, FILED 8-16-2006.



OWNER OF U.S. REG. NO. 2,929,318.
THE COLOR(S) RED, WHITE, BLUE, GREEN, ORANGE, YELLOW, PURPLE IS/ARE CLAIMED AS A FEATURE OF THE MARK.

THE WORD SKITTLES IS WHITE WITH A RED BORDER, THE RAINBOW IS BLUE, GREEN, YELLOW, ORANGE AND RED. THE LENTILS ARE YELLOW, RED, PURPLE, GREEN AND ORANGE.

FOR BUBBLE BATH, BODY LOTION AND SHAMPOO (U.S. CLS. 1, 4, 6, 50, 51 AND 52).
FIRST USE 10-0-2006; IN COMMERCE 10-0-2006.

SOOTHING BOTANICALS

THE MARK CONSISTS OF STANDARD CHARACTERS WITHOUT CLAIM TO ANY PARTICULAR FONT, STYLE, SIZE, OR COLOR.

NO CLAIM IS MADE TO THE EXCLUSIVE RIGHT TO USE "BOTANICALS", APART FROM THE MARK AS SHOWN.

FOR FOAMING CLEANSING BATH SOLUTION FOR EXTERNAL FEMININE HYGIENE AND CLEANSING (U.S. CLS. 1, 4, 6, 50, 51 AND 52).

FIRST USE 6-12-2007; IN COMMERCE 6-12-2007.

3,314,861. AVEDA CORPORATION, MINNEAPOLIS, MN. SN 78-963,561. PUB. 4-17-2007, FILED 8-30-2006.

SMOOTH INFUSION

THE MARK CONSISTS OF STANDARD CHARACTERS WITHOUT CLAIM TO ANY PARTICULAR FONT, STYLE, SIZE, OR COLOR.

FOR HAIR CARE PREPARATIONS (U.S. CLS. 1, 4, 6, 50, 51 AND 52).
FIRST USE 4-29-2007; IN COMMERCE 4-29-2007.

CLASS 3—(Continued).

3,314,868. BRULIN & COMPANY, INC., INDIANAPOLIS, IN. SN 78-965,742. PUB. 1-23-2007, FILED 9-1-2006.

CATCH-UP SHOWER ROOM CLEANER

THE MARK CONSISTS OF STANDARD CHARACTERS WITHOUT CLAIM TO ANY PARTICULAR FONT, STYLE, SIZE, OR COLOR.

NO CLAIM IS MADE TO THE EXCLUSIVE RIGHT TO USE SHOWER ROOM CLEANER, APART FROM THE MARK AS SHOWN.

FOR CLEANING PREPARATIONS FOR SHOWER ROOMS (U.S. CLS. 1, 4, 6, 50, 51 AND 52).

FIRST USE 11-1-2006; IN COMMERCE 11-1-2006.

3,314,872. PYRAMID PUBLISHING AND PRODUCTIONS, INC., CHICAGO, IL. SN 78-966,821. PUB. 5-15-2007, FILED 9-5-2006.

LIGHT UP YOUR LIFE

THE MARK CONSISTS OF STANDARD CHARACTERS WITHOUT CLAIM TO ANY PARTICULAR FONT, STYLE, SIZE, OR COLOR.

FOR COSMETIC COMPOSITIONS, NAMELY, NAIL POLISH, FOUNDATION, BLUSH, MASCARA, EYE SHADOW, LIPSTICKS, ROUGE, EYELINER, LIP GLOSSES, AND FRAGRANCES FOR PERSONAL USE (U.S. CLS. 1, 4, 6, 50, 51 AND 52).

FIRST USE 8-8-2007; IN COMMERCE 8-8-2007.

3,314,888. MERCANTIL DE COMERCIO, S.A., GUATEMALA CITY, GUATEMALA. SN 78-971,058. PUB. 4-24-2007, FILED 9-11-2006.

Tamy de Familia

THE MARK CONSISTS OF STANDARD CHARACTERS WITHOUT CLAIM TO ANY PARTICULAR FONT, STYLE, SIZE, OR COLOR.

THE FOREIGN WORDING IN THE MARK TRANSLATES INTO ENGLISH AS TAMY OF FAMILY.

FOR BODY CREAMS; BODY LOTIONS; SHAMPOOS; SOAPS (U.S. CLS. 1, 4, 6, 50, 51 AND 52).

FIRST USE 11-1-1994; IN COMMERCE 1-1-2007.

CLASS 3—(Continued).

3,314,904. DR. WONDER, LLC, NEW YORK, NY. SN 78-978,844. PUB. 9-19-2006, FILED 1-19-2005.

DOCTOR WONDER

THE MARK CONSISTS OF STANDARD CHARACTERS WITHOUT CLAIM TO ANY PARTICULAR FONT, STYLE, SIZE, OR COLOR.

FOR HAIR CARE AND HAIR TREATMENT PREPARATIONS, NAMELY, HAIR SHAMPOO, HAIR CONDITIONERS, HAIR OILS, HAIR BALMS, HAIR CREAMS, HAIR RINSES, HAIR LOTIONS, HAIR GELS AND HAIR RELAXERS (U.S. CLS. 1, 4, 6, 50, 51 AND 52).

FIRST USE 5-10-2005; IN COMMERCE 5-10-2005.

CLASS 4—LUBRICANTS AND FUELS

3,313,216. MUDLARK PAPERS, INC., BOLINGBROOK, IL. SN 76-662,936. PUB. 2-27-2007, FILED 7-12-2006.

TOTARA

THE MARK CONSISTS OF STANDARD CHARACTERS WITHOUT CLAIM TO ANY PARTICULAR FONT, STYLE, SIZE, OR COLOR.

FOR CANDLES, NAMELY SCENTED AND UNSCENTED CANDLES, AND FRAGRANT WAX FOR USE IN POTPOURRI BURNERS (U.S. CLS. 1, 6 AND 15).

FIRST USE 9-1-2006; IN COMMERCE 9-1-2006.

3,314,109. EVEY, DAVID S., BEVERLY HILLS, CA. SN 78-770,770. PUB. 8-8-2006, FILED 12-10-2005.



zensual

FOR CANDLES (U.S. CLS. 1, 6 AND 15).
FIRST USE 4-18-2006; IN COMMERCE 4-25-2006.

CLASS 4—(Continued).

3,314,442. AEROSPACE LUBRICANTS, INC., COLUMBUS, OH. SN 78-832,102. PUB. 10-31-2006, FILED 3-8-2006.

TRIBOGEL

THE MARK CONSISTS OF STANDARD CHARACTERS WITHOUT CLAIM TO ANY PARTICULAR FONT, STYLE, SIZE, OR COLOR.

OWNER OF U.S. REG. NO. 1,452,826.
FOR FOOD GRADE LUBRICANT (U.S. CLS. 1, 6 AND 15).
FIRST USE 2-28-2006; IN COMMERCE 2-28-2006.

CLASS 4—(Continued).

3,314,722. KLEIN TOOLS, INC., LINCOLNSHIRE, IL. SN 78-917,014. PUB. 4-17-2007, FILED 6-26-2006.



NO CLAIM IS MADE TO THE EXCLUSIVE RIGHT TO USE "PREMIUM SYNTHETIC POLYMER", APART FROM THE MARK AS SHOWN.

FOR WIRE PULLING LUBRICANTS (U.S. CLS. 1, 6 AND 15).
FIRST USE 8-1-2006; IN COMMERCE 8-1-2006.

CLASS 5—PHARMACEUTICALS

3,313,001. WELLMARK INTERNATIONAL, SCHAUMBURG, IL. SN 76-404,313. PUB. 2-24-2004, FILED 5-6-2002.

EGGBUSTERS

FOR INSECTICIDES FOR DOMESTIC AND PROFESSIONAL USE FOR INDOOR APPLICATIONS IN AND RESIDENTIAL AND COMMERCIAL DWELLINGS AND OUTDOOR APPLICATIONS IN PERIMETER RESIDENTIAL AREAS, LAWN AND GARDEN, AND PROFESSIONAL GREENHOUSES AND NURSERIES (U.S. CLS. 6, 18, 44, 46, 51 AND 52).

FIRST USE 5-2-2007; IN COMMERCE 5-2-2007.

3,314,445. AEROSPACE LUBRICANTS, INC., COLUMBUS, OH. SN 78-832,395. PUB. 10-31-2006, FILED 3-8-2006.

PRO H1

THE MARK CONSISTS OF STANDARD CHARACTERS WITHOUT CLAIM TO ANY PARTICULAR FONT, STYLE, SIZE, OR COLOR.

OWNER OF U.S. REG. NO. 1,804,060 AND OTHERS.
NO CLAIM IS MADE TO THE EXCLUSIVE RIGHT TO USE "H1", APART FROM THE MARK AS SHOWN.
FOR FOOD GRADE LUBRICANT FOR INDUSTRIAL USE IN THE FOOD PACKAGING INDUSTRY AND FOOD SERVICE INDUSTRY (U.S. CLS. 1, 6 AND 15).
FIRST USE 11-30-2005; IN COMMERCE 11-30-2005.

3,313,028. ENZYMATIC THERAPY, INC., GREEN BAY, WI. SN 76-524,301. PUB. 2-10-2004, FILED 6-13-2003.

REAL SIMPLE

FOR DIETARY AND NUTRITIONAL SUPPLEMENTS (U.S. CLS. 6, 18, 44, 46, 51 AND 52).
FIRST USE 4-30-2007; IN COMMERCE 4-30-2007.

CLASS 5—(Continued).

3,313,030. ENZYMATIC THERAPY, INC., GREEN BAY, WI. SN 76-525,047. PUB. 2-17-2004, FILED 6-13-2003.

REAL SIMPLE THERAPY

NO CLAIM IS MADE TO THE EXCLUSIVE RIGHT TO USE "THERAPY", APART FROM THE MARK AS SHOWN. FOR DIETARY AND NUTRITIONAL SUPPLEMENTS (U.S. CLS. 6, 18, 44, 46, 51 AND 52).
FIRST USE 4-30-2007; IN COMMERCE 4-30-2007.

3,313,042. PAULSON, RICK, BISMARCK, ND. SN 76-559,963. PUB. 1-30-2007, FILED 11-18-2003.



THE NAME(S), PORTRAIT(S), AND/OR SIGNATURE(S) SHOWN IN THE MARK DOES NOT IDENTIFY A PARTICULAR LIVING INDIVIDUAL.

THE MARK CONSISTS OF THE MARK "THE HEALERS HELPER" UNDER A FICTITIOUS PHARMACIST WITH AND ARCH TO THE SIDE OF THE PHARMACIST AND EXTENDING BEHIND THE PHARMACIST'S HEAD. THE MARK IS NOT IN COLOR.

FOR VITAMIN, HERBAL AND NUTRITIONAL SUPPLEMENTS (U.S. CLS. 6, 18, 44, 46, 51 AND 52).
FIRST USE 3-1-2007; IN COMMERCE 3-1-2007.

3,313,052. RICECO LLC, MEMPHIS, TN. SN 76-587,828. PUB. 1-25-2005, FILED 4-21-2004.

RICEPRO

THE MARK CONSISTS OF STANDARD CHARACTERS WITHOUT CLAIM TO ANY PARTICULAR FONT, STYLE, SIZE, OR COLOR.

OWNER OF U.S. REG. NOS. 2,588,925, 2,743,753, AND OTHERS.

FOR HERBICIDES FOR AGRICULTURAL USE (U.S. CLS. 6, 18, 44, 46, 51 AND 52).
FIRST USE 4-20-2007; IN COMMERCE 4-20-2007.

CLASS 5—(Continued).

3,313,069. GL DIABETES INC., ST-LAURENT, QUEBEC H4S 1S3, CANADA. SN 76-607,572. PUB. 11-29-2005, FILED 8-18-2004.

GLUCOLEADER

THE MARK CONSISTS OF STANDARD CHARACTERS WITHOUT CLAIM TO ANY PARTICULAR FONT, STYLE, SIZE, OR COLOR.

FOR BLOOD TESTING STRIPS TO TEST FOR BLOOD GLUCOSE LEVELS (U.S. CLS. 6, 18, 44, 46, 51 AND 52).
FIRST USE 10-0-2004; IN COMMERCE 10-0-2004.

3,313,107. DOUBLE A BEVERAGE, LLC, BOCA RATON, FL. SN 76-632,529. PUB. 4-24-2007, FILED 3-2-2005.

W20

THE MARK CONSISTS OF STANDARD CHARACTERS WITHOUT CLAIM TO ANY PARTICULAR FONT, STYLE, SIZE, OR COLOR.

FOR NUTRITIONALLY FORTIFIED BEVERAGES (U.S. CLS. 6, 18, 44, 46, 51 AND 52).
FIRST USE 7-0-2005; IN COMMERCE 7-0-2005.

3,313,113. SIGMA-TAU HEALTHSCIENCE, INC., NEW YORK, NY. SN 76-634,196. PUB. 12-27-2005, FILED 3-23-2005.

GLYCOCARN

THE MARK CONSISTS OF STANDARD CHARACTERS WITHOUT CLAIM TO ANY PARTICULAR FONT, STYLE, SIZE, OR COLOR.

FOR NUTRITIONAL SUPPLEMENTS (U.S. CLS. 6, 18, 44, 46, 51 AND 52).
FIRST USE 3-20-2006; IN COMMERCE 3-20-2006.

CLASS 5—(Continued).

3,313,151. GREAT AMERICAN PRODUCTS, DESTIN, FL. SN 76-643,433. PUB. 4-11-2006, FILED 7-22-2005.

HoodiaPro

THE MARK CONSISTS OF STANDARD CHARACTERS WITHOUT CLAIM TO ANY PARTICULAR FONT, STYLE, SIZE, OR COLOR.

FOR DIET SUPPLEMENT (U.S. CLS. 6, 18, 44, 46, 51 AND 52).

FIRST USE 6-22-2005; IN COMMERCE 6-22-2005.

3,313,201. PANACEA CREAM PRODUCTS, LLC, LAFAYETTE, LA. SN 76-658,084. PUB. 11-21-2006, FILED 4-10-2006.

SEABLUE

THE MARK CONSISTS OF STANDARD CHARACTERS WITHOUT CLAIM TO ANY PARTICULAR FONT, STYLE, SIZE, OR COLOR.

FOR TOPICAL GEL FOR THE TRANSDERMAL DELIVERY OF VITAMINS, MINERALS, HORMONES, OR A COMBINATION THEREOF (U.S. CLS. 6, 18, 44, 46, 51 AND 52).

FIRST USE 2-28-2006; IN COMMERCE 3-15-2006.

3,313,255. NICKELL, ROBERT P, TORRANCE, CA. SN 77-005,935. PUB. 5-1-2007, FILED 9-23-2006.

ketoderm

THE MARK CONSISTS OF STANDARD CHARACTERS WITHOUT CLAIM TO ANY PARTICULAR FONT, STYLE, SIZE, OR COLOR.

FOR TOPICAL GEL FOR MEDICAL AND THERAPEUTIC TREATMENT OF INFLAMMATION AND PAIN (U.S. CLS. 6, 18, 44, 46, 51 AND 52).

FIRST USE 1-1-2007; IN COMMERCE 1-1-2007.

CLASS 5—(Continued).

3,313,257. WORLDWIDE NUTRACEUTICALS, MCKINNEY, TX. SN 77-006,254. PUB. 5-8-2007, FILED 9-25-2006.

Stay Alert

THE MARK CONSISTS OF STANDARD CHARACTERS WITHOUT CLAIM TO ANY PARTICULAR FONT, STYLE, SIZE, OR COLOR.

FOR DIETARY AND NUTRITIONAL SUPPLEMENTS (U.S. CLS. 6, 18, 44, 46, 51 AND 52).

FIRST USE 10-11-2006; IN COMMERCE 2-21-2007.

3,313,289. JEFFREY A. MORRISON, LLC, NEW YORK, NY. SN 77-020,414. PUB. 5-22-2007, FILED 10-13-2006.

DR. MORRISON'S DAILYBENEFIT

THE MARK CONSISTS OF STANDARD CHARACTERS WITHOUT CLAIM TO ANY PARTICULAR FONT, STYLE, SIZE, OR COLOR.

THE NAME DR. MORRISON IDENTIFIES A LIVING INDIVIDUAL WHOSE CONSENT IS OF RECORD.

FOR DIETARY AND NUTRITIONAL SUPPLEMENTS (U.S. CLS. 6, 18, 44, 46, 51 AND 52).

FIRST USE 7-17-2007; IN COMMERCE 7-17-2007.

3,313,296. HEALTH OPTIONS, INC., GOLDEN, CO. SN 77-025,767. PUB. 5-29-2007, FILED 10-20-2006.

ZOOMDOG

THE MARK CONSISTS OF STANDARD CHARACTERS WITHOUT CLAIM TO ANY PARTICULAR FONT, STYLE, SIZE, OR COLOR.

FOR DIETARY ANIMAL FOOD SUPPLEMENTS, NAMELY, VITAMINS, ANTI-OXIDANTS AND MINERAL SUPPLEMENTS (U.S. CLS. 6, 18, 44, 46, 51 AND 52).

FIRST USE 1-19-2007; IN COMMERCE 1-19-2007.

CLASS 5—(Continued).

3,313,298. HALLER SCHWARZ, LONG BEACH, CA. SN 77-026,672. PUB. 4-3-2007, FILED 10-22-2006.

CLASS 5—(Continued).

3,313,313. CHEMENCE MEDICAL PRODUCTS, INC., ALPHARETTA, GA. SN 77-033,394. PUB. 5-1-2007, FILED 10-31-2006.

PAINWHACKER

Liquid Suture

THE MARK CONSISTS OF STANDARD CHARACTERS WITHOUT CLAIM TO ANY PARTICULAR FONT, STYLE, SIZE, OR COLOR.
FOR HEADACHE TREATMENT PREPARATIONS (U.S. CLS. 6, 18, 44, 46, 51 AND 52).
FIRST USE 5-28-2007; IN COMMERCE 5-28-2007.

THE MARK CONSISTS OF STANDARD CHARACTERS WITHOUT CLAIM TO ANY PARTICULAR FONT, STYLE, SIZE, OR COLOR.
FOR MEDICAL ADHESIVES FOR BINDING WOUNDS (U.S. CLS. 6, 18, 44, 46, 51 AND 52).
FIRST USE 7-25-2007; IN COMMERCE 7-25-2007.

3,313,299. HALLER SCHWARZ, LONG BEACH, CA. SN 77-026,676. PUB. 4-3-2007, FILED 10-22-2006.

3,313,314. CHEMENCE MEDICAL PRODUCTS, INC., ALPHARETTA, GA. SN 77-033,416. PUB. 5-1-2007, FILED 10-31-2006.

COLDWHACKER

Gluture

THE MARK CONSISTS OF STANDARD CHARACTERS WITHOUT CLAIM TO ANY PARTICULAR FONT, STYLE, SIZE, OR COLOR.
FOR PHARMACEUTICAL ANTITUSSIVE-COLD PREPARATIONS; PREPARATIONS FOR TREATING COLDS (U.S. CLS. 6, 18, 44, 46, 51 AND 52).
FIRST USE 5-28-2007; IN COMMERCE 5-28-2007.

THE MARK CONSISTS OF STANDARD CHARACTERS WITHOUT CLAIM TO ANY PARTICULAR FONT, STYLE, SIZE, OR COLOR.
FOR MEDICAL ADHESIVES FOR BINDING WOUNDS (U.S. CLS. 6, 18, 44, 46, 51 AND 52).
FIRST USE 7-25-2007; IN COMMERCE 7-25-2007.

3,313,304. RESCUE BEVERAGE COMPANY, PALM HARBOR, FL. SN 77-030,207. PUB. 5-29-2007, FILED 10-26-2006.

3,313,315. CHEMENCE MEDICAL PRODUCTS, INC., ALPHARETTA, GA. SN 77-033,425. PUB. 5-1-2007, FILED 10-31-2006.

THE CURE

Liquid Stitch

THE MARK CONSISTS OF STANDARD CHARACTERS WITHOUT CLAIM TO ANY PARTICULAR FONT, STYLE, SIZE, OR COLOR.
FOR POWDERED DRINK MIX FORTIFIED WITH VITAMINS, MINERALS AND ELECTROLYTES (U.S. CLS. 6, 18, 44, 46, 51 AND 52).
FIRST USE 2-1-2007; IN COMMERCE 2-1-2007.

THE MARK CONSISTS OF STANDARD CHARACTERS WITHOUT CLAIM TO ANY PARTICULAR FONT, STYLE, SIZE, OR COLOR.
FOR MEDICAL ADHESIVES FOR BINDING WOUNDS (U.S. CLS. 6, 18, 44, 46, 51 AND 52).
FIRST USE 7-25-2007; IN COMMERCE 7-25-2007.

CLASS 5—(Continued).

3,313,317. IMAGENETIX, SAN DIEGO, CA. SN 77-035,730.
PUB. 6-5-2007, FILED 11-2-2006.

MORACTIVES

THE MARK CONSISTS OF STANDARD CHARACTERS WITHOUT CLAIM TO ANY PARTICULAR FONT, STYLE, SIZE, OR COLOR.

FOR DIETARY SUPPLEMENTS (U.S. CLS. 6, 18, 44, 46, 51 AND 52).
FIRST USE 3-1-2007; IN COMMERCE 3-1-2007.

3,313,332. MEDICIS PHARMACEUTICAL CORPORATION, SCOTTSDALE, AZ. SN 77-055,120. PUB. 4-24-2007, FILED 12-1-2006.



THE MARK CONSISTS OF A SWIRL.
FOR PHARMACEUTICAL PREPARATIONS FOR DERMATOLOGIC USE, NAMELY, TOPICAL PREPARATIONS FOR THE TREATMENT OF ACNE AND TOPICAL PREPARATIONS FOR THE TREATMENT OF STEROID-RESPONSIVE DERMATOSES, EXCLUDING PREPARATIONS FOR THE TREATMENT, OR ALLEVIATION OF VIRAL INFECTIONS, REGARDLESS OF THEIR DOSAGE FORM (U.S. CLS. 6, 18, 44, 46, 51 AND 52).
FIRST USE 12-19-2006; IN COMMERCE 12-19-2006.

3,313,338. ALBAUGH, INC., ANKENY, IA. SN 77-069,716.
PUB. 5-1-2007, FILED 12-21-2006.

Refute

THE MARK CONSISTS OF STANDARD CHARACTERS WITHOUT CLAIM TO ANY PARTICULAR FONT, STYLE, SIZE, OR COLOR.
FOR PESTICIDES (U.S. CLS. 6, 18, 44, 46, 51 AND 52).
FIRST USE 6-1-2007; IN COMMERCE 6-1-2007.

CLASS 5—(Continued).

3,313,339. ALBAUGH, INC., ANKENY, IA. SN 77-069,747.
PUB. 5-1-2007, FILED 12-21-2006.

Crossroad

THE MARK CONSISTS OF STANDARD CHARACTERS WITHOUT CLAIM TO ANY PARTICULAR FONT, STYLE, SIZE, OR COLOR.

FOR PESTICIDES (U.S. CLS. 6, 18, 44, 46, 51 AND 52).
FIRST USE 1-1-2007; IN COMMERCE 1-1-2007.

3,313,348. GASPARI NUTRITION INC., LAKEWOOD, NJ. SN 77-092,557. PUB. 6-5-2007, FILED 1-26-2007.

CYTOLEAN

THE MARK CONSISTS OF STANDARD CHARACTERS WITHOUT CLAIM TO ANY PARTICULAR FONT, STYLE, SIZE, OR COLOR.

FOR DIETARY SUPPLEMENTS (U.S. CLS. 6, 18, 44, 46, 51 AND 52).
FIRST USE 3-2-2007; IN COMMERCE 3-2-2007.

3,313,382. INSTEAD, INC., LAJOLLA, CA. SN 78-255,766.
PUB. 2-24-2004, FILED 5-29-2003.

AMPHORA

FOR PHARMACEUTICAL PREPARATIONS FOR VAGINAL LUBRICATION; VAGINAL MICROBIOCIDAL SPERMICIDAL GEL; PERSONAL LUBRICANT (U.S. CLS. 6, 18, 44, 46, 51 AND 52).
FIRST USE 5-1-2007; IN COMMERCE 5-1-2007.

CLASS 5—(Continued).

3,313,383. SORIA NATURAL, S.L., 42162 GARRAY (SORIA), SPAIN. SN 78-259,254. PUB. 9-21-2004, FILED 6-6-2003.

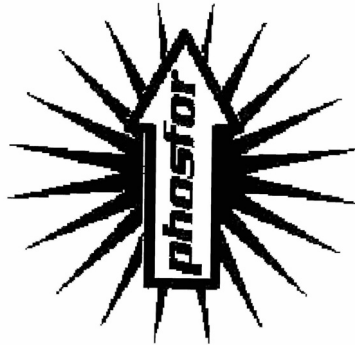

FOR DIETARY FOOD SUPPLEMENTS; DIETARY AND NUTRITIONAL SUPPLEMENTS, HERBAL SUPPLEMENTS, VITAMIN AND MINERAL SUPPLEMENTS AND MEAL REPLACEMENT DRINKS, SPECIFICALLY EXCLUDING SOLUTIONS USED AS LAXATIVES AND PURGATIVES AND FOR THE TREATMENT OF CONSTIPATION AND GASTRO-INTESTINAL DISTURBANCES (U.S. CLS. 6, 18, 44, 46, 51 AND 52).

FIRST USE 6-23-2003; IN COMMERCE 6-23-2003.

3,313,411. HAROUNIAN, KAVEH, LOS ANGELES, CA. AND HAROUNIAN, KOUROSH, LOS ANGELES, CA. SN 78-334,855. PUB. 4-26-2005, FILED 12-1-2003.

FOOT CLINIC

THE MARK CONSISTS OF STANDARD CHARACTERS WITHOUT CLAIM TO ANY PARTICULAR FONT, STYLE, SIZE, OR COLOR.

NO CLAIM IS MADE TO THE EXCLUSIVE RIGHT TO USE "FOOT", APART FROM THE MARK AS SHOWN.

FOR ANTI-ITCH CREAMS, MEDICATED SKIN PREPARATIONS FOR USE IN TREATING PROBLEMS ASSOCIATED WITH THE DRYNESS, CRACKING, ITCHING AND ODORS OF FEET, AND MEDICATED FOOT CREAMS, ALL OF THE ABOVE SOLD OVER THE COUNTER (U.S. CLS. 6, 18, 44, 46, 51 AND 52).

FIRST USE 7-18-2006; IN COMMERCE 7-18-2006.

CLASS 5—(Continued).

3,313,413. DERMAVIVE INC., LAKE OSWEGO, OR. SN 78-346,781. PUB. 10-19-2004, FILED 12-30-2003.

Aravel

THE MARK CONSISTS OF STANDARD CHARACTERS WITHOUT CLAIM TO ANY PARTICULAR FONT, STYLE, SIZE, OR COLOR.

FOR TOPICAL CREAM USED TO RELIEVE ITCHING CAUSED BY ALLERGIES, HIVES, POISON IVY OR OAK OR SUMAC, CHICKEN POX, SUNBURN, BURNS, AGING SKIN AND INSECT BITES, BUT NOT USED TO TREAT THE SYMPTOMS OF PSORIASIS OR ANY OTHER SIDE EFFECTS OF RHEUMATOID ARTHRITIS (U.S. CLS. 6, 18, 44, 46, 51 AND 52).

FIRST USE 5-1-2004; IN COMMERCE 11-9-2004.

3,313,420. GUTHY-RENKER CORPORATION, PALM DESERT, CA. SN 78-358,395. PUB. 11-9-2004, FILED 1-27-2004.

**BEAUTY STARTS WITH
GOOD NUTRITION**

THE MARK CONSISTS OF STANDARD CHARACTERS WITHOUT CLAIM TO ANY PARTICULAR FONT, STYLE, SIZE, OR COLOR.

FOR VITAMINS AND NUTRITIONAL SUPPLEMENTS (U.S. CLS. 6, 18, 44, 46, 51 AND 52).

FIRST USE 5-11-2007; IN COMMERCE 5-11-2007.

CLASS 5—(Continued).

3,313,423. DOW AGROSCIENCES LLC, INDIANAPOLIS, IN.
SN 78-362,886. PUB. 3-22-2005, FILED 2-5-2004.

SHATTER

THE MARK CONSISTS OF STANDARD CHARACTERS WITHOUT CLAIM TO ANY PARTICULAR FONT, STYLE, SIZE, OR COLOR.

FOR PESTICIDES AND PREPARATIONS FOR DESTROYING VERMIN, NAMELY HERBICIDES, INSECTICIDES AND FUNGICIDES FOR AGRICULTURE, HORTICULTURE, FORESTRY, TURF AND ORNAMENTAL, COMMERCIAL, INDUSTRIAL AND DOMESTIC USE (U.S. CLS. 6, 18, 44, 46, 51 AND 52).
FIRST USE 12-1-2005; IN COMMERCE 12-1-2005.

3,313,428. SYNGENTA LIMITED, SURREY, UNITED KINGDOM. SN 78-373,893. PUB. 2-8-2005, FILED 2-25-2004.

Callisto Plant Technology



NO CLAIM IS MADE TO THE EXCLUSIVE RIGHT TO USE "PLANT TECHNOLOGY", APART FROM THE MARK AS SHOWN.

FOR PESTICIDES, HERBICIDES, INSECTICIDES, FUNGICIDES AND PREPARATIONS FOR DESTROYING VERMIN, ALL FOR AGRICULTURAL AND HORTICULTURAL USE (U.S. CLS. 6, 18, 44, 46, 51 AND 52).
FIRST USE 3-1-2006; IN COMMERCE 3-1-2006.

3,313,705. LIQUIDIA TECHNOLOGIES, INC., CHAPEL HILL, NC. SN 78-636,826. PUB. 5-9-2006, FILED 5-25-2005.



**LIQUIDIA
TECHNOLOGIES**

CLASS 5—(Continued).

NO CLAIM IS MADE TO THE EXCLUSIVE RIGHT TO USE "TECHNOLOGIES", APART FROM THE MARK AS SHOWN.

THE MARK CONSISTS OF THE WORDS IN A STYLIZED FONT FEATURING TO THE LEFT A DROPLET OF WATER DESCENDING WHAT COULD BE DESCRIBED AS A STAIRWAY MADE OF BRICKS.

FOR MICRO- AND NANO-PARTICLES, NAMELY THOSE COMPOSED OF POLYMERS, THERAPEUTICS OR EXCIPIENTS USED FOR MEDICAL DIAGNOSTIC AND TREATMENT PURPOSES (U.S. CLS. 6, 18, 44, 46, 51 AND 52).

FIRST USE 3-19-2007; IN COMMERCE 3-19-2007.

3,313,763. CUTICEUTICALS, INC., ST. PAUL, MN. SN 78-660,110. PUB. 9-5-2006, FILED 6-28-2005.

CUTILOTION

THE MARK CONSISTS OF STANDARD CHARACTERS WITHOUT CLAIM TO ANY PARTICULAR FONT, STYLE, SIZE, OR COLOR.

OWNER OF U.S. REG. NO. 2,820,164.

FOR MEDICATED LOTION THAT IMPROVES THE APPEARANCE OF SKIN REDNESS, ECZEMA AND DRYNESS (U.S. CLS. 6, 18, 44, 46, 51 AND 52).

FIRST USE 1-1-2007; IN COMMERCE 1-1-2007.

3,313,801. ANCIENT HERBS RESEARCH & DEVELOPMENT FOUNDATION, LAS VEGAS, NV. SN 78-676,687. PUB. 4-11-2006, FILED 7-22-2005.

Silvermax

THE MARK CONSISTS OF STANDARD CHARACTERS WITHOUT CLAIM TO ANY PARTICULAR FONT, STYLE, SIZE, OR COLOR.

FOR MINERAL SUPPLEMENTS (U.S. CLS. 6, 18, 44, 46, 51 AND 52).

FIRST USE 4-24-2007; IN COMMERCE 4-24-2007.

CLASS 5—(Continued).

3,313,890. RAINFOREST NUTRITIONALS, INC., RALEIGH, NC. SN 78-715,239. PUB. 5-23-2006, FILED 9-18-2005.

REPARAGEN

THE MARK CONSISTS OF STANDARD CHARACTERS WITHOUT CLAIM TO ANY PARTICULAR FONT, STYLE, SIZE, OR COLOR.

FOR NUTRITIONAL AND DIETARY SUPPLEMENTS (U.S. CLS. 6, 18, 44, 46, 51 AND 52).
FIRST USE 1-1-2007; IN COMMERCE 1-1-2007.

3,313,930. BIRDS HILL PHARMACY, INC., NEEDHAM, MA. SN 78-735,379. PUB. 6-20-2006, FILED 10-18-2005.

BIRDS HILL HEALTHY HAIR

THE MARK CONSISTS OF STANDARD CHARACTERS WITHOUT CLAIM TO ANY PARTICULAR FONT, STYLE, SIZE, OR COLOR.

NO CLAIM IS MADE TO THE EXCLUSIVE RIGHT TO USE "HEALTHY HAIR", APART FROM THE MARK AS SHOWN.

FOR DIETARY SUPPLEMENTS; HAIR GROWTH STIMULANTS (U.S. CLS. 6, 18, 44, 46, 51 AND 52).
FIRST USE 3-1-2007; IN COMMERCE 3-1-2007.

3,313,952. DANNMARIE, LLC, LARCHMONT, NY. SN 78-742,465. PUB. 8-1-2006, FILED 10-28-2005.

premc
al

THE COLOR(S) BLUE AND LIGHT BLUE IS/ARE CLAIMED AS A FEATURE OF THE MARK.

THE MARK CONSISTS OF LETTERS "PREM" IN LIGHT BLUE AND "CAL" IN BLUE WITH BLUE FADING DOTS BELOW THE LETTERS "CAL".

FOR NON-PRESCRIPTION AND NON-HORMONAL NUTRACEUTICAL FOR THE RELIEF OF PREMENSTRUAL SYNDROME (U.S. CLS. 6, 18, 44, 46, 51 AND 52).
FIRST USE 3-15-2007; IN COMMERCE 3-15-2007.

CLASS 5—(Continued).

3,313,969. WAL-MART STORES, INC., BENTONVILLE, AR. SN 78-747,105. PUB. 1-16-2007, FILED 11-4-2005.

ESTROBLEND

THE MARK CONSISTS OF STANDARD CHARACTERS WITHOUT CLAIM TO ANY PARTICULAR FONT, STYLE, SIZE, OR COLOR.

FOR VITAMIN AND MINERAL SUPPLEMENTS; DIETARY SUPPLEMENTS FOR USE IN SUPPORTING ESTROGEN METABOLISM (U.S. CLS. 6, 18, 44, 46, 51 AND 52).
FIRST USE 5-31-2006; IN COMMERCE 5-31-2006.

3,314,002. BRIOSCHI, INC., FAIR LAWN, NJ. SN 78-751,482. PUB. 8-1-2006, FILED 11-10-2005.

GINGERA

THE MARK CONSISTS OF STANDARD CHARACTERS WITHOUT CLAIM TO ANY PARTICULAR FONT, STYLE, SIZE, OR COLOR.

FOR ANTACIDS, NAMELY EFFERVESCENT BEVERAGE SALTS (U.S. CLS. 6, 18, 44, 46, 51 AND 52).
FIRST USE 1-30-2007; IN COMMERCE 1-30-2007.

3,314,024. NUTRIGENIC LABORATORIES INC., AMITYVILLE, NY. SN 78-756,237. PUB. 7-25-2006, FILED 11-17-2005.

EQUASTASIS

THE MARK CONSISTS OF STANDARD CHARACTERS WITHOUT CLAIM TO ANY PARTICULAR FONT, STYLE, SIZE, OR COLOR.

FOR DIETARY SUPPLEMENTS (U.S. CLS. 6, 18, 44, 46, 51 AND 52).
FIRST USE 3-15-2007; IN COMMERCE 3-15-2007.

CLASS 5—(Continued).

3,314,029. BODY WISE INTERNATIONAL, LLC, TUSTIN, CA. SN 78-757,563. PUB. 9-5-2006, FILED 11-18-2005.

BW

THE MARK CONSISTS OF STANDARD CHARACTERS WITHOUT CLAIM TO ANY PARTICULAR FONT, STYLE, SIZE, OR COLOR.

FOR FOOD SUPPLEMENTS, NUTRITIONAL SUPPLEMENTS, MEAL REPLACEMENT SHAKES, POWDERED NUTRITIONAL SUPPLEMENT DRINK MIXES, VITAMINS, WEIGHT LOSS SUPPLEMENTS, DIETARY AND NUTRITIONAL KITS CONTAINING FOOD SUPPLEMENTS AND MEAL REPLACEMENTS SHAKES, HERBAL TEAS FOR MEDICINAL PURPOSES (U.S. CLS. 6, 18, 44, 46, 51 AND 52).

FIRST USE 2-1-2005; IN COMMERCE 2-1-2005.

3,314,093. IVX ANIMAL HEALTH, INC., ST. JOSEPH, MO. SN 78-767,869. PUB. 8-8-2006, FILED 12-6-2005.

SYNOVI

THE MARK CONSISTS OF STANDARD CHARACTERS WITHOUT CLAIM TO ANY PARTICULAR FONT, STYLE, SIZE, OR COLOR.

OWNER OF U.S. REG. NOS. 2,359,059, 3,012,550, AND OTHERS.

FOR VETERINARY NUTRITIONAL SUPPLEMENT FOR COMPANION ANIMALS (U.S. CLS. 6, 18, 44, 46, 51 AND 52).

FIRST USE 1-0-1999; IN COMMERCE 1-0-1999.

3,314,122. ENSYSTEX, INC., FAYETTEVILLE, NC. SN 78-773,416. PUB. 5-9-2006, FILED 12-14-2005.

PROTHOR

THE MARK CONSISTS OF STANDARD CHARACTERS WITHOUT CLAIM TO ANY PARTICULAR FONT, STYLE, SIZE, OR COLOR.

FOR PESTICIDES, INSECTICIDES, TERMITICIDES, HERBICIDES, FUNGICIDES, ALGAECIDES, AND PARASITICIDES FOR HOME, GARDEN, LAWN AND PROFESSIONAL USE IN PREPARATIONS FOR KILLING WEEDS AND DESTROYING VERMIN (U.S. CLS. 6, 18, 44, 46, 51 AND 52).

FIRST USE 3-12-2005; IN COMMERCE 4-30-2006.

CLASS 5—(Continued).

3,314,125. COAST REPRODUCTIVE, INC., SAN DIEGO, CA. SN 78-774,002. PUB. 8-8-2006, FILED 12-15-2005.

YOU'RE EXPECTING

THE MARK CONSISTS OF STANDARD CHARACTERS WITHOUT CLAIM TO ANY PARTICULAR FONT, STYLE, SIZE, OR COLOR.

FOR NUTRITIONAL SUPPLEMENTS (U.S. CLS. 6, 18, 44, 46, 51 AND 52).

FIRST USE 11-15-2005; IN COMMERCE 11-15-2005.

3,314,181. BIOTECH INTERNATIONAL CORPORATION, GLASTONBURY, CT. SN 78-782,694. PUB. 5-30-2006, FILED 12-29-2005.

COGNIVIN

THE MARK CONSISTS OF STANDARD CHARACTERS WITHOUT CLAIM TO ANY PARTICULAR FONT, STYLE, SIZE, OR COLOR.

FOR DIETARY SUPPLEMENTS; NUTRITIONAL SUPPLEMENTS; VITAMIN AND MINERAL SUPPLEMENTS (U.S. CLS. 6, 18, 44, 46, 51 AND 52).

FIRST USE 12-7-2006; IN COMMERCE 12-7-2006.

3,314,199. CHURCH & DWIGHT COMPANY, GREEN RIVER, WY. SN 78-785,334. PUB. 1-9-2007, FILED 1-5-2006.

FRIDGE FRESH

THE MARK CONSISTS OF STANDARD CHARACTERS WITHOUT CLAIM TO ANY PARTICULAR FONT, STYLE, SIZE, OR COLOR.

NO CLAIM IS MADE TO THE EXCLUSIVE RIGHT TO USE "FRIDGE", APART FROM THE MARK AS SHOWN.

FOR DEODORIZERS FOR USE IN KITCHEN APPLIANCES (U.S. CLS. 6, 18, 44, 46, 51 AND 52).

FIRST USE 5-1-2006; IN COMMERCE 5-1-2006.

CLASS 5—(Continued).

3,314,244. RIDLEY BLOCK OPERATIONS, INC., MANKATO, MN. SN 78-793,232. PUB. 9-19-2006, FILED 1-17-2006.

META-BOLYX

THE MARK CONSISTS OF STANDARD CHARACTERS WITHOUT CLAIM TO ANY PARTICULAR FONT, STYLE, SIZE, OR COLOR.

OWNER OF U.S. REG. NOS. 1,089,036, 2,506,579, AND 2,813,675.

FOR ANIMAL FEED SUPPLEMENTS (U.S. CLS. 6, 18, 44, 46, 51 AND 52).

FIRST USE 2-24-2006; IN COMMERCE 2-24-2006.

3,314,258. NOBLE FIBER TECHNOLOGIES, LLC, SCRANTON, PA. SN 78-795,680. PUB. 8-29-2006, FILED 1-20-2006.

SILVERAID

THE MARK CONSISTS OF STANDARD CHARACTERS WITHOUT CLAIM TO ANY PARTICULAR FONT, STYLE, SIZE, OR COLOR.

FOR ADHESIVE BANDAGES, ADHESIVES FOR BANDAGES FOR SKIN WOUNDS; BANDAGES FOR SKIN WOUNDS; SURGICAL BANDAGES (U.S. CLS. 6, 18, 44, 46, 51 AND 52).

FIRST USE 4-1-2006; IN COMMERCE 4-1-2006.

CLASS 5—(Continued).

3,314,262. CHURCH & DWIGHT COMPANY, GREEN RIVER, WY. SN 78-795,980. PUB. 1-9-2007, FILED 1-20-2006.



FRIDGE FRESH

OWNER OF U.S. REG. NOS. 1,795,450, 2,187,074, AND OTHERS.

NO CLAIM IS MADE TO THE EXCLUSIVE RIGHT TO USE "FRIDGE", APART FROM THE MARK AS SHOWN.

FOR DEODORIZERS FOR USE IN KITCHEN APPLIANCES (U.S. CLS. 6, 18, 44, 46, 51 AND 52).

FIRST USE 5-1-2006; IN COMMERCE 5-1-2006.

3,314,303. U.S. NUTRACEUTICALS, L.L.C., EUSTIS, FL. SN 78-805,504. PUB. 2-13-2007, FILED 2-2-2006.

NANOCOSANOL

THE MARK CONSISTS OF STANDARD CHARACTERS WITHOUT CLAIM TO ANY PARTICULAR FONT, STYLE, SIZE, OR COLOR.

FOR VITAMINS, NUTRITIONAL SUPPLEMENTS AND DIETARY SUPPLEMENTS (U.S. CLS. 6, 18, 44, 46, 51 AND 52).

FIRST USE 6-0-2007; IN COMMERCE 6-0-2007.

CLASS 5—(Continued).

3,314,318. WALCO INTERNATIONAL, INC., WESTLAKE, TX. SN 78-809,119. PUB. 9-5-2006, FILED 2-7-2006.

MIRACLE SAND OUT

THE MARK CONSISTS OF STANDARD CHARACTERS WITHOUT CLAIM TO ANY PARTICULAR FONT, STYLE, SIZE, OR COLOR.

NO CLAIM IS MADE TO THE EXCLUSIVE RIGHT TO USE "SAND", APART FROM THE MARK AS SHOWN.

FOR NUTRITIONAL PRODUCT FOR ABSORBING AND REMOVING SAND FROM THE STOMACH OF EQUINES (U.S. CLS. 6, 18, 44, 46, 51 AND 52).

FIRST USE 3-13-2006; IN COMMERCE 3-13-2006.

3,314,346. ALLERA HEALTH PRODUCTS, INC., ST. PETERSBURG, FL. SN 78-813,869. PUB. 5-8-2007, FILED 2-14-2006.

IMMUNEXTRA

THE MARK CONSISTS OF STANDARD CHARACTERS WITHOUT CLAIM TO ANY PARTICULAR FONT, STYLE, SIZE, OR COLOR.

FOR DIETARY SUPPLEMENTS (U.S. CLS. 6, 18, 44, 46, 51 AND 52).

FIRST USE 10-5-2006; IN COMMERCE 10-5-2006.

3,314,382. CARGILL, INCORPORATED, WAYZATA, MN. SN 78-819,239. PUB. 9-12-2006, FILED 2-21-2006.

Sweepstakes

THE MARK CONSISTS OF STANDARD CHARACTERS WITHOUT CLAIM TO ANY PARTICULAR FONT, STYLE, SIZE, OR COLOR.

FOR ANIMAL FEED SUPPLEMENTS (U.S. CLS. 6, 18, 44, 46, 51 AND 52).

FIRST USE 7-25-2006; IN COMMERCE 7-25-2006.

CLASS 5—(Continued).

3,314,416. NUTRAMAX LABORATORIES, INC., EDGEWOOD, MD. SN 78-826,035. PUB. 3-6-2007, FILED 3-1-2006.

NMX1000

THE MARK CONSISTS OF STANDARD CHARACTERS WITHOUT CLAIM TO ANY PARTICULAR FONT, STYLE, SIZE, OR COLOR.

FOR DIETARY SUPPLEMENT INGREDIENT, NAMELY, AVOCADO SOYBEAN UNSAPONIFIABLE (U.S. CLS. 6, 18, 44, 46, 51 AND 52).

FIRST USE 9-21-2006; IN COMMERCE 9-21-2006.

3,314,466. NATURAL ORGANICS INC., MELVILLE, NY. SN 78-837,800. PUB. 1-9-2007, FILED 3-15-2006.

RED LIGHTNING

THE MARK CONSISTS OF STANDARD CHARACTERS WITHOUT CLAIM TO ANY PARTICULAR FONT, STYLE, SIZE, OR COLOR.

NO CLAIM IS MADE TO THE EXCLUSIVE RIGHT TO USE "RED", APART FROM THE MARK AS SHOWN.

FOR DIETARY SUPPLEMENT (U.S. CLS. 6, 18, 44, 46, 51 AND 52).

FIRST USE 3-17-2006; IN COMMERCE 5-1-2006.

3,314,469. AMERILAB TECHNOLOGIES, INC., PLYMOUTH, MN. SN 78-839,501. PUB. 12-12-2006, FILED 3-16-2006.



OWNER OF U.S. REG. NO. 2,729,092.

FOR EFFERVESCENT PREPARATIONS FOR USE IN FOODS AND BEVERAGES, NAMELY, DIETARY SUPPLEMENTS, NUTRACEUTICALS FOR USE AS DIETARY SUPPLEMENTS; EFFERVESCENT PREPARATIONS FOR USE IN FOODS AND BEVERAGES, NAMELY, DIETARY AND NUTRITIONAL SUPPLEMENTS, NUTRACEUTICALS FOR USE AS DIETARY SUPPLEMENTS, AND SUPPLEMENTS FOR ANIMAL CONSUMPTION (U.S. CLS. 6, 18, 44, 46, 51 AND 52).

FIRST USE 7-1-1997; IN COMMERCE 8-1-1997.

CLASS 5—(Continued).

3,314,501. SYLVIA'S SECRETVITAMIN & NUTRITIONAL SUPPLEMENTS, LTD, CHESTNUT RIDGE, NY. SN 78-853,779. PUB. 11-21-2006, FILED 4-4-2006.

SYLVIASSECRET.COM

THE MARK CONSISTS OF STANDARD CHARACTERS WITHOUT CLAIM TO ANY PARTICULAR FONT, STYLE, SIZE, OR COLOR.

FOR NUTRITIONAL SUPPLEMENTS; VITAMINS (U.S. CLS. 6, 18, 44, 46, 51 AND 52).
FIRST USE 12-1-2006; IN COMMERCE 12-1-2006.

3,314,505. REPROQUEST, LLC, FITCHBURG, WI. SN 78-855,908. PUB. 5-8-2007, FILED 4-6-2006.

Preserv

THE MARK CONSISTS OF STANDARD CHARACTERS WITHOUT CLAIM TO ANY PARTICULAR FONT, STYLE, SIZE, OR COLOR.

FOR SANITARY PREPARATIONS FOR VETERINARY MEDICAL PURPOSES; DIAGNOSTIC PREPARATIONS FOR VETERINARY PURPOSES, ANTI-BACTERIAL PREPARATIONS FOR VETERINARY PURPOSES; EXTENDERS FOR THE MAINTENANCE AND STORAGE OF ANIMAL SEMEN, OOCYTES, OR EMBRYOS (U.S. CLS. 6, 18, 44, 46, 51 AND 52).
FIRST USE 8-0-2006; IN COMMERCE 8-0-2006.

3,314,509. ICASACOR, INC., BLUE BELL, PA. SN 78-858,523. PUB. 12-12-2006, FILED 4-11-2006.

SPAA

THE MARK CONSISTS OF STANDARD CHARACTERS WITHOUT CLAIM TO ANY PARTICULAR FONT, STYLE, SIZE, OR COLOR.

OWNER OF U.S. REG. NO. 2,799,032.
FOR NUTRITIONAL SUPPLEMENTS (U.S. CLS. 6, 18, 44, 46, 51 AND 52).
FIRST USE 1-0-2007; IN COMMERCE 1-0-2007.

CLASS 5—(Continued).

3,314,528. INO THERAPEUTICS, LLC, CLINTON, NJ. SN 78-863,912. PUB. 11-28-2006, FILED 4-18-2006.

COVOX

THE MARK CONSISTS OF STANDARD CHARACTERS WITHOUT CLAIM TO ANY PARTICULAR FONT, STYLE, SIZE, OR COLOR.

FOR PHARMACEUTICAL PREPARATION, NAMELY, CARBON MONOXIDE FOR INHALATION (U.S. CLS. 6, 18, 44, 46, 51 AND 52).
FIRST USE 2-23-2006; IN COMMERCE 9-29-2006.

3,314,557. SCIELE PHARMA, INC., ATLANTA, GA. SN 78-875,740. PUB. 1-9-2007, FILED 5-3-2006.

SCIELE

THE MARK CONSISTS OF STANDARD CHARACTERS WITHOUT CLAIM TO ANY PARTICULAR FONT, STYLE, SIZE, OR COLOR.

PRIORITY CLAIMED UNDER SEC. 44(D) ON ERP CMNTY TM OFC APPLICATION NO. 005051313, FILED 5-2-2006.

FOR HOUSE MARK FOR A FULL LINE OF PHARMACEUTICAL PREPARATIONS, DIETETIC AND NUTRITIONAL SUBSTANCES FOR MEDICAL USE AND VITAMINS; PRESCRIPTION PHARMACEUTICAL PREPARATIONS FOR HUMANS, NAMELY, PAIN MEDICATIONS, ANTIHISTAMINES, DECONGESTANTS, EARDROPS, LIQUID ANTITUSSIVES, CARDIOVASCULAR AND CARDIOLOGY MEDICATIONS, PREPARATIONS FOR TREATING METABOLIC DISORDERS, ANTICHOLINERGICS, PREPARATIONS FOR TREATING GASTROENTEROLOGY CONDITIONS, PREPARATIONS FOR TREATING NEUROLOGY CONDITIONS INCLUDING DEMENTIA, PREPARATIONS FOR TREATING URINARY TRACT INFECTIONS, PREPARATIONS FOR TREATING OSTEOPOROSIS AND PREPARATIONS FOR TREATING WOMEN'S HEALTH, PRENATAL VITAMINS AND MENSTRUAL PAIN RELIEF MEDICATIONS (U.S. CLS. 6, 18, 44, 46, 51 AND 52).
FIRST USE 7-1-2006; IN COMMERCE 7-1-2006.

CLASS 5—(Continued).

3,314,558. TRIVITA, INC., SCOTTSDALE, AZ. SN 78-876,025.
PUB. 10-3-2006, FILED 5-3-2006.

Optima Flex

THE MARK CONSISTS OF STANDARD CHARACTERS WITHOUT CLAIM TO ANY PARTICULAR FONT, STYLE, SIZE, OR COLOR.
FOR NUTRITIONAL SUPPLEMENT (U.S. CLS. 6, 18, 44, 46, 51 AND 52).
FIRST USE 9-29-2006; IN COMMERCE 9-29-2006.

CLASS 5—(Continued).

3,314,626. DREAMERZ FOODS, INC., SAN FRANCISCO, CA.
SN 78-893,595. PUB. 1-9-2007, FILED 5-25-2006.

DREAMERZ

THE MARK CONSISTS OF STANDARD CHARACTERS WITHOUT CLAIM TO ANY PARTICULAR FONT, STYLE, SIZE, OR COLOR.
FOR DIETARY SUPPLEMENT FORTIFIED BEVERAGES (U.S. CLS. 6, 18, 44, 46, 51 AND 52).
FIRST USE 2-20-2007; IN COMMERCE 2-20-2007.

3,314,574. TISHCON CORP., WESTBURY, NY. SN 78-880,075.
PUB. 12-19-2006, FILED 5-9-2006.

MITO-RX

THE MARK CONSISTS OF STANDARD CHARACTERS WITHOUT CLAIM TO ANY PARTICULAR FONT, STYLE, SIZE, OR COLOR.
FOR DIETARY SUPPLEMENT DESIGNED TO RESUSCITATE MITOCHONDRIA (U.S. CLS. 6, 18, 44, 46, 51 AND 52).
FIRST USE 4-4-2007; IN COMMERCE 4-4-2007.

3,314,752. TISHCON CORP., WESTBURY, NY. SN 78-926,788.
PUB. 12-19-2006, FILED 7-11-2006.

CUR-Q-GEL

THE MARK CONSISTS OF STANDARD CHARACTERS WITHOUT CLAIM TO ANY PARTICULAR FONT, STYLE, SIZE, OR COLOR.
FOR NUTRITIONAL SUPPLEMENTS (U.S. CLS. 6, 18, 44, 46, 51 AND 52).
FIRST USE 4-4-2007; IN COMMERCE 4-4-2007.

3,314,577. NATROL, INC., CHATSWORTH, CA. SN 78-881,494. PUB. 12-5-2006, FILED 5-11-2006.

SLENDERITE

THE MARK CONSISTS OF STANDARD CHARACTERS WITHOUT CLAIM TO ANY PARTICULAR FONT, STYLE, SIZE, OR COLOR.
FOR DIETARY SUPPLEMENTS (U.S. CLS. 6, 18, 44, 46, 51 AND 52).
FIRST USE 6-8-2006; IN COMMERCE 6-8-2006.

3,314,762. WALSH, RIANNON, EAST COVENTRY, PA. SN 78-932,024. PUB. 3-6-2007, FILED 7-18-2006.

SWEET RELIEF GNAT-URALLY

THE MARK CONSISTS OF STANDARD CHARACTERS WITHOUT CLAIM TO ANY PARTICULAR FONT, STYLE, SIZE, OR COLOR.
FOR INSECT REPELLENT (U.S. CLS. 6, 18, 44, 46, 51 AND 52).
FIRST USE 5-0-2006; IN COMMERCE 5-0-2006.

CLASS 5—(Continued).

3,314,781. PEGASUS LABORATORIES, INC., KANSAS CITY, MO. SN 78-940,122. PUB. 3-20-2007, FILED 7-28-2006.

GASTROMATE

THE MARK CONSISTS OF STANDARD CHARACTERS WITHOUT CLAIM TO ANY PARTICULAR FONT, STYLE, SIZE, OR COLOR.

FOR NUTRITIONAL SUPPLEMENT FOR TREATING GASTRIC DISORDERS AND TO PROMOTE ENTERIC HEALTH FOR VETERINARY APPLICATIONS (U.S. CLS. 6, 18, 44, 46, 51 AND 52).

FIRST USE 11-30-2006; IN COMMERCE 11-30-2006.

CLASS 5—(Continued).

3,314,821. BOARDROOM, INC., STAMFORD, CT. SN 78-952,512. PUB. 4-24-2007, FILED 8-15-2006.

BOTTOM LINE NUTRITIONALS

THE MARK CONSISTS OF STANDARD CHARACTERS WITHOUT CLAIM TO ANY PARTICULAR FONT, STYLE, SIZE, OR COLOR.

OWNER OF U.S. REG. NOS. 2,148,643 AND 3,057,998.

NO CLAIM IS MADE TO THE EXCLUSIVE RIGHT TO USE "NUTRITIONALS", APART FROM THE MARK AS SHOWN.

FOR VITAMIN AND NUTRITIONAL SUPPLEMENTS (U.S. CLS. 6, 18, 44, 46, 51 AND 52).

FIRST USE 4-6-2007; IN COMMERCE 4-6-2007.

3,314,789. DREAMERZ FOODS, INC., SAN FRANCISCO, CA. SN 78-941,212. PUB. 4-17-2007, FILED 7-31-2006.

CRÈME DE LA REM

THE MARK CONSISTS OF STANDARD CHARACTERS WITHOUT CLAIM TO ANY PARTICULAR FONT, STYLE, SIZE, OR COLOR.

FOR BEVERAGES FORTIFIED WITH DIETARY SUPPLEMENTS (U.S. CLS. 6, 18, 44, 46, 51 AND 52).

FIRST USE 3-13-2007; IN COMMERCE 3-13-2007.

3,314,830. SIMILASAN CORPORATION, HIGHLANDS RANCH, CO. SN 78-955,649. PUB. 4-10-2007, FILED 8-18-2006.

TRUSTED MEDICINE... NATURALLY

THE MARK CONSISTS OF STANDARD CHARACTERS WITHOUT CLAIM TO ANY PARTICULAR FONT, STYLE, SIZE, OR COLOR.

FOR NATURAL PHARMACEUTICAL PREPARATIONS AND HOMEOPATHIC PHARMACEUTICALS FOR USE IN THE TREATMENT OF MEDICAL CONDITIONS OF THE EYES, EARS, NOSE AND THROAT (U.S. CLS. 6, 18, 44, 46, 51 AND 52).

FIRST USE 5-1-2007; IN COMMERCE 5-1-2007.

3,314,805. W.F. YOUNG, INC., EAST LONGMEADOW, MA. SN 78-946,978. PUB. 4-17-2007, FILED 8-8-2006.

EASY SWIPE

THE MARK CONSISTS OF STANDARD CHARACTERS WITHOUT CLAIM TO ANY PARTICULAR FONT, STYLE, SIZE, OR COLOR.

FOR APPLICATORS FOR A INSECT REPELLANT CONTAINING INSECT REPELLANT (U.S. CLS. 6, 18, 44, 46, 51 AND 52).

FIRST USE 12-15-2006; IN COMMERCE 12-15-2006.

3,314,838. BRANDT CONSOLIDATED, INC., PLEASANT PLAINS, IL. SN 78-956,370. PUB. 4-17-2007, FILED 8-21-2006.

ECOTEC

THE MARK CONSISTS OF STANDARD CHARACTERS WITHOUT CLAIM TO ANY PARTICULAR FONT, STYLE, SIZE, OR COLOR.

FOR TURF INSECTICIDE (U.S. CLS. 6, 18, 44, 46, 51 AND 52).

FIRST USE 7-1-2006; IN COMMERCE 7-1-2006.

CLASS 5—(Continued).

3,314,839. BRANDT CONSOLIDATED, INC., PLEASANT PLAINS, IL. SN 78-956,376. PUB. 4-10-2007, FILED 8-21-2006.

PARADOX

THE MARK CONSISTS OF STANDARD CHARACTERS WITHOUT CLAIM TO ANY PARTICULAR FONT, STYLE, SIZE, OR COLOR.

FOR HERBICIDE, FUNGICIDE, INSECTICIDE, PESTICIDE FOR TURF (U.S. CLS. 6, 18, 44, 46, 51 AND 52).
FIRST USE 7-1-2006; IN COMMERCE 7-1-2006.

3,314,840. BRANDT CONSOLIDATED, INC., PLEASANT PLAINS, IL. SN 78-956,598. PUB. 4-10-2007, FILED 8-21-2006.

SPORATEC

THE MARK CONSISTS OF STANDARD CHARACTERS WITHOUT CLAIM TO ANY PARTICULAR FONT, STYLE, SIZE, OR COLOR.

FOR TURF FUNGICIDE (U.S. CLS. 6, 18, 44, 46, 51 AND 52).
FIRST USE 7-1-2006; IN COMMERCE 7-1-2006.

3,314,869. SUN GREEN INTERNATIONAL, INC., RICHARDSON, TX. SN 78-966,121. PUB. 5-1-2007, FILED 9-1-2006.

SG CHOSANOL

THE MARK CONSISTS OF STANDARD CHARACTERS WITHOUT CLAIM TO ANY PARTICULAR FONT, STYLE, SIZE, OR COLOR.

FOR DIETARY AND NUTRITIONAL SUPPLEMENTS (U.S. CLS. 6, 18, 44, 46, 51 AND 52).
FIRST USE 8-1-2006; IN COMMERCE 8-1-2006.

CLASS 6—METAL GOODS**CLASS 6—(Continued).**

3,313,018. LEN STAR WELDING & FABRICATORS LIMITED, TORONTO, ONTARIO, CANADA. SN 76-512,126. PUB. 9-26-2006, FILED 5-6-2003.

STARLOCK

FOR METAL SCAFFOLDING SYSTEM FOR USE IN THE CONSTRUCTION INDUSTRY; METAL SCAFFOLDING SYSTEM COMPONENTS, NAMELY, BRACINGS, LEDGERS, STANDARDS, SIDE BRACKETS AND PLANKING, ALL FOR USE IN THE CONSTRUCTION INDUSTRY (U.S. CLS. 2, 12, 13, 14, 23, 25 AND 50).

FIRST USE 1-6-2003; IN COMMERCE 6-2-2003.

3,313,022. PERMA-PIPE, INC., NILES, IL. SN 76-517,891. PUB. 1-20-2004, FILED 5-29-2003.

ULTRA-THERM

OWNER OF U.S. REG. NO. 2,294,963.
FOR FIBERGLASS CLAD STEEL CONDUIT/PIPE (U.S. CLS. 2, 12, 13, 14, 23, 25 AND 50).
FIRST USE 12-31-2003; IN COMMERCE 12-31-2003.

3,313,066. MATERIAL SCIENCES CORPORATION, ENGINEERED MATERIALS AND SOLUTIONS GROUP, INC., ELK GROVE VILLAGE, IL. SN 76-606,224. PUB. 7-5-2005, FILED 8-9-2004.

MAGNADAMP

THE MARK CONSISTS OF STANDARD CHARACTERS WITHOUT CLAIM TO ANY PARTICULAR FONT, STYLE, SIZE, OR COLOR.

FOR MATERIALS MADE PRINCIPALLY OF METAL IN SHEET FORM AND COILED FORM, WITH ONE OR MORE METAL LAYERS AND ONE OR MORE DAMPING LAYERS, TO BE FURTHER FABRICATED BY CUSTOMERS INTO PRODUCTS WHICH HAVE NOISE DAMPING CAPABILITY (U.S. CLS. 2, 12, 13, 14, 23, 25 AND 50).

FIRST USE 11-0-2006; IN COMMERCE 11-0-2006.

CLASS 6—(Continued).

3,313,106. R.A.P. SECURITY, INC., CUDAHY, CA. SN 76-632,261. PUB. 8-15-2006, FILED 2-28-2005.

CLASS 6—(Continued).

3,313,429. AZOT, INC., BOULDER, CO. SN 78-375,053. PUB. 8-1-2006, FILED 2-27-2004.

GOURMET FLEXI

THE MARK CONSISTS OF STANDARD CHARACTERS WITHOUT CLAIM TO ANY PARTICULAR FONT, STYLE, SIZE, OR COLOR.

FOR METAL WALL PANELS WITH SHELVES MOUNTED THEREON FOR SALE TO PROFESSIONAL BUYERS (U.S. CLS. 2, 12, 13, 14, 23, 25 AND 50).

FIRST USE 8-28-2005; IN COMMERCE 8-28-2005.

3,313,192. JB LOCK LLC, BOISE, ID. SN 76-654,806. PUB. 9-26-2006, FILED 2-9-2006.

**GREEN LIGHT ON THE RIGHT**

THE MARK CONSISTS OF STANDARD CHARACTERS WITHOUT CLAIM TO ANY PARTICULAR FONT, STYLE, SIZE, OR COLOR.

FOR METAL SECURITY LOCK BOXES FOR TRAILER HITCHES (U.S. CLS. 2, 12, 13, 14, 23, 25 AND 50).

FIRST USE 6-1-2007; IN COMMERCE 6-1-2007.

3,313,292. CHICAGO METALLIC CORPORATION, CHICAGO, IL. SN 77-022,566. PUB. 2-6-2007, FILED 10-17-2006.

THE COLOR(S) GRAY, YELLOW AND BLACK IS/ARE CLAIMED AS A FEATURE OF THE MARK.

THE MARK CONSISTS OF THE WORD AURODYN IN WHICH THE LETTERS AUR ARE IN THE COLOR BLACK FOLLOWED BY A THREE-DIMENSIONAL FACETED SPHERE FEATURING THE COLORS YELLOW AND GRAY AND FOLLOWED BY THE LETTERS DYN WHICH ARE ALSO IN THE COLOR BLACK.

FOR METAL BUILDING MATERIALS, NAMELY, TUBES, TUBULAR RODS, RODS, STRUCTURAL PANELS, IN PARTICULAR STRUCTURAL PANELS FOR WALLS, FLOORS, CEILINGS FACADES AND COVERING PANELS; CONNECTING PIECES OF METAL FOR BUILDING, NAMELY NODE AND STRUTS AND WEIGHTS-BEARING PIECES OF METAL FOR BUILDING, NAMELY, STRUTS; TRANSPORTABLE BUILDINGS OF METAL IN THE NATURE OF SPACE FRAMEWORKS; TRANSPORTABLE BUILDINGS OF METAL NAMELY, SCAFFOLDINGS, ROSTRUMS AND STANDS SERVICING AND MAINTENANCE STANDS AND FRAMEWORKS FOR AERO PLANES, LAND AND WATER VEHICLES; TRANSPORTABLE BUILDINGS OF METAL, NAMELY, COMMERCIAL, INSTITUTIONAL, AND RELIGIOUS BUILDINGS, ATRIA, ENTRYWAYS, TOWERS, BRIDGES, CONSERVATORIES, MUSEUMS, THEATERS, MUSIC HALLS, ART GALLERIES, OPERA HOUSES, CUSTOM HOMES, BOAT RIGGING, SCULPTURES, PLAYGROUNDS, NON-LUMINOUS AND NON-MECHANICAL METAL SIGNS, METAL EXHIBITION BUILDINGS, THEATER AND FILM SETS, LIGHTING SCAFFOLDS, METAL THEME PARK BUILDINGS, STRUCTURAL SUPPORTS FOR INDUSTRIAL PROCESS EQUIPMENT; METAL MILITARY EQUIPMENT, NAMELY, TENT PEGS AND STAKES, PORTABLE METAL MILITARY BUILDINGS (U.S. CLS. 2, 12, 13, 14, 23, 25 AND 50).

FIRST USE 2-26-2004; IN COMMERCE 2-26-2004.

SPANFAST

THE MARK CONSISTS OF STANDARD CHARACTERS WITHOUT CLAIM TO ANY PARTICULAR FONT, STYLE, SIZE, OR COLOR.

FOR METAL CEILING SUPPORTS FOR DRYWALL SUSPENSION SYSTEMS (U.S. CLS. 2, 12, 13, 14, 23, 25 AND 50).

FIRST USE 4-17-2007; IN COMMERCE 4-17-2007.

3,313,358. KASS INDUSTRIAL SUPPLY CORP., BRONX, NY. SN 78-153,631. PUB. 2-3-2004, FILED 8-13-2002.

TITE ROCK

FOR METAL SCREWS (U.S. CLS. 2, 12, 13, 14, 23, 25 AND 50).

FIRST USE 1-0-2007; IN COMMERCE 1-0-2007.

CLASS 6—(Continued).

3,313,442. NORDSON CORPORATION, WESTLAKE, OH. SN 78-400,030. PUB. 9-6-2005, FILED 4-12-2004.

VANTAGE

THE MARK CONSISTS OF STANDARD CHARACTERS WITHOUT CLAIM TO ANY PARTICULAR FONT, STYLE, SIZE, OR COLOR.
FOR POWDER COATING PAINT SPRAY BOOTHS, MADE OF METAL (U.S. CLS. 2, 12, 13, 14, 23, 25 AND 50).
FIRST USE 10-26-2006; IN COMMERCE 10-26-2006.

3,313,747. COOPER TECHNOLOGIES COMPANY, HOUSTON, TX. SN 78-654,394. PUB. 5-9-2006, FILED 6-20-2005.

ENVIROSHIELD

THE MARK CONSISTS OF STANDARD CHARACTERS WITHOUT CLAIM TO ANY PARTICULAR FONT, STYLE, SIZE, OR COLOR.
FOR METAL ENCLOSURES, NAMELY METAL BOXES TO HOUSE ELECTRICAL EQUIPMENT (U.S. CLS. 2, 12, 13, 14, 23, 25 AND 50).
FIRST USE 11-1-2005; IN COMMERCE 11-1-2005.

3,313,749. COOPER TECHNOLOGIES COMPANY, HOUSTON, TX. SN 78-654,553. PUB. 5-9-2006, FILED 6-20-2005.



FOR METAL ENCLOSURES, NAMELY METAL BOXES TO HOUSE ELECTRICAL EQUIPMENT (U.S. CLS. 2, 12, 13, 14, 23, 25 AND 50).
FIRST USE 11-1-2005; IN COMMERCE 11-1-2005.

CLASS 6—(Continued).

3,313,789. CAS DESIGNS, INC., NOVATO, CA. SN 78-671,995. PUB. 10-3-2006, FILED 7-17-2005.

Molar Money

THE MARK CONSISTS OF STANDARD CHARACTERS WITHOUT CLAIM TO ANY PARTICULAR FONT, STYLE, SIZE, OR COLOR.
FOR METAL TOKENS USED AS DENTAL PATIENT COMPLIANCE REWARDS (U.S. CLS. 2, 12, 13, 14, 23, 25 AND 50).
FIRST USE 4-15-2007; IN COMMERCE 4-15-2007.

3,313,873. ATI PROPERTIES, INC., ALBANY, OR. SN 78-709,721. PUB. 5-30-2006, FILED 9-9-2005.

THE SWITCH IS ON!

THE MARK CONSISTS OF STANDARD CHARACTERS WITHOUT CLAIM TO ANY PARTICULAR FONT, STYLE, SIZE, OR COLOR.
FOR STAINLESS STEEL IN SHEET, PLATE AND STRIP FORM (U.S. CLS. 2, 12, 13, 14, 23, 25 AND 50).
FIRST USE 0-0-2006; IN COMMERCE 0-0-2006.

3,314,184. JEWETT CAMERON LUMBER CORPORATION, NORTH PLAINS, OR. SN 78-784,371. PUB. 9-26-2006, FILED 1-3-2006.

PERIMETER PATROL

THE MARK CONSISTS OF STANDARD CHARACTERS WITHOUT CLAIM TO ANY PARTICULAR FONT, STYLE, SIZE, OR COLOR.
FOR TEMPORARY METAL FENCE PANELS (U.S. CLS. 2, 12, 13, 14, 23, 25 AND 50).
FIRST USE 10-1-2006; IN COMMERCE 10-1-2006.

CLASS 6—(Continued).

3,314,217. WERNER CO., GREENVILLE, PA. SN 78-789,047.
PUB. 9-19-2006, FILED 1-11-2006.

THE Transformer
BY 

OWNER OF U.S. REG. NOS. 833,191 AND 2,914,896.
FOR METAL LADDERS AND STEP STOOLS (U.S. CLS.
2, 12, 13, 14, 23, 25 AND 50).
FIRST USE 10-10-2005; IN COMMERCE 10-10-2005.

3,314,261. FASTEC INDUSTRIAL CORP., ELKHART, IN. SN
78-795,960. PUB. 9-5-2006, FILED 1-20-2006.

EZ-JUST

THE MARK CONSISTS OF STANDARD CHARACTERS
WITHOUT CLAIM TO ANY PARTICULAR FONT, STYLE,
SIZE, OR COLOR.
FOR METAL DOOR LATCHES (U.S. CLS. 2, 12, 13, 14,
23, 25 AND 50).
FIRST USE 6-20-2006; IN COMMERCE 6-20-2006.

3,314,300. COOPER TECHNOLOGIES COMPANY, HOUS-
TON, TX. SN 78-805,116. PUB. 10-3-2006, FILED 2-2-2006.

REDIMOUNT

THE MARK CONSISTS OF STANDARD CHARACTERS
WITHOUT CLAIM TO ANY PARTICULAR FONT, STYLE,
SIZE, OR COLOR.
FOR HANGERS, NAMELY, METAL CEILING FAN/
FIXTURE HANGERS; METAL STRUCTURAL CHAN-
NEL HANGERS; AND, HARDWARE KITS COMPOSED
OF METAL WASHERS, METAL THREADED NUTS,
METAL MASONRY ANCHORS, METAL MASONRY
BOLTS, METAL ANGLE BRACKETS, METAL TOGGLE
BOLTS AND METAL CLAMPS, FOR USE IN INSTAL-
LING METAL STRUCTURAL CHANNEL HANGERS,
CEILING FANS AND ELECTRICAL FIXTURES (U.S.
CLS. 2, 12, 13, 14, 23, 25 AND 50).
FIRST USE 1-2-2000; IN COMMERCE 1-2-2000.

CLASS 6—(Continued).

3,314,377. IMPERIAL USA LTD., CHARLOTTE, NC. SN 78-
818,505. PUB. 9-26-2006, FILED 2-19-2006.

SUITE YOUR HOME

THE MARK CONSISTS OF STANDARD CHARACTERS
WITHOUT CLAIM TO ANY PARTICULAR FONT, STYLE,
SIZE, OR COLOR.

FOR DOOR HARDWARE, NAMELY KEYS AND KEY
CYLINDERS; DOOR STOPS OF METAL; METAL DOOR
KICK PLATES; METAL HANDLES FOR DOORS; METAL
LOCKS; METAL LOCKS FOR DOORS; METAL SASH
LOCKS; METAL SECURITY LOCK CYLINDERS (U.S.
CLS. 2, 12, 13, 14, 23, 25 AND 50).
FIRST USE 3-27-2007; IN COMMERCE 3-27-2007.

CLASS 7—MACHINERY

3,313,017. PANASONIC CORPORATION OF NORTH AMER-
ICA, SECAUCUS, NJ. SN 76-509,713. PUB. 1-27-2004, FILED
4-9-2003.

ideas for life

FOR WOOD SAWS, IMPACT DRIVERS (U.S. CLS. 13,
19, 21, 23, 31, 34 AND 35).
FIRST USE 10-31-2005; IN COMMERCE 10-31-2005.

3,313,056. FUJIFILM DIMATIX, INC., LEBANON, NH. SN 76-
592,280. PUB. 12-20-2005, FILED 5-14-2004.

SPECTRA JETPOWERED

THE MARK CONSISTS OF STANDARD CHARACTERS
WITHOUT CLAIM TO ANY PARTICULAR FONT, STYLE,
SIZE, OR COLOR.

FOR MACHINES FOR SHAPING MATERIALS INTO
DESIRED FORM, AND FOR EXTRUDING, EJECTING
OR DISPENSING OF DECORATIONS, COATINGS, AND
PRINTHEADS AS A COMPONENT PART OF THE
FOREGOING; MICROPUMPS FOR EXTRUDING,
EJECTING OR DISPENSING OF FOODSTUFFS, DEC-
ORATIONS, CLOTHING ACCESSORIES AND COMPO-
NENTS, PHARMACEUTICAL PREPARATIONS,
MEDICAL PREPARATIONS, BIOLOGICAL SUB-
STANCES, ADHESIVES, COATINGS, OFFICE SUPPLIES,
WALL COVERING MATERIALS AND FLOOR COVER-
ING MATERIALS; MICROPUMPS FOR SHAPING MA-
TERIALS INTO DESIRED FORM (U.S. CLS. 13, 19, 21, 23,
31, 34 AND 35).
FIRST USE 5-6-2004; IN COMMERCE 5-6-2004.

CLASS 7—(Continued).

3,313,088. JOUBERT, MICHAEL, GREINA, LA. AND FOLSE, ROY, GREINA, LA. SN 76-622,714. PUB. 9-19-2006, FILED 12-1-2004.

CAJUN TORNADO

THE MARK CONSISTS OF STANDARD CHARACTERS WITHOUT CLAIM TO ANY PARTICULAR FONT, STYLE, SIZE, OR COLOR.

FOR PAINT MIXING ATTACHMENT USED IN CONNECTION WITH POWER HAND DRILLS (U.S. CLS. 13, 19, 21, 23, 31, 34 AND 35).
FIRST USE 1-12-2007; IN COMMERCE 1-12-2007.



3,313,125. YANMAR CO., LTD., KITA-KU, OSAKA, JAPAN. SN 76-636,628. PUB. 8-8-2006, FILED 4-21-2005.

CBL

THE MARK CONSISTS OF STANDARD CHARACTERS WITHOUT CLAIM TO ANY PARTICULAR FONT, STYLE, SIZE, OR COLOR.

FOR CIVIL ENGINEERING MACHINES AND CONSTRUCTION MACHINES, NAMELY, BACKHOE LOADERS (U.S. CLS. 13, 19, 21, 23, 31, 34 AND 35).
FIRST USE 12-2-2005; IN COMMERCE 12-2-2005.



3,313,147. YANMAR CO., LTD., KITA-KU, OSAKA, JAPAN. SN 76-641,896. PUB. 8-29-2006, FILED 6-29-2005.

UNIVERSAL VIO

THE MARK CONSISTS OF STANDARD CHARACTERS WITHOUT CLAIM TO ANY PARTICULAR FONT, STYLE, SIZE, OR COLOR.

OWNER OF U.S. REG. NO. 2,705,119.
FOR EXCAVATING MACHINES, DIGGING MACHINES AND DIESEL ENGINES FOR MACHINES (U.S. CLS. 13, 19, 21, 23, 31, 34 AND 35).
FIRST USE 7-5-2005; IN COMMERCE 7-5-2005.

CLASS 7—(Continued).

3,313,181. THE SCOTT FETZER COMPANY, WESTLAKE, OH. SN 76-651,941. PUB. 9-12-2006, FILED 12-15-2005.



FOR VACUUM CLEANERS AND VACUUM CLEANER ACCESSORIES, NAMELY, VACUUM CLEANER BAGS, VACUUM CLEANER BELTS, VACUUM CLEANER BRUSH ROLLS, VACUUM CLEANER BRUSHES, VACUUM CLEANER HOSES, VACUUM CLEANER WANDS, VACUUM CLEANER HOSE EXTENSION TUBES, VACUUM CLEANER HANDLE EXTENSIONS, VACUUM CLEANER CREVICE TOOLS, VACUUM CLEANER MOTORS, VACUUM CLEANER TRANSMISSIONS, VACUUM CLEANER HEADLIGHT BULBS, VACUUM CLEANER SWITCHES, VACUUM CLEANER CORDS, VACUUM CLEANER WHEELS, VACUUM CLEANER BUMPERS, VACUUM CLEANER SANDER ATTACHMENTS, VACUUM CLEANER BUFFER ATTACHMENTS, VACUUM CLEANER POLISHING ATTACHMENTS, AND VACUUM CLEANER CARPET SHAMPOOING ATTACHMENTS (U.S. CLS. 13, 19, 21, 23, 31, 34 AND 35).

FIRST USE 1-4-2007; IN COMMERCE 1-4-2007.



3,313,190. TSUKIBOSHI MFG. CO. LTD. PREF. 922, JAPAN. SN 76-653,671. PUB. 9-26-2006, FILED 1-20-2006.

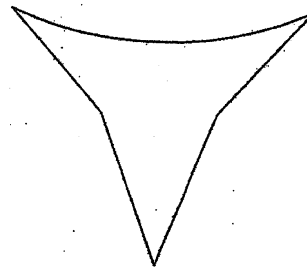

FOR CYLINDER HEAD BOLTS FOR MOTORCYCLE ENGINES (U.S. CLS. 13, 19, 21, 23, 31, 34 AND 35).
FIRST USE 0-0-2000; IN COMMERCE 0-0-2000.

CLASS 7—(Continued).

3,313,575. ATTACHMENT TECHNOLOGIES, INC., CEDAR RAPIDS, IA. SN 78-574,325. PUB. 11-22-2005, FILED 2-24-2005.

BRADCO

THE MARK CONSISTS OF STANDARD CHARACTERS WITHOUT CLAIM TO ANY PARTICULAR FONT, STYLE, SIZE, OR COLOR.

OWNER OF U.S. REG. NO. 1,004,477.
FOR CONSTRUCTION EQUIPMENT ATTACHMENTS FOR SKID STEERS AND TRACTORS, NAMELY, BACKHOES, TRENCHERS, BROOMS, MATERIAL HANDLERS AND BUCKETS (U.S. CLS. 13, 19, 21, 23, 31, 34 AND 35).
FIRST USE 6-0-2005; IN COMMERCE 6-0-2005.

CLASS 7—(Continued).

3,313,577. ATTACHMENT TECHNOLOGIES, INC., CEDAR RAPIDS, IA. SN 78-574,375. PUB. 11-22-2005, FILED 2-24-2005.

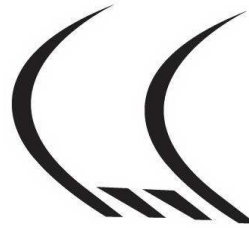

FOR BUCKETS, THUMBS AND COUPLERS FOR EXCAVATORS AND BACKHOES AND BUCKETS, FORKS AND RAKES FOR WHEEL LOADERS (U.S. CLS. 13, 19, 21, 23, 31, 34 AND 35).

FIRST USE 11-0-2006; IN COMMERCE 11-0-2006.

3,313,576. ATTACHMENT TECHNOLOGIES, INC., CEDAR RAPIDS, IA. SN 78-574,350. PUB. 11-22-2005, FILED 2-24-2005.

CP

THE MARK CONSISTS OF STANDARD CHARACTERS WITHOUT CLAIM TO ANY PARTICULAR FONT, STYLE, SIZE, OR COLOR.

OWNER OF U.S. REG. NO. 2,532,292.
FOR BUCKETS, THUMBS AND COUPLERS FOR EXCAVATORS AND BACKHOES AND BUCKETS, FORKS AND RAKES FOR WHEEL LOADERS (U.S. CLS. 13, 19, 21, 23, 31, 34 AND 35).
FIRST USE 11-0-2006; IN COMMERCE 11-0-2006.

3,313,578. ATTACHMENT TECHNOLOGIES, INC., CEDAR RAPIDS, IA. SN 78-574,389. PUB. 12-27-2005, FILED 2-24-2005.



OWNER OF U.S. REG. NO. 2,532,292.
NO CLAIM IS MADE TO THE EXCLUSIVE RIGHT TO USE "HEAVY CONSTRUCTION", APART FROM THE MARK AS SHOWN.

FOR BUCKETS, THUMBS AND COUPLERS FOR EXCAVATORS AND BACKHOES AND BUCKETS, FORKS AND RAKES FOR WHEEL LOADERS (U.S. CLS. 13, 19, 21, 23, 31, 34 AND 35).
FIRST USE 3-1-2007; IN COMMERCE 3-1-2007.

CLASS 7—(Continued).

3,313,605. EMERSON ELECTRIC CO., ST. LOUIS, MO. SN 78-590,692. PUB. 8-1-2006, FILED 3-18-2005.

OWNER OF U.S. REG. NO. 892,794.
FOR FOOD WASTE DISPOSERS, GARBAGE DISPOSALS, AND REPLACEMENT AND COMPONENT PARTS THEREFOR; SPLASH BAFFLES FOR FOOD WASTE DISPOSERS AND GARBAGE DISPOSALS (U.S. CLS. 13, 19, 21, 23, 31, 34 AND 35).
FIRST USE 4-21-2006; IN COMMERCE 4-21-2006.

3,313,623. MITSUBISHI ELECTRIC CORPORATION, CHIYODA-KU, TOKYO, JAPAN. SN 78-602,785. PUB. 8-1-2006, FILED 4-6-2005.

OWNER OF U.S. REG. NO. 2,721,605.
FOR INDUSTRIAL ROBOTS (U.S. CLS. 13, 19, 21, 23, 31, 34 AND 35).
FIRST USE 6-25-1982; IN COMMERCE 6-25-1982.

3,313,757. SAVI MEDIA GROUP, INC., HUNTINGTON BEACH, CA. SN 78-656,531. PUB. 10-31-2006, FILED 6-23-2005.

EconoValve

THE MARK CONSISTS OF STANDARD CHARACTERS WITHOUT CLAIM TO ANY PARTICULAR FONT, STYLE, SIZE, OR COLOR.

NO CLAIM IS MADE TO THE EXCLUSIVE RIGHT TO USE "VALVE", APART FROM THE MARK AS SHOWN. SEC. 2(F).

FOR EMISSION REDUCTION VALVES FOR MOTORS AND ENGINES, NAMELY PCV VALVES (U.S. CLS. 13, 19, 21, 23, 31, 34 AND 35).

FIRST USE 10-1-2006; IN COMMERCE 10-1-2006.

CLASS 7—(Continued).

3,313,870. CRYSTAL GLASS CANADA LTD., EDMONTON, ALBERTA, CANADA. SN 78-709,230. PUB. 9-19-2006, FILED 9-8-2005.

EXTRACTOR

THE MARK CONSISTS OF STANDARD CHARACTERS WITHOUT CLAIM TO ANY PARTICULAR FONT, STYLE, SIZE, OR COLOR.

PRIORITY CLAIMED UNDER SEC. 44(D) ON CANADA APPLICATION NO. 1250151, FILED 3-10-2005, REG. NO. TMA662,048, DATED 4-3-2006, EXPIRES 4-3-2021.

FOR HAND HELD POWER TOOL USED TO SEVER THE URETHANE BED AROUND WINDSHIELDS IN AUTOMOBILES; A HAND HELD POWER TOOL USED TO SEVER THE SEAL BETWEEN TWO SURFACES GLUED TO EACH OTHER (U.S. CLS. 13, 19, 21, 23, 31, 34 AND 35).

FIRST USE 9-15-2005; IN COMMERCE 9-15-2005.

3,314,037. HUGHES-MILLAR HOLDINGS, LLC, ALISO VIEJO, CA. SN 78-759,749. PUB. 3-6-2007, FILED 11-22-2005.

VACNSEAL

THE MARK CONSISTS OF STANDARD CHARACTERS WITHOUT CLAIM TO ANY PARTICULAR FONT, STYLE, SIZE, OR COLOR.

FOR POWER OPERATED VACUUM MACHINES FOR USE IN THE KITCHEN TO REMOVE AIR FROM REUSABLE PLASTIC BAGS FOR THE STORAGE OF FOOD (U.S. CLS. 13, 19, 21, 23, 31, 34 AND 35).

FIRST USE 1-20-2005; IN COMMERCE 1-20-2005.

3,314,071. B & J MANUFACTURING COMPANY, GLENWOOD, IL. SN 78-765,311. PUB. 8-29-2006, FILED 12-2-2005.

DURO-MAX

THE MARK CONSISTS OF STANDARD CHARACTERS WITHOUT CLAIM TO ANY PARTICULAR FONT, STYLE, SIZE, OR COLOR.

FOR MACHINE PARTS, NAMELY, RASP HUBS FOR RASP BLADES USED IN BOTH HAND-HELD AND MOUNTED TIRE RE-TREADING MACHINES, AND REPLACEMENT RASP BLADES FOR USE IN TIRE RE-TREADING MACHINES (U.S. CLS. 13, 19, 21, 23, 31, 34 AND 35).

FIRST USE 1-1-2006; IN COMMERCE 1-1-2006.

CLASS 7—(Continued).

3,314,077. CONAIR CORPORATION, STAMFORD, CT. SN 78-765,621. PUB. 8-1-2006, FILED 12-2-2005.

WARING PRO

THE MARK CONSISTS OF STANDARD CHARACTERS WITHOUT CLAIM TO ANY PARTICULAR FONT, STYLE, SIZE, OR COLOR.

OWNER OF U.S. REG. NOS. 2,681,182, 2,993,269, AND OTHERS.

NO CLAIM IS MADE TO THE EXCLUSIVE RIGHT TO USE "PRO", APART FROM THE MARK AS SHOWN.

FOR ELECTRIC KNIFE SHARPENERS; ELECTRIC MEAT GRINDERS; POWER-OPERATED MEAT GRINDERS (U.S. CLS. 13, 19, 21, 23, 31, 34 AND 35).

FIRST USE 9-0-2002; IN COMMERCE 9-0-2002.

3,314,173. SCHRAMM, INC., WEST CHESTER, PA. SN 78-780,913. PUB. 11-28-2006, FILED 12-27-2005.

I-CONTROL

THE MARK CONSISTS OF STANDARD CHARACTERS WITHOUT CLAIM TO ANY PARTICULAR FONT, STYLE, SIZE, OR COLOR.

FOR ELECTRONIC CONTROLS AND MONITORS FOR CONTROLLING AND MONITORING THE OPERATION AND PERFORMANCE OF DRILL RIGS, SOLD AS COMPONENTS OF DRILL RIGS FOR EARTH DRILLING (U.S. CLS. 13, 19, 21, 23, 31, 34 AND 35).

FIRST USE 12-28-2006; IN COMMERCE 12-28-2006.

3,314,188. HEALTHY GAIN INVESTMENTS LIMITED, TSUEN WAN, N.T., HONG KONG. SN 78-784,539. PUB. 8-1-2006, FILED 1-4-2006.

REAL TIME

THE MARK CONSISTS OF STANDARD CHARACTERS WITHOUT CLAIM TO ANY PARTICULAR FONT, STYLE, SIZE, OR COLOR.

FOR TOOL FEATURE IN THE NATURE OF A HANDLE WHICH CONVERTS TO A TELESCOPIC WAND WITH ACCOMPANYING ATTACHMENTS SOLD AS AN INTEGRAL COMPONENT OF VACUUM CLEANERS (U.S. CLS. 13, 19, 21, 23, 31, 34 AND 35).

FIRST USE 6-1-2006; IN COMMERCE 6-1-2006.

CLASS 7—(Continued).

3,314,221. HY CITE CORPORATION, MADISON, WI. SN 78-790,041. PUB. 10-31-2006, FILED 1-12-2006.

DRIVEN BY NATURE

THE MARK CONSISTS OF STANDARD CHARACTERS WITHOUT CLAIM TO ANY PARTICULAR FONT, STYLE, SIZE, OR COLOR.

FOR VACUUM CLEANERS AND ACCESSORIES THEREFOR, NAMELY, TELESCOPIC WAND, POWER NOZZLE WITH LIGHT, CREVICE TOOL, BRUSHES, SQUEEGEE, SPRAYER, PLASTIC BAG, NON ELECTRIC HOSE WITH WAND, ELECTRONIC HOSE WITH HANDLE (U.S. CLS. 13, 19, 21, 23, 31, 34 AND 35).

FIRST USE 6-30-2006; IN COMMERCE 6-30-2006.

3,314,232. HY CITE CORPORATION, MADISON, WI. SN 78-792,232. PUB. 9-12-2006, FILED 1-16-2006.



HYDROTURBINE

FOR VACUUM CLEANERS (U.S. CLS. 13, 19, 21, 23, 31, 34 AND 35).

FIRST USE 6-30-2006; IN COMMERCE 6-30-2006.

3,314,237. HY CITE CORPORATION, MADISON, WI. SN 78-792,666. PUB. 10-31-2006, FILED 1-17-2006.

OCEANBLUE

THE MARK CONSISTS OF STANDARD CHARACTERS WITHOUT CLAIM TO ANY PARTICULAR FONT, STYLE, SIZE, OR COLOR.

FOR VACUUM CLEANERS AND ACCESSORIES THEREFOR, NAMELY, TELESCOPIC WAND, POWER NOZZLE WITH LIGHT, CREVICE TOOL, BRUSHES, SQUEEGEE, SPRAYER, PLASTIC BAG, NON ELECTRIC HOSE WITH WAND, ELECTRONIC HOSE WITH HANDLE (U.S. CLS. 13, 19, 21, 23, 31, 34 AND 35).

FIRST USE 6-30-2006; IN COMMERCE 6-30-2006.

CLASS 7—(Continued).

3,314,297. TELLKAMP SYSTEMS, INC., SANTA FE SPRINGS, CA. AND TREVISAN COMETAL, VERONA, ITALY. SN 78-804,795. PUB. 10-10-2006, FILED 2-1-2006.

TREVISAN TELLKAMP POWDER COATING SYSTEM

THE MARK CONSISTS OF STANDARD CHARACTERS WITHOUT CLAIM TO ANY PARTICULAR FONT, STYLE, SIZE, OR COLOR.

NO CLAIM IS MADE TO THE EXCLUSIVE RIGHT TO USE "POWDER COATING SYSTEM", APART FROM THE MARK AS SHOWN.

FOR VERTICAL POWDER COATING SYSTEM, CONSISTING PRIMARILY OF MACHINERY FOR CLEANING AND CHEMICAL TREATMENT OF METAL PARTS, CONVEYORS, BOOTH WITH POWDER COATING SPRAY GUNS, AND CONVECTION OVENS, SOLD TOGETHER AS A UNIT (U.S. CLS. 13, 19, 21, 23, 31, 34 AND 35).

FIRST USE 1-9-2007; IN COMMERCE 1-9-2007.

3,314,310. MAYTAG CORPORATION, NEWTON, IA. SN 78-807,624. PUB. 9-12-2006, FILED 2-6-2006.



OWNER OF U.S. REG. NOS. 802,649, 2,796,099, AND OTHERS.

THE MARK CONSISTS OF MAYTAG AND M DESIGN. FOR AUTOMATIC FLOOR SCRUBBERS; CARPET CLEANING MACHINES; FLOOR WASHING MACHINES; VACUUM CLEANERS (U.S. CLS. 13, 19, 21, 23, 31, 34 AND 35).

FIRST USE 6-30-2006; IN COMMERCE 6-30-2006.

3,314,327. MARGARITAVILLE ENTERPRISES, LLC, PALM BEACH, FL. SN 78-809,810. PUB. 10-3-2006, FILED 2-8-2006.



OWNER OF U.S. REG. NOS. 1,642,132, 3,079,807, AND OTHERS.

THE MARK CONSISTS OF THE WORDS MARGARITAVILLE ESCAPE TO PARADISE AND CARTOUCHE DESIGN.

FOR ELECTRIC FOOD AND DRINK BLENDERS (U.S. CLS. 13, 19, 21, 23, 31, 34 AND 35).

FIRST USE 6-14-2006; IN COMMERCE 6-14-2006.

CLASS 7—(Continued).

3,314,328. MARGARITAVILLE ENTERPRISES, LLC, PALM BEACH, FL. SN 78-809,819. PUB. 9-19-2006, FILED 2-8-2006.

THE BEST MARGARITAS COME FROM MARGARITAVILLE

THE MARK CONSISTS OF STANDARD CHARACTERS WITHOUT CLAIM TO ANY PARTICULAR FONT, STYLE, SIZE, OR COLOR.

OWNER OF U.S. REG. NOS. 1,642,132, 3,082,894, AND OTHERS.

FOR ELECTRIC FOOD AND DRINK BLENDERS (U.S. CLS. 13, 19, 21, 23, 31, 34 AND 35).

FIRST USE 6-14-2006; IN COMMERCE 6-14-2006.

3,314,362. COMPUTERS & MULTIMEDIA TECHNOLOGY, INC., PISCATAWAY, NJ. SN 78-816,777. PUB. 1-16-2007, FILED 2-16-2006.

Boston Tools

THE MARK CONSISTS OF STANDARD CHARACTERS WITHOUT CLAIM TO ANY PARTICULAR FONT, STYLE, SIZE, OR COLOR.

NO CLAIM IS MADE TO THE EXCLUSIVE RIGHT TO USE TOOLS, APART FROM THE MARK AS SHOWN.

FOR POWER TOOLS, NAMELY DRILL, GRINDER, CIRCULAR SAW, JIG SAW; AIR TOOLS, NAMELY IMPACT WRENCH, POLISHER, SANDER, RATCHET, DRILL; GENERATORS; AIR COMPRESSORS (U.S. CLS. 13, 19, 21, 23, 31, 34 AND 35).

FIRST USE 2-0-2006; IN COMMERCE 4-0-2006.

3,314,380. ARIENS COMPANY, BRILLION, WI. SN 78-818,766. PUB. 8-1-2006, FILED 2-20-2006.

X-TREME FLO 1550

THE MARK CONSISTS OF STANDARD CHARACTERS WITHOUT CLAIM TO ANY PARTICULAR FONT, STYLE, SIZE, OR COLOR.

FOR OUTDOOR POWER EQUIPMENT, NAMELY, BAGGERS FOR LAWN MOWERS (U.S. CLS. 13, 19, 21, 23, 31, 34 AND 35).

FIRST USE 2-21-2007; IN COMMERCE 2-21-2007.

CLASS 7—(Continued).

3,314,534. PANDA CO., LTD., APIA, SAMOA. SN 78-867,400. PUB. 11-21-2006, FILED 4-22-2006.

Penetall

THE MARK CONSISTS OF STANDARD CHARACTERS WITHOUT CLAIM TO ANY PARTICULAR FONT, STYLE, SIZE, OR COLOR.

FOR AIR COMPRESSOR, ELECTRIC COMPRESSOR, PNEUMATIC AND ELECTRIC TOOLS, NAMELY PNEUMATIC NAILERS, PNEUMATIC SCREWDRIVERS, PNEUMATIC SPANNERS, PNEUMATIC HAMMERS, PNEUMATIC DRILLS, ELECTRIC NAILERS, ELECTRIC SCREWDRIVERS, ELECTRIC SCREWDRIVER BITS (U.S. CLS. 13, 19, 21, 23, 31, 34 AND 35).

FIRST USE 10-1-2006; IN COMMERCE 10-1-2006.

CLASS 7—(Continued).

3,314,585. PRIDE ENGINEERING, INC., MINNEAPOLIS, MN. SN 78-883,580. PUB. 12-12-2006, FILED 5-15-2006.

PRIDE TOUCH

THE MARK CONSISTS OF STANDARD CHARACTERS WITHOUT CLAIM TO ANY PARTICULAR FONT, STYLE, SIZE, OR COLOR.

FOR GRINDING MACHINES, NAMELY, COMPUTER CONTROLLED GRINDING MACHINES HAVING POSITIONING SYSTEMS FOR THE GRINDING OF ARTICLES SUCH AS THE INSIDE DIAMETER OF ROUND PARTS AND FOR THE MANUFACTURE OF TOOLING USED IN THE PRODUCTION OF CANS (U.S. CLS. 13, 19, 21, 23, 31, 34 AND 35).

FIRST USE 12-11-2006; IN COMMERCE 12-11-2006.

3,314,560. WINNER GLOBAL DEFENSE LLC, SHARON, PA. SN 78-877,339. PUB. 8-29-2006, FILED 5-5-2006.

SAFEXIT

THE MARK CONSISTS OF STANDARD CHARACTERS WITHOUT CLAIM TO ANY PARTICULAR FONT, STYLE, SIZE, OR COLOR.

FOR LIFE-SAVING SAFETY MECHANISM, NAMELY A CONTROLLED DESCENT DEVICE COMPRISED OF SEVERAL DESCENT SLOWING MECHANISMS ALLOWING FOR THE REGULATED DESCENT AT A FIXED AND SAFE SPEED, A HARNESS ATTACHED AT EITHER END OF A STEEL FIBER CABLE, AND AN ASSORTMENT OF ACCESSORIES ATTACHED THERE-TO (U.S. CLS. 13, 19, 21, 23, 31, 34 AND 35).

FIRST USE 8-16-2006; IN COMMERCE 8-16-2006.

3,314,591. SPAN TECH LLC, GLASGOW, KY. SN 78-884,562. PUB. 12-26-2006, FILED 5-16-2006.

SANISPAN

THE MARK CONSISTS OF STANDARD CHARACTERS WITHOUT CLAIM TO ANY PARTICULAR FONT, STYLE, SIZE, OR COLOR.

FOR CONVEYORS (U.S. CLS. 13, 19, 21, 23, 31, 34 AND 35).

FIRST USE 8-0-2006; IN COMMERCE 8-0-2006.

3,314,568. THE HELMAN GROUP, LTD., OXNARD, CA. SN 78-879,277. PUB. 10-17-2006, FILED 5-8-2006.

MARGARATOR

THE MARK CONSISTS OF STANDARD CHARACTERS WITHOUT CLAIM TO ANY PARTICULAR FONT, STYLE, SIZE, OR COLOR.

FOR ELECTRIC BLENDER THAT GRINDS AND SHAVES ICE AND MIXES DRINKS (U.S. CLS. 13, 19, 21, 23, 31, 34 AND 35).

FIRST USE 8-31-2006; IN COMMERCE 8-31-2006.

3,314,619. KWIK PRODUCTS, INC., PHOENIX, AZ. SN 78-891,504. PUB. 11-21-2006, FILED 5-24-2006.

KWIK REWIND

THE MARK CONSISTS OF STANDARD CHARACTERS WITHOUT CLAIM TO ANY PARTICULAR FONT, STYLE, SIZE, OR COLOR.

FOR HEADS FOR WEED TRIMMERS; ADAPTOR KITS COMPOSED OF AN ADAPTOR, A SPACER, AND BOLTS, FOR MOUNTING HEADS TO WEED TRIMMERS (U.S. CLS. 13, 19, 21, 23, 31, 34 AND 35).

FIRST USE 4-15-2007; IN COMMERCE 4-15-2007.

CLASS 7—(Continued).

3,314,620. KWIK PRODUCTS, INC., PHOENIX, AZ. SN 78-891,526. PUB. 11-21-2006, FILED 5-24-2006.

RAPID REWIND

THE MARK CONSISTS OF STANDARD CHARACTERS WITHOUT CLAIM TO ANY PARTICULAR FONT, STYLE, SIZE, OR COLOR.

FOR HEADS FOR WEED TRIMMERS; ADAPTOR KITS COMPOSED OF AN ADAPTOR, A SPACER, AND BOLTS, FOR MOUNTING HEADS TO WEED TRIMMERS (U.S. CLS. 13, 19, 21, 23, 31, 34 AND 35).

FIRST USE 4-15-2007; IN COMMERCE 4-15-2007.

CLASS 7—(Continued).

3,314,768. EMERSON ELECTRIC CO., ST. LOUIS, MO. SN 78-934,246. PUB. 4-24-2007, FILED 7-20-2006.



THE MARK CONSISTS OF THE SILHOUETTE OF A ROUND VASE-TYPE FIGURE WITH A NARROW NECK AND A WIDE LIP AT THE NECK SURROUNDED BY A DARK LINE OUTLINING THE FIGURE.

FOR POWER TOOLS, NAMELY, POWER OPERATED PRESSING TOOLS FOR MAKING CONNECTIONS ON PIPES AND TUBING (U.S. CLS. 13, 19, 21, 23, 31, 34 AND 35).

FIRST USE 12-31-2006; IN COMMERCE 12-31-2006.

3,314,624. OXBO INTERNATIONAL CORPORATION, BYRON, NY. SN 78-893,167. PUB. 1-2-2007, FILED 5-25-2006.



OWNER OF U.S. REG. NOS. 2,400,838 AND 2,959,501. FOR AGRICULTURAL MACHINERY, NAMELY, HARVESTERS, SPRAYERS, DETASSELERS, SWATHERS, PESTICIDE SPREADERS, FERTILIZER SPREADERS AND HYDRAULIC DUMP BOXES FOR HARVESTING (U.S. CLS. 13, 19, 21, 23, 31, 34 AND 35). FIRST USE 3-23-2007; IN COMMERCE 3-23-2007.

3,314,779. NOVATEK INTERNATIONAL INC., PROVO, UT. SN 78-939,258. PUB. 3-20-2007, FILED 7-27-2006.

3,314,753. WAYNE & JENDY, LLC, DALLAS, TX. SN 78-928,591. PUB. 2-27-2007, FILED 7-13-2006.

NovaSteer**AIRWASHER**

THE MARK CONSISTS OF STANDARD CHARACTERS WITHOUT CLAIM TO ANY PARTICULAR FONT, STYLE, SIZE, OR COLOR.

FOR VACUUM CLEANERS FOR HOUSEHOLD PURPOSES (U.S. CLS. 13, 19, 21, 23, 31, 34 AND 35). FIRST USE 2-0-2007; IN COMMERCE 2-0-2007.

THE MARK CONSISTS OF STANDARD CHARACTERS WITHOUT CLAIM TO ANY PARTICULAR FONT, STYLE, SIZE, OR COLOR.

FOR AUTOMATED STEERABLE TOOL COMPRISING A MANIPULABLE POINT AT THE CENTER OF THE TOOL, NAMELY, DRILL BITS, MILLING CUTTERS, INDEXABLE CUTTING INSERTS AND PENETRATORS, FOR CREATING HOLES IN HARD SURFACES (U.S. CLS. 13, 19, 21, 23, 31, 34 AND 35).

FIRST USE 7-27-2006; IN COMMERCE 7-27-2006.

CLASS 7—(Continued).

3,314,809. KLIKLOK CORPORATION, DECATUR, GA. SN 78-948,446. PUB. 3-27-2007, FILED 8-9-2006.

CELOX

THE MARK CONSISTS OF STANDARD CHARACTERS WITHOUT CLAIM TO ANY PARTICULAR FONT, STYLE, SIZE, OR COLOR.

FOR PACKAGING MACHINES, NAMELY, ENDLOADERS; MACHINES FOR SETTING UP BLANKS OF FLEXIBLE SHEET MATERIAL INTO RECEPTACLES; MACHINES FOR INSERTING MERCHANDISE INTO SUCH RECEPTACLES; MACHINES FOR CONVEYING RECEPTACLES; MACHINES FOR CONVEYING MERCHANDISE ABOUT TO BE PACKAGED; MACHINES FOR CONVEYING MERCHANDISE ABOUT TO BE PACKAGED IN RECEPTACLES; MACHINES FOR FORMING AND TRANSFERRING SHEET MATERIAL INTO SIMULTANEOUSLY FORMED RECEPTACLES; MACHINES FOR FORMING AND TRANSFERRING SHEET MATERIAL INTO PREVIOUSLY FORMED RECEPTACLES; AND MACHINES FOR ENCLOSING MERCHANDISE IN A RECEPTABLE FORMED FROM A BLANK OF FLEXIBLE SHEET MATERIAL FOLDED ABOUT THE MERCHANDISE (U.S. CLS. 13, 19, 21, 23, 31, 34 AND 35).

FIRST USE 1-23-2007; IN COMMERCE 1-23-2007.

3,314,844. GRAVES SPRAY SUPPLY, INC., CLEARWATER, FL. SN 78-957,707. PUB. 5-22-2007, FILED 8-22-2006.



THE COLOR(S) YELLOW, WHITE AND BLUE. IS/ARE CLAIMED AS A FEATURE OF THE MARK.

THE MARK CONSISTS OF YELLOW LETTERS FOR "PATRIOT" WITH "PRECISION & PERFORMANCE" IN WHITE UNDERNEATH THE LAST SIX LETTERS OF "PATRIOT" AND SMALLER THAN THE LETTERS OF "PATRIOT." THE BACKGROUND IS BLUE. TWO SOLID YELLOW LINES ARE OVER AND UNDER THE LAST SIX LETTERS OF "PATRIOT."

FOR PUMPING SYSTEM FOR APPLYING FIBER-GLASS RESINS BY COMPOSITE EQUIPMENT, COMPRISED OF PNEUMATIC CATALYST PUMP, FLUID PUMP, SLIDE DRIVE, FILTER SURGE CHAMBER ASSEMBLY, AND AIR MOTOR (U.S. CLS. 13, 19, 21, 23, 31, 34 AND 35).

FIRST USE 10-5-2006; IN COMMERCE 10-5-2006.

CLASS 7—(Continued).

3,314,876. POLARIS INDUSTRIES INC., MEDINA, MN. SN 78-966,984. PUB. 3-6-2007, FILED 9-5-2006.

VERSAWINCH

THE MARK CONSISTS OF STANDARD CHARACTERS WITHOUT CLAIM TO ANY PARTICULAR FONT, STYLE, SIZE, OR COLOR.

FOR POWER WINCHES (U.S. CLS. 13, 19, 21, 23, 31, 34 AND 35).

FIRST USE 11-0-2006; IN COMMERCE 11-0-2006.

3,314,902. ILLINOIS TOOL WORKS INC., GLENVIEW, IL. SN 78-978,838. PUB. 9-20-2005, FILED 6-4-2004.

DEVILBISS

THE MARK CONSISTS OF STANDARD CHARACTERS WITHOUT CLAIM TO ANY PARTICULAR FONT, STYLE, SIZE, OR COLOR.

OWNER OF U.S. REG. NOS. 166,404 AND 771,830.

SEC. 2(F).

FOR AIR COMPRESSORS (U.S. CLS. 13, 19, 21, 23, 31, 34 AND 35).

FIRST USE 3-16-2007; IN COMMERCE 3-16-2007.

CLASS 8—HAND TOOLS

CLASS 8—(Continued).

3,313,045. WAHL CLIPPER CORPORATION, STERLING, IL.
SN 76-566,391. PUB. 10-24-2006, FILED 12-22-2003.

OMEGA

THE MARK CONSISTS OF STANDARD CHARACTERS WITHOUT CLAIM TO ANY PARTICULAR FONT, STYLE, SIZE, OR COLOR.

FOR ELECTRIC HAIR TRIMMERS (U.S. CLS. 23, 28 AND 44).

FIRST USE 6-0-2004; IN COMMERCE 6-0-2004.

3,313,312. BENCHMARK KNIFE CO., INC., OREGON CITY, OR. SN 77-032,524. PUB. 3-6-2007, FILED 10-30-2006.

ALLY

THE MARK CONSISTS OF STANDARD CHARACTERS WITHOUT CLAIM TO ANY PARTICULAR FONT, STYLE, SIZE, OR COLOR.

FOR KNIVES, NAMELY, POCKET KNIVES, FOLDING KNIVES, SPORT KNIVES, RESCUE KNIVES, UTILITY KNIVES, TACTICAL KNIVES, FISHING KNIVES, HUNTING KNIVES, CAMPING KNIVES, AND SURVIVAL KNIVES (U.S. CLS. 23, 28 AND 44).

FIRST USE 3-20-2007; IN COMMERCE 3-20-2007.

3,313,548. PROVO CRAFT AND NOVELTY, INC., SPANISH FORK, UT. SN 78-543,175. PUB. 5-2-2006, FILED 1-6-2005.

DOODLE TAG

THE MARK CONSISTS OF STANDARD CHARACTERS WITHOUT CLAIM TO ANY PARTICULAR FONT, STYLE, SIZE, OR COLOR.

NO CLAIM IS MADE TO THE EXCLUSIVE RIGHT TO USE "TAG", APART FROM THE MARK AS SHOWN.

FOR HAND OPERATED DIE CUTTERS, NAMELY, STEEL RULE DIES (U.S. CLS. 23, 28 AND 44).

FIRST USE 6-10-2005; IN COMMERCE 6-10-2005.

CLASS 8—(Continued).

3,313,549. PROVO CRAFT AND NOVELTY, INC., SPANISH FORK, UT. SN 78-543,182. PUB. 5-2-2006, FILED 1-6-2005.

DOODLE DOTS

THE MARK CONSISTS OF STANDARD CHARACTERS WITHOUT CLAIM TO ANY PARTICULAR FONT, STYLE, SIZE, OR COLOR.

NO CLAIM IS MADE TO THE EXCLUSIVE RIGHT TO USE "DOTS", APART FROM THE MARK AS SHOWN.

FOR HAND OPERATED DIE CUTTERS, NAMELY, STEEL RULE DIES (U.S. CLS. 23, 28 AND 44).

FIRST USE 9-30-2005; IN COMMERCE 10-4-2005.

3,313,625. KYOCERA TYCOM CORPORATION, IRVINE, CA. SN 78-604,601. PUB. 12-26-2006, FILED 4-8-2005.

THE PERFECT PEELER

THE MARK CONSISTS OF STANDARD CHARACTERS WITHOUT CLAIM TO ANY PARTICULAR FONT, STYLE, SIZE, OR COLOR.

NO CLAIM IS MADE TO THE EXCLUSIVE RIGHT TO USE "PEELER", APART FROM THE MARK AS SHOWN.

FOR NON-ELECTRIC FRUIT AND VEGETABLE PEELER (U.S. CLS. 23, 28 AND 44).

FIRST USE 4-7-2005; IN COMMERCE 4-7-2005.

3,314,055. JACCARD CORPORATION, ORCHARD PARK, NY. SN 78-762,636. PUB. 8-8-2006, FILED 11-29-2005.

SAFE HANDS

THE MARK CONSISTS OF STANDARD CHARACTERS WITHOUT CLAIM TO ANY PARTICULAR FONT, STYLE, SIZE, OR COLOR.

FOR FOOD PROCESSING EQUIPMENT, NAMELY, HAND-OPERATED MANDOLIN TYPE FOOD SLICERS (U.S. CLS. 23, 28 AND 44).

FIRST USE 1-21-2005; IN COMMERCE 1-21-2005.

CLASS 8—(Continued).

3,314,056. JACCARD CORPORATION, ORCHARD PARK, NY. SN 78-762,670. PUB. 8-8-2006, FILED 11-29-2005.

SIMPLY BETTER

THE MARK CONSISTS OF STANDARD CHARACTERS WITHOUT CLAIM TO ANY PARTICULAR FONT, STYLE, SIZE, OR COLOR.

FOR FOOD HANDLING EQUIPMENT; NAMELY, HAND OPERATED MEAT TENDERIZERS, HAND OPERATED CUTTERS FOR FOOD, HAND OPERATED CHOPPERS FOR FOOD, HAND OPERATED SHREDDERS FOR FOOD, HAND OPERATED MANDOLIN TYPE SLICERS FOR FOOD AND COMMERCIAL MEAT TENDERIZERS (U.S. CLS. 23, 28 AND 44).

FIRST USE 4-9-2004; IN COMMERCE 4-9-2004.

CLASS 8—(Continued).

3,314,316. ZAKARIAN, ARTIN, LAS VEGAS, CA. SN 78-808,944. PUB. 9-26-2006, FILED 2-7-2006.

Z-Tech

THE MARK CONSISTS OF STANDARD CHARACTERS WITHOUT CLAIM TO ANY PARTICULAR FONT, STYLE, SIZE, OR COLOR.

FOR MANUALLY OPERATED HAND TOOLS NAMELY, HAMMERS, SCREWDRIVERS, PLIERS, WRENCHES, SOCKET SETS AND UTILITY KNIVES (U.S. CLS. 23, 28 AND 44).

FIRST USE 3-10-2006; IN COMMERCE 3-10-2006.

3,314,408. LIFETIME BRANDS, INC., GARDEN CITY, NY. SN 78-823,055. PUB. 10-17-2006, FILED 2-24-2006.

3,314,293. DIAMOND ROSE SHEARS, LLC, CASTLE ROCK, CO. SN 78-803,383. PUB. 11-14-2006, FILED 1-31-2006.

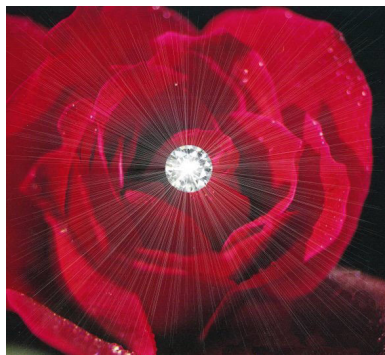

THE COLOR(S) RED, WHITE, SILVER, GREY AND BLACK IS/ARE CLAIMED AS A FEATURE OF THE MARK.

THE COLOR RED IS LOCATED IN THE DEPICTION OF THE ROSE; THE COLORS WHITE-GREY AND SILVER ARE LOCATED IN THE DIAMOND AND THE RAYS FROM THE DIAMOND; THE COLOR BLACK IS LOCATED IN THE SQUARE BACKGROUND BORDER.

THE MARK CONSISTS OF A ROSE WITH A DIAMOND IN THE MIDDLE

FOR HAIR CUTTING SCISSORS; SCISSOR BLADES; SCISSORS (U.S. CLS. 23, 28 AND 44).

FIRST USE 1-31-2006; IN COMMERCE 1-31-2006.

SHEARTOKU

THE MARK CONSISTS OF STANDARD CHARACTERS WITHOUT CLAIM TO ANY PARTICULAR FONT, STYLE, SIZE, OR COLOR.

FOR SCISSORS, HAND OPERATED SHEARS, CUTLERY, KNIVES (U.S. CLS. 23, 28 AND 44).

FIRST USE 2-13-2007; IN COMMERCE 2-13-2007.

3,314,497. PANASONIC CORPORATION OF NORTH AMERICA, SECAUCUS, NJ. SN 78-852,639. PUB. 9-26-2006, FILED 4-3-2006.

EPIGLIDE

THE MARK CONSISTS OF STANDARD CHARACTERS WITHOUT CLAIM TO ANY PARTICULAR FONT, STYLE, SIZE, OR COLOR.

FOR ELECTRONIC EPILATOR (U.S. CLS. 23, 28 AND 44).

FIRST USE 8-1-2006; IN COMMERCE 8-1-2006.

CLASS 8—(Continued).

3,314,531. BIOFOREST TECHNOLOGIES (USA), INC., SAULT SAINTE MARIE, MI. SN 78-864,863. PUB. 1-16-2007, FILED 4-19-2006.

ECOJECT

THE MARK CONSISTS OF STANDARD CHARACTERS WITHOUT CLAIM TO ANY PARTICULAR FONT, STYLE, SIZE, OR COLOR.

FOR HAND TOOLS, NAMELY, INJECTORS FOR INJECTING PESTICIDES, NUTRIENTS, AND GROWTH REGULATORS INTO TREES AND WOODY PLANTS (U.S. CLS. 23, 28 AND 44).

FIRST USE 7-0-2007; IN COMMERCE 7-0-2007.

CLASS 8—(Continued).

3,314,903. AMES TRUE TEMPER PROPERTIES, INC., WILMINGTON, DE. SN 78-978,840. PUB. 9-12-2006, FILED 2-20-2006.

T-250 SERIES

THE MARK CONSISTS OF STANDARD CHARACTERS WITHOUT CLAIM TO ANY PARTICULAR FONT, STYLE, SIZE, OR COLOR.

NO CLAIM IS MADE TO THE EXCLUSIVE RIGHT TO USE "SERIES", APART FROM THE MARK AS SHOWN.

FOR MANUALLY OPERATED HAND TOOLS, NAMELY, SHOVELS; RAKES; HOES; SPADES; CULTIVATORS; WEEDING FORKS; LAWN EDGERS; POST HOLE DIGGERS (U.S. CLS. 23, 28 AND 44).

FIRST USE 10-0-2006; IN COMMERCE 10-0-2006.

3,314,540. THE COUNCIL TOOL CO., INC., LAKE WACCA-MAW, NC. SN 78-869,017. PUB. 12-5-2006, FILED 4-25-2006.

FORM-A-NATOR

THE MARK CONSISTS OF STANDARD CHARACTERS WITHOUT CLAIM TO ANY PARTICULAR FONT, STYLE, SIZE, OR COLOR.

FOR HAND TOOLS, NAMELY, A COMBINATION SLEDGE HAMMER AND MATTOCK (U.S. CLS. 23, 28 AND 44).

FIRST USE 6-15-2006; IN COMMERCE 6-15-2006.

3,314,905. AMES TRUE TEMPER PROPERTIES, INC., WILMINGTON, DE. SN 78-978,861. PUB. 9-12-2006, FILED 2-8-2006.

J-450 SERIES

THE MARK CONSISTS OF STANDARD CHARACTERS WITHOUT CLAIM TO ANY PARTICULAR FONT, STYLE, SIZE, OR COLOR.

NO CLAIM IS MADE TO THE EXCLUSIVE RIGHT TO USE "SERIES", APART FROM THE MARK AS SHOWN.

FOR MANUALLY OPERATED HAND TOOLS, NAMELY, SHOVELS; RAKES; HOES; SPADES; WEEDING FORKS (U.S. CLS. 23, 28 AND 44).

FIRST USE 2-0-2007; IN COMMERCE 2-0-2007.

3,314,647. DIXIE CONSUMER PRODUCTS LLC, ATLANTA, GA. SN 78-898,433. PUB. 11-21-2006, FILED 6-1-2006.

SMARTSTOCK

THE MARK CONSISTS OF STANDARD CHARACTERS WITHOUT CLAIM TO ANY PARTICULAR FONT, STYLE, SIZE, OR COLOR.

FOR CUTLERY, NAMELY, FORKS, SPOONS AND KNIVES (U.S. CLS. 23, 28 AND 44).

FIRST USE 3-17-2007; IN COMMERCE 3-17-2007.

CLASS 9—ELECTRICAL AND SCIENTIFIC APPARATUS

3,312,984. UI HOLDING CO., CONKLIN, NY. SN 76-071,407. PUB. 3-6-2007, FILED 6-15-2000.

DIMENSIONS

FOR COMPUTER PROGRAMS FOR USE IN CONNECTION WITH ELECTRONIC COMPONENT ASSEMBLY PRODUCTION LINES, NAMELY, PROCESS LINE MONITORING AND PROGRAMMING SOFTWARE AND PROCESS LINE OPTIMIZATION SOFTWARE (U.S. CLS. 21, 23, 26, 36 AND 38).

FIRST USE 12-12-2000; IN COMMERCE 12-12-2000.

CLASS 9—(Continued).

3,313,012. LANMARK CONTROLS, INC., BOXBOROUGH, MA. SN 76-459,089. PUB. 2-10-2004, FILED 10-4-2002.

LANMARK

FOR COMPUTER HARDWARE AND SOFTWARE FOR CONTROLLING LASER MACHINING AND MARKING DEVICES (U.S. CLS. 21, 23, 26, 36 AND 38).
FIRST USE 7-6-2006; IN COMMERCE 7-6-2006.

3,313,040. HONDA GIKEN KOGYO KABUSHIKI KAISHA, TA HONDA MOTOR CO., LTD., TOKYO 107-8556, JAPAN. SN 76-556,955. PUB. 3-8-2005, FILED 11-5-2003.

HONDA FC STACK

THE MARK CONSISTS OF STANDARD CHARACTERS WITHOUT CLAIM TO ANY PARTICULAR FONT, STYLE, SIZE, OR COLOR.

OWNER OF U.S. REG. NOS. 826,779, 1,002,188, AND OTHERS.

NO CLAIM IS MADE TO THE EXCLUSIVE RIGHT TO USE "FC STACK", APART FROM THE MARK AS SHOWN.

FOR FUEL CELLS AND ITS STRUCTURAL PARTS (U.S. CLS. 21, 23, 26, 36 AND 38).

FIRST USE 9-0-2004; IN COMMERCE 9-0-2004.

3,313,047. LEONI KABEL HOLDING GMBH & CO. KG, NURNBERG, FED REP GERMANY. SN 76-570,556. PUB. 2-21-2006, FILED 1-16-2004.

LEONI FLEXLINE

THE MARK CONSISTS OF STANDARD CHARACTERS WITHOUT CLAIM TO ANY PARTICULAR FONT, STYLE, SIZE, OR COLOR.

OWNER OF U.S. REG. NO. 2,796,633.

FOR ELECTRIC CABLES AND ELECTRIC CABLE JUMP LEADS, TELECOMMUNICATION CABLES AND ELECTRICAL CONNECTORS THEREFORE; COAXIAL CABLES AND ELECTRICAL CONNECTORS THEREFORE; JUMPER CABLES AND ELECTRICAL CONNECTORS THEREFORE (U.S. CLS. 21, 23, 26, 36 AND 38).

FIRST USE 10-0-1998; IN COMMERCE 3-0-2004.

CLASS 9—(Continued).

3,313,055. MICHELIN NORTH AMERICA, INC., GREENVILLE, SC. SN 76-589,443. PUB. 10-4-2005, FILED 4-29-2004.

MICHELIN

THE MARK CONSISTS OF STANDARD CHARACTERS WITHOUT CLAIM TO ANY PARTICULAR FONT, STYLE, SIZE, OR COLOR.

FOR COMPUTERS, NAMELY, PERSONAL DIGITAL ASSISTANTS; SOFTWARE, NAMELY, DATABASES AND SOFTWARE RELATING TO MAPS AND ADDRESSES (U.S. CLS. 21, 23, 26, 36 AND 38).

FIRST USE 1-26-2007; IN COMMERCE 1-26-2007.

3,313,058. TALARIS CORPORATION, SAN MATEO, CA. SN 76-593,312. PUB. 4-5-2005, FILED 5-20-2004.

SAVINGS NOT SOFTWARE

THE MARK CONSISTS OF STANDARD CHARACTERS WITHOUT CLAIM TO ANY PARTICULAR FONT, STYLE, SIZE, OR COLOR.

FOR COMPUTER SOFTWARE FOR ACCESSING INFORMATION FROM ONE OR MORE DATABASES FOR THE PURPOSE OF ENABLING CONSUMERS TO MAKE ONLINE PURCHASES OF GOODS AND SERVICES OF OTHERS (U.S. CLS. 21, 23, 26, 36 AND 38).

FIRST USE 1-1-2006; IN COMMERCE 1-1-2006.

3,313,065. GRYGOROVYCH, SERGIY, KYIV 04211, UKRAINE. SN 76-605,649. PUB. 10-4-2005, FILED 8-4-2004.

S.T.A.L.K.E.R. : SHADOW OF CHERNOBYL

THE MARK CONSISTS OF STANDARD CHARACTERS WITHOUT CLAIM TO ANY PARTICULAR FONT, STYLE, SIZE, OR COLOR.

NO CLAIM IS MADE TO THE EXCLUSIVE RIGHT TO USE "CHERNOBYL", APART FROM THE MARK AS SHOWN.

FOR SOFTWARE FOR ELECTRONIC GAMES; SOFTWARE GAMES FOR MOBILE AND CELLULAR TELEPHONES, HANDHELD COMPUTERS, PERSONAL COMPUTERS, PERSONAL DIGITAL ASSISTANTS; SOFTWARE FOR ELECTRONIC GAMES THAT IS DOWNLOADABLE FROM A REMOTE COMPUTER SITE; COMPUTER GAME SOFTWARE; COMPUTER GAME ACCESSORIES, NAMELY, COMPUTER GAMES CONTROLLERS, JOY STICKS, HEADSETS, POWER ADAPTERS, MEMORY CARDS AND MOUSE MATS; COMPUTER GAMES HARDWARE; GAME CONSOLES, NAMELY, HARDWARE DEVICES CONNECTED TO TELEVISION SETS OR COMPUTER MONITORS FOR THE PURPOSE OF PLAYING ELECTRONIC GAMES; COMPUTER SOFTWARE FOR ELECTRONIC GAMES; COMPUTER HARDWARE; PRE-RECORDED MAGNETIC DATA CARRIERS FEATURING ELECTRONIC GAMES; PRE-RECORDED OPTICAL DATA CARRIERS FEATURING ELECTRONIC GAMES; ELECTRICAL APPARATUS AND INSTRUMENTS, NAMELY, WIRES,

CLASS 9—(Continued).

CABLES AND CIRCUITS; BATTERIES; ELECTRONIC GAMES SOFTWARE; DOWNLOADABLE ELECTRONIC PUBLICATIONS IN THE NATURE OF ONLINE PUBLICATIONS, NAMELY, MAGAZINES, NEWSLETTERS, ARTICLES, PAMPHLETS AND MANUALS IN THE FIELD OF ELECTRONIC GAMES; PLUG-IN COMPUTER GAME CARDS; INPUT DEVICES FOR COMPUTER GAMES EQUIPMENT, NAMELY, SCANNERS, KEYBOARDS, DIGITAL CAMERAS AND MICE; BLANK RECORDING DISCS; PRE-RECORDED SOFTWARE FOR USE WITH INTERACTIVE ELECTRONIC APPARATUS FOR ELECTRONIC GAMES; DIGITAL COMPUTER GAME SOFTWARE DOWNLOADABLE FROM THE INTERNET; VIRTUAL REALITY APPARATUS, NAMELY, HEAD-MOUNTED VIEWERS, MOTION TRACKERS, DATA GLOVES, 3D CONTROLLERS AND VIRTUAL REALITY SIMULATORS; CLEANING APPARATUS AND INSTRUMENTS FOR COMPUTER AND/OR GAME CONSOLE HARDWARE, NAMELY, MAGNETIC HEAD AND TAPE CLEANERS; AND PARTS FOR ALL OF THE AFORESAID (U.S. CLS. 21, 23, 26, 36 AND 38).

FIRST USE 3-20-2007; IN COMMERCE 3-20-2007.

3,313,073. BIOSONIX, LLC, GRAYTON BEACH, FL. SN 76-610,240. PUB. 8-8-2006, FILED 9-7-2004.

BIOSONIX SYSTEMS

THE MARK CONSISTS OF STANDARD CHARACTERS WITHOUT CLAIM TO ANY PARTICULAR FONT, STYLE, SIZE, OR COLOR.

NO CLAIM IS MADE TO THE EXCLUSIVE RIGHT TO USE "SYSTEMS", APART FROM THE MARK AS SHOWN.

FOR SPORTING GOODS, NAMELY, FISHING EQUIPMENT COMPRISING SPEAKERS AND SOFTWARE FOR PLAYING SOUNDS TO ATTRACT AND STIMULATE FISH (U.S. CLS. 21, 23, 26, 36 AND 38).

FIRST USE 3-1-2002; IN COMMERCE 7-1-2003.

3,313,075. MACK SOFTWARE SOLUTIONS, INC., FRISCO, TX. SN 76-611,537. PUB. 9-6-2005, FILED 9-10-2004.



NO CLAIM IS MADE TO THE EXCLUSIVE RIGHT TO USE "BIZ", APART FROM THE MARK AS SHOWN.

FOR SOFTWARE TO ASSIST IN THE INVOICING OF CLIENTS; NAMELY, SOFTWARE THAT COMBINES CONTACT MANAGEMENT, SUPPORT CALL LOGGING, INVENTORY TRACKING, PURCHASE ORDER, PACKING SLIPS, INVOICES AND MORE WITH THE OPTION TO CUSTOMIZE AS NECESSARY (U.S. CLS. 21, 23, 26, 36 AND 38).

FIRST USE 5-1-2007; IN COMMERCE 5-1-2007.

CLASS 9—(Continued).

3,313,092. AMERICAN MODULAR TOOLING, L.L.C., WARREN, MI. SN 76-623,745. PUB. 3-14-2006, FILED 12-8-2004.

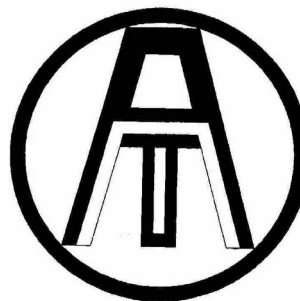

FOR COORDINATE MEASURING MACHINES AND FIXTURING AND MEASURING TOOL PARTS THEREOF; MEASURING DEVICES FOR CALIBRATING AND DIMENSIONAL CERTIFICATION OF EQUIPMENT (U.S. CLS. 21, 23, 26, 36 AND 38).

FIRST USE 11-1-2004; IN COMMERCE 11-1-2004.

3,313,095. GEARBOX SOFTWARE LLC, PLANO, TX. SN 76-624,803. PUB. 3-6-2007, FILED 12-15-2004.

BROTHERS IN ARMS ROAD TO HILL 30

THE MARK CONSISTS OF STANDARD CHARACTERS WITHOUT CLAIM TO ANY PARTICULAR FONT, STYLE, SIZE, OR COLOR.

FOR SOFTWARE AND ELECTRONIC GAMES, NAMELY, SOFTWARE GAMES RECORDED ON CD-ROM AND DIGITAL VIDEO DISCS FOR COMPUTERS; SOFTWARE GAMES RECORDED ON CD-ROMS, DIGITAL VIDEO DISCS, AND CARTRIDGES FOR CONSOLE AND INDIVIDUAL, PORTABLE GAMING SYSTEMS; SOFTWARE GAMES THAT ARE DOWNLOADABLE FROM A REMOTE COMPUTER SITE; AND SOFTWARE GAMES FOR MOBILE PHONES, PERSONAL DIGITAL ASSISTANTS, AND HANDHELD COMPUTERS (U.S. CLS. 21, 23, 26, 36 AND 38).

FIRST USE 3-1-2005; IN COMMERCE 3-1-2005.

CLASS 9—(Continued).

3,313,103. ARGELA TECHNOLOGIES, MASLAK, ISTANBUL, 34398, TURKEY. SN 76-631,509. PUB. 8-8-2006, FILED 2-17-2005.

ARGELA

THE MARK CONSISTS OF STANDARD CHARACTERS WITHOUT CLAIM TO ANY PARTICULAR FONT, STYLE, SIZE, OR COLOR.

FOR COMPUTER SOFTWARE USED WITH AUDIO, TEXT AND MULTIMEDIA COMMUNICATION SYSTEMS TO DELIVER AND RECEIVE AUDIO, TEXT AND MULTIMEDIA MESSAGES; COMPUTER TELEPHONY SOFTWARE AND COMPUTER APPLICATION SOFTWARE FOR MOBILE TELEPHONES AND FOR USE WITH INTELLIGENT TELEPHONES; COMPUTER SOFTWARE PLATFORMS FOR USE BY MOBILE WIRELESS AND WIRE LINE OPERATORS; COMPUTER SOFTWARE USED TO DELIVER VOICE OVER THE INTERNET PROTOCOL SYSTEMS; COMPUTER SOFTWARE DESIGNED FOR CONTENT PROVIDERS AND MOBILE VIRTUAL NETWORK OPERATORS, NAMELY SERVICE CREATION SOFTWARE APPLICATIONS AND VISUAL SERVICE CREATION SOFTWARE TOOLS USED TO ALLOW OPERATORS TO ACCESS NETWORK FUNCTIONS; COMPUTER HARDWARE, NAMELY, MEDIA GATEWAY CONTROLLERS AND MEDIA GATEWAY ROUTERS; COMPUTER CONTROL HARDWARE AND SOFTWARE USED TO OPERATE COMPUTER SYSTEMS (U.S. CLS. 21, 23, 26, 36 AND 38).

FIRST USE 5-15-2007; IN COMMERCE 5-15-2007.

3,313,112. GRIFFIN TECHNOLOGY, INC., NASHVILLE, TN. SN 76-634,172. PUB. 7-18-2006, FILED 3-23-2005.

ROADTRIP

THE MARK CONSISTS OF STANDARD CHARACTERS WITHOUT CLAIM TO ANY PARTICULAR FONT, STYLE, SIZE, OR COLOR.

FOR HOLDERS AND MOUNTS FOR PORTABLE AUDIO DEVICES IN THE NATURE OF CD PLAYERS, MP3 PLAYERS, AND AUDIOCASSETTE PLAYERS (U.S. CLS. 21, 23, 26, 36 AND 38).

FIRST USE 8-31-2004; IN COMMERCE 8-31-2004.

CLASS 9—(Continued).

3,313,124. HOLOGRAFX, INC., EMERSON, NJ. SN 76-636,558. PUB. 8-15-2006, FILED 4-20-2005.



THE COLOR(S) RED, ORANGE AND BLACK IS/ARE CLAIMED AS A FEATURE OF THE MARK.

THE COLOR RED APPEARS IN THE LETTERS FX. THE COLOR ORANGE APPEARS IN THE ELLIPTICAL ORBIT DESIGN. THE COLOR BLACK APPEARS IN THE TERM HOLOGRA AND THE ELLIPTICAL ORBIT DESIGN.

FOR ELECTRIC LUMINESCENT DISPLAY PANELS FOR DISPLAYING THREE DIMENSIONAL IMAGES (U.S. CLS. 21, 23, 26, 36 AND 38).

FIRST USE 6-7-2005; IN COMMERCE 6-7-2005.

3,313,126. ONSCREEN TECHNOLOGIES, INC., SAFETY HARBOR, FL. SN 76-636,682. PUB. 5-22-2007, FILED 4-21-2005.



THE COLOR(S) WHITE, DARK BLUE, LIGHT BLUE AND DEEP RED IS/ARE CLAIMED AS A FEATURE OF THE MARK.

THE ENTIRE MARK IS ON A WHITE BACKGROUND. THE LINES OF THE HEAVIER LINED "WINDOW" ARE COLORED DARK BLUE. THE LINES OF THE LIGHTER LINED "WINDOW" (THE SHADOW) ARE COLORED LIGHT BLUE. THE LETTERS OF THE WORDS "LIVING WINDOW" ARE DEEP RED. THE POINTED WAVE IMAGE IS DEEP RED IN THE CENTER AND GRADUALLY LIGHTENS FROM THE CENTER TOWARD THE LEFT AND RIGHT TO NEARLY NO COLOR. THE SHADOW OF THE POINTED WAVE IMAGE IS A LIGHT SHADE OF THE DEEP RED OF THE FULL POINTED IMAGE.

FOR PERMANENTLY MOUNTED OR WINDOW OVERLAID LED (LIGHT EMITTING DIODE) ELECTRONICALLY CONTROLLED, POWERED AND LIGHTED SIGN FOR VISUAL TRANSMISSION OF IMAGES AND WORDS FOR COMMERCIAL ADVERTISING (U.S. CLS. 21, 23, 26, 36 AND 38).

FIRST USE 10-22-2005; IN COMMERCE 10-22-2005.

CLASS 9—(Continued).

3,313,134. WOVEN ELECTRONICS CORPORATION, GREENVILLE, SC. SN 76-639,680. PUB. 9-5-2006, FILED 5-27-2005.

SMARTCABLE

THE MARK CONSISTS OF STANDARD CHARACTERS WITHOUT CLAIM TO ANY PARTICULAR FONT, STYLE, SIZE, OR COLOR.

FOR FIBER OPTIC CABLES EMBEDDED IN BRAIDED WIRE STRANDS, ALL OF WHICH FORMS A SECURITY BARRIER (U.S. CLS. 21, 23, 26, 36 AND 38).

FIRST USE 5-19-2005; IN COMMERCE 5-19-2005.

3,313,150. TOP EIGHT INDUSTRIAL CORP., TAIPEI 114, TAIWAN. SN 76-643,251. PUB. 10-24-2006, FILED 7-19-2005.



FOR ACCESSORIES FOR CAMERAS, NAMELY, CARRYING BELTS FOR CAMERAS, CAMERA ACCESSORY CASES, CAMERA ACCESSORY SLEEVES, TRIPODS, CAMERA FLASHES, CAMERA MASKS, CAMERAS, UNDERWATER VIDEO CAMERAS, DIGITAL CAMERAS, ELECTRONIC VIDEO CAMERAS, TELEVISION VIDEO CAMERAS WITH ELECTRONIC BURGLAR-PROOF MONITORS, CAMERA ACCESSORIES, NAMELY, CAMERA FILTERS, CAMERA CLOSURES, DIGITAL VIDEO CAMERAS, VIDEO TAPE RECORDERS, DIGITAL VIDEO RECORDERS, PORTABLE DVD AND MP3 PLAYERS (U.S. CLS. 21, 23, 26, 36 AND 38).

FIRST USE 11-16-2003; IN COMMERCE 1-0-2006.

CLASS 9—(Continued).

3,313,160. MAGAL SECURITY SYSTEMS LTD., YEHUD 56100, ISRAEL. SN 76-645,292. PUB. 9-12-2006, FILED 8-19-2005.

FORTIS 

THE ENGLISH TRANSLATION OF THE LATIN WORD "FORTIS" IN THE MARK IS "STRONG".

FOR INTEGRATED ELECTRONIC COMMAND AND CONTROL SYSTEM FOR INTRUSION DETECTION CONSISTING OF COMPUTERS, COMPUTER SOFTWARE, DISPLAY MONITORS AND A WIRELESS LOCAL AREA NETWORK FOR COLLECTING, ANALYZING, INTEGRATING AND COMMUNICATING SECURITY INFORMATION BETWEEN A CONTROL CENTER AND SECURITY PERSONNEL IN THE FIELD (U.S. CLS. 21, 23, 26, 36 AND 38).

FIRST USE 3-31-2003; IN COMMERCE 8-31-2003.

3,313,161. MAGAL SECURITY SYSTEMS LTD., YEHUD 56100, ISRAEL. SN 76-645,295. PUB. 8-29-2006, FILED 8-19-2005.

DreamBox 

FOR ELECTRONIC CONTROL AND MONITORING SYSTEM FOR INTRUSION DETECTION, NAMELY A CLOSED CIRCUIT TV SECURITY SYSTEM CONSISTING OF DIGITAL VIDEO AND AUDIO RECORDERS, VIDEO AND AUDIO MATRIX SWITCHERS, OUTDOOR AND INDOOR VIDEO MOTION DETECTORS, COMPUTER PROCESSORS, COMMUNICATION NETWORK HARDWARE AND COMPUTER SOFTWARE, AND SECURITY MANAGEMENT SOFTWARE (U.S. CLS. 21, 23, 26, 36 AND 38).

FIRST USE 4-30-2002; IN COMMERCE 9-30-2002.

3,313,163. YAMAHA CORPORATION, SHIZUOKA 430, JAPAN. SN 76-645,371. PUB. 10-10-2006, FILED 8-22-2005.

INTELLIBEAM

THE MARK CONSISTS OF STANDARD CHARACTERS WITHOUT CLAIM TO ANY PARTICULAR FONT, STYLE, SIZE, OR COLOR.

FOR LOUDSPEAKERS, MINI AUDIO SYSTEMS COMPRISING AMPLIFIERS AND SPEAKERS, AUDIO AND VIDEO AMPLIFIERS, AUDIO AND VIDEO RECEIVERS (U.S. CLS. 21, 23, 26, 36 AND 38).

FIRST USE 12-30-2004; IN COMMERCE 12-30-2004.

CLASS 9—(Continued).

3,313,169. SPI LASERS UK LIMITED, SOUTHAMPTON, SO30 2QU, UNITED KINGDOM. SN 76-648,222. PUB. 3-6-2007, FILED 10-11-2005.

redENERGY

THE MARK CONSISTS OF STANDARD CHARACTERS WITHOUT CLAIM TO ANY PARTICULAR FONT, STYLE, SIZE, OR COLOR.

FOR LASERS NOT FOR MEDICAL USE; OPTICAL AMPLIFIERS; PULSED AND CONTINUOUS WAVE, AMPLIFIED SPONTANEOUS EMISSION SOURCES, BASED ON RARE-EARTH DOPED OPTICAL FIBERS, WHICH SOURCES HAVING EMISSION BANDWIDTHS IN THE RANGE OF APPROXIMATELY 1/100 NM TO APPROXIMATELY 100 NM; AND ALL OF THE AFORESAID GOODS FOR USE IN WELDING, DRILLING, CUTTING, SOLDERING, PROCESSING MATERIALS, TELECOMMUNICATIONS APPLICATIONS, AEROSPACE APPLICATIONS, AND DEFENSE (U.S. CLS. 21, 23, 26, 36 AND 38).
FIRST USE 1-25-2005; IN COMMERCE 5-25-2006.

3,313,174. BRAEBURN SYSTEMS LLC, MONTGOMERY, IL. SN 76-650,174. PUB. 10-10-2006, FILED 10-24-2005.

MEGASWITCH

THE MARK CONSISTS OF STANDARD CHARACTERS WITHOUT CLAIM TO ANY PARTICULAR FONT, STYLE, SIZE, OR COLOR.

FOR THERMOSTATS (U.S. CLS. 21, 23, 26, 36 AND 38).
FIRST USE 1-22-2006; IN COMMERCE 1-22-2006.

3,313,183. LAKELAND INDUSTRIES, INC., RONKONKOMA, NY. SN 76-652,465. PUB. 8-22-2006, FILED 12-23-2005.

NEOSOL

THE MARK CONSISTS OF STANDARD CHARACTERS WITHOUT CLAIM TO ANY PARTICULAR FONT, STYLE, SIZE, OR COLOR.

FOR PROTECTIVE GLOVES FOR INDUSTRIAL USE AND FOOD SERVICE (U.S. CLS. 21, 23, 26, 36 AND 38).
FIRST USE 12-21-2006; IN COMMERCE 12-21-2006.

CLASS 9—(Continued).

3,313,184. LAKELAND INDUSTRIES, INC., RONKONKOMA, NY. SN 76-652,467. PUB. 8-22-2006, FILED 12-27-2005.

NITROSOL

THE MARK CONSISTS OF STANDARD CHARACTERS WITHOUT CLAIM TO ANY PARTICULAR FONT, STYLE, SIZE, OR COLOR.

FOR PROTECTIVE GLOVES FOR INDUSTRIAL USE AND FOOD SERVICE (U.S. CLS. 21, 23, 26, 36 AND 38).
FIRST USE 12-21-2006; IN COMMERCE 12-21-2006.

3,313,208. EEMPACT SOFTWARE, INC., BLOOMINGTON, MN. SN 76-659,473. PUB. 12-12-2006, FILED 5-3-2006.

BOND STARESEARCHER

THE MARK CONSISTS OF STANDARD CHARACTERS WITHOUT CLAIM TO ANY PARTICULAR FONT, STYLE, SIZE, OR COLOR.

FOR COMPUTER SOFTWARE, NAMELY, AN APPLICANT TRACKING SYSTEM FOR EMPLOYMENT RECRUITMENT, HIRING, PLACEMENT AND SCREENING (U.S. CLS. 21, 23, 26, 36 AND 38).
FIRST USE 7-14-2006; IN COMMERCE 7-14-2006.

3,313,219. GAMELOFT S.A., 75009 PARIS, FRANCE. SN 76-663,860. PUB. 4-24-2007, FILED 7-31-2006.

NAVAL BATTLE: MISSION COMMANDER

THE MARK CONSISTS OF STANDARD CHARACTERS WITHOUT CLAIM TO ANY PARTICULAR FONT, STYLE, SIZE, OR COLOR.

FOR COMPUTER SOFTWARE FOR ELECTRONIC GAMES AND ENTERTAINMENT, NAMELY, COMPUTER GAME SOFTWARE USED AND PLAYED ON MOBILE AND CELLULAR TELEPHONES, HANDHELD COMPUTERS, PERSONAL COMPUTERS AND PERSONAL DIGITAL ASSISTANTS; DOWNLOADABLE ELECTRONIC GAME PROGRAMS; RING TONES; VOICE RINGERS; WALL PAPERS, NAMELY, STILL IMAGES FOR BACKGROUNDS ON PHONE SCREENS; SCREEN SAVERS; ANIMATED IMAGES FOR USE ON PHONE SCREENS; AND PROGRAMS FOR DOWNLOADING IMAGES FOR MOBILE TELECOMMUNICATION DEVICES, NAMELY, MOBILE AND CELLULAR TELEPHONES, HANDHELD COMPUTERS, PERSONAL COMPUTERS AND PERSONAL DIGITAL ASSISTANTS VIA THE GLOBAL COMPUTER NETWORK AND WIRELESS DEVICES; AND COMPUTER SOFTWARE FOR USE IN THE DESIGN, DEVELOPMENT AND EXECUTION OF WIRELESS COMPUTER GAMES (U.S. CLS. 21, 23, 26, 36 AND 38).
FIRST USE 9-1-2006; IN COMMERCE 9-1-2006.

CLASS 9—(Continued).

3,313,220. ISECRUETRAC INC., OMAHA, NE. SN 76-664,091.
PUB. 4-24-2007, FILED 8-3-2006.

FOR PERSONAL TRACKING AND MONITORING SYSTEM COMPRISED OF ELECTRONIC RECEIVERS, TRANSMITTERS, AND SOFTWARE INSTALLED IN A BRACELET (U.S. CLS. 21, 23, 26, 36 AND 38).
FIRST USE 7-22-2006; IN COMMERCE 7-16-2007.

3,313,221. SCIENTIFIC INSTRUMENT SERVICES, INC., RINGOES, NJ. SN 76-664,432. PUB. 3-27-2007, FILED 8-10-2006.

SIMION

THE MARK CONSISTS OF STANDARD CHARACTERS WITHOUT CLAIM TO ANY PARTICULAR FONT, STYLE, SIZE, OR COLOR.

OWNER OF U.S. REG. NO. 3,074,096.
FOR SIMULATION SOFTWARE FOR MODELING OF ELECTRON AND ION OPTICS (U.S. CLS. 21, 23, 26, 36 AND 38).

FIRST USE 10-31-2006; IN COMMERCE 10-31-2006.

CLASS 9—(Continued).

3,313,229. GAMELOFT S.A., 75009 PARIS, FRANCE. SN 76-665,938. PUB. 4-24-2007, FILED 9-13-2006.

PLATINUM KAKURO

THE MARK CONSISTS OF STANDARD CHARACTERS WITHOUT CLAIM TO ANY PARTICULAR FONT, STYLE, SIZE, OR COLOR.

OWNER OF U.S. REG. NO. 3,090,839.

NO CLAIM IS MADE TO THE EXCLUSIVE RIGHT TO USE "KAKURO", APART FROM THE MARK AS SHOWN.

FOR COMPUTER SOFTWARE FOR ELECTRONIC GAMES AND ENTERTAINMENT, NAMELY, COMPUTER GAME SOFTWARE USED AND PLAYED ON MOBILE AND CELLULAR TELEPHONES, HANDHELD COMPUTERS, PERSONAL COMPUTERS AND PERSONAL DIGITAL ASSISTANTS; DOWNLOADABLE ELECTRONIC GAME PROGRAMS; DOWNLOADABLE RING TONES; DOWNLOADABLE VOICE RINGERS FOR MOBILE TELECOMMUNICATIONS DEVICES; COMPUTER SOFTWARE FOR WALL PAPERS, NAMELY, STILL IMAGES FOR USE IN BACKGROUNDS ON MOBILE PHONE SCREENS; COMPUTER SCREEN SAVER SOFTWARE; COMPUTER SOFTWARE FOR PROCESSING ANIMATED IMAGES FOR USE ON MOBILE PHONE SCREENS; AND PROGRAMS FOR DOWNLOADING IMAGES TO MOBILE TELECOMMUNICATION DEVICES, NAMELY, MOBILE AND CELLULAR TELEPHONES, HANDHELD COMPUTERS, PERSONAL COMPUTERS AND PERSONAL DIGITAL ASSISTANTS VIA THE GLOBAL COMPUTER NETWORK AND WIRELESS DEVICES; AND COMPUTER SOFTWARE FOR USE IN THE DESIGN, DEVELOPMENT AND EXECUTION OF WIRELESS COMPUTER GAMES (U.S. CLS. 21, 23, 26, 36 AND 38).

FIRST USE 7-1-2006; IN COMMERCE 7-1-2006.

3,313,231. ORNER, CAROLINE H., HAGERSTOWN, MD. SN 76-666,455. PUB. 5-15-2007, FILED 9-21-2006.

GOGGLE GUARDS

THE MARK CONSISTS OF STANDARD CHARACTERS WITHOUT CLAIM TO ANY PARTICULAR FONT, STYLE, SIZE, OR COLOR.

NO CLAIM IS MADE TO THE EXCLUSIVE RIGHT TO USE "GOGGLE", APART FROM THE MARK AS SHOWN.

FOR PROTECTIVE COVERS FOR EYE WEAR (U.S. CLS. 21, 23, 26, 36 AND 38).

FIRST USE 8-13-2007; IN COMMERCE 8-13-2007.

CLASS 9—(Continued).

3,313,234. GAMELOFT S.A., 75009 PARIS, FRANCE. SN 76-669,434. PUB. 4-17-2007, FILED 11-22-2006.

CLASS 9—(Continued).

3,313,235. GAMELOFT S.A., 75009 PARIS, FRANCE. SN 76-669,450. PUB. 4-17-2007, FILED 11-24-2006.

PLATINUM MAHJONG

THE MARK CONSISTS OF STANDARD CHARACTERS WITHOUT CLAIM TO ANY PARTICULAR FONT, STYLE, SIZE, OR COLOR.

OWNER OF U.S. REG. NO. 3,090,839.

NO CLAIM IS MADE TO THE EXCLUSIVE RIGHT TO USE "MAHJONG", APART FROM THE MARK AS SHOWN.

FOR COMPUTER SOFTWARE FOR ELECTRONIC GAMES AND ENTERTAINMENT, NAMELY, COMPUTER GAME SOFTWARE USED AND PLAYED ON MOBILE AND CELLULAR TELEPHONES, HANDHELD COMPUTERS, PERSONAL COMPUTERS AND PERSONAL DIGITAL ASSISTANTS; DOWNLOADABLE ELECTRONIC GAME PROGRAMS; DOWNLOADABLE RING TONES; DOWNLOADABLE VOICE RINGERS FOR MOBILE TELECOMMUNICATIONS DEVICES; COMPUTER SOFTWARE FOR WALL PAPERS, NAMELY, STILL IMAGES FOR USE IN BACKGROUNDS ON MOBILE PHONE SCREENS; COMPUTER SCREEN SAVER SOFTWARE; COMPUTER SOFTWARE FOR PROCESSING ANIMATED IMAGES FOR USE ON MOBILE PHONE SCREENS; AND PROGRAMS FOR DOWNLOADING IMAGES TO MOBILE TELECOMMUNICATION DEVICES, NAMELY, MOBILE AND CELLULAR TELEPHONES, HANDHELD COMPUTERS, PERSONAL COMPUTERS AND PERSONAL DIGITAL ASSISTANTS VIA THE GLOBAL COMPUTER NETWORK AND WIRELESS DEVICES; AND COMPUTER SOFTWARE FOR USE IN THE DESIGN, DEVELOPMENT AND EXECUTION OF WIRELESS COMPUTER GAMES (U.S. CLS. 21, 23, 26, 36 AND 38).

FIRST USE 6-1-2006; IN COMMERCE 6-1-2006.

PLATINUM SUDOKU

THE MARK CONSISTS OF STANDARD CHARACTERS WITHOUT CLAIM TO ANY PARTICULAR FONT, STYLE, SIZE, OR COLOR.

OWNER OF U.S. REG. NO. 3,090,839.

NO CLAIM IS MADE TO THE EXCLUSIVE RIGHT TO USE "SUDOKU", APART FROM THE MARK AS SHOWN.

FOR COMPUTER SOFTWARE FOR ELECTRONIC GAMES AND ENTERTAINMENT, NAMELY, COMPUTER GAME SOFTWARE USED AND PLAYED ON MOBILE AND CELLULAR TELEPHONES, HANDHELD COMPUTERS, PERSONAL COMPUTERS AND PERSONAL DIGITAL ASSISTANTS; DOWNLOADABLE ELECTRONIC GAME PROGRAMS; DOWNLOADABLE RING TONES; DOWNLOADABLE VOICE RINGERS FOR MOBILE TELECOMMUNICATIONS DEVICES; COMPUTER SOFTWARE FOR WALL PAPERS, NAMELY, STILL IMAGES FOR USE IN BACKGROUNDS ON MOBILE PHONE SCREENS; COMPUTER SCREEN SAVER SOFTWARE; COMPUTER SOFTWARE FOR PROCESSING ANIMATED IMAGES FOR USE ON MOBILE PHONE SCREENS; AND PROGRAMS FOR DOWNLOADING IMAGES TO MOBILE TELECOMMUNICATION DEVICES, NAMELY, MOBILE AND CELLULAR TELEPHONES, HANDHELD COMPUTERS, PERSONAL COMPUTERS AND PERSONAL DIGITAL ASSISTANTS VIA THE GLOBAL COMPUTER NETWORK AND WIRELESS DEVICES; AND COMPUTER SOFTWARE FOR USE IN THE DESIGN, DEVELOPMENT AND EXECUTION OF WIRELESS COMPUTER GAMES (U.S. CLS. 21, 23, 26, 36 AND 38).

FIRST USE 4-1-2006; IN COMMERCE 4-1-2006.

3,313,258. KABUSHIKI KAISHA SEGA, DBA SEGA CORPORATION, TOKYO, JAPAN. SN 77-006,357. PUB. 1-16-2007, FILED 9-25-2006.

SHADOW DANCER

THE MARK CONSISTS OF STANDARD CHARACTERS WITHOUT CLAIM TO ANY PARTICULAR FONT, STYLE, SIZE, OR COLOR.

FOR DOWNLOADABLE VIDEO GAME PROGRAMS; VIDEO GAME SOFTWARE; COMPUTER GAME PROGRAMS (U.S. CLS. 21, 23, 26, 36 AND 38).

FIRST USE 11-8-2006; IN COMMERCE 11-8-2006.

CLASS 9—(Continued).

3,313,259. KABUSHIKI KAISHA SEGA, DBA SEGA CORPORATION, TOKYO, JAPAN. SN 77-006,373. PUB. 1-16-2007, FILED 9-25-2006.

RISTAR

THE MARK CONSISTS OF STANDARD CHARACTERS WITHOUT CLAIM TO ANY PARTICULAR FONT, STYLE, SIZE, OR COLOR.

FOR DOWNLOADABLE VIDEO GAME PROGRAMS (U.S. CLS. 21, 23, 26, 36 AND 38).
FIRST USE 12-4-2006; IN COMMERCE 12-4-2006.

3,313,262. CANARYS AUTOMATIONS LTD., BANGALORE, KARNATAKA, INDIA. SN 77-007,195. PUB. 4-3-2007, FILED 9-26-2006.

Scorpus

THE MARK CONSISTS OF STANDARD CHARACTERS WITHOUT CLAIM TO ANY PARTICULAR FONT, STYLE, SIZE, OR COLOR.

FOR COMPUTER SOFTWARE FOR COMPUTER SYSTEM AND APPLICATION DEVELOPMENT, DEPLOYMENT AND MANAGEMENT; COMPUTER SOFTWARE FOR CREATING SEARCHABLE DATABASES OF INFORMATION AND DATA; COMPUTER SOFTWARE FOR THE COLLECTION, EDITING, ORGANIZING, MODIFYING, BOOK MARKING, TRANSMISSION, STORAGE AND SHARING OF DATA AND INFORMATION (U.S. CLS. 21, 23, 26, 36 AND 38).

FIRST USE 12-1-2006; IN COMMERCE 3-16-2006.

3,313,263. JANAM PARTNERS, LLC, COLD SPRING HARBOR, NY. SN 77-007,355. PUB. 5-8-2007, FILED 9-26-2006.

JANAM

THE MARK CONSISTS OF STANDARD CHARACTERS WITHOUT CLAIM TO ANY PARTICULAR FONT, STYLE, SIZE, OR COLOR.

FOR PORTABLE COMPUTERS (U.S. CLS. 21, 23, 26, 36 AND 38).
FIRST USE 8-6-2007; IN COMMERCE 8-6-2007.

CLASS 9—(Continued).

3,313,266. MOLL, CHRISTOPHER THOMAS, CLEARWATER, FL. AND RIZZO, SALVATORE N., III, CLEARWATER, FL. SN 77-009,179. PUB. 5-8-2007, FILED 9-28-2006.

Perfect Flaw

THE MARK CONSISTS OF STANDARD CHARACTERS WITHOUT CLAIM TO ANY PARTICULAR FONT, STYLE, SIZE, OR COLOR.

FOR AUDIO RECORDINGS FEATURING MUSIC, LYRICS; AUDIO TAPES FEATURING MUSIC, LYRICS; DOWNLOADABLE MULTIMEDIA FILE CONTAINING ARTWORK, TEXT, AUDIO, VIDEO, GAMES, AND INTERNET WEB LINKS RELATING TO MUSIC, LYRICS, PERFORMANCE; DOWNLOADABLE MUSICAL SOUND RECORDINGS; DOWNLOADABLE RING TONES, GRAPHICS AND MUSIC VIA A GLOBAL COMPUTER NETWORK AND WIRELESS DEVICES; DOWNLOADABLE VIDEO RECORDINGS FEATURING MUSIC, LYRICS, PERFORMANCE; MUSICAL SOUND RECORDINGS; MUSICAL VIDEO RECORDINGS; PRE-RECORDED CD'S, VIDEO TAPES, LASER DISKS AND DVD'S FEATURING MUSIC, LYRICS, PERFORMANCE; PRERECORDED AUDIO CASSETTES FEATURING MUSIC, LYRICS; PRERECORDED AUDIO TAPES FEATURING MUSIC, LYRICS; SOUND RECORDINGS FEATURING MUSIC, LYRICS; VIDEO RECORDINGS FEATURING MUSIC, LYRICS, PERFORMANCE; VISUAL RECORDINGS AND AUDIO VISUAL RECORDINGS FEATURING MUSIC AND ANIMATION (U.S. CLS. 21, 23, 26, 36 AND 38).

FIRST USE 4-26-2007; IN COMMERCE 8-1-2007.

3,313,267. DIMARZIO, INC., STATEN ISLAND, NY. SN 77-009,228. PUB. 5-8-2007, FILED 9-28-2006.

D ACTIVATOR

THE MARK CONSISTS OF STANDARD CHARACTERS WITHOUT CLAIM TO ANY PARTICULAR FONT, STYLE, SIZE, OR COLOR.

FOR ELECTRONIC SOUND PICKUP FOR GUITARS (U.S. CLS. 21, 23, 26, 36 AND 38).
FIRST USE 1-0-2007; IN COMMERCE 1-0-2007.

CLASS 9—(Continued).

3,313,270. BRANLY, ROLANDO MANUEL, MIAMI, FL. SN 77-011,135. PUB. 5-15-2007, FILED 9-29-2006.

CLASS 9—(Continued).

3,313,306. ROIZEN, MICHAEL F., SHAKER HEIGHTS, OH. AND OZ, MEHMET C., NEW YORK, NY. SN 77-030,292. PUB. 5-15-2007, FILED 10-26-2006.

NeoXcience

YOU

THE MARK CONSISTS OF STANDARD CHARACTERS WITHOUT CLAIM TO ANY PARTICULAR FONT, STYLE, SIZE, OR COLOR.

FOR PATTERN RECOGNITION SYSTEMS COMPOSED OF COMPUTER CHIPS, COMPUTER HARDWARE AND SOFTWARE (U.S. CLS. 21, 23, 26, 36 AND 38).

FIRST USE 8-7-2007; IN COMMERCE 8-7-2007.

THE MARK CONSISTS OF THE WORD "YOU" WITH ALL LETTERS IN UPPER CASE, AND INSIDE THE LETTER "O" APPEARS A CLOSED FIST WITH AN EXTENDED INDEX FINGER.

FOR ELECTRONIC PUBLICATIONS, NAMELY, BOOKS FEATURING HEALTH, DIET, AND NUTRITION COUNSELING RECORDED ON COMPUTER MEDIA; PRE-RECORDED CD'S, VIDEO TAPES, LASER DISKS AND DVD'S FEATURING INFORMATION ON HEALTH, DIET, AND NUTRITION (U.S. CLS. 21, 23, 26, 36 AND 38).

FIRST USE 5-3-2005; IN COMMERCE 5-3-2005.

3,313,271. BIZY, INC., PALM SPRINGS, CA. SN 77-011,266. PUB. 5-15-2007, FILED 10-1-2006.

3,313,319. CADILLAC JACK, INC., DULUTH, GA. SN 77-036,176. PUB. 6-5-2007, FILED 11-3-2006.

Place Management

CRAZY CLOWNS

THE MARK CONSISTS OF STANDARD CHARACTERS WITHOUT CLAIM TO ANY PARTICULAR FONT, STYLE, SIZE, OR COLOR.

FOR COMPUTER SOFTWARE FOR USE ON COMPUTER COMMUNICATION NETWORKS, NAMELY, SOFTWARE FOR CREATING, EDITING AND DELIVERING TEXTUAL AND GRAPHIC INFORMATION VIA COMPUTER NETWORKS AND GLOBAL COMMUNICATION NETWORKS, AND INSTRUCTION MANUALS SOLD AS A UNIT; WEB SITE DEVELOPMENT SOFTWARE (U.S. CLS. 21, 23, 26, 36 AND 38).

FIRST USE 8-20-2007; IN COMMERCE 8-20-2007.

THE MARK CONSISTS OF STANDARD CHARACTERS WITHOUT CLAIM TO ANY PARTICULAR FONT, STYLE, SIZE, OR COLOR.

FOR GAMING DEVICES, NAMELY, GAMING MACHINES, SLOT MACHINES, BINGO MACHINES, WITH OR WITHOUT VIDEO OUTPUT (U.S. CLS. 21, 23, 26, 36 AND 38).

FIRST USE 11-0-2006; IN COMMERCE 11-0-2006.

CLASS 9—(Continued).

3,313,322. SNIPITRON, LLC, CHICAGO, IL. SN 77-037,047.
PUB. 6-5-2007, FILED 11-5-2006.

SNIPITRON

THE MARK CONSISTS OF STANDARD CHARACTERS WITHOUT CLAIM TO ANY PARTICULAR FONT, STYLE, SIZE, OR COLOR.

FOR COMPUTER SEARCH ENGINE SOFTWARE; COMPUTER SOFTWARE FOR CREATING SEARCHABLE DATABASES OF INFORMATION AND DATA; COMPUTER SOFTWARE FOR THE COLLECTION, EDITING, ORGANIZING, MODIFYING, BOOK MARKING, TRANSMISSION, STORAGE AND SHARING OF DATA AND INFORMATION (U.S. CLS. 21, 23, 26, 36 AND 38).

FIRST USE 10-1-2006; IN COMMERCE 11-1-2006.

CLASS 9—(Continued).

3,313,349. ENGINEERING & RESEARCH ASSOCIATES, INC., TUCSON, AZ. SN 77-100,458. PUB. 6-5-2007, FILED 2-6-2007.



THE MARK CONSISTS OF LETTERS IN A STYLIZED FONT WITH A CIRCLE IN THE MIDDLE OF THE LETTER 'S' AND AN UNDERLINE EXTENDING PAST THE LETTERS 'AFFIRE'.

FOR HEATING AND TEMPERATURE CONTROL APPARATUS USED TO SEAL, FORM AND MOLD THERMOPLASTIC MATERIALS (U.S. CLS. 21, 23, 26, 36 AND 38).

FIRST USE 6-30-2007; IN COMMERCE 6-30-2007.

3,313,353. DIGEO, INC., KIRKLAND, WA. SN 78-109,137.
PUB. 1-27-2004, FILED 2-15-2002.

SUPERTICKER

FOR COMPUTER SOFTWARE, NAMELY, INTERACTIVE USER INTERFACE SOFTWARE FOR SEARCHING, CUSTOMIZING, DISPLAYING, SELECTING, BROWSING, VIEWING, MANAGING, ORGANIZING AND NAVIGATING CONTENT AND DATA DELIVERED IN CONJUNCTION WITH DIGITAL TELEVISION BROADCASTING SERVICES, CABLE TELEVISION BROADCASTING SERVICES, AND INTERACTIVE TELEVISION SERVICES; COMPUTER SOFTWARE FOR SEARCHING, CUSTOMIZING, DISPLAYING, SELECTING, BROWSING, VIEWING, MANAGING, ORGANIZING AND NAVIGATING PRIVATE NETWORK-BASED INTERACTIVE DATABASES (U.S. CLS. 21, 23, 26, 36 AND 38).

FIRST USE 12-0-2006; IN COMMERCE 12-0-2006.

3,313,334. SOLIDSCAPE, INC., MERRIMACK, NH. SN 77-056,891. PUB. 4-10-2007, FILED 12-5-2006.

D66

THE MARK CONSISTS OF STANDARD CHARACTERS WITHOUT CLAIM TO ANY PARTICULAR FONT, STYLE, SIZE, OR COLOR.

OWNER OF U.S. REG. NOS. 2,774,050 AND 2,776,667.
FOR COMPUTER AIDED DESIGN MODELING AND PATTERN MAKING APPARATUS COMPRISED OF COMPUTER HARDWARE AND SOFTWARE FOR MAKING HIGH PRECISION 3-D PROTOTYPE MODELS USED IN THE INDUSTRIAL AND CONSUMER FIELDS (U.S. CLS. 21, 23, 26, 36 AND 38).

FIRST USE 2-24-2007; IN COMMERCE 2-24-2007.

3,313,390. ACCU-ASSEMBLY INCORPORATED, ANDOVER, MA. SN 78-269,024. PUB. 1-20-2004, FILED 7-1-2003.

HUMITEL

FOR HUMIDITY DATA LOGGER (U.S. CLS. 21, 23, 26, 36 AND 38).

FIRST USE 6-30-2006; IN COMMERCE 6-30-2006.

CLASS 9—(Continued).

3,313,391. Z-FORCE ENTERPRISES, LLC, WEST PALM BEACH, FL. SN 78-269,410. PUB. 3-2-2004, FILED 7-1-2003.

Z-FORCE

FOR PRERECORDED COMPACT DISCS, VIDEO TAPES AND DISCS FEATURING ACTION-ADVENTURE, ANIMATION, AND MUSIC (U.S. CLS. 21, 23, 26, 36 AND 38).

FIRST USE 1-31-2006; IN COMMERCE 1-31-2006.

3,313,400. FIBERLINK COMMUNICATIONS CORPORATION, BLUE BELL, PA. SN 78-306,060. PUB. 1-18-2005, FILED 9-26-2003.

EXTEND360

THE MARK CONSISTS OF STANDARD CHARACTERS WITHOUT CLAIM TO ANY PARTICULAR FONT, STYLE, SIZE, OR COLOR.

FOR COMPUTER SOFTWARE FOR PROVIDING MANAGED REMOTE ACCESS SERVICES, NAMELY FOR PROVIDING SECURE, GENERAL PURPOSE CONNECTIVITY SO THAT COMPUTER APPLICATIONS AND COMPUTER NETWORK-BASED SERVICES, CAN BE SECURELY ACCESSED BY A USER CONNECTING REMOTELY TO THE ENTERPRISE LAN AND FOR THE MANAGEMENT, ADMINISTRATION, MODIFICATION AND CONTROL OF THE REMOTE ACCESS (U.S. CLS. 21, 23, 26, 36 AND 38).

FIRST USE 11-10-2003; IN COMMERCE 11-10-2003.

3,313,401. EVEREADY BATTERY COMPANY, INC., ST. LOUIS, MO. SN 78-306,571. PUB. 6-15-2004, FILED 9-29-2003.

ENERGIZER PERFORMANCE BRANDS

OWNER OF U.S. REG. NOS. 1,502,902, 2,423,714, AND OTHERS.

NO CLAIM IS MADE TO THE EXCLUSIVE RIGHT TO USE "PERFORMANCE BRANDS", APART FROM THE MARK AS SHOWN.

FOR BATTERIES (U.S. CLS. 21, 23, 26, 36 AND 38).
FIRST USE 2-28-2007; IN COMMERCE 2-28-2007.

3,313,402. SCIENTIFIC COMPUTING ASSOCIATES, INC., NEW HAVEN, CT. SN 78-307,381. PUB. 7-27-2004, FILED 9-30-2003.

LINDASPACE

OWNER OF U.S. REG. NO. 1,541,384.
FOR COMPUTER SOFTWARE FOR DISTRIBUTED AND PARALLEL COMPUTING (U.S. CLS. 21, 23, 26, 36 AND 38).

FIRST USE 1-3-2007; IN COMMERCE 1-3-2007.

CLASS 9—(Continued).

3,313,404. INFOCUS CORPORATION, WILSONVILLE, OR. SN 78-315,090. PUB. 4-13-2004, FILED 10-17-2003.

SP

FOR AUDIO AND VIDEO PROJECTORS AND PROJECTOR SYSTEMS, NAMELY HOME AUDIO AND VIDEO PROJECTION TELEVISION SETS AND HOME THEATER PROJECTORS (U.S. CLS. 21, 23, 26, 36 AND 38).

FIRST USE 10-17-2003; IN COMMERCE 10-17-2003.

3,313,409. AMERICAN AMUSEMENTS, INC., OMAHA, NE. SN 78-328,086. PUB. 1-30-2007, FILED 11-14-2003.



NO CLAIM IS MADE TO THE EXCLUSIVE RIGHT TO USE "SYSTEMS", APART FROM THE MARK AS SHOWN.

THE COLOR(S) PURPLE, GREEN, YELLOW, BLUE, BLACK, ORANGE, RED, BLUE GREEN AND WHITE IS/ARE CLAIMED AS A FEATURE OF THE MARK.

THE COLORS GREEN AND YELLOW APPEAR IN THE DESIGN OF THE EMERALD. THE CUTS OF THE EMERALD ARE IN BLACK. THE EMERALD IS OUTLINED IN WHITE. THE WORDS "EMERALD CITY" AND "SYSTEMS" APPEAR IN RED, ORANGE AND YELLOW. EACH WORD IS OUTLINED IN BLACK AND WHITE. THE BUILDINGS ARE BLACK WITH BLUE WINDOWS. THE RAINBOW IS IN PURPLE, YELLOW AND BLUE GREEN. THE SUN AND SUN RAYS ARE IN YELLOW. THE BACKGROUND OF THE SKY IS PURPLE.

FOR REEL SLOT MACHINES; GAMING MACHINES FEATURING SLOT MACHINE TYPE GAMES VIA VIDEO DISPLAY; COIN-OPERATED VIDEO OUTPUT GAMING MACHINES; ELECTRO-MECHANICAL AND VIDEO DISPLAY GAMING MACHINE (U.S. CLS. 21, 23, 26, 36 AND 38).

FIRST USE 5-1-2005; IN COMMERCE 5-1-2006.

CLASS 9—(Continued).

3,313,410. SANYO ELECTRIC CO., LTD., MORIGUCHI CITY, OSAKA, JAPAN. SN 78-331,462. PUB. 8-31-2004, FILED 11-21-2003.

CLASS 9—(Continued).

3,313,435. TOSHIBA AMERICA CONSUMER PRODUCTS, L.L.C., WAYNE, NJ. SN 78-383,602. PUB. 1-17-2006, FILED 3-12-2004.

TOYCELL

THE MARK CONSISTS OF STANDARD CHARACTERS WITHOUT CLAIM TO ANY PARTICULAR FONT, STYLE, SIZE, OR COLOR.
FOR BATTERIES (U.S. CLS. 21, 23, 26, 36 AND 38).
FIRST USE 11-3-2006; IN COMMERCE 11-3-2006.

3,313,422. FLESHWOUND FILMS, LLC, LA QUINTA, CA. SN 78-361,345. PUB. 7-5-2005, FILED 2-2-2004.

CRUSTY

THE MARK CONSISTS OF STANDARD CHARACTERS WITHOUT CLAIM TO ANY PARTICULAR FONT, STYLE, SIZE, OR COLOR.
OWNER OF U.S. REG. NOS. 2,094,698 AND 2,876,016.
FOR PRE-RECORDED ENTERTAINMENT PRODUCTS, NAMELY, DVD'S FEATURING SPORTING AND RECREATIONAL ACTIVITIES, MOTOCROSS COMPETITIONS AND FREESTYLE RIDING ON VARIOUS TERRAINS; PRE-RECORDED SOUND RECORDINGS, NAMELY, CD'S, DVD'S, FEATURING SPORTING AND RECREATIONAL ACTIVITIES, MOTOCROSS COMPETITIONS AND FREESTYLE RIDING ON VARIOUS TERRAINS (U.S. CLS. 21, 23, 26, 36 AND 38).
FIRST USE 0-0-1995; IN COMMERCE 0-0-1995.

TALEN

THE MARK CONSISTS OF STANDARD CHARACTERS WITHOUT CLAIM TO ANY PARTICULAR FONT, STYLE, SIZE, OR COLOR.
FOR TELEVISIONS; DEVICES USED IN THE OPERATION OF TELEVISIONS, NAMELY, CHIP BASED CIRCUITRY, LAMPS, LENS, MECHANICAL ENGINE, PROJECTION SCREENS, TELEVISION SCREENS AND TELEVISION COMPONENTS (U.S. CLS. 21, 23, 26, 36 AND 38).
FIRST USE 8-31-2004; IN COMMERCE 8-31-2004.

3,313,438. HOME BOX OFFICE, INC., NEW YORK, NY. SN 78-388,177. PUB. 9-12-2006, FILED 3-22-2004.

CLASSICAL BABY

THE MARK CONSISTS OF STANDARD CHARACTERS WITHOUT CLAIM TO ANY PARTICULAR FONT, STYLE, SIZE, OR COLOR.
FOR DVD'S FEATURING A CHILDREN'S VIDEO SERIES (U.S. CLS. 21, 23, 26, 36 AND 38).
FIRST USE 8-30-2006; IN COMMERCE 8-30-2006.

CLASS 9—(Continued).

3,313,452. VISIONCORP INTERNATIONAL INC., EDMONTON, CANADA. SN 78-426,900. PUB. 7-25-2006, FILED 5-28-2004.

ATMOSPHERE

PRIORITY CLAIMED UNDER SEC. 44(D) ON CANADA APPLICATION NO. 1198192, FILED 11-28-2003, REG. NO. TMA626,098, DATED 11-22-2004, EXPIRES 11-22-2019.

FOR SUNGLASSES AND RELATED ACCESSORIES, NAMELY, SUNGLASSES, SUNGLASSES CASES; EYEWEAR ACCESSORIES, NAMELY, SUNGLASSES CORDS AND CHAINS, NOSE PADS, NOSE PIECES AND TEMPLE TIPS; SUNGLASSES FRAMES SUNGLASSES BANDS, CLIP-ON SUNGLASSES, CLIP-ON NOVELTY SUNGLASS LENSES, CLIP-ON SUNGLASS LENSES ATTACHMENTS AND SUN LENSES ATTACHMENTS WHICH UTILIZE MAGNETS TO SECURE THE SUNGLASS LENSES, SUNGLASSES BRIDGES AND ATTACHMENT CLIPS, LENSES, AND KITS FOR ASSEMBLING AUXILIARY EYEGLASS LENSES COMPRISING LENSES, BRIDGES, AND ATTACHMENT CLIPS FOR AUXILIARY EYEGLASS LENSES; CLEANING CLOTHS FOR SUNGLASSES, LENS CLEANING CLOTHS; WIND/SUN PROTECTION SIDE GUARDS FOR SUNGLASSES; EYEGLASS FRAME HINGES AND CASES; CASES AND POUCHES USED FOR SUNGLASSES; SUNGLASSES CASE INSERTS; HIGH TECH MICRO FIBER LENS WIPING CLOTH FOR USE IN ASSOCIATION WITH SUNGLASSES (U.S. CLS. 21, 23, 26, 36 AND 38).

FIRST USE 1-1-2005; IN COMMERCE 1-1-2005.

3,313,462. CROWN EQUIPMENT CORPORATION, NEW BREMEN, OH. SN 78-437,857. PUB. 9-13-2005, FILED 6-18-2004.

InfoLink

FOR LIFT TRUCK SYSTEMS COMPRISED OF ELECTRONIC DEVICES FOR ATTACHMENT TO LIFT TRUCKS, RECEIVERS, AND ASSOCIATED HARDWARE AND SOFTWARE, ALL USED IN THE COLLECTION AND TRANSMISSION OF DATA, AND USED FOR LOCATING, ROUTING AND TRACKING LIFT TRUCKS AND LIFT TRUCK OPERATORS, FOR TRACKING THE PERFORMANCE OF TASKS BY LIFT TRUCKS AND LIFT TRUCK OPERATORS, FOR GENERATION OF REPORTS REGARDING LIFT TRUCK LOCATION AND OPERATION, FOR PERFORMANCE OF LIFT TRUCK FLEET MANAGEMENT SERVICES, AND FOR CONSULTING SERVICES IN THE FIELD OF LIFT TRUCK FLEET MANAGEMENT SERVICES (U.S. CLS. 21, 23, 26, 36 AND 38).

FIRST USE 3-2-2007; IN COMMERCE 3-2-2007.

CLASS 9—(Continued).

3,313,468. ARK THERAPEUTIC SERVICES, INC., LUGOFF, SC. SN 78-445,698. PUB. 7-26-2005, FILED 7-2-2004.

TALK4ME

THE MARK CONSISTS OF STANDARD CHARACTERS WITHOUT CLAIM TO ANY PARTICULAR FONT, STYLE, SIZE, OR COLOR.

FOR ELECTRONIC DEVICE WHICH CAN BE ACTIVATED BY A PERSON WITH A SPEECH DISABILITY TO GENERATE A SELECTED AUDIBLE MESSAGE (U.S. CLS. 21, 23, 26, 36 AND 38).

FIRST USE 3-8-2007; IN COMMERCE 3-8-2007.

3,313,477. AUTHENTIX, INC., ADDISON, TX. SN 78-469,603. PUB. 1-17-2006, FILED 8-18-2004.

AXIS

THE MARK CONSISTS OF STANDARD CHARACTERS WITHOUT CLAIM TO ANY PARTICULAR FONT, STYLE, SIZE, OR COLOR.

FOR COMPUTER SOFTWARE FOR ORGANIZATION AND PRESENTATION OF DATA RELATED TO MARKED CHEMICALS, PHARMACEUTICALS, ALCOHOL, PETROLEUM PRODUCTS, FUELS AND OILS, PRODUCT PACKAGING IN PAPER AND PLASTIC CONTAINERS USED FOR RENDERING CONSULTING SERVICES, NAMELY, CONSULTING SERVICES IN THE FIELDS OF PRODUCTS LABELING, LABORATORY ANALYSIS OF SAMPLES FOR AUTHENTICATION, CHAIN OF CUSTODY VERIFICATION, AUTHENTICATION OF MARKED CHEMICALS, PHARMACEUTICALS, ALCOHOL, PETROLEUM PRODUCTS, FUELS AND OILS, PRODUCT PACKAGING IN PAPER AND PLASTIC CONTAINERS, MARKER IDENTIFICATION AND USE, AND LEGAL TESTIMONY REGARDING PRODUCT COUNTERFEITING AND AUTHENTICATION (U.S. CLS. 21, 23, 26, 36 AND 38).

FIRST USE 2-0-2005; IN COMMERCE 2-0-2005.

CLASS 9—(Continued).

3,313,481. ARISTOCRAT TECHNOLOGIES AUSTRALIA PTY LTD, LANE COVE, AUSTRALIA. SN 78-478,268. PUB. 7-12-2005, FILED 9-2-2004.

CLASS 9—(Continued).

NO CLAIM IS MADE TO THE EXCLUSIVE RIGHT TO USE "PAYROLL MANAGER", APART FROM THE MARK AS SHOWN.

FOR COMPUTER SOFTWARE FOR USE IN BUSINESS PAYROLL MANAGEMENT (U.S. CLS. 21, 23, 26, 36 AND 38).

FIRST USE 6-1-2002; IN COMMERCE 1-1-2004.

HEART OF GOLD

THE MARK CONSISTS OF STANDARD CHARACTERS WITHOUT CLAIM TO ANY PARTICULAR FONT, STYLE, SIZE, OR COLOR.

FOR GAMING DEVICES, NAMELY, GAMING MACHINES AND COMPUTER SOFTWARE USED THEREWITH TO ENABLE THE GAMING MACHINE TO RUN (U.S. CLS. 21, 23, 26, 36 AND 38).

FIRST USE 9-11-2006; IN COMMERCE 9-11-2006.

3,313,508. CARLING TECHNOLOGIES, INC., PLAINVILLE, CT. SN 78-503,361. PUB. 1-17-2006, FILED 10-21-2004.

3,313,500. NETALOG, INC., CHARLESTON, SC. SN 78-488,270. PUB. 3-21-2006, FILED 9-23-2004.

iBoom

FOR ELECTRONIC COMPONENTS, NAMELY PERSONAL STEREOS OR LOUDSPEAKERS FOR RECEIVING AND AMPLIFYING AUDIO SIGNALS FROM HANDHELD DIGITAL ELECTRONIC AUDIO PLAYERS; PLUG ADAPTORS, NAMELY FOR MOUNTING, CHARGING, AND POWERING PORTABLE AND HANDHELD DIGITAL ELECTRONIC VIDEO OR AUDIO PLAYERS AND FOR RECEIVING AND AMPLIFYING VISUAL OR AUDIO SIGNALS (U.S. CLS. 21, 23, 26, 36 AND 38).

FIRST USE 11-12-2004; IN COMMERCE 11-12-2004.

WAVE

3,313,505. SHARP BANCSYSTEMS INC., BEDFORD, TX. SN 78-500,283. PUB. 9-13-2005, FILED 10-15-2004.



THE MARK CONSISTS OF STANDARD CHARACTERS WITHOUT CLAIM TO ANY PARTICULAR FONT, STYLE, SIZE, OR COLOR.

FOR ELECTRICAL ROCKER SWITCHES (U.S. CLS. 21, 23, 26, 36 AND 38).

FIRST USE 10-0-2004; IN COMMERCE 10-0-2004.

CLASS 9—(Continued).

3,313,516. GILBARCO INC., GREENSBORO, NC. SN 78-509,982. PUB. 10-4-2005, FILED 11-2-2004.

ATLAS

THE MARK CONSISTS OF STANDARD CHARACTERS WITHOUT CLAIM TO ANY PARTICULAR FONT, STYLE, SIZE, OR COLOR.

FOR FUEL DISPENSERS AND FUEL PUMPS AND PARTS THEREFOR FOR SERVICE STATIONS; FUEL DISPENSER AND FUEL PUMP CUSTOMER INTERFACE SYSTEMS AND PARTS THEREFOR. SAID SYSTEMS FOR USE IN ALLOWING CUSTOMERS TO PURCHASE FUEL AT THE DISPENSER OR PUMP AND COMPRISED OF KEYPADS, ELECTRIC LUMINESCENT DISPLAY PANELS, AND MAGNETIC CARD READERS; HANGING HARDWARE AND METERING DEVICES, NAMELY, NOZZLES, HOSES, BREAKAWAYS, AND FUEL METERS; POINT-OF-SALE, CONTROL, AND COMMUNICATION ELECTRONICS COMPRISED OF AN INTEGRATED CIRCUIT BOARD CONTAINING A MICROPROCESSOR AND A COMMUNICATIONS INTEGRATED CIRCUIT ASSOCIATED WITH FUEL DISPENSERS AND FUEL PUMPS TO ALLOW THE FUEL DISPENSER OR FUEL PUMP TO COMMUNICATE WITH THE POINT-OF-SALE (U.S. CLS. 21, 23, 26, 36 AND 38).
FIRST USE 1-1-2005; IN COMMERCE 2-7-2005.

3,313,519. IGT, RENO, NV. SN 78-516,467. PUB. 9-27-2005, FILED 11-13-2004.

MYSTICAL SWORDS

THE MARK CONSISTS OF STANDARD CHARACTERS WITHOUT CLAIM TO ANY PARTICULAR FONT, STYLE, SIZE, OR COLOR.

OWNER OF U.S. REG. NO. 2,903,842 AND OTHERS.
FOR GAMING MACHINES, NAMELY, DEVICES WHICH ACCEPT A WAGER AND COMPONENTS THEREFOR, NAMELY, CONTROLLERS, DISPLAYS, BUTTON PANELS, BOLSTERS, ELECTRICAL WIRING, AND COMPUTER HARDWARE AND SOFTWARE ASSOCIATED THEREWITH (U.S. CLS. 21, 23, 26, 36 AND 38).
FIRST USE 12-22-2006; IN COMMERCE 2-9-2007.

CLASS 9—(Continued).

3,313,520. MMA/CARAT, INC., WILTON, CT. SN 78-518,242. PUB. 10-11-2005, FILED 11-17-2004.

AVISTA BY MMA

THE MARK CONSISTS OF STANDARD CHARACTERS WITHOUT CLAIM TO ANY PARTICULAR FONT, STYLE, SIZE, OR COLOR.

FOR COMPUTER SOFTWARE FOR USE IN DETERMINING, TRACKING AND EVALUATING THE EFFECTIVENESS OF MARKETING PROGRAMS FOR THE GOODS AND SERVICES OF OTHERS (U.S. CLS. 21, 23, 26, 36 AND 38).
FIRST USE 12-0-2004; IN COMMERCE 12-0-2004.

3,313,524. REFLEX PHOTONICS, INC., MONTREAL QUEBEC, CANADA. SN 78-523,080. PUB. 1-10-2006, FILED 11-26-2004.

LIGHT ON BOARD

THE MARK CONSISTS OF STANDARD CHARACTERS WITHOUT CLAIM TO ANY PARTICULAR FONT, STYLE, SIZE, OR COLOR.

FOR ELECTRO-OPTICAL PACKAGING DEVICES, NAMELY, DETECTORS, EMITTERS, LASERS, MODULATORS AND AMPLIFIERS, USED IN THE FIELD OF PHOTONICS, SPECIFICALLY, IN ALLOWING AND FACILITATING ULTRA-HIGH-SPEED COMMUNICATIONS AND DIGITAL DATA TRANSFERS BETWEEN HIGH-SPEED AND HIGH-PERFORMANCE, COMPUTER PROCESSORS, COMPUTER CHIPS AND COMPUTER NETWORKS (U.S. CLS. 21, 23, 26, 36 AND 38).
FIRST USE 2-0-2007; IN COMMERCE 2-0-2007.

CLASS 9—(Continued).

3,313,530. IGT, RENO, NV. SN 78-531,669. PUB. 10-4-2005, FILED 12-13-2004.

RED HOTTIE

THE MARK CONSISTS OF STANDARD CHARACTERS WITHOUT CLAIM TO ANY PARTICULAR FONT, STYLE, SIZE, OR COLOR.

OWNER OF U.S. REG. NOS. 1,884,749, 2,030,164, AND OTHERS.

FOR GAMING MACHINES, NAMELY, DEVICES WHICH ACCEPT A WAGER AND COMPONENTS THEREFOR, NAMELY, CONTROLLERS, DISPLAYS, BUTTON PANELS, BOLSTERS, ELECTRICAL WIRING, AND COMPUTER HARDWARE AND SOFTWARE ASSOCIATED THEREWITH (U.S. CLS. 21, 23, 26, 36 AND 38).

FIRST USE 11-22-2006; IN COMMERCE 12-29-2006.

3,313,532. DATACOLOR HOLDING AG., LUZERN, SWITZERLAND. SN 78-531,989. PUB. 7-25-2006, FILED 12-14-2004.



OWNER OF U.S. REG. NO. 1,423,732.

THE COLOR(S) BLACK, GRAY, WHITE, RED AND BLUE IS/ARE CLAIMED AS A FEATURE OF THE MARK.

THE COLOR BLACK APPEARS IN THE WORD "DATACOLOR" AND IN THE HORIZONTAL LINE IN THE CENTER OF THE MARK. THE COLOR GRAY APPEARS IN THE WORD "CHECK". THE COLOR RED APPEARS IN THE RECTANGLE IN THE UPPER RIGHT HAND CORNER OF THE MARKS. THE COLORS BLUE AND WHITE APPEAR IN THE SQUARE IN THE LOWER LEFT HAND CORNER OF THE MARK.

FOR INTEGRATED MOBILE, HANDHELD COLOR MANAGEMENT SYSTEM CONSISTING OF A MOBILE, HANDHELD SPECTROPHOTOMETER AND COLOR MANAGEMENT/MEASUREMENT COMPUTER SOFTWARE FOR COLOR MEASUREMENT AND IDENTIFICATION, COLOR EVALUATION, COLOR SPECIFICATION AND COLOR QUALITY CONTROL IN BOTH LABORATORY AND PRODUCTION SETTINGS (U.S. CLS. 21, 23, 26, 36 AND 38).

FIRST USE 3-10-2005; IN COMMERCE 3-10-2005.

CLASS 9—(Continued).

3,313,535. BUZZLOGIC, LC, SAN FRANCISCO, CA. SN 78-534,602. PUB. 7-18-2006, FILED 12-17-2004.

BuzzLogic

THE MARK CONSISTS OF STANDARD CHARACTERS WITHOUT CLAIM TO ANY PARTICULAR FONT, STYLE, SIZE, OR COLOR.

FOR COMPUTER SOFTWARE FOR PROVIDING BUSINESS MARKETING AND PUBLIC RELATIONS MANAGEMENT INFORMATION, UTILIZING SEARCH, TEXT MINING AND BUSINESS INTELLIGENCE TECHNOLOGIES FOR TARGETING AND MESSAGE INSERTION APPLIED TO COMPILING, INDEXING, MONITORING, MEASURING, ANALYZING, CHARTING AND ENTERING CONVERSATIONS WITHIN PEER MEDIA, CORPORATE AND OTHER DIGITAL CONTENT WHERE TRENDS, OPPORTUNITIES, RELATIONSHIPS AND PATTERNS ARE SUPPORTIVE (U.S. CLS. 21, 23, 26, 36 AND 38).

FIRST USE 6-1-2004; IN COMMERCE 4-1-2006.

3,313,537. NONESUCH RECORDS INC., NEW YORK, NY. SN 78-535,015. PUB. 4-4-2006, FILED 12-18-2004.

The logo for Nonesuch. It features a large, bold, black letter "N" positioned above the word "NONESUCH" in a bold, uppercase, sans-serif font.

OWNER OF U.S. REG. NOS. 1,437,854 AND 1,492,989.

FOR PRE-RECORDED GOODS, NAMELY, PRE-RECORDED AUDIO AND AUDIO-VIDEO TAPES, DISCS, CASSETTES AND DVDS, ALL FEATURING MUSIC (U.S. CLS. 21, 23, 26, 36 AND 38).

FIRST USE 0-0-1995; IN COMMERCE 0-0-1995.

CLASS 9—(Continued).

3,313,544. K & M ENVIRONMENTAL, INC., VIRGINIA BEACH, VA. SN 78-540,202. PUB. 8-1-2006, FILED 12-30-2004.

CLASS 9—(Continued).

3,313,550. STACCATO COMMUNICATIONS, INC., SAN DIEGO, CA. SN 78-547,806. PUB. 12-12-2006, FILED 1-14-2005.

**DETECTING THE
INVISIBLE**

THE MARK CONSISTS OF STANDARD CHARACTERS WITHOUT CLAIM TO ANY PARTICULAR FONT, STYLE, SIZE, OR COLOR.

FOR MONITORING DEVICES WHICH DETECT THE PRESENCE OR ABSENCE OF SUBSTANCES, NAMELY, TOXIC CHEMICAL DETECTORS, CHEMICAL WARFARE AGENT DETECTORS, RADIATION DETECTORS, TOXIC BIOLOGICAL SUBSTANCE DETECTORS, AND BIOLOGICAL THREAT AGENT DETECTORS (U.S. CLS. 21, 23, 26, 36 AND 38).

FIRST USE 4-14-2005; IN COMMERCE 4-14-2005.

RIPCORD

THE MARK CONSISTS OF STANDARD CHARACTERS WITHOUT CLAIM TO ANY PARTICULAR FONT, STYLE, SIZE, OR COLOR.

FOR INTEGRATED CIRCUITS; WIRELESS SEMICONDUCTOR DEVICES; RADIO FREQUENCY MODULES; COMPUTER HARDWARE; SOFTWARE, NAMELY, CONFIGURATION AND DRIVER SOFTWARE USED TO FACILITATE WIRELESS CONNECTIVITY (U.S. CLS. 21, 23, 26, 36 AND 38).

FIRST USE 1-14-2005; IN COMMERCE 3-31-2005.

3,313,572. UNITED MICROELECTRONICS CORP, HSINCHU, TAIWAN. SN 78-573,112. PUB. 9-13-2005, FILED 2-23-2005.

3,313,545. LG ELECTRONICS INC., SEOUL, REPUBLIC OF KOREA. SN 78-541,333. PUB. 12-6-2005, FILED 1-3-2005.

URAM



THE MARK CONSISTS OF STANDARD CHARACTERS WITHOUT CLAIM TO ANY PARTICULAR FONT, STYLE, SIZE, OR COLOR.

FOR INTEGRATED CIRCUITS, SEMICONDUCTORS, INTEGRATED CIRCUIT CHIPS, SILICON CHIPS (U.S. CLS. 21, 23, 26, 36 AND 38).

FIRST USE 4-25-2007; IN COMMERCE 4-25-2007.

FOR COMPUTERS AND COMPUTER MONITORS (U.S. CLS. 21, 23, 26, 36 AND 38).
FIRST USE 12-31-2005; IN COMMERCE 12-31-2005.

CLASS 9—(Continued).

3,313,573. UNITED MICROELECTRONICS CORP., HSINCHU, TAIWAN. SN 78-573,114. PUB. 9-27-2005, FILED 2-23-2005.

URAM

THE MARK CONSISTS OF THE WORD "URAM" IN STYLIZED FONT.

FOR INTEGRATED CIRCUITS, SEMICONDUCTORS, INTEGRATED CIRCUIT CHIPS, SILICON CHIPS (U.S. CLS. 21, 23, 26, 36 AND 38).

FIRST USE 4-25-2007; IN COMMERCE 4-25-2007.

CLASS 9—(Continued).

3,313,594. OAKLEY, INC., FOOTHILL RANCH, CA. SN 78-584,468. PUB. 11-22-2005, FILED 3-10-2005.

CROSSHAIR

FOR PROTECTIVE EYEWEAR, NAMELY SPECTACLES, PRESCRIPTION EYEWEAR, ANTI GLARE GLASSES AND SUNGLASSES AND THEIR PARTS AND ACCESSORIES, NAMELY REPLACEMENT LENSES, FRAMES, EARSTEMS, AND NOSE PIECES; CASES SPECIALLY ADAPTED FOR SPECTACLES AND SUNGLASSES AND THEIR PARTS AND ACCESSORIES (U.S. CLS. 21, 23, 26, 36 AND 38).

FIRST USE 2-1-2005; IN COMMERCE 2-1-2005.

3,313,592. MONITOR AUDIO LIMITED, ESSEX, UNITED KINGDOM. SN 78-583,467. PUB. 7-11-2006, FILED 3-9-2005.

I-DECK

THE MARK CONSISTS OF STANDARD CHARACTERS WITHOUT CLAIM TO ANY PARTICULAR FONT, STYLE, SIZE, OR COLOR.

FOR APPARATUS FOR USE IN THE RECORDING OR REPRODUCTION OF SOUND AND/OR IMAGES; APPARATUS FOR CONNECTING A STORAGE DEVICE FOR STORING AUDIO AND/OR IMAGE DATA TO ANOTHER ITEM OF EQUIPMENT; APPARATUS FOR CONNECTING PERSONAL MUSIC STORAGE DEVICES TO AN AUDIO AMPLIFIER; APPARATUS FOR RECHARGING AND PROVIDING A DATA CONNECTION FOR AN AUDIO AND/OR IMAGE DATA STORAGE AND RECORDAL DEVICE (U.S. CLS. 21, 23, 26, 36 AND 38).

FIRST USE 7-0-2005; IN COMMERCE 10-0-2005.

3,313,606. ECHOSTAR SATELLITE LLC, ENGLEWOOD, CO. SN 78-590,917. PUB. 7-11-2006, FILED 3-18-2005.

PocketDISH

THE MARK CONSISTS OF STANDARD CHARACTERS WITHOUT CLAIM TO ANY PARTICULAR FONT, STYLE, SIZE, OR COLOR.

FOR VIDEO, AUDIO, AND MUSIC PLAYERS AND RECORDERS; HARD DISKS; HEADPHONES; POWER SUPPLIES; MICROPHONES; INTERFACE POWER CABLES; MUSIC PLAYER AND RECORDER ADAPTERS; MP3, AUDIO, RADIO PLAYERS AND RECORDERS; HANDHELD PERSONAL COMPUTERS AND DEVICES COMBINING VIDEO PLAYERS AND RECORDERS, DIGITAL PHOTO WALLETS AND DATA STORAGE (U.S. CLS. 21, 23, 26, 36 AND 38).

FIRST USE 4-1-2005; IN COMMERCE 10-1-2005.

CLASS 9—(Continued).

3,313,611. XSIGO SYSTEMS, INC., SUNNYVALE, CA. SN 78-593,645. PUB. 12-20-2005, FILED 3-23-2005.

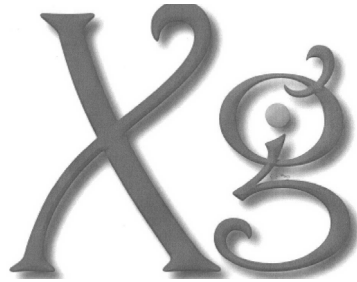

FOR COMPUTER NETWORKING HARDWARE; SYSTEMS MANAGEMENT SOFTWARE (U.S. CLS. 21, 23, 26, 36 AND 38).
FIRST USE 11-17-2006; IN COMMERCE 11-17-2006.

CLASS 9—(Continued).

3,313,627. PIONEER INTERSTATE, INC., DBA TIGER CLAW, KNOXVILLE, TN. SN 78-605,124. PUB. 8-22-2006, FILED 4-8-2005.



THE MARK CONSISTS OF A KICKING TIGER. FOR MAGNETS (U.S. CLS. 21, 23, 26, 36 AND 38).
FIRST USE 8-0-2004; IN COMMERCE 5-8-2007.

3,313,616. SONY ONLINE ENTERTAINMENT INC., CULVER CITY, CA. SN 78-596,254. PUB. 8-8-2006, FILED 3-28-2005.

FIELD COMMANDER

THE MARK CONSISTS OF STANDARD CHARACTERS WITHOUT CLAIM TO ANY PARTICULAR FONT, STYLE, SIZE, OR COLOR.
FOR COMPUTER GAME SOFTWARE FOR USE WITH HANDHELD AND CONSOLE GAME SYSTEMS (U.S. CLS. 21, 23, 26, 36 AND 38).
FIRST USE 5-23-2006; IN COMMERCE 5-23-2006.

3,313,633. LEGAL AND CORPORATE AFFAIRS OF TERABEAM, INC., SOUTH DEERFIELD, MA. SN 78-607,988. PUB. 7-18-2006, FILED 4-13-2005.

TERABRIDGE

THE MARK CONSISTS OF STANDARD CHARACTERS WITHOUT CLAIM TO ANY PARTICULAR FONT, STYLE, SIZE, OR COLOR.
FOR TELECOMMUNICATIONS AND NETWORKING EQUIPMENT, SOFTWARE, AND SYSTEMS, NAMELY, ACCESS POINTS, ANTENNAS, TRANSMITTERS, RECEIVERS, TRANSCEIVERS, MULTIPLEXERS, MODEMS, AMPLIFIERS, INTERFACE CIRCUITS, CONTROLLERS, AND COMPUTER SOFTWARE FOR OPERATING SYSTEMS (U.S. CLS. 21, 23, 26, 36 AND 38).
FIRST USE 9-0-2004; IN COMMERCE 9-0-2004.

CLASS 9—(Continued).

3,313,634. LEGAL AND CORPORATE AFFAIRS OF TERA-BEAM, INC., SOUTH DEERFIELD, MA. SN 78-607,990. PUB. 7-18-2006, FILED 4-13-2005.

TERAOPTIC

THE MARK CONSISTS OF STANDARD CHARACTERS WITHOUT CLAIM TO ANY PARTICULAR FONT, STYLE, SIZE, OR COLOR.

FOR TELECOMMUNICATIONS AND NETWORKING EQUIPMENT, SOFTWARE, AND SYSTEMS, NAMELY, ACCESS POINTS, ANTENNAS, TRANSMITTERS, RECEIVERS, TRANSCEIVERS, MULTIPLEXERS, MODEMS, AMPLIFIERS, INTERFACE CIRCUITS, CONTROLLERS, AND COMPUTER SOFTWARE FOR OPERATING SYSTEMS (U.S. CLS. 21, 23, 26, 36 AND 38).
FIRST USE 9-0-2004; IN COMMERCE 9-0-2004.

3,313,636. BEROL CORPORATION, ATLANTA, GA. SN 78-608,946. PUB. 8-8-2006, FILED 4-14-2005.

ROLODEX

THE MARK CONSISTS OF STANDARD CHARACTERS WITHOUT CLAIM TO ANY PARTICULAR FONT, STYLE, SIZE, OR COLOR.

OWNER OF U.S. REG. NOS. 378,802, 1,631,413, AND OTHERS.

FOR COMPUTER ACCESSORIES; NAMELY, TELEPHONE STANDS, LAPTOP STANDS, PRINTER STANDS, MONITOR STANDS; COMPUTER COMMUNICATION HUBS; NAMELY, USB AND POWER HUBS, AND DESKTOP STANDS FOR PDAS, MP3 PLAYERS, CELL PHONES, OR PORTABLE DISK DRIVES (U.S. CLS. 21, 23, 26, 36 AND 38).

FIRST USE 11-0-2006; IN COMMERCE 11-0-2006.

3,313,642. BUILDINGREPORTS.COM, INC., DULUTH, GA. SN 78-610,561. PUB. 8-22-2006, FILED 4-17-2005.

FireScan

THE MARK CONSISTS OF STANDARD CHARACTERS WITHOUT CLAIM TO ANY PARTICULAR FONT, STYLE, SIZE, OR COLOR.

FOR COMPUTER SOFTWARE, NAMELY AN APPLICATION FOR PERFORMING INSPECTIONS ON FIRE AND LIFE SAFETY SYSTEMS (U.S. CLS. 21, 23, 26, 36 AND 38).

FIRST USE 12-1-1999; IN COMMERCE 12-1-1999.

CLASS 9—(Continued).

3,313,648. EMS TECHNOLOGIES, INC., NORCROSS, GA. SN 78-611,607. PUB. 8-29-2006, FILED 4-19-2005.



The logo for eNfusion broadband features the word "eNfusion" in a sans-serif font, with a stylized "N" that has a horizontal bar extending to the left. Below "eNfusion" is the word "broadband" in a smaller, bold, sans-serif font.

NO CLAIM IS MADE TO THE EXCLUSIVE RIGHT TO USE "BROADBAND", APART FROM THE MARK AS SHOWN.

FOR ANTENNAS, RADOMES, SATELLITE COMMUNICATION TRANSCEIVERS, AIRCRAFT MOUNTED ANTENNAS, EMERGENCY LOCATOR TRANSMITTERS, AND SYSTEMS COMPRISED OF RADOMES, SATELLITE COMMUNICATION TRANSCEIVERS, AIRCRAFT MOUNTED ANTENNAS, HIGH POWER AMPLIFIERS, DIPLEXERS, LOW NOISE AMPLIFIERS SOLD AS A UNIT FOR PROVIDING VOICE, DATA, VIDEO COMMUNICATIONS TO PASSENGERS AND CREW IN AIRCRAFT (U.S. CLS. 21, 23, 26, 36 AND 38).

FIRST USE 12-31-2006; IN COMMERCE 12-31-2006.

3,313,649. IGT, RENO, NV. SN 78-611,829. PUB. 10-11-2005, FILED 4-19-2005.

DOUBLE STRIKE PARTY

THE MARK CONSISTS OF STANDARD CHARACTERS WITHOUT CLAIM TO ANY PARTICULAR FONT, STYLE, SIZE, OR COLOR.

OWNER OF U.S. REG. NOS. 1,854,535, 2,900,855, AND OTHERS.

FOR GAMING MACHINES, NAMELY, DEVICES WHICH ACCEPT A WAGER AND COMPONENTS THEREFOR, NAMELY, CONTROLLERS, DISPLAYS, BUTTON PANELS, BOLSTERS, ELECTRICAL WIRING, AND COMPUTER HARDWARE AND SOFTWARE ASSOCIATED THEREWITH (U.S. CLS. 21, 23, 26, 36 AND 38).

FIRST USE 3-13-2006; IN COMMERCE 4-7-2006.

CLASS 9—(Continued).

3,313,654. GREAT AMERICAN INSURANCE CO., CINCINNATI, OH. SN 78-615,795. PUB. 9-26-2006, FILED 4-25-2005.

CHIPS

THE MARK CONSISTS OF STANDARD CHARACTERS WITHOUT CLAIM TO ANY PARTICULAR FONT, STYLE, SIZE, OR COLOR.

FOR WEB BASED PROCESSING SYSTEM COMPRISED OF COMPUTER SOFTWARE FOR QUOTING, DATA ENTRY AND ACCOUNT REVIEW FOR USE INTERNALLY AND BY INSURANCE PRODUCERS IN UNDERWRITING CROP INSURANCE (U.S. CLS. 21, 23, 26, 36 AND 38).

FIRST USE 3-31-2004; IN COMMERCE 3-31-2004.

3,313,668. ULTRASOUND DEEJAYS, INC., GAITHERSBURG, MD. SN 78-620,941. PUB. 8-22-2006, FILED 5-2-2005.

GIFT OF A LIFETIME

THE MARK CONSISTS OF STANDARD CHARACTERS WITHOUT CLAIM TO ANY PARTICULAR FONT, STYLE, SIZE, OR COLOR.

NO CLAIM IS MADE TO THE EXCLUSIVE RIGHT TO USE "GIFT", APART FROM THE MARK AS SHOWN.

FOR PRE-RECORDED AUDIOCASSETTES, VIDEOCASSETTES, COMPACT DISCS, DIGITAL VIDEO DISCS, AND CD-ROMS FEATURING MUSIC, DOCUMENTARY BIOGRAPHIES OF FAMOUS INDIVIDUALS, AND CUSTOM-MADE DOCUMENTARY BIOGRAPHIES AND TRIBUTES OF FRIENDS, FAMILY MEMBERS, AND OTHERS, AVAILABLE TO THE GENERAL PUBLIC (U.S. CLS. 21, 23, 26, 36 AND 38).

FIRST USE 12-1-2006; IN COMMERCE 12-1-2006.

CLASS 9—(Continued).

3,313,675. MULTIMEDIA GAMES, INC., AUSTIN, TX. SN 78-623,222. PUB. 5-23-2006, FILED 5-4-2005.



THE COLOR(S) RED, BLACK, GOLD, WHITE AND PINK IS/ARE CLAIMED AS A FEATURE OF THE MARK.

THE MARK CONSISTS OF THE STYLIZED NUMBER "3" AND THE STYLIZED WORDS "HAND" AND "POKER" ON A COLORED BACKGROUND WITH PLAYING CARDS. THE COLOR RED APPEARS IN THE OUTLINE OF THE WORDS 3 HAND, THE COLOR BLACK APPEARS IN THE OVAL OUTLINING THE WORD POKER, AND IN THE SPADES, FACES, LETTERS AND NUMBERS ON THE PLAYING CARDS, THE COLOR GOLD APPEARS IN THE WORD HAND AND IN THE CROWNS ON THE CARDS, THE COLOR WHITE APPEARS ON THE CARDS, AND IN THE WORD POKER AND THE NUMBER 3, AND THE COLOR PINK APPEARS IN THE FACES OF THE KING, QUEEN AND JACK OF SPADES ON THE CARDS.

FOR GAMING MACHINES, NAMELY, ELECTRONIC SLOT AND BINGO MACHINES; VIDEO LOTTERY TERMINALS (U.S. CLS. 21, 23, 26, 36 AND 38).

FIRST USE 6-8-2005; IN COMMERCE 6-8-2005.

3,313,679. DEFENSE HOLDINGS, INC., MANASSAS, VA. SN 78-624,508. PUB. 11-21-2006, FILED 5-6-2005.

QuickLight

THE MARK CONSISTS OF STANDARD CHARACTERS WITHOUT CLAIM TO ANY PARTICULAR FONT, STYLE, SIZE, OR COLOR.

FOR PHOTOLUMINESCENT EMERGENCY SIGNAGE AND LIGHTING UNITS (U.S. CLS. 21, 23, 26, 36 AND 38).

FIRST USE 5-1-2005; IN COMMERCE 5-1-2005.

3,313,680. DEFENSE HOLDINGS, INC., MANASSAS, VA. SN 78-624,516. PUB. 8-29-2006, FILED 5-6-2005.

LightRing

THE MARK CONSISTS OF STANDARD CHARACTERS WITHOUT CLAIM TO ANY PARTICULAR FONT, STYLE, SIZE, OR COLOR.

FOR PHOTOLUMINESCENT EMERGENCY SIGNAGE AND LIGHTING UNITS (U.S. CLS. 21, 23, 26, 36 AND 38).

FIRST USE 5-1-2005; IN COMMERCE 5-1-2005.

CLASS 9—(Continued).

3,313,681. DEFENSE HOLDINGS, INC., MANASSAS, VA. SN 78-624,526. PUB. 9-26-2006, FILED 5-6-2005.

LightStep

THE MARK CONSISTS OF STANDARD CHARACTERS WITHOUT CLAIM TO ANY PARTICULAR FONT, STYLE, SIZE, OR COLOR.

FOR PHOTOLUMINESCENT EMERGENCY SIGNAGE AND LIGHTING UNITS (U.S. CLS. 21, 23, 26, 36 AND 38). FIRST USE 5-1-2005; IN COMMERCE 5-1-2005.

3,313,684. ARISTOCRAT TECHNOLOGIES AUSTRALIA PTY LTD, LANE COVE, NEW SOUTH WALES, AUSTRALIA. SN 78-625,447. PUB. 1-31-2006, FILED 5-9-2005.

STATUS SYMBOLS

THE MARK CONSISTS OF STANDARD CHARACTERS WITHOUT CLAIM TO ANY PARTICULAR FONT, STYLE, SIZE, OR COLOR.

FOR GAMING DEVICES, NAMELY, GAMING MACHINES AND COMPUTER SOFTWARE USED THEREWITH TO ENABLE THE GAMING MACHINE TO RUN (U.S. CLS. 21, 23, 26, 36 AND 38).

FIRST USE 6-1-2005; IN COMMERCE 6-1-2005.

3,313,690. VIZABILITY LLC, CEDAR RAPIDS, IA. SN 78-627,680. PUB. 2-21-2006, FILED 5-11-2005.

VIZABILITY

THE MARK CONSISTS OF STANDARD CHARACTERS WITHOUT CLAIM TO ANY PARTICULAR FONT, STYLE, SIZE, OR COLOR.

FOR ACCESS CONTROL AND ALARM MONITORING SYSTEMS (U.S. CLS. 21, 23, 26, 36 AND 38).

FIRST USE 3-27-2007; IN COMMERCE 5-11-2007.

CLASS 9—(Continued).

3,313,698. FLESSAS, JULIE J., MEQUON, WI. SN 78-632,943. PUB. 2-14-2006, FILED 5-19-2005.

CHARMING CAMERAS

THE MARK CONSISTS OF STANDARD CHARACTERS WITHOUT CLAIM TO ANY PARTICULAR FONT, STYLE, SIZE, OR COLOR.

NO CLAIM IS MADE TO THE EXCLUSIVE RIGHT TO USE "CAMERAS", APART FROM THE MARK AS SHOWN. FOR DISPOSABLE CAMERAS (U.S. CLS. 21, 23, 26, 36 AND 38).

FIRST USE 3-0-2007; IN COMMERCE 3-0-2007.

3,313,703. AVX CORPORATION, MYRTLE BEACH, SC. SN 78-636,320. PUB. 10-10-2006, FILED 5-24-2005.

CORECAP

THE MARK CONSISTS OF STANDARD CHARACTERS WITHOUT CLAIM TO ANY PARTICULAR FONT, STYLE, SIZE, OR COLOR.

FOR CAPACITORS (U.S. CLS. 21, 23, 26, 36 AND 38).

FIRST USE 3-12-2007; IN COMMERCE 3-12-2007.

3,313,707. GAMELOGIC INC., WALTHAM, MA. SN 78-637,944. PUB. 2-14-2006, FILED 5-26-2005.

LUNAR LUCK

THE MARK CONSISTS OF STANDARD CHARACTERS WITHOUT CLAIM TO ANY PARTICULAR FONT, STYLE, SIZE, OR COLOR.

FOR COMPUTER GAME SOFTWARE (U.S. CLS. 21, 23, 26, 36 AND 38).

FIRST USE 7-13-2005; IN COMMERCE 7-13-2005.

CLASS 9—(Continued).

3,313,739. CARRY THE DAY, INC., FOSTER CITY, CA. SN 78-651,627. PUB. 10-10-2006, FILED 6-15-2005.



FOR COMPUTER PROGRAMS, NAMELY, APPLICATION PROGRAMS FOR CELL PHONES, SMART PHONES, PERSONAL DIGITAL ASSISTANTS (U.S. CLS. 21, 23, 26, 36 AND 38).
 FIRST USE 1-15-2007; IN COMMERCE 1-15-2007.

CLASS 9—(Continued).

3,313,750. IMAGE INFO, LLC, NEW YORK, NY. SN 78-655,158. PUB. 9-26-2006, FILED 6-21-2005.

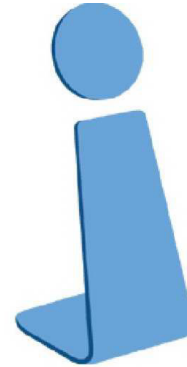

THE COLOR(S) BLUE IS/ARE CLAIMED AS A FEATURE OF THE MARK.
 THE COLOR BLUE APPEARS IN THE ENTIRETY OF THE MARK.
 FOR COMPUTER SOFTWARE FOR STORAGE, RETRIEVAL, DISPLAY AND PRINTING OF DIGITAL PHOTOGRAPHS AND OTHER DATA, EDITING DIGITAL PHOTOGRAPHS, CATALOG DESIGN AND PREPARATION, AND DISTRIBUTING PHOTOGRAPHS AND DATA OVER LOCAL AND GLOBAL COMPUTER NETWORKS (U.S. CLS. 21, 23, 26, 36 AND 38).
 FIRST USE 7-21-2005; IN COMMERCE 7-21-2005.

3,313,746. TECHNI AUTOMATION PTY LTD, CAMPBELLFIELD VIC 3061, AUSTRALIA. SN 78-654,211. PUB. 7-4-2006, FILED 6-20-2005.

TRU-CUT

THE MARK CONSISTS OF STANDARD CHARACTERS WITHOUT CLAIM TO ANY PARTICULAR FONT, STYLE, SIZE, OR COLOR.
 FOR COMPUTER SOFTWARE FOR THE CONTROL AND OPERATION OF WATERJET CUTTING MACHINES (U.S. CLS. 21, 23, 26, 36 AND 38).
 FIRST USE 3-0-2005; IN COMMERCE 5-0-2005.

3,313,756. GUPPY GAMES INC., BELLEVUE, WA. SN 78-656,425. PUB. 2-28-2006, FILED 6-22-2005.

NUMBOLUTION

THE MARK CONSISTS OF STANDARD CHARACTERS WITHOUT CLAIM TO ANY PARTICULAR FONT, STYLE, SIZE, OR COLOR.
 FOR SOFTWARE AND ELECTRONIC GAMES, NAMELY DOWNLOADABLE OR INSTALLABLE SOFTWARE PROGRAMS FOR COMPUTERS AND MOBILE TELEPHONES, PERSONAL DIGITAL ASSISTANTS, AND HANDHELD COMPUTERS (U.S. CLS. 21, 23, 26, 36 AND 38).
 FIRST USE 12-20-2006; IN COMMERCE 12-20-2006.

CLASS 9—(Continued).

3,313,758. FLIR SYSTEMS, INC., WILSONVILLE, OR. SN 78-657,972. PUB. 8-1-2006, FILED 6-24-2005.



OWNER OF U.S. REG. NOS. 2,411,289 AND 2,975,668.
 NO CLAIM IS MADE TO THE EXCLUSIVE RIGHT TO USE "FLIR", APART FROM THE MARK AS SHOWN.
 FOR ELECTRONIC VISION SYSTEMS, NAMELY, IMAGE PROCESSORS AND CAMERAS SENSING ELECTROMAGNETIC RADIATION INCLUDING VISIBLE LIGHT, INFRARED RADIATION AND OTHER THERMAL RADIATION (U.S. CLS. 21, 23, 26, 36 AND 38).
 FIRST USE 3-1-1999; IN COMMERCE 3-1-1999.

3,313,760. PANASONIC CORPORATION OF NORTH AMERICA, SECAUCUS, NJ. SN 78-659,650. PUB. 9-5-2006, FILED 6-28-2005.

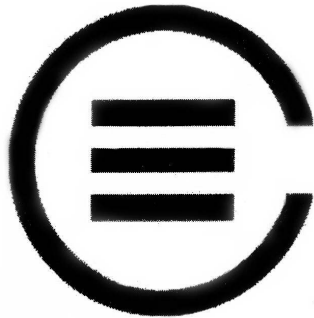

FOR MULTI-FUNCTION MACHINES FOR USE AS A PHOTOCOPIER, SCANNER, PRINTER AND FACSIMILE MACHINE, AND COLOR LASER PRINTERS (U.S. CLS. 21, 23, 26, 36 AND 38).
 FIRST USE 5-29-2007; IN COMMERCE 5-29-2007.

3,313,765. ERB INDUSTRIES, INC., WOODSTOCK, GA. SN 78-660,425. PUB. 4-25-2006, FILED 6-29-2005.



FOR SAFETY HELMETS (U.S. CLS. 21, 23, 26, 36 AND 38).
 FIRST USE 1-0-2006; IN COMMERCE 2-0-2006.

CLASS 9—(Continued).

3,313,766. UMG RECORDINGS, INC., SANTA MONICA, CA. SN 78-661,177. PUB. 3-21-2006, FILED 6-29-2005.

THE TEMPTATIONS

THE MARK CONSISTS OF STANDARD CHARACTERS WITHOUT CLAIM TO ANY PARTICULAR FONT, STYLE, SIZE, OR COLOR.
 OWNER OF U.S. REG. NO. 879,695.
 FOR PRE-RECORDED AUDIO TAPES, DISCS AND CASSETTES, VIDEO TAPES, DISCS AND CASSETTES, DIGITAL AUDIO AND AUDIO VIDEO TAPES AND DISCS, CDS, DVDS, LASER DISCS, AND PHONOGRAPH RECORDS FEATURING MUSIC AND ENTERTAINMENT; THEATRICAL AND MUSICAL SOUND AND VIDEO RECORDINGS; VIRTUAL REALITY SOFTWARE; DOWNLOADABLE RING TONES, MUSIC, MP3S, GRAPHICS, GAMES, IMAGES AND VIDEOS FOR WIRELESS COMMUNICATION DEVICES (U.S. CLS. 21, 23, 26, 36 AND 38).
 FIRST USE 8-0-1961; IN COMMERCE 8-0-1961.

3,313,767. WASHINGTON MUTUAL, INC., SEATTLE, WA. SN 78-661,736. PUB. 10-24-2006, FILED 6-30-2005.



OWNER OF U.S. REG. NOS. 1,214,303, 2,588,771, AND OTHERS.
 THE MARK CONSISTS OF THE STYLIZED LETTER W INSIDE THE CIRCULAR DESIGN OF A SEAL WITH FLAT EDGES ON THE LEFT SIDE AND BOTTOM OF THE DRAWING THAT CONTAINS THE WORDING "WASHINGTON" AT THE TOP OF THE SEAL AND "MUTUAL" AT THE BOTTOM OF THE SEAL.
 SEC. 2(F) AS TO "WASHINGTON MUTUAL".
 FOR MAGNETICALLY ENCODED CREDIT CARDS, DEBIT CARDS, CHECK CARD, CASH CARDS, ATM CARDS, AND STORED VALUE CARDS (U.S. CLS. 21, 23, 26, 36 AND 38).
 FIRST USE 10-31-2005; IN COMMERCE 10-31-2005.

CLASS 9—(Continued).

3,313,777. MINKA LIGHTING, INC., CORONA, CA. SN 78-666,003. PUB. 8-1-2006, FILED 7-7-2005.



The logo for AireControl features the word "AireControl" in a stylized, cursive font. The "A" is large and loops around the "i", and the "C" is also large and loops around the "o".

FOR ELECTRONIC REMOTE CONTROL FOR COMBINED CEILING FAN AND LIGHTING FIXTURE (U.S. CLS. 21, 23, 26, 36 AND 38).

FIRST USE 5-1-2005; IN COMMERCE 5-1-2005.

3,313,781. LAW ENFORCEMENT TECHNOLOGY GROUP, INC., PLYMOUTH, MN. SN 78-667,996. PUB. 8-1-2006, FILED 7-11-2005.



The logo for emerts features the word "emerts" in a blue, lowercase, sans-serif font. A red oval is positioned around the letter "e", and a red line passes through the middle of the letters "e", "m", "e", "r", "t", and "s".

THE COLOR(S) BLUE AND RED IS/ARE CLAIMED AS A FEATURE OF THE MARK.

THE MARK CONSISTS OF WORD EMERTS: BEGINNING WITH THE LETTER "E", DECREASING DARKNESS OF BLUE, WITH RED OVAL AROUND THE "E" AND "SPEEDING BULLET WITH TRAIL" PASSING THROUGH THE MIDDLE OF THE ENTIRE WORD.

FOR COMPUTER SOFTWARE, NAMELY, SOFTWARE FOR USE IN DATABASE MANAGEMENT BY LAW ENFORCEMENT AGENCIES (U.S. CLS. 21, 23, 26, 36 AND 38).

FIRST USE 1-1-2006; IN COMMERCE 1-1-2006.

3,313,784. THE ZEPPU NETWORK, INC., HONOLULU, HI. SN 78-669,543. PUB. 5-1-2007, FILED 7-13-2005.

WEB EMPOWERMENT

THE MARK CONSISTS OF STANDARD CHARACTERS WITHOUT CLAIM TO ANY PARTICULAR FONT, STYLE, SIZE, OR COLOR.

NO CLAIM IS MADE TO THE EXCLUSIVE RIGHT TO USE "WEB", APART FROM THE MARK AS SHOWN.

FOR SOFTWARE FOR MANAGING WEB CONTENT, STRUCTURE AND DESIGN (U.S. CLS. 21, 23, 26, 36 AND 38).

FIRST USE 12-31-2006; IN COMMERCE 7-27-2007.

CLASS 9—(Continued).

3,313,788. HER INTERACTIVE, INC., BELLEVUE, WA. SN 78-671,742. PUB. 4-4-2006, FILED 7-15-2005.

Dare To Play

THE MARK CONSISTS OF STANDARD CHARACTERS WITHOUT CLAIM TO ANY PARTICULAR FONT, STYLE, SIZE, OR COLOR.

FOR INTERACTIVE GAMES, NAMELY, VIRTUAL REALITY GAME SOFTWARE FOR CONSOLES, DESKTOP COMPUTERS, PERSONAL COMPUTERS, HAND HELD COMPUTERS, PERSONAL DATA ASSISTANTS AND OTHER WIRELESS DEVICES; DOWNLOADABLE INTERACTIVE COMPUTER GAMES OF VIRTUAL REALITY FOR DESKTOP COMPUTERS, PERSONAL COMPUTERS, HAND HELD COMPUTERS, PERSONAL DATA ASSISTANTS AND OTHER WIRELESS DEVICES (U.S. CLS. 21, 23, 26, 36 AND 38).

FIRST USE 10-12-2006; IN COMMERCE 10-12-2006.

3,313,798. DIAMOND GAME ENTERPRISES, INC., CHATSWORTH, CA. SN 78-676,161. PUB. 5-2-2006, FILED 7-22-2005.

BIG BAD WOLF

THE MARK CONSISTS OF STANDARD CHARACTERS WITHOUT CLAIM TO ANY PARTICULAR FONT, STYLE, SIZE, OR COLOR.

FOR GAMING EQUIPMENT, NAMELY, GAMING MACHINES (U.S. CLS. 21, 23, 26, 36 AND 38).

FIRST USE 8-0-2006; IN COMMERCE 8-0-2006.

3,313,811. COMPUTERIZED SECURITY SYSTEMS, INC., TROY, MI. SN 78-682,774. PUB. 1-31-2006, FILED 8-1-2005.

MESSENGER

THE MARK CONSISTS OF STANDARD CHARACTERS WITHOUT CLAIM TO ANY PARTICULAR FONT, STYLE, SIZE, OR COLOR.

FOR FACILITIES MANAGEMENT SOFTWARE, NAMELY, SOFTWARE TO CONTROL AND INTERFACE WITH ACCESS AND SECURITY SYSTEMS; ELECTRONIC ENTRY CONTROL SYSTEM COMPRISING ELECTRONIC LOCKS; ELECTRONIC DOOR ACCESS SYSTEM COMPRISED OF ELECTRONIC MAGNETIC KEY CARD ENTRY LOCKS (U.S. CLS. 21, 23, 26, 36 AND 38).

FIRST USE 9-30-2004; IN COMMERCE 9-30-2004.

CLASS 9—(Continued).

3,313,818. AGM AIRFIELD GUIDANCESIGN MANUFACTURERS, INC., MANLIUS, NY. SN 78-685,045. PUB. 5-2-2006, FILED 8-3-2005.

D LUX

THE MARK CONSISTS OF STANDARD CHARACTERS WITHOUT CLAIM TO ANY PARTICULAR FONT, STYLE, SIZE, OR COLOR.

FOR INTERNALLY ILLUMINATED AIRPORT RUNWAY AND TAXIWAY GUIDANCE SIGNS (U.S. CLS. 21, 23, 26, 36 AND 38).

FIRST USE 12-18-2006; IN COMMERCE 12-18-2006.

3,313,838. REGIO IV, LLC, LOS ANGELES, CA. SN 78-697,747. PUB. 2-14-2006, FILED 8-22-2005.

CARDIO CHEER

THE MARK CONSISTS OF STANDARD CHARACTERS WITHOUT CLAIM TO ANY PARTICULAR FONT, STYLE, SIZE, OR COLOR.

NO CLAIM IS MADE TO THE EXCLUSIVE RIGHT TO USE "CARDIO". APART FROM THE MARK AS SHOWN.

FOR PRE-RECORDED CD'S, VIDEO TAPES, LASER DISKS AND DVD'S FEATURING FITNESS AND WORKOUT EXERCISES; PRERECORDED AUDIO TAPES FEATURING FITNESS AND WORKOUT EXERCISES (U.S. CLS. 21, 23, 26, 36 AND 38).

FIRST USE 12-15-2005; IN COMMERCE 12-15-2005.

3,313,839. ACTIVE POWER, INC., AUSTIN, TX. SN 78-698,363. PUB. 7-25-2006, FILED 8-23-2005.

COOLAIR

THE MARK CONSISTS OF STANDARD CHARACTERS WITHOUT CLAIM TO ANY PARTICULAR FONT, STYLE, SIZE, OR COLOR.

FOR ENERGY STORAGE DEVICES, NAMELY, BATTERY-FREE ENERGY STORAGE DEVICES AND THERMAL AND COMPRESSED AIR ENERGY STORAGE ("TACAS") DEVICES; AND TACAS-BASED UNINTERRUPTIBLE POWER SUPPLY DEVICES (U.S. CLS. 21, 23, 26, 36 AND 38).

FIRST USE 6-30-2006; IN COMMERCE 6-30-2006.

CLASS 9—(Continued).

3,313,843. GIALO, MARK, BASKING RIDGE, NJ. SN 78-699,008. PUB. 8-8-2006, FILED 8-24-2005.



NO CLAIM IS MADE TO THE EXCLUSIVE RIGHT TO USE "E MATCH PLAY.COM", APART FROM THE MARK AS SHOWN.

THE MARK CONSISTS OF STYLIZED LINE DRAWING OF FIGURE SWINGING GOLF CLUB POSITIONED ABOVE THE WORDS EMATCHPLAY.COM.

FOR COMPUTER SOFTWARE FOR ELECTRONIC SCORING AND INTERACTIVE PLAY OF GOLF GAMES OVER AN ELECTRONIC COMMUNICATION NETWORK AND THAT MAY BE DOWNLOADED FROM A GLOBAL COMPUTER NETWORK (U.S. CLS. 21, 23, 26, 36 AND 38).

FIRST USE 4-1-2006; IN COMMERCE 4-1-2006.

3,313,844. FREEMAN, RAYMOND F., LOUDON, TN. SN 78-699,034. PUB. 11-7-2006, FILED 8-24-2005.

CONSTRUCT-A-CAM

THE MARK CONSISTS OF STANDARD CHARACTERS WITHOUT CLAIM TO ANY PARTICULAR FONT, STYLE, SIZE, OR COLOR.

FOR REMOTE MONITORING EQUIPMENT FOR CONSTRUCTION SITES, NAMELY DIGITAL VIDEO CAMERAS CONNECTED REMOTELY TO A SERVER (U.S. CLS. 21, 23, 26, 36 AND 38).

FIRST USE 3-1-2006; IN COMMERCE 3-1-2006.

3,313,846. LEUPOLD & STEVENS, INC., BEAVERTON, OR. SN 78-700,191. PUB. 11-21-2006, FILED 8-25-2005.

DARK EARTH

THE MARK CONSISTS OF STANDARD CHARACTERS WITHOUT CLAIM TO ANY PARTICULAR FONT, STYLE, SIZE, OR COLOR.

FOR TELESCOPIC SIGHTS, OPTICAL LENS SCOPES; RIFLESCOPES; BINOCULARS (U.S. CLS. 21, 23, 26, 36 AND 38).

FIRST USE 1-12-2007; IN COMMERCE 1-12-2007.

CLASS 9—(Continued).

3,313,881. MARTHA STEWART LIVING OMNIMEDIA, INC., NEW YORK, NY. SN 78-712,849. PUB. 7-11-2006, FILED 9-14-2005.

MARTHA STEWART LIVING

THE MARK CONSISTS OF STANDARD CHARACTERS WITHOUT CLAIM TO ANY PARTICULAR FONT, STYLE, SIZE, OR COLOR.

THE NAME(S), PORTRAIT(S), AND/OR SIGNATURE(S) SHOWN IN THE MARK IDENTIFIES MARTHA STEWART, WHOSE CONSENT(S) TO REGISTER IS SUBMITTED.

FOR PRE-RECORDED MUSICAL CDS (U.S. CLS. 21, 23, 26, 36 AND 38).

FIRST USE 12-31-2005; IN COMMERCE 12-31-2005.

3,313,887. QSI CORPORATION, SALT LAKE CITY, UT. SN 78-714,571. PUB. 9-12-2006, FILED 9-16-2005.

TREQ

THE MARK CONSISTS OF STANDARD CHARACTERS WITHOUT CLAIM TO ANY PARTICULAR FONT, STYLE, SIZE, OR COLOR.

FOR COMPUTER TERMINALS FOR VEHICLES; MOBILE COMPUTER DATA TERMINALS (U.S. CLS. 21, 23, 26, 36 AND 38).

FIRST USE 6-0-2005; IN COMMERCE 4-5-2006.

3,313,888. JENNINGS, ANDREW BLAKE, MESA, AZ. SN 78-715,018. PUB. 7-25-2006, FILED 9-16-2005.

SHOPTIVATE

THE MARK CONSISTS OF STANDARD CHARACTERS WITHOUT CLAIM TO ANY PARTICULAR FONT, STYLE, SIZE, OR COLOR.

FOR COMPUTER SOFTWARE FOR INDEXING, SEARCHING, AND DISPLAYING INFORMATION ABOUT PRODUCTS FOR SALE IN THE FIELD OF SHOPPING OVER A COMPUTER NETWORK (U.S. CLS. 21, 23, 26, 36 AND 38).

FIRST USE 4-10-2007; IN COMMERCE 4-10-2007.

CLASS 9—(Continued).

3,313,891. VITALE AML CONSULTANTS, INC., NEW YORK, NY. SN 78-715,352. PUB. 9-5-2006, FILED 9-19-2005.

AMLINC

THE MARK CONSISTS OF STANDARD CHARACTERS WITHOUT CLAIM TO ANY PARTICULAR FONT, STYLE, SIZE, OR COLOR.

FOR COMPUTER PROGRAMS RELATING TO THE DETECTION OF MONEY LAUNDERING TRANSACTIONS (U.S. CLS. 21, 23, 26, 36 AND 38).

FIRST USE 4-1-2005; IN COMMERCE 8-1-2005.

3,313,900. SONY KABUSHIKI KAISHA, TA SONY CORPORATION, TOKYO, JAPAN. SN 78-720,158. PUB. 6-20-2006, FILED 9-26-2005.

LifeFLOW

THE MARK CONSISTS OF STANDARD CHARACTERS WITHOUT CLAIM TO ANY PARTICULAR FONT, STYLE, SIZE, OR COLOR.

FOR COMPUTER SCREEN-SAVER SOFTWARE FOR THE REPRODUCTION OF SOUND; COMPUTER SCREEN-SAVER SOFTWARE FOR DISPLAYING A CLOCK, A CALENDAR AND FOR MAKING MEMOS IN THE CALENDAR; COMPUTER SCREEN-SAVER SOFTWARE FOR DISPLAYING A WORLD TIME CLOCK, A WEATHER FORECAST AND A SLIDESHOW OF DIGITAL IMAGES; COMPUTER SCREEN-SAVER SOFTWARE FOR INDICATING NEWS; COMPUTER SOFTWARE FOR READING AND ORGANIZING ONLINE RSS FEEDS (U.S. CLS. 21, 23, 26, 36 AND 38).

FIRST USE 10-31-2005; IN COMMERCE 10-31-2005.

CLASS 9—(Continued).

3,313,908. HUAWEI TECHNOLOGIES CO., LTD., SHENZHEN, CHINA. SN 78-724,256. PUB. 1-23-2007, FILED 9-30-2005.



OWNER OF U.S. REG. NO. 2,750,650.

FOR COMPUTER HARDWARE, FIRMWARE, AND SOFTWARE AND COMPUTER NETWORKS AND NETWORKING COMPONENTS, AND COMPONENTS FOR MANAGING AND INTERCONNECTING TELECOMMUNICATIONS NETWORKS, FOR PROVIDING COMPUTER AND COMPUTER NETWORK SECURITY, AND FOR PROVIDING NETWORK MANAGEMENT AND ENHANCED SERVICES DEVELOPMENT AND DEPLOYMENT, AND FOR MANAGING AND INTERCONNECTING MULTIMEDIA, AUDIO AND VIDEO DATA EQUIPMENT, NAMELY, COMPUTERS, PERIPHERALS, WIRED AND WIRELESS NETWORK INTERFACE DEVICES, ELECTRICAL SWITCHING DEVICES, GATEWAYS FOR USE IN WIRELESS COMMUNICATIONS SYSTEMS' COMPUTER NETWORK BRIDGES, HUBS, ROUTERS, MODEMS, ELECTRIC CABLING, ELECTRONIC INTEGRATED CIRCUITS, ELECTRICAL POWER SUPPLIES, REMOTE ACCESS EQUIPMENT FOR USE IN THE FIELD OF COMPUTER NETWORKING AND TELEPHONY, NAMELY, RECONFIGURABLE PROCESSORS FOR USE IN WIRELESS COMMUNICATION HANDSETS AND NETWORK EQUIPMENT, PC CARD CABLES, HUB AND SWITCH CABLES, RPS CABLES, WAN ACCESS CABLES, FIREWALLS AND FILTERS, NETWORK INTERFACE CARDS, NETWORK JACKS, WIRELESS LAN ANTENNAS AND CABLES, PC CARDS, PCMCIA CARDS, WIRELESS RECEPTION CARDS, SMART CARD INTERFACES, VOICE INPUT DEVICES, SPEAKERS, AND MICROPHONES, AND RELATED SOFTWARE FOR ALL OF THE FOREGOING, NAMELY, COMPUTER SOFTWARE FOR DIAGNOSING, INSTALLING, SUPPORTING, MANAGING, CONFIGURING, CONNECTING, INTEROPERATING, UPGRADING AND CONTROLLING COMPUTER HARDWARE, FIRMWARE, AND SOFTWARE; COMPUTER SOFTWARE FOR DIAGNOSING, INSTALLING, SUPPORTING, MANAGING, CONFIGURING, CONNECTING, INTEROPERATING, UPGRADING AND CONTROLLING COMPUTER HARDWARE, FIRMWARE, AND SOFTWARE; COMPUTER SOFTWARE FOR USE IN THE FIELD OF EDUCATION, NAMELY, FOR DATA COMMUNICATIONS AMONG USERS; TELECOMMUNICATION EQUIPMENT, NAMELY, WIRELESS RADIO FREQUENCY SWITCHES; RADIO TRANSMITTERS AND RECEIVERS FOR TELECOMMUNICATION; WIRELESS LOCAL LOOP ACCESS APPARATUS FOR RADIO SIGNAL TRANSMISSION COMPRISED OF BASE STATION CONTROLLERS, ANTENNAS, SUBSCRIBER UNITS THAT TRANSMIT AND RECEIVE SIGNALS, AND NETWORK MANAGEMENT SWITCHES FOR USE IN MANAGING RADIO SIGNALS AND VOICE TRANSFER BETWEEN SUBSCRIBER TERMINALS AND LOCAL EXCHANGES; WIRELESS SWITCHING PLATFORMS FOR SELECTION OF OPTICAL CHANNEL CONNECTIONS FOR VOICE AND SIGNALS, CALL PROCESSING AND SYSTEM MAINTENANCE; ACCESS NETWORK APPARATUS, NAMELY BASE STATION CONTROLLERS; DIRECTIONAL AND OMNI ANTENNAS; SUBSCRIBER TERMINALS; MOBILE PHONES, WIRELESS TELEPHONES; WIRELESS BASE STATIONS, WIRELESS

CLASS 9—(Continued).

ANTENNAS; TRANSCIVERS FOR TELECOMMUNICATION PURPOSES; AND TELECOMMUNICATION TRUNK CIRCUITS AND TRUNK LINE ASSEMBLIES COMPRISING TRUNK LINE CABLES AND TRUNK LINE AMPLIFIERS; STORED PROGRAM CONTROLLED SWITCHING SYSTEM, NAMELY, STORED PROGRAM CONTROLLED SWITCHING MACHINE FOR USE IN PROCESSING THE INFORMATION FROM INCOMING CALLS TO OUTGOING TERMINALS IN THE PUBLIC SERVICE TELEPHONE NETWORK; RADIO APPARATUS, NAMELY, DATA, VOICE, AND IMAGE SWITCHING EQUIPMENT FOR MOBILE COMMUNICATIONS; OPTICAL TELECOMMUNICATIONS APPARATUS, NAMELY, OPTICAL LINE TERMINAL FOR USE IN RECEIVING, TRANSMITTING AND ANALYZING THE OPTICAL SIGNAL, OPTICAL NETWORK UNIT, ALSO KNOWN AS AN OPTICAL LINE TERMINAL WHICH MANAGES THE OPTICAL NETWORK; FIBER OPTICAL CATV TRANSMISSIONS EQUIPMENT, NAMELY, ELECTRIC LIGHT SWITCHES, OPTIC FIBERS, FIBER OPTIC CABLES; ISDN ACCESS ADAPTER, TELECOMMUNICATION SYSTEM, NAMELY, INTELLIGENT HIGH FREQUENCY NETWORK COMPRISED OF COMPUTER WORKSTATIONS TELECOMMUNICATION TERMINAL EQUIPMENT, NAMELY, TELEPHONE ISDN PHONE, VISUAL PHONE, DIGITAL ENHANCED CORDLESS TELECOMMUNICATIONS (DECT) PHONE, MOBILE PHONE; AND, DIGITAL PHONE; WIRELESS LOCAL LOOP EQUIPMENT, NAMELY, CONNECTIONS FOR MOBILE SUBSCRIBERS TO ACCESS SWITCHING SYSTEMS (U.S. CLS. 21, 23, 26, 36 AND 38).

FIRST USE 5-31-2006; IN COMMERCE 5-31-2006.

3,313,925. MULTIMEDIA GAMES, INC., AUSTIN, TX. SN 78-731,786. PUB. 8-1-2006, FILED 10-12-2005.

Total Meltdown

THE MARK CONSISTS OF STANDARD CHARACTERS WITHOUT CLAIM TO ANY PARTICULAR FONT, STYLE, SIZE, OR COLOR.

FOR GAMING MACHINES, NAMELY ELECTRONIC SLOT AND BINGO MACHINES; VIDEO LOTTERY TERMINALS (U.S. CLS. 21, 23, 26, 36 AND 38).

FIRST USE 1-31-2006; IN COMMERCE 1-31-2006.

CLASS 9—(Continued).

3,313,929. TRIDIUM, INC., RICHMOND, VA. SN 78-735,140. PUB. 8-29-2006, FILED 10-18-2005.

NIAGARA APPLIANCE

THE MARK CONSISTS OF STANDARD CHARACTERS WITHOUT CLAIM TO ANY PARTICULAR FONT, STYLE, SIZE, OR COLOR.

OWNER OF U.S. REG. NO. 2,648,120.

NO CLAIM IS MADE TO THE EXCLUSIVE RIGHT TO USE "APPLIANCE", APART FROM THE MARK AS SHOWN.

FOR COMPUTER SOFTWARE FOR USE IN CREATING OTHER SOFTWARE TO CONTROL AND OPTIMIZE THE OPERATION OF EQUIPMENT OR PROCESSES IN THE FIELD OF COMMERCIAL AND INDUSTRIAL SYSTEMS THROUGH THE INTERNET; COMPUTER SOFTWARE TO CONTROL AND OPTIMIZE THE OPERATION OF EQUIPMENT AND PROCESSES IN THE FIELD OF COMMERCIAL AND INDUSTRIAL SYSTEMS THROUGH THE INTERNET; COMPUTER HARDWARE TO CONTROL AND OPTIMIZE THE OPERATION OF EQUIPMENT AND PROCESSES IN THE FIELD OF COMMERCIAL AND INDUSTRIAL SYSTEMS THROUGH THE INTERNET (U.S. CLS. 21, 23, 26, 36 AND 38).

FIRST USE 1-31-2004; IN COMMERCE 6-30-2002.

3,313,931. ONBOARD RESEARCH CORPORATION, CARROLLTON, TX. SN 78-736,199. PUB. 3-6-2007, FILED 10-19-2005.



NO CLAIM IS MADE TO THE EXCLUSIVE RIGHT TO USE "RHYTHMIC ANALYZERS", APART FROM THE MARK AS SHOWN.

FOR ELECTRONIC DEVICE FOR MEASURING, ASSESSING AND IMPROVING THE SKILLS OF MUSICAL AND TIMING ACCURACY; ELECTRONIC DEVICE FEATURING A METRONOME AND DIGITAL DATA COLLECTION AND DISPLAY (U.S. CLS. 21, 23, 26, 36 AND 38).

FIRST USE 11-2-2005; IN COMMERCE 11-2-2005.

CLASS 9—(Continued).

3,313,932. ONBOARD RESEARCH CORPORATION, CARROLLTON, TX. SN 78-736,201. PUB. 2-13-2007, FILED 10-19-2005.

BEATNIK

THE MARK CONSISTS OF STANDARD CHARACTERS WITHOUT CLAIM TO ANY PARTICULAR FONT, STYLE, SIZE, OR COLOR.

FOR ELECTRONIC DEVICE FOR MEASURING, ASSESSING AND IMPROVING THE SKILLS OF MUSICAL AND TIMING ACCURACY; ELECTRONIC DEVICE FEATURING A METRONOME AND DIGITAL DATA COLLECTION AND DISPLAY (U.S. CLS. 21, 23, 26, 36 AND 38).

FIRST USE 11-2-2005; IN COMMERCE 11-2-2005.

3,313,949. DIRECT SOURCE SPECIAL PRODUCTS INC., LASALLE, QUEBEC, CANADA. SN 78-742,236. PUB. 7-18-2006, FILED 10-28-2005.

PARTY CENTRAL

THE MARK CONSISTS OF STANDARD CHARACTERS WITHOUT CLAIM TO ANY PARTICULAR FONT, STYLE, SIZE, OR COLOR.

FOR COMPACT DISCS FEATURING MUSIC; PRERECORDED DIGITAL VIDEO DISKS FEATURING MUSIC (U.S. CLS. 21, 23, 26, 36 AND 38).

FIRST USE 4-5-2006; IN COMMERCE 4-5-2006.

3,313,950. DIRECT SOURCE SPECIAL PRODUCTS INC., LASALLE, QUEBEC, CANADA. SN 78-742,244. PUB. 8-1-2006, FILED 10-28-2005.



THE MARK CONSISTS OF A BANNER WITH THE WORDS PARTY CENTRAL WHICH IS PRECEDED BY TWO SMILEY FACES.

FOR COMPACT DISCS FEATURING MUSIC; PRERECORDED DIGITAL VIDEO DISKS FEATURING MUSIC (U.S. CLS. 21, 23, 26, 36 AND 38).

FIRST USE 4-5-2006; IN COMMERCE 4-5-2006.

CLASS 9—(Continued).

3,313,964. KINESIX CORPORATION, HOUSTON, TX. SN 78-745,880. PUB. 1-23-2007, FILED 11-2-2005.

DEVELOPING THE REAL-TIME
ENTERPRISE

THE MARK CONSISTS OF STANDARD CHARACTERS WITHOUT CLAIM TO ANY PARTICULAR FONT, STYLE, SIZE, OR COLOR.

FOR SOFTWARE DEVELOPMENT TOOLS (U.S. CLS. 21, 23, 26, 36 AND 38).

FIRST USE 7-0-2005; IN COMMERCE 11-0-2005.

3,313,966. TOYOTA JIDOSHA KABUSHIKI KAISHA, TA TOYOTA MOTOR CORPORATION, TOYOTA-SHI, AICHI-KEN, JAPAN. SN 78-746,546. PUB. 9-12-2006, FILED 11-3-2005.

FJAMMER

THE MARK CONSISTS OF STANDARD CHARACTERS WITHOUT CLAIM TO ANY PARTICULAR FONT, STYLE, SIZE, OR COLOR.

FOR AUTOMOBILE AUDIO EQUIPMENT SYSTEM, NAMELY, AUDIO TAPE PLAYERS AND RECORDERS, AUDIO DISC PLAYERS AND RECORDERS, STEREO AMPLIFIERS, RADIOS, LOUD SPEAKERS, AND REMOTE CONTROLLERS THEREOF (U.S. CLS. 21, 23, 26, 36 AND 38).

FIRST USE 3-31-2006; IN COMMERCE 3-31-2006.

3,313,989. LEUPOLD & STEVENS, INC., BEAVERTON, OR. SN 78-749,843. PUB. 2-6-2007, FILED 11-8-2005.

TBR

THE MARK CONSISTS OF STANDARD CHARACTERS WITHOUT CLAIM TO ANY PARTICULAR FONT, STYLE, SIZE, OR COLOR.

FOR TELESCOPIC SIGHTS, OPTICAL LENS SCOPES; OPTICAL LENS SIGHTS FOR FIREARMS; SPOTTING SCOPES; RANGEFINDERS; COMPONENT OF OPTICAL LENS SIGHTS IN THE NATURE OF A USER-DEFINED AIMING ENHANCEMENT FEATURE WITHIN THE OPTICAL LENS SCOPE DISPLAY (U.S. CLS. 21, 23, 26, 36 AND 38).

FIRST USE 1-19-2006; IN COMMERCE 1-19-2006.

CLASS 9—(Continued).

3,313,994. LEUPOLD & STEVENS, INC., BEAVERTON, OR. SN 78-750,274. PUB. 3-27-2007, FILED 11-9-2005.

SPR

THE MARK CONSISTS OF STANDARD CHARACTERS WITHOUT CLAIM TO ANY PARTICULAR FONT, STYLE, SIZE, OR COLOR.

FOR FEATURE OF AN OPTICAL LENS SCOPE, NAMELY, A RETICLE (U.S. CLS. 21, 23, 26, 36 AND 38).

FIRST USE 4-15-2005; IN COMMERCE 4-15-2005.

3,314,006. NIKE, INC., BEAVERTON, OR. SN 78-752,119. PUB. 7-25-2006, FILED 11-11-2005.

THE EYES LEAD THE BODY

THE MARK CONSISTS OF STANDARD CHARACTERS WITHOUT CLAIM TO ANY PARTICULAR FONT, STYLE, SIZE, OR COLOR.

FOR OPTICAL FRAMES, EYEGLASSES, SUNGLASSES, EYEGLASS LENSES, SUNGLASS LENSES, CONTACT LENSES, PROTECTIVE EYEWEAR, EYEWEAR ACCESSORIES, NAMELY CASES, STRAPS AND NECK CORDS (U.S. CLS. 21, 23, 26, 36 AND 38).

FIRST USE 8-0-2006; IN COMMERCE 8-0-2006.

3,314,016. SYMANTEC CORPORATION, CUPERTINO, CA. SN 78-754,116. PUB. 2-13-2007, FILED 11-15-2005.

NORTON INTERNET SECURITY

THE MARK CONSISTS OF STANDARD CHARACTERS WITHOUT CLAIM TO ANY PARTICULAR FONT, STYLE, SIZE, OR COLOR.

OWNER OF U.S. REG. NOS. 1,507,873, 1,508,960, AND 1,758,084.

NO CLAIM IS MADE TO THE EXCLUSIVE RIGHT TO USE "INTERNET SECURITY", APART FROM THE MARK AS SHOWN.

FOR COMPUTER ANTI VIRUS SOFTWARE; INTERNET SECURITY SOFTWARE; USER MANUALS SUPPLIED WITH ALL OF THE FOREGOING (U.S. CLS. 21, 23, 26, 36 AND 38).

FIRST USE 9-0-1999; IN COMMERCE 9-0-1999.

CLASS 9—(Continued).

3,314,063. CATALOG.COM, INC., OKLAHOMA CITY, OK.
SN 78-764,451. PUB. 8-8-2006, FILED 12-1-2005.

SOCIALCORE

THE MARK CONSISTS OF STANDARD CHARACTERS WITHOUT CLAIM TO ANY PARTICULAR FONT, STYLE, SIZE, OR COLOR.

FOR COMPUTER SOFTWARE PLATFORMS FOR OPERATING A SYSTEM COMPRISING MULTIPLE USER-DEFINED AND COMPANY-DEFINED SOCIAL NETWORKS ENABLING THE COMMUNICATION AND DISTRIBUTION OF INFORMATION AMONG MEMBERS AND VISITORS ACROSS MULTIPLE ELECTRONIC INTERFACES, WHILE ALLOWING TRUSTED THIRD-PARTIES TO SELECTIVELY COMMUNICATE WITH INDIVIDUALS OR BROADER COMMUNITIES (U.S. CLS. 21, 23, 26, 36 AND 38).

FIRST USE 1-1-2006; IN COMMERCE 1-1-2006.

3,314,065. CATALOG.COM, INC., OKLAHOMA CITY, OK.
SN 78-764,476. PUB. 8-8-2006, FILED 12-1-2005.



THE MARK CONSISTS OF THE WORD SOCIALCORE IN STYLIZED LETTERING SUPERIMPOSED OVER AN OPEN HAND.

FOR COMPUTER SOFTWARE PLATFORMS FOR OPERATING A SYSTEM COMPRISING MULTIPLE USER-DEFINED AND COMPANY-DEFINED SOCIAL NETWORKS ENABLING THE COMMUNICATION AND DISTRIBUTION OF INFORMATION AMONG MEMBERS AND VISITORS ACROSS MULTIPLE ELECTRONIC INTERFACES, WHILE ALLOWING TRUSTED THIRD-PARTIES TO SELECTIVELY COMMUNICATE WITH INDIVIDUALS OR BROADER COMMUNITIES (U.S. CLS. 21, 23, 26, 36 AND 38).

FIRST USE 1-1-2006; IN COMMERCE 1-1-2006.

CLASS 9—(Continued).

3,314,070. BEIJING SURSEN INTERNATIONAL INFORMATION TECHNOLOGY CO., LTD., BEIJING 100083, CHINA.
SN 78-765,165. PUB. 11-7-2006, FILED 12-1-2005.

UOML

FOR COMPUTER PERIPHERALS; COMPUTER PROGRAMS FOR USE IN DATABASE MANAGEMENT, FOR USE AS A SPREAD SHEET, FOR WORD PROCESSING; COMPUTER SOFTWARE FOR USE IN DATABASE MANAGEMENT, FOR USE AS A SPREAD SHEET, FOR WORD PROCESSING; DOWNLOADABLE ELECTRONIC PUBLICATIONS IN THE NATURE OF MAGAZINES, PRESENTATION PACKS AND BOOKS IN THE FIELD OF COMPUTER INFORMATION; COMPUTER GAME PROGRAMS; DATA PROCESSING PRODUCTS, PARTICULARLY COMPUTER PROGRAMS FOR USE IN DATABASE MANAGEMENT, FOR USE AS A SPREAD SHEET, FOR WORD PROCESSING; COMPUTER CENTRAL PROCESSING UNITS; COMPUTER E-COMMERCE SOFTWARE TO ALLOW USERS TO PERFORM ELECTRONIC BUSINESS TRANSACTIONS VIA A GLOBAL COMPUTER NETWORK; COMPUTER GROUPWARE FOR USE IN WORKFLOW MANAGEMENT AND ELECTRONIC COMMUNICATION; COMPUTER MEMORIES; ELECTRONIC DATABASE IN THE FIELD OF COMPUTER GAME INFORMATION RECORDED ON COMPUTER MEDIA; COMPUTER SOFTWARE FOR APPLICATION AND DATABASE INTEGRATION (U.S. CLS. 21, 23, 26, 36 AND 38).

FIRST USE 12-1-2004; IN COMMERCE 2-10-2005.

3,314,074. GE HEALTHCARE BIO-SCIENCES AB, UPPSALA, SWEDEN. SN 78-765,392. PUB. 2-13-2007, FILED 12-2-2005.

IMAGEQUANT

THE MARK CONSISTS OF STANDARD CHARACTERS WITHOUT CLAIM TO ANY PARTICULAR FONT, STYLE, SIZE, OR COLOR.

OWNER OF U.S. REG. NO. 1,960,520.

FOR SCANNER FOR CAPTURING IMAGES FOR ANALYSIS FOR USE IN THE LIFE SCIENCE RESEARCH FIELD (U.S. CLS. 21, 23, 26, 36 AND 38).

FIRST USE 5-31-2007; IN COMMERCE 5-31-2007.

CLASS 9—(Continued).

3,314,185. MOELLERS, LUCAS, DBA MO MOD COMPANY, HUTCHINSON, MN. AND MOELLERS, SARANYA, DBA MO MOD COMPANY, HUTCHINSON, MN. SN 78-784,406. PUB. 8-29-2006, FILED 1-3-2006.

Calc La Guard

THE MARK CONSISTS OF STANDARD CHARACTERS WITHOUT CLAIM TO ANY PARTICULAR FONT, STYLE, SIZE, OR COLOR.

FOR CARRYING CASES SPECIALLY ADAPTED FOR POCKET CALCULATORS AND CELLPHONES (U.S. CLS. 21, 23, 26, 36 AND 38).

FIRST USE 4-3-2007; IN COMMERCE 4-30-2007.

3,314,186. BEBOSOFT, INC., PLANTATION, FL. SN 78-784,526. PUB. 8-29-2006, FILED 1-4-2006.

Forms to Go

THE MARK CONSISTS OF STANDARD CHARACTERS WITHOUT CLAIM TO ANY PARTICULAR FONT, STYLE, SIZE, OR COLOR.

NO CLAIM IS MADE TO THE EXCLUSIVE RIGHT TO USE "FORMS", APART FROM THE MARK AS SHOWN.

FOR COMPUTER SOFTWARE FOR PROCESSING WEB FORMS (U.S. CLS. 21, 23, 26, 36 AND 38).

FIRST USE 3-14-2007; IN COMMERCE 3-14-2007.

3,314,195. SMARTSOUND SOFTWARE, INC., NORTH-RIDGE, CA. SN 78-785,092. PUB. 9-5-2006, FILED 1-4-2006.

MOOD READY

THE MARK CONSISTS OF STANDARD CHARACTERS WITHOUT CLAIM TO ANY PARTICULAR FONT, STYLE, SIZE, OR COLOR.

FOR AUDIO RECORDINGS FEATURING MUSIC (U.S. CLS. 21, 23, 26, 36 AND 38).

FIRST USE 5-21-2007; IN COMMERCE 5-21-2007.

CLASS 9—(Continued).

3,314,196. BALON, BRADLEY E., GOFFSTOWN, NH. SN 78-785,157. PUB. 8-29-2006, FILED 1-4-2006.

OUTMEET

THE MARK CONSISTS OF STANDARD CHARACTERS WITHOUT CLAIM TO ANY PARTICULAR FONT, STYLE, SIZE, OR COLOR.

FOR COMPUTER SOFTWARE FOR ACCESSING INFORMATION DIRECTORIES THAT MAY BE DOWNLOADED FROM THE GLOBAL COMPUTER NETWORK; COMPUTER SOFTWARE FOR APPLICATION AND DATABASE INTEGRATION; COMPUTER SOFTWARE FOR CREATING SEARCHABLE DATABASES OF INFORMATION AND DATA; COMPUTER SOFTWARE FOR ORGANIZING AND VIEWING DIGITAL IMAGES AND PHOTOGRAPHS; COMPUTER SOFTWARE FOR THE COLLECTION, EDITING, ORGANIZING, MODIFYING, BOOK MARKING, TRANSMISSION, STORAGE AND SHARING OF DATA AND INFORMATION; COMPUTER SOFTWARE FOR FACILITATING GROUP COMMUNICATIONS; COMPUTER SOFTWARE FOR FACILITATING GROUP COMMUNICATIONS THAT MAY BE DOWNLOADED FROM A GLOBAL COMPUTER NETWORK; COMPUTER SOFTWARE PLATFORMS FOR FACILITATING GROUP COMMUNICATIONS (U.S. CLS. 21, 23, 26, 36 AND 38).

FIRST USE 1-28-2007; IN COMMERCE 1-28-2007.

3,314,197. BALON, BRADLEY E., GOFFSTOWN, NH. SN 78-785,170. PUB. 8-29-2006, FILED 1-4-2006.

TAKING THE MEETING OUT OF THE MEETING

THE MARK CONSISTS OF STANDARD CHARACTERS WITHOUT CLAIM TO ANY PARTICULAR FONT, STYLE, SIZE, OR COLOR.

FOR COMPUTER SOFTWARE FOR ACCESSING INFORMATION DIRECTORIES THAT MAY BE DOWNLOADED FROM THE GLOBAL COMPUTER NETWORK; COMPUTER SOFTWARE FOR APPLICATION AND DATABASE INTEGRATION; COMPUTER SOFTWARE FOR CREATING SEARCHABLE DATABASES OF INFORMATION AND DATA; COMPUTER SOFTWARE FOR ORGANIZING AND VIEWING DIGITAL IMAGES AND PHOTOGRAPHS; COMPUTER SOFTWARE FOR THE COLLECTION, EDITING, ORGANIZING, MODIFYING, BOOK MARKING, TRANSMISSION, STORAGE AND SHARING OF DATA AND INFORMATION; COMPUTER SOFTWARE FOR FACILITATING GROUP COMMUNICATIONS; COMPUTER SOFTWARE FOR FACILITATING GROUP COMMUNICATIONS THAT MAY BE DOWNLOADED FROM A GLOBAL COMPUTER NETWORK; COMPUTER SOFTWARE PLATFORMS FOR FACILITATING GROUP COMMUNICATIONS (U.S. CLS. 21, 23, 26, 36 AND 38).

FIRST USE 1-28-2007; IN COMMERCE 1-28-2007.

CLASS 9—(Continued).

3,314,229. MONITOR TECHNOLOGIES LLC, ELBURN, IL. SN 78-791,530. PUB. 9-12-2006, FILED 1-13-2006.

CLASS 9—(Continued).

3,314,251. QUARK, INC., DENVER, CO. SN 78-794,651. PUB. 9-12-2006, FILED 1-19-2006.

FLEXAR

THE MARK CONSISTS OF STANDARD CHARACTERS WITHOUT CLAIM TO ANY PARTICULAR FONT, STYLE, SIZE, OR COLOR.
FOR LEVEL SENSORS FOR USE IN MONITORING LIQUIDS AND BULK MATERIALS (U.S. CLS. 21, 23, 26, 36 AND 38).
FIRST USE 2-3-2007; IN COMMERCE 2-3-2007.



3,314,236. VIEWDO LLC, AKA VIEWDO, OAKLAND, CA. SN 78-792,624. PUB. 2-13-2007, FILED 1-17-2006.

ViewDo

THE MARK CONSISTS OF STANDARD CHARACTERS WITHOUT CLAIM TO ANY PARTICULAR FONT, STYLE, SIZE, OR COLOR.
FOR DOWNLOADABLE VIDEO RECORDINGS FEATURING HOW TO DO SOMETHING, NAMELY, DOWNLOADABLE INSTRUCTIONAL VIDEO RECORDINGS ON A WIDE VARIETY OF TOPICS (U.S. CLS. 21, 23, 26, 36 AND 38).
FIRST USE 1-20-2006; IN COMMERCE 6-13-2006.



3,314,249. GUTHY-RENKER CORPORATION, PALM DESERT, CA. SN 78-794,221. PUB. 8-1-2006, FILED 1-18-2006.

SLEEK ESSENTIALS

THE MARK CONSISTS OF STANDARD CHARACTERS WITHOUT CLAIM TO ANY PARTICULAR FONT, STYLE, SIZE, OR COLOR.
FOR SERIES OF AUDIO AND VIDEO RECORDINGS FEATURING EXERCISE INSTRUCTION (U.S. CLS. 21, 23, 26, 36 AND 38).
FIRST USE 2-24-2007; IN COMMERCE 2-24-2007.

Composition Zones

THE MARK CONSISTS OF STANDARD CHARACTERS WITHOUT CLAIM TO ANY PARTICULAR FONT, STYLE, SIZE, OR COLOR.
NO CLAIM IS MADE TO THE EXCLUSIVE RIGHT TO USE COMPOSITION, APART FROM THE MARK AS SHOWN.
FOR COMPUTER SOFTWARE FOR PLACING A LAYOUT COMPOSITION INTO ANOTHER LAYOUT COMPOSITION FOR THE PURPOSE OF COLLABORATIVE WORKFLOWS AND CONTENT REUSE NAMELY IN GRAPHIC DESIGN AND DESKTOP PUBLISHING (U.S. CLS. 21, 23, 26, 36 AND 38).
FIRST USE 9-9-2005; IN COMMERCE 9-9-2005.



3,314,259. NUMENTA, INC., MENLO PARK, CA. SN 78-795,770. PUB. 8-8-2006, FILED 1-20-2006.

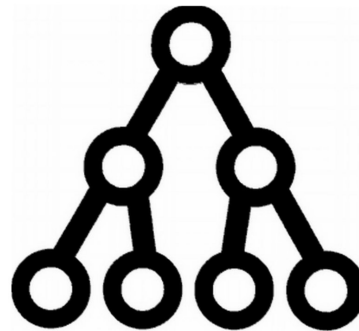

FOR COMPUTER SOFTWARE RELATED TO HIERARCHICALLY ORGANIZED COMPUTER MEMORY SYSTEMS USED TO SOLVE PROBLEMS IN MACHINE VISION, LANGUAGE UNDERSTANDING, ROBOTICS, AND OTHER PROBLEMS THAT REQUIRE MODELING OF COMPLEX DATA; COMPUTER HARDWARE RELATED TO HIERARCHICALLY ORGANIZED COMPUTER MEMORY SYSTEMS USED TO SOLVE PROBLEMS IN MACHINE VISION, LANGUAGE UNDERSTANDING, ROBOTICS, AND OTHER PROBLEMS THAT REQUIRE MODELING OF COMPLEX DATA (U.S. CLS. 21, 23, 26, 36 AND 38).
FIRST USE 2-13-2006; IN COMMERCE 2-13-2006.

CLASS 9—(Continued).

3,314,282. SYMANTEC CORPORATION, CUPERTINO, CA. SN 78-801,013. PUB. 8-1-2006, FILED 1-27-2006.

INFOVAULT

THE MARK CONSISTS OF STANDARD CHARACTERS WITHOUT CLAIM TO ANY PARTICULAR FONT, STYLE, SIZE, OR COLOR.

FOR FEATURE OF INTERNET SECURITY SOFTWARE; A FEATURE OF PRIVACY CONTROL SOFTWARE; A FEATURE OF COMPUTER SOFTWARE FOR USE IN STORING PERSONAL AND CONFIDENTIAL INFORMATION (U.S. CLS. 21, 23, 26, 36 AND 38).

FIRST USE 11-1-2006; IN COMMERCE 11-1-2006.

3,314,309. COPAN SYSTEMS, INC., LONGMONT, CO. SN 78-807,109. PUB. 11-21-2006, FILED 2-3-2006.

MILLENNIA ARCHIVE

THE MARK CONSISTS OF STANDARD CHARACTERS WITHOUT CLAIM TO ANY PARTICULAR FONT, STYLE, SIZE, OR COLOR.

NO CLAIM IS MADE TO THE EXCLUSIVE RIGHT TO USE "ARCHIVE", APART FROM THE MARK AS SHOWN. FOR COMPUTER SOFTWARE FOR DATA ARCHIVING (U.S. CLS. 21, 23, 26, 36 AND 38).

FIRST USE 1-0-2006; IN COMMERCE 1-0-2006.

3,314,317. MEDTRONIC, INC., MINNEAPOLIS, MN. SN 78-809,076. PUB. 9-12-2006, FILED 2-7-2006.

OPTIMIZER

THE MARK CONSISTS OF STANDARD CHARACTERS WITHOUT CLAIM TO ANY PARTICULAR FONT, STYLE, SIZE, OR COLOR.

FOR FEATURE OF PROGRAMMING SOFTWARE THAT USES A MATHEMATICAL ALGORITHM TO DETERMINE THE ELECTRODE PLACEMENT AND AMPLITUDE LEVEL FOR AN IMPLANTED NEUROLOGICAL STIMULATOR, SOLD AS AN INTEGRAL COMPONENT OF COMPUTER PROGRAMMING SOFTWARE THAT IS SOLD AS AN INTEGRAL COMPONENT OF A PROGRAMMING UNIT FOR AN IMPLANTED NEUROLOGICAL STIMULATOR (U.S. CLS. 21, 23, 26, 36 AND 38).

FIRST USE 10-11-2006; IN COMMERCE 10-11-2006.

CLASS 9—(Continued).

3,314,333. ESI CASES & ACCESSORIES, INC., NEW YORK, NY. SN 78-810,912. PUB. 5-22-2007, FILED 2-9-2006.

DESIGNS BY MILAN

THE MARK CONSISTS OF STANDARD CHARACTERS WITHOUT CLAIM TO ANY PARTICULAR FONT, STYLE, SIZE, OR COLOR.

NO CLAIM IS MADE TO THE EXCLUSIVE RIGHT TO USE "DESIGNS", APART FROM THE MARK AS SHOWN.

FOR CELL PHONE CASES; CASES FOR MUSIC PLAYERS, NAMELY MP3 PLAYERS (U.S. CLS. 21, 23, 26, 36 AND 38).

FIRST USE 4-1-2006; IN COMMERCE 4-1-2006.

3,314,357. HELIO LLC, LOS ANGELES, CA. SN 78-815,569. PUB. 12-26-2006, FILED 2-15-2006.

KICKFLIP

THE MARK CONSISTS OF STANDARD CHARACTERS WITHOUT CLAIM TO ANY PARTICULAR FONT, STYLE, SIZE, OR COLOR.

FOR WIRELESS COMMUNICATION DEVICES, NAMELY, MOBILE HANDSETS IN THE NATURE OF A COMBINATION PERSONAL DIGITAL ASSISTANT, TELEPHONE, CAMERA, GLOBAL POSITIONING AND MAPPING DEVICE, TELEVISION, RADIO, VIDEO AND AUDIO PLAYER AND RECORDER (U.S. CLS. 21, 23, 26, 36 AND 38).

FIRST USE 4-28-2006; IN COMMERCE 4-28-2006.

3,314,400. IKONISYS, INC., NEW HAVEN, CT. SN 78-821,774. PUB. 8-1-2006, FILED 2-23-2006.

IKONIPROBE

THE MARK CONSISTS OF STANDARD CHARACTERS WITHOUT CLAIM TO ANY PARTICULAR FONT, STYLE, SIZE, OR COLOR.

FOR BIOLOGICAL MICROSCOPES; MICROSCOPES (U.S. CLS. 21, 23, 26, 36 AND 38).

FIRST USE 6-2-2004; IN COMMERCE 6-2-2004.

CLASS 9—(Continued).

3,314,403. BFTV, LLC, LOS ANGELES, CA. SN 78-822,316. PUB. 5-15-2007, FILED 2-23-2006.

BabyFirstTV

THE MARK CONSISTS OF STANDARD CHARACTERS WITHOUT CLAIM TO ANY PARTICULAR FONT, STYLE, SIZE, OR COLOR.

FOR AUDIO AND VIDEO RECORDINGS FEATURING CHILDREN'S EDUCATION AND ENTERTAINMENT; COMPUTER SOFTWARE PROGRAMS FOR THE INTEGRATION OF TEXT, AUDIO, GRAPHIC, STILL IMAGE AND MOVING PICTURES INTO AN INTERACTIVE DELIVERY FOR MULTIMEDIA APPLICATIONS IN THE FIELD OF CHILDREN'S EDUCATION AND ENTERTAINMENT; COMPUTER SOFTWARE PROGRAMS FOR THE INTEGRATION OF TEXT, AUDIO, GRAPHIC, STILL IMAGE AND MOVING PICTURES INTO AN INTERACTIVE DELIVERY FOR USE WITH INTERACTIVE TELEVISION PROGRAMS AND INTERACTIVE TELEVISION PROGRAM CONTROL DEVICES; COMPUTER GAME SOFTWARE IN THE FIELD OF CHILDREN'S EDUCATION AND ENTERTAINMENT; ELECTRONIC CONTROL AND STORAGE DEVICES, NAMELY, VIDEO GAME INTERACTIVE REMOTE CONTROL UNITS AND VIDEO GAME INTERACTIVE HAND HELD REMOTE CONTROLS FOR PLAYING INTERACTIVE GAMES FOR USE WITH INTERACTIVE TELEVISION PROGRAMS; REMOTE CONTROLS FOR USE WITH INTERACTIVE TELEVISION PROGRAMS (U.S. CLS. 21, 23, 26, 36 AND 38).

FIRST USE 1-24-2007; IN COMMERCE 1-24-2007.

3,314,404. FRED DENNIS RENICK, HERMOSA BEACH, CA. SN 78-822,356. PUB. 10-17-2006, FILED 2-24-2006.



THE COLORS YELLOW, BLACK, GREY AND WHITE ARE CLAIMED AS A FEATURE OF THE MARK.

THE COLOR YELLOW APPEARS ON THE LION'S FUR. THE COLOR GREY APPEARS IN THE WORDING ROCKZION ALONGSIDE THE COLOR WHITE. THE COLOR WHITE APPEARS BEHIND THE LION IN A CIRCULAR FORMATION. THE COLOR BLACK APPEARS IN THE LION'S MANE, OUTLINE OF THE LION, LIONS FACE, THE ROCK THE LION IS SITTING UPON AND THE BACKGROUND OF THE MARK.

FOR PRE-RECORDED CD'S, VIDEO TAPES, LASER DISKS AND DVD'S FEATURING MUSICAL PERFORMANCES BY SINGLE ARTIST OR GROUP (U.S. CLS. 21, 23, 26, 36 AND 38).

FIRST USE 2-3-2007; IN COMMERCE 2-3-2007.

CLASS 9—(Continued).

3,314,414. CELL TREASURES INC., PENSACOLA, FL. SN 78-825,811. PUB. 12-12-2006, FILED 2-28-2006.

Techshell

THE MARK CONSISTS OF STANDARD CHARACTERS WITHOUT CLAIM TO ANY PARTICULAR FONT, STYLE, SIZE, OR COLOR.

FOR PROTECTIVE HARD PLASTIC SHELL FOR NOTEBOOK OR LAPTOP COMPUTERS AND WIRELESS PHONES OR MOBILE PHONES (U.S. CLS. 21, 23, 26, 36 AND 38).

FIRST USE 12-1-2006; IN COMMERCE 12-1-2006.

3,314,421. DEDICATED DEVICES, INC., BOISE, ID. SN 78-827,604. PUB. 10-17-2006, FILED 3-2-2006.

DIGITALiFE

THE MARK CONSISTS OF STANDARD CHARACTERS WITHOUT CLAIM TO ANY PARTICULAR FONT, STYLE, SIZE, OR COLOR.

FOR COMPUTER NETWORK ADAPTERS; COMPUTER NETWORK HUBS, SWITCHES AND ROUTERS; COMPUTER NETWORKING HARDWARE (U.S. CLS. 21, 23, 26, 36 AND 38).

FIRST USE 4-1-2006; IN COMMERCE 4-1-2006.

3,314,425. THE FORCE, INC., HUNTSVILLE, AL. SN 78-828,543. PUB. 10-24-2006, FILED 3-3-2006.

The Force, Inc.

THE MARK CONSISTS OF STANDARD CHARACTERS WITHOUT CLAIM TO ANY PARTICULAR FONT, STYLE, SIZE, OR COLOR.

NO CLAIM IS MADE TO THE EXCLUSIVE RIGHT TO USE "INC.", APART FROM THE MARK AS SHOWN.

FOR COMPUTER SOFTWARE FOR GOVERNMENTAL AND COMMERCIAL ENTITIES FOR DETERMINING PHYSICAL ASSET MANAGEMENT (U.S. CLS. 21, 23, 26, 36 AND 38).

FIRST USE 7-15-2006; IN COMMERCE 7-15-2006.

CLASS 9—(Continued).

3,314,428. WAYNE T. MOORE, IONE, CA. SN 78-828,655. PUB. 10-24-2006, FILED 3-3-2006.



NO CLAIM IS MADE TO THE EXCLUSIVE RIGHT TO USE "SELECT PAYMENT SERVICE", APART FROM THE MARK AS SHOWN.

THE COLOR(S) GREEN, BLACK AND WHITE IS/ARE CLAIMED AS A FEATURE OF THE MARK.

THE MARK CONSISTS OF THE DOLLAR SIGN IN BLACK AND WHITE, THE LETTER "P" IN BLACK, THE WORDING IN BLACK AND ARROWS AROUND THE LETTER "P" IN GREEN.

FOR CARD READERS FOR CREDIT CARDS; COMPUTER PROGRAM FOR THE COMPILATION OF CREDIT REPORTING DATA; ELECTRONIC MACHINES FOR READING CREDIT CARDS AND RECORDING FINANCIAL OPERATIONS (U.S. CLS. 21, 23, 26, 36 AND 38).

FIRST USE 1-1-2006; IN COMMERCE 2-15-2006.

3,314,448. DRAGON OPTICAL, INC., CARLSBAD, CA. SN 78-833,333. PUB. 10-24-2006, FILED 3-9-2006.

PROG

THE MARK CONSISTS OF STANDARD CHARACTERS WITHOUT CLAIM TO ANY PARTICULAR FONT, STYLE, SIZE, OR COLOR.

FOR PROTECTIVE AND/OR ANTIGLARE EYEWEAR, NAMELY, SUNGLASSES, GOGGLES AND PARTS AND ACCESSORIES THEREFORE, NAMELY, REPLACEMENT LENSES, EAR STEMS, FRAMES, NOSE PIECES AND FOAM STRIPS; AND CASES SPECIALLY ADAPTED FOR PROTECTIVE AND/OR ANTI-GLARE EYEWEAR (U.S. CLS. 21, 23, 26, 36 AND 38).

FIRST USE 8-31-2006; IN COMMERCE 10-31-2006.

CLASS 9—(Continued).

3,314,456. WESTCOM SOFTWARE, LLC, FUQUAY-VARINA, NC. SN 78-835,050. PUB. 1-9-2007, FILED 3-11-2006.

Karaoke Song Book Pro

THE MARK CONSISTS OF STANDARD CHARACTERS WITHOUT CLAIM TO ANY PARTICULAR FONT, STYLE, SIZE, OR COLOR.

NO CLAIM IS MADE TO THE EXCLUSIVE RIGHT TO USE "KARAOKE SONG BOOK", APART FROM THE MARK AS SHOWN.

FOR COMPUTER SOFTWARE FOR MAINTAINING A KARAOKE AND AUDIO SONG TITLE DATABASE (U.S. CLS. 21, 23, 26, 36 AND 38).

FIRST USE 1-15-2007; IN COMMERCE 1-15-2007.

3,314,462. HUMAN SYNERGISTICS, INC., PLYMOUTH, MI. SN 78-836,266. PUB. 10-31-2006, FILED 3-14-2006.

CHANGING THE WORLD-ONE ORGANIZATION AT A TIME

THE MARK CONSISTS OF STANDARD CHARACTERS WITHOUT CLAIM TO ANY PARTICULAR FONT, STYLE, SIZE, OR COLOR.

FOR DVDS FEATURING INSTRUCTION OR GUIDANCE IN THE ADMINISTRATION, USE, INTERPRETATION AND APPLICATION OF PSYCHOLOGICAL TESTING INSTRUMENTS, TEAM BUILDING EXERCISES AND ORGANIZATIONAL SURVEYS; VIDEO TAPES FEATURING GUIDANCE IN THE ADMINISTRATION, USE, INTERPRETATION AND APPLICATION OF PSYCHOLOGICAL TESTING INSTRUMENTS, TEAM BUILDING EXERCISES AND ORGANIZATIONAL SURVEYS (U.S. CLS. 21, 23, 26, 36 AND 38).

FIRST USE 6-19-2006; IN COMMERCE 7-6-2006.

CLASS 9—(Continued).

3,314,472. MU SECURITY, SUNNYVALE, CA. SN 78-841,548.
PUB. 2-13-2007, FILED 3-20-2006.

PROTOCOL SPIDERING

THE MARK CONSISTS OF STANDARD CHARACTERS WITHOUT CLAIM TO ANY PARTICULAR FONT, STYLE, SIZE, OR COLOR.

NO CLAIM IS MADE TO THE EXCLUSIVE RIGHT TO USE "PROTOCOL", APART FROM THE MARK AS SHOWN. FOR COMPUTER HARDWARE AND SOFTWARE FOR EVALUATING THE SECURITY READINESS OF NETWORKED EQUIPMENTS, NAMELY, VOICE-OVER INTERNET PROTOCOL (VOIP) PHONES, NETWORK SWITCHES, ROUTERS, FIREWALLS, INTRUSION PREVENTION SYSTEMS, UNIFIED THREAT MANAGEMENT (UTM) SYSTEMS, GAME CONTROLLERS, E-COMMERCE NETWORKS, HOME GATEWAYS, POINT OF SALE SYSTEMS AND SOFTWARE APPLICATIONS, AND INSTRUCTIONAL MANUALS SOLD AS A UNIT (U.S. CLS. 21, 23, 26, 36 AND 38).

FIRST USE 4-14-2006; IN COMMERCE 4-14-2006.

3,314,477. DRAGON OPTICAL, INC., CARLSBAD, CA. SN 78-843,372. PUB. 10-31-2006, FILED 3-22-2006.

WORMSER

THE MARK CONSISTS OF STANDARD CHARACTERS WITHOUT CLAIM TO ANY PARTICULAR FONT, STYLE, SIZE, OR COLOR.

FOR PROTECTIVE AND/OR ANTIGLARE EYEWEAR, NAMELY, SUNGLASSES, GOGGLES AND PARTS AND ACCESSORIES THEREFORE, NAMELY, REPLACEMENT LENSES, EAR STEMS, FRAMES, NOSE PIECES AND FOAM STRIPS; AND CASES SPECIALLY ADAPTED FOR PROTECTIVE AND/OR ANTI-GLARE EYEWEAR (U.S. CLS. 21, 23, 26, 36 AND 38).

FIRST USE 8-31-2006; IN COMMERCE 10-31-2006.

CLASS 9—(Continued).

3,314,478. BIRD TECHNOLOGIES GROUP INC., SOLON, OH. SN 78-843,395. PUB. 5-15-2007, FILED 3-22-2006.

BDS

THE MARK CONSISTS OF STANDARD CHARACTERS WITHOUT CLAIM TO ANY PARTICULAR FONT, STYLE, SIZE, OR COLOR.

FOR ELECTRIC OR ELECTRONIC SENSORS FOR MEASURING RADIO FREQUENCY SIGNAL POWER AND STRENGTH SOLD AS A COMPONENT PART OF A RADIO FREQUENCY SIGNAL DIAGNOSTIC SYSTEM (U.S. CLS. 21, 23, 26, 36 AND 38).

FIRST USE 6-29-2006; IN COMMERCE 6-29-2006.

3,314,489. THE RADIAN GROUP LLC, MELVILLE, NY. SN 78-849,156. PUB. 1-23-2007, FILED 3-29-2006.

SOLEIL

THE MARK CONSISTS OF STANDARD CHARACTERS WITHOUT CLAIM TO ANY PARTICULAR FONT, STYLE, SIZE, OR COLOR.

THE ENGLISH TRANSLATION OF THE WORD SOLEIL IN THE MARK IS SUN.

FOR STORAGE AND CARRYING CASES FOR COMPUTERS, PERSONAL COMPUTERS, LAPTOP COMPUTERS, NOTEBOOK COMPUTERS, PORTABLE AUDIO PLAYERS AND PORTABLE VIDEO PLAYERS; LAPTOP AND NOTEBOOK COMPUTER BAGS (U.S. CLS. 21, 23, 26, 36 AND 38).

FIRST USE 8-0-2006; IN COMMERCE 8-0-2006.

CLASS 9—(Continued).

3,314,548. PRORODEO FILMS, INC., NEW YORK, NY. SN 78-871,013. PUB. 12-5-2006, FILED 4-27-2006.

CLASS 9—(Continued).

3,314,549. BFTV, LLC, LOSANGELES, CA. SN 78-872,699. PUB. 5-15-2007, FILED 4-28-2006.

COWBOYS OF FAITH

THE MARK CONSISTS OF STANDARD CHARACTERS WITHOUT CLAIM TO ANY PARTICULAR FONT, STYLE, SIZE, OR COLOR.

NO CLAIM IS MADE TO THE EXCLUSIVE RIGHT TO USE COWBOYS, APART FROM THE MARK AS SHOWN.

FOR PRERECORDED DIGITAL VIDEO DISCS, PRERECORDED VIDEO CASSETTES, PRERECORDED AUDIO CASSETTES, DOWNLOADABLE VIDEO RECORDINGS, DOWNLOADABLE MULTIMEDIA FILE CONTAINING AUDIO, DOWNLOADABLE TV PROGRAMS, VIDEO GAME SOFTWARE, COMPUTER GAME SOFTWARE, COMPUTER SCREEN SAVER SOFTWARE, ELECTRONIC GAME SOFTWARE FOR CELLULAR TELEPHONES, ELECTRONIC GAME SOFTWARE FOR WIRELESS DEVICES, AND ELECTRONIC GAME SOFTWARE FOR HANDHELD ELECTRONIC DEVICES ALL FEATURING WESTERN LIFESTYLE, RODEO AND RELIGIOUS MINISTRY SUBJECT MATTER (U.S. CLS. 21, 23, 26, 36 AND 38).

FIRST USE 1-1-2007; IN COMMERCE 5-1-2007.

THE COLOR(S) TAN, YELLOW, BLACK, RED, PINK, PURPLE, LIGHT GREEN, ORANGE IS/ARE CLAIMED AS A FEATURE OF THE MARK.

THE MARK CONSISTS OF THE DESIGN OF A FLOWER, WITH THE COLOR TAN APPEARING IN THE MIDDLE OF THE FLOWER, AND THE COLOR BLACK AS THE "EYES" AND THE COLOR RED AS THE "MOUTH" AND "HAIR" DESIGNS THEREIN; THE PETALS OF THE FLOWERS AS IN THE COLORS PINK, PURPLE, LIGHT GREEN, YELLOW, ORANGE AND RED SEPARATELY.

FOR AUDIO AND VIDEO RECORDINGS FEATURING CHILDREN'S EDUCATION AND ENTERTAINMENT; COMPUTER SOFTWARE FOR THE INTEGRATION OF TEXT, AUDIO, GRAPHIC, STILL IMAGE AND MOVING PICTURES INTO AN INTERACTIVE DELIVERY FOR MULTIMEDIA APPLICATIONS IN THE FIELD OF CHILDREN'S EDUCATION AND ENTERTAINMENT; COMPUTER SOFTWARE FOR THE INTEGRATION OF TEXT, AUDIO, GRAPHIC, STILL IMAGE AND MOVING PICTURES INTO AN INTERACTIVE DELIVERY FOR USE WITH INTERACTIVE TELEVISION PROGRAMS AND INTERACTIVE TELEVISION PROGRAM CONTROL DEVICES; COMPUTER GAME SOFTWARE IN THE FIELD OF CHILDREN'S EDUCATION AND ENTERTAINMENT; ELECTRONIC CONTROL AND STORAGE DEVICES, NAMELY, VIDEO GAME INTERACTIVE REMOTE CONTROLS AND VIDEO GAME INTERACTIVE HAND HELD REMOTE CONTROLS FOR PLAYING INTERACTIVE GAMES FOR USE WITH INTERACTIVE TELEVISION PROGRAMS; REMOTE CONTROLS FOR USE WITH INTERACTIVE TELEVISION PROGRAMS (U.S. CLS. 21, 23, 26, 36 AND 38).

FIRST USE 1-24-2007; IN COMMERCE 1-24-2007.

CLASS 9—(Continued).

3,314,551. FLUID IMAGING TECHNOLOGIES, INC., EDGE-COMB, ME. SN 78-874,015. PUB. 12-19-2006, FILED 5-2-2006.

PETROCAM

THE MARK CONSISTS OF STANDARD CHARACTERS WITHOUT CLAIM TO ANY PARTICULAR FONT, STYLE, SIZE, OR COLOR.

FOR FLUID IMAGING DEVICES CONSISTING OF SPECIALIZED OPTICS, VIDEO CAMERAS, MICROSCOPES, COMPUTER SOFTWARE, AND COMPUTER, USED TO COUNT, IMAGE, MEASURE, PHOTOGRAPH AND DIGITALLY RECORD AND PRESERVE IMAGES OF INDIVIDUAL CELLS, PARTICLES, AND DROPLETS (U.S. CLS. 21, 23, 26, 36 AND 38).
FIRST USE 4-30-2007; IN COMMERCE 4-30-2007.

3,314,553. AMPHENOL CORPORATION, WALLINGFORD, CT. SN 78-874,606. PUB. 11-21-2006, FILED 5-2-2006.

eHSD

THE MARK CONSISTS OF STANDARD CHARACTERS WITHOUT CLAIM TO ANY PARTICULAR FONT, STYLE, SIZE, OR COLOR.

FOR ELECTRICAL CONNECTORS (U.S. CLS. 21, 23, 26, 36 AND 38).
FIRST USE 8-31-2006; IN COMMERCE 11-21-2006.

3,314,562. SONY COMPUTER ENTERTAINMENT AMERICA INC., FOSTER CITY, CA. SN 78-877,649. PUB. 9-5-2006, FILED 5-5-2006.

THE END BEGINS

THE MARK CONSISTS OF STANDARD CHARACTERS WITHOUT CLAIM TO ANY PARTICULAR FONT, STYLE, SIZE, OR COLOR.

FOR COMPUTER GAME SOFTWARE AND VIDEO GAME SOFTWARE (U.S. CLS. 21, 23, 26, 36 AND 38).
FIRST USE 3-13-2007; IN COMMERCE 3-13-2007.

CLASS 9—(Continued).

3,314,567. WMS GAMING INC., WAUKEGAN, IL. SN 78-878,979. PUB. 9-12-2006, FILED 5-8-2006.

GRECIAN GOLD

THE MARK CONSISTS OF STANDARD CHARACTERS WITHOUT CLAIM TO ANY PARTICULAR FONT, STYLE, SIZE, OR COLOR.

FOR GAMING MACHINES (U.S. CLS. 21, 23, 26, 36 AND 38).
FIRST USE 9-12-2005; IN COMMERCE 9-12-2005.

3,314,575. DYNAVOX SYSTEMS LLC, PITTSBURGH, PA. SN 78-880,214. PUB. 1-2-2007, FILED 5-10-2006.

INTERAACT

THE MARK CONSISTS OF STANDARD CHARACTERS WITHOUT CLAIM TO ANY PARTICULAR FONT, STYLE, SIZE, OR COLOR.

FOR GRAPHICAL USER INTERFACE SOFTWARE, NAMELY, SOFTWARE FOR AUGMENTATIVE AND ALTERNATIVE COMMUNICATIONS SOLUTIONS FOR AIDING THE SPEECH IMPAIRED (U.S. CLS. 21, 23, 26, 36 AND 38).
FIRST USE 2-1-2007; IN COMMERCE 2-1-2007.

3,314,612. WALTON CHAINTECH CORPORATION, TAIPEI COUNTY, TAIWAN. SN 78-889,456. PUB. 12-26-2006, FILED 5-22-2006.

APOGEE

THE MARK CONSISTS OF HIGHLY STYLIZED WORD "APOGEE" HAVING A PAIR OF CUSPS ON OPPOSING SIDES OF THE "O" AT THE TOP AND BOTTOM OF THE "O".

FOR MEMORY STORAGE DEVICES, NAMELY, RANDOM ACCESS MEMORY CARDS, RANDOM ACCESS MEMORY MODULES, FLASH MEMORY CARDS AND FLASH MEMORY MODULES; MEMORY STICKS, NAMELY, MOBILE HARD DISC DRIVES FOR COMPUTERS; CARD READERS, NAMELY, ELECTRONIC CARD READERS, CHIP CARD READERS, FLASH MEMORY CARD READERS (U.S. CLS. 21, 23, 26, 36 AND 38).

FIRST USE 3-24-2006; IN COMMERCE 7-18-2006.

CLASS 9—(Continued).

3,314,631. WEBENERGY.NET, INC., NEW YORK, NY. SN 78-895,870. PUB. 2-6-2007, FILED 5-30-2006.

CLASS 9—(Continued).

3,314,638. TCI ACQUISITION CORP., NEW YORK, NY. SN 78-896,744. PUB. 12-26-2006, FILED 5-31-2006.

HOME JOULE

THE MARK CONSISTS OF STANDARD CHARACTERS WITHOUT CLAIM TO ANY PARTICULAR FONT, STYLE, SIZE, OR COLOR.

FOR DATA DISPLAY DEVICE, NAMELY, AN LCD SCREEN USING NUMBERS, TEXT, GRAPHICS, AND LED COLORS TO DISPLAY DATA RELATING TO HOURLY ENERGY PRICES, BUILDING OR APARTMENT ENERGY USAGE, POSSIBLE ENERGY SHORTAGES, AND THE PRESENCE OF INCENTIVES FOR RESPONSIBLE ENERGY USAGE, TO HELP CONSUMERS MAKE INFORMED DECISIONS ABOUT PERSONAL OR BUSINESS ENERGY USAGE (U.S. CLS. 21, 23, 26, 36 AND 38).

FIRST USE 11-2-2006; IN COMMERCE 11-2-2006.

LicenseHQ

THE MARK CONSISTS OF STANDARD CHARACTERS WITHOUT CLAIM TO ANY PARTICULAR FONT, STYLE, SIZE, OR COLOR.

FOR COMPUTER PROGRAMS FOR MANAGING BUSINESS LICENSES (U.S. CLS. 21, 23, 26, 36 AND 38).

FIRST USE 6-1-2006; IN COMMERCE 6-1-2006.

3,314,633. AUL, L.L.C., NAPA, CA. SN 78-896,066. PUB. 12-12-2006, FILED 5-30-2006.

PEARL

THE MARK CONSISTS OF STANDARD CHARACTERS WITHOUT CLAIM TO ANY PARTICULAR FONT, STYLE, SIZE, OR COLOR.

FOR COMPUTER SOFTWARE FOR USE IN DATABASE MANAGEMENT FOR THE ADMINISTRATION OF VEHICLE SERVICE CONTRACTS (U.S. CLS. 21, 23, 26, 36 AND 38).

FIRST USE 5-18-2006; IN COMMERCE 5-18-2006.

3,314,642. CUMMINGS, WILLIAM DENNIS, WHITE CITY, OR. SN 78-897,301. PUB. 3-13-2007, FILED 5-31-2006.

3,314,637. MICROSOLVED, INC., COLUMBUS, OH. SN 78-896,620. PUB. 1-2-2007, FILED 5-31-2006.

THE ILLUMINOIDS**HoneyPoint Security Server**

THE MARK CONSISTS OF STANDARD CHARACTERS WITHOUT CLAIM TO ANY PARTICULAR FONT, STYLE, SIZE, OR COLOR.

NO CLAIM IS MADE TO THE EXCLUSIVE RIGHT TO USE "SECURITY SERVER", APART FROM THE MARK AS SHOWN.

FOR COMPUTER SOFTWARE FOR THE PURPOSE OF MONITORING NETWORK SECURITY (U.S. CLS. 21, 23, 26, 36 AND 38).

FIRST USE 4-8-2006; IN COMMERCE 6-19-2006.

THE MARK CONSISTS OF STANDARD CHARACTERS WITHOUT CLAIM TO ANY PARTICULAR FONT, STYLE, SIZE, OR COLOR.

FOR PRERECORDED CD'S AND PHONOGRAPH RECORDS FEATURING MUSIC (U.S. CLS. 21, 23, 26, 36 AND 38).

FIRST USE 1-16-2001; IN COMMERCE 6-24-2001.

CLASS 9—(Continued).

3,314,652. MARKEY'S VIDEO IMAGES, LLC, INDIANAPOLIS, IN. SN 78-899,363. PUB. 12-26-2006, FILED 6-2-2006.

CLASS 9—(Continued).

3,314,673. GUITAR CENTER, INC., WESTLAKE VILLAGE, CA. SN 78-903,541. PUB. 4-3-2007, FILED 6-8-2006.

SENSORYTECHNOLOGIES

THE MARK CONSISTS OF STANDARD CHARACTERS WITHOUT CLAIM TO ANY PARTICULAR FONT, STYLE, SIZE, OR COLOR.

FOR AUDIO VISUAL EQUIPMENT AND VIDEO CONFERRING SYSTEMS COMPRISING AMPLIFIERS, SPEAKERS, PROJECTORS, PROJECTION SCREENS, REMOTE CONTROL UNITS, TRANSMITTERS, RECEIVERS, COMPRESSORS, CODERS, DECODERS, TELEVISIONS, LCD SCREENS, COMPUTERS, CABINETS, MONITORS, MICROPHONES, TRANSFORMERS, CAMERAS, MIXERS, DVD/VCRS, WIRES, CABLES, SWITCHERS, PLASMA DISPLAYS, COMPUTER INTERFACES, VIDEO SCAN CONVERTERS AND SCALERS, TOUCH PANELS, DIGITAL SIGNAL PROCESSORS, VIDEO/AUDIO SERVERS, WEB-BASED STREAMING ENCODERS AND SERVERS, MEDIA DISTRIBUTION AND RETRIEVAL SYSTEMS, COMPRISED OF WIRES, SWITCHES, CABLES, COMPUTER HARDWARE AND OPERATING SOFTWARE (U.S. CLS. 21, 23, 26, 36 AND 38).

FIRST USE 3-15-2006; IN COMMERCE 3-15-2006.

HARBINGER

THE MARK CONSISTS OF STANDARD CHARACTERS WITHOUT CLAIM TO ANY PARTICULAR FONT, STYLE, SIZE, OR COLOR.

FOR ELECTRIC SOUND EQUIPMENT, NAMELY, APPARATUS AND INSTRUMENTS FOR RECORDING, TRANSMISSION, RECEPTION, PROCESSING, RETRIEVAL, REPRODUCTION AND MANIPULATION OF SOUND AND/OR AUDIO SIGNALS AND EFFECTS; ACTIVE DIRECT INPUT BOXES; DYNAMIC DIGITAL AND ANALOG SIGNAL PROCESSORS; AMPLIFIERS; POWER AMPLIFIERS FOR CREATING EFFECTS; KEYBOARD AMPLIFIERS; CONVERTERS, ELECTRIC SIGNAL CONVERTERS; CROSSOVERS; GRAPHIC AND PARAMETRIC EQUALIZERS; MICROPHONES; MICROPHONE PREAMPLIFIERS; SOUND EFFECTS PEDALS FOR MUSICAL INSTRUMENTS; BASS AMPLIFIERS; MODELING AMPLIFIERS; AUDIO MIXING CONSOLES; MASTER AUDIO MIXING DESKS FOR USE IN AN AUDIO RECORDING STUDIO; ELECTRONIC MUSICAL RECORDING APPARATUS; ELECTRICAL SOUND ADAPTION APPARATUS FOR USE WITH MUSICAL INSTRUMENTS; SOUND AMPLIFIERS FOR MUSICAL INSTRUMENTS AND PARTS AND FITTINGS THEREOF; APPARATUS FOR RECORDING SOUND ON DIGITAL AND MAGNETIC DISCS AND/OR TAPES; COMPACT DISCS CONTAINING RECORDED MUSIC, SOUND LIBRARIES AND SOFTWARE PROGRAMS FOR CREATING DIGITAL AUDIO FILES IN THE FIELD OF MUSIC PRODUCTION; PRE-RECORDED RECORDING MEDIA FOR AUDIO SIGNALS, NAMELY CDS, CD-ROMS, DVD-ROMS AND HARD DISKS FEATURING SOUND FILES, SOUND LOOPS AND MUSIC; DJ APPARATUS, NAMELY TURNTABLES, COMPACT DISC PLAYERS AND MP3 PLAYERS; SIGNAL DISTRIBUTION DEVICES NAMELY, PATCHBAYS AND DIGITAL CLOCK DISTRIBUTION DEVICES; CONTROL APPARATUS FOR AUDIO SIGNALS, NAMELY CONTROL SURFACE HARDWARE; AUDIO DATA PROCESSORS NAMELY SURROUND PROCESSORS; HEADPHONES; AUDIO SPEAKERS; HEADPHONE AMPLIFIERS; LOUDSPEAKERS AND LOUDSPEAKER SYSTEMS; STUDIO AUDIO MONITORS; GUITAR MICROPHONES AND AMPLIFIERS; ELECTRONIC COMPONENTS FOR ELECTRIC GUITARS; ELECTRIC LIGHTING APPARATUS, NAMELY LIGHTING CONTROLLERS CONSISTING OF THE FOLLOWING EITHER INDIVIDUALLY OR AS A COMPONENT OF SUCH CONTROLLERS— DIMMER SWITCHES, ON/OFF SWITCHES, SEQUENCERS AND TIMERS, AND DIMMER PACKS; COMPUTER PROGRAMS FOR EDUCATIONAL USE FOR TEACHING MUSIC AND INSTRUCTIONAL MANUALS SOLD AS A UNIT THEREWITH; AND ELECTRONIC PUBLICATIONS RECORDED ON COMPUTER MEDIA AND DOWNLOADABLE ELECTRONIC PUBLICATIONS IN THE NATURE OF MANUALS, BROCHURES, SPECIFICATION SHEETS AND MAGAZINES IN THE FIELD OF MUSIC (U.S. CLS. 21, 23, 26, 36 AND 38).

FIRST USE 2-15-2007; IN COMMERCE 2-15-2007.

3,314,667. FOCUS ON THE FAMILY, COLORADO SPRINGS, CO. SN 78-902,430. PUB. 1-9-2007, FILED 6-7-2006.

Love Won Out

THE MARK CONSISTS OF STANDARD CHARACTERS WITHOUT CLAIM TO ANY PARTICULAR FONT, STYLE, SIZE, OR COLOR.

OWNER OF U.S. REG. NOS. 2,404,009, 2,460,450, AND 2,481,568.

FOR PRE-RECORDED DVDS FEATURING TOPICS RELATING TO HOMOSEXUALITY (U.S. CLS. 21, 23, 26, 36 AND 38).

FIRST USE 9-23-2006; IN COMMERCE 9-23-2006.

CLASS 9—(Continued).

3,314,679. INNOVATIVE WIRELESS TECHNOLOGIES, INC., FOREST, VA. SN 78-905,597. PUB. 1-16-2007, FILED 6-12-2006.

MPROM

THE MARK CONSISTS OF STANDARD CHARACTERS WITHOUT CLAIM TO ANY PARTICULAR FONT, STYLE, SIZE, OR COLOR.

FOR ELECTRONIC COMPONENTS, NAMELY, WIRELESS RADIO TRANSCEIVER MODULES (U.S. CLS. 21, 23, 26, 36 AND 38).

FIRST USE 12-6-2006; IN COMMERCE 12-6-2006.

3,314,680. SUN OPTICS, INC., SALT LAKE CITY, UT. SN 78-905,913. PUB. 11-7-2006, FILED 6-12-2006.



FOR OPTICAL GOODS, NAMELY, READING GLASSES, MAGNIFYING GLASSES, OPTICAL FRAMES, EYEGGLASS CASES, EYEGGLASS CORDS (U.S. CLS. 21, 23, 26, 36 AND 38).

FIRST USE 10-20-2006; IN COMMERCE 10-20-2006.

3,314,685. LASERUS, INC., EAGLE POINT, OR. SN 78-906,747. PUB. 1-23-2007, FILED 6-13-2006.

LASERUS

THE MARK CONSISTS OF STANDARD CHARACTERS WITHOUT CLAIM TO ANY PARTICULAR FONT, STYLE, SIZE, OR COLOR.

FOR LASERS NOT FOR MEDICAL USE (U.S. CLS. 21, 23, 26, 36 AND 38).

FIRST USE 12-7-2006; IN COMMERCE 12-7-2006.

CLASS 9—(Continued).

3,314,697. ROYAL WEST SALES, INC., WOODLAND HILLS, CA. SN 78-909,852. PUB. 2-13-2007, FILED 6-16-2006.

MUSICDOCK

THE MARK CONSISTS OF STANDARD CHARACTERS WITHOUT CLAIM TO ANY PARTICULAR FONT, STYLE, SIZE, OR COLOR.

FOR CONSUMER ELECTRONICS, NAMELY, STEREO, RADIOS, TELEVISIONS AND DVD PLAYERS CONTAINING DOCKING UNITS FOR MP3 PLAYERS (U.S. CLS. 21, 23, 26, 36 AND 38).

FIRST USE 4-30-2007; IN COMMERCE 4-30-2007.

3,314,707. FOOT LEVELERS, INC., ROANOKE, VA. SN 78-912,555. PUB. 4-10-2007, FILED 6-20-2006.

ASSOCIATE PLATINUM

THE MARK CONSISTS OF STANDARD CHARACTERS WITHOUT CLAIM TO ANY PARTICULAR FONT, STYLE, SIZE, OR COLOR.

FOR DIGITAL SCANNING APPARATUS FOR OBTAINING AN IMAGE OF A PERSON'S FOOT TO OBTAIN MEASUREMENTS FOR MAKING CUSTOM ORTHOTICS (U.S. CLS. 21, 23, 26, 36 AND 38).

FIRST USE 8-1-2006; IN COMMERCE 8-1-2006.

CLASS 9—(Continued).

3,314,714. LI, DONGQING, SHENZHEN CITY, CHINA. SN 78-915,080. PUB. 1-23-2007, FILED 6-22-2006.



THE COLOR(S) RED IS/ARE CLAIMED AS A FEATURE OF THE MARK.

THE MARK CONSISTS OF THE WORD "HOWA" IN RED. FOR COMPUTER PERIPHERALS; ELECTRONIC DICTIONARIES; HANDHELD COMPUTERS; ELECTRONIC CARD READERS; MAGNETIC CODED CARD READERS; COMPUTERS; BLANK SMART CARDS; WORD PROCESSORS; VIDEO OUTPUT GAME MACHINES FOR USE WITH TELEVISIONS; MP4 PLAYERS; APPARATUS FOR SPEECH RECORDING AND REPLAYING; CD PLAYERS; RADIOS; AUDIOVISUAL TEACHING APPARATUS, NAMELY, DVD PLAYERS, OVERHEAD PROJECTORS, AMPLIFIERS, SPEAKERS, LOUDSPEAKERS; TELEPHONES; MOBILE TELEPHONES; ELECTRONIC AND OPTICAL COMMUNICATIONS INSTRUMENTS AND COMPONENTS, NAMELY, OPTICAL TRANSMITTERS, OPTICAL RECEIVERS, OPTICAL DATA LINKS; COMPUTER NETWORK ADAPTERS; COMPUTER NETWORK HUBS, SWITCHES AND ROUTERS; PERSONAL STEREOs; TAPE RECORDERS; SOUND MIXERS; EAR PLUGS NOT FOR MEDICAL PURPOSES; CAMCORDERS; PHOTOGRAPHIC CAMERAS; TELESCOPES; MICROSCOPES; ELECTRIC WIRES; ELECTRIC CABLES; BATTERY CHARGERS; BATTERIES (U.S. CLS. 21, 23, 26, 36 AND 38).

FIRST USE 9-1-2007; IN COMMERCE 9-1-2007.

3,314,770. HOMAC MFG. COMPANY, ORMOND BEACH, FL. SN 78-934,766. PUB. 3-20-2007, FILED 7-21-2006.

EZ TORQUE

THE MARK CONSISTS OF STANDARD CHARACTERS WITHOUT CLAIM TO ANY PARTICULAR FONT, STYLE, SIZE, OR COLOR.

OWNER OF U.S. REG. NOS. 2,781,731 AND 2,839,291.

NO CLAIM IS MADE TO THE EXCLUSIVE RIGHT TO USE "TORQUE", APART FROM THE MARK AS SHOWN.

FOR ELECTRICAL APPARATUS, NAMELY, ELECTRICAL CONNECTORS FOR USE IN CONNECTION WITH POWER CABLES AND POWER DISTRIBUTION TRANSFORMERS, ALL FOR USE BY ELECTRIC UTILITIES (U.S. CLS. 21, 23, 26, 36 AND 38).

FIRST USE 12-0-2006; IN COMMERCE 12-0-2006.

CLASS 9—(Continued).

3,314,771. DANA INNOVATIONS, SAN CLEMENTE, CA. SN 78-935,230. PUB. 3-20-2007, FILED 7-21-2006.

Sonance Architectural Series

THE MARK CONSISTS OF STANDARD CHARACTERS WITHOUT CLAIM TO ANY PARTICULAR FONT, STYLE, SIZE, OR COLOR.

OWNER OF U.S. REG. NOS. 1,429,672, 2,568,351, AND 2,931,842.

NO CLAIM IS MADE TO THE EXCLUSIVE RIGHT TO USE "ARCHITECTURAL SERIES", APART FROM THE MARK AS SHOWN.

SEC. 2(F) SONANCE.

FOR AUDIO EQUIPMENT, NAMELY, LOUDSPEAKERS, IN-WALL SPEAKERS, IN-CEILING SPEAKERS, VOLUME CONTROLLERS, AUDIO SWITCHES, AUDIO AMPLIFIERS AND AUDIO CABLES (U.S. CLS. 21, 23, 26, 36 AND 38).

FIRST USE 11-28-2006; IN COMMERCE 11-28-2006.

3,314,775. LI, JINTAI, DONGGUAN, CHINA. SN 78-935,613. PUB. 3-6-2007, FILED 7-24-2006.

BKELL

THE MARK CONSISTS OF STANDARD CHARACTERS WITHOUT CLAIM TO ANY PARTICULAR FONT, STYLE, SIZE, OR COLOR.

FOR AMPLIFIERS; AUDIO SPEAKERS; BURGLAR ALARMS; COMPUTER PERIPHERALS; ELECTRICAL WIRES; LOUDSPEAKERS; RADIO RECEIVERS; REMOTE CONTROLS FOR RADIOS, TELEVISIONS, STEREOs, OR SPEAKERS; THEFT ALARMS (U.S. CLS. 21, 23, 26, 36 AND 38).

FIRST USE 5-3-2007; IN COMMERCE 6-6-2007.

3,314,780. WOODFORD INDUSTRIES, INC., LOS ANGELES, CA. SN 78-939,320. PUB. 3-27-2007, FILED 7-27-2006.

Sudden Stop

THE MARK CONSISTS OF STANDARD CHARACTERS WITHOUT CLAIM TO ANY PARTICULAR FONT, STYLE, SIZE, OR COLOR.

FOR EMERGENCY WARNING LIGHTS (U.S. CLS. 21, 23, 26, 36 AND 38).

FIRST USE 11-1-2006; IN COMMERCE 11-1-2006.

CLASS 9—(Continued).

3,314,795. CABOT SAFETY INTERMEDIATE CORPORATION, NEWARK, DE. SN 78-942,229. PUB. 1-16-2007, FILED 8-1-2006.

KINETIC

THE MARK CONSISTS OF STANDARD CHARACTERS WITHOUT CLAIM TO ANY PARTICULAR FONT, STYLE, SIZE, OR COLOR.

FOR FALL PROTECTION EQUIPMENT FOR FALL RESTRAINT AND FALL ARREST, NAMELY, HARNESSES, BARS, ANCHORS, LINES, LANYARDS, CARABINERS AND ANCHORAGE CONNECTORS (U.S. CLS. 21, 23, 26, 36 AND 38).

FIRST USE 8-0-2006; IN COMMERCE 8-0-2006.

3,314,807. ZENITH ELECTRONICS CORPORATION, LINCOLNSHIRE, IL. SN 78-947,829. PUB. 4-3-2007, FILED 8-8-2006.

PRO:IDIOM

THE MARK CONSISTS OF STANDARD CHARACTERS WITHOUT CLAIM TO ANY PARTICULAR FONT, STYLE, SIZE, OR COLOR.

FOR ELECTRONIC EQUIPMENT FOR USE IN THE ENCRYPTION AND DECRYPTION OF TELEVISION SIGNALS (U.S. CLS. 21, 23, 26, 36 AND 38).

FIRST USE 8-31-2006; IN COMMERCE 8-31-2006.

3,314,812. BLK ENTERPRISES, LLC, GREEN POND, NJ. SN 78-949,446. PUB. 4-3-2007, FILED 8-10-2006.

CellBlock

THE MARK CONSISTS OF STANDARD CHARACTERS WITHOUT CLAIM TO ANY PARTICULAR FONT, STYLE, SIZE, OR COLOR.

FOR PROTECTIVE SANITARY COVERS FOR PERSONAL ELECTRONIC DEVICES (U.S. CLS. 21, 23, 26, 36 AND 38).

FIRST USE 4-30-2006; IN COMMERCE 8-27-2006.

CLASS 9—(Continued).

3,314,841. DANA INNOVATIONS, SAN CLEMENTE, CA. SN 78-956,806. PUB. 3-20-2007, FILED 8-21-2006.



OWNER OF U.S. REG. NOS. 1,429,672, 2,568,351, AND 2,931,842.

SEC. 2(F) AS TO "SONANCE".

FOR AUDIO EQUIPMENT, NAMELY, LOUDSPEAKERS, IN-WALL SPEAKERS, IN-CEILING SPEAKERS, INDOOR/OUTDOOR SPEAKERS, WATERPROOF SPEAKERS, PLANAR DRIVER SPEAKERS, WOOFERS AND SUBWOOFERS, DOCKING STATIONS FOR CONNECTING HOUSEHOLD AUDIO/VIDEO PLAYERS TO INSTALLED AUDIO/VIDEO EQUIPMENT, AUDIO VOLUME CONTROLLERS, MULTI-ROOM AUDIO SYSTEM CONTROLLERS, AUDIO SWITCHES, AUDIO AMPLIFIERS, AUDIO/VIDEO CABLES, AND SPEAKER JACKS (U.S. CLS. 21, 23, 26, 36 AND 38).

FIRST USE 12-1-2006; IN COMMERCE 12-1-2006.

3,314,853. QUANTUM3D, SAN JOSE, CA. SN 78-959,770. PUB. 3-13-2007, FILED 8-24-2006.

FARSIGHT

THE MARK CONSISTS OF STANDARD CHARACTERS WITHOUT CLAIM TO ANY PARTICULAR FONT, STYLE, SIZE, OR COLOR.

OWNER OF U.S. REG. NO. 2,766,323.

FOR VIDEO DISPLAY DEVICES, NAMELY, HAND-HELD, HEAD-MOUNTED OR VEHICLE-MOUNTED VIDEO DISPLAYS (U.S. CLS. 21, 23, 26, 36 AND 38).

FIRST USE 1-10-2007; IN COMMERCE 1-10-2007.

CLASS 9—(Continued).

3,314,859. CABOT SAFETY INTERMEDIATE CORPORATION, NEWARK, DE. SN 78-962,600. PUB. 1-16-2007, FILED 8-29-2006.

ELAVATION

THE MARK CONSISTS OF STANDARD CHARACTERS WITHOUT CLAIM TO ANY PARTICULAR FONT, STYLE, SIZE, OR COLOR.

FOR FALL PROTECTION EQUIPMENT FOR FALL RESTRAINT AND FALL ARREST, NAMELY, HARNESSES, BARS, ANCHORS, LINES, LANYARDS, CARABINERS AND ANCHORAGE CONNECTORS (U.S. CLS. 21, 23, 26, 36 AND 38).

FIRST USE 5-0-2007; IN COMMERCE 5-0-2007.

3,314,867. SOLIDSCAPE, INC., MERRIMACK, NH. SN 78-965,663. PUB. 4-10-2007, FILED 9-1-2006.

R66

THE MARK CONSISTS OF STANDARD CHARACTERS WITHOUT CLAIM TO ANY PARTICULAR FONT, STYLE, SIZE, OR COLOR.

OWNER OF U.S. REG. NOS. 2,774,050 AND 2,776,667.

FOR COMPUTER AIDED DESIGN MODELING AND PATTERN MAKING APPARATUS COMPRISED OF COMPUTER HARDWARE AND SOFTWARE FOR MAKING HIGH PRECISION 3-D PROTOTYPE MODELS USED IN THE INDUSTRIAL AND CONSUMER FIELDS (U.S. CLS. 21, 23, 26, 36 AND 38).

FIRST USE 2-23-2007; IN COMMERCE 2-23-2007.

3,314,871. CUSTOM GAME DESIGN, INC., PLANO, TX. SN 78-966,716. PUB. 1-2-2007, FILED 9-4-2006.

HOT LUCK KENO

THE MARK CONSISTS OF STANDARD CHARACTERS WITHOUT CLAIM TO ANY PARTICULAR FONT, STYLE, SIZE, OR COLOR.

NO CLAIM IS MADE TO THE EXCLUSIVE RIGHT TO USE "KENO", APART FROM THE MARK AS SHOWN.

FOR GAMING DEVICES, NAMELY, GAMING MACHINES, SLOT MACHINES, BINGO MACHINES, WITH OR WITHOUT VIDEO OUTPUT; VIDEO GAME SOFTWARE (U.S. CLS. 21, 23, 26, 36 AND 38).

FIRST USE 10-1-2006; IN COMMERCE 10-1-2006.

CLASS 9—(Continued).

3,314,882. INTEGRATION ASSOCIATES INC., MOUNTAIN VIEW, CA. SN 78-969,479. PUB. 4-3-2007, FILED 9-7-2006.

EZSWITCHER

THE MARK CONSISTS OF STANDARD CHARACTERS WITHOUT CLAIM TO ANY PARTICULAR FONT, STYLE, SIZE, OR COLOR.

FOR SEMICONDUCTORS, SEMICONDUCTOR CHIPS, SEMICONDUCTOR DEVICES, SEMICONDUCTOR POWER ELEMENTS, ELECTRONIC INTEGRATED CIRCUITS, INTEGRATED CIRCUIT MODULE, INTEGRATED CIRCUITS, LARGE SCALE INTEGRATED CIRCUITS, CIRCUIT BOARDS PROVIDED WITH INTEGRATED CIRCUITS, PRINTED ELECTRONIC CIRCUITS FOR APPARATUS AND CARDS BEARING INTEGRATED CIRCUITS (U.S. CLS. 21, 23, 26, 36 AND 38).

FIRST USE 7-1-2007; IN COMMERCE 7-1-2007.

3,314,890. DESIGN MANUFACTURE DISTRIBUTION, LLC, ST. LOUIS, MO. SN 78-971,613. PUB. 11-21-2006, FILED 9-11-2006.



THE MARK CONSISTS OF A STYLIZED K FOLLOWED BY THE LETTERS ITCHRICS.

FOR SCALES; THERMOMETERS; TIMERS (U.S. CLS. 21, 23, 26, 36 AND 38).

FIRST USE 2-20-2007; IN COMMERCE 2-20-2007.

CLASS 10—MEDICAL APPARATUS

3,313,068. EARIGATE INC., OAKVILLE, ONATRIO, CANADA. SN 76-607,347. PUB. 9-12-2006, FILED 8-17-2004.

EARIGATE

THE MARK CONSISTS OF STANDARD CHARACTERS WITHOUT CLAIM TO ANY PARTICULAR FONT, STYLE, SIZE, OR COLOR.

FOR MEDICAL DEVICE, NAMELY, A BOTTLE WITH AN APPLICATOR AT ITS END, CONTAINING SALINE SOLUTION, FOR USE IN REMOVING CERUMEN FROM THE EAR CANAL (U.S. CLS. 26, 39 AND 44).

FIRST USE 4-30-2007; IN COMMERCE 4-30-2007.

CLASS 10—(Continued).

3,313,079. SCHAEERER MAYFIELD USA, INC., CINCINNATI, OH. SN 76-616,101. PUB. 2-21-2006, FILED 10-15-2004.

NEUROMATE

THE MARK CONSISTS OF STANDARD CHARACTERS WITHOUT CLAIM TO ANY PARTICULAR FONT, STYLE, SIZE, OR COLOR.

FOR MEDICAL ROBOTIC SURGICAL APPARATUS USED FOR SURGICAL PROCEDURES, NAMELY, ROBOTIC ARMS, CUTTING INSTRUMENTS, AND INSTRUMENT HOLDERS (U.S. CLS. 26, 39 AND 44).
FIRST USE 12-0-1997; IN COMMERCE 12-0-1997.

CLASS 10—(Continued).

3,313,195. CAS MEDICAL SYSTEMS, INC., BRANFORD, CT. SN 76-656,020. PUB. 11-14-2006, FILED 3-3-2006.

FORE-SIGHT

THE MARK CONSISTS OF STANDARD CHARACTERS WITHOUT CLAIM TO ANY PARTICULAR FONT, STYLE, SIZE, OR COLOR.

FOR MEDICAL APPARATUS, NAMELY, CEREBRAL OXIMETER FOR NON-INVASIVE PATIENT MONITORING (U.S. CLS. 26, 39 AND 44).
FIRST USE 1-0-2007; IN COMMERCE 1-0-2007.

3,313,111. CRYOCATH TECHNOLOGIES INC., CANADA. SN 76-634,171. PUB. 2-14-2006, FILED 3-23-2005.

FLEXCATH

THE MARK CONSISTS OF STANDARD CHARACTERS WITHOUT CLAIM TO ANY PARTICULAR FONT, STYLE, SIZE, OR COLOR.

FOR SURGICAL APPARATUS AND INSTRUMENTS, NAMELY, CRYOSURGICAL BALLOON CATHETERS, INTRODUCER CATHETERS, AND COOLING CONSOLES (U.S. CLS. 26, 39 AND 44).
FIRST USE 6-22-2005; IN COMMERCE 6-22-2005.

3,313,198. FLOWCARDIA, INC., SUNNYVALE, CA. SN 76-656,589. PUB. 10-24-2006, FILED 3-14-2006.

THE CROSSER

THE MARK CONSISTS OF STANDARD CHARACTERS WITHOUT CLAIM TO ANY PARTICULAR FONT, STYLE, SIZE, OR COLOR.

FOR MEDICAL DEVICES, NAMELY CARDIOVASCULAR CATHETERS (U.S. CLS. 26, 39 AND 44).
FIRST USE 2-27-2007; IN COMMERCE 4-19-2007.

3,313,146. MINNESOTA SCIENTIFIC, INC., ST. PAUL, MN. SN 76-641,740. PUB. 12-12-2006, FILED 6-27-2005.

OMNI-BRIGHT

THE MARK CONSISTS OF STANDARD CHARACTERS WITHOUT CLAIM TO ANY PARTICULAR FONT, STYLE, SIZE, OR COLOR.

OWNER OF U.S. REG. NOS. 1,325,588, 2,979,838, AND OTHERS.
FOR MEDICAL APPARATUS, NAMELY, SURGICAL LAMPS (U.S. CLS. 26, 39 AND 44).
FIRST USE 2-1-2006; IN COMMERCE 2-1-2006.

3,313,202. THERAPEUTICS:101 INC., TINTON FALLS, NJ. SN 76-658,486. PUB. 1-30-2007, FILED 4-17-2006.

PRESSURE RIGHT

THE MARK CONSISTS OF STANDARD CHARACTERS WITHOUT CLAIM TO ANY PARTICULAR FONT, STYLE, SIZE, OR COLOR.

NO CLAIM IS MADE TO THE EXCLUSIVE RIGHT TO USE "PRESSURE", APART FROM THE MARK AS SHOWN.

FOR APPARATUS FOR ACUPRESSURE THERAPY, NAMELY, AN ADHESIVELY SECURABLE ACUPRESSURE ANTI-NAUSEA DEVICE FOR HUMANS, DOGS AND CATS (U.S. CLS. 26, 39 AND 44).
FIRST USE 3-4-2007; IN COMMERCE 3-4-2007.

CLASS 10—(Continued).

3,313,246. IMPACT SPORTS TECHNOLOGIES INC., LAS VEGAS, NV. SN 77-002,672. PUB. 5-8-2007, FILED 9-19-2006.

ePulse

THE MARK CONSISTS OF STANDARD CHARACTERS WITHOUT CLAIM TO ANY PARTICULAR FONT, STYLE, SIZE, OR COLOR.

FOR HEART MONITORS TO BE WORN DURING EXERCISE; PULSE RATE MONITORS (U.S. CLS. 26, 39 AND 44).

FIRST USE 6-11-2007; IN COMMERCE 6-11-2007.

3,313,301. ZIMMER TECHNOLOGY, INC., WARSAW, IN. SN 77-027,317. PUB. 2-20-2007, FILED 10-23-2006.

KINECTIV

THE MARK CONSISTS OF STANDARD CHARACTERS WITHOUT CLAIM TO ANY PARTICULAR FONT, STYLE, SIZE, OR COLOR.

FOR ORTHOPEDIC JOINT PROSTHESIS NAMELY HIP PROSTHESIS UTILIZING A MODULAR NECK SYSTEM, INSTRUMENTS AND TOOLS FOR THE IMPLANTATION OF PROSTHESES AND PARTS OF PROSTHESIS (U.S. CLS. 26, 39 AND 44).

FIRST USE 4-24-2007; IN COMMERCE 4-24-2007.

3,313,340. COOK INCORPORATED, BLOOMINGTON, IN. SN 77-074,169. PUB. 5-15-2007, FILED 1-2-2007.

ADVANCE

THE MARK CONSISTS OF STANDARD CHARACTERS WITHOUT CLAIM TO ANY PARTICULAR FONT, STYLE, SIZE, OR COLOR.

OWNER OF U.S. REG. NO. 3,170,090. FOR MEDICAL DEVICE, NAMELY, A VASCULAR BALLOON CATHETER (U.S. CLS. 26, 39 AND 44).

FIRST USE 8-0-2005; IN COMMERCE 8-0-2005.

CLASS 10—(Continued).

3,313,359. SIEMENS MEDICAL SOLUTIONS USA, INC., MALVERN, PA. SN 78-171,333. PUB. 1-6-2004, FILED 10-4-2002.

OPTIGARD

FOR LASER TRIANGULATION DEVICE, NAMELY, LASERS FOR USE IN CONNECTION WITH RADIOTHERAPY MACHINES TO DETECT COLLISIONS BETWEEN THE MACHINE AND THE PATIENT (U.S. CLS. 26, 39 AND 44).

FIRST USE 6-0-2006; IN COMMERCE 6-0-2006.

3,313,381. MEDI-SCREW, INC., KNOXVILLE, TN. SN 78-255,665. PUB. 12-23-2003, FILED 5-29-2003.

MEDI-SCREW

FOR MEDICAL FASTENERS AND MEDICAL FASTENER APPLICATION SYSTEMS (U.S. CLS. 26, 39 AND 44).

FIRST USE 6-1-2006; IN COMMERCE 6-1-2006.

3,313,447. MODESITT, BRUCE D., SAN CARLOS, CA. SN 78-413,757. PUB. 9-5-2006, FILED 5-5-2004.

Arstasis

THE MARK CONSISTS OF STANDARD CHARACTERS WITHOUT CLAIM TO ANY PARTICULAR FONT, STYLE, SIZE, OR COLOR.

THE NAME ARSTASIS DOES NOT IDENTIFY A LIVING INDIVIDUAL.

FOR SURGICAL INSTRUMENTS, NAMELY, ARTERIAL ACCESS AND CLOSURE INSTRUMENTS AND LAPAROSCOPIC SURGICAL INSTRUMENTS (U.S. CLS. 26, 39 AND 44).

FIRST USE 4-17-2007; IN COMMERCE 4-17-2007.

CLASS 10—(Continued).

3,313,463. SONIC INNOVATIONS, INC., SALT LAKE CITY, UT. SN 78-438,038. PUB. 5-9-2006, FILED 6-18-2004.

INNOVA

THE MARK CONSISTS OF STANDARD CHARACTERS WITHOUT CLAIM TO ANY PARTICULAR FONT, STYLE, SIZE, OR COLOR.

OWNER OF U.S. REG. NO. 2,446,742.
FOR HEARING AIDS (U.S. CLS. 26, 39 AND 44).
FIRST USE 3-1-2005; IN COMMERCE 3-1-2005.

3,313,466. ALPHATEC MANUFACTURING, INC., CARLSBAD, CA. SN 78-443,315. PUB. 9-6-2005, FILED 6-29-2004.

NOVEL

THE MARK CONSISTS OF STANDARD CHARACTERS WITHOUT CLAIM TO ANY PARTICULAR FONT, STYLE, SIZE, OR COLOR.

FOR VERTEBRAL BODY REPLACEMENT DEVICES, NAMELY, IMPLANTS CONSISTING OF ARTIFICIAL MATERIALS (U.S. CLS. 26, 39 AND 44).
FIRST USE 10-7-2004; IN COMMERCE 1-13-2005.

CLASS 10—(Continued).

3,313,469. IOMED, INC., SALT LAKE CITY, UT. SN 78-447,256. PUB. 6-14-2005, FILED 7-7-2004.

OCUPHOR

THE MARK CONSISTS OF STANDARD CHARACTERS WITHOUT CLAIM TO ANY PARTICULAR FONT, STYLE, SIZE, OR COLOR.

FOR IONTOPHORETIC DRUG DELIVERY SYSTEMS COMPRISED OF IONTOPHORESIS ELECTRODES, DRUG RESERVOIRS AND/OR DRUG DELIVERY CONTROLLERS (U.S. CLS. 26, 39 AND 44).
FIRST USE 10-31-2006; IN COMMERCE 10-31-2006.

3,313,473. KENTUCKY PACKAGING SERVICE, L.P., SUN VALLEY, CA. SN 78-459,853. PUB. 6-14-2005, FILED 7-30-2004.

OLSEN

THE MARK CONSISTS OF STANDARD CHARACTERS WITHOUT CLAIM TO ANY PARTICULAR FONT, STYLE, SIZE, OR COLOR.

OWNER OF U.S. REG. NO. 1,836,684.
SEC. 2(F).
FOR SPINAL IMPLANTS AND PARTS THEREFOR (U.S. CLS. 26, 39 AND 44).
FIRST USE 4-0-2005; IN COMMERCE 4-0-2005.

CLASS 10—(Continued).

3,313,551. ABBOTT CARDIOVASCULAR SYSTEMS, INC., SANTA CLARA, CA. SN 78-549,481. PUB. 10-24-2006, FILED 1-18-2005.

CLASS 10—(Continued).

3,313,603. IMPACT SPORTS TECHNOLOGIES, INC., LAS VEGAS, NV. SN 78-589,002. PUB. 8-29-2006, FILED 3-17-2005.

WHISPER VIEW

Impact Sports

THE MARK CONSISTS OF STANDARD CHARACTERS WITHOUT CLAIM TO ANY PARTICULAR FONT, STYLE, SIZE, OR COLOR.

OWNER OF U.S. REG. NO. 2,815,395.
FOR MEDICAL GUIDEWIRES; CATHETERS; STENTS; DRUG DELIVERY SYSTEMS; HEART PACEMAKERS; PERIPHERAL DILATATION CATHETERS, PERIPHERAL GUIDEWIRES, PERIPHERAL GUIDING CATHETERS, INTRODUCER SHEATHS; AND ACCESSORIES FOR ALL THE ABOVE NAMELY GUIDEWIRE LEADS, GUIDEWIRE TIPS AND HEMOSTATIC VALVES (U.S. CLS. 26, 39 AND 44).

FIRST USE 11-27-2006; IN COMMERCE 11-27-2006.

THE MARK CONSISTS OF STANDARD CHARACTERS WITHOUT CLAIM TO ANY PARTICULAR FONT, STYLE, SIZE, OR COLOR.

NO CLAIM IS MADE TO THE EXCLUSIVE RIGHT TO USE "SPORTS", APART FROM THE MARK AS SHOWN.

FOR HEART RATE MONITORS TO BE WORN DURING EXERCISE SOLD AS A UNIT WITH SENSORS EMBEDDED IN GLOVES; ATHLETIC FITNESS MONITORING DEVICES COMPRISED OF SENSORS, BATTERIES, MICROPROCESSORS TO MEASURE AND DELIVER VIAL STATISTICS SUCH AS HEART RATE, CALORIC BURN, BLOOD OXYGEN, BLOOD PRESSURE AND HAND/FOOT OR LEG FORCE OR SPEED MEASUREMENT ALL EMBEDDED IN WRISTBANDS, GLOVES AND/OR AUDIO HEAD SETS TO BE WORN DURING EXERCISE (U.S. CLS. 26, 39 AND 44).

FIRST USE 3-1-2006; IN COMMERCE 3-1-2006.

3,313,574. CRAZY ACE, INC., PHOENIX, AZ. SN 78-573,401. PUB. 11-15-2005, FILED 2-23-2005.

3,313,622. STERLING MEDIVATIONS, INC., DBA SIMPLECHOICE, NORCROSS, GA. SN 78-602,733. PUB. 7-11-2006, FILED 4-6-2005.

DILGLOW

SIMPLECHOICE TWIST

THE MARK CONSISTS OF STANDARD CHARACTERS WITHOUT CLAIM TO ANY PARTICULAR FONT, STYLE, SIZE, OR COLOR.

NO CLAIM IS MADE TO THE EXCLUSIVE RIGHT TO USE "GLOW", APART FROM THE MARK AS SHOWN.

FOR GLASS SEXUAL AIDS FOR ADULT USE (U.S. CLS. 26, 39 AND 44).

FIRST USE 5-0-2005; IN COMMERCE 5-0-2005.

THE MARK CONSISTS OF STANDARD CHARACTERS WITHOUT CLAIM TO ANY PARTICULAR FONT, STYLE, SIZE, OR COLOR.

OWNER OF U.S. REG. NO. 2,688,667.

FOR MEDICAL DEVICES, NAMELY, NON-INVASIVE OR MINIMALLY INVASIVE MEDICAL DEVICES FOR DRUG INFUSION AND BODILY FLUID ASSAY; DRUG DELIVERY SYSTEMS (U.S. CLS. 26, 39 AND 44).

FIRST USE 6-10-2005; IN COMMERCE 9-1-2005.

CLASS 10—(Continued).

3,313,692. SYRVET, INC., WAUKEE, IA. SN 78-627,817. PUB. 1-24-2006, FILED 5-11-2005.

SYRFLEX

THE MARK CONSISTS OF STANDARD CHARACTERS WITHOUT CLAIM TO ANY PARTICULAR FONT, STYLE, SIZE, OR COLOR.
FOR ELASTIC BANDAGE (U.S. CLS. 26, 39 AND 44).
FIRST USE 4-17-2007; IN COMMERCE 4-17-2007.

3,313,718. BOSTON SCIENTIFIC SCIMED, INC., MAPLE GROVE, MN. SN 78-642,061. PUB. 10-10-2006, FILED 6-2-2005.

SOLOIST

THE MARK CONSISTS OF STANDARD CHARACTERS WITHOUT CLAIM TO ANY PARTICULAR FONT, STYLE, SIZE, OR COLOR.
FOR MEDICAL NEEDLE ELECTRODE FOR TISSUE ABLATION, NOT FOR USE IN THE FIELD OF ELECTROPHYSIOLOGY (U.S. CLS. 26, 39 AND 44).
FIRST USE 1-0-2006; IN COMMERCE 1-0-2006.

3,313,800. VERTIFLEX, INC., SAN CLEMENTE, CA. SN 78-676,595. PUB. 9-5-2006, FILED 7-22-2005.

Vertiflex

THE MARK CONSISTS OF STANDARD CHARACTERS WITHOUT CLAIM TO ANY PARTICULAR FONT, STYLE, SIZE, OR COLOR.
FOR SPINAL IMPLANTS CONSISTING OF ARTIFICIAL MATERIALS, SURGICAL INSTRUMENTS FOR THE IMPLANTATION OF SPINAL IMPLANTS, AND RELATED INSTRUCTIONAL MATERIALS AND DOCUMENTATION PROVIDED THEREWITH (U.S. CLS. 26, 39 AND 44).
FIRST USE 8-24-2005; IN COMMERCE 9-19-2006.

CLASS 10—(Continued).

3,313,840. CANNUFLOW, INC., SAN JOSE, CA. SN 78-698,782. PUB. 5-9-2006, FILED 8-23-2005.

EXTRAVASTAT

THE MARK CONSISTS OF STANDARD CHARACTERS WITHOUT CLAIM TO ANY PARTICULAR FONT, STYLE, SIZE, OR COLOR.
FOR A FEATURE OF SURGICAL INSTRUMENTS FOR USE IN ARTHROSCOPIC SURGERY (U.S. CLS. 26, 39 AND 44).
FIRST USE 6-28-2006; IN COMMERCE 6-28-2006.

3,313,867. HUOT INSTRUMENTS LLC, MENOMONEE FALLS, WI. SN 78-707,736. PUB. 5-16-2006, FILED 9-8-2005.

SEE THE LESION

THE MARK CONSISTS OF STANDARD CHARACTERS WITHOUT CLAIM TO ANY PARTICULAR FONT, STYLE, SIZE, OR COLOR.
FOR SURGICAL INSTRUMENTS FOR USE IN OBTAINING TISSUE BIOPSY SAMPLES (U.S. CLS. 26, 39 AND 44).
FIRST USE 1-10-2007; IN COMMERCE 1-10-2007.

3,313,892. ARIBEX, INC., OREM, UT. SN 78-715,540. PUB. 8-8-2006, FILED 9-19-2005.

ARIBEX

THE MARK CONSISTS OF STANDARD CHARACTERS WITHOUT CLAIM TO ANY PARTICULAR FONT, STYLE, SIZE, OR COLOR.
FOR X-RAY APPARATUS FOR PORTABLE USE, NAMELY, MEDICAL AND DENTAL X-RAY DIAGNOSTICS (U.S. CLS. 26, 39 AND 44).
FIRST USE 7-1-2005; IN COMMERCE 7-1-2005.

CLASS 10—(Continued).

3,313,894. FAIR ISAAC CORPORATION, MINNEAPOLIS, MN. SN 78-716,095. PUB. 10-31-2006, FILED 9-19-2005.

FASTPANEL

THE MARK CONSISTS OF STANDARD CHARACTERS WITHOUT CLAIM TO ANY PARTICULAR FONT, STYLE, SIZE, OR COLOR.

FOR ANIMAL PATHOGEN DIAGNOSTIC TECHNOLOGY, TEST KITS AND TEST PANELS (U.S. CLS. 26, 39 AND 44).

FIRST USE 10-0-2005; IN COMMERCE 10-0-2005.

3,313,910. ANSELL HEALTHCARE PRODUCTS LLC, RED BANK, NJ. SN 78-724,980. PUB. 6-6-2006, FILED 10-3-2005.

HYDRASOFT

THE MARK CONSISTS OF STANDARD CHARACTERS WITHOUT CLAIM TO ANY PARTICULAR FONT, STYLE, SIZE, OR COLOR.

FOR GLOVES FOR MEDICAL USE; LATEX MEDICAL GLOVES; SURGICAL GLOVES (U.S. CLS. 26, 39 AND 44).

FIRST USE 4-5-2007; IN COMMERCE 4-5-2007.

3,313,947. VISIONQUEST INDUSTRIES, INC., IRVINE, CA. SN 78-741,113. PUB. 11-21-2006, FILED 10-26-2005.

SURGISTIM 3
A T.E.A.R. Technology Product

OWNER OF U.S. REG. NOS. 2,746,498, 2,979,197, AND OTHERS.

NO CLAIM IS MADE TO THE EXCLUSIVE RIGHT TO USE "TECHNOLOGY PRODUCT", APART FROM THE MARK AS SHOWN.

FOR MEDICAL EQUIPMENT, NAMELY, A HANDHELD ELECTRONIC NERVE AND MUSCLE STIMULATOR; MEDICAL ELECTRODES AND LEAD WIRES FOR A HANDHELD ELECTRONIC NERVE AND MUSCLE STIMULATOR (U.S. CLS. 26, 39 AND 44).

FIRST USE 2-10-2006; IN COMMERCE 2-10-2006.

CLASS 10—(Continued).

3,314,015. ÖSSUR HF, 110 REYKJAVIK, ICELAND. SN 78-754,081. PUB. 10-3-2006, FILED 11-15-2005.

PROPRIO FOOT

THE MARK CONSISTS OF STANDARD CHARACTERS WITHOUT CLAIM TO ANY PARTICULAR FONT, STYLE, SIZE, OR COLOR.

NO CLAIM IS MADE TO THE EXCLUSIVE RIGHT TO USE "FOOT", APART FROM THE MARK AS SHOWN.

FOR ORTHOTICS AND PROSTHESES NAMELY ARTIFICIAL FEET AND PARTS THEREOF (U.S. CLS. 26, 39 AND 44).

FIRST USE 6-29-2006; IN COMMERCE 6-29-2006.

3,314,243. BSN MEDICAL, INC., CHARLOTTE, NC. SN 78-793,183. PUB. 9-19-2006, FILED 1-17-2006.

DELTA-DRY

THE MARK CONSISTS OF STANDARD CHARACTERS WITHOUT CLAIM TO ANY PARTICULAR FONT, STYLE, SIZE, OR COLOR.

OWNER OF U.S. REG. NOS. 2,200,073, 2,710,147, AND 2,837,166.

FOR ORTHOPEDIC CASTING PRODUCTS, NAMELY CAST PADDING (U.S. CLS. 26, 39 AND 44).

FIRST USE 2-15-2007; IN COMMERCE 4-1-2007.

3,314,255. COMEDICA INCORPORATED, DALLAS, TX. SN 78-795,043. PUB. 9-5-2006, FILED 1-19-2006.

METANEB

THE MARK CONSISTS OF STANDARD CHARACTERS WITHOUT CLAIM TO ANY PARTICULAR FONT, STYLE, SIZE, OR COLOR.

FOR RESPIRATORY MEDICAL APPARATUS, NAMELY NEBULIZERS AND PARTS AND ATTACHMENTS THEREFORE (U.S. CLS. 26, 39 AND 44).

FIRST USE 6-8-2006; IN COMMERCE 6-8-2006.

CLASS 10—(Continued).

3,314,360. RADLYN LLC, CINCINNATI, OH. SN 78-816,003. PUB. 10-3-2006, FILED 2-16-2006.

RADLYN

THE MARK CONSISTS OF STANDARD CHARACTERS WITHOUT CLAIM TO ANY PARTICULAR FONT, STYLE, SIZE, OR COLOR.

FOR MEDICAL APPARATUS FOR DIAGNOSING OR TREATING RESPIRATORY CONDITIONS; MEDICAL GUIDEWIRES; MEDICAL TUBING FOR PATIENT INTUBATION SO AS TO ESTABLISH AN AIRWAY; SURGICAL AND MEDICAL APPARATUS AND INSTRUMENTS FOR USE IN GENERAL SURGERY (U.S. CLS. 26, 39 AND 44).

FIRST USE 12-1-2006; IN COMMERCE 12-1-2006.

CLASS 10—(Continued).

3,314,401. IVIVI TECHNOLOGIES, INC., NORTHVALE, NJ. SN 78-821,787. PUB. 8-29-2006, FILED 2-23-2006.

Torino

THE MARK CONSISTS OF STANDARD CHARACTERS WITHOUT CLAIM TO ANY PARTICULAR FONT, STYLE, SIZE, OR COLOR.

FOR ELECTROMAGNETIC THERAPY APPARATUS FOR MEDICAL USE IN THE TREATMENT OF TISSUE GROWTH AND REPAIR (U.S. CLS. 26, 39 AND 44).

FIRST USE 2-23-2006; IN COMMERCE 2-23-2006.

3,314,385. ANSELL HEALTHCARE PRODUCTS LLC, RED BANK, NJ. SN 78-819,704. PUB. 10-17-2006, FILED 2-21-2006.



NO CLAIM IS MADE TO THE EXCLUSIVE RIGHT TO USE "TECHNOLOGY", APART FROM THE MARK AS SHOWN.

THE MARK CONSISTS OF A ROUND DISK WITH A HOLE IN THE CENTER AND THE WORD SUREFIT ARCHING ACROSS THE TOP AND THE WORD TECHNOLOGY IN AN INVERTED ARCH ACROSS THE BOTTOM.

FOR GLOVES FOR MEDICAL USE; SURGICAL GLOVES (U.S. CLS. 26, 39 AND 44).

FIRST USE 1-20-2007; IN COMMERCE 1-20-2007.

3,314,405. IMPACT SPORTS TECHNOLOGIES, INC., LAS VEGAS, NV. SN 78-822,580. PUB. 12-26-2006, FILED 2-24-2006.

Personal Fitness Assistant

THE MARK CONSISTS OF STANDARD CHARACTERS WITHOUT CLAIM TO ANY PARTICULAR FONT, STYLE, SIZE, OR COLOR.

NO CLAIM IS MADE TO THE EXCLUSIVE RIGHT TO USE "PERSONAL FITNESS", APART FROM THE MARK AS SHOWN.

FOR FITNESS DEVICE WORN ON THE HAND AS A GLOVE OR AS A BAND ON THE ARM THAT CONSISTS OF A CALORIMETER AND HEART MONITOR THAT DETECTS HEART RATE FROM A SENSOR MOUNTED ON THE DEVICE THAT EMPLOYS A LIGHT EMITTING DIODE AND LIGHT-TO-FREQUENCY OR LIGHT-TO-VOLTAGE SENSOR TO DETECT HEART RATE FROM ARTERIAL BLOOD FLOW, THE DEVICE COMBINES THE HEART RATE DATA WITH PERSONAL DATA FROM THE WEARER TO CALCULATE AND DISPLAY DYNAMIC HEART RATE, EXERCISE CALORIES BURNED, BASAL METABOLIC RATE IN TERMS OF PREDICTED DAILY CALORIC BURN, EXERCISE TARGET ZONES AND OTHER FITNESS RELATED DATA WHICH IS DISPLAYED TO THE USER DIRECTLY ON THE DEVICE AND MAY ALSO BE TRANSFERRED BY WIRELESS OR WIRED MEANS TO A PERSONAL COMPUTER (U.S. CLS. 26, 39 AND 44).

FIRST USE 3-1-2006; IN COMMERCE 3-1-2006.

CLASS 10—(Continued).

3,314,450. PACIFIC PEDIATRIC SUPPLY LLC, WINCHESTER, CA. SN 78-833,512. PUB. 1-23-2007, FILED 3-9-2006.

SIT-N-SKATE

THE MARK CONSISTS OF STANDARD CHARACTERS WITHOUT CLAIM TO ANY PARTICULAR FONT, STYLE, SIZE, OR COLOR.

FOR MEDICAL APPARATUS DESIGNED TO IMPROVE MENTAL FOCUS IN INDIVIDUALS SUFFERING FROM ATTENTION DEFICIT DISORDER COMPOSED OF A SKATING BOARD SITTING ON A RECTANGULAR BASE THAT ENABLES AFFECTED INDIVIDUALS TO EXERCISE SKATING LIKE MOTION OF THE FEET WHILE SITTING DOWN (U.S. CLS. 26, 39 AND 44).

FIRST USE 1-1-2006; IN COMMERCE 1-1-2006.

CLASS 10—(Continued).

3,314,564. AMS RESEARCH CORPORATION, MINNETONKA, MN. SN 78-878,005. PUB. 11-14-2006, FILED 5-5-2006.

ADVANCE

THE MARK CONSISTS OF STANDARD CHARACTERS WITHOUT CLAIM TO ANY PARTICULAR FONT, STYLE, SIZE, OR COLOR.

FOR MEDICAL DEVICES, NAMELY, A SLING SYSTEM FOR UROLOGICAL USE CONSISTING OF AN IMPLANTABLE SLING, SLING CONNECTORS, AND INSERTION DEVICES (U.S. CLS. 26, 39 AND 44).

FIRST USE 7-28-2006; IN COMMERCE 7-28-2006.

3,314,600. PIONEER LABORATORIES, INC., MARQUETTE, MI. SN 78-886,628. PUB. 12-26-2006, FILED 5-18-2006.

IJAK

THE MARK CONSISTS OF STANDARD CHARACTERS WITHOUT CLAIM TO ANY PARTICULAR FONT, STYLE, SIZE, OR COLOR.

FOR SPINAL IMPLANTS COMPOSED OF ARTIFICIAL MATERIAL; SPINAL FIXATION DEVICES; SURGICAL INSTRUMENTS FOR USE IN SPINAL SURGERY (U.S. CLS. 26, 39 AND 44).

FIRST USE 5-18-2006; IN COMMERCE 7-27-2006.

3,314,467. RESPCARE, INC., COCONUT CREEK, FL. SN 78-838,892. PUB. 10-31-2006, FILED 3-16-2006.

BRAVO

THE MARK CONSISTS OF STANDARD CHARACTERS WITHOUT CLAIM TO ANY PARTICULAR FONT, STYLE, SIZE, OR COLOR.

FOR NASAL VENTILATION INTERFACE AND RESPIRATORS FOR MEDICAL PURPOSES; CONTINUOUS POSITIVE AIRWAY PRESSURE (CPAP) COMPRESSORS AND MONITORS; BILEVEL POSITIVE AIRWAY PRESSURE COMPRESSORS AND MONITORS; HUMIDIFIERS FOR USE IN CONNECTION WITH MEDICAL RESPIRATORY DEVICES; FACIAL MASKS FOR USE IN CONNECTION WITH NASAL VENTILATION INTERFACE AND RESPIRATORS, CONTINUOUS POSITIVE AIRWAY PRESSURE (CPAP) COMPRESSORS BILEVEL POSITIVE AIRWAY PRESSURE COMPRESSORS (U.S. CLS. 26, 39 AND 44).

FIRST USE 4-1-2006; IN COMMERCE 2-1-2007.

3,314,611. ALLEGIANCE CORPORATION, MCGAW PARK, IL. SN 78-889,405. PUB. 1-2-2007, FILED 5-22-2006.

EXPRESS

THE MARK CONSISTS OF STANDARD CHARACTERS WITHOUT CLAIM TO ANY PARTICULAR FONT, STYLE, SIZE, OR COLOR.

FOR NONWOVEN STERILIZATION WRAP USED IN CONNECTION WITH SURGICAL INSTRUMENT SETS (U.S. CLS. 26, 39 AND 44).

FIRST USE 4-1-1999; IN COMMERCE 4-1-1999.

CLASS 10—(Continued).

3,314,740. MERIT MEDICAL SYSTEMS, INC., SOUTH JORDAN, UT. SN 78-924,473. PUB. 2-13-2007, FILED 7-7-2006.

Merit Advance

THE MARK CONSISTS OF STANDARD CHARACTERS WITHOUT CLAIM TO ANY PARTICULAR FONT, STYLE, SIZE, OR COLOR.

FOR MEDICAL DEVICES, NAMELY, ANGIOGRAPHIC NEEDLES (U.S. CLS. 26, 39 AND 44).
FIRST USE 11-1-2006; IN COMMERCE 11-1-2006.

3,314,745. BURNS, JOHN R, SOUTH MILWAUKEE, WI. SN 78-925,227. PUB. 2-20-2007, FILED 7-9-2006.

Tao-Well

THE MARK CONSISTS OF STANDARD CHARACTERS WITHOUT CLAIM TO ANY PARTICULAR FONT, STYLE, SIZE, OR COLOR.

FOR APPARATUS FOR ACUPRESSURE THERAPY; APPARATUS FOR PHYSICAL TRAINING FOR MEDICAL USE; MASSAGE APPARATUS (U.S. CLS. 26, 39 AND 44).
FIRST USE 8-12-2007; IN COMMERCE 8-12-2007.

CLASS 11—ENVIRONMENTAL CONTROL APPARATUS

3,313,054. FORTRESS HILL INDUSTRY LTD., RICHMOND, BC, CANADA. SN 76-589,198. PUB. 3-8-2005, FILED 4-28-2004.

FORTRESS HILL

THE MARK CONSISTS OF STANDARD CHARACTERS WITHOUT CLAIM TO ANY PARTICULAR FONT, STYLE, SIZE, OR COLOR.

FOR COMMERCIAL AND RESIDENTIAL ELECTRICAL PRODUCTS NAMELY, EXHAUST FANS, HOOD FANS, LIGHT BULBS, VENTILATION FANS, CEILING FANS, AIR CONDITIONERS, LIGHTING NAMELY, LIGHT FIXTURES, INDOOR AND OUTDOOR LIGHT FIXTURES, FLOOD LIGHTS, RECESSED LIGHTS, ARCHITECTURAL LIGHTS, SPECIAL EFFECT LAMPS, LED LAMPS, ENERGY SAVING LAMPS (U.S. CLS. 13, 21, 23, 31 AND 34).
FIRST USE 3-1-2004; IN COMMERCE 5-1-2007.

CLASS 11—(Continued).

3,313,120. ACUITY BRANDS, INC., ATLANTA, GA. SN 76-635,598. PUB. 1-24-2006, FILED 4-11-2005.

VELARÉ

THE MARK CONSISTS OF STANDARD CHARACTERS WITHOUT CLAIM TO ANY PARTICULAR FONT, STYLE, SIZE, OR COLOR.

THE ENGLISH TRANSLATION OF THE ITALIAN TERM "VELARE" IS "VAILED."

FOR EMERGENCY ELECTRIC LIGHTING FIXTURES (U.S. CLS. 13, 21, 23, 31 AND 34).
FIRST USE 7-0-2006; IN COMMERCE 7-0-2006.

3,313,152. PURE HEALTH SOLUTIONS, INC., SANDPOINT, ID. SN 76-643,447. PUB. 4-18-2006, FILED 7-22-2005.

INTERPURE

THE MARK CONSISTS OF STANDARD CHARACTERS WITHOUT CLAIM TO ANY PARTICULAR FONT, STYLE, SIZE, OR COLOR.

FOR BOTTLELESS WATER PURIFICATION SYSTEM CONSISTING OF WATER PURIFICATION UNIT, WATER DISPENSER, PROGRAMMABLE MICROPROCESSOR, OPERATING SOFTWARE, AND WATER FILTERS THAT PRODUCES POTABLE WATER FOR DOMESTIC AND COMMERCIAL POINT OF USE (U.S. CLS. 13, 21, 23, 31 AND 34).
FIRST USE 2-1-2007; IN COMMERCE 2-1-2007.

3,313,341. KOHLER CO., KOHLER, WI. SN 77-077,113. PUB. 5-22-2007, FILED 1-5-2007.

BOTTICELLI

THE MARK CONSISTS OF STANDARD CHARACTERS WITHOUT CLAIM TO ANY PARTICULAR FONT, STYLE, SIZE, OR COLOR.

FOR LAVATORIES (U.S. CLS. 13, 21, 23, 31 AND 34).
FIRST USE 4-11-2003; IN COMMERCE 4-11-2003.

CLASS 11—(Continued).

3,313,342. KOHLER CO., KOHLER, WI. SN 77-077,211. PUB. 5-22-2007, FILED 1-5-2007.

CLASS 11—(Continued).

3,313,345. KOHLER CO., KOHLER, WI. SN 77-077,257. PUB. 5-22-2007, FILED 1-5-2007.

CANTATA

FARMINGTON

THE MARK CONSISTS OF STANDARD CHARACTERS WITHOUT CLAIM TO ANY PARTICULAR FONT, STYLE, SIZE, OR COLOR.
FOR LAVATORIES (U.S. CLS. 13, 21, 23, 31 AND 34).
FIRST USE 2-19-1990; IN COMMERCE 2-19-1990.

THE MARK CONSISTS OF STANDARD CHARACTERS WITHOUT CLAIM TO ANY PARTICULAR FONT, STYLE, SIZE, OR COLOR.
FOR LAVATORIES (U.S. CLS. 13, 21, 23, 31 AND 34).
FIRST USE 12-3-1964; IN COMMERCE 12-3-1964.

3,313,343. KOHLER CO., KOHLER, WI. SN 77-077,213. PUB. 5-22-2007, FILED 1-5-2007.

3,313,346. KOHLER CO., KOHLER, WI. SN 77-078,015. PUB. 5-22-2007, FILED 1-8-2007.

BROOKLINE

INVITATION

THE MARK CONSISTS OF STANDARD CHARACTERS WITHOUT CLAIM TO ANY PARTICULAR FONT, STYLE, SIZE, OR COLOR.
FOR LAVATORIES (U.S. CLS. 13, 21, 23, 31 AND 34).
FIRST USE 2-1-1963; IN COMMERCE 2-1-1963.

THE MARK CONSISTS OF STANDARD CHARACTERS WITHOUT CLAIM TO ANY PARTICULAR FONT, STYLE, SIZE, OR COLOR.
FOR LAVATORIES (U.S. CLS. 13, 21, 23, 31 AND 34).
FIRST USE 2-17-1992; IN COMMERCE 2-17-1992.

3,313,344. KOHLER CO., KOHLER, WI. SN 77-077,256. PUB. 5-22-2007, FILED 1-5-2007.

3,313,347. KOHLER CO., KOHLER, WI. SN 77-078,018. PUB. 5-22-2007, FILED 1-8-2007.

FANDANGO

FLAMENCO

THE MARK CONSISTS OF STANDARD CHARACTERS WITHOUT CLAIM TO ANY PARTICULAR FONT, STYLE, SIZE, OR COLOR.
FOR LAVATORIES (U.S. CLS. 13, 21, 23, 31 AND 34).
FIRST USE 4-1-1998; IN COMMERCE 4-1-1998.

THE MARK CONSISTS OF STANDARD CHARACTERS WITHOUT CLAIM TO ANY PARTICULAR FONT, STYLE, SIZE, OR COLOR.
FOR LAVATORIES (U.S. CLS. 13, 21, 23, 31 AND 34).
FIRST USE 2-1-2004; IN COMMERCE 2-1-2004.

CLASS 11—(Continued).

3,313,374. WESTINGHOUSE ELECTRIC CORPORATION, NEW YORK, NY. SN 78-243,741. PUB. 6-29-2004, FILED 4-30-2003.

YOU CAN BE SURE...IF IT'S WESTINGHOUSE

OWNER OF U.S. REG. NOS. 2,538,110 AND 2,617,250.
FOR TROUBLE LIGHTS, NIGHT LIGHTS; WALL
SWITCH ADAPTERS AND RECEIVERS (U.S. CLS. 13,
21, 23, 31 AND 34).
FIRST USE 3-21-2006; IN COMMERCE 3-21-2006.

3,313,384. PANAVISION INTERNATIONAL, L.P., WOOD-
LAND HILLS, CA. SN 78-261,744. PUB. 8-15-2006, FILED
6-12-2003.

PANAVISION

OWNER OF U.S. REG. NOS. 627,362, 1,972,238, AND
OTHERS.
FOR LAMPS AND LIGHTING FIXTURES FOR USE IN
PHOTOGRAPHY, CINEMATOGRAPHY, STAGE AND
THEATRICAL PERFORMANCES (U.S. CLS. 13, 21, 23,
31 AND 34).
FIRST USE 6-0-1990; IN COMMERCE 6-0-1990.

3,313,501. HUNTER FAN COMPANY, MEMPHIS, TN. SN 78-
489,981. PUB. 8-1-2006, FILED 9-27-2004.

LA FLEUR

THE MARK CONSISTS OF STANDARD CHARACTERS
WITHOUT CLAIM TO ANY PARTICULAR FONT, STYLE,
SIZE, OR COLOR.

THE ENGLISH TRANSLATION OF THE WORDS "LA
FLEUR" IN THE MARK IS "THE FLOWER."
FOR CEILING FANS (U.S. CLS. 13, 21, 23, 31 AND 34).
FIRST USE 11-1-2005; IN COMMERCE 11-1-2005.

CLASS 11—(Continued).

3,313,539. TRUE VALUE COMPANY, CHICAGO, IL. SN 78-
538,059. PUB. 5-15-2007, FILED 12-23-2004.

AQUA THERAPY

THE MARK CONSISTS OF STANDARD CHARACTERS
WITHOUT CLAIM TO ANY PARTICULAR FONT, STYLE,
SIZE, OR COLOR.

NO CLAIM IS MADE TO THE EXCLUSIVE RIGHT TO
USE "AQUA", APART FROM THE MARK AS SHOWN.
FOR SHOWERHEADS (U.S. CLS. 13, 21, 23, 31 AND 34).
FIRST USE 3-0-2005; IN COMMERCE 3-0-2005.

3,313,540. TRUE VALUE COMPANY, CHICAGO, IL. SN 78-
538,061. PUB. 5-15-2007, FILED 12-23-2004.



NO CLAIM IS MADE TO THE EXCLUSIVE RIGHT TO
USE "AQUA", APART FROM THE MARK AS SHOWN.
FOR SHOWERHEADS (U.S. CLS. 13, 21, 23, 31 AND 34).
FIRST USE 3-0-2005; IN COMMERCE 3-0-2005.

3,313,661. JACUZZI INC., DALLAS, TX. SN 78-617,911. PUB.
7-4-2006, FILED 4-27-2005.

ELARA

THE MARK CONSISTS OF STANDARD CHARACTERS
WITHOUT CLAIM TO ANY PARTICULAR FONT, STYLE,
SIZE, OR COLOR.

FOR WHIRLPOOL BATHS (U.S. CLS. 13, 21, 23, 31
AND 34).
FIRST USE 7-6-2005; IN COMMERCE 7-6-2005.

CLASS 11—(Continued).

3,313,676. SHARPER IMAGE CORPORATION, SAN FRANCISCO, CA. SN 78-623,938. PUB. 8-1-2006, FILED 5-5-2005.

OZONEGUARD

THE MARK CONSISTS OF STANDARD CHARACTERS WITHOUT CLAIM TO ANY PARTICULAR FONT, STYLE, SIZE, OR COLOR.

FOR AIR PURIFIERS, HOUSEHOLD AIR CLEANERS, AND STRUCTURAL PARTS THEREFOR; AIR CLEANING UNITS AND CARTRIDGES USED FOR REDUCING OZONE AND CONVERTING OZONE TO OXYGEN; COATINGS FOR THE REDUCTION OF OZONE AND THE CONVERSION OF OZONE TO OXYGEN SOLD AS AN INTEGRAL COMPONENT OF AIR PURIFIERS AND AIR CLEANERS (U.S. CLS. 13, 21, 23, 31 AND 34).
FIRST USE 9-0-2005; IN COMMERCE 9-0-2005.

3,313,723. LASKO HOLDINGS, INC., WILMINGTON, DE. SN 78-645,001. PUB. 2-21-2006, FILED 6-7-2005.

IBIZA

THE MARK CONSISTS OF STANDARD CHARACTERS WITHOUT CLAIM TO ANY PARTICULAR FONT, STYLE, SIZE, OR COLOR.

FOR RANGE HOODS (U.S. CLS. 13, 21, 23, 31 AND 34).
FIRST USE 6-7-2005; IN COMMERCE 6-7-2005.

3,313,761. HANS GROHE, INC., ALPHARETTA, GA. SN 78-659,657. PUB. 10-10-2006, FILED 6-28-2005.

TYPHOON

THE MARK CONSISTS OF STANDARD CHARACTERS WITHOUT CLAIM TO ANY PARTICULAR FONT, STYLE, SIZE, OR COLOR.

FOR KITCHEN AND BATH FAUCETS, SHOWER HEADS, HAND SHOWERS, SHOWER VALVES, TUB SPOUTS AND LAMPS (U.S. CLS. 13, 21, 23, 31 AND 34).
FIRST USE 1-25-2007; IN COMMERCE 1-25-2007.

CLASS 11—(Continued).

3,313,812. TECHLITE DESIGNS, GRAFTON, MA. SN 78-682,777. PUB. 8-22-2006, FILED 8-1-2005.

PowerSURE

THE MARK CONSISTS OF STANDARD CHARACTERS WITHOUT CLAIM TO ANY PARTICULAR FONT, STYLE, SIZE, OR COLOR.

FOR ELECTRIC LIGHTING FIXTURES, NAMELY POWER FAILURE BACKUP SAFETY LIGHTING; ELECTRIC NIGHT LIGHTS (U.S. CLS. 13, 21, 23, 31 AND 34).
FIRST USE 8-31-2005; IN COMMERCE 1-6-2007.

3,313,903. HAPPY BIRD CORPORATION, WESTON, MA. SN 78-721,014. PUB. 8-1-2006, FILED 9-27-2005.

SOLAR SIPPER WATER WARMER

THE MARK CONSISTS OF STANDARD CHARACTERS WITHOUT CLAIM TO ANY PARTICULAR FONT, STYLE, SIZE, OR COLOR.

OWNER OF U.S. REG. NO. 1,616,785.
NO CLAIM IS MADE TO THE EXCLUSIVE RIGHT TO USE "SOLAR" AND "WATER WARMER", APART FROM THE MARK AS SHOWN.

FOR DEVICES FOR WARMING WATER, NAMELY, DEVICES FOR WARMING WATER FOR USE WITH ANIMAL WATERING CONTAINERS, NAMELY, CONTAINERS FOR WATERING BIRDS, DOGS, HORSES AND OTHER WILD AND DOMESTIC ANIMALS (U.S. CLS. 13, 21, 23, 31 AND 34).
FIRST USE 1-23-2007; IN COMMERCE 1-23-2007.

3,313,918. HUNTER FAN COMPANY, MEMPHIS, TN. SN 78-728,979. PUB. 8-29-2006, FILED 10-7-2005.

AVT

THE MARK CONSISTS OF STANDARD CHARACTERS WITHOUT CLAIM TO ANY PARTICULAR FONT, STYLE, SIZE, OR COLOR.

FOR CEILING FANS (U.S. CLS. 13, 21, 23, 31 AND 34).
FIRST USE 1-25-2006; IN COMMERCE 1-25-2006.

CLASS 11—(Continued).

3,314,011. HEADWATERS, INC., MARBLEHEAD, MA. SN 78-753,184. PUB. 7-25-2006, FILED 11-14-2005.

AirTamer

THE MARK CONSISTS OF STANDARD CHARACTERS WITHOUT CLAIM TO ANY PARTICULAR FONT, STYLE, SIZE, OR COLOR.

FOR AIR PURIFIERS (U.S. CLS. 13, 21, 23, 31 AND 34).
FIRST USE 9-16-2006; IN COMMERCE 12-10-2006.

CLASS 11—(Continued).

3,314,081. RUUD LIGHTING, INC., RACINE, WI. SN 78-766,412. PUB. 8-1-2006, FILED 12-5-2005.

EZ BAY PLUS

THE MARK CONSISTS OF STANDARD CHARACTERS WITHOUT CLAIM TO ANY PARTICULAR FONT, STYLE, SIZE, OR COLOR.

OWNER OF U.S. REG. NO. 2,579,881.
FOR OVERHEAD INDUSTRIAL ELECTRIC LIGHTING FIXTURES (U.S. CLS. 13, 21, 23, 31 AND 34).
FIRST USE 1-2-2006; IN COMMERCE 1-2-2006.

3,314,054. ECOWATER SYSTEMS, LLC, WOODBURY, MN. SN 78-762,169. PUB. 8-1-2006, FILED 11-29-2005.

INTELLISOFT

THE MARK CONSISTS OF STANDARD CHARACTERS WITHOUT CLAIM TO ANY PARTICULAR FONT, STYLE, SIZE, OR COLOR.

FOR WATER SOFTENING UNITS (U.S. CLS. 13, 21, 23, 31 AND 34).
FIRST USE 3-23-2006; IN COMMERCE 3-23-2006.

3,314,128. WORLD IMPORTS INTERNATIONAL, INC., FORT LAUDERDALE, FL. SN 78-774,348. PUB. 8-22-2006, FILED 12-15-2005.

THINGLOW

THE MARK CONSISTS OF STANDARD CHARACTERS WITHOUT CLAIM TO ANY PARTICULAR FONT, STYLE, SIZE, OR COLOR.

OWNER OF U.S. REG. NOS. 1,938,553 AND 2,098,673.
FOR AUTOMOTIVE LED LIGHTING FIXTURES (U.S. CLS. 13, 21, 23, 31 AND 34).
FIRST USE 12-25-2005; IN COMMERCE 12-25-2005.

3,314,058. WEST BEND HOUSEWARES, LLC, VERNON HILLS, IL. SN 78-763,963. PUB. 9-5-2006, FILED 11-30-2005.

QUIKSERVE

THE MARK CONSISTS OF STANDARD CHARACTERS WITHOUT CLAIM TO ANY PARTICULAR FONT, STYLE, SIZE, OR COLOR.

FOR ELECTRIC TOASTERS (U.S. CLS. 13, 21, 23, 31 AND 34).
FIRST USE 2-0-2007; IN COMMERCE 2-0-2007.

3,314,150. BULBRITE INDUSTRIES, INC., MOONACHIE, NJ. SN 78-776,896. PUB. 8-15-2006, FILED 12-20-2005.

KRYSTAL TOUCH

THE MARK CONSISTS OF STANDARD CHARACTERS WITHOUT CLAIM TO ANY PARTICULAR FONT, STYLE, SIZE, OR COLOR.

NO CLAIM IS MADE TO THE EXCLUSIVE RIGHT TO USE "CRYSTAL", APART FROM THE MARK AS SHOWN.
FOR LIGHT BULBS AND LAMPS (U.S. CLS. 13, 21, 23, 31 AND 34).
FIRST USE 2-9-2006; IN COMMERCE 2-9-2006.

CLASS 11—(Continued).

3,314,238. ECOWATER SYSTEMS LLC, WOODBURY, MN.
SN 78-792,891. PUB. 8-29-2006, FILED 1-17-2006.



THE MARK CONSISTS OF THE WORD "INTELLISOFT" WITH A WATER DROP DOTTING THE "I" AND A SEMI-OVAL SHAPE PARTIALLY SURROUNDING "SOFT".
FOR WATER SOFTENING UNITS (U.S. CLS. 13, 21, 23, 31 AND 34).
FIRST USE 3-23-2006; IN COMMERCE 3-23-2006.

3,314,332. HOMER TLC, INC., CLAYMONT, DE. SN 78-810,793. PUB. 8-29-2006, FILED 2-9-2006.

SAN LUCAS

THE MARK CONSISTS OF STANDARD CHARACTERS WITHOUT CLAIM TO ANY PARTICULAR FONT, STYLE, SIZE, OR COLOR.
FOR CEILING FANS; ELECTRIC LIGHTING FIXTURES (U.S. CLS. 13, 21, 23, 31 AND 34).
FIRST USE 4-0-2006; IN COMMERCE 4-0-2006.

3,314,407. SEABREEZE ELECTRIC CORPORATION, TORONTO, ONTARIO, CANADA. SN 78-823,005. PUB. 10-10-2006, FILED 2-24-2006.

CONTEMPRO

THE MARK CONSISTS OF STANDARD CHARACTERS WITHOUT CLAIM TO ANY PARTICULAR FONT, STYLE, SIZE, OR COLOR.
FOR PORTABLE ELECTRIC HEATERS (U.S. CLS. 13, 21, 23, 31 AND 34).
FIRST USE 9-0-2006; IN COMMERCE 9-0-2006.

CLASS 11—(Continued).

3,314,623. JOURNÉE LIGHTING, INC., WESTLAKE VILLAGE, CA. SN 78-893,127. PUB. 12-19-2006, FILED 5-25-2006.

WattageAdjust

THE MARK CONSISTS OF STANDARD CHARACTERS WITHOUT CLAIM TO ANY PARTICULAR FONT, STYLE, SIZE, OR COLOR.
FOR ELECTRICAL WATTAGE ADJUSTER COMPONENT OF ELECTRIC LIGHTING FIXTURES (U.S. CLS. 13, 21, 23, 31 AND 34).
FIRST USE 2-1-2006; IN COMMERCE 3-7-2007.

3,314,656. HONEYWELL INTERNATIONAL INC., MORRISTOWN, NJ. SN 78-901,262. PUB. 12-12-2006, FILED 6-6-2006.

FLAREGLO

THE MARK CONSISTS OF STANDARD CHARACTERS WITHOUT CLAIM TO ANY PARTICULAR FONT, STYLE, SIZE, OR COLOR.
FOR LIGHTS, NAMELY SAFETY LIGHTS AND SECURITY LIGHTS FOR USE WITH SEA, AIR AND LAND VEHICLES; READING LIGHTS; FLASHLIGHTS AND MULTI-PURPOSE LIGHTS (U.S. CLS. 13, 21, 23, 31 AND 34).
FIRST USE 11-30-2006; IN COMMERCE 2-28-2007.

3,314,658. HONEYWELL INTERNATIONAL INC., MORRISTOWN, NJ. SN 78-901,316. PUB. 12-12-2006, FILED 6-6-2006.

SPACEGLO

THE MARK CONSISTS OF STANDARD CHARACTERS WITHOUT CLAIM TO ANY PARTICULAR FONT, STYLE, SIZE, OR COLOR.
FOR LIGHTS, NAMELY SAFETY LIGHTS AND SECURITY LIGHTS FOR USE WITH SEA, AIR AND LAND VEHICLES; READING LIGHTS; FLASHLIGHTS AND MULTI-PURPOSE LIGHTS (U.S. CLS. 13, 21, 23, 31 AND 34).
FIRST USE 11-30-2006; IN COMMERCE 2-28-2007.

CLASS 11—(Continued).

3,314,724. PEPCO SALES OF DALLAS, INC., IRVING, TX. SN 78-917,568. PUB. 2-13-2007, FILED 6-27-2006.

AVORA

THE MARK CONSISTS OF STANDARD CHARACTERS WITHOUT CLAIM TO ANY PARTICULAR FONT, STYLE, SIZE, OR COLOR.
FOR BIDETS; SINKS; TOILETS; URINALS (U.S. CLS. 13, 21, 23, 31 AND 34).
FIRST USE 5-25-2006; IN COMMERCE 5-25-2006.

3,314,746. PEPCO SALES OF DALLAS, INC., IRVING, TX. SN 78-925,400. PUB. 2-20-2007, FILED 7-10-2006.

BRILANTE

THE MARK CONSISTS OF STANDARD CHARACTERS WITHOUT CLAIM TO ANY PARTICULAR FONT, STYLE, SIZE, OR COLOR.
FOR LAVATORIES; SINKS (U.S. CLS. 13, 21, 23, 31 AND 34).
FIRST USE 2-13-2007; IN COMMERCE 2-13-2007.

3,314,747. PEPCO SALES OF DALLAS, INC., IRVING, TX. SN 78-925,407. PUB. 2-20-2007, FILED 7-10-2006.

NATURAL EARTH

THE MARK CONSISTS OF STANDARD CHARACTERS WITHOUT CLAIM TO ANY PARTICULAR FONT, STYLE, SIZE, OR COLOR.
FOR BATH TUBS; LAVATORIES; SINK PEDESTALS; SINKS; TOILETS (U.S. CLS. 13, 21, 23, 31 AND 34).
FIRST USE 11-9-2006; IN COMMERCE 11-9-2006.

CLASS 11—(Continued).

3,314,772. THE CEILING FAN COMPANY, INC., DBA FANCO, LAS VEGAS, NV. SN 78-935,413. PUB. 3-13-2007, FILED 7-22-2006.

WHISPER BREEZE

THE MARK CONSISTS OF STANDARD CHARACTERS WITHOUT CLAIM TO ANY PARTICULAR FONT, STYLE, SIZE, OR COLOR.
NO CLAIM IS MADE TO THE EXCLUSIVE RIGHT TO USE "BREEZE", APART FROM THE MARK AS SHOWN.
FOR CEILING FANS (U.S. CLS. 13, 21, 23, 31 AND 34).
FIRST USE 6-1-2007; IN COMMERCE 6-1-2007.

3,314,855. HANSGRÖHE AG, SCHILTACH, FED REP GERMANY. SN 78-961,439. PUB. 2-13-2007, FILED 8-28-2006.

TALIS

THE MARK CONSISTS OF STANDARD CHARACTERS WITHOUT CLAIM TO ANY PARTICULAR FONT, STYLE, SIZE, OR COLOR.
FOR FAUCETS, NAMELY, LAVATORY FAUCETS, KITCHEN FAUCETS, FAUCET HANDLES, FAUCET VALVES, BAR SINK FAUCETS, ROMAN TUB FAUCETS AND FAUCET FILTERS; SHOWER AND TUB FIXTURES, NAMELY, SHOWER VALVES, TUB/SHOWER VALVES, TUB/SHOWER DIVERTER VALVES, TUB SPOUTS AND PARTS THEREFOR (U.S. CLS. 13, 21, 23, 31 AND 34).
FIRST USE 5-25-2007; IN COMMERCE 5-25-2007.

CLASS 12—VEHICLES

3,313,166. CANNONDALE BICYCLE CORPORATION, BETHEL, CT. SN 76-646,581. PUB. 10-31-2006, FILED 9-12-2005.



The logo for 'velopods' is written in a bold, lowercase, sans-serif font. The 'o's in 'pods' are stylized to resemble bicycle wheels, with a central dot and a thick rim.

FOR PANNIERS, COURIER BAGS, SADDLEBAGS AND HANDLEBAR BAGS, ALL FOR USE IN BICYCLING (U.S. CLS. 19, 21, 23, 31, 35 AND 44).
FIRST USE 2-7-2006; IN COMMERCE 2-7-2006.

CLASS 12—(Continued).

3,313,176. GATE FLEXOR, INC., DENVER, CO. SN 76-650,969. PUB. 2-13-2007, FILED 11-28-2005.



FOR TRAILER PARTS, NAMELY, NON MOTORIZED TRAILER TAILGATE LIFT SYSTEM COMPRISING A RAMP, SPRING, CABLE AND ATTACHMENT HARDWARE (U.S. CLS. 19, 21, 23, 31, 35 AND 44).
FIRST USE 12-2-2005; IN COMMERCE 12-2-2005.

3,313,188. CHINA MANUFACTURERS ALLIANCE, LLC, MONROVIA, CA. SN 76-653,337. PUB. 9-12-2006, FILED 1-13-2006.

DYNACARGO

THE MARK CONSISTS OF STANDARD CHARACTERS WITHOUT CLAIM TO ANY PARTICULAR FONT, STYLE, SIZE, OR COLOR.

FOR PASSENGER, LIGHT TRUCK, MEDIUM TRUCK, OFF ROAD, INDUSTRIAL, SKID STEER AND RUBBER TRACK TIRES (U.S. CLS. 19, 21, 23, 31, 35 AND 44).
FIRST USE 12-19-2005; IN COMMERCE 12-19-2005.

3,313,189. HSIEH, HSIN MAO, KAOHSIUNG CITY, TAIWAN. SN 76-653,579. PUB. 8-29-2006, FILED 1-17-2006.



FOR BICYCLES, COLLAPSIBLE BICYCLES, ELECTRIC BICYCLES AND ELECTRIC COLLAPSIBLE BICYCLES, AND STRUCTURAL PARTS THEREFOR; AND ACCESSORIES FOR BICYCLES, COLLAPSIBLE BICYCLES, ELECTRIC BICYCLES AND ELECTRIC COLLAPSIBLE BICYCLES, NAMELY, FRAMES, HANDLEBARS, HANDLEBAR STEMS, HEADSETS, DERAILERS, GEARS, SADDLES, SADDLE COVERS, SADDLEBAGS, SEAT POSTS, SEAT TUBES, PEDALS, CRANKS, WHEELS, TUBES, TIRES, RIMS, SPOKES, FORKS, CARRIERS, MUDGUARDS, CHAINS, CHAIN GUARDS, BELLS, HUBS, BRAKES AND LEVERS, TOE STRAPS AND CLIPS; SUSPENSION SYSTEMS FOR BICYCLES; MOTORS FOR BICYCLES (U.S. CLS. 19, 21, 23, 31, 35 AND 44).

FIRST USE 4-15-2007; IN COMMERCE 4-15-2007.

CLASS 12—(Continued).

3,313,215. A-M LLC, LOVELAND, CO. SN 76-662,481. PUB. 2-13-2007, FILED 7-3-2006.

HANDS ON

THE MARK CONSISTS OF STANDARD CHARACTERS WITHOUT CLAIM TO ANY PARTICULAR FONT, STYLE, SIZE, OR COLOR.

FOR BICYCLE SADDLES; SADDLES FOR BICYCLES (U.S. CLS. 19, 21, 23, 31, 35 AND 44).
FIRST USE 8-1-2006; IN COMMERCE 8-1-2006.

3,313,225. CURRIE TECHNOLOGIES, INC., CHATSWORTH, CA. SN 76-665,535. PUB. 3-27-2007, FILED 9-1-2006.

MEERKAT

THE MARK CONSISTS OF STANDARD CHARACTERS WITHOUT CLAIM TO ANY PARTICULAR FONT, STYLE, SIZE, OR COLOR.

FOR MOTORIZED VEHICLES, NAMELY, GO-CARTS; MOTORIZED BICYCLES, SCOOTERS, AND ELECTRIC BICYCLES (U.S. CLS. 19, 21, 23, 31, 35 AND 44).
FIRST USE 6-15-2006; IN COMMERCE 1-29-2007.

3,313,307. KW AUTOMOTIVE NORTH AMERICA, INC., SANGER, CA. SN 77-030,555. PUB. 5-29-2007, FILED 10-26-2006.



NO CLAIM IS MADE TO THE EXCLUSIVE RIGHT TO USE "PERFORMANCE", APART FROM THE MARK AS SHOWN.

THE MARK CONSISTS OF STREET PERFORMANCE. FOR METAL COVERS USED TO COVER AUTOMOTIVE SHOCK PARTS; SHOCK ABSORBING SPRINGS FOR MOTOR CARS; VEHICLE PARTS, NAMELY, SHOCK ABSORBERS (U.S. CLS. 19, 21, 23, 31, 35 AND 44).

FIRST USE 11-1-2006; IN COMMERCE 2-22-2007.

CLASS 12—(Continued).

3,313,311. THORSEN TOOL COMPANY, ONTARIO, CA. SN 77-031,003. PUB. 5-15-2007, FILED 10-27-2006.

CLASS 12—(Continued).

3,313,620. TRADITIONAL WATERCRAFT, INC., DBA ISLAND PACKET YACHTS, LARGO, FL. SN 78-599,025. PUB. 8-8-2006, FILED 3-31-2005.

HAUL N ROLL

THE MARK CONSISTS OF STANDARD CHARACTERS WITHOUT CLAIM TO ANY PARTICULAR FONT, STYLE, SIZE, OR COLOR.

FOR MULTI PURPOSE CARGO CARRIERS FOR USE WITH MOTOR VEHICLES (U.S. CLS. 19, 21, 23, 31, 35 AND 44).

FIRST USE 6-0-2007; IN COMMERCE 6-0-2007.

SP

THE MARK CONSISTS OF STANDARD CHARACTERS WITHOUT CLAIM TO ANY PARTICULAR FONT, STYLE, SIZE, OR COLOR.

FOR AUXILLIARY-POWERED SAILBOATS AND YACHTS (U.S. CLS. 19, 21, 23, 31, 35 AND 44).

FIRST USE 9-15-2006; IN COMMERCE 9-15-2006.

3,313,490. DYNACRAFT BSC, INC., AMERICAN CANYON, CA. SN 78-483,142. PUB. 9-27-2005, FILED 9-14-2004.

3,314,172. SABERTOOTH MOTORCYCLES LLC, GREER, SC. SN 78-780,794. PUB. 3-20-2007, FILED 12-27-2005.

DIRT WAVE

THE MARK CONSISTS OF STANDARD CHARACTERS WITHOUT CLAIM TO ANY PARTICULAR FONT, STYLE, SIZE, OR COLOR.

OWNER OF U.S. REG. NOS. 1,872,411, 2,642,445, AND OTHERS.

NO CLAIM IS MADE TO THE EXCLUSIVE RIGHT TO USE "DIRT", APART FROM THE MARK AS SHOWN.

FOR BICYCLES (U.S. CLS. 19, 21, 23, 31, 35 AND 44).
FIRST USE 3-0-2006; IN COMMERCE 3-0-2006.

Bobcat

THE MARK CONSISTS OF STANDARD CHARACTERS WITHOUT CLAIM TO ANY PARTICULAR FONT, STYLE, SIZE, OR COLOR.

FOR MOTORCYCLE ENGINES; MOTORCYCLE SADDLEBAGS; MOTORCYCLE SIDECARS; MOTORCYCLES AND STRUCTURAL PARTS THEREFOR (U.S. CLS. 19, 21, 23, 31, 35 AND 44).

FIRST USE 2-1-2006; IN COMMERCE 3-1-2007.

CLASS 12—(Continued).

3,314,183. THE HILLIARD CORPORATION, ELMIRA, NY.
SN 78-783,865. PUB. 9-5-2006, FILED 1-3-2006.

AUTO-LOK

THE MARK CONSISTS OF STANDARD CHARACTERS WITHOUT CLAIM TO ANY PARTICULAR FONT, STYLE, SIZE, OR COLOR.

OWNER OF U.S. REG. NO. 3,016,859.
FOR AXLES AND DIFFERENTIALS FOR LAND VEHICLES (U.S. CLS. 19, 21, 23, 31, 35 AND 44).
FIRST USE 2-12-2007; IN COMMERCE 2-12-2007.

3,314,205. NUCANOE, INC., BELLINGHAM, WA. SN 78-786,821. PUB. 3-13-2007, FILED 1-6-2006.

NUCANOE

THE MARK CONSISTS OF STANDARD CHARACTERS WITHOUT CLAIM TO ANY PARTICULAR FONT, STYLE, SIZE, OR COLOR.

FOR CANOES, CANOE EQUIPMENT, NAMELY, PADDLES (U.S. CLS. 19, 21, 23, 31, 35 AND 44).
FIRST USE 3-31-2006; IN COMMERCE 3-31-2006.

3,314,265. JUST WHEELS & TIRES CO., HUNTINGTON BEACH, CA. SN 78-796,216. PUB. 9-12-2006, FILED 1-20-2006.

PETROL

THE MARK CONSISTS OF STANDARD CHARACTERS WITHOUT CLAIM TO ANY PARTICULAR FONT, STYLE, SIZE, OR COLOR.

FOR VEHICLE PARTS, NAMELY, WHEELS (U.S. CLS. 19, 21, 23, 31, 35 AND 44).
FIRST USE 12-1-2006; IN COMMERCE 12-1-2006.

CLASS 12—(Continued).

3,314,278. VONDERAHE, ROGER P., ROCHESTER, NY. SN 78-799,801. PUB. 9-19-2006, FILED 1-26-2006.

SNAPTRAXX

THE MARK CONSISTS OF STANDARD CHARACTERS WITHOUT CLAIM TO ANY PARTICULAR FONT, STYLE, SIZE, OR COLOR.

FOR BOAT STORAGE AND TRANSPORT ACCESSORIES, NAMELY, A FITTED PROTECTIVE COVER ASSEMBLY COMPRISING PLASTIC SLEEVES AND END CAPS THAT SNAP TOGETHER AND ARE USED TO COVER LUMBER SECTIONS ON BOAT TRAILERS, BOAT HOISTS AND BOAT RACKS (U.S. CLS. 19, 21, 23, 31, 35 AND 44).
FIRST USE 10-9-2006; IN COMMERCE 10-9-2006.

3,314,411. PYLON MANUFACTURING CORPORATION, DEERFIELD BEACH, FL. SN 78-824,912. PUB. 9-12-2006, FILED 2-28-2006.

M-GUARD

THE MARK CONSISTS OF STANDARD CHARACTERS WITHOUT CLAIM TO ANY PARTICULAR FONT, STYLE, SIZE, OR COLOR.

FOR WINDSHIELD WIPER BLADES (U.S. CLS. 19, 21, 23, 31, 35 AND 44).
FIRST USE 5-0-2006; IN COMMERCE 10-23-2006.

3,314,544. PAULSON, MEGAN C., VENTURA, CA. SN 78-870,238. PUB. 1-9-2007, FILED 4-26-2006.

BABBLE CHIC

THE MARK CONSISTS OF STANDARD CHARACTERS WITHOUT CLAIM TO ANY PARTICULAR FONT, STYLE, SIZE, OR COLOR.

FOR CHILDREN'S PROTECTIVE FABRIC SLIPCOVERS FOR CAR SEATS, NAMELY, INFANT AND CHILDREN CAR SEATS AND BOOSTER CAR SEATS (U.S. CLS. 19, 21, 23, 31, 35 AND 44).
FIRST USE 7-11-2006; IN COMMERCE 11-4-2006.

CLASS 12—(Continued).

3,314,552. FOX FACTORY INC., WATSONVILLE, CA. SN 78-874,200. PUB. 10-31-2006, FILED 5-2-2006.

wherever you ride

THE MARK CONSISTS OF STANDARD CHARACTERS WITHOUT CLAIM TO ANY PARTICULAR FONT, STYLE, SIZE, OR COLOR.

FOR VEHICLE PARTS, NAMELY SHOCK ABSORBERS (U.S. CLS. 19, 21, 23, 31, 35 AND 44).

FIRST USE 4-11-2007; IN COMMERCE 4-11-2007.

CLASS 12—(Continued).

3,314,648. SRAM CORPORATION, CHICAGO, IL. SN 78-898,948. PUB. 1-2-2007, FILED 6-2-2006.

OMNIUM

THE MARK CONSISTS OF STANDARD CHARACTERS WITHOUT CLAIM TO ANY PARTICULAR FONT, STYLE, SIZE, OR COLOR.

FOR BICYCLES, BICYCLE PARTS, NAMELY, CRANKS AND BOLTS BEING PART OF CRANKS (U.S. CLS. 19, 21, 23, 31, 35 AND 44).

FIRST USE 7-6-2006; IN COMMERCE 7-6-2006.

3,314,618. LP WHEEL GROUP, INC., LAS VEGAS, NV. SN 78-891,241. PUB. 1-23-2007, FILED 5-24-2006.

IcedOutGrillz

THE MARK CONSISTS OF STANDARD CHARACTERS WITHOUT CLAIM TO ANY PARTICULAR FONT, STYLE, SIZE, OR COLOR.

FOR METAL AND/OR PLASTIC PARTS FOR VEHICLES, NAMELY, AUTOMOTIVE EXTERIOR AND INTERIOR EXTRUDED DECORATIVE TRIM (U.S. CLS. 19, 21, 23, 31, 35 AND 44).

FIRST USE 10-30-2006; IN COMMERCE 3-1-2007.

3,314,665. HOUSER PRODUCTS, LLC, GREEN CAMP, OH. SN 78-902,385. PUB. 5-15-2007, FILED 6-7-2006.

TRICTRAC

THE MARK CONSISTS OF STANDARD CHARACTERS WITHOUT CLAIM TO ANY PARTICULAR FONT, STYLE, SIZE, OR COLOR.

FOR ALL TERRAIN VEHICLE (ATV) SUSPENSION COMPONENTS, NAMELY, ATV A FRAMES, A ARMS, UPPER ARMS, CONTROL ARMS, SUSPENSION ARMS (U.S. CLS. 19, 21, 23, 31, 35 AND 44).

FIRST USE 2-5-2007; IN COMMERCE 2-5-2007.

3,314,621. STILES, COLLEEN, K., COLORADO SPRINGS, CO. SN 78-891,820. PUB. 1-9-2007, FILED 5-24-2006.

SkicadEZ

THE MARK CONSISTS OF STANDARD CHARACTERS WITHOUT CLAIM TO ANY PARTICULAR FONT, STYLE, SIZE, OR COLOR.

FOR SKI CARRIER/TOTE TO CARRY FROM VEHICLE TO SLOPE (U.S. CLS. 19, 21, 23, 31, 35 AND 44).

FIRST USE 6-9-2007; IN COMMERCE 6-9-2007.

3,314,674. HONEYWELL INTERNATIONAL INC., MORRISTOWN, NJ. SN 78-904,563. PUB. 12-19-2006, FILED 6-9-2006.

BENDIX CQ

THE MARK CONSISTS OF STANDARD CHARACTERS WITHOUT CLAIM TO ANY PARTICULAR FONT, STYLE, SIZE, OR COLOR.

OWNER OF U.S. REG. NOS. 893,583, 1,063,807, AND OTHERS.

FOR BRAKE PADS FOR LAND VEHICLES (U.S. CLS. 19, 21, 23, 31, 35 AND 44).

FIRST USE 3-9-2007; IN COMMERCE 3-31-2007.

CLASS 12—(Continued).

3,314,699. DYNACRAFT BSC, INC., AMERICAN CANYON, CA. SN 78-910,563. PUB. 1-2-2007, FILED 6-16-2006.

SUNSET

THE MARK CONSISTS OF STANDARD CHARACTERS WITHOUT CLAIM TO ANY PARTICULAR FONT, STYLE, SIZE, OR COLOR.

FOR BICYCLES (U.S. CLS. 19, 21, 23, 31, 35 AND 44).
FIRST USE 2-0-2007; IN COMMERCE 2-0-2007.

3,314,797. DYNACRAFT BSC, INC., AMERICAN CANYON, CA. SN 78-943,567. PUB. 3-13-2007, FILED 8-2-2006.

CURSE

THE MARK CONSISTS OF STANDARD CHARACTERS WITHOUT CLAIM TO ANY PARTICULAR FONT, STYLE, SIZE, OR COLOR.

FOR BICYCLES (U.S. CLS. 19, 21, 23, 31, 35 AND 44).
FIRST USE 8-2-2006; IN COMMERCE 8-28-2006.

CLASS 13—FIREARMS

3,312,993. MCLAREN, ROBERT R., COLORADO SPRINGS, CO. SN 76-245,596. PUB. 1-20-2004, FILED 4-24-2001.

LIFE SAVE-R GUNLOCK

NO CLAIM IS MADE TO THE EXCLUSIVE RIGHT TO USE "GUNLOCK", APART FROM THE MARK AS SHOWN.
FOR GUN LOCKS (U.S. CLS. 2 AND 9).
FIRST USE 2-13-2004; IN COMMERCE 2-13-2004.

3,313,006. ANGELOTTI INC., SCARBOROUGH, ONTARIO MIX 1E7, CANADA. SN 76-434,295. PUB. 11-18-2003, FILED 7-22-2002.

POWER SLIDE

NO CLAIM IS MADE TO THE EXCLUSIVE RIGHT TO USE "SLIDE", APART FROM THE MARK AS SHOWN.
FOR FIREARMS, REPLACEMENT AND STRUCTURAL PARTS THEREFORE (U.S. CLS. 2 AND 9).
FIRST USE 1-30-2007; IN COMMERCE 1-30-2007.

CLASS 13—(Continued).

3,314,141. THOMPSON CENTER ARMS COMPANY INC., ROCHESTER, NH. SN 78-775,993. PUB. 8-22-2006, FILED 12-19-2005.

FLEXTECH

THE MARK CONSISTS OF STANDARD CHARACTERS WITHOUT CLAIM TO ANY PARTICULAR FONT, STYLE, SIZE, OR COLOR.

FOR GUN STOCKS (U.S. CLS. 2 AND 9).
FIRST USE 3-1-2006; IN COMMERCE 3-1-2006.

3,314,142. THOMPSON CENTER ARMS COMPANY INC., ROCHESTER, NH. SN 78-776,001. PUB. 10-24-2006, FILED 12-19-2005.

SPEED BREECH

THE MARK CONSISTS OF STANDARD CHARACTERS WITHOUT CLAIM TO ANY PARTICULAR FONT, STYLE, SIZE, OR COLOR.

NO CLAIM IS MADE TO THE EXCLUSIVE RIGHT TO USE "BREECH", APART FROM THE MARK AS SHOWN.
FOR BREECHES OF FIREARMS (U.S. CLS. 2 AND 9).
FIRST USE 3-1-2006; IN COMMERCE 3-1-2006.

3,314,296. THOMPSON CENTER ARMS COMPANY INC., ROCHESTER, NH. SN 78-804,404. PUB. 10-24-2006, FILED 2-1-2006.

SWING HAMMER

THE MARK CONSISTS OF STANDARD CHARACTERS WITHOUT CLAIM TO ANY PARTICULAR FONT, STYLE, SIZE, OR COLOR.

NO CLAIM IS MADE TO THE EXCLUSIVE RIGHT TO USE "HAMMER", APART FROM THE MARK AS SHOWN.
FOR GUN PARTS; GUNS (U.S. CLS. 2 AND 9).
FIRST USE 3-1-2006; IN COMMERCE 3-1-2006.

CLASS 13—(Continued).

3,314,342. INGRAM ENTERPRISES, INC., SPRINGFIELD, MO. SN 78-813,213. PUB. 8-1-2006, FILED 2-13-2006.

MAN IN THE MOON

THE MARK CONSISTS OF STANDARD CHARACTERS WITHOUT CLAIM TO ANY PARTICULAR FONT, STYLE, SIZE, OR COLOR.
FOR FIREWORKS (U.S. CLS. 2 AND 9).
FIRST USE 3-5-2007; IN COMMERCE 3-5-2007.

CLASS 13—(Continued).

3,314,640. THOMPSON CENTER ARMS COMPANY INC., ROCHESTER, NH. SN 78-897,039. PUB. 10-10-2006, FILED 5-31-2006.

TRIUMPH

THE MARK CONSISTS OF STANDARD CHARACTERS WITHOUT CLAIM TO ANY PARTICULAR FONT, STYLE, SIZE, OR COLOR.
FOR FIREARMS (U.S. CLS. 2 AND 9).
FIRST USE 3-31-2006; IN COMMERCE 3-31-2006.

3,314,347. INGRAM ENTERPRISES, INC., SPRINGFIELD, MO. SN 78-814,057. PUB. 8-1-2006, FILED 2-14-2006.

INSTANT PARTY

THE MARK CONSISTS OF STANDARD CHARACTERS WITHOUT CLAIM TO ANY PARTICULAR FONT, STYLE, SIZE, OR COLOR.
FOR FIREWORKS (U.S. CLS. 2 AND 9).
FIRST USE 4-11-2007; IN COMMERCE 4-11-2007.

3,314,676. ALLIANT TECHSYSTEMS INC., EDINA, MN. SN 78-904,616. PUB. 1-16-2007, FILED 6-9-2006.

FLITESTOPPER

THE MARK CONSISTS OF STANDARD CHARACTERS WITHOUT CLAIM TO ANY PARTICULAR FONT, STYLE, SIZE, OR COLOR.
OWNER OF U.S. REG. NO. 3,099,182.
FOR AMMUNITION (U.S. CLS. 2 AND 9).
FIRST USE 11-0-2006; IN COMMERCE 11-0-2006.

3,314,394. NORTH PASS, LTD., FORT COLLINS, CO. SN 78-821,376. PUB. 10-10-2006, FILED 2-23-2006.

REDI-FIT

THE MARK CONSISTS OF STANDARD CHARACTERS WITHOUT CLAIM TO ANY PARTICULAR FONT, STYLE, SIZE, OR COLOR.
FOR RECOIL PADS (U.S. CLS. 2 AND 9).
FIRST USE 10-1-2006; IN COMMERCE 12-1-2006.

CLASS 14—JEWELRY

3,313,172. STERLING JEWELERS INC., AKRON, OH. SN 76-649,501. PUB. 9-12-2006, FILED 11-1-2005.

HEARTS DESIRE

THE MARK CONSISTS OF STANDARD CHARACTERS WITHOUT CLAIM TO ANY PARTICULAR FONT, STYLE, SIZE, OR COLOR.
FOR FINE JEWELRY (U.S. CLS. 2, 27, 28 AND 50).
FIRST USE 11-1-2006; IN COMMERCE 11-1-2006.

CLASS 14—(Continued).

3,313,218. TITAN DESIGNS, INC., LOS ANGELES, CA. SN 76-663,852. PUB. 3-6-2007, FILED 7-31-2006.

SPARTAN

THE MARK CONSISTS OF STANDARD CHARACTERS WITHOUT CLAIM TO ANY PARTICULAR FONT, STYLE, SIZE, OR COLOR.

FOR MEN'S FINE JEWELRY (U.S. CLS. 2, 27, 28 AND 50).
FIRST USE 1-0-2007; IN COMMERCE 1-0-2007.

3,313,360. POLARIS INDUSTRIES INC., MEDINA, MN. SN 78-175,208. PUB. 7-18-2006, FILED 10-16-2002.

POLARIS

OWNER OF U.S. REG. NOS. 908,318, 2,383,434, AND OTHERS.
FOR BELT BUCKLES OF PRECIOUS METALS; CLOCKS (U.S. CLS. 2, 27, 28 AND 50).
FIRST USE 0-0-1997; IN COMMERCE 0-0-1997.

3,313,403. AZOTIC COATING TECHNOLOGY, INC., ROCHESTER, MN. SN 78-309,597. PUB. 3-1-2005, FILED 10-6-2003.

MYSTIC PLATINUM TOPAZ

NO CLAIM IS MADE TO THE EXCLUSIVE RIGHT TO USE "PLATINUM TOPAZ", APART FROM THE MARK AS SHOWN.

FOR GEMSTONES AND JEWELRY (U.S. CLS. 2, 27, 28 AND 50).
FIRST USE 3-0-2003; IN COMMERCE 3-0-2003.

3,313,912. BUTTERFLY WORLDWIDE, LLC, ANN ARBOR, MI. SN 78-726,189. PUB. 12-19-2006, FILED 10-4-2005.

JEANS TO JEWELS

THE MARK CONSISTS OF STANDARD CHARACTERS WITHOUT CLAIM TO ANY PARTICULAR FONT, STYLE, SIZE, OR COLOR.

NO CLAIM IS MADE TO THE EXCLUSIVE RIGHT TO USE "JEWELS", APART FROM THE MARK AS SHOWN.
FOR JEWELRY, NAMELY, EARRINGS (U.S. CLS. 2, 27, 28 AND 50).
FIRST USE 1-1-2006; IN COMMERCE 1-1-2006.

CLASS 14—(Continued).

3,313,914. TESTI S.P.A., 50053 EMPOLI (FIRENZE), ITALY. SN 78-727,277. PUB. 7-25-2006, FILED 10-5-2005.

Rebecca

THE NAME(S), PORTRAIT(S), AND/OR SIGNATURE(S) SHOWN IN THE MARK IDENTIFIES A LIVING INDIVIDUAL, WHOSE CONSENT(S) TO REGISTER IS SUBMITTED.

THE MARK CONSISTS OF THE WORDS REBECCA APPEARING IN STYLIZED LETTERING BELOW WHICH APPEARS THE WORD TESTI ON A RECTANGULAR BACKGROUND.

FOR JEWELRY, NAMELY, EARRINGS, RINGS, PENDANTS, BRACELETS, NECKLACES; JEWELRY MADE IN PRECIOUS STONES; HOROLOGICAL AND CHRONOMETRICAL INSTRUMENTS, NAMELY, WATCHES (U.S. CLS. 2, 27, 28 AND 50).
FIRST USE 12-21-2006; IN COMMERCE 12-21-2006.

3,313,968. DUBLINX WATCHES AND ACCESSORIES, IRVINE, CA. SN 78-746,847. PUB. 8-29-2006, FILED 11-3-2005.

KLIP CLOX

THE MARK CONSISTS OF STANDARD CHARACTERS WITHOUT CLAIM TO ANY PARTICULAR FONT, STYLE, SIZE, OR COLOR.

FOR WATCHES (U.S. CLS. 2, 27, 28 AND 50).
FIRST USE 2-1-2006; IN COMMERCE 2-1-2006.

3,314,106. DIRECT PARTNERS, LTD., PLANO, TX. SN 78-770,584. PUB. 8-8-2006, FILED 12-9-2005.

ALLURIUM

THE MARK CONSISTS OF STANDARD CHARACTERS WITHOUT CLAIM TO ANY PARTICULAR FONT, STYLE, SIZE, OR COLOR.

FOR JEWELRY (U.S. CLS. 2, 27, 28 AND 50).
FIRST USE 2-2-2005; IN COMMERCE 2-2-2005.

CLASS 14—(Continued).

3,314,170. QUANTUM JEWELRY DISTRIBUTORS, INC., KENT, OH. SN 78-780,138. PUB. 3-20-2007, FILED 12-23-2005.

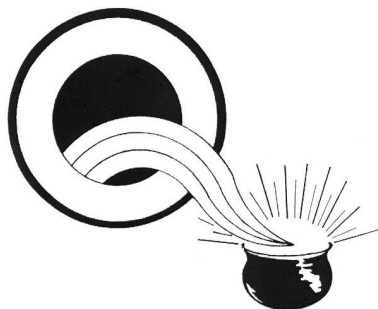

FOR JEWELRY, JEWELRY PRODUCTS, NAMELY, PINS, PENDANTS, AND ORNAMENTS IN STERLING SILVER, PEWTER AND OTHER PRECIOUS AND SEMI-PRECIOUS METALS (U.S. CLS. 2, 27, 28 AND 50).
FIRST USE 11-1-2005; IN COMMERCE 11-1-2005.

3,314,190. QUANTUM JEWELRY DISTRIBUTORS, INC., KENT, OH. SN 78-784,799. PUB. 3-27-2007, FILED 1-4-2006.



FOR JEWELRY, JEWELRY PRODUCTS, NAMELY, PINS, PENDANTS, AND ORNAMENTS IN STERLING SILVER, PEWTER, AND OTHER PRECIOUS AND SEMI-PRECIOUS METALS (U.S. CLS. 2, 27, 28 AND 50).
FIRST USE 11-1-2005; IN COMMERCE 11-1-2005.

CLASS 14—(Continued).

3,314,260. YES I AM PRODUCTS, LLC, LARGO, FL. SN 78-795,877. PUB. 9-12-2006, FILED 1-20-2006.



FOR JEWELRY, NAMELY, PINS AND NECKLACE PENDANTS (U.S. CLS. 2, 27, 28 AND 50).
FIRST USE 1-1-2006; IN COMMERCE 1-1-2006.

3,314,314. INVICTA WATCH COMPANY OF AMERICA, INC., HOLLYWOOD, FL. SN 78-808,761. PUB. 10-3-2006, FILED 2-7-2006.

INVICTA ANATOMIC

THE MARK CONSISTS OF STANDARD CHARACTERS WITHOUT CLAIM TO ANY PARTICULAR FONT, STYLE, SIZE, OR COLOR.

THE ENGLISH TRANSLATION OF THE WORD INVICTA IN THE MARK IS UNCONQUERED.

FOR HOROLOGICAL AND CHRONOMETRIC INSTRUMENTS AND CASES THEREFOR (U.S. CLS. 2, 27, 28 AND 50).

FIRST USE 11-20-2006; IN COMMERCE 1-18-2007.

3,314,695. J. EDWARDS JEWELRY DISTRIBUTING LLC, DBA J. EDWARDS DIAMONDS, EL PASO, TX. SN 78-909,558. PUB. 1-23-2007, FILED 6-15-2006.

INFINITY-STAR

THE MARK CONSISTS OF STANDARD CHARACTERS WITHOUT CLAIM TO ANY PARTICULAR FONT, STYLE, SIZE, OR COLOR.

FOR DIAMONDS (U.S. CLS. 2, 27, 28 AND 50).
FIRST USE 5-6-2006; IN COMMERCE 6-1-2006.

CLASS 14—(Continued).

3,314,728. AUCOIN HART JEWELERS, INC., METAIRIE, LA.
SN 78-918,819. PUB. 1-30-2007, FILED 6-28-2006.



FOR JEWELRY (U.S. CLS. 2, 27, 28 AND 50).
FIRST USE 12-0-2006; IN COMMERCE 12-0-2006.

CLASS 14—(Continued).

3,314,856. CREATIVE COTERIE, INC., NEWPORT BEACH,
CA. SN 78-961,559. PUB. 4-17-2007, FILED 8-28-2006.

Resurrected Beauty

THE MARK CONSISTS OF STANDARD CHARACTERS
WITHOUT CLAIM TO ANY PARTICULAR FONT, STYLE,
SIZE, OR COLOR.

FOR JEWELRY (U.S. CLS. 2, 27, 28 AND 50).
FIRST USE 1-14-2007; IN COMMERCE 1-14-2007.

3,314,764. PSI CORPORATION LIMITED, KOWLOON,
HONG KONG. SN 78-933,421. PUB. 3-6-2007, FILED 7-20-
2006.



THE ENGLISH TRANSLATION OF THE WORD LA
CERISAIE IN THE MARK IS THE CHERRY ORCHARD.

FOR PRECIOUS STONES; PRECIOUS GEMSTONES;
JEWELRY CHAINS; RINGS BEING JEWELRY; PINS
BEING JEWELRY; BRACELETS BEING JEWELRY;
CHARMS BEING PERSONAL JEWELRY; JADE BEING
JEWELRY; JEWELRY FOR THE HEAD; JEWELRY
WATCHES; WATCHES; CLOCKS; ORNAMENTS OF
PRECIOUS METAL; SHOE ORNAMENTS OF PRECIOUS
METAL; HAT ORNAMENTS OF PRECIOUS METAL;
ORNAMENTAL PINS; KEY CHAINS OF PRECIOUS
METAL; JEWELRY BOXES OF PRECIOUS METAL;
DECORATIVE BOXES MADE OF PRECIOUS METAL;
PRECIOUS METALS AND THEIR ALLOYS, NAMELY,
GOLD, SILVER (U.S. CLS. 2, 27, 28 AND 50).
FIRST USE 8-31-2007; IN COMMERCE 8-31-2007.

CLASS 15—MUSICAL INSTRUMENTS

3,314,148. STANNARD, JOHN, CLEARWATER, FL. SN 78-
776,823. PUB. 9-5-2006, FILED 12-20-2005.

HELLBELL

THE MARK CONSISTS OF STANDARD CHARACTERS
WITHOUT CLAIM TO ANY PARTICULAR FONT, STYLE,
SIZE, OR COLOR.

FOR CYMBALS AND PERCUSSION INSTRUMENTS
(U.S. CLS. 2, 21 AND 36).
FIRST USE 8-1-2006; IN COMMERCE 8-1-2006.

CLASS 15—(Continued).

3,314,862. K.H.S. MUSICAL INSTRUMENT CO., LTD., LUZHOU CITY, TAIWAN. SN 78-963,568. PUB. 1-9-2007, FILED 8-30-2006.



FOR BRASS INSTRUMENTS; ELECTRONIC MUSICAL INSTRUMENTS; KEYBOARD INSTRUMENTS; PERCUSSION INSTRUMENTS; REED INSTRUMENTS; STRINGED INSTRUMENTS; WOODWIND INSTRUMENTS; WIND INSTRUMENTS; PEDALS FOR MUSICAL INSTRUMENTS, NAMELY SOUND EFFECT PEDALS FOR PIANOS, DRUM SETS, CYMBALS, ELECTRONIC DRUM SETS AND ELECTRONIC MUSICAL INSTRUMENTS; STANDS FOR MUSICAL INSTRUMENTS; DISPLAY STANDS FOR MUSICAL INSTRUMENTS; DRUM PRACTICE PADS; GUITAR STANDS; KEYBOARD STANDS; STANDS FOR DRUM SETS; SHEET MUSIC STANDS; CYMBALS; CYMBAL STANDS; TIMPANI STANDS; DRUMS; SNARE DRUMS; DRUMSTICKS; DRUMHEADS; CARRYING CASES FOR MUSICAL INSTRUMENTS; GUITARS; GUITAR PICKS; GUITAR STRINGS; MUSIC SYNTHESIZERS; ACCORDIONS; HARMONICAS (U.S. CLS. 2, 21 AND 36).
FIRST USE 1-20-2007; IN COMMERCE 1-20-2007.

CLASS 16—(Continued).

3,312,991. PARRAGON BOOKS LIMITED, BATH, UNITED KINGDOM. SN 76-193,708. PUB. 3-29-2005, FILED 1-12-2001.



PRIORITY CLAIMED UNDER SEC. 44(D) ON UNITED KINGDOM APPLICATION NO. 2239316B, FILED 7-12-2000, REG. NO. 2239316B, DATED 4-2-2004, EXPIRES 7-12-2010.
THE MARK CONSISTS OF A STYLIZED STAR DESIGN WITH THE TEXT "BRIGHT" DISPOSED ABOVE THE STAR AND THE TEXT "SPARKS" BELOW.
FOR BOOKS FOR CHILDREN; PRINTED PUBLICATIONS FOR CHILDREN (U.S. CLS. 2, 5, 22, 23, 29, 37, 38 AND 50).
FIRST USE 10-1-2000; IN COMMERCE 10-1-2000.

3,312,997. BUILD-A-BEAR RETAIL MANAGEMENT, INC., ST. LOUIS, MO. SN 76-333,920. PUB. 6-18-2002, FILED 11-5-2001.

BUILD-A-PAGE

CLASS 16—PAPER GOODS AND PRINTED MATTER

FOR PRINTED PAPER USED FOR SCRAPBOOKING (U.S. CLS. 2, 5, 22, 23, 29, 37, 38 AND 50).
FIRST USE 8-1-2002; IN COMMERCE 8-1-2002.

CLASS 16—(Continued).

3,313,007. AMERICAN BIBLE SOCIETY, NEW YORK, NY. SN 76-442,874. PUB. 6-8-2004, FILED 8-22-2002.



NO CLAIM IS MADE TO THE EXCLUSIVE RIGHT TO USE "CONTEMPORARY ENGLISH VERSION", APART FROM THE MARK AS SHOWN.

THE DESIGN PORTION OF THE MARK CONSISTS OF "THE WORD" WITH CROSS SYMBOL.

FOR BIBLES, BOOKS, STUDY GUIDES, WORKBOOKS, NEWSLETTERS, BROCHURES, LEAFLETS, INFORMATIONAL FLYERS, BOOKLETS, AND PRINTED INSTRUCTIONAL MATERIALS RELATING TO THE BIBLE, CHRISTIANITY, RELIGION, AND SPIRITUALITY; CATALOGS; RELIGIOUS CIRCULAR LETTERS; POSTERS; PENS; PENCILS; NOTE CARDS; GREETING CARDS; OCCASION CARDS; CALENDARS; WALL CALENDARS; POCKET CALENDARS; DESK CALENDARS; PRINTED PAPER SIGNS; PAPER BANNERS; BOOKMARKS; PRINTED LABELS; STICKERS; FOLDERS; BOOK COVERS; BOOK PLATES; DECALS; PAPER PADS; STATIONERY; AND ENVELOPES (U.S. CLS. 2, 5, 22, 23, 29, 37, 38 AND 50).

FIRST USE 2-4-2003; IN COMMERCE 2-4-2003.

3,313,034. NEWMAN, ROBERT D., GREENWOOD, MO. AND SPECIALTY PRODUCTS OF GREENWOOD, MISSOURI, INC., GREENWOOD, MO. SN 76-540,921. PUB. 7-27-2004, FILED 8-29-2003.

UP AGAINST THE WALL

FOR PAINT APPLICATION KIT COMPRISED OF PAINT TRAY, PAINT APPLICATORS FOR USE IN CORNERS AND ON TRIM, PAINT ROLLER, ROLLER FRAME AND EXTENSION POLE, ALL SOLD AS A UNIT (U.S. CLS. 2, 5, 22, 23, 29, 37, 38 AND 50).

FIRST USE 4-12-2007; IN COMMERCE 4-12-2007.

3,313,060. AMERICAN SOCIETY OF CONSULTANT PHARMACISTS RESEARCH AND EDUCATION FOUNDATION, INC., ALEXANDRIA, VA. SN 76-601,624. PUB. 11-15-2005, FILED 7-9-2004.

THE FLEETWOOD PROJECT

THE MARK CONSISTS OF STANDARD CHARACTERS WITHOUT CLAIM TO ANY PARTICULAR FONT, STYLE, SIZE, OR COLOR.

FOR PRINTED PUBLICATIONS, NAMELY BOOKS, MAGAZINES, NEWSLETTERS, JOURNALS IN THE FIELD OF PHARMACY PRACTICE (U.S. CLS. 2, 5, 22, 23, 29, 37, 38 AND 50).

FIRST USE 11-0-2006; IN COMMERCE 11-0-2006.

CLASS 16—(Continued).

3,313,116. FISHER, JUANITA B., VALLEJO, CA. SN 76-635,041. PUB. 7-25-2006, FILED 4-4-2005.



THE COLOR(S) RED AND BLACK IS/ARE CLAIMED AS A FEATURE OF THE MARK.

THE COLOR RED APPEARS IN THE LINE UNDERNEATH THE WORDING SILLA SMILES ONLY. THE COLOR BLACK APPEARS IN THE REMAINDER OF THE MARK.

FOR CHILDREN'S ACTIVITY BOOKS, CHILDREN'S BOOKS, PRAYER BOOKS, RELIGIOUS BOOKS, BOOKS ON CHILDREN'S SAFETY, NON-FICTION BOOKS ON RELATIONSHIP, TALKING CHILDREN'S BOOKS, WIREBOUND BOOKS, GREETING CARDS, MUSICAL GREETING CARDS, PRINTED GREETING CARDS WITH ELECTRONIC INFORMATION STORED THEREIN, PAPER STATIONERY, STATIONERY WRITING PAPER AND ENVELOPES, STATIONERY-TYPE PORTFOLIOS, STICKERS (U.S. CLS. 2, 5, 22, 23, 29, 37, 38 AND 50).

FIRST USE 3-7-2007; IN COMMERCE 3-7-2007.

3,313,127. ICHABOD INK, LLC, WEST CHESTER, PA. SN 76-636,703. PUB. 8-8-2006, FILED 4-21-2005.



THE COLORS YELLOW, PINK, BLUE, BLACK AND WHITE ARE CLAIMED AS FEATURES OF THE MARK.

THE MARK CONSISTS OF A TOP LEFT CIRCLE IS SHOWN IN THE COLOR PINK AND OUTLINED IN WHITE; THE TOP RIGHT CIRCLE IS SHOWN IN THE COLOR YELLOW AND OUTLINED IN WHITE, THE BOTTOM RIGHT CIRCLE IS SHOWN IN BLACK AND OUTLINED IN WHITE; AND THE BOTTOM LEFT CIRCLE IS SHOWN IN BLUE AND OUTLINED IN WHITE AND WITH A WHITE LINE TO THE RIGHT OF THE CIRCLE. THE BOTTOM RIGHT CIRCLE ALSO CONTAINS A WHITE-LINED CARTOON DRAWING OF A DOGFACE. THE CIRCLES AND DOG DESIGN APPEAR AGAINST A SQUARE BACKGROUND IN THE COLOR BLACK. THE WORDING ICHABOD INK APPEARS IN THE COLOR BLACK.

FOR PRINTED MATTER, NAMELY, EDUCATIONAL CHILDREN'S BOOKS, TEACHER RESOURCES IN THE NATURE OF MANUALS AND EDUCATIONAL BROCHURES ALL IN THE FIELD OF VETERINARY MEDICINE (U.S. CLS. 2, 5, 22, 23, 29, 37, 38 AND 50).

FIRST USE 1-26-2006; IN COMMERCE 1-26-2006.

CLASS 16—(Continued).

3,313,137. DYMO CORPORATION, STAMFORD, CT. SN 76-640,117. PUB. 2-28-2006, FILED 6-3-2005.

COOL CLICKS

THE MARK CONSISTS OF STANDARD CHARACTERS WITHOUT CLAIM TO ANY PARTICULAR FONT, STYLE, SIZE, OR COLOR.

FOR HAND HELD LABELMAKER/EMBOSSER (U.S. CLS. 2, 5, 22, 23, 29, 37, 38 AND 50).

FIRST USE 1-1-2006; IN COMMERCE 1-1-2006.

3,313,238. COLORKEYS INCORPORATED, TORONTO, ONTARIO, CANADA. SN 76-978,633. PUB. 3-21-2006, FILED 1-3-2005.

COLORKEYS

FOR PRINTED EDUCATIONAL MATERIALS FOR MUSIC INSTRUCTION, SHEET MUSIC, DECALS AND STICKERS (U.S. CLS. 2, 5, 22, 23, 29, 37, 38 AND 50).

FIRST USE 2-23-2007; IN COMMERCE 2-23-2007.

3,313,295. POTLATCH FOREST PRODUCTS CORPORATION, SPOKANE, WA. SN 77-025,127. PUB. 4-17-2007, FILED 10-19-2006.

FOR A CLEAN, LINT-CLEAR FINISH

THE MARK CONSISTS OF STANDARD CHARACTERS WITHOUT CLAIM TO ANY PARTICULAR FONT, STYLE, SIZE, OR COLOR.

FOR PAPER TOWELS (U.S. CLS. 2, 5, 22, 23, 29, 37, 38 AND 50).

FIRST USE 8-1-2007; IN COMMERCE 8-1-2007.

CLASS 16—(Continued).

3,313,376. NELSON, JEFFERY J., CHATHAM, MA. SN 78-246,176. PUB. 12-23-2003, FILED 5-6-2003.



NO CLAIM IS MADE TO THE EXCLUSIVE RIGHT TO USE "TALES", APART FROM THE MARK AS SHOWN.

FOR SERIES OF BOOKS CONTAINING POEMS (U.S. CLS. 2, 5, 22, 23, 29, 37, 38 AND 50).

FIRST USE 2-24-2007; IN COMMERCE 2-24-2007.

3,313,388. JAKKS PACIFIC, INC., MALIBU, CA. SN 78-266,616. PUB. 2-17-2004, FILED 6-24-2003.

MATISSE

FOR PENS (U.S. CLS. 2, 5, 22, 23, 29, 37, 38 AND 50).

FIRST USE 12-11-2006; IN COMMERCE 12-11-2006.

3,313,395. CURTCO ROBB MEDIA, L.L.C., MALIBU, CA. SN 78-282,977. PUB. 8-30-2005, FILED 8-4-2003.

ROBB REPORT SPORTS & LUXURY AUTOMOBILE

THE MARK CONSISTS OF STANDARD CHARACTERS WITHOUT CLAIM TO ANY PARTICULAR FONT, STYLE, SIZE, OR COLOR.

NO CLAIM IS MADE TO THE EXCLUSIVE RIGHT TO USE "SPORTS & LUXURY AUTOMOBILE", APART FROM THE MARK AS SHOWN.

FOR MAGAZINES ON THE SUBJECT OF VARIOUS TOPICS OF INTEREST TO SUCCESSFUL PEOPLE AND ENTHUSIASTS RELATED TO NEW AND CLASSIC SPORTS CARS AND LUXURY CARS FOR GENERAL CIRCULATION (U.S. CLS. 2, 5, 22, 23, 29, 37, 38 AND 50).

FIRST USE 11-14-2006; IN COMMERCE 11-14-2006.

CLASS 16—(Continued).

3,313,399. MORRISON, CYNTHIA L., OCOEE, FL. SN 78-305,150. PUB. 8-31-2004, FILED S.R. 9-25-2003; AM. P.R. 8-15-2007.

"TRUST GOD WHEN YOU CAN'T
TRACE HIM; PRAYER REACHES
WHERE YOU CAN'T GO!"

THE MARK CONSISTS OF STANDARD CHARACTERS WITHOUT CLAIM TO ANY PARTICULAR FONT, STYLE, SIZE, OR COLOR.

FOR BOOKMARKS, RUBBER STAMPS, PENS AND NOTE PADS (U.S. CLS. 2, 5, 22, 23, 29, 37, 38 AND 50).
FIRST USE 4-12-2006; IN COMMERCE 4-12-2006.

3,313,419. INTEK AMERICA, INC., TORRANCE, CA. SN 78-355,544. PUB. 7-5-2005, FILED 1-22-2004.

INFOGUARD

THE MARK CONSISTS OF STANDARD CHARACTERS WITHOUT CLAIM TO ANY PARTICULAR FONT, STYLE, SIZE, OR COLOR.

FOR ELECTRIC AND NON ELECTRIC PAPER SHREDDERS (U.S. CLS. 2, 5, 22, 23, 29, 37, 38 AND 50).
FIRST USE 2-1-2004; IN COMMERCE 2-1-2004.

3,313,439. ALTANA PHARMA AG, KONSTANZ, FED REP GERMANY. SN 78-389,418. PUB. 3-22-2005, FILED 3-23-2004.



THE MARK CONSISTS OF AN UPWARD POINTING ARROW TO THE LEFT OF THE LETTER "R" IN THE WORD GERDYZER.

FOR PRINTED MATTER, NAMELY QUESTIONNAIRES FOR THE ENTRY OF MEDICAL DATA; INSTRUCTIONAL AND TEACHING MATERIAL FOR MEDICINE AND SCIENCE, EXCLUDING APPARATUS (U.S. CLS. 2, 5, 22, 23, 29, 37, 38 AND 50).
FIRST USE 1-20-2004; IN COMMERCE 11-22-2005.

CLASS 16—(Continued).

3,313,440. ALTANA PHARMA AG, KONSTANZ, FED REP GERMANY. SN 78-389,430. PUB. 3-22-2005, FILED 3-23-2004.



THE COLOR(S) BLUE, ORANGE AND WHITE IS/ARE CLAIMED AS A FEATURE OF THE MARK.

THE MARK CONSISTS OF AN UPWARD POINTING ORANGE ARROW TO THE LEFT OF THE WHITE LETTER "R" IN THE WORD GERDYZER, ALL INSIDE A BLUE RECTANGLE.

FOR PRINTED MATTER, NAMELY QUESTIONNAIRES FOR THE ENTRY OF MEDICAL DATA; INSTRUCTIONAL AND TEACHING MATERIAL FOR MEDICINE AND SCIENCE, EXCLUDING APPARATUS (U.S. CLS. 2, 5, 22, 23, 29, 37, 38 AND 50).
FIRST USE 1-20-2004; IN COMMERCE 11-22-2005.

3,313,509. DIAMOND GAME ENTERPRISES, INC., CHATSWORTH, CA. SN 78-503,472. PUB. 9-27-2005, FILED 10-21-2004.

PEELERS

THE MARK CONSISTS OF STANDARD CHARACTERS WITHOUT CLAIM TO ANY PARTICULAR FONT, STYLE, SIZE, OR COLOR.

FOR PRINTED GAMES OF CHANCE TICKETS (U.S. CLS. 2, 5, 22, 23, 29, 37, 38 AND 50).
FIRST USE 7-0-2005; IN COMMERCE 7-0-2005.

CLASS 16—(Continued).

3,313,552. UK INDUSTRIAL TAPES LIMITED, GATESHEAD, UNITED KINGDOM. SN 78-550,568. PUB. 8-29-2006, FILED 1-20-2005.

STIX2

THE MARK CONSISTS OF STANDARD CHARACTERS WITHOUT CLAIM TO ANY PARTICULAR FONT, STYLE, SIZE, OR COLOR.

PRIORITY CLAIMED UNDER SEC. 44(D) ON ERP NCNTY TM OFC APPLICATION NO. 004015582, FILED 9-8-2004, REG. NO. 004015582, DATED 10-18-2005, EXPIRES 9-8-2014.

FOR ADHESIVE TAPES, SELF-ADHESIVE TAPES, GUMMED ADHESIVE TAPES, SINGLE SIDED ADHESIVE TAPES, AND DOUBLE SIDED ADHESIVE TAPES FOR HOUSEHOLD AND STATIONERY USE (U.S. CLS. 2, 5, 22, 23, 29, 37, 38 AND 50).
FIRST USE 2-7-2006; IN COMMERCE 2-11-2006.

3,313,601. KALIL, CAROLYN, PACIFIC PALISADES, CA. SN 78-587,085. PUB. 12-20-2005, FILED 3-14-2005.

The Four Colors

THE MARK CONSISTS OF STANDARD CHARACTERS WITHOUT CLAIM TO ANY PARTICULAR FONT, STYLE, SIZE, OR COLOR.

FOR SERIES OF NON-FICTION BOOKS AND MAGAZINES IN THE FIELD OF INSPIRATION AND SELF-ESTEEM AND RELATIONSHIPS (U.S. CLS. 2, 5, 22, 23, 29, 37, 38 AND 50).
FIRST USE 4-1-2006; IN COMMERCE 4-1-2006.

CLASS 16—(Continued).

3,313,626. PIONEER INTERSTATE, INC., DBA TIGER CLAW, KNOXVILLE, TN. SN 78-605,109. PUB. 8-22-2006, FILED 4-8-2005.



THE MARK CONSISTS OF A KICKING TIGER. FOR STICKERS (U.S. CLS. 2, 5, 22, 23, 29, 37, 38 AND 50).

FIRST USE 8-0-2004; IN COMMERCE 5-8-2007.

3,313,637. EMPIRE BEAUTY SCHOOL, INC, POTTSVILLE, PA. SN 78-609,627. PUB. 1-17-2006, FILED 4-15-2005.

LOVE WHAT YOU DO!

THE MARK CONSISTS OF STANDARD CHARACTERS WITHOUT CLAIM TO ANY PARTICULAR FONT, STYLE, SIZE, OR COLOR.

FOR PRINTED INSTRUCTIONAL, EDUCATIONAL AND TEACHING MATERIALS IN THE FIELD OF COSMETOLOGY (U.S. CLS. 2, 5, 22, 23, 29, 37, 38 AND 50).

FIRST USE 4-0-2005; IN COMMERCE 3-0-2006.

3,313,713. THE SMEAD MANUFACTURING COMPANY, HASTINGS, MN. SN 78-640,175. PUB. 8-22-2006, FILED 5-31-2005.

CALM

THE MARK CONSISTS OF STANDARD CHARACTERS WITHOUT CLAIM TO ANY PARTICULAR FONT, STYLE, SIZE, OR COLOR.

FOR OFFICE SUPPLIES, NAMELY, FILE FOLDERS, HANGING FOLDERS, PAPER EXPANDING FILES (U.S. CLS. 2, 5, 22, 23, 29, 37, 38 AND 50).

FIRST USE 6-0-2005; IN COMMERCE 12-0-2005.

CLASS 16—(Continued).

3,313,714. LEADERWORK INTERNATIONAL LIMITED, TORTOLA, BR. VIRGIN ISLANDS. SN 78-640,347. PUB. 5-23-2006, FILED 5-31-2005.

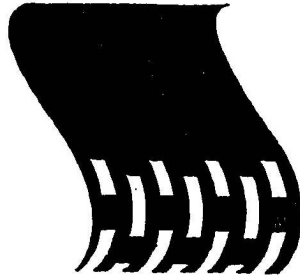

FOR PAPER SHREDDERS FOR OFFICE USE (U.S. CLS. 2, 5, 22, 23, 29, 37, 38 AND 50).
FIRST USE 6-12-2005; IN COMMERCE 5-10-2006.

CLASS 16—(Continued).

3,313,743. WILD BIRD CENTERS OF AMERICA, INC., GLEN ECHO, MD. SN 78-652,352. PUB. 2-28-2006, FILED 6-16-2005.

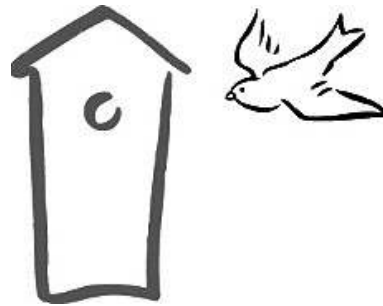

THE MARK CONSISTS OF A LEFTWARD-FACING BIRD ON THE RIGHT AND A BIRDHOUSE ON THE LEFT.
FOR DECALS AND BANNERS (U.S. CLS. 2, 5, 22, 23, 29, 37, 38 AND 50).
FIRST USE 1-10-2005; IN COMMERCE 1-10-2005.

3,313,736. NOVA GRAFON'S GRÁFICA E EDITORA LTDA, BARUERI - SP, BRAZIL. SN 78-651,066. PUB. 9-5-2006, FILED 6-15-2005.

GRAFON'S

THE MARK CONSISTS OF STANDARD CHARACTERS WITHOUT CLAIM TO ANY PARTICULAR FONT, STYLE, SIZE, OR COLOR.
FOR UNIVERSITY CARD INDEX NOTEBOOKS, COLLEGIAL CARD INDEX NOTEBOOKS, UNIVERSITY NOTEBOOKS, COLLEGIAL NOTEBOOKS, INDEX CARD SEPARATORS, REFILL CARD INDEX BLOCKS, SMALL NOTEBOOKS, ADHESIVES FOR STATIONARY AND HOUSEHOLD USE, BLOCKS FOR NOTATIONS (U.S. CLS. 2, 5, 22, 23, 29, 37, 38 AND 50).
FIRST USE 10-0-2004; IN COMMERCE 5-0-2006.

3,313,769. NATIONAL CONFERENCE OF STANDARDS LABORATORIES, BOULDER, CO. SN 78-662,159. PUB. 3-14-2006, FILED 6-30-2005.

NCSLI

THE MARK CONSISTS OF STANDARD CHARACTERS WITHOUT CLAIM TO ANY PARTICULAR FONT, STYLE, SIZE, OR COLOR.
FOR PRINTED MATTER AND REFERENCE MATERIALS, NAMELY, NEWSLETTERS, EDUCATIONAL GUIDES, PROGRAM BOOKS, INSTRUCTIONAL MATERIALS, PAMPHLETS, BROCHURES AND BOOKS ALL IN THE FIELD OF PHYSICAL STANDARDS OF MEASUREMENT, THE CALIBRATION OF MEASURING INSTRUMENTS AND THE SPECIFICATION OF MEASUREMENT METHODS (U.S. CLS. 2, 5, 22, 23, 29, 37, 38 AND 50).
FIRST USE 12-15-2006; IN COMMERCE 12-15-2006.

CLASS 16—(Continued).

3,313,785. SWINGER, TRUYEN, NEW YORK, NY. SN 78-670,663. PUB. 9-5-2006, FILED 7-14-2005.

The Truth, the Whole Truth
and Nothing but the Truth

THE MARK CONSISTS OF STANDARD CHARACTERS WITHOUT CLAIM TO ANY PARTICULAR FONT, STYLE, SIZE, OR COLOR.

FOR DIARIES; BLANK WRITING JOURNALS; BLANK JOURNAL BOOKS; BLANK WRITING JOURNALS AND BLANK JOURNAL BOOKS CONTAINING INSPIRATIONAL QUOTES AND MESSAGES (U.S. CLS. 2, 5, 22, 23, 29, 37, 38 AND 50).

FIRST USE 12-14-2006; IN COMMERCE 12-14-2006.

3,313,821. GENERAL BINDING CORPORATION, LINCOLNSHIRE, IL. SN 78-686,182. PUB. 10-31-2006, FILED 8-4-2005.

ProClick Pronto

THE MARK CONSISTS OF STANDARD CHARACTERS WITHOUT CLAIM TO ANY PARTICULAR FONT, STYLE, SIZE, OR COLOR.

OWNER OF U.S. REG. NOS. 2,644,545 AND 2,921,390.
FOR BINDING EQUIPMENT FOR PUNCHING AND INSERTING PLASTIC SPIRAL BINDING ELEMENTS; BINDING SUPPLIES, NAMELY PAPER HOLE PUNCHES, PRE-PUNCHED PAPER AND PRE-PUNCHED COVERS, PLASTIC SPIRAL BINDING ELEMENTS; AND BINDING KITS CONTAINING PLASTIC SPIRAL BINDING ELEMENTS, PRE-PUNCHED PAPER AND PRE-PUNCHED COVERS (U.S. CLS. 2, 5, 22, 23, 29, 37, 38 AND 50).

FIRST USE 10-6-2005; IN COMMERCE 10-6-2005.

CLASS 16—(Continued).

3,313,830. INTERNATIONAL PAPER COMPANY, MEMPHIS, TN. SN 78-692,318. PUB. 6-6-2006, FILED 8-15-2005.



NO CLAIM IS MADE TO THE EXCLUSIVE RIGHT TO USE "TECHNOLOGIES", APART FROM THE MARK AS SHOWN.

FOR PAPER FOR PRINTING, PUBLICATION, REPRODUCTION, COPYING AND WRITING; COVER PAPER, BOND PAPER, ENVELOPE PAPER, LASER PAPER, OFFSET PAPER, INKJET PAPER, MULTI-PURPOSE PAPER, COMPUTER AND FORMS PAPER; AND PAPERBOARD (U.S. CLS. 2, 5, 22, 23, 29, 37, 38 AND 50).

FIRST USE 10-1-2005; IN COMMERCE 10-1-2005.

3,313,831. INTERNATIONAL PAPER COMPANY, MEMPHIS, TN. SN 78-692,320. PUB. 5-9-2006, FILED 8-15-2005.

VIP

THE MARK CONSISTS OF STANDARD CHARACTERS WITHOUT CLAIM TO ANY PARTICULAR FONT, STYLE, SIZE, OR COLOR.

FOR PAPER FOR PRINTING, PUBLICATION, REPRODUCTION, COPYING AND WRITING; COVER PAPER, BOND PAPER, ENVELOPE PAPER, LASER PAPER, OFFSET PAPER, INKJET PAPER, MULTI-PURPOSE PAPER, COMPUTER AND FORMS PAPER; AND PAPERBOARD (U.S. CLS. 2, 5, 22, 23, 29, 37, 38 AND 50).

FIRST USE 10-1-2005; IN COMMERCE 10-1-2005.

3,313,849. COLOR MY WORLD, INC., KINGSTON, PA. SN 78-700,418. PUB. 11-14-2006, FILED 8-25-2005.

ImageStix

THE MARK CONSISTS OF STANDARD CHARACTERS WITHOUT CLAIM TO ANY PARTICULAR FONT, STYLE, SIZE, OR COLOR.

FOR HEAT TRANSFER PAPER (U.S. CLS. 2, 5, 22, 23, 29, 37, 38 AND 50).

FIRST USE 3-8-2007; IN COMMERCE 3-8-2007.

CLASS 16—(Continued).

3,313,897. EDUFARM, LLC, CARY, NC. SN 78-718,185. PUB. 6-20-2006, FILED 9-22-2005.

EDUFARM

THE MARK CONSISTS OF STANDARD CHARACTERS WITHOUT CLAIM TO ANY PARTICULAR FONT, STYLE, SIZE, OR COLOR.

FOR PRINTED INSTRUCTIONAL AND TEACHING MATERIAL USED IN TRAINING ABOUT PHARMACEUTICAL DEVELOPMENT AND PHARMACEUTICAL REGISTRATION (U.S. CLS. 2, 5, 22, 23, 29, 37, 38 AND 50).

FIRST USE 7-9-2007; IN COMMERCE 7-9-2007.

3,313,967. JAFER LIMITED, HAMILTON HM12, BERMUDA. SN 78-746,577. PUB. 3-27-2007, FILED 11-3-2005.

ENTRE NOS

THE MARK CONSISTS OF STANDARD CHARACTERS WITHOUT CLAIM TO ANY PARTICULAR FONT, STYLE, SIZE, OR COLOR.

THE ENGLISH TRANSLATION OF "ENTRE NOS" IS "BETWEEN US"

FOR SPANISH LANGUAGE MAGAZINE FEATURING WOMEN'S PERFUMES, MAKEUP AND COSMETICS (U.S. CLS. 2, 5, 22, 23, 29, 37, 38 AND 50).

FIRST USE 10-1-1997; IN COMMERCE 7-12-2007.

3,314,082. BLUE KANGAROO LIMITED, LONDON, UNITED KINGDOM. SN 78-766,757. PUB. 10-10-2006, FILED 12-5-2005.

BLUE KANGAROO

THE MARK CONSISTS OF STANDARD CHARACTERS WITHOUT CLAIM TO ANY PARTICULAR FONT, STYLE, SIZE, OR COLOR.

FOR STICKERS, STICKER PACKS (U.S. CLS. 2, 5, 22, 23, 29, 37, 38 AND 50).

FIRST USE 2-10-2006; IN COMMERCE 2-10-2006.

CLASS 16—(Continued).

3,314,083. BLUE KANGAROO LIMITED, LONDON, UNITED KINGDOM. SN 78-766,794. PUB. 10-10-2006, FILED 12-5-2005.



THE MARK CONSISTS OF KANGAROO. FOR STICKERS, STICKER PACKS (U.S. CLS. 2, 5, 22, 23, 29, 37, 38 AND 50).

FIRST USE 2-10-2006; IN COMMERCE 2-10-2006.

3,314,090. DEPARTMENT OF DEFENSE, WASHINGTON, DC. SN 78-767,697. PUB. 8-8-2006, FILED 12-6-2005.

STRIPES

THE MARK CONSISTS OF STANDARD CHARACTERS WITHOUT CLAIM TO ANY PARTICULAR FONT, STYLE, SIZE, OR COLOR.

FOR BALL-POINT PENS; CALENDARS; FELT-TIP PENS; FOLDERS; GREETING CARDS; MAGAZINES FEATURING TRAVEL AND GENERAL INTEREST NEWS ABOUT THE MILITARY; NEWSPAPERS; PICTURE BOOKS; PICTURE POSTCARDS; PICTURES; POSTERS; TRAVEL BOOKS (U.S. CLS. 2, 5, 22, 23, 29, 37, 38 AND 50).

FIRST USE 1-24-2007; IN COMMERCE 1-24-2007.

CLASS 16—(Continued).

3,314,095. CLIP-RITE INC., HAYWARD, CA. SN 78-768,115. PUB. 8-15-2006, FILED 12-7-2005.

CLIP-RITE

THE MARK CONSISTS OF STANDARD CHARACTERS WITHOUT CLAIM TO ANY PARTICULAR FONT, STYLE, SIZE, OR COLOR.

FOR PAPER CLIPS; BINDER CLIPS; INDEX TABS; REINFORCED STATIONERY TABS; NOTE PADS; STATIONERY NOTES; ADHESIVE NOTE PAPER; PRINTED INDEX TABS AND PRINTED REINFORCED STATIONERY TABS FEATURING MESSAGES, PICTURES OR ORNAMENTAL DESIGNS; AND DISPENSERS AND CASES FOR ALL OF THE AFOREMENTIONED GOODS; AND OFFICE OR STATIONERY SUPPLIES NAMELY PAPER FASTENERS, NAMELY PAPER CLIPS AND/OR BINDER CLIPS, WITH PAPER, CARD STOCK, OR PLASTIC SHEETS FOR WRITING, PRINTING AND MARKING SOLD AS A UNIT (U.S. CLS. 2, 5, 22, 23, 29, 37, 38 AND 50).

FIRST USE 6-7-2006; IN COMMERCE 6-7-2006.

3,314,166. DAP BRANDS COMPANY, MEDINA, OH. SN 78-779,224. PUB. 9-5-2006, FILED 12-22-2005.

STIKAROUNDS

THE MARK CONSISTS OF STANDARD CHARACTERS WITHOUT CLAIM TO ANY PARTICULAR FONT, STYLE, SIZE, OR COLOR.

FOR GLUE FOR STATIONERY OR HOUSEHOLD USE (U.S. CLS. 2, 5, 22, 23, 29, 37, 38 AND 50).

FIRST USE 9-0-2006; IN COMMERCE 9-0-2006.

3,314,211. MEADWESTVACO CORPORATION, GLEN ALLEN, VA. SN 78-788,241. PUB. 8-15-2006, FILED 1-10-2006.

PAGE JOG

THE MARK CONSISTS OF STANDARD CHARACTERS WITHOUT CLAIM TO ANY PARTICULAR FONT, STYLE, SIZE, OR COLOR.

NO CLAIM IS MADE TO THE EXCLUSIVE RIGHT TO USE "PAGE", APART FROM THE MARK AS SHOWN.

FOR PERSONAL ORGANIZERS (U.S. CLS. 2, 5, 22, 23, 29, 37, 38 AND 50).

FIRST USE 7-27-2006; IN COMMERCE 7-27-2006.

CLASS 16—(Continued).

3,314,230. P. H. GLATFELTER COMPANY, YORK, PA. SN 78-791,696. PUB. 1-16-2007, FILED 1-13-2006.

G COLORS

THE MARK CONSISTS OF STANDARD CHARACTERS WITHOUT CLAIM TO ANY PARTICULAR FONT, STYLE, SIZE, OR COLOR.

NO CLAIM IS MADE TO THE EXCLUSIVE RIGHT TO USE "COLORS", APART FROM THE MARK AS SHOWN.

FOR ENVELOPE PAPERS (U.S. CLS. 2, 5, 22, 23, 29, 37, 38 AND 50).

FIRST USE 4-16-2007; IN COMMERCE 4-16-2007.

3,314,283. VIRGIN COMICS, LLC, HOLMDEL, NJ. SN 78-801,642. PUB. 9-26-2006, FILED 1-28-2006.

SNAKE WOMAN

THE MARK CONSISTS OF STANDARD CHARACTERS WITHOUT CLAIM TO ANY PARTICULAR FONT, STYLE, SIZE, OR COLOR.

FOR PRINTED MATTER, NAMELY A SERIES OF FICTION BOOKS, COMIC BOOKS AND GRAPHIC NOVELS (U.S. CLS. 2, 5, 22, 23, 29, 37, 38 AND 50).

FIRST USE 6-1-2006; IN COMMERCE 6-1-2006.

3,314,288. NORTH AMERICAN PUBLISHING COMPANY, PHILADELPHIA, PA. SN 78-802,256. PUB. 5-1-2007, FILED 1-30-2006.

BOOK BUSINESS

THE MARK CONSISTS OF STANDARD CHARACTERS WITHOUT CLAIM TO ANY PARTICULAR FONT, STYLE, SIZE, OR COLOR.

NO CLAIM IS MADE TO THE EXCLUSIVE RIGHT TO USE "BOOK", APART FROM THE MARK AS SHOWN.

FOR MAGAZINES IN THE FIELD OF PUBLISHING AND MANUFACTURING OF BOOKS (U.S. CLS. 2, 5, 22, 23, 29, 37, 38 AND 50).

FIRST USE 3-1-2006; IN COMMERCE 7-31-2007.

CLASS 16—(Continued).

3,314,326. BOOKSPAN, GARDEN CITY, NY. SN 78-809,737.
PUB. 9-12-2006, FILED 2-8-2006.

Heaven Sent Heartbeat

THE MARK CONSISTS OF STANDARD CHARACTERS WITHOUT CLAIM TO ANY PARTICULAR FONT, STYLE, SIZE, OR COLOR.
FOR SERIES OF FICTION BOOKS (U.S. CLS. 2, 5, 22, 23, 29, 37, 38 AND 50).
FIRST USE 12-12-2006; IN COMMERCE 12-12-2006.

CLASS 16—(Continued).

3,314,424. UNITED STATES HUNTER JUMPER ASSOCIATION, LEXINGTON, KY. SN 78-828,175. PUB. 10-17-2006, FILED 3-3-2006.

USHJA IN STRIDE

THE MARK CONSISTS OF STANDARD CHARACTERS WITHOUT CLAIM TO ANY PARTICULAR FONT, STYLE, SIZE, OR COLOR.
FOR MAGAZINES FEATURING EQUINE RELATED TOPICS (U.S. CLS. 2, 5, 22, 23, 29, 37, 38 AND 50).
FIRST USE 4-12-2006; IN COMMERCE 4-12-2006.

3,314,367. AGC, INC., CLEVELAND, OH. SN 78-817,666. PUB. 8-1-2006, FILED 2-17-2006.

FUNHOUSE

THE MARK CONSISTS OF STANDARD CHARACTERS WITHOUT CLAIM TO ANY PARTICULAR FONT, STYLE, SIZE, OR COLOR.
FOR GREETING CARDS (U.S. CLS. 2, 5, 22, 23, 29, 37, 38 AND 50).
FIRST USE 6-30-2005; IN COMMERCE 4-30-2006.

3,314,427. ROMANO, SALVATORE N., SCOTTSDALE, AZ. SN 78-828,621. PUB. 10-24-2006, FILED 3-3-2006.

POPPA-ARTZEE

THE MARK CONSISTS OF STANDARD CHARACTERS WITHOUT CLAIM TO ANY PARTICULAR FONT, STYLE, SIZE, OR COLOR.
FOR ART PADS; ART PAPER; ART PICTURES; ART PRINTS; GRAPHIC ART REPRODUCTIONS; PRINTED ART REPRODUCTIONS (U.S. CLS. 2, 5, 22, 23, 29, 37, 38 AND 50).
FIRST USE 3-1-2006; IN COMMERCE 3-1-2006.

3,314,368. AGC, INC., CLEVELAND, OH. SN 78-817,670. PUB. 8-1-2006, FILED 2-17-2006.

SUNBEAM FRIENDS

THE MARK CONSISTS OF STANDARD CHARACTERS WITHOUT CLAIM TO ANY PARTICULAR FONT, STYLE, SIZE, OR COLOR.
FOR GREETING CARDS (U.S. CLS. 2, 5, 22, 23, 29, 37, 38 AND 50).
FIRST USE 3-31-2003; IN COMMERCE 4-30-2006.

3,314,457. LINGOLOOK PUBLISHING LLC, PRINCETON, NJ. SN 78-835,146. PUB. 10-31-2006, FILED 3-12-2006.

Lingolook

THE MARK CONSISTS OF STANDARD CHARACTERS WITHOUT CLAIM TO ANY PARTICULAR FONT, STYLE, SIZE, OR COLOR.
FOR INSTRUCTIONAL FLASH CARDS WITH FOREIGN LANGUAGE TRANSLATIONS FOR TRAVELERS (U.S. CLS. 2, 5, 22, 23, 29, 37, 38 AND 50).
FIRST USE 3-14-2006; IN COMMERCE 5-6-2007.

CLASS 16—(Continued).

3,314,578. RANDOM HOUSE, INC., NEW YORK, NY. SN 78-881,526. PUB. 1-2-2007, FILED 5-11-2006.



NO CLAIM IS MADE TO THE EXCLUSIVE RIGHT TO USE "PRESS", APART FROM THE MARK AS SHOWN.
 THE MARK CONSISTS OF A LEAPING DOLPHIN.
 FOR FICTION AND NON-FICTION BOOKS ON A VARIETY OF TOPICS (U.S. CLS. 2, 5, 22, 23, 29, 37, 38 AND 50).
 FIRST USE 3-27-2007; IN COMMERCE 3-27-2007.

3,314,635. DAOEN CORPORATION, BOISE, ID. SN 78-896,511. PUB. 12-26-2006, FILED 5-31-2006.

WEEKEND WARRIOR'S GUIDE TO

THE MARK CONSISTS OF STANDARD CHARACTERS WITHOUT CLAIM TO ANY PARTICULAR FONT, STYLE, SIZE, OR COLOR.
 FOR SERIES OF NON-FICTION BOOKS IN THE FIELD OF SPORTS AND RECREATION NAMELY SKIING, SAILING, ROCK CLIMBING, MOUNTAINEERING, FISHING, BOWLING, BICYCLING, EXERCISE, AND PHYSICAL CONDITIONING (U.S. CLS. 2, 5, 22, 23, 29, 37, 38 AND 50).
 FIRST USE 3-1-2007; IN COMMERCE 3-1-2007.

CLASS 16—(Continued).

3,314,639. GREAT LAKES PUBLISHING CO., CLEVELAND, OH. SN 78-896,771. PUB. 1-2-2007, FILED 5-31-2006.

FEAST

THE MARK CONSISTS OF STANDARD CHARACTERS WITHOUT CLAIM TO ANY PARTICULAR FONT, STYLE, SIZE, OR COLOR.
 FOR MAGAZINES FEATURING FOOD (U.S. CLS. 2, 5, 22, 23, 29, 37, 38 AND 50).
 FIRST USE 7-29-2005; IN COMMERCE 7-29-2005.

3,314,675. RESTORING ORDER LLC, SHERWOOD, OR. SN 78-904,598. PUB. 12-5-2006, FILED 6-9-2006.

RESTORING ORDER

THE MARK CONSISTS OF STANDARD CHARACTERS WITHOUT CLAIM TO ANY PARTICULAR FONT, STYLE, SIZE, OR COLOR.
 FOR PUBLICATIONS, NAMELY, BOOKS, INFORMATIONAL SHEETS, INSTRUCTION SHEETS, PRINTED GUIDES, PRINTED INSTRUCTIONAL, EDUCATIONAL, AND TEACHING MATERIALS, DIRECTORIES, ON THE TOPICS OF ORGANIZATION AND LIFE AND TIME MANAGEMENT FOR BUSINESSES AND INDIVIDUALS; PRINTED PRODUCTS, NAMELY, PRODUCT GUIDES FEATURING PRODUCTS FOR ORGANIZATION AND LIFE AND TIME MANAGEMENT FOR BUSINESSES AND INDIVIDUALS (U.S. CLS. 2, 5, 22, 23, 29, 37, 38 AND 50).
 FIRST USE 1-0-2007; IN COMMERCE 1-0-2007.

CLASS 16—(Continued).

3,314,683. KUDOS FINDER TRADING CO., LTD., TAIPEI, TAIWAN. SN 78-906,547. PUB. 11-21-2006, FILED 6-13-2006.



THE COLOR(S) YELLOW, BLUE, GREEN, ORANGE, RED, WHITE AND BLACK, IS/ARE CLAIMED AS A FEATURE OF THE MARK.

THE COLOR YELLOW APPEARS IN A CHECKERBOARD PATTERN WITHIN A RECTANGLE, AND AS BACKGROUND; THE COLORS BLUE, GREEN, ORANGE, AND RED, APPEARS IN CHECKERBOARD PATTERNS WITHIN RECTANGLES; THE COLOR WHITE APPEARS WITHIN THE RECTANGULAR DESIGN ELEMENTS; THE COLOR BLACK APPEARS AS BORDERING FOR THE RECTANGULAR DESIGN ELEMENTS AND IN THE WORDING DOT POINT.

THE MARK CONSISTS OF A YELLOW OBLONG SHAPE CONTAINING FIVE COLORED SELF-ADHESIVE NOTES AND THE WORDS DOT POINT UNDERNEATH.

FOR SELF-ADHESIVE NOTES AND SELF-ADHESIVE NOTES IN THE FORM OF TRANSPARENT FILM (U.S. CLS. 2, 5, 22, 23, 29, 37, 38 AND 50).

FIRST USE 2-1-2007; IN COMMERCE 2-1-2007.

3,314,688. BLUE Q CORPORATION, PITTSFIELD, MA. SN 78-908,385. PUB. 8-29-2006, FILED 6-14-2006.

MISO PRETTY

THE MARK CONSISTS OF STANDARD CHARACTERS WITHOUT CLAIM TO ANY PARTICULAR FONT, STYLE, SIZE, OR COLOR.

OWNER OF U.S. REG. NO. 2,935,428.

FOR STATIONERY, CALENDARS, NOTE CARDS AND BLANK WRITING JOURNALS (U.S. CLS. 2, 5, 22, 23, 29, 37, 38 AND 50).

FIRST USE 4-5-2007; IN COMMERCE 4-5-2007.

CLASS 16—(Continued).

3,314,689. HALLMARK LICENSING, INC., KANSAS CITY, MO. SN 78-908,695. PUB. 1-16-2007, FILED 6-15-2006.

BIG TIME GREETINGS

THE MARK CONSISTS OF STANDARD CHARACTERS WITHOUT CLAIM TO ANY PARTICULAR FONT, STYLE, SIZE, OR COLOR.

NO CLAIM IS MADE TO THE EXCLUSIVE RIGHT TO USE "GREETINGS", APART FROM THE MARK AS SHOWN.

FOR OVER-SIZED GREETING CARDS AND ADVERTISING SIGNS OF PAPER OR CARDBOARD (U.S. CLS. 2, 5, 22, 23, 29, 37, 38 AND 50).

FIRST USE 12-31-1995; IN COMMERCE 12-31-1995.

3,314,690. HALLMARK LICENSING, INC., KANSAS CITY, MO. SN 78-908,791. PUB. 1-16-2007, FILED 6-15-2006.

**JOURNEYS
ENCOURAGING WORDS ALONG
LIFE'S WAY.**

THE MARK CONSISTS OF STANDARD CHARACTERS WITHOUT CLAIM TO ANY PARTICULAR FONT, STYLE, SIZE, OR COLOR.

FOR GREETING CARDS (U.S. CLS. 2, 5, 22, 23, 29, 37, 38 AND 50).

FIRST USE 1-31-2007; IN COMMERCE 1-31-2007.

3,314,706. ARTIST'S ADVANTAGE, INC., SOUTHLAKE, TX. SN 78-912,517. PUB. 1-23-2007, FILED 6-20-2006.

WINDMILL

THE MARK CONSISTS OF STANDARD CHARACTERS WITHOUT CLAIM TO ANY PARTICULAR FONT, STYLE, SIZE, OR COLOR.

FOR ARTIST'S SUPPLIES, NAMELY EASELS (U.S. CLS. 2, 5, 22, 23, 29, 37, 38 AND 50).

FIRST USE 8-22-2007; IN COMMERCE 8-22-2007.

CLASS 16—(Continued).

3,314,823. PERMACHARGE CORPORATION, RIO RANCHO, NM. SN 78-953,237. PUB. 4-24-2007, FILED 8-16-2006.

VERSALINER

THE MARK CONSISTS OF STANDARD CHARACTERS WITHOUT CLAIM TO ANY PARTICULAR FONT, STYLE, SIZE, OR COLOR.

FOR COATED PAPER RELEASE LINER FOR USE WITH ELECTROSTATICALLY CHARGED FILM (U.S. CLS. 2, 5, 22, 23, 29, 37, 38 AND 50).

FIRST USE 7-21-2006; IN COMMERCE 9-27-2006.

3,314,843. THE WEALTH CORP., INDIANAPOLIS, IN. SN 78-957,510. PUB. 5-22-2007, FILED 8-22-2006.

RENOVATE YOUR SUCCESS

THE MARK CONSISTS OF STANDARD CHARACTERS WITHOUT CLAIM TO ANY PARTICULAR FONT, STYLE, SIZE, OR COLOR.

NO CLAIM IS MADE TO THE EXCLUSIVE RIGHT TO USE "RENOVATE", APART FROM THE MARK AS SHOWN. FOR BOOKS IN THE FIELD OF REAL ESTATE REHABILITATION (U.S. CLS. 2, 5, 22, 23, 29, 37, 38 AND 50).

FIRST USE 7-27-2007; IN COMMERCE 7-27-2007.

3,314,858. HALLMARK LICENSING, INC., KANSAS CITY, MO. SN 78-962,040. PUB. 1-16-2007, FILED 8-28-2006.

POP GOES THE CULTURE

THE MARK CONSISTS OF STANDARD CHARACTERS WITHOUT CLAIM TO ANY PARTICULAR FONT, STYLE, SIZE, OR COLOR.

FOR GREETING CARDS (U.S. CLS. 2, 5, 22, 23, 29, 37, 38 AND 50).

FIRST USE 5-21-2007; IN COMMERCE 5-21-2007.

CLASS 16—(Continued).

3,314,889. NIDCAP FEDERATION INTERNATIONAL, INC., MELROSE, MA. SN 78-971,225. PUB. 5-1-2007, FILED 9-11-2006.



nidcap

OWNER OF U.S. REG. NO. 2,303,276.
FOR PRINTED INSTRUCTIONAL AND TEACHING MATERIALS IN THE FIELD OF NEWBORN CARE AND ASSESSMENT (U.S. CLS. 2, 5, 22, 23, 29, 37, 38 AND 50).
FIRST USE 10-27-2006; IN COMMERCE 10-27-2006.

3,314,892. JEWISH RENAISSANCE MEDIA, LLC, SOUTH-FIELD, MI. SN 78-972,410. PUB. 4-24-2007, FILED 9-12-2006.

JULEP

THE MARK CONSISTS OF STANDARD CHARACTERS WITHOUT CLAIM TO ANY PARTICULAR FONT, STYLE, SIZE, OR COLOR.

FOR GENERAL FEATURE MAGAZINE (U.S. CLS. 2, 5, 22, 23, 29, 37, 38 AND 50).

FIRST USE 1-5-2007; IN COMMERCE 1-5-2007.

3,314,908. DISNEY ENTERPRISES, INC, BURBANK, CA. SN 78-978,895. PUB. 10-4-2005, FILED 3-11-2004.

PISTON CUP

CLASS 16—(Continued).

THE MARK CONSISTS OF STANDARD CHARACTERS WITHOUT CLAIM TO ANY PARTICULAR FONT, STYLE, SIZE, OR COLOR.

FOR ARTS AND CRAFT PAINT KITS; CALENDARS; PENS; PENCILS; STICKERS; POSTERS; NOTEBOOKS; MEMO PADS, ERASERS; PENCIL SHARPENERS (U.S. CLS. 2, 5, 22, 23, 29, 37, 38 AND 50).

FIRST USE 6-9-2006; IN COMMERCE 6-9-2006.

CLASS 17—(Continued).

3,313,141. TAIWAN PAIHO LIMITED, HO MEI TOWN, CHANGHUA HSIEN, TAIWAN. SN 76-640,561. PUB. 8-1-2006, FILED 6-10-2005.

3H

3,314,909. DISNEY ENTERPRISES, INC., BURBANK, CA. SN 78-978,907. PUB. 9-19-2006, FILED 5-25-2005.



THE MARK CONSISTS OF STANDARD CHARACTERS WITHOUT CLAIM TO ANY PARTICULAR FONT, STYLE, SIZE, OR COLOR.

FOR REFLECTIVE TAPES FOR USE IN ROAD TRAFFIC SIGNS; REFLECTIVE PLASTIC TAPES FOR USE IN VEHICLES WARNING; REFLECTIVE PLASTIC SHEETS FOR USE IN SIGNS OR WARNINGS; REFLECTIVE PLASTIC FILMS FOR USE IN HOME, AUTO WINDOWS, DECORATIONS, SIGNS, INDUSTRY OR VEHICLES; PLASTIC FILMS FOR USE IN AUTOMOBILE INDUSTRY; REFLECTIVE PLASTIC SHEETS FOR USE IN HOME, AUTO WINDOWS, DECORATIONS, SIGNS, INDUSTRY OR VEHICLES; PLASTIC FILMS THAT IS TINTED, LAMINATED OR REFLECTIVE, OTHER THAN FOR PACKING FOR USE IN HOME, AUTO WINDOWS, DECORATIONS, SIGNS, INDUSTRY OR VEHICLES; PLASTIC SHEET MATERIALS COVERED WITH ADHESIVE FOR USE IN SIGNS OR DECORATIONS (U.S. CLS. 1, 5, 12, 13, 35 AND 50).

FIRST USE 6-0-2006; IN COMMERCE 9-0-2006.

3,313,513. AZDEL, INC., FOREST, VA. SN 78-508,356. PUB. 4-4-2006, FILED 10-29-2004.

RAIL-LITE

OWNER OF U.S. REG. NOS. 2,516,004, 2,784,058, AND OTHERS.

FOR ADDRESS BOOKS; APPLIQUES IN THE FORM OF DECALS; BALL POINT PENS; CHILDREN'S ACTIVITY BOOKS; COLORING BOOKS; DRAWING RULERS; NOTEBOOKS; PENCILS; PENS; RUBBER STAMPS AND STATIONERY (U.S. CLS. 2, 5, 22, 23, 29, 37, 38 AND 50).

FIRST USE 5-0-2005; IN COMMERCE 5-0-2005.

THE MARK CONSISTS OF STANDARD CHARACTERS WITHOUT CLAIM TO ANY PARTICULAR FONT, STYLE, SIZE, OR COLOR.

FOR THERMOPLASTIC LAMINATE COMPOSITES CONTAINING GLASS FIBERS FOR USE IN FURTHER MANUFACTURING INTERIOR OR EXTERIOR PANELING FOR AUTOMOTIVE AND TOWED VEHICLES (U.S. CLS. 1, 5, 12, 13, 35 AND 50).

FIRST USE 2-28-2007; IN COMMERCE 3-2-2007.

CLASS 17—RUBBER GOODS

CLASS 17—(Continued).

3,313,701. PERMA-PIPE, INC., NILES, IL. SN 78-636,019. PUB. 2-21-2006, FILED 5-24-2005.

AUTO-THERM

THE MARK CONSISTS OF STANDARD CHARACTERS WITHOUT CLAIM TO ANY PARTICULAR FONT, STYLE, SIZE, OR COLOR.

OWNER OF U.S. REG. NO. 2,294,963.

FOR PIPELINE INSULATION, NAMELY POLYURETHANE AND SYNTACTIC POLYURETHANE FOR APPLICATION TO UNDERWATER PIPELINES (U.S. CLS. 1, 5, 12, 13, 35 AND 50).

FIRST USE 3-31-2006; IN COMMERCE 3-31-2006.

CLASS 17—(Continued).

3,313,729. CSS GLOBAL INC., GRASS VALLEY, CA. SN 78-648,754. PUB. 9-5-2006, FILED 6-11-2005.

CSS Caulk & Sealant Solution

THE MARK CONSISTS OF STANDARD CHARACTERS WITHOUT CLAIM TO ANY PARTICULAR FONT, STYLE, SIZE, OR COLOR.

NO CLAIM IS MADE TO THE EXCLUSIVE RIGHT TO USE "CAULK & SEALANT SOLUTION", APART FROM THE MARK AS SHOWN.

FOR CAULKING COMPOUND AND ADHESIVE SEALANT FINISHING LIQUID FOR GENERAL USE (U.S. CLS. 1, 5, 12, 13, 35 AND 50).

FIRST USE 3-8-2006; IN COMMERCE 10-1-2006.

3,313,879. KOPPERS DELAWARE, INC., WILMINGTON, DE. SN 78-711,856. PUB. 12-5-2006, FILED 9-13-2005.

KFOAM

THE MARK CONSISTS OF STANDARD CHARACTERS WITHOUT CLAIM TO ANY PARTICULAR FONT, STYLE, SIZE, OR COLOR.

FOR CARBON, GRAPHITE AND COMPOSITE FOAM MATERIALS USED FOR HEAT TRANSFER AND THERMAL MANAGEMENT APPLICATIONS (U.S. CLS. 1, 5, 12, 13, 35 AND 50).

FIRST USE 2-16-2006; IN COMMERCE 2-17-2006.

3,313,720. PHILMAC PTY LTD, NORTH PLYMPTON, AUSTRALIA. SN 78-642,837. PUB. 6-13-2006, FILED 6-3-2005.

SLIDE & TIGHTEN

THE MARK CONSISTS OF STANDARD CHARACTERS WITHOUT CLAIM TO ANY PARTICULAR FONT, STYLE, SIZE, OR COLOR.

FOR NON-METALLIC RIGID IRRIGATION PIPE CONNECTORS, NAMELY, PIPE JOINTS; NON-METALLIC RIGID IRRIGATION PIPE COUPLINGS; NON-METALLIC RIGID IRRIGATION PIPE SPIKE ASSEMBLIES, NAMELY, PIPE SUPPORTS; PARTS AND FITTINGS FOR NON-METALLIC RIGID IRRIGATION PIPES, NAMELY, PLASTIC CONDUIT; GOODS MADE FROM POLYMERS, NAMELY, THERMOPLASTIC ELASTOMER RESINS IN PELLET FORM FOR USE IN FURTHER MANUFACTURE AND PLASTICS IN EXTRUDED FORM FOR GENERAL INDUSTRIAL USE; NON-METALLIC PIPES AND PIPE LINERS, NAMELY, PLASTIC CONDUIT FOR IRRIGATION AND PLASTIC CONDUIT LINERS FOR IRRIGATION (U.S. CLS. 1, 5, 12, 13, 35 AND 50).

FIRST USE 6-13-2006; IN COMMERCE 6-13-2006.

3,313,951. JOHNSON WINDOW FILMS, INC., CARSON, CA. SN 78-742,456. PUB. 9-26-2006, FILED 10-28-2005.

NIGHTSCAPE

THE MARK CONSISTS OF STANDARD CHARACTERS WITHOUT CLAIM TO ANY PARTICULAR FONT, STYLE, SIZE, OR COLOR.

FOR LAMINATED AND COATED PLASTIC AND POLYESTER FILMS FOR USE WITH COMMERCIAL AND RESIDENTIAL BUILDING WINDOWS; PLASTIC AND POLYESTER SOLAR CONTROL WINDOW FILMS FOR USE IN COMMERCIAL AND RESIDENTIAL BUILDINGS; PLASTIC AND POLYESTER RELEASE FILMS SOLD IN SHEETS OR ROLLS DESIGNED TO PREVENT ONE SURFACE FROM ADHERING TO ANOTHER (U.S. CLS. 1, 5, 12, 13, 35 AND 50).

FIRST USE 6-1-2005; IN COMMERCE 7-1-2005.

CLASS 17—(Continued).

3,314,254. SCHOLLE CORPORATION, IRVINE, CA. SN 78-794,909. PUB. 2-27-2007, FILED 1-19-2006.

DURASHIELD

THE MARK CONSISTS OF STANDARD CHARACTERS WITHOUT CLAIM TO ANY PARTICULAR FONT, STYLE, SIZE, OR COLOR.

FOR PLASTIC FILM FOR BAGS AND FOR BAGS INSERTABLE INTO CONTAINERS USED FOR THE CONTAINMENT OF PROCESSED FOOD, BEVERAGES AND NON-FOOD PRODUCTS FOR INDUSTRIAL OR COMMERCIAL USE (U.S. CLS. 1, 5, 12, 13, 35 AND 50).
FIRST USE 6-14-1999; IN COMMERCE 6-14-1999.

CLASS 18—(Continued).

3,313,157. KODER, GEMMA V., PALM BEACH GARDENS, FL. SN 76-644,716. PUB. 11-7-2006, FILED 8-11-2005.

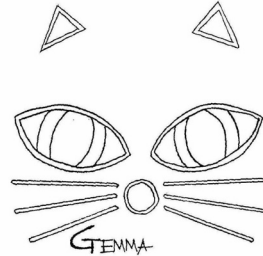

FOR ALL PURPOSE CARRYING BAGS; ANIMAL CARRIERS IN THE NATURE OF A TOTE BAG, AT-TACHE CASES, BACK PACKS; BANKNOTE HOLDER; BILLFOLD; BRIEFCASES; BUSINESS CARD CASES; CARRY-ALL BAGS; CHANGE PURSES; CLUTCH BAGS; CLUTCH PURSES; COSMETIC BAGS SOLD EMPTY; CREDIT CARD CASES; EVENING BAGS; FANNY PACKS (U.S. CLS. 1, 2, 3, 22 AND 41).
FIRST USE 2-25-2007; IN COMMERCE 2-25-2007.

CLASS 18—LEATHER GOODS

3,313,139. AGE GROUP, LTD., NEW YORK, NY. SN 76-640,293. PUB. 8-1-2006, FILED 6-6-2005.

DOG IS LOVE

THE MARK CONSISTS OF STANDARD CHARACTERS WITHOUT CLAIM TO ANY PARTICULAR FONT, STYLE, SIZE, OR COLOR.

NO CLAIM IS MADE TO THE EXCLUSIVE RIGHT TO USE "DOG", APART FROM THE MARK AS SHOWN.

FOR LEASHES AND COLLARS FOR ANIMALS; PET CARRYING CASES; PET CLOTHING (U.S. CLS. 1, 2, 3, 22 AND 41).

FIRST USE 12-1-2005; IN COMMERCE 12-1-2005.

3,313,187. MANNING TURK, LLC, DARIEN, CT. SN 76-653,334. PUB. 9-5-2006, FILED 1-13-2006.

FOR LUXURY AND HIGH-END HANDBAGS FOR WOMEN (U.S. CLS. 1, 2, 3, 22 AND 41).
FIRST USE 1-1-2007; IN COMMERCE 1-1-2007.

CLASS 18—(Continued).

3,313,213. COCOS INTERNATIONAL TRADING, INC., LOS ANGELES, CA. SN 76-661,797. PUB. 11-14-2006, FILED 6-19-2006.

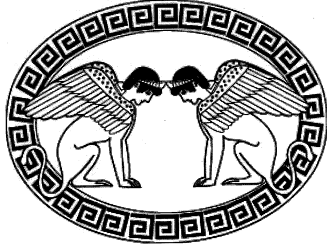

FOR TRAVEL BAGS, TRAVEL BAGS MADE OF LEATHER; LUGGAGE TRUNKS AND VALISES, GARMENT BAGS FOR TRAVEL, VANITY-CASES SOLD EMPTY; RUCKSACKS, SHOULDER BAGS, HANDBAGS; ATTACHE-CASES, BRIEFCASES, DRAWSTRING POUCHES, POCKET WALLETS, PURSES, UMBRELLAS, BUSINESS CARD CASES MADE OF LEATHER OR OF IMITATION LEATHER, CREDIT CARD CASES MADE OF LEATHER OR OF IMITATION LEATHER; CALLING CARD CASES MADE OF LEATHER OR OF IMITATION LEATHER (U.S. CLS. 1, 2, 3, 22 AND 41).

FIRST USE 2-2-2002; IN COMMERCE 2-15-2002.

3,313,233. COCOS INTERNATIONAL TRADING INC., LOS ANGELES, CA. SN 76-668,868. PUB. 5-1-2007, FILED 11-13-2006.



FOR TRAVEL BAGS, TRAVEL BAGS MADE OF LEATHER; LUGGAGE TRUNKS AND VALISES, GARMENT BAGS FOR TRAVEL, VANITY-CASES SOLD EMPTY; RUCKSACKS, SHOULDER BAGS, HANDBAGS; ATTACHE-CASES, BRIEFCASES, DRAWSTRING POUCHES, POCKET WALLETS, PURSES, UMBRELLAS, BUSINESS CARD CASES MADE OF LEATHER OR OF IMITATION LEATHER, CREDIT CARD CASES MADE OF LEATHER OR OF IMITATION LEATHER; CALLING CARD CASES MADE OF LEATHER OR OF IMITATION LEATHER (U.S. CLS. 1, 2, 3, 22 AND 41).

FIRST USE 4-2-2007; IN COMMERCE 4-15-2007.

CLASS 18—(Continued).

3,313,518. LES FILOS PARTICIPACOES E COMERCIO LTDA, SAO PAULO, SP, BRAZIL. SN 78-512,594. PUB. 2-21-2006, FILED 11-5-2004.

LES FILOS

THE MARK CONSISTS OF STANDARD CHARACTERS WITHOUT CLAIM TO ANY PARTICULAR FONT, STYLE, SIZE, OR COLOR.

FOR PURSES, HANDBAGS, SHOULDER BAGS, CLUTCH BAGS, TOTE BAGS, DUFFEL BAGS, ATTACHE CASES, BRIEFCASES, ALL PURPOSE SPORT BAGS; LUGGAGE, TRAVELING TRUNKS, CARRY-ON BAGS, AND SUIT BAGS FOR TRAVELING (U.S. CLS. 1, 2, 3, 22 AND 41).

FIRST USE 12-2-1998; IN COMMERCE 2-18-2007.

3,313,670. BELISI FASHIONS, INC., JUPITER, FL. SN 78-621,926. PUB. 8-1-2006, FILED 5-3-2005.

BELISI

THE MARK CONSISTS OF STANDARD CHARACTERS WITHOUT CLAIM TO ANY PARTICULAR FONT, STYLE, SIZE, OR COLOR.

OWNER OF U.S. REG. NO. 2,937,892.
FOR HANDBAGS AND WALLETS (U.S. CLS. 1, 2, 3, 22 AND 41).

FIRST USE 3-0-2007; IN COMMERCE 3-0-2007.

CLASS 18—(Continued).

3,313,728. ALRIC SUBA LLC, NEW YORK, NY. SN 78-648,722.
PUB. 11-14-2006, FILED 6-10-2005.

ALRIC SUBA

THE NAME "ALRIC SUBA" IDENTIFIES A LIVING INDIVIDUAL WHOSE CONSENT IS OF RECORD.
FOR HANDBAGS, LEATHER HANDBAGS, EVENING HANDBAGS, CLUTCH HANDBAGS (U.S. CLS. 1, 2, 3, 22 AND 41).

FIRST USE 1-15-2006; IN COMMERCE 1-15-2006.

3,313,877. CANTWELL, TOM, ALISO VIEJO, CA. SN 78-711,107. PUB. 8-1-2006, FILED 9-12-2005.

HANDLE WITH CARE

THE MARK CONSISTS OF STANDARD CHARACTERS WITHOUT CLAIM TO ANY PARTICULAR FONT, STYLE, SIZE, OR COLOR.

FOR SOFT ANIMAL CARRIER (U.S. CLS. 1, 2, 3, 22 AND 41).

FIRST USE 10-15-2006; IN COMMERCE 4-20-2007.

3,313,920. SAN FRANCISCO BASEBALL ASSOCIATES L.P., SAN FRANCISCO, CA. SN 78-729,834. PUB. 6-27-2006, FILED 10-10-2005.



OWNER OF U.S. REG. NOS. 1,527,781, 1,661,650, AND OTHERS.

FOR ATHLETIC BAGS, OVERNIGHT BAGS, BACKPACKS, DUFFEL BAGS, TOTE BAGS, BEACH BAGS, LUNCH TOTES, KNAPSACKS, ATTACHE CASES, BRIEFCASES, PURSES, HANDBAGS, WALLETS, BILLFOLDS, FANNY PACKS, WAIST PACKS, COSMETIC CASES SOLD EMPTY, TOILETRY CASES SOLD EMPTY, BUSINESS CARD CASES, LUGGAGE, LUGGAGE TAGS, SUITCASES, UMBRELLAS, DOG COLLARS, AND DOG LEASHES (U.S. CLS. 1, 2, 3, 22 AND 41).

FIRST USE 9-0-2002; IN COMMERCE 9-0-2002.

CLASS 18—(Continued).

3,313,927. WILEY, DEBRA A., BOSTON, MA. SN 78-732,609.
PUB. 10-17-2006, FILED 10-13-2005.

Sapelo Halle

THE MARK CONSISTS OF STANDARD CHARACTERS WITHOUT CLAIM TO ANY PARTICULAR FONT, STYLE, SIZE, OR COLOR.

THE NAME SAPELO HALLE DOES NOT IDENTIFY A LIVING INDIVIDUAL.

FOR WOMEN'S HANDBAGS (U.S. CLS. 1, 2, 3, 22 AND 41).

FIRST USE 10-16-2004; IN COMMERCE 10-16-2004.

3,314,087. RED OXX MFG INCORPORATED, BILLINGS, MT. SN 78-767,121. PUB. 8-29-2006, FILED 12-5-2005.

RED OXX

THE MARK CONSISTS OF STANDARD CHARACTERS WITHOUT CLAIM TO ANY PARTICULAR FONT, STYLE, SIZE, OR COLOR.

FOR LUGGAGE; ALL-PURPOSE SPORT BAGS; ALL-PURPOSE CARRYING BAGS; BAGS FOR CARRYING BABIES ACCESSORIES; COSMETIC BAGS SOLD EMPTY; DIAPER BAGS; DUFFEL BAGS; GARMENT BAGS FOR TRAVEL; GYM BAGS; HIKING BAGS; HUNTING BAGS; BACKPACKS; RUCKSACKS; SHAVING BAGS SOLD EMPTY; BRIEFCASES (U.S. CLS. 1, 2, 3, 22 AND 41).

FIRST USE 10-31-1986; IN COMMERCE 10-11-1996.

3,314,193. BLUE Q CORPORATION, PITTSFIELD, MA. SN 78-784,863. PUB. 8-22-2006, FILED 1-4-2006.

MISO PRETTY

THE MARK CONSISTS OF STANDARD CHARACTERS WITHOUT CLAIM TO ANY PARTICULAR FONT, STYLE, SIZE, OR COLOR.

OWNER OF U.S. REG. NO. 2,935,428.

FOR HANDBAGS, WALLETS, COIN PURSES, TOTE BAGS AND COSMETIC BAGS SOLD EMPTY (U.S. CLS. 1, 2, 3, 22 AND 41).

FIRST USE 10-4-2004; IN COMMERCE 10-4-2004.

CLASS 18—(Continued).

3,314,269. EMILY MYLES, DBA EMILY MYLES FIBRE ART & DESIGN, SWANSEA, MA. SN 78-797,623. PUB. 9-12-2006, FILED 1-23-2006.

E MYLES

THE MARK CONSISTS OF STANDARD CHARACTERS WITHOUT CLAIM TO ANY PARTICULAR FONT, STYLE, SIZE, OR COLOR.

FOR HANDBAGS (U.S. CLS. 1, 2, 3, 22 AND 41).
FIRST USE 2-22-2006; IN COMMERCE 2-22-2006.

3,314,386. LANDS' END DIRECT MERCHANTS, INC., RICHFIELD, MN. SN 78-819,923. PUB. 8-29-2006, FILED 2-21-2006.

Classmate

THE MARK CONSISTS OF STANDARD CHARACTERS WITHOUT CLAIM TO ANY PARTICULAR FONT, STYLE, SIZE, OR COLOR.

FOR BACKPACKS; SCHOOLCHILDREN'S BACKPACKS; SMALL BACKPACKS (U.S. CLS. 1, 2, 3, 22 AND 41).

FIRST USE 7-8-2006; IN COMMERCE 7-8-2006.

3,314,515. SHANGHAI Y.W.E. INDUSTRY INC. LTD., SHANGHAI, CHINA. SN 78-859,768. PUB. 11-21-2006, FILED 4-12-2006.

INFRAPÖT

THE MARK CONSISTS OF STYLIZED INFRAPET. LETTER "E" IS A PAW PRINT WITH A LOWER-CASE "E" CONTAINED INSIDE THE PAW PRINT.

FOR COLLARS FOR ANIMALS; LEASHES FOR ANIMALS; CLOTHING FOR PETS; DOG COLLARS (U.S. CLS. 1, 2, 3, 22 AND 41).

FIRST USE 7-5-2006; IN COMMERCE 7-5-2006.

CLASS 18—(Continued).

3,314,605. METROKANE, INC., NEW YORK, NY. SN 78-887,472. PUB. 12-26-2006, FILED 5-19-2006.

WINE-TO-GO

THE MARK CONSISTS OF STANDARD CHARACTERS WITHOUT CLAIM TO ANY PARTICULAR FONT, STYLE, SIZE, OR COLOR.

FOR BAGS FOR CARRYING OR HOLDING BEVERAGE BOTTLES (U.S. CLS. 1, 2, 3, 22 AND 41).
FIRST USE 3-11-2007; IN COMMERCE 3-11-2007.

3,314,765. PSI CORPORATION LIMITED, KOWLOON, HONG KONG. SN 78-933,423. PUB. 3-6-2007, FILED 7-20-2006.



The logo for 'La Cerisaie' features the brand name in a stylized, serif font. A thick, black horizontal line with a circular dot at its center is positioned below the text, partially overlapping the letters 'a' and 'i'.

THE ENGLISH TRANSLATION OF THE WORD LA CERISAIE IN THE MARK IS THE CHERRY ORCHARD.

FOR UNWORKED OR SEMI-WORKED LEATHER; IMITATION LEATHER; PURSES; LEATHER CASES; TEXTILE SHOPPING BAGS; LEATHER SHOPPING BAGS; BRIEFCASES; HANDBAGS; LEATHER BAGS FOR MERCHANDISE PACKAGING, NAMELY, ENVELOPES, POUCHES; SADDLE BELTS; TRAVEL BAGS (U.S. CLS. 1, 2, 3, 22 AND 41).

FIRST USE 8-31-2007; IN COMMERCE 8-31-2007.

CLASS 18—(Continued).

3,314,911. DISNEY ENTERPRISES, INC., BURBANK, CA. SN 78-978,912. PUB. 9-19-2006, FILED 5-25-2005.



OWNER OF U.S. REG. NOS. 2,516,004, 2,784,058, AND OTHERS.

FOR ALL PURPOSE SPORT BAGS; ATHLETIC BAGS; BACKPACKS; BEACH BAGS; BOOK BAGS; CHANGE PURSES; COIN PURSES; HANDBAGS; LEATHER KEY CHAINS; LUGGAGE; PURSES; TOTE BAGS; WAIST PACKS; WALLETS (U.S. CLS. 1, 2, 3, 22 AND 41).

FIRST USE 5-0-2005; IN COMMERCE 5-0-2005.

CLASS 19—(Continued).

3,313,223. AWI LICENSING COMPANY, WILMINGTON, DE. SN 76-665,153. PUB. 1-9-2007, FILED 8-25-2006.

FILAMENTS

THE MARK CONSISTS OF STANDARD CHARACTERS WITHOUT CLAIM TO ANY PARTICULAR FONT, STYLE, SIZE, OR COLOR.

FOR NON-METAL CEILING PANELS (U.S. CLS. 1, 12, 33 AND 50).

FIRST USE 3-19-2007; IN COMMERCE 3-19-2007.

CLASS 19—NON-METALLIC BUILDING MATERIALS

3,313,142. TRADEMARK ACQUISITION COMPANY, DBA ZARING PREMIER HOMES, FORT MITCHELL, KY. SN 76-641,011. PUB. 9-12-2006, FILED 6-17-2005.



OWNER OF U.S. REG. NOS. 1,480,001, 2,627,262, AND OTHERS.

NO CLAIM IS MADE TO THE EXCLUSIVE RIGHT TO USE "GENUINE", "CRAFTED EXCLUSIVELY FOR" AND "HOMES", APART FROM THE MARK AS SHOWN.

FOR MILLWORK EXCLUSIVE OF CABINETS, AND MOLDINGS, ALL OF SYNTHETIC MATERIAL, FOR USE IN RESIDENTIAL CONSTRUCTION (U.S. CLS. 1, 12, 33 AND 50).

FIRST USE 4-0-1997; IN COMMERCE 4-0-1997.

3,313,302. SPECIALTY CONSTRUCTION BRANDS, INC., SAINT PAUL, MN. SN 77-028,004. PUB. 1-23-2007, FILED 10-24-2006.

ACCUCOLOR EFX

THE MARK CONSISTS OF STANDARD CHARACTERS WITHOUT CLAIM TO ANY PARTICULAR FONT, STYLE, SIZE, OR COLOR.

OWNER OF U.S. REG. NO. 2,085,897.
FOR GROUT; MORTAR MIX; MORTARS (U.S. CLS. 1, 12, 33 AND 50).

FIRST USE 1-16-2007; IN COMMERCE 7-1-2007.

CLASS 19—(Continued).

3,313,354. GRANT FOREST PRODUCTS INC., MISSISSAUGA, ONTARIO, CANADA. SN 78-111,758. PUB. 8-8-2006, FILED 2-28-2002.



PRIORITY CLAIMED UNDER SEC. 44(D) ON CANADA APPLICATION NO. 1114936, FILED 8-30-2001, REG. NO. TMA661,718, DATED 3-29-2006, EXPIRES 3-29-2021.

NO CLAIM IS MADE TO THE EXCLUSIVE RIGHT TO USE "NO SWELL", APART FROM THE MARK AS SHOWN. FOR BUILDING MATERIALS, NAMELY SUB-FLOORING ALL MADE OF ORIENTED STRAND BOARD (U.S. CLS. 1, 12, 33 AND 50).

FIRST USE 1-9-2003; IN COMMERCE 1-9-2003.

CLASS 19—(Continued).

3,313,496. PIMENTAL, TERRY W., RENO, NV. SN 78-485,129. PUB. 7-18-2006, FILED 9-17-2004.

Get out of the Stone Age!

THE MARK CONSISTS OF STANDARD CHARACTERS WITHOUT CLAIM TO ANY PARTICULAR FONT, STYLE, SIZE, OR COLOR.

FOR ARTIFICIAL LIGHTWEIGHT ROCK AND MASONRY PRODUCTS, WHEREIN SAID PRODUCTS ARE CONSTRUCTED TO HAVE A POLYMER OR RESIN SHELL WHOSE EXTERIOR GENERALLY DENOTES A HOLLOW INTERIOR, WHICH MAY BE FOAM FILLED, THE EXTERIOR OF THE SHELL BEING FURTHER SHAPED TO REPRESENT BUILDING BLOCKS, SLABS, POSTS, WALLBOARDS, RETAINING WALLS MADE OF NON-METALLIC MATERIALS SUCH AS CEMENT, CONCRETE, STONE, AND THE LIKE (U.S. CLS. 1, 12, 33 AND 50).

FIRST USE 3-10-2007; IN COMMERCE 3-10-2007.

3,313,567. SIMPSON DOOR COMPANY, TACOMA, WA. SN 78-568,542. PUB. 6-20-2006, FILED 2-16-2005.

3,313,495. PATRIOT HOMES, INC., ELKHART, IN. SN 78-483,814. PUB. 12-27-2005, FILED 9-15-2004.

EVOLUTIONHOMES

ALLISTON

THE MARK CONSISTS OF STANDARD CHARACTERS WITHOUT CLAIM TO ANY PARTICULAR FONT, STYLE, SIZE, OR COLOR.

FOR MANUFACTURED HOUSING; NAMELY, MODULAR HOMES AND MOBILE HOMES (U.S. CLS. 1, 12, 33 AND 50).

FIRST USE 1-16-2007; IN COMMERCE 1-16-2007.

THE MARK CONSISTS OF STANDARD CHARACTERS WITHOUT CLAIM TO ANY PARTICULAR FONT, STYLE, SIZE, OR COLOR.

FOR WOOD DOORS (U.S. CLS. 1, 12, 33 AND 50).

FIRST USE 2-0-2004; IN COMMERCE 2-0-2004.

CLASS 19—(Continued).

3,313,568. SIMPSON DOOR COMPANY, TACOMA, WA. SN 78-568,544. PUB. 6-20-2006, FILED 2-16-2005.

TRAFTON

THE MARK CONSISTS OF STANDARD CHARACTERS WITHOUT CLAIM TO ANY PARTICULAR FONT, STYLE, SIZE, OR COLOR.
FOR WOOD DOORS (U.S. CLS. 1, 12, 33 AND 50).
FIRST USE 2-0-2004; IN COMMERCE 2-0-2004.

3,313,667. ANTHONY FOREST PRODUCTS COMPANY, EL DORADO, AR. SN 78-620,786. PUB. 2-21-2006, FILED 5-2-2005.

POWER BEAM

THE MARK CONSISTS OF STANDARD CHARACTERS WITHOUT CLAIM TO ANY PARTICULAR FONT, STYLE, SIZE, OR COLOR.

OWNER OF U.S. REG. NOS. 2,092,082, 2,938,437, AND OTHERS.

NO CLAIM IS MADE TO THE EXCLUSIVE RIGHT TO USE "BEAM", APART FROM THE MARK AS SHOWN.

FOR LAMINATED WOOD BEAM USED HORIZONTALLY IN CONSTRUCTION TO SUPPORT A LOAD (U.S. CLS. 1, 12, 33 AND 50).

FIRST USE 12-31-1992; IN COMMERCE 12-31-1992.

3,313,725. FERNCO INC., DAVISON, MI. SN 78-645,499. PUB. 3-21-2006, FILED 6-7-2005.

FERNCO STORM DRAIN

THE MARK CONSISTS OF STANDARD CHARACTERS WITHOUT CLAIM TO ANY PARTICULAR FONT, STYLE, SIZE, OR COLOR.

CLASS 19—(Continued).

OWNER OF U.S. REG. NO. 2,563,518.

NO CLAIM IS MADE TO THE EXCLUSIVE RIGHT TO USE "STORM DRAIN", APART FROM THE MARK AS SHOWN.

FOR PLASTIC DRAIN CHANNELS WITH PLASTIC GRATES (U.S. CLS. 1, 12, 33 AND 50).

FIRST USE 4-1-2007; IN COMMERCE 4-1-2007.

3,313,940. THE DRY ROOF COMPANY, LLC, HILLSBORO, OR. SN 78-739,357. PUB. 6-27-2006, FILED 10-24-2005.

AWNINGFILTER

THE MARK CONSISTS OF STANDARD CHARACTERS WITHOUT CLAIM TO ANY PARTICULAR FONT, STYLE, SIZE, OR COLOR.

FOR FOAM INSERT FOR RESIDENTIAL AND COMMERCIAL GUTTERS, TO PREVENT DEBRIS FROM FILLING THE GUTTER AND CLOGGING THE GUTTER'S DOWNSPOUT (U.S. CLS. 1, 12, 33 AND 50).

FIRST USE 9-0-2006; IN COMMERCE 9-0-2006.

3,313,972. THE HOFF COMPANIES, INC., MERIDIAN, ID. SN 78-747,624. PUB. 7-11-2006, FILED 11-4-2005.

COLOR SURECOAT

THE MARK CONSISTS OF STANDARD CHARACTERS WITHOUT CLAIM TO ANY PARTICULAR FONT, STYLE, SIZE, OR COLOR.

NO CLAIM IS MADE TO THE EXCLUSIVE RIGHT TO USE "COLOR", APART FROM THE MARK AS SHOWN.

FOR VINYL WINDOWS (U.S. CLS. 1, 12, 33 AND 50).

FIRST USE 11-1-2005; IN COMMERCE 11-1-2005.

CLASS 19—(Continued).

3,313,974. AL'S GARDEN ART, INC., COLTON, CA. SN 78-748,578. PUB. 8-1-2006, FILED 11-7-2005.



NO CLAIM IS MADE TO THE EXCLUSIVE RIGHT TO USE "COLLECTION", APART FROM THE MARK AS SHOWN.

THE COLOR(S) BROWN, YELLOW AND BLACK IS/ARE CLAIMED AS A FEATURE OF THE MARK.

THE MARK CONSISTS OF THE WORD "BRACCI", IN TITLE CASE IN A YELLOW COLORED STYLIZED FONT, ABOVE THE WORD "COLLECTION", IN UPPER CASE IN A BLACK TYPED FONT; THE LITERAL ELEMENTS "BRACCI COLLECTION" ARE SUPERIMPOSED IN AN OVAL OVER A RECTANGULAR BROWN, YELLOW AND BLACK IMAGE REPRESENTING CARVING.

THE FOREIGN WORDING IN THE MARK TRANSLATES INTO ENGLISH AS ARMS.

FOR CAST STONE GARDEN AND HOUSEHOLD ORNAMENTS AND SCULPTURES (U.S. CLS. 1, 12, 33 AND 50).

FIRST USE 12-22-2006; IN COMMERCE 12-22-2006.

3,314,089. COFAIR PRODUCTS, INC., SKOKIE, IL. SN 78-767,539. PUB. 9-19-2006, FILED 12-6-2005.

SB60

THE MARK CONSISTS OF STANDARD CHARACTERS WITHOUT CLAIM TO ANY PARTICULAR FONT, STYLE, SIZE, OR COLOR.

FOR NON-METAL SHINGLE OR ROOFING UNDERLAYMENT (U.S. CLS. 1, 12, 33 AND 50).

FIRST USE 12-0-2005; IN COMMERCE 12-0-2005.

3,314,120. LUMBER LIQUIDATORS, INC., TOANO, VA. SN 78-772,586. PUB. 3-20-2007, FILED 12-13-2005.



NO CLAIM IS MADE TO THE EXCLUSIVE RIGHT TO USE "SUPREME BAMBOO" AND "FLOORING CO.", APART FROM THE MARK AS SHOWN.

FOR BAMBOO FLOORING (U.S. CLS. 1, 12, 33 AND 50).

FIRST USE 1-1-2006; IN COMMERCE 1-1-2006.

CLASS 19—(Continued).

3,314,134. PERGO (EUROPE) AB, TRELLEBORG, SWEDEN. SN 78-775,165. PUB. 9-5-2006, FILED 12-16-2005.

WORLD TRAVELER

THE MARK CONSISTS OF STANDARD CHARACTERS WITHOUT CLAIM TO ANY PARTICULAR FONT, STYLE, SIZE, OR COLOR.

FOR FLOORING, NAMELY, WOOD, THERMOSETTING LAMINATE, THERMOSETTING LAMINATE BONDED TO A BASE OF PARTICLE BOARD OR FIBERBOARD AND PARTICLE BOARD OR FIBERBOARD PROVIDED WITH A DECORATIVE SURFACE OR COATING (U.S. CLS. 1, 12, 33 AND 50).

FIRST USE 3-31-2006; IN COMMERCE 3-31-2006.

3,314,136. PERGO (EUROPE) AB, TRELLEBORG, SWEDEN. SN 78-775,209. PUB. 9-5-2006, FILED 12-16-2005.

GLOBAL PASSAGE

THE MARK CONSISTS OF STANDARD CHARACTERS WITHOUT CLAIM TO ANY PARTICULAR FONT, STYLE, SIZE, OR COLOR.

FOR FLOORING, NAMELY, WOOD, THERMOSETTING LAMINATE, THERMOSETTING LAMINATE BONDED TO A BASE OF PARTICLE BOARD OR FIBERBOARD AND PARTICLE BOARD OR FIBERBOARD PROVIDED WITH A DECORATIVE SURFACE OR COATING (U.S. CLS. 1, 12, 33 AND 50).

FIRST USE 2-28-2006; IN COMMERCE 2-28-2006.

3,314,240. LIFETIME FLOORS, LLC, HUDSON, WI. SN 78-793,058. PUB. 12-12-2006, FILED 1-17-2006.

LIFETIME ELEMENTS

THE MARK CONSISTS OF STANDARD CHARACTERS WITHOUT CLAIM TO ANY PARTICULAR FONT, STYLE, SIZE, OR COLOR.

FOR CEMENTITIOUS CONCENTRATE USED TO CREATE DECORATIVE CONCRETE FLOORS, COUNTERTOPS AND TABLETOPS (U.S. CLS. 1, 12, 33 AND 50).

FIRST USE 6-30-2005; IN COMMERCE 8-31-2006.

CLASS 19—(Continued).

3,314,274. OCEANSIDE GLASSTILE COMPANY, CARLSBAD, CA. SN 78-798,855. PUB. 9-12-2006, FILED 1-25-2006.

Elevations

THE MARK CONSISTS OF STANDARD CHARACTERS WITHOUT CLAIM TO ANY PARTICULAR FONT, STYLE, SIZE, OR COLOR.

FOR GLASS TILES FOR COMMERCIAL AND RESIDENTIAL USE ON WALLS, FLOORS, CEILINGS, AND OTHER SURFACES (U.S. CLS. 1, 12, 33 AND 50).
FIRST USE 3-20-2006; IN COMMERCE 3-20-2006.

3,314,446. PERGO (EUROPE) AB. TRELLEBORG, SWEDEN. SN 78-832,487. PUB. 9-5-2006, FILED 3-8-2006.

PERGO GLOBAL PASSAGE

THE MARK CONSISTS OF STANDARD CHARACTERS WITHOUT CLAIM TO ANY PARTICULAR FONT, STYLE, SIZE, OR COLOR.

FOR FLOORING, NAMELY, WOOD, THERMOSETTING LAMINATE, THERMOSETTING LAMINATE BONDED TO A BASE OF PARTICLE BOARD OR FIBERBOARD AND PARTICLE BOARD OR FIBERBOARD PROVIDED WITH A DECORATIVE SURFACE OR COATING (U.S. CLS. 1, 12, 33 AND 50).
FIRST USE 2-28-2006; IN COMMERCE 2-28-2006.

3,314,449. PERGO (EUROPE) AB. TRELLEBORG, SWEDEN. SN 78-833,497. PUB. 9-5-2006, FILED 3-9-2006.

PERGO CASUAL LIVING

THE MARK CONSISTS OF STANDARD CHARACTERS WITHOUT CLAIM TO ANY PARTICULAR FONT, STYLE, SIZE, OR COLOR.

FOR FLOORING, NAMELY, WOOD, THERMOSETTING LAMINATE, THERMOSETTING LAMINATE BONDED TO A BASE OF PARTICLE BOARD OR FIBERBOARD AND PARTICLE BOARD OR FIBERBOARD PROVIDED WITH A DECORATIVE SURFACE OR COATING (U.S. CLS. 1, 12, 33 AND 50).
FIRST USE 5-31-2004; IN COMMERCE 5-31-2004.

CLASS 19—(Continued).

3,314,592. TIMBERLINE LUMBER COMPANY OF ASHEVILLE, ASHEVILLE, NC. SN 78-884,635. PUB. 12-19-2006, FILED 5-16-2006.

ANVIL

THE MARK CONSISTS OF STANDARD CHARACTERS WITHOUT CLAIM TO ANY PARTICULAR FONT, STYLE, SIZE, OR COLOR.

FOR WOOD PRODUCTS FOR BUILDING, NAMELY LUMBER (U.S. CLS. 1, 12, 33 AND 50).
FIRST USE 8-4-2006; IN COMMERCE 9-8-2006.

3,314,598. WOOD FLOOR MART, INC., MIAMI, FL. SN 78-885,633. PUB. 12-19-2006, FILED 5-17-2006.

CHESS

THE MARK CONSISTS OF STANDARD CHARACTERS WITHOUT CLAIM TO ANY PARTICULAR FONT, STYLE, SIZE, OR COLOR.

FOR WOOD FLOORING (U.S. CLS. 1, 12, 33 AND 50).
FIRST USE 5-1-2006; IN COMMERCE 5-1-2006.

3,314,613. FLEX MEMBRANE INTERNATIONAL CORP., LEESPORT, PA. SN 78-889,719. PUB. 1-2-2007, FILED 5-23-2006.

FLEXMEMBRANE

THE MARK CONSISTS OF STANDARD CHARACTERS WITHOUT CLAIM TO ANY PARTICULAR FONT, STYLE, SIZE, OR COLOR.

FOR NON-METALLIC ROOFING COVERING MATERIALS AS A ROOFING MEMBRANE (U.S. CLS. 1, 12, 33 AND 50).
FIRST USE 3-29-2007; IN COMMERCE 3-29-2007.

CLASS 20—FURNITURE AND ARTICLES NOT OTHERWISE CLASSIFIED

CLASS 20—(Continued).

3,313,029. PADDOCK POOL CONSTRUCTION CO., SCOTTS-DALE, AZ. SN 76-524,446. PUB. 2-24-2004, FILED 6-23-2003.

SUPER COMFORT

FOR OUTDOOR, PATIO AND CASUAL FURNITURE (U.S. CLS. 2, 13, 22, 25, 32 AND 50).
FIRST USE 5-2-2007; IN COMMERCE 5-2-2007.

3,313,143. SIDDHI, ANDREW, LARKSPUR, CA. SN 76-641,245. PUB. 7-18-2006, FILED 6-20-2005.

LUIGIANNI

THE MARK CONSISTS OF STANDARD CHARACTERS WITHOUT CLAIM TO ANY PARTICULAR FONT, STYLE, SIZE, OR COLOR.

FOR NON-METAL MONEY CLIPS (U.S. CLS. 2, 13, 22, 25, 32 AND 50).
FIRST USE 4-10-2007; IN COMMERCE 4-10-2007.

3,313,281. BURNES HOME ACCENTS, LLC, AUSTIN, TX. SN 77-015,584. PUB. 2-27-2007, FILED 10-6-2006.

LEVEL-LINE

THE MARK CONSISTS OF STANDARD CHARACTERS WITHOUT CLAIM TO ANY PARTICULAR FONT, STYLE, SIZE, OR COLOR.

FOR DECORATIVE LEDGES, MIRRORS AND PICTURE FRAMES; AND KITS CONSISTING OF BRACKETS WITH BUILT IN LEVEL, SOLD AS A UNIT, FOR USE IN HANGING ITEMS FROM A WALL (U.S. CLS. 2, 13, 22, 25, 32 AND 50).
FIRST USE 7-0-2004; IN COMMERCE 7-0-2004.

3,313,326. JAMI, INC., OVERLAND PARK, KS. SN 77-042,070. PUB. 5-22-2007, FILED 11-12-2006.

TURBO**CLASS 20—(Continued).**

THE MARK CONSISTS OF STANDARD CHARACTERS WITHOUT CLAIM TO ANY PARTICULAR FONT, STYLE, SIZE, OR COLOR.

FOR CHAIRS (U.S. CLS. 2, 13, 22, 25, 32 AND 50).
FIRST USE 3-12-2007; IN COMMERCE 3-12-2007.

3,313,377. SEALY TECHNOLOGY LLC, TRINITY, NC. SN 78-247,219. PUB. 1-20-2004, FILED 5-8-2003.

SUPPORT CHANNELS

NO CLAIM IS MADE TO THE EXCLUSIVE RIGHT TO USE "SUPPORT", APART FROM THE MARK AS SHOWN.

FOR MATTRESSES AND BOXSPRINGS (U.S. CLS. 2, 13, 22, 25, 32 AND 50).
FIRST USE 6-0-2003; IN COMMERCE 6-0-2003.

3,313,491. NEOPETS, INC., GLENDALE, CA. SN 78-483,377. PUB. 8-16-2005, FILED 9-14-2004.

GRUSLEN

THE MARK CONSISTS OF STANDARD CHARACTERS WITHOUT CLAIM TO ANY PARTICULAR FONT, STYLE, SIZE, OR COLOR.

FOR NON-METAL AND NON-LEATHER KEY CHAINS, PLASTIC KEY CHAIN TAGS, PLASTIC NAME BADGES, PAPER PHOTO FRAMES, PAPER PICTURE FRAMES, PICTURE FRAMES, NOVELTY DISPLAY BOARDS, HEAD SUPPORTING PILLOWS, PILLOWS (U.S. CLS. 2, 13, 22, 25, 32 AND 50).
FIRST USE 7-8-2005; IN COMMERCE 7-8-2005.

CLASS 20—(Continued).

3,313,492. NEOPETS, INC., GLENDALE, CA. SN 78-483,391.
PUB. 8-30-2005, FILED 9-14-2004.

CLASS 20—(Continued).

3,313,494. NEOPETS, INC., GLENDALE, CA. SN 78-483,460.
PUB. 8-23-2005, FILED 9-14-2004.

HASEE

SNARHOOK

THE MARK CONSISTS OF STANDARD CHARACTERS WITHOUT CLAIM TO ANY PARTICULAR FONT, STYLE, SIZE, OR COLOR.

FOR NON-METAL AND NON-LEATHER KEY CHAINS, PLASTIC KEY CHAIN TAGS, PLASTIC NAME BADGES, PAPER PHOTO FRAMES, PAPER PICTURE FRAMES, PICTURE FRAMES, NOVELTY DISPLAY BOARDS, HEAD SUPPORTING PILLOWS, PILLOWS (U.S. CLS. 2, 13, 22, 25, 32 AND 50).

FIRST USE 7-8-2005; IN COMMERCE 7-8-2005.

THE MARK CONSISTS OF STANDARD CHARACTERS WITHOUT CLAIM TO ANY PARTICULAR FONT, STYLE, SIZE, OR COLOR.

FOR NON-METAL AND NON-LEATHER KEY CHAINS, PLASTIC KEY CHAIN TAGS, PLASTIC NAME BADGES, PAPER PHOTO FRAMES, PAPER PICTURE FRAMES, PICTURE FRAMES, NOVELTY DISPLAY BOARDS, HEAD SUPPORTING PILLOWS, PILLOWS (U.S. CLS. 2, 13, 22, 25, 32 AND 50).

FIRST USE 7-8-2005; IN COMMERCE 7-8-2005.

3,313,730. DALIAN HUAFENG FURNITURE CO., LTD, DALIAN, CHINA. SN 78-649,045. PUB. 2-28-2006, FILED 6-13-2005.

SUNNY EAST

3,313,493. NEOPETS, INC., GLENDALE, CA. SN 78-483,444.
PUB. 8-23-2005, FILED 9-14-2004.

THE MARK CONSISTS OF STANDARD CHARACTERS WITHOUT CLAIM TO ANY PARTICULAR FONT, STYLE, SIZE, OR COLOR.

FOR FURNITURE (U.S. CLS. 2, 13, 22, 25, 32 AND 50).
FIRST USE 2-20-2007; IN COMMERCE 2-20-2007.

RAINDORF

3,313,734. DEER KING COMPANY, LLC, CANTERBURY, NH. SN 78-650,666. PUB. 3-7-2006, FILED 6-14-2005.

DEER KING

THE MARK CONSISTS OF STANDARD CHARACTERS WITHOUT CLAIM TO ANY PARTICULAR FONT, STYLE, SIZE, OR COLOR.

FOR NON-METAL AND NON-LEATHER KEY CHAINS, PLASTIC KEY CHAIN TAGS, PLASTIC NAME BADGES, PAPER PHOTO FRAMES, PAPER PICTURE FRAMES, PICTURE FRAMES, NOVELTY DISPLAY BOARDS, HEAD SUPPORTING PILLOWS, PILLOWS (U.S. CLS. 2, 13, 22, 25, 32 AND 50).

FIRST USE 7-8-2005; IN COMMERCE 7-8-2005.

THE MARK CONSISTS OF STANDARD CHARACTERS WITHOUT CLAIM TO ANY PARTICULAR FONT, STYLE, SIZE, OR COLOR.

FOR NON-METALLIC STORAGE UNITS FOR SPORTING GOODS (U.S. CLS. 2, 13, 22, 25, 32 AND 50).

FIRST USE 12-8-2005; IN COMMERCE 12-8-2005.

CLASS 20—(Continued).

3,313,824. ARM'S REACH CONCEPTS, INC., MALIBU, CA. SN 78-689,903. PUB. 7-18-2006, FILED 8-10-2005.

DESKETTE

THE MARK CONSISTS OF STANDARD CHARACTERS WITHOUT CLAIM TO ANY PARTICULAR FONT, STYLE, SIZE, OR COLOR.

FOR INFANTS' BASSINETS THAT CONVERT INTO OTHER ITEMS OF INFANTS'/CHILDREN'S FURNITURE, NAMELY DESK OR LOVESEAT (U.S. CLS. 2, 13, 22, 25, 32 AND 50).

FIRST USE 4-5-2007; IN COMMERCE 4-5-2007.

3,313,961. JORDAN OUTDOOR ENTERPRISES, LTD., COLUMBUS, GA. SN 78-744,488. PUB. 7-11-2006, FILED 11-1-2005.

TEAM REALTREE JR.

THE MARK CONSISTS OF STANDARD CHARACTERS WITHOUT CLAIM TO ANY PARTICULAR FONT, STYLE, SIZE, OR COLOR.

NO CLAIM IS MADE TO THE EXCLUSIVE RIGHT TO USE "JR.", APART FROM THE MARK AS SHOWN.

FOR FURNITURE (U.S. CLS. 2, 13, 22, 25, 32 AND 50).

FIRST USE 4-9-2007; IN COMMERCE 4-9-2007.

3,314,145. UNITED COMB & NOVELTY CORPORATION, LEOMINSTER, MA. SN 78-776,519. PUB. 9-12-2006, FILED 12-19-2005.

UNITED SOLUTIONS

THE MARK CONSISTS OF STANDARD CHARACTERS WITHOUT CLAIM TO ANY PARTICULAR FONT, STYLE, SIZE, OR COLOR.

FOR HAMPERS; NON-METAL BINS (U.S. CLS. 2, 13, 22, 25, 32 AND 50).

FIRST USE 6-21-2006; IN COMMERCE 6-21-2006.

CLASS 20—(Continued).

3,314,165. DEMCO, INC., MADISON, WI. SN 78-779,100. PUB. 9-5-2006, FILED 12-22-2005.

LIBRACRAFT

THE MARK CONSISTS OF STANDARD CHARACTERS WITHOUT CLAIM TO ANY PARTICULAR FONT, STYLE, SIZE, OR COLOR.

FOR LIBRARY FURNITURE AND DISPLAY RACKS FOR THE DISPLAY OF BOOKS, VIDEO, DVDS, CDS, NEWSPAPERS, MAGAZINES, LITERATURE, AND VARIOUS OTHER TYPES OF MEDIA (U.S. CLS. 2, 13, 22, 25, 32 AND 50).

FIRST USE 1-1-2006; IN COMMERCE 1-1-2006.

3,314,212. OPTIONS UNLIMITED INTERNATIONAL, L.L.C., WOODINVILLE, WA. SN 78-788,777. PUB. 9-12-2006, FILED 1-10-2006.

TravelSleeper.com

THE MARK CONSISTS OF THE WORD TRAVELSLEEPER.COM WRITTEN IN BUBBLED LETTERING IN AN UPWARD WAVE MANNER FROM LEFT TO RIGHT.

FOR SLEEPING MATS, NAMELY, PORTABLE SLEEPING PADS (U.S. CLS. 2, 13, 22, 25, 32 AND 50).

FIRST USE 1-30-2007; IN COMMERCE 1-30-2007.

CLASS 20—(Continued).

3,314,213. JOHN RICH & SONS INVESTMENT HOLDING COMPANY, WILMINGTON, DE. SN 78-788,878. PUB. 9-5-2006, FILED 1-10-2006.

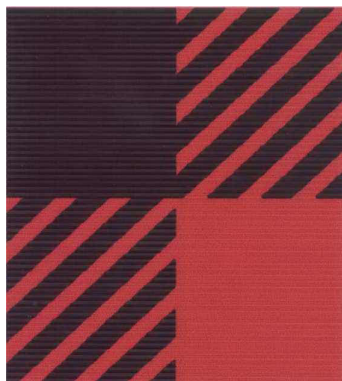

THE COLOR(S) RED AND BLACK IS/ARE CLAIMED AS A FEATURE OF THE MARK.

THE MARK CONSISTS OF A SQUARE MADE UP OF FOUR SMALLER SQUARES. THE UPPER LEFT SQUARE IS BLACK. THE LOWER RIGHT SQUARE IS RED. THE UPPER RIGHT AND LOWER LEFT SQUARES ARE DIAGONAL BLACK AND RED STRIPES.

FOR SHOWER CURTAIN RINGS (U.S. CLS. 2, 13, 22, 25, 32 AND 50).

FIRST USE 1-31-2007; IN COMMERCE 1-31-2007.

3,314,242. WINNING LINK, INC., HIGH POINT, NC. SN 78-793,116. PUB. 9-26-2006, FILED 1-17-2006.

DRIVERS' SERIES

THE MARK CONSISTS OF STANDARD CHARACTERS WITHOUT CLAIM TO ANY PARTICULAR FONT, STYLE, SIZE, OR COLOR.

NO CLAIM IS MADE TO THE EXCLUSIVE RIGHT TO USE "SERIES", APART FROM THE MARK AS SHOWN.

FOR FURNITURE (U.S. CLS. 2, 13, 22, 25, 32 AND 50). FIRST USE 2-18-2003; IN COMMERCE 2-18-2003.

CLASS 20—(Continued).

3,314,343. SCS LTD., LAKE ARIEL, PA. SN 78-813,374. PUB. 10-10-2006, FILED 2-13-2006.

COTMASTER

THE MARK CONSISTS OF STANDARD CHARACTERS WITHOUT CLAIM TO ANY PARTICULAR FONT, STYLE, SIZE, OR COLOR.

FOR PORTABLE COT ENCLOSED IN NETTING OR OTHER MATERIAL TO PROTECT THE USER FROM MOSQUITOES OR OTHER INSECTS (U.S. CLS. 2, 13, 22, 25, 32 AND 50).

FIRST USE 7-30-2006; IN COMMERCE 7-30-2006.

3,314,383. STEELCASE DEVELOPMENT CORPORATION, CALEDONIA, MI. SN 78-819,263. PUB. 9-12-2006, FILED 2-21-2006.

NURTURE

THE MARK CONSISTS OF STANDARD CHARACTERS WITHOUT CLAIM TO ANY PARTICULAR FONT, STYLE, SIZE, OR COLOR.

FOR FURNITURE FOR HEALTHCARE ENVIRONMENTS (U.S. CLS. 2, 13, 22, 25, 32 AND 50).

FIRST USE 6-0-2006; IN COMMERCE 6-0-2006.

3,314,912. DISNEY ENTERPRISES, INC., BURBANK, CA. SN 78-978,913. PUB. 9-19-2006, FILED 5-25-2005.



OWNER OF U.S. REG. NOS. 2,516,004, 2,784,058, AND OTHERS.

FOR JEWELRY BOXES NOT OF METAL; PILLOWS; PLASTIC FLAGS; PLASTIC NAME BADGES (U.S. CLS. 2, 13, 22, 25, 32 AND 50).

FIRST USE 5-0-2005; IN COMMERCE 5-0-2005.

CLASS 21—HOUSEWARES AND GLASS

3,313,083. ALI, WAIEL, CARLSBAD, CA. SN 76-620,458. PUB. 7-11-2006, FILED 11-15-2004.



NO CLAIM IS MADE TO THE EXCLUSIVE RIGHT TO USE "TRAY", APART FROM THE MARK AS SHOWN.

THE LINING AND STIPPLING SHOWN IN THE DRAWING IS A FEATURE OF THE MARK.

FOR TRAYS MADE OF PLASTIC; TRAVEL ACCESSORIES, NAMELY, PORTABLE CUP HOLDERS MADE OF PLASTIC (U.S. CLS. 2, 13, 23, 29, 30, 33, 40 AND 50). FIRST USE 4-6-2006; IN COMMERCE 4-6-2006.

3,313,194. PLATT, SHERI, PASADENA, MD. SN 76-655,582. PUB. 11-21-2006, FILED 2-23-2006.

LITTERZIPPER

THE MARK CONSISTS OF STANDARD CHARACTERS WITHOUT CLAIM TO ANY PARTICULAR FONT, STYLE, SIZE, OR COLOR.

FOR SCOOPS FOR THE DISPOSAL OF ANIMAL WASTE (U.S. CLS. 2, 13, 23, 29, 30, 33, 40 AND 50). FIRST USE 7-19-2006; IN COMMERCE 7-19-2006.

3,313,454. BLOUIN, JOHN, JUPITER, FL. SN 78-428,919. PUB. 7-18-2006, FILED 6-2-2004.

CYPRESS PROJECT

THE MARK CONSISTS OF STANDARD CHARACTERS WITHOUT CLAIM TO ANY PARTICULAR FONT, STYLE, SIZE, OR COLOR.

FOR PLANT WATERING, CONSERVATION, AND POLLUTION CONTROL SYSTEM FOR USE WITH ANY FORM OF VEGETATION, COMPRISED OF A PLANTER, AN UPWARDLY DIRECTED OVERFLOW FUNNEL, AND AN ELECTRICAL FLOAT SWITCH FOR CONTROLLING A VEGATION WATER SPRINKLER (U.S. CLS. 2, 13, 23, 29, 30, 33, 40 AND 50). FIRST USE 4-9-2007; IN COMMERCE 4-9-2007.

CLASS 21—(Continued).

3,313,504. QUICKIE MANUFACTURING CORPORATION, CINNAMINSON, NJ. SN 78-497,482. PUB. 9-13-2005, FILED 10-10-2004.

EZ-WRINGER

THE MARK CONSISTS OF STANDARD CHARACTERS WITHOUT CLAIM TO ANY PARTICULAR FONT, STYLE, SIZE, OR COLOR.

FOR MOPS (U.S. CLS. 2, 13, 23, 29, 30, 33, 40 AND 50). FIRST USE 1-31-2005; IN COMMERCE 1-31-2005.

3,313,596. YIN SHAN MFG BRUSHES CO., LTD., TAIZHOU CITY, ZHEJIANG, CHINA. SN 78-585,094. PUB. 12-19-2006, FILED 3-11-2005.



THE ENGLISH TRANSLATION OF YIN SHAN IS PRINT MOUNTAIN IN ENGLISH.

THE NON-LATIN CHARACTER(S) IN THE MARK TRANSLITERATES INTO YIN; SHAN, AND THIS MEANS PRINT; MOUNTAIN IN ENGLISH.

FOR FRUIT CUPS; CRUETS NOT OF PRECIOUS METAL; CRUET STANDS FOR OIL OR VINEGAR NOT OF PRECIOUS METAL; BASKETS FOR DOMESTIC USE, NOT OF METAL, NAMELY FITTED PICNIC BASKETS, FLOWER BASKETS, PLANT BASKETS; CANDY BOXES OF GLASS; BRUSHES, NAMELY TOILET BRUSHES, BRUSHES FOR FOOTWEAR, BRUSHES FOR BASTING MEAT, BRUSHES FOR BILLIARD TABLES, BRUSHES FOR PARQUET FLOORS, BRUSHES FOR PETS, BRUSHES FOR USE ON BARK OF TREES, ELECTRIC AND NON-ELECTRIC TOOTHBRUSHES, WIRE BRUSHES, NOT BEING MACHINE PARTS, COSMETIC BRUSHES; TOILETS UTENSILS, NAMELY HAND WASH BASINS, BABY BATHTUBS; CLOTHING STRETCHERS; SOAP HOLDERS; PLASTIC BUCKETS; DUST BINS (U.S. CLS. 2, 13, 23, 29, 30, 33, 40 AND 50). FIRST USE 11-2-1999; IN COMMERCE 4-28-2004.

CLASS 21—(Continued).

3,313,607. FIRTH, CHARLES B., BATAVIA, IL. SN 78-591,082. PUB. 12-27-2005, FILED 3-20-2005.

duranimals

THE MARK CONSISTS OF STANDARD CHARACTERS WITHOUT CLAIM TO ANY PARTICULAR FONT, STYLE, SIZE, OR COLOR.

FOR LITTER PANS AND OTHER PRODUCTS AND TOOLS RELATED TO COMPANION ANIMAL CARE, NAMELY, LITTER SCOOPS, LITTER MATS, COMBS, BRUSHES, MAT SPLITTERS AND COAT RAKES (U.S. CLS. 2, 13, 23, 29, 30, 33, 40 AND 50).

FIRST USE 5-28-2006; IN COMMERCE 7-30-2006.

CLASS 21—(Continued).

3,313,638. FOOD EQUIPMENT TECHNOLOGIES COMPANY, INC., LAKE ZURICH, IL. SN 78-609,780. PUB. 1-17-2006, FILED 4-15-2005.

BREAKING FRESH GROUNDS

THE MARK CONSISTS OF STANDARD CHARACTERS WITHOUT CLAIM TO ANY PARTICULAR FONT, STYLE, SIZE, OR COLOR.

FOR COMMERCIAL PORTABLE INSULATED BEVERAGE DISPENSERS AND COMMERCIAL BEVERAGE SERVERS IN THE NATURE OF NON-ELECTRIC COFFEE SERVERS NOT OF PRECIOUS METALS, NON-ELECTRIC INSULATED AIRPOTS, AND THERMALLY INSULATED BEVERAGE BOTTLES, ALL SOLD TO RESTAURANTS, COFFEE SHOPS, CATERERS AND OTHER COMMERCIAL PROVIDERS OF LARGE QUANTITIES OF FRESHLY BREWED BEVERAGE (U.S. CLS. 2, 13, 23, 29, 30, 33, 40 AND 50).

FIRST USE 1-1-2005; IN COMMERCE 1-1-2005.

3,313,628. PIONEER INTERSTATE, INC., DBA TIGER CLAW, KNOXVILLE, TN. SN 78-605,143. PUB. 8-22-2006, FILED 4-8-2005.



THE MARK CONSISTS OF A KICKING TIGER, FOR BOTTLES, SOLD EMPTY (U.S. CLS. 2, 13, 23, 29, 30, 33, 40 AND 50).

FIRST USE 8-0-2004; IN COMMERCE 5-8-2007.

3,313,745. STUDIO CROSSROADS, INC., SUGAR LAND, TX. SN 78-653,752. PUB. 3-21-2006, FILED 6-19-2005.



NO CLAIM IS MADE TO THE EXCLUSIVE RIGHT TO USE "STUDIO" AND "INC.", APART FROM THE MARK AS SHOWN.

THE MARK CONSISTS OF A DESIGN OF WATER GOBLET, WINE GLASSES, BOWLS, AND A FISH IN THE NORTHWESTERN QUADRANT OF THE MARK ALONG WITH THE STYLIZED TERMS "STUDIO CROSSROADS INC." APPEARING ADJACENT TO THE DESIGN ELEMENTS.

FOR WORKS OF ART, NAMELY, CERAMIC CROSSES (U.S. CLS. 2, 13, 23, 29, 30, 33, 40 AND 50).

FIRST USE 1-1-2005; IN COMMERCE 5-1-2005.

CLASS 21—(Continued).

3,313,819. WESTMINSTER, INC., ATLANTA, GA. SN 78-685,639. PUB. 4-10-2007, FILED 8-4-2005.

Titanware

THE MARK CONSISTS OF STANDARD CHARACTERS WITHOUT CLAIM TO ANY PARTICULAR FONT, STYLE, SIZE, OR COLOR.

FOR COOKWARE, NAMELY, POTS, PANS, POT LIDS AND PAN LIDS (U.S. CLS. 2, 13, 23, 29, 30, 33, 40 AND 50).

FIRST USE 3-9-2006; IN COMMERCE 3-9-2006.

3,313,848. EARTH CHEMICAL COMPANY LIMITED, TOKYO, JAPAN. SN 78-700,332. PUB. 5-9-2006, FILED 8-25-2005.

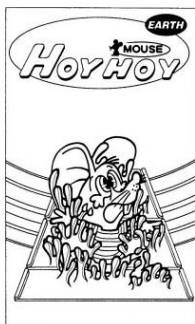

OWNER OF U.S. REG. NOS. 1,069,253 AND 3,061,525. NO CLAIM IS MADE TO THE EXCLUSIVE RIGHT TO USE "MOUSE", APART FROM THE MARK AS SHOWN.

THE ENGLISH TRANSLATION OF THE WORD "HOY" IN THE MARK IS "TODAY".

FOR MOUSE TRAP (U.S. CLS. 2, 13, 23, 29, 30, 33, 40 AND 50).

FIRST USE 2-1-2001; IN COMMERCE 8-4-2005.

CLASS 21—(Continued).

3,313,898. ROMAR INTERNATIONAL CORP., NEW YORK, NY. SN 78-718,603. PUB. 6-20-2006, FILED 9-22-2005.

SIP & SNACK

THE MARK CONSISTS OF STANDARD CHARACTERS WITHOUT CLAIM TO ANY PARTICULAR FONT, STYLE, SIZE, OR COLOR.

FOR COMBINATION DRIPLESS DRINKING CUP AND FOOD CONTAINER (U.S. CLS. 2, 13, 23, 29, 30, 33, 40 AND 50).

FIRST USE 12-6-2005; IN COMMERCE 12-6-2005.

3,313,983. BLACK & DECKER CORPORATION, THE, TOWSON, MD. SN 78-749,571. PUB. 7-11-2006, FILED 11-8-2005.

CANAVERAL

THE MARK CONSISTS OF STANDARD CHARACTERS WITHOUT CLAIM TO ANY PARTICULAR FONT, STYLE, SIZE, OR COLOR.

FOR BATHROOM ACCESSORIES, NAMELY, TOWEL BARS, TOWEL RINGS, TOILET TISSUE HOLDERS, SOAP DISHES AND TOOTHBRUSH-TUMBLER HOLDERS (U.S. CLS. 2, 13, 23, 29, 30, 33, 40 AND 50).

FIRST USE 9-24-2004; IN COMMERCE 9-24-2004.

3,313,984. THE BLACK & DECKER CORPORATION, TOWSON, MD. SN 78-749,591. PUB. 7-4-2006, FILED 11-8-2005.

CHAMPLAIN

THE MARK CONSISTS OF STANDARD CHARACTERS WITHOUT CLAIM TO ANY PARTICULAR FONT, STYLE, SIZE, OR COLOR.

FOR BATHROOM ACCESSORIES, NAMELY, TOWEL BARS, TOWEL RINGS, TOILET TISSUE HOLDERS, SOAP DISHES AND TOOTHBRUSH-TUMBLER HOLDERS (U.S. CLS. 2, 13, 23, 29, 30, 33, 40 AND 50).

FIRST USE 9-24-2004; IN COMMERCE 9-24-2004.

CLASS 21—(Continued).

3,313,985. BLACK & DECKER CORPORATION, THE, TOWSON, MD. SN 78-749,604. PUB. 7-11-2006, FILED 11-8-2005.

HYANNIS

THE MARK CONSISTS OF STANDARD CHARACTERS WITHOUT CLAIM TO ANY PARTICULAR FONT, STYLE, SIZE, OR COLOR.

FOR BATHROOM ACCESSORIES, NAMELY, TOWEL BARS, TOWEL RINGS, TOILET TISSUE HOLDERS, SOAP DISHES AND TOOTHBRUSH-TUMBLER HOLDERS (U.S. CLS. 2, 13, 23, 29, 30, 33, 40 AND 50).
FIRST USE 12-2-2004; IN COMMERCE 12-2-2004.

3,313,986. BLACK & DECKER CORPORATION, THE, TOWSON, MD. SN 78-749,615. PUB. 7-11-2006, FILED 11-8-2005.

ANZIO

THE MARK CONSISTS OF STANDARD CHARACTERS WITHOUT CLAIM TO ANY PARTICULAR FONT, STYLE, SIZE, OR COLOR.

FOR BATHROOM ACCESSORIES, NAMELY, TOWEL BARS, TOWEL RINGS, TOILET TISSUE HOLDERS, SOAP DISHES AND TOOTHBRUSH-TUMBLER HOLDERS (U.S. CLS. 2, 13, 23, 29, 30, 33, 40 AND 50).
FIRST USE 1-11-2006; IN COMMERCE 1-11-2006.

3,314,067. HEB GROCERY COMPANY, L.P., SAN ANTONIO, TX. SN 78-764,691. PUB. 2-14-2006, FILED 12-1-2005.

H•E•BUDDY

OWNER OF U.S. REG. NOS. 2,721,038, 2,909,042, AND OTHERS.

FOR DISPOSABLE PAPER PLATES; DISPOSABLE PAPER BOWLS (U.S. CLS. 2, 13, 23, 29, 30, 33, 40 AND 50).
FIRST USE 10-0-2006; IN COMMERCE 10-0-2006.

CLASS 21—(Continued).

3,314,147. UNITED COMB & NOVELTY CORPORATION, LEOMINSTER, MA. SN 78-776,801. PUB. 9-12-2006, FILED 12-20-2005.

UNITED SOLUTIONS

THE MARK CONSISTS OF STANDARD CHARACTERS WITHOUT CLAIM TO ANY PARTICULAR FONT, STYLE, SIZE, OR COLOR.

FOR LAUNDRY BASKETS, TRASH CANS, PORTABLE NON-METAL HOUSEHOLD STORAGE CONTAINERS (U.S. CLS. 2, 13, 23, 29, 30, 33, 40 AND 50).

FIRST USE 5-18-2006; IN COMMERCE 5-18-2006.

3,314,158. HUHTAMAKI COMPANY MANUFACTURING, DESOTO, KS. SN 78-777,846. PUB. 9-19-2006, FILED 12-21-2005.

PAPER PRO

THE MARK CONSISTS OF STANDARD CHARACTERS WITHOUT CLAIM TO ANY PARTICULAR FONT, STYLE, SIZE, OR COLOR.

NO CLAIM IS MADE TO THE EXCLUSIVE RIGHT TO USE "PAPER", APART FROM THE MARK AS SHOWN.

FOR PLATES, BOWLS, PLATTERS, TRAYS AND CUP CARRIERS MADE OF MOLDED PAPER FIBER (U.S. CLS. 2, 13, 23, 29, 30, 33, 40 AND 50).

FIRST USE 2-7-2006; IN COMMERCE 3-13-2007.

3,314,214. JOHN RICH & SONS INVESTMENT HOLDING COMPANY, WILMINGTON, DE. SN 78-788,884. PUB. 9-5-2006, FILED 1-10-2006.



THE COLOR(S) RED AND BLACK IS/ARE CLAIMED AS

CLASS 21—(Continued).

A FEATURE OF THE MARK.

THE MARK CONSISTS OF A SQUARE MADE UP OF FOUR SMALLER SQUARES. THE UPPER LEFT SQUARE IS BLACK. THE LOWER RIGHT SQUARE IS RED. THE UPPER RIGHT AND LOWER LEFT SQUARES ARE DIAGONAL BLACK AND RED STRIPES.

FOR LIQUID SOAP DISPENSERS, LOTION PUMPS, SOAP DISHES, TISSUE BOXES, TOOTHBRUSH HOLDERS, WASTE BASKETS (U.S. CLS. 2, 13, 23, 29, 30, 33, 40 AND 50).

FIRST USE 1-31-2007; IN COMMERCE 1-31-2007.

3,314,219. NTT ADVANCED TECHNOLOGY CORPORATION, SHINJUKU-KU, TOKYO, JAPAN. SN 78-789,199. PUB. 8-29-2006, FILED 1-11-2006.

NEOCLEAN

THE MARK CONSISTS OF STANDARD CHARACTERS WITHOUT CLAIM TO ANY PARTICULAR FONT, STYLE, SIZE, OR COLOR.

FOR OPTICAL FIBER CONNECTOR CLEANERS MADE OF CLOTH (U.S. CLS. 2, 13, 23, 29, 30, 33, 40 AND 50).

FIRST USE 1-15-2006; IN COMMERCE 8-22-2006.

3,314,223. GROBAL, L.L.C., CHANDLER, AZ. SN 78-790,171. PUB. 10-17-2006, FILED 1-12-2006.

NUTRIPORT

THE MARK CONSISTS OF STANDARD CHARACTERS WITHOUT CLAIM TO ANY PARTICULAR FONT, STYLE, SIZE, OR COLOR.

FOR PLANT CULTIVATING SYSTEMS, NAMELY, TERRARIUMS FOR PLANTS, PLANT POTS; PLANT CONTAINERS, NAMELY, POTS AND PLANTERS FOR FLOWERS AND PLANTS; PLASTIC HYDROPONICS UNITS, NAMELY, TERRARIUMS FOR PLANTS, PLANTERS AND POTS FOR CULTIVATION OF PLANTS IN NUTRIENT SOLUTION; PARTS AND ACCESSORIES FOR SUCH CULTIVATING SYSTEMS, CONTAINERS AND HYDROPONICS UNITS, NAMELY, ACCESS HATCHES AND CHUTES TO FACILITATE THE DELIVERY OF FERTILIZERS, NUTRIENTS AND PLANT ADDITIVES, SOLD AS A PART OF SUCH CULTIVATING SYSTEMS, CONTAINERS AND HYDROPONICS UNITS AND SEPARATELY AS SPARE COMPONENTS FOR USE WITH SUCH CULTIVATING SYSTEMS, CONTAINERS AND HYDROPONICS UNITS (U.S. CLS. 2, 13, 23, 29, 30, 33, 40 AND 50).

FIRST USE 3-1-2007; IN COMMERCE 3-1-2007.

CLASS 21—(Continued).

3,314,301. CONTINENTAL COMMERCIAL PRODUCTS, LLC, BRIDGETON, MO. SN 78-805,181. PUB. 10-3-2006, FILED 2-2-2006.

ERGO WORX

THE MARK CONSISTS OF STANDARD CHARACTERS WITHOUT CLAIM TO ANY PARTICULAR FONT, STYLE, SIZE, OR COLOR.

FOR MOPS, MOP HEADS, AND CLEANING PADS (U.S. CLS. 2, 13, 23, 29, 30, 33, 40 AND 50).

FIRST USE 1-18-2006; IN COMMERCE 1-18-2006.

3,314,308. CONTINENTAL COMMERCIAL PRODUCTS, LLC, BRIDGETON, MO. SN 78-806,816. PUB. 10-3-2006, FILED 2-3-2006.

ERGO WORX

THE MARK CONSISTS OF STANDARD CHARACTERS WITHOUT CLAIM TO ANY PARTICULAR FONT, STYLE, SIZE, OR COLOR.

FOR BUCKETS (U.S. CLS. 2, 13, 23, 29, 30, 33, 40 AND 50).

FIRST USE 1-18-2006; IN COMMERCE 1-18-2006.

3,314,390. FARBERWARE LICENSING COMPANY LLC, NEEDHAM, MA. SN 78-820,573. PUB. 4-10-2007, FILED 2-22-2006.

RELIANCE

THE MARK CONSISTS OF STANDARD CHARACTERS WITHOUT CLAIM TO ANY PARTICULAR FONT, STYLE, SIZE, OR COLOR.

FOR COOKWARE, NAMELY, NON-ELECTRIC, METAL POTS AND PANS FOR COOKING; BAKEWARE VESSELS FOR OVEN USE; BAKEWARE (U.S. CLS. 2, 13, 23, 29, 30, 33, 40 AND 50).

FIRST USE 9-30-2006; IN COMMERCE 9-30-2006.

CLASS 21—(Continued).

3,314,500. HALLER SCHWARZ, LONG BEACH, CA. SN 78-853,260. PUB. 1-2-2007, FILED 4-4-2006.



OWNER OF U.S. REG. NO. 2,851,639.
THE MARK CONSISTS OF A CARTOON CHARACTER WITH ARMS FOLDED AND WEARING A MOLAR-SHAPED HAT APPEARS OUT OF A BLACK CIRCLE. IN A CURVE ABOVE THE CIRCLE APPEAR THE WORDS THE TOOTH, AND BELOW THE FIGURE APPEARS THE WORD TEAM.

FOR DENTAL FLOSS; MANUAL TOOTHBRUSHES (U.S. CLS. 2, 13, 23, 29, 30, 33, 40 AND 50).
FIRST USE 4-4-2006; IN COMMERCE 5-28-2007.

3,314,666. LIFETIME BRANDS, INC., GARDEN CITY, NY.
SN 78-902,404. PUB. 12-26-2006, FILED 6-7-2006.



FOR BAKEWARE (U.S. CLS. 2, 13, 23, 29, 30, 33, 40 AND 50).
FIRST USE 8-0-2006; IN COMMERCE 8-0-2006.

CLASS 21—(Continued).

3,314,782. FOH, INC., MIAMI, FL. SN 78-940,249. PUB. 2-13-2007, FILED 7-28-2006.

Room 360°

THE MARK CONSISTS OF STANDARD CHARACTERS WITHOUT CLAIM TO ANY PARTICULAR FONT, STYLE, SIZE, OR COLOR.

NO CLAIM IS MADE TO THE EXCLUSIVE RIGHT TO USE "ROOM", APART FROM THE MARK AS SHOWN.

FOR BASKETS OF RATTAN; BATH ACCESSORIES, NAMELY, CUP HOLDERS; BATH BRUSHES; BOWLS; BUCKETS; BUCKETS OF WOVEN FABRIC; BUTLERS' TRAYS; CARAFES; CERAMIC TISSUE BOX COVERS; CHAMPAGNE BUCKETS; COCKTAIL SHAKERS; COFFEE CUPS; COFFEE POTS NOT OF PRECIOUS METAL; COFFEE SERVICES NOT OF PRECIOUS METAL; COFFEE STIRRERS; CONTAINERS FOR ICE; COOLERS FOR WINE; COOLING BUCKETS FOR WINE; CORK SCREWS; COTTON BALL DISPENSERS; CUPS; DECANTERS; DECORATIVE GLASS; DECORATIVE PLATES; DISPENSERS FOR LIQUID SOAP; DISPENSERS FOR PAPER TOWELS; DRINKING CUPS; DRINKING GLASSES; DRINKING VESSELS; EARTHENWARE BASINS; EARTHENWARE MUGS; FLOWER BASKETS; FLOWER BOWLS; FLOWER VASES AND BOWLS; FRUIT BOWLS; FRUIT BOWLS OF GLASS; GLASS BEVERAGeware; GLASS BOWLS; GLASS BOXES; GLASS CARAFES; GLASS DISHES; GLASS MUGS; GOBLET; HOLDERS FOR FLOWERS AND PLANTS; HOLDERS FOR TOILET PAPER; ICE PAILS; ICE SCOOPS; JAPANESE STYLE PERSONAL DINING TRAYS OR STANDS (ZEN); LEATHER COASTERS; MEAL TRAYS; MUG TREES; MUGS; NON-ELECTRIC COFFEE POTS NOT OF PRECIOUS METAL; NON-ELECTRIC COFFEE SERVERS NOT OF PRECIOUS METAL; PAILS; PASTRY BOARDS; PITCHERS; PLASTIC BUCKETS; PLASTIC COASTERS; PLASTIC CUPS; PORCELAIN MUGS; SCOOPS; SERVING DISHES; SERVING SPOONS; SERVING TONGS; SERVING TRAYS NOT OF PRECIOUS METAL; SHOT GLASSES; SOAP BOXES; SOAP CONTAINERS; SOAP DISHES; SOAP DISPENSERS; SOAP HOLDERS; SOAP HOLDERS AND BOXES; SPECKLED GLASS; SPONGE HOLDERS; SPONGES FOR APPLYING BODY POWDER; STEMWARE; SWIZZLE STICKS; TEA POTS NOT OF PRECIOUS METAL; TEA SERVICES NOT OF PRECIOUS METAL; TEA SETS; TEACUPS (YUNOMI); TOILET BRUSH HOLDERS; TOILET BRUSHES; TOILET PAPER DISPENSERS; TOILET PAPER HOLDERS; TOILET SPONGES; TOILET TISSUE HOLDERS; TOWEL HOLDERS; TRASH CANS; TRASH CONTAINERS FOR HOUSEHOLD USE; TRAYS; VASES; WASTE BASKETS; WASTE PAPER BASKETS; WINE BOTTLE CRADLES; WINE BUCKETS; WINE COOLING PAILS (U.S. CLS. 2, 13, 23, 29, 30, 33, 40 AND 50).
FIRST USE 1-1-2007; IN COMMERCE 1-1-2007.

CLASS 21—(Continued).

3,314,863. RANGE KLEEN MFG., INC., LIMA, OH. SN 78-963,582. PUB. 4-24-2007, FILED 8-30-2006.

GO GO SALAD

THE MARK CONSISTS OF STANDARD CHARACTERS WITHOUT CLAIM TO ANY PARTICULAR FONT, STYLE, SIZE, OR COLOR.

NO CLAIM IS MADE TO THE EXCLUSIVE RIGHT TO USE "SALAD", APART FROM THE MARK AS SHOWN.

FOR CONTAINERS FOR HOUSEHOLD OR KITCHEN USE; HOUSEHOLD CONTAINERS FOR FOODS (U.S. CLS. 2, 13, 23, 29, 30, 33, 40 AND 50).

FIRST USE 4-0-2007; IN COMMERCE 4-0-2007.

3,314,877. LENTRADE, INC., DBA CHANTAL COOKWARE CORP., HOUSTON, TX. SN 78-966,996. PUB. 5-29-2007, FILED 9-5-2006.

COPPER FUSION

THE MARK CONSISTS OF STANDARD CHARACTERS WITHOUT CLAIM TO ANY PARTICULAR FONT, STYLE, SIZE, OR COLOR.

NO CLAIM IS MADE TO THE EXCLUSIVE RIGHT TO USE "COPPER", APART FROM THE MARK AS SHOWN.

FOR COOKWARE, NAMELY FRY PANS, SAUCE PANS, SAUTÉ PANS, STOCK POTS, CASSEROLES, PASTA COOKING POTS AND BRAZIER PANS, ROASTER PANS, STIR FRY PANS, CHEF'S PANS, PAELLA PANS, OMELET PANS, AU GRATIN PANS, DOUBLE BOILER INSERTS, AND NON-ELECTRIC GRIDDLE PLATES (U.S. CLS. 2, 13, 23, 29, 30, 33, 40 AND 50).

FIRST USE 3-11-2007; IN COMMERCE 3-11-2007.

CLASS 22—CORDAGE AND FIBERS

3,313,719. POOL COVER CORP., HAUPPAUGE, NY. SN 78-642,264. PUB. 9-26-2006, FILED 6-2-2005.

AQUA-LOC

THE MARK CONSISTS OF STANDARD CHARACTERS WITHOUT CLAIM TO ANY PARTICULAR FONT, STYLE, SIZE, OR COLOR.

FOR PROTECTIVE LINERS OF VINYL FOR SWIMMING POOLS, HOT TUBS AND SPAS (U.S. CLS. 1, 2, 7, 19, 22, 42 AND 50).

FIRST USE 10-31-2006; IN COMMERCE 10-31-2006.

CLASS 22—(Continued).

3,314,080. BEAUPRE, DANIEL, ELMVALE, ONTARIO, CANADA. SN 78-766,295. PUB. 9-12-2006, FILED 12-5-2005.

POOPYSAK

THE MARK CONSISTS OF STANDARD CHARACTERS WITHOUT CLAIM TO ANY PARTICULAR FONT, STYLE, SIZE, OR COLOR.

FOR NYLON BAGS FOR COLLECTING AND DISPOSING OF PET WASTE (U.S. CLS. 1, 2, 7, 19, 22, 42 AND 50).

FIRST USE 1-5-2006; IN COMMERCE 1-5-2006.

3,314,608. PLYMKRAFT, INC., NEWPORT NEWS, VA. SN 78-888,680. PUB. 3-6-2007, FILED 5-22-2006.

FastRope

THE MARK CONSISTS OF STANDARD CHARACTERS WITHOUT CLAIM TO ANY PARTICULAR FONT, STYLE, SIZE, OR COLOR.

OWNER OF U.S. REG. NO. 2,820,781.

FOR ROPE; ROPE, NAMELY, A TACTICAL ROPE FOR USE WITH HELICOPTERS; ROPES USED BY MILITARY SPECIAL OPERATIONS FOR HELICOPTER EVACUATION; TACTICAL ROPE; RESCUE ROPE; ROPE, NAMELY, CLIMBING LINES, REPELLING LINES AND EMERGENCY RESCUE LIFE LINES (U.S. CLS. 1, 2, 7, 19, 22, 42 AND 50).

FIRST USE 6-0-2007; IN COMMERCE 6-0-2007.

CLASS 23—YARNS AND THREADS

CLASS 23—(Continued).

3,313,135. SAEHAN INDUSTRIES INC., KYUNGSANG-DO, REPUBLIC OF KOREA. SN 76-639,743. PUB. 9-12-2006, FILED 5-31-2005.

ESFRON

THE MARK CONSISTS OF STANDARD CHARACTERS WITHOUT CLAIM TO ANY PARTICULAR FONT, STYLE, SIZE, OR COLOR.

FOR SYNTHETIC FIBER THREAD AND YARN FOR TEXTILE USE; SPUN SILK; SEMI-SYNTHETIC FIBER THREAD AND YARN FOR TEXTILE USE; REGENERATED FIBER THREAD AND YARN FOR TEXTILE USE; WOOL BASE MIXED THREAD AND YARN; COTTON BASE MIXED THREAD AND YARN; CHEMICAL FIBER BASE MIXED THREAD AND YARN; JUTE THREAD AND YARN; SPUN THREAD AND YARN; WASTE COTTON YARN (U.S. CL. 43).

FIRST USE 3-20-1999; IN COMMERCE 6-10-2005.

3,313,179. TRIEXE MANAGEMENT GROUP ULC, FOUNT-HILL, ONTARIO, CANADA. SN 76-651,741. PUB. 7-4-2006, FILED 12-7-2005.

STRENEXE

THE MARK CONSISTS OF STANDARD CHARACTERS WITHOUT CLAIM TO ANY PARTICULAR FONT, STYLE, SIZE, OR COLOR.

FOR SYNTHETIC YARN FOR ARTIFICIAL TURF (U.S. CL. 43).

FIRST USE 11-18-2005; IN COMMERCE 11-18-2005.

3,314,175. U-LONG PROSPERITY CO., LTD., TAI PAO CITY, TAIWAN. SN 78-781,822. PUB. 12-12-2006, FILED 12-28-2005.

SHELLON

THE MARK CONSISTS OF STANDARD CHARACTERS WITHOUT CLAIM TO ANY PARTICULAR FONT, STYLE, SIZE, OR COLOR.

FOR THREAD, YARN, COTTON YARN, BLENDING YARN AND SYNTHETIC FIBER YARN, NYLON YARN, KNITTING THREAD, WEAVING THREAD, KNITTING WOOL (U.S. CL. 43).

FIRST USE 10-1-2006; IN COMMERCE 10-1-2006.

CLASS 23—(Continued).

3,314,739. J. & P. COATS, LIMITED, GLASGOW, SCOTLAND. SN 78-924,460. PUB. 2-20-2007, FILED 7-7-2006.

RAG DOLL

THE MARK CONSISTS OF STANDARD CHARACTERS WITHOUT CLAIM TO ANY PARTICULAR FONT, STYLE, SIZE, OR COLOR.

FOR HANDKNITTING YARNS (U.S. CL. 43).

FIRST USE 8-11-2006; IN COMMERCE 8-11-2006.

3,314,741. ORCHARD YARN AND THREAD COMPANY INC., DBA LION BRAND YARN COMPANY, NEW YORK, NY. SN 78-924,488. PUB. 2-13-2007, FILED 7-7-2006.

RUFFLES

THE MARK CONSISTS OF STANDARD CHARACTERS WITHOUT CLAIM TO ANY PARTICULAR FONT, STYLE, SIZE, OR COLOR.

FOR KNITTING AND CROCHET YARNS (U.S. CL. 43).

FIRST USE 8-1-2006; IN COMMERCE 8-1-2006.

3,314,742. J. & P. COATS, LIMITED, GLASGOW, SCOTLAND. SN 78-924,511. PUB. 2-20-2007, FILED 7-7-2006.

STRATA

THE MARK CONSISTS OF STANDARD CHARACTERS WITHOUT CLAIM TO ANY PARTICULAR FONT, STYLE, SIZE, OR COLOR.

FOR HANDKNITTING YARNS (U.S. CL. 43).

FIRST USE 7-6-2006; IN COMMERCE 7-6-2006.

CLASS 24—FABRICS

CLASS 24—(Continued).

3,313,089. SAEHAN INDUSTRIES INC., KYUNGSANGBUK-DO, REPUBLIC OF KOREA. SN 76-623,198. PUB. 3-21-2006, FILED 12-3-2004.

ESLON

THE MARK CONSISTS OF STANDARD CHARACTERS WITHOUT CLAIM TO ANY PARTICULAR FONT, STYLE, SIZE, OR COLOR.

FOR NAP-RAISED DISH TOWELS, RAYON FABRICS, COTTON FABRICS, SEMI-SYNTHETIC FIBER FABRICS, BED SHEETS, SYNTHETIC FIBER FABRICS, CHEMICAL FIBER BASE MIXED FABRICS, MULTIPLE CHEMICAL FIBER FABRICS, COTTON BASE MIXED FABRICS (U.S. CLS. 42 AND 50).

FIRST USE 1-10-1986; IN COMMERCE 12-10-2004.

3,313,398. ZHEJIANG QINGSHENG TEXTILE GROUP CO., LTD., ZHEJIANG PROVINCE, CHINA. SN 78-299,762. PUB. 3-8-2005, FILED 9-12-2003.



慶盛
QINGSHENG

THE CHINESE CHARACTERS IN THE MARK TRANSLITERATE AS "QINGSHENG", TRANSLATES INTO ENGLISH AS "CELEBRATE" AND "FLOURISHING".

FOR FABRICS FOR THE MANUFACTURE OF CURTAINS, SOFA COVERS, CUSHIONS, BED COVERS, PILLOW COVERS FOR DOMESTIC USE; COTTON AND TERYLENE CLOTH; COTTON FABRICS; TEXTILE LININGS FOR GARMENTS; PRINTED CALICO CLOTH; SILK CLOTH; FABRICS FOR TEXTILE USE; UPHOLSTERY FABRICS; WOOLEN CLOTH; WOOLEN FABRICS; AND RAYON FABRICS (U.S. CLS. 42 AND 50).

FIRST USE 1-5-2003; IN COMMERCE 3-6-2007.

CLASS 24—(Continued).

3,313,489. JOHN RICH & SONS INVESTMENT HOLDING COMPANY, WILMINGTON, DE. SN 78-482,635. PUB. 9-6-2005, FILED 9-13-2004.



THE COLOR(S) RED AND BLACK IS/ARE CLAIMED AS A FEATURE OF THE MARK.

THE MARK CONSISTS OF A SQUARE MADE UP OF FOUR SMALLER SQUARES. THE UPPER LEFT SQUARE IS BLACK. THE LOWER RIGHT SQUARE IS RED. THE UPPER RIGHT AND LOWER LEFT SQUARES ARE DIAGONAL BLACK AND RED STRIPES.

FOR BED BLANKETS, TROWLS, WOOL OR WOOL BLEND FABRIC, PILLOW SHAMS AND BED SKIRTS (U.S. CLS. 42 AND 50).

FIRST USE 1-2-2007; IN COMMERCE 1-2-2007.

3,313,506. LULU BRANDS LLC, WILMINGTON, DE. SN 78-501,359. PUB. 8-1-2006, FILED 10-18-2004.

WICK-STOP

THE MARK CONSISTS OF STANDARD CHARACTERS WITHOUT CLAIM TO ANY PARTICULAR FONT, STYLE, SIZE, OR COLOR.

FOR MULTI-LAYER FABRIC SYSTEM COMPRISING WICKING AND ABSORBENT FABRICS, AND WATER-PROOF-BREATHABLE MEMBRANES AND FABRICS FOR MANUFACTURE OF INNERWEAR, OUTERWEAR, FOOTWEAR, SHEETS, WRAPS, AND PADS (U.S. CLS. 42 AND 50).

FIRST USE 5-23-2005; IN COMMERCE 7-29-2006.

CLASS 24—(Continued).

3,313,643. CURECHIEF FOUNDATION, INC., CHESHIRE, CT. SN 78-610,699. PUB. 1-10-2006, FILED 4-18-2005.

PIECE OF HOPE

THE MARK CONSISTS OF STANDARD CHARACTERS WITHOUT CLAIM TO ANY PARTICULAR FONT, STYLE, SIZE, OR COLOR.

FOR STRIP OF FLEECE FABRIC USED TO INDICATE SUPPORT FOR CANCER PATIENTS (U.S. CLS. 42 AND 50).

FIRST USE 12-1-2006; IN COMMERCE 12-1-2006.

3,313,689. CHROMATIC CONCEPTS, MINNEAPOLIS, MN. SN 78-627,479. PUB. 2-7-2006, FILED 5-11-2005.



THE COLORS BLUE, WHITE, AND GOLD ARE CLAIMED AS A FEATURE OF THE MARK.

THE WORD TITAN AND LIGHTNING BOLT ARE GOLD AND OUTLINED IN BLUE. THE FIST GRASPING THE LIGHTNING BOLT IS WHITE OUTLINED IN BLUE.

FOR VINYL AND CLOTH TEXTILES FOR USE IN THE MANUFACTURE OF SIGNS, FLAGS AND BANNERS (U.S. CLS. 42 AND 50).

FIRST USE 1-1-2005; IN COMMERCE 1-1-2005.

3,314,215. JOHN RICH & SONS INVESTMENT HOLDING COMPANY, WILMINGTON, DE. SN 78-788,887. PUB. 9-5-2006, FILED 1-10-2006.

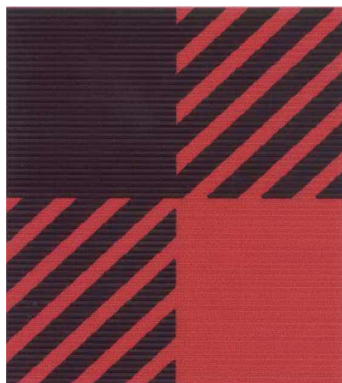

THE COLOR(S) RED AND BLACK IS/ARE CLAIMED AS

CLASS 24—(Continued).

A FEATURE OF THE MARK.

THE MARK CONSISTS OF A SQUARE MADE UP OF FOUR SMALLER SQUARES. THE UPPER LEFT SQUARE IS BLACK. THE LOWER RIGHT SQUARE IS RED. THE UPPER RIGHT AND LOWER LEFT SQUARES ARE DIAGONAL BLACK AND RED STRIPES.

FOR TOWEL SETS, SHOWER CURTAINS (U.S. CLS. 42 AND 50).

FIRST USE 1-31-2007; IN COMMERCE 1-31-2007.

3,314,573. DEWOOLFSON DOWN INTERNATIONAL, INC., BANNER ELK, NC. SN 78-879,852. PUB. 12-19-2006, FILED 5-9-2006.

LYCELLA

THE MARK CONSISTS OF STANDARD CHARACTERS WITHOUT CLAIM TO ANY PARTICULAR FONT, STYLE, SIZE, OR COLOR.

FOR COMFORTERS, COMFORTER COVERS, DUVETS, DUVET COVERS, PILLOW COVERS, PILLOW SHAMS AND BED LINENS (U.S. CLS. 42 AND 50).

FIRST USE 10-25-2006; IN COMMERCE 10-25-2006.

3,314,655. BYTRONICS, INC., HACKETTSTOWN, NJ. SN 78-901,116. PUB. 12-12-2006, FILED 6-5-2006.



NO CLAIM IS MADE TO THE EXCLUSIVE RIGHT TO USE "USA BANNERS", APART FROM THE MARK AS SHOWN.

THE COLOR(S) RED, WHITE, BLUE, BLACK IS/ARE CLAIMED AS A FEATURE OF THE MARK.

THE MARK CONSISTS OF ALL LETTERS BAUHAUS HV, UPPERCASE "U" RED, UPPERCASE "S" WHITE, UPPERCASE "A" BLUE AND WHITE STAR IN THE CENTER OF THE "A", A BLACK TILDAY SEPARATES THE UPPERCASE "USA" LETTERS FROM THE LOWERCASE LETTERS "BANNERS", "BANNERS" LETTERS ARE BAUHAUS HV FONT AND ARE BLACK.

FOR CLOTH BANNERS; CLOTH FLAGS; FABRIC FLAGS (U.S. CLS. 42 AND 50).

FIRST USE 6-13-2006; IN COMMERCE 6-13-2006.

CLASS 25—CLOTHING

CLASS 25—(Continued).

3,313,021. MALE POUCH, INC., NORTH PALM BEACH, FL.
SN 76-516,209. PUB. 12-2-2003, FILED 5-23-2003.

COOLFIT

THE MARK CONSISTS OF STYLIZED LETTERING.
FOR CLOTHING, NAMELY, SHORTS, GYM SHORTS,
BERMUDA SHORTS, BATHING SUITS, BOXER
SHORTS, UNDERWEAR, SHIRTS, SPORT SHIRTS, JER-
SEYS, PANTS, AND HATS (U.S. CLS. 22 AND 39).
FIRST USE 12-31-2005; IN COMMERCE 2-16-2007.

3,313,027. GROUP USA, INC., SECAUCUS, NJ. SN 76-523,761.
PUB. 2-3-2004, FILED 6-16-2003.

CAMILLE BRIDAL

NO CLAIM IS MADE TO THE EXCLUSIVE RIGHT TO
USE "BRIDAL", APART FROM THE MARK AS SHOWN.
FOR WOMEN'S CLOTHING, NAMELY, SKIRTS,
BLOUSES, DRESSES, SHOES; CLOTHING ACCES-
SORIES, NAMELY, SCARVES, GLOVES AND HATS
(U.S. CLS. 22 AND 39).
FIRST USE 10-1-2006; IN COMMERCE 10-1-2006.

3,313,062. SIR DRAKE LLC, NEW YORK, NY. SN 76-604,674.
PUB. 8-8-2006, FILED 7-28-2004.

Sir Drake

FOR CLOTHING, NAMELY, HATS, HEADWEAR,
SHIRTS, GOLF SHIRTS, POLO SHIRTS, SPORTS
SHIRTS, T-SHIRTS, SHORTS, SKIRTS, SLACKS, SOCKS,
SUSPENDERS, SWEATERS, TANK TOPS, UNDER-
CLOTHES, UNDERWEAR, WRISTBANDS (U.S. CLS. 22
AND 39).
FIRST USE 2-23-2006; IN COMMERCE 2-23-2006.

CLASS 25—(Continued).

3,313,076. FANI, LISA, STATEN ISLAND, NY. SN 76-612,263.
PUB. 9-6-2005, FILED 9-21-2004.

fani

FOR CLOTHING, NAMELY; JEANS, T-SHIRTS,
SHIRTS, BLOUSES, DRESSES, SKIRTS, BLAZERS, UN-
DERWEAR, SOCKS, POLO SHIRTS, PANTS, SLACKS,
BOXERS, TIES, BELTS, COATS, RAIN COATS, SWEA-
TERS, JACKETS, SWEAT PANTS, PANTS SUITS,
SHORTS SETS, HOODED SWEAT SHIRTS, FLEECE
JACKETS, SCARVES, HATS, CAPS, HEADBANDS AND
WRISTBANDS (U.S. CLS. 22 AND 39).
FIRST USE 5-21-2007; IN COMMERCE 5-21-2007.

3,313,096. BULL RUN BOOTS, LTD., HUNTINGTON BAY,
NY. SN 76-625,715. PUB. 9-27-2005, FILED 12-20-2004.

**Bull Run
Boots**

NO CLAIM IS MADE TO THE EXCLUSIVE RIGHT TO
USE "BOOTS", APART FROM THE MARK AS SHOWN.
FOR BOOTS (U.S. CLS. 22 AND 39).
FIRST USE 7-0-2005; IN COMMERCE 7-0-2005.

3,313,171. JAMMIN BEAR LLC, OLNEY, MD. SN 76-649,398.
PUB. 7-4-2006, FILED 10-28-2005.

FEET AT EASE

THE MARK CONSISTS OF STANDARD CHARACTERS
WITHOUT CLAIM TO ANY PARTICULAR FONT, STYLE,
SIZE, OR COLOR.
FOR SHOES AND SHOE SOLES (U.S. CLS. 22 AND 39).
FIRST USE 1-15-2004; IN COMMERCE 4-28-2004.

CLASS 25—(Continued).

3,313,177. GENEXUS INTERNATIONAL, INC., INGLEWOOD, CA. SN 76-651,354. PUB. 8-22-2006, FILED 12-5-2005.

GEE GEE SPORT

THE MARK CONSISTS OF STANDARD CHARACTERS WITHOUT CLAIM TO ANY PARTICULAR FONT, STYLE, SIZE, OR COLOR.

NO CLAIM IS MADE TO THE EXCLUSIVE RIGHT TO USE "SPORT", APART FROM THE MARK AS SHOWN.

FOR MEN'S WEARING APPAREL, NAMELY, T-SHIRTS, SWEATSHIRTS, TANK TOPS, WOVEN SHIRTS, SWEATERS, CARDIGANS, VESTS, JACKETS, PANTS, SWEAT PANTS, JEANS, SHORTS, HATS, CAPS, COATS, PAJAMAS, SHOES, SOCKS, AND UNDERWEAR; AND WOMEN'S WEARING APPAREL, NAMELY, T-SHIRTS, SWEATSHIRTS, TANK TOPS, WOVEN SHIRTS, SWEATERS, CARDIGANS, VESTS, JACKETS, PANTS, SWEAT PANTS, JEANS, SHORTS, HATS, CAPS, COATS, PAJAMAS, SHOES, SKIRTS, DRESSES, BLOUSES, SOCKS, LINGERIE, UNDERWEAR, PANTYHOSE, HOSIERY, TEDDIES, BRAS, PANTIES, SLIPS, FOUNDATION GARMENTS, GIRDLES, ROBES, AND LOUNGEWEAR (U.S. CLS. 22 AND 39).

FIRST USE 7-30-2006; IN COMMERCE 7-30-2006.

3,313,182. THE ALLEN COMPANY, INC., BROOMFIELD, CO. SN 76-652,002. PUB. 9-12-2006, FILED 12-19-2005.

GOLD STREAM

FOR FISHING WADERS (U.S. CLS. 22 AND 39).
FIRST USE 9-20-2006; IN COMMERCE 9-20-2006.

3,313,193. EDITH'S INC., RIEGELSVILLE, PA. SN 76-655,484. PUB. 10-10-2006, FILED 2-22-2006.

BEZI

THE MARK CONSISTS OF STANDARD CHARACTERS WITHOUT CLAIM TO ANY PARTICULAR FONT, STYLE, SIZE, OR COLOR.

FOR LINGERIE, NAMELY, BRAS, MODESTY SHIELDS AND UNDERWEAR (U.S. CLS. 22 AND 39).
FIRST USE 6-0-2006; IN COMMERCE 6-0-2006.

CLASS 25—(Continued).

3,313,209. SIMON INTERNATIONAL TRADING CORP., NEW YORK, NY. SN 76-660,484. PUB. 3-13-2007, FILED 5-22-2006.

BABY BOXER

THE MARK CONSISTS OF STANDARD CHARACTERS WITHOUT CLAIM TO ANY PARTICULAR FONT, STYLE, SIZE, OR COLOR.

NO CLAIM IS MADE TO THE EXCLUSIVE RIGHT TO USE "BABY", APART FROM THE MARK AS SHOWN.

FOR CLOTHING, NAMELY, BABY LAYETTES, BODY SUITS, DRESSES, SKIRT SETS, PANT SETS AND SHORT SETS (U.S. CLS. 22 AND 39).

FIRST USE 4-25-2006; IN COMMERCE 4-25-2006.

3,313,239. MOSS, KATE, LONDON SW3 3TD, ENGLAND. SN 76-978,638. PUB. 9-27-2005, FILED 3-20-2001.

KATE MOSS

THE NAME KATE MOSS IDENTIFIES A LIVING INDIVIDUAL WHOSE CONSENT IS OF RECORD.

FOR CLOTHING, NAMELY, BATHING SUITS, BEACH CLOTHES, CLOTHING MADE OF LEATHER, COATS, JACKETS, JUMPERS, PULLOVERS, PANTS, TROUSERS, SCARVES, SHIRTS, SKIRTS, SMOCKS, JERSEYS, SPORT JERSEYS, SWEATERS, T-SHIRTS, VESTS, SANDALS, BOOTS, FOOTWEAR (U.S. CLS. 22 AND 39).

FIRST USE 5-1-2007; IN COMMERCE 5-9-2007.

CLASS 25—(Continued).

3,313,242. S.W.B. APPAREL, INC., NEW YORK, NY. SN 77-001,957. PUB. 2-13-2007, FILED 9-19-2006.

SOUR N' CREAM

THE MARK CONSISTS OF STANDARD CHARACTERS WITHOUT CLAIM TO ANY PARTICULAR FONT, STYLE, SIZE, OR COLOR.

FOR CLOTHING FOR WOMEN AND CHILDREN, NAMELY, SKIRTS, DRESSES, LINGERIE, T-SHIRTS, SHIRTS, SWEATSHIRTS, SWEATERS, JACKETS, RAINCOATS, JEANS, SHORTS, PANTS, TRACK SUITS, JOGGING SUITS, SWEATPANTS, FLEECE SHIRTS, FLEECE JACKETS, FLEECE PULLOVERS, SLEEPWEAR, UNDERWEAR, CAPRI PANTS, SWIMWEAR, VESTS, POLO SHIRTS, DRESS SHIRTS, MESH SHIRTS, MESH SHORTS, JERSEYS, TANK TOPS, DOWN JACKETS, TRACK JACKETS, LEATHER JACKETS, SUEDE JACKETS, DENIM JACKETS, LEATHER PANTS, BELTS, GLOVES, CAPS, HATS, VISORS, CAPS, HEADBANDS, SCARVES, SHAWLS, SHOES AND SNEAKERS; CLOTHING FOR INFANTS AND BABIES, NAMELY BABY CLOTH BIBS, BODY SUITS, BONNETS, BOOTIES, HATS, CAPS, CARDIGANS, COATS, COORDINATING SETS COMPRISING TOPS AND BOTTOMS, COVERALLS, DRESSES, HATS, JACKETS, JEANS, JOGGING SUITS, JUMPERS, JUMPSUITS, LAYETTE SETS, MITTENS, OVERALLS, PANTS, RAINWEAR, ROMPERS, SHIRTS, SHORTS, SKIRTS, SLEEPWEAR, SNOW SUITS, SOCKS, SWEAT SHIRTS, SWEAT PANTS, SWEATERS, SWIMWEAR (U.S. CLS. 22 AND 39).

FIRST USE 2-13-2007; IN COMMERCE 2-13-2007.

3,313,283. BROAD ENTERPRISES NETWORKED, LLC, MIAMI, FL. SN 77-017,305. PUB. 5-15-2007, FILED 10-9-2006.

AUSTERE

THE MARK CONSISTS OF STANDARD CHARACTERS WITHOUT CLAIM TO ANY PARTICULAR FONT, STYLE, SIZE, OR COLOR.

FOR CAPS; HATS; PANTS; SHIRTS; SHORT-SLEEVED OR LONG-SLEEVED T-SHIRTS; SHORTS (U.S. CLS. 22 AND 39).

FIRST USE 11-3-2006; IN COMMERCE 11-3-2006.

CLASS 25—(Continued).

3,313,284. BROAD ENTERPRISES NETWORKED, LLC, MIAMI, FL. SN 77-017,306. PUB. 5-15-2007, FILED 10-9-2006.

SLEVS

THE MARK CONSISTS OF STANDARD CHARACTERS WITHOUT CLAIM TO ANY PARTICULAR FONT, STYLE, SIZE, OR COLOR.

FOR SHORT-SLEEVED OR LONG-SLEEVED T-SHIRTS (U.S. CLS. 22 AND 39).

FIRST USE 11-3-2006; IN COMMERCE 11-3-2006.

3,313,290. DIGLORIA, NATHANAEL, METHUEN, MA. SN 77-021,348. PUB. 5-22-2007, FILED 10-14-2006.

Nasty Dog

THE MARK CONSISTS OF STANDARD CHARACTERS WITHOUT CLAIM TO ANY PARTICULAR FONT, STYLE, SIZE, OR COLOR.

FOR HATS; SHIRTS; SHORT-SLEEVED OR LONG-SLEEVED T-SHIRTS; SWEAT SHIRTS (U.S. CLS. 22 AND 39).

FIRST USE 1-1-2007; IN COMMERCE 1-1-2007.

3,313,328. TRIUMPH HOSIERY CORP., HOLLYWOOD, FL. SN 77-045,871. PUB. 5-29-2007, FILED 11-16-2006.

EARTHABLES

THE MARK CONSISTS OF STANDARD CHARACTERS WITHOUT CLAIM TO ANY PARTICULAR FONT, STYLE, SIZE, OR COLOR.

FOR SOCKS, HOSIERY, FOOTWEAR, SLIPPERS, SHIRTS, HATS, GLOVES, SCARVES, PANTYHOSE, SLEEP MASKS, BABY BIBS NOT OF PAPER, SHOES, BEACHWEAR, TIES, BELTS, CAPS, VISORS (U.S. CLS. 22 AND 39).

FIRST USE 4-11-2007; IN COMMERCE 4-11-2007.

CLASS 25—(Continued).

3,313,351. DAL PIAZ, CHRISTOPHER C., NEW YORK, NY. SN 78-065,529. PUB. 6-6-2006, FILED 5-24-2001.

IN THE LOOP

FOR LADIES APPAREL, NAMELY, TOPS, SWEATERS, JACKETS, T-SHIRTS, DRESSES (U.S. CLS. 22 AND 39). FIRST USE 6-1-2003; IN COMMERCE 6-1-2003.

3,313,361. THE H.D. LEE COMPANY, INC., WILMINGTON, DE. SN 78-178,704. PUB. 11-11-2003, FILED 10-25-2002.



OWNER OF U.S. REG. NOS. 255,018, 2,421,222, AND OTHERS.

NO CLAIM IS MADE TO THE EXCLUSIVE RIGHT TO USE "DUNGAREES" AND "SINCE 1889", APART FROM THE MARK AS SHOWN.

FOR CLOTHING, NAMELY, BELTS (U.S. CLS. 22 AND 39).

FIRST USE 1-5-2006; IN COMMERCE 1-5-2006.

3,313,364. EDELSTEIN, MORRY, SYOSSET, NY. SN 78-187,475. PUB. 2-17-2004, FILED 11-21-2002.

PUNCTUATION

FOR BICYCLE CLOTHING, NAMELY, SHORTS, HEADWEAR, GLOVES, SHIRTS, JACKETS (U.S. CLS. 22 AND 39).

FIRST USE 1-0-2007; IN COMMERCE 1-0-2007.

3,313,371. DAL PIAZ, CHRISTOPHER, NEW YORK, NY. SN 78-224,634. PUB. 1-10-2006, FILED 3-12-2003.

ISLAND CLOTHING COMPANY

FOR LADIES WEARING APPAREL, NAMELY T-SHIRTS, BLOUSES, PANTS, SWEATSHIRTS, SWEATERS, AND DRESSES (U.S. CLS. 22 AND 39).

FIRST USE 4-1-2006; IN COMMERCE 4-1-2006.

CLASS 25—(Continued).

3,313,393. IMAGE M.A.D. LIMITED, DUBLINO, SUCCURSALE DI LUGANO, LUGANO, SWITZERLAND. SN 78-270,871. PUB. 9-7-2004, FILED 7-7-2003.



THE NAME(S), PORTRAIT(S), AND/OR SIGNATURE(S) SHOWN IN THE MARK IDENTIFIES ALBERTO SALVUCCI, WHOSE CONSENT(S) TO REGISTER IS SUBMITTED.

THE COLOR(S) RED AND GRAY IS/ARE CLAIMED AS A FEATURE OF THE MARK.

THE MARK CONSISTS OF THREE LARGE ADJACENT SQUARES, CONTAINING RESPECTIVELY, 'A' IN GRAY ON RED BACKGROUND, '.' IN RED ON GRAY BACKGROUND AND 'S' IN GRAY ON RED BACKGROUND. THE RED AND GRAY PORTIONS ARE SHOWN WITH A SHIFTING LIGHT EFFECT IN THE MANNER OF A METALLIC OR REFLECTIVE SURFACE OR THE LIKE. BENEATH THE THREE LARGE SQUARES ARE 15 SPACED-APART SMALLER SQUARES, EACH CONTAINING ONE OF THE LETTERS OF ALBERTO SALVUCCI. THE SMALL SQUARES SHOW THE LETTERS IN GRAY ON RED BACKGROUND, WITH A LIGHTER REFLECTIVE PORTION RUNNING HORIZONTALLY THROUGH THE SQUARES.

FOR FOOTWEAR (U.S. CLS. 22 AND 39).

FIRST USE 12-1-2006; IN COMMERCE 12-1-2006.

3,313,394. MCCASSY V, MALCOLM C., IRVINE, CA. SN 78-273,840. PUB. 2-24-2004, FILED 7-14-2003.

ETHIKA

THE ENGLISH TRANSLATION OF THE WORD ETHIKA IN THE MARK IS "ETHICS."

FOR CLOTHING, NAMELY, BOXER SHORTS, UNDERWEAR, AND HEADWEAR (U.S. CLS. 22 AND 39).

FIRST USE 3-1-2007; IN COMMERCE 3-1-2007.

CLASS 25—(Continued).

3,313,416. SUN BLOOM PARTICIPACOES S/C LTDA., JUNDIAI/SP, BRAZIL. SN 78-351,826. PUB. 12-14-2004, FILED 1-14-2004.

CLASS 25—(Continued).

3,313,437. WARREN, JAMES EDWARD CHARLES, CHESHIRE SK12 1QJ, UNITED KINGDOM. SN 78-386,770. PUB. 11-8-2005, FILED 3-18-2004.

PLANET GIRLS

THE MARK CONSISTS OF STANDARD CHARACTERS WITHOUT CLAIM TO ANY PARTICULAR FONT, STYLE, SIZE, OR COLOR.

FOR CLOTHING, FOOTWEAR, AND HEADGEAR, NAMELY KNIT PANTS, KNIT DRESSES, KNIT SKIRTS, KNIT BLOUSES, KNIT JACKETS, KNIT TOPS, KNIT SHIRTS, KNIT T-SHIRTS, KNIT SHORTS, KNIT BERMUDA SHORTS; BANDANNAS; HANDKERCHIEFS FOR THE HEAD; BERMUDA SHORTS; BIKINIS; CAPS; BOOTS, SHOES; PANTS, SHIRTS, T-SHIRTS, BRIEFS; BEACHWEAR; PANTS OF IMITATION LEATHER, JACKETS OF IMITATION LEATHER, SKIRTS OF IMITATION LEATHER; PANTS OF LEATHER, JACKETS OF LEATHER, SKIRTS OF LEATHER; TOPS FOR GYMNASTICS, T-SHIRTS FOR GYMNASTICS, PANTS FOR GYMNASTICS, SHORTS FOR GYMNASTICS, BERMUDA SHORTS FOR GYMNASTICS; UNDERWEAR; JACKETS; LINGERIE; STOCKINGS; PAJAMAS AND SWIM TRUNKS (U.S. CLS. 22 AND 39).

FIRST USE 9-10-1998; IN COMMERCE 12-12-2005.

Mie

THE MARK CONSISTS OF STANDARD CHARACTERS WITHOUT CLAIM TO ANY PARTICULAR FONT, STYLE, SIZE, OR COLOR.

OWNER OF UNITED KINGDOM REG. NO. 2359133, DATED 3-23-2004, EXPIRES 3-23-2014.

OWNER OF UNITED KINGDOM REG. NO. 2344381, DATED 9-26-2003, EXPIRES 9-26-2013.

FOR CLOTHING, NAMELY, SHIRTS, T-SHIRTS (U.S. CLS. 22 AND 39).

FIRST USE 11-7-2005; IN COMMERCE 11-7-2005.

3,313,431. CHOOSECO LLC, CHARLOTTE, VT. SN 78-378,036. PUB. 12-21-2004, FILED 3-3-2004.

3,313,443. PAQUETTE, MARTIN, LOS ANGELES, CA. SN 78-400,104. PUB. 9-6-2005, FILED 4-12-2004.

**CHOOSE YOUR OWN
ADVENTURE**

THE MARK CONSISTS OF STANDARD CHARACTERS WITHOUT CLAIM TO ANY PARTICULAR FONT, STYLE, SIZE, OR COLOR.

OWNER OF U.S. REG. NO. 2,807,473.

FOR CLOTHING AND APPAREL FOR MEN, WOMEN, YOUNG ADULTS, CHILDREN AND INFANTS, NAMELY BANDANNAS, BASEBALL CAPS, BATHROBES, BEACH COVER-UPS, BELTS, BODY SUITS, BOOTS, BOW TIES, COATS, EMBROIDERED CAPS, EMBROIDERED SHIRTS, FOOTWEAR, GLOVES, HATS, HEAD BANDS, HEADWEAR, JACKETS, JEANS, JERSEYS, JUMPSUITS, KNITTED HATS, LOUNGEWEAR, NECKWEAR, NIGHT SHIRTS, OVERCOATS, PAJAMAS, PANTS, PARKAS, RAIN COATS, ROBES, SANDALS, SCARVES, SHIRTS, SHOES, SHORTS, SLEEPWEAR, SLIPPERS, SNEAKERS, SOCKS, SPORT SHIRTS, SUITS, SUSPENDERS, SWEATERS, SWEATPANTS, SWEATSHIRTS, SWIMSUITS, TANK TOPS, TEE SHIRTS, TIES, TOP COATS, UNDERGARMENTS, UNDERPANTS, UNDERSHIRTS, UNDERWEAR, VESTS, WARM-UP SUITS; INFANTWEAR (U.S. CLS. 22 AND 39).

FIRST USE 1-18-2006; IN COMMERCE 1-18-2006.

knit resource

THE MARK CONSISTS OF STANDARD CHARACTERS WITHOUT CLAIM TO ANY PARTICULAR FONT, STYLE, SIZE, OR COLOR.

NO CLAIM IS MADE TO THE EXCLUSIVE RIGHT TO USE "KNIT", APART FROM THE MARK AS SHOWN.

FOR CLOTHING, NAMELY, KNIT CLOTHING IN THE NATURE OF T-SHIRTS, TANK TOPS, TOPS, DRESSES, SHIRTS, JACKETS, PANTS, SKIRTS, SHORTS, SLEEPWEAR, UNDERWEAR (U.S. CLS. 22 AND 39).

FIRST USE 1-0-2007; IN COMMERCE 1-0-2007.

CLASS 25—(Continued).

3,313,445. ROSS, PETER, CARLSBAD, CA. AND ROSS, NICHOLAS, CARLSBAD, CA. AND ROSS, DAVID, CARLSBAD, CA. SN 78-404,527. PUB. 10-11-2005, FILED 4-20-2004.



THE MARK CONSISTS OF THE WORD HOME STYLIZED WITH A HALF CIRCLE OF STARS ABOVE.

FOR APPAREL FOR MEN, WOMEN AND CHILDREN, NAMELY, SHOES, BOOTS, SNEAKERS, SOCKS, HATS, T-SHIRTS, SKIRTS, JERSEYS, DRESSES, PANTS, SHIRTS, BLOUSES, SWEATERS, SWEATSHIRTS, SWEAT SUITS, SLEEPWEAR, RAINCOATS, JACKETS, TANK TOPS, EXERCISE WEAR IN THE NATURE OF ATHLETIC UNIFORMS, ATHLETIC FOOTWEAR, SWEAT BANDS, HEAD BANDS, WRIST BANDS, NECK BANDS, BODY SHAPERS, GLOVES, HEAD WEAR, SWEAT JACKETS, GYM SHORTS, AND TRACKSUITS, UNDERWEAR, SWIMWEAR, CAPS, SHORTS, AND BABY BIBS NOT OF PAPER (U.S. CLS. 22 AND 39).

FIRST USE 1-1-1971; IN COMMERCE 1-1-1971.

CLASS 25—(Continued).

3,313,450. Y&Z WORLD DEVELOPMENT INC., NEW YORK, NY. SN 78-420,925. PUB. 4-19-2005, FILED 5-18-2004.

FRESH TWIST

THE MARK CONSISTS OF STANDARD CHARACTERS WITHOUT CLAIM TO ANY PARTICULAR FONT, STYLE, SIZE, OR COLOR.

FOR WOMEN'S CLOTHING, NAMELY, WOVEN AND KNIT SKIRTS, JACKETS, PANTS, SHIRTS, BLOUSES, TOPS, DRESSES, SUITS, SWEATERS, VESTS, COATS, SHORTS, EVENING GOWNS, LINGERIE, SWIMWEAR, SHOES AND ACCESSORIES, NAMELY, SCARVES, BELTS AND HATS (U.S. CLS. 22 AND 39).

FIRST USE 12-31-2004; IN COMMERCE 12-31-2004.

3,313,449. ZACCAI, JOSEPH AND ZACCAI, MARC, BROOKLYN, NY. SN 78-419,139. PUB. 9-6-2005, FILED 5-14-2004.

IGLOO

THE MARK CONSISTS OF STANDARD CHARACTERS WITHOUT CLAIM TO ANY PARTICULAR FONT, STYLE, SIZE, OR COLOR.

FOR WEARING APPAREL, NAMELY COATS, JACKETS (U.S. CLS. 22 AND 39).

FIRST USE 2-25-2007; IN COMMERCE 5-25-2007.

3,313,478. RODRIGO, JACKS A., ASUNCION, PARAGUAY. SN 78-469,974. PUB. 9-5-2006, FILED 8-19-2004.



THE COLORS ORANGE AND BLACK IS/ARE CLAIMED AS A FEATURE OF THE MARK.

THE COLOR ORANGE APPEARS IN THE CROSS SECTION OF THE DRAWING, WITH THE COLOR BLACK APPEARING IN THE SURROUNDING FEATHER DESIGNS. THE COLOR BLACK ALSO APPEARS IN THE TERM POMBERO.

FOR SHIRTS, PANTS AND SHOES (U.S. CLS. 22 AND 39).

FIRST USE 9-0-2006; IN COMMERCE 9-8-2006.

CLASS 25—(Continued).

3,313,484. JOHN RICH & SONS INVESTMENT HOLDING COMPANY, WILMINGTON, DE. SN 78-482,530. PUB. 9-6-2005, FILED 9-13-2004.

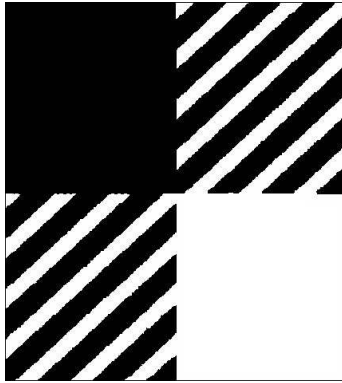

THE MARK CONSISTS OF A SQUARE MADE UP OF FOUR SMALLER SQUARES. THE UPPER LEFT-HAND SQUARE IS DARK. THE LOWER RIGHT-HAND SQUARE IS LIGHT. THE UPPER RIGHT-HAND AND LOWER LEFT-HAND SQUARES ARE DIAGONAL DARK AND LIGHT STRIPES.

FOR APPAREL, NAMELY, JACKETS, COATS, VESTS, ANORAKS, PANTS, SHIRTS, SWEATERS, SKIRTS, OVERALLS, JUMPERS AND ROBES (U.S. CLS. 22 AND 39).

FIRST USE 1-2-2007; IN COMMERCE 1-2-2007.

CLASS 25—(Continued).

3,313,486. JOHN RICH & SONS INVESTMENT HOLDING COMPANY, WILMINGTON, DE. SN 78-482,588. PUB. 9-6-2005, FILED 9-13-2004.



THE COLORS RED AND BLACK ARE CLAIMED AS A FEATURE OF THE MARK.

THE MARK CONSISTS OF A SQUARE MADE UP OF FOUR SMALLER SQUARES. THE UPPER LEFT SQUARE IS BLACK. THE LOWER RIGHT SQUARE IS RED. THE UPPER RIGHT AND LOWER LEFT SQUARES ARE DIAGONAL BLACK AND RED STRIPES.

FOR FOOTWEAR; SLIPPERS; AND MOCCASINS (U.S. CLS. 22 AND 39).

FIRST USE 1-2-2007; IN COMMERCE 1-2-2007.

3,313,485. JOHN RICH & SONS INVESTMENT HOLDING COMPANY, WILMINGTON, DE. SN 78-482,570. PUB. 9-6-2005, FILED 9-13-2004.

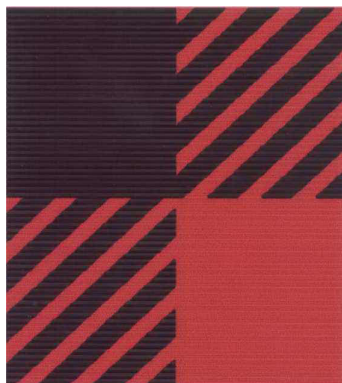

THE COLORS RED AND BLACK ARE CLAIMED AS A FEATURE OF THE MARK.

THE MARK CONSISTS OF A SQUARE MADE UP OF FOUR SMALLER SQUARES. THE UPPER LEFT SQUARE IS BLACK. THE LOWER RIGHT SQUARE IS RED. THE UPPER RIGHT AND LOWER LEFT SQUARES ARE DIAGONAL BLACK AND RED STRIPES.

FOR APPAREL, NAMELY, JACKETS, COATS, VESTS, ANORAKS, PANTS, SHIRTS, SWEATERS, SKIRTS, OVERALLS, JUMPERS AND ROBES (U.S. CLS. 22 AND 39).

FIRST USE 1-2-2007; IN COMMERCE 1-2-2007.

3,313,487. JOHN RICH & SONS INVESTMENT HOLDING COMPANY, WILMINGTON, DE. SN 78-482,597. PUB. 9-6-2005, FILED 9-13-2004.



THE COLORS RED AND BLACK ARE CLAIMED AS A FEATURE OF THE MARK.

THE MARK CONSISTS OF A SQUARE MADE UP OF FOUR SMALLER SQUARES. THE UPPER LEFT SQUARE IS BLACK. THE LOWER RIGHT SQUARE IS RED. THE UPPER RIGHT AND LOWER LEFT SQUARES ARE DIAGONAL BLACK AND RED STRIPES.

FOR HEADWEAR; HATS; HEADBANDS; VISORS (U.S. CLS. 22 AND 39).

FIRST USE 1-2-2007; IN COMMERCE 1-2-2007.

CLASS 25—(Continued).

3,313,488. JOHN RICH & SONS INVESTMENT HOLDING COMPANY, WILMINGTON, DE. SN 78-482,605. PUB. 9-6-2005, FILED 9-13-2004.



THE COLORS RED AND BLACK ARE CLAIMED AS A FEATURE OF THE MARK.

THE MARK CONSISTS OF A SQUARE MADE UP OF FOUR SMALLER SQUARES. THE UPPER LEFT SQUARE IS BLACK. THE LOWER RIGHT SQUARE IS RED. THE UPPER RIGHT AND LOWER LEFT SQUARES ARE DIAGONAL BLACK AND RED STRIPES.

FOR GLOVES (U.S. CLS. 22 AND 39).

FIRST USE 1-2-2007; IN COMMERCE 1-2-2007.

CLASS 25—(Continued).

3,313,585. DIAMOND TRIPLE C RANCH, YARDLEY, PA. SN 78-580,108. PUB. 8-15-2006, FILED 3-4-2005.



NO CLAIM IS MADE TO THE EXCLUSIVE RIGHT TO USE "SVETRE" OR "SWEATERS", APART FROM THE MARK AS SHOWN.

THE FOREIGN WORDING IN THE MARK TRANSLATES INTO ENGLISH AS SWEATERS FROM THE CASTLE.

FOR CLOTHING, NAMELY SWEATERS AND SCARVES WHOLLY OR SUBSTANTIALLY MADE OF ALPACA FIBERS (U.S. CLS. 22 AND 39).

FIRST USE 12-1-2006; IN COMMERCE 12-1-2006.

3,313,521. TURNBULL, LISA A., MAPLE GROVE, MN. AND TURNBULL, RICHARD A., MAPLE GROVE, MN. SN 78-518,800. PUB. 9-27-2005, FILED 11-17-2004.

GOSP

THE MARK CONSISTS OF STANDARD CHARACTERS WITHOUT CLAIM TO ANY PARTICULAR FONT, STYLE, SIZE, OR COLOR.

FOR CHILDREN'S AND LADIES SLEEPWEAR, SWEATSHIRTS, T-SHIRTS, NIGHT SHIRTS, NIGHT CAPS, PAJAMAS INCLUDING BOXER SHORTS WITH MATCHING SHORT AND LONG SLEEVE TOPS, AND LONG PAJAMA PANTS WITH MATCHING SHORT AND LONG SLEEVE TOPS, AND SOCKS (U.S. CLS. 22 AND 39).

FIRST USE 8-22-2006; IN COMMERCE 11-2-2006.

3,313,588. LEGACY HOCKEY, LLC, PHOENIX, AZ. SN 78-581,817. PUB. 10-18-2005, FILED 3-7-2005.

**PAX
RoadRunners**

FOR CLOTHING, NAMELY, BEACH COVER-UPS, BELTS, BODY SUITS, BOXER SHORTS, CAPS, CLOTH BIBS, COATS, DRESSES, FOOTWEAR, EAR MUFFS, GLOVES, HATS, HEADBANDS, HOSIERY, HOUSECOATS, JACKETS, JERSEYS, MITTENS, NIGHTSHIRTS, PAJAMAS, PANTS, RAIN COATS, RAIN WEAR, ROBES, SCARVES, SHORTS, SKIRTS, SOCKS, SUITS, SUN VISORS, SUSPENDERS, SWEATERS, SWEATPANTS, SWEATSHIRTS, SWIMSUITS, SWIM TRUNKS, T-SHIRTS, POLO SHIRTS, TIES, UNDERWEAR, VESTS, WARM-UP SUITS AND WRISTBANDS (U.S. CLS. 22 AND 39).

FIRST USE 2-1-2005; IN COMMERCE 2-1-2005.

CLASS 25—(Continued).

3,313,593. IM TRADING, LTD., NEW YORK, NY. SN 78-584,182. PUB. 6-20-2006, FILED 3-10-2005.

IAN MICHAEL

THE MARK CONSISTS OF STANDARD CHARACTERS WITHOUT CLAIM TO ANY PARTICULAR FONT, STYLE, SIZE, OR COLOR.

THE NAME(S), PORTRAIT(S), AND/OR SIGNATURE(S) SHOWN IN THE MARK DOES NOT IDENTIFY A PARTICULAR LIVING INDIVIDUAL.

FOR MEN'S CLOTHING, NAMELY, COATS, JACKETS, RAINCOATS, RAIN JACKETS, STADIUM COATS, CAR COATS, DOWN JACKETS, FLEECE JACKETS, QUILTED JACKETS, VESTS, ALL WEATHER JACKETS AND COATS, 3 IN 1 JACKETS AND VESTS, SPORT JACKETS, BLAZERS; WOMEN'S CLOTHING, NAMELY, HATS, SCARVES (U.S. CLS. 22 AND 39).

FIRST USE 9-30-2005; IN COMMERCE 9-30-2005.

3,313,609. LES FILÓS PARTICIPAÇÕES E COMERCIO LTDA, SAO PAULO-SP, BRAZIL. SN 78-592,912. PUB. 1-31-2006, FILED 3-22-2005.

LES FILOS

THE MARK CONSISTS OF STANDARD CHARACTERS WITHOUT CLAIM TO ANY PARTICULAR FONT, STYLE, SIZE, OR COLOR.

FOR CLOTHING, NAMELY, COLLARS, SHORTS, BIKINIS, BATHING SUITS, BLOUSES, BODICES, PANTS, SHIRTS, T-SHIRTS, SLEEVELESS T-SHIRTS, COATS, HATS, BELTS, VESTS, STOLEES, JACKETS, SCARVES, STOCKINGS, SOCKS, PARKAS, SKIRTS, UNDERWEAR, DRESSES, NECKERCHIEFS, FOOTWEAR, AND HEADWEAR (U.S. CLS. 22 AND 39).

FIRST USE 12-2-1998; IN COMMERCE 2-18-2007.

CLASS 25—(Continued).

3,313,632. HBI BRANDED APPAREL ENTERPRISES, LLC, WINSTON-SALEM, NC. SN 78-607,807. PUB. 1-10-2006, FILED 4-13-2005.

INNER DELIGHT

THE MARK CONSISTS OF STANDARD CHARACTERS WITHOUT CLAIM TO ANY PARTICULAR FONT, STYLE, SIZE, OR COLOR.

OWNER OF U.S. REG. NOS. 2,518,339 AND 2,736,826. FOR BRAS AND PANTIES (U.S. CLS. 22 AND 39). FIRST USE 2-15-2006; IN COMMERCE 2-15-2006.

3,313,651. RICCO TIZIO WORLDWIDE, LLC, POMPANO BEACH, FL. SN 78-614,769. PUB. 8-1-2006, FILED 4-22-2005.

RICCO TIZIO

THE MARK CONSISTS OF STANDARD CHARACTERS WITHOUT CLAIM TO ANY PARTICULAR FONT, STYLE, SIZE, OR COLOR.

THE NAME(S), PORTRAIT(S), AND/OR SIGNATURE(S) SHOWN IN THE MARK DOES NOT IDENTIFY A PARTICULAR LIVING INDIVIDUAL.

THE FOREIGN WORDING IN THE MARK TRANSLATES INTO ENGLISH AS RICH FELLOW.

FOR MEN'S, WOMEN'S AND CHILDREN'S CLOTHING, NAMELY, JEANS, PANTS, SHIRTS, T-SHIRTS, COATS, JACKETS (U.S. CLS. 22 AND 39).

FIRST USE 7-29-2005; IN COMMERCE 7-29-2005.

3,313,653. MARIN, CHRISTIAN J., SAN JOSE, CA. AND MARIN, ROBERT J., SAN JOSE, CA. SN 78-615,309. PUB. 8-22-2006, FILED 4-22-2005.

MoneyMakers

THE MARK CONSISTS OF STANDARD CHARACTERS WITHOUT CLAIM TO ANY PARTICULAR FONT, STYLE, SIZE, OR COLOR.

FOR CLOTHING, NAMELY, T-SHIRTS, POLO SHIRTS, LONG-SLEEVE SHIRTS AND DRESS SHIRTS (U.S. CLS. 22 AND 39).

FIRST USE 6-0-2005; IN COMMERCE 6-0-2005.

CLASS 25—(Continued).

3,313,672. L.A. GEAR, INC., LOS ANGELES, CA. SN 78-622,156. PUB. 8-8-2006, FILED 5-4-2005.

DISCOVER THEM

THE MARK CONSISTS OF STANDARD CHARACTERS WITHOUT CLAIM TO ANY PARTICULAR FONT, STYLE, SIZE, OR COLOR.
FOR FOOTWEAR (U.S. CLS. 22 AND 39).
FIRST USE 5-31-2005; IN COMMERCE 5-31-2005.

3,313,686. STYLE INTERNATIONAL SOURCE, LLC, TORRANCE, CA. SN 78-626,717. PUB. 8-22-2006, FILED 5-10-2005.

California Born

THE MARK CONSISTS OF STANDARD CHARACTERS WITHOUT CLAIM TO ANY PARTICULAR FONT, STYLE, SIZE, OR COLOR.
NO CLAIM IS MADE TO THE EXCLUSIVE RIGHT TO USE "CALIFORNIA", APART FROM THE MARK AS SHOWN.
FOR CLOTHING, NAMELY, SHIRTS, PANTS, SWEAT SUITS, JEANS, AND SHORTS (U.S. CLS. 22 AND 39).
FIRST USE 4-1-2004; IN COMMERCE 4-1-2004.

3,313,712. DR.'S OWN, INC., CARLSBAD, CA. SN 78-639,375. PUB. 2-14-2006, FILED 5-27-2005.

Good Feet

OWNER OF U.S. REG. NOS. 2,766,190, 2,852,411, AND OTHERS.
NO CLAIM IS MADE TO THE EXCLUSIVE RIGHT TO USE FEET, APART FROM THE MARK AS SHOWN.
FOR T-SHIRTS, SHIRTS, SWEATSHIRTS, SWEAT PANTS, BELTS, SOCKS, HOSIERY, FOOTWEAR, SLIPPERS, HATS, CAPS, VISORS, INSOLES, HEEL CUSHIONS, HEEL LINERS, AND HEEL RESTS (U.S. CLS. 22 AND 39).
FIRST USE 12-20-2001; IN COMMERCE 12-20-2001.

CLASS 25—(Continued).

3,313,731. REBEL YELL, LLC, LOS ANGELES, CA. SN 78-650,198. PUB. 3-14-2006, FILED 6-14-2005.



THE MARK CONSISTS OF THE FILLED-IN STYLIZED LETTER "R" AND THE STYLIZED LETTER "Y" COMPOSED OF A CIRCLE AND DIAGONAL LINE MADE UP OF SMALLER LINES.

FOR CLOTHING, NAMELY MEN'S, WOMEN'S, MIS-SY'S, JUNIORS', CHILDREN'S AND INFANTS' JEANS, PANTS, TROUSERS, CAPRIS, LEGGINGS, SHORTS, SKORTS, OVERALLS, SHORTALLS, SKIRTS, DRESSES, TOPS, T-SHIRTS, TANK TOPS, SWEATSHIRTS, SWEAT PANTS, BLOUSES, SHIRTS, JACKETS, COATS, SWEATERS, VESTS, CARDIGANS, SCARVES, SOCKS, UNDERWEAR, LINGERIE, LOUNGEWEAR, THERMAL WEAR, NAMELY SOCKS AND UNDERWEAR, BANDANAS, WRISTBANDS, NECKTIES, FOOTWEAR, HATS, CAPS, HEADWEAR, BOOTS, SANDALS AND BELTS (U.S. CLS. 22 AND 39).

FIRST USE 10-20-2005; IN COMMERCE 10-25-2005.

3,313,741. BUCKLEY, GARY W., CORONA DEL MAR, CA. SN 78-651,700. PUB. 2-21-2006, FILED 6-15-2005.

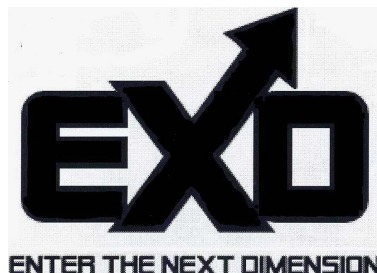

THE MARK CONSISTS OF THE WORD "EXO" IN THE "ALIEN ENCOUNTER" FONT WITH THE "X" SLIGHTLY LARGER AND AN ARROWHEAD ON THE TOP RIGHT PART.

FOR SHIRTS, PANTS, SHORTS AND HATS (U.S. CLS. 22 AND 39).
FIRST USE 11-10-2006; IN COMMERCE 11-10-2006.

CLASS 25—(Continued).

3,313,754. RECKITT BENCKISER INC., PARSIPPANY, NJ. SN 78-656,036. PUB. 4-25-2006, FILED 6-22-2005.



OWNER OF U.S. REG. NOS. 545,030, 1,738,543, AND OTHERS.

FOR OUTERWEAR, NAMELY, WARM-UP SUITS, FLEECE PULL-OVERS, SWEATSHIRTS, JERSEY SHIRTS, POLO SHIRTS, LONG SLEEVED T-SHIRTS, SHORT SLEEVED T-SHIRTS, SCREEN PRINTED T-SHIRTS, EMBROIDERED T-SHIRTS, FULL-ZIP SHIRTS, PULLOVER SHIRTS, WOVEN SHIRTS, TANK TOPS, SHORTS, PANTS, JEANS, FOOTWEAR, NAMELY, HOSIERY, SOCKS, SHOES, FLIP-FLOPS, SLIPPERS; UNDERWEAR, LINGERIE, SLEEPWEAR, PAJAMAS, SLEEP BOTTOMS AND COORDINATED SLEEP TOPS, LOUNGEWEAR, ROBES, BOXER SHORTS, ACCESSORIES, NAMELY, BELTS, GLOVES, NECKTIES, SCARVES; SWIMWEAR; SPORTS AND FITNESS CLOTHING, NAMELY, SHORTS AND T-SHIRTS (U.S. CLS. 22 AND 39).

FIRST USE 12-31-2005; IN COMMERCE 12-31-2005.

3,313,778. ASHJIAN, NAZAR, H., ENCINO, CA. SN 78-666,821. PUB. 4-4-2006, FILED 7-8-2005.

OLD AIR FORCE

THE MARK CONSISTS OF STANDARD CHARACTERS WITHOUT CLAIM TO ANY PARTICULAR FONT, STYLE, SIZE, OR COLOR.

FOR CLOTHING, NAMELY, T-SHIRTS, SHIRTS, JACKETS, PANTS, SHORTS, HATS, SOCKS AND UNDERWEAR (U.S. CLS. 22 AND 39).

FIRST USE 2-6-2007; IN COMMERCE 2-6-2007.

3,313,783. HBI BRANDED APPAREL ENTERPRISES, LLC, WINSTON-SALEM, NC. SN 78-669,446. PUB. 3-21-2006, FILED 7-13-2005.

BARE L'EGGS. BEAUTIFUL CURVES.**CLASS 25—(Continued).**

THE MARK CONSISTS OF STANDARD CHARACTERS WITHOUT CLAIM TO ANY PARTICULAR FONT, STYLE, SIZE, OR COLOR.

OWNER OF U.S. REG. NO. 2,420,003. FOR FOUNDATION GARMENTS (U.S. CLS. 22 AND 39).

FIRST USE 10-2-2002; IN COMMERCE 10-2-2002.

3,313,791. RUUD, WILLIAM, OAKS, PA. SN 78-673,503. PUB. 4-25-2006, FILED 7-19-2005.

SWEATHOG

THE MARK CONSISTS OF STANDARD CHARACTERS WITHOUT CLAIM TO ANY PARTICULAR FONT, STYLE, SIZE, OR COLOR.

FOR EXERCISE GLOVES (U.S. CLS. 22 AND 39).

FIRST USE 11-23-2005; IN COMMERCE 11-23-2005.

3,313,793. R. E. TRICKER HOLDINGS LIMITED, NORTH-AMPTON, UNITED KINGDOM. SN 78-674,136. PUB. 10-24-2006, FILED 7-20-2005.

TRICKER'S

THE MARK CONSISTS OF STANDARD CHARACTERS WITHOUT CLAIM TO ANY PARTICULAR FONT, STYLE, SIZE, OR COLOR.

FOR FOOTWEAR (U.S. CLS. 22 AND 39).

FIRST USE 0-0-1829; IN COMMERCE 0-0-1975.

3,313,803. MARTINEZ, CASEY, NORCO, CA. SN 78-678,572. PUB. 7-18-2006, FILED 7-26-2005.

MAXO

THE MARK CONSISTS OF STANDARD CHARACTERS WITHOUT CLAIM TO ANY PARTICULAR FONT, STYLE, SIZE, OR COLOR.

FOR CLOTHING, NAMELY, HATS, SHIRTS, SHORTS, PANTS, SWEATS, BEANIES, SWEATERS, HEADBANDS, AND UNDERWEAR (U.S. CLS. 22 AND 39).

FIRST USE 6-1-2006; IN COMMERCE 6-1-2006.

CLASS 25—(Continued).

3,313,809. HBI BRANDED APPAREL ENTERPRISES, LLC, WINSTON-SALEM, NC. SN 78-681,286. PUB. 4-11-2006, FILED 7-29-2005.

LUXURIOUS BY BARELY THERE

THE MARK CONSISTS OF STANDARD CHARACTERS WITHOUT CLAIM TO ANY PARTICULAR FONT, STYLE, SIZE, OR COLOR.

OWNER OF U.S. REG. NOS. 579,747 AND 1,973,373. FOR PANTIES (U.S. CLS. 22 AND 39). FIRST USE 5-31-2006; IN COMMERCE 5-31-2006.

CLASS 25—(Continued).

3,313,853. MUSSER, MICHAEL W., SAN RAFAEL, CA. SN 78-701,717. PUB. 9-12-2006, FILED 8-26-2005.

ROMEO RABBIT

THE MARK CONSISTS OF STANDARD CHARACTERS WITHOUT CLAIM TO ANY PARTICULAR FONT, STYLE, SIZE, OR COLOR.

FOR CLOTHING FOR MEN, WOMEN, AND CHILDREN, NAMELY, CAPS, HATS, SHIRTS, T-SHIRTS, JERSEYS, TANK TOPS, VISORS (U.S. CLS. 22 AND 39). FIRST USE 6-1-1996; IN COMMERCE 11-1-2005.

3,313,813. SANDS, ROLAND W., LONG BEACH, CA. SN 78-683,106. PUB. 10-31-2006, FILED 8-1-2005.

RSD

THE MARK CONSISTS OF STANDARD CHARACTERS WITHOUT CLAIM TO ANY PARTICULAR FONT, STYLE, SIZE, OR COLOR.

FOR CLOTHING, NAMELY, T-SHIRTS, SWEAT SHIRTS AND PANTS, JACKETS, GLOVES, CAPS, HATS, BELTS, LEATHER BOOTS AND SHOES (U.S. CLS. 22 AND 39).

FIRST USE 10-0-2005; IN COMMERCE 10-0-2005.

3,313,863. IVY BROWN JEANS, LLC, STAMFORD, CT. SN 78-706,270. PUB. 9-5-2006, FILED 9-2-2005.

IVY BROWN

THE MARK CONSISTS OF STANDARD CHARACTERS WITHOUT CLAIM TO ANY PARTICULAR FONT, STYLE, SIZE, OR COLOR.

FOR CLOTHING, NAMELY, JEANS AND SPORTSWEAR, NAMELY, KNIT AND DENIM SHIRTS AND PANTS FOR MEN, WOMEN, AND CHILDREN (U.S. CLS. 22 AND 39).

FIRST USE 12-0-2006; IN COMMERCE 12-0-2006.

3,313,825. ALFRED ANGELO, INC., FORT WASHINGTON, PA. SN 78-689,951. PUB. 4-25-2006, FILED 8-10-2005.

ANGELO ANGELS

THE MARK CONSISTS OF STANDARD CHARACTERS WITHOUT CLAIM TO ANY PARTICULAR FONT, STYLE, SIZE, OR COLOR.

OWNER OF U.S. REG. NOS. 1,365,681, 2,558,174, AND OTHERS.

FOR GIRLS DRESSES, NAMELY, FLOWER GIRL DRESSES AND SPECIAL OCCASION DRESSES, NOT RELATING TO SPORTS OR SPORT TEAMS (U.S. CLS. 22 AND 39).

FIRST USE 0-0-2006; IN COMMERCE 0-0-2006.

3,313,874. ROBERT TALBOTT, INC., CARMEL VALLEY, CA. SN 78-709,865. PUB. 7-18-2006, FILED 9-9-2005.

KALI HART

THE MARK CONSISTS OF STANDARD CHARACTERS WITHOUT CLAIM TO ANY PARTICULAR FONT, STYLE, SIZE, OR COLOR.

OWNER OF U.S. REG. NO. 2,761,502.

THE NAME SHOWN IN THE MARK IDENTIFIES KALI HART, WHOSE CONSENT(S) TO REGISTER IS OF RECORD.

FOR CLOTHING, NAMELY, WOMEN'S SHIRTS (U.S. CLS. 22 AND 39).

FIRST USE 3-1-2007; IN COMMERCE 3-1-2007.

CLASS 25—(Continued).

3,313,899. CHARLES KOMAR & SONS, INC., NEW YORK, NY. SN 78-719,570. PUB. 2-20-2007, FILED 9-23-2005.

DONNA NADEAU

THE MARK CONSISTS OF STANDARD CHARACTERS WITHOUT CLAIM TO ANY PARTICULAR FONT, STYLE, SIZE, OR COLOR.

THE NAME(S), PORTRAIT(S), AND/OR SIGNATURE(S) SHOWN IN THE MARK IDENTIFIES DONNA NADEAU, WHOSE CONSENT(S) TO REGISTER IS SUBMITTED.

FOR BOTTOMS; DUSTERS; FOOTWEAR; LINGERIE; LOUNGEWEAR; PAJAMAS; PANTS; ROBES; SLEEPWEAR; SLIPPERS; TOPS; UNDERGARMENTS (U.S. CLS. 22 AND 39).

FIRST USE 7-0-2006; IN COMMERCE 7-0-2006.

3,313,901. ALLEGHENY VALLEY SCHOOL, CORAOPOLIS, PA. SN 78-720,461. PUB. 8-29-2006, FILED 9-26-2005.

MYRON COPE'S OFFICIAL THE TERRIBLE TOWEL

THE MARK CONSISTS OF STANDARD CHARACTERS WITHOUT CLAIM TO ANY PARTICULAR FONT, STYLE, SIZE, OR COLOR.

OWNER OF U.S. REG. NOS. 2,123,428, 2,128,165, AND 2,386,205.

NO CLAIM IS MADE TO THE EXCLUSIVE RIGHT TO USE "OFFICIAL", APART FROM THE MARK AS SHOWN.

THE NAME "MYRON COPE" IDENTIFIES A LIVING INDIVIDUAL WHOSE CONSENT IS OF RECORD.

FOR GLOVES (U.S. CLS. 22 AND 39).

FIRST USE 6-5-2006; IN COMMERCE 6-5-2006.

3,313,948. TOZIER, LTD., HONOLULU, HI. SN 78-741,344. PUB. 8-22-2006, FILED 10-27-2005.



NO CLAIM IS MADE TO THE EXCLUSIVE RIGHT TO

CLASS 25—(Continued).

USE "HI", APART FROM THE MARK AS SHOWN.

THE MARK CONSISTS OF IN PART, THE TERM HI WITHIN THE FANCIFUL DESIGN OF A HEART.

FOR BRIEFS; CLOTHING, NAMELY, WRAP-AROUNDS; GOLF SHIRTS; HATS; HEADGEAR, NAMELY, HATS AND HEADBANDS; JACKETS; KNIT SHIRTS; LADIES' UNDERWEAR; LINGERIE; POLO SHIRTS; SHIRTS; SHOES; SLEEP SHIRTS; SLIPPERS; SOCKS; SWEAT-ABSORBENT STOCKINGS; SWEAT BANDS; SWEAT SHIRTS; SWEAT SHORTS; SWEAT SUITS; T-SHIRTS; THONGS; UNDERWEAR; WRAPS; WRISTBANDS (U.S. CLS. 22 AND 39).

FIRST USE 5-19-2006; IN COMMERCE 5-19-2006.

3,313,976. COOL-TEKWARE, INC., LOS ANGELES, CA. SN 78-748,870. PUB. 2-13-2007, FILED 11-7-2005.

PERSONAL RADIATOR

THE MARK CONSISTS OF STANDARD CHARACTERS WITHOUT CLAIM TO ANY PARTICULAR FONT, STYLE, SIZE, OR COLOR.

FOR EVAPORATIVE AND COOLING GARMENT WORN ABOUT THE NECK FOR COOLING THE BODY DURING PHYSICAL ACTIVITY (U.S. CLS. 22 AND 39).

FIRST USE 8-1-2006; IN COMMERCE 8-1-2006.

3,313,998. THE ELECTRIC GRAPEVINE INCORPORATED, COSTA MESA, CA. SN 78-751,179. PUB. 7-18-2006, FILED 11-10-2005.

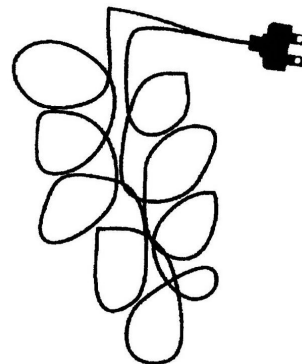

THE MARK CONSISTS OF A FANCIFUL SKETCH OF A GRAPE BUNCH WITH AN ELECTRICAL PLUG ATTACHED.

FOR DRESSES; SHIRTS; SHORTS; SWEAT SHIRTS; SWIMSUITS; T-SHIRTS (U.S. CLS. 22 AND 39).

FIRST USE 2-17-2006; IN COMMERCE 4-17-2006.

CLASS 25—(Continued).

3,313,999. THE ELECTRIC GRAPEVINE INCORPORATED, COSTA MESA, CA. SN 78-751,198. PUB. 7-18-2006, FILED 11-10-2005.

ANDOLAND

THE MARK CONSISTS OF STANDARD CHARACTERS WITHOUT CLAIM TO ANY PARTICULAR FONT, STYLE, SIZE, OR COLOR.

FOR DRESSES; SHIRTS; SHORTS; SWEAT SHIRTS; SWIMSUITS; T-SHIRTS (U.S. CLS. 22 AND 39).
FIRST USE 2-17-2006; IN COMMERCE 4-17-2006.

CLASS 25—(Continued).

3,314,073. 91620542 QUEBEC, INC., MONTREAL, QUEBEC, CANADA. SN 78-765,379. PUB. 8-22-2006, FILED 12-2-2005.

IMPERIAL CREST

THE MARK CONSISTS OF STANDARD CHARACTERS WITHOUT CLAIM TO ANY PARTICULAR FONT, STYLE, SIZE, OR COLOR.

FOR CLOTHING, NAMELY, SUITS (U.S. CLS. 22 AND 39).
FIRST USE 4-0-2006; IN COMMERCE 4-0-2006.

3,314,001. SPIRITED SISTERS, INC., BRIDGEWATER, MA. SN 78-751,389. PUB. 10-17-2006, FILED 11-10-2005.

ORIGINAL HEALING THREADS

THE MARK CONSISTS OF STANDARD CHARACTERS WITHOUT CLAIM TO ANY PARTICULAR FONT, STYLE, SIZE, OR COLOR.

NO CLAIM IS MADE TO THE EXCLUSIVE RIGHT TO USE "ORIGINAL" AND "THREADS", APART FROM THE MARK AS SHOWN.

FOR CLOTHING, NAMELY, TOPS, JACKETS, ROBES, DRESSES, GOWNS, DRESSING GOWNS, BLOUSES, SHIRTS, SMOCKS, TUNICS, CHEMISES, COATS, OVER-SHIRTS, PANTS, TROUSERS, SLACKS, CHINOS, KHAKIS, AND BOTTOMS (U.S. CLS. 22 AND 39).
FIRST USE 1-1-2006; IN COMMERCE 1-1-2006.

3,314,100. THORNBURG, CHRIS, SAN CLEMENTE, CA. AND DURKEE, JAY, SAN CLEMENTE, CA. SN 78-768,944. PUB. 8-22-2006, FILED 12-7-2005.

OLD HONOLULU

THE MARK CONSISTS OF STANDARD CHARACTERS WITHOUT CLAIM TO ANY PARTICULAR FONT, STYLE, SIZE, OR COLOR.

NO CLAIM IS MADE TO THE EXCLUSIVE RIGHT TO USE "HONOLULU", APART FROM THE MARK AS SHOWN.

FOR SHIRTS; T-SHIRTS (U.S. CLS. 22 AND 39).
FIRST USE 7-5-2006; IN COMMERCE 7-5-2006.

3,314,072. 91620542 QUEBEC, INC., MONTREAL, QUEBEC, CANADA. SN 78-765,375. PUB. 8-22-2006, FILED 12-2-2005.

PALM HILL

THE MARK CONSISTS OF STANDARD CHARACTERS WITHOUT CLAIM TO ANY PARTICULAR FONT, STYLE, SIZE, OR COLOR.

FOR CLOTHING, NAMELY, SUITS (U.S. CLS. 22 AND 39).
FIRST USE 4-0-2006; IN COMMERCE 4-0-2006.

3,314,107. CARACATERRA, SUSAN, ATTLEBORO, MD. SN 78-770,588. PUB. 8-22-2006, FILED 12-9-2005.

SCHNOODLISCIOUS

THE MARK CONSISTS OF STANDARD CHARACTERS WITHOUT CLAIM TO ANY PARTICULAR FONT, STYLE, SIZE, OR COLOR.

FOR CLOTHING, NAMELY, T-SHIRTS, HATS, SWEATSHIRTS, SWEATPANTS, AND SHIRTS (U.S. CLS. 22 AND 39).
FIRST USE 5-13-2007; IN COMMERCE 5-13-2007.

CLASS 25—(Continued).

3,314,113. AMEMIYA, SHOICHI, NEW YORK, NY. SN 78-771,265. PUB. 8-29-2006, FILED 12-12-2005.

SABIT

FOR COATS; DRESS SHIRTS; DRESSES; FLEECE PULLOVERS; JACKETS; KNIT SHIRTS; PANTS; SKIRTS; SWEATERS; T-SHIRTS (U.S. CLS. 22 AND 39).
FIRST USE 8-15-2006; IN COMMERCE 8-15-2006.

3,314,116. PRESCOTT VALLEY HOCKEY CLUB, LLC, PRESCOTT VALLEY, AZ. SN 78-772,112. PUB. 8-8-2006, FILED 12-13-2005.



THE MARK CONSISTS OF A STYLIZED "S" WITH AN OUTLINE, WITH A 4-POINT DIAMOND IN THE CENTER NEAR THE TOP OF THE "S" AND AN 8-POINT SUN-SHAPED DESIGN IN THE CENTER NEAR THE BOTTOM OF THE "S".

FOR CAPS; GLOVES; HATS; JACKETS; JERSEYS; POLO SHIRTS; SHIRTS; SHORTS; SWEAT PANTS; SWEAT SHIRTS; T-SHIRTS (U.S. CLS. 22 AND 39).
FIRST USE 4-27-2006; IN COMMERCE 5-1-2006.

CLASS 25—(Continued).

3,314,117. PRESCOTT VALLEY HOCKEY CLUB, LLC, PRESCOTT VALLEY, AZ. SN 78-772,123. PUB. 8-8-2006, FILED 12-13-2005.

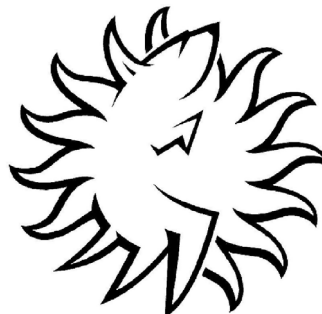

THE MARK CONSISTS OF A SUN-SHAPED DESIGN WITH A STYLIZED VERSION OF A DOG AND ITS FACE OVERLAYED ON THE SUN-SHAPED DESIGN.

FOR CAPS; GLOVES; HATS; JACKETS; JERSEYS; POLO SHIRTS; SHIRTS; SHORTS; SWEAT PANTS; SWEAT SHIRTS; T-SHIRTS (U.S. CLS. 22 AND 39).
FIRST USE 4-27-2006; IN COMMERCE 5-1-2006.

3,314,119. INBS INC., NEW YORK, NY. SN 78-772,389. PUB. 9-12-2006, FILED 12-13-2005.

STEPHEN AND CASEY

THE MARK CONSISTS OF STANDARD CHARACTERS WITHOUT CLAIM TO ANY PARTICULAR FONT, STYLE, SIZE, OR COLOR.

FOR WOMEN'S CLOTHING, NAMELY, BLAZERS, BLOUSES, CAMISOLES, CARDIGANS, DRESSES, JUMPERS, PANTS, PANTSUITS, SHELLS, SHIRTS, SHORTS, SKIRTS, SLACKS, SWEATERS, TANK TOPS, TUNICS, T-SHIRTS, VESTS (U.S. CLS. 22 AND 39).
FIRST USE 1-27-2006; IN COMMERCE 1-27-2006.

CLASS 25—(Continued).

3,314,123. MUNRO & COMPANY, INC., HOT SPRINGS, AR. SN 78-773,902. PUB. 8-8-2006, FILED 12-15-2005.

CLASS 25—(Continued).

3,314,157. NOBLE FIBER TECHNOLOGIES, LLC, SCRANTON, PA. SN 78-777,813. PUB. 8-22-2006, FILED 12-21-2005.

BASICALLY BAREFOOT

ARMOR FOR YOUR FEET

THE MARK CONSISTS OF STANDARD CHARACTERS WITHOUT CLAIM TO ANY PARTICULAR FONT, STYLE, SIZE, OR COLOR.
FOR SHOES (U.S. CLS. 22 AND 39).
FIRST USE 8-30-2006; IN COMMERCE 8-30-2006.

THE MARK CONSISTS OF STANDARD CHARACTERS WITHOUT CLAIM TO ANY PARTICULAR FONT, STYLE, SIZE, OR COLOR.
FOR CLOTHING, NAMELY, BATHING SUITS, INFANT CLOTH DIAPERS, GLOVES, HATS, INSOLES, UNIFORMS, SHOES, SOCKS, PANTYHOSE, UNDERWEAR, DRIVING GLOVES, JERSEYS, T-SHIRTS AND WAISTBANDS IN THE NATURE OF BELTS (U.S. CLS. 22 AND 39).
FIRST USE 1-0-2006; IN COMMERCE 1-0-2006.

3,314,137. WASHINGTON SHOE COMPANY, KENT, WA. SN 78-775,448. PUB. 8-22-2006, FILED 12-16-2005.

3,314,162. DISGUISE, INC., POWAY, CA. SN 78-778,241. PUB. 9-5-2006, FILED 12-21-2005.

WESTERN CHIEF

THY EVIL COURT

THE MARK CONSISTS OF STANDARD CHARACTERS WITHOUT CLAIM TO ANY PARTICULAR FONT, STYLE, SIZE, OR COLOR.
OWNER OF U.S. REG. NO. 2,662,872.
FOR BOOTS; WORK BOOTS; SNOW BOOTS; RUBBER BOOTS; RAIN BOOTS; SHOES; CLOGS; SANDALS; MOCCASINS; SLIPPERS; FOOTWEAR; RAIN COATS; T-SHIRTS; HATS; RAIN HATS; AND HEADWEAR (U.S. CLS. 22 AND 39).
FIRST USE 1-1-1920; IN COMMERCE 1-1-1920.

THE MARK CONSISTS OF STANDARD CHARACTERS WITHOUT CLAIM TO ANY PARTICULAR FONT, STYLE, SIZE, OR COLOR.
FOR HALLOWEEN AND MASQUERADE COSTUMES, AND MASKS SOLD IN CONNECTION THEREWITH (U.S. CLS. 22 AND 39).
FIRST USE 1-11-2006; IN COMMERCE 1-11-2006.

3,314,154. BENCHMARK BRANDS, INC., MEMPHIS, TN. SN 78-777,096. PUB. 8-29-2006, FILED 12-20-2005.

3,314,167. RODRIGUEZ, RAUL CAMPILLO, ELCHE (ALICANTE), SPAIN. SN 78-779,540. PUB. 1-23-2007, FILED 12-22-2005.

Europedica

NEWDRESS

THE MARK CONSISTS OF STANDARD CHARACTERS WITHOUT CLAIM TO ANY PARTICULAR FONT, STYLE, SIZE, OR COLOR.
FOR COMFORT FOOTWEAR (U.S. CLS. 22 AND 39).
FIRST USE 12-20-2005; IN COMMERCE 9-15-2006.

THE MARK CONSISTS OF STANDARD CHARACTERS WITHOUT CLAIM TO ANY PARTICULAR FONT, STYLE, SIZE, OR COLOR.
OWNER OF U.S. REG. NO. 2,617,120.
FOR FOOTWEAR EXCLUDING ORTHOPEDIC FOOTWEAR (U.S. CLS. 22 AND 39).
FIRST USE 2-0-2006; IN COMMERCE 2-0-2006.

CLASS 25—(Continued).

3,314,220. DO DENIM LLC, MIAMI, FL. SN 78-789,268. PUB. 9-12-2006, FILED 1-11-2006.

DO DENIM

THE MARK CONSISTS OF STANDARD CHARACTERS WITHOUT CLAIM TO ANY PARTICULAR FONT, STYLE, SIZE, OR COLOR.

NO CLAIM IS MADE TO THE EXCLUSIVE RIGHT TO USE "DENIM", APART FROM THE MARK AS SHOWN.

FOR BATHING SUITS; BELTS; BELTS MADE OF LEATHER; BELTS OF TEXTILE; BLOUSES; BODY SUITS; CROP TOPS; DRESS SUITS; FABRIC BELTS; HALTER TOPS; JACKETS; JERSEYS; JOGGING SUITS; LEATHER BELTS; MEN'S SUITS, WOMEN'S SUITS; MUSCLE TOPS; PANTS; PLAY SUITS; RUGBY TOPS; SHIRTS; SHORT SETS; SHORTS; SHOULDER WRAPS; SKI SUITS; SKIRTS AND DRESSES; SLACKS; SNOW SUITS; SOCKS; SUIT COATS; SUITS; SWEAT SUITS; TANK TOPS; TOPS; TRACK SUITS; TRAINING SUITS; VESTS; WAIST BELTS; WARM UP SUITS; WET SUITS (U.S. CLS. 22 AND 39).

FIRST USE 4-1-2006; IN COMMERCE 4-1-2006.

CLASS 25—(Continued).

3,314,239. QUINTANILLA, ELIZABETH J., WOODBRIDGE, VA. SN 78-792,928. PUB. 9-12-2006, FILED 1-17-2006.



FOR CLOTHING, NAMELY, SHIRTS, PANTS, BABY DOLL T-SHIRTS, T-SHIRTS, POLO SHIRTS, SKIRTS, DRESSES, MINI-SKIRTS, HATS, HEADWEAR, JACKETS, COATS, UNDERGARMENTS, SHORTS, SWEAT PANTS, SWEAT SHIRTS AND SWEAT SUITS, WRIST BANDS, HOODS, SWEATERS, BELTS, BUTTON-DOWN DRESS SHIRTS, TANK TOPS, NECKWARE, FOOTWEAR AND DENIM CLOTHING, NAMELY DENIM JEANS AND DENIM JACKETS (U.S. CLS. 22 AND 39).

FIRST USE 10-20-2005; IN COMMERCE 1-15-2006.

3,314,228. INTERNATIONAL SEAWAY TRADING CORPORATION, BOCA RATON, FL. SN 78-791,489. PUB. 9-19-2006, FILED 1-13-2006.

SURFBOARDS

THE MARK CONSISTS OF STANDARD CHARACTERS WITHOUT CLAIM TO ANY PARTICULAR FONT, STYLE, SIZE, OR COLOR.

OWNER OF U.S. REG. NO. 981,157.

FOR FOOTWEAR, NAMELY, CLOGS FABRICATED OF POLYMER FOAM EVA MATERIAL (U.S. CLS. 22 AND 39).

FIRST USE 1-0-2007; IN COMMERCE 1-0-2007.

3,314,245. PICHU LLC, BEVERLY HILLS, CA. SN 78-793,333. PUB. 9-12-2006, FILED 1-17-2006.

SKYLAB

THE MARK CONSISTS OF STANDARD CHARACTERS WITHOUT CLAIM TO ANY PARTICULAR FONT, STYLE, SIZE, OR COLOR.

FOR CLOTHING, NAMELY T-SHIRTS, TANK TOPS, SPORTS BRAS, PANTS, SHORTS, JACKETS, JERSEYS, SHIRTS, PULLOVERS, WARM-UP SUITS, SWEATSUITS, LEGGINGS, SOCKS, SHOES, ATHLETIC FOOTWEAR, WRIST SWEATBANDS, HEAD SWEATBANDS AND CAPS (U.S. CLS. 22 AND 39).

FIRST USE 4-25-2007; IN COMMERCE 4-25-2007.

CLASS 25—(Continued).

3,314,256. WISE BUYS INC., ATLANTA, GA. SN 78-795,140. PUB. 12-26-2006, FILED 1-19-2006.

212 BLUE

THE MARK CONSISTS OF STANDARD CHARACTERS WITHOUT CLAIM TO ANY PARTICULAR FONT, STYLE, SIZE, OR COLOR.

FOR CLOTHING FOR MEN, CHILDREN, BOYS AND GIRLS, NAMELY, JEANS, PANTS, SHIRTS, SWEATSHIRTS, HATS, CAPS, HEADBANDS, VESTS, BATHING SUITS, SHOES, SOCKS, HOSIERY, WARM-UP SUITS, AND WIND SUITS, UNDERWEAR, LOUNGEWEAR AND KNITS, NAMELY, KNIT SHIRTS AND TEE SHIRTS (U.S. CLS. 22 AND 39).

FIRST USE 1-1-2006; IN COMMERCE 1-2-2006.

3,314,264. GOUDA, INC., NEW YORK, NY. SN 78-796,077. PUB. 4-10-2007, FILED 1-20-2006.

LOGICA

FOR CLOTHING AND APPAREL, NAMELY, SHIRTS, T-SHIRTS, SOCKS, NECKTIES, SCARVES, ROBES, PAJAMAS, SLIPPERS, SHOES, PANTS, SHORTS, COATS, AND HATS (U.S. CLS. 22 AND 39).

FIRST USE 5-1-2006; IN COMMERCE 5-1-2006.

3,314,270. SAWYER, GEOFFREY, ATLANTA, GA. AND SAWYER, NIGEL, MARIETTA, GA. SN 78-797,965. PUB. 9-26-2006, FILED 1-24-2006.

Down South

THE MARK CONSISTS OF STANDARD CHARACTERS WITHOUT CLAIM TO ANY PARTICULAR FONT, STYLE, SIZE, OR COLOR.

FOR T-SHIRTS, JACKETS, PANTS, SHIRTS, COATS, BANDANNAS, SWEATSHIRTS, HEADWEAR, UNDERWEAR, BOXER SHORTS (U.S. CLS. 22 AND 39).

FIRST USE 1-3-2006; IN COMMERCE 1-6-2006.

CLASS 25—(Continued).

3,314,280. WORLD WRESTLING ENTERTAINMENT, INC., STAMFORD, CT. SN 78-800,278. PUB. 9-5-2006, FILED 1-26-2006.

CYBER SUNDAY

THE MARK CONSISTS OF STANDARD CHARACTERS WITHOUT CLAIM TO ANY PARTICULAR FONT, STYLE, SIZE, OR COLOR.

FOR CLOTHING, NAMELY, TANK TOPS, T-SHIRTS, SHIRTS, SPORT SHIRTS, DRESS SHIRTS, POLO SHIRTS, UNDERSHIRTS, SWEATSHIRTS, SWEATERS, PULL-OVERS, BLOUSES, JACKETS, RAINCOATS, OVERCOATS, TOPCOATS, TROUSERS, PANTS, JEAN PANTS, JOGGING SUITS, EXERCISE PANTS, EXERCISE SUITS, SWEATPANTS, SHORTS, UNDERWEAR, BOXER SHORTS, SOCKS, CLOTHING TIES, PAJAMAS, BELTS, GLOVES, HALLOWEEN AND MASQUERADE COSTUMES, WRIST BANDS, BANDANNAS; FOOTWEAR, NAMELY, SHOES, SNEAKERS, BOOTS, SLIPPERS; HEADWEAR, NAMELY, HATS, CAPS (U.S. CLS. 22 AND 39).

FIRST USE 11-30-2006; IN COMMERCE 11-30-2006.

3,314,284. HUNTER CREEK HATTING & CO, DUBLIN, CA. SN 78-801,825. PUB. 9-26-2006, FILED 1-29-2006.

HUNTER CREEK HATTING & CO

THE MARK CONSISTS OF STANDARD CHARACTERS WITHOUT CLAIM TO ANY PARTICULAR FONT, STYLE, SIZE, OR COLOR.

NO CLAIM IS MADE TO THE EXCLUSIVE RIGHT TO USE "HATTING & CO", APART FROM THE MARK AS SHOWN.

FOR CAPS WITH VISORS; GLOVES INCLUDING THOSE MADE OF SKIN, HIDE OR FUR; MEN AND WOMEN JACKETS, COATS, TROUSERS, VESTS (U.S. CLS. 22 AND 39).

FIRST USE 11-1-2006; IN COMMERCE 11-1-2006.

CLASS 25—(Continued).

3,314,286. SMITH, KEVIN T., WASHINGTON, DC. AND BUNTIN, BILLY, WASHINGTON, DC. SN 78-801,863. PUB. 9-19-2006, FILED 1-29-2006.



FOR BASEBALL CAPS, T-SHIRTS, POLO SHIRTS, HEAD BANDS, HEADWEAR (U.S. CLS. 22 AND 39). FIRST USE 3-31-2006; IN COMMERCE 3-31-2006.

CLASS 25—(Continued).

3,314,315. CHAO, PEI-CHING, TAICHUNG, TAIWAN. SN 78-808,826. PUB. 12-12-2006, FILED 2-7-2006.

Vivian Chao

THE NAME VIVIAN CHAO DOES NOT IDENTIFY A LIVING INDIVIDUAL.
FOR SHOES; LADIES' SHOES; WOMEN'S SHOES; MEN'S SHOES; SANDALS; SLIPPERS; LEATHER SHOES; SPORTS SHOES; SNEAKERS; CHILDREN'S SHOES (U.S. CLS. 22 AND 39). FIRST USE 2-8-2006; IN COMMERCE 2-8-2006.

3,314,294. SYYAP, CHRISTOPHER J, PLANO, TX. SN 78-804,173. PUB. 10-10-2006, FILED 2-1-2006.



NO CLAIM IS MADE TO THE EXCLUSIVE RIGHT TO USE "CLOTHING CO.", APART FROM THE MARK AS SHOWN.

FOR UNDER WEAR, HEAD BANDS, CAPS, BEANIES, HEAD WEAR, WRIST BANDS, SOCKS, T-SHIRTS, GYM SHIRTS, SWEAT SHIRTS, HOODED SWEATSHIRT, TANK TOPS, GYM SHORTS, SWEAT SHORTS, JOGGING PANTS, SWEAT PANTS, WARM UP SUITS, PANTS, RAIN SUITS, JACKETS (U.S. CLS. 22 AND 39). FIRST USE 12-15-2006; IN COMMERCE 1-19-2007.

3,314,337. KAMIRAN INC., LOS ANGELES, CA. SN 78-811,662. PUB. 10-3-2006, FILED 2-9-2006.

FROM THE HEART JEANS

THE MARK CONSISTS OF STANDARD CHARACTERS WITHOUT CLAIM TO ANY PARTICULAR FONT, STYLE, SIZE, OR COLOR.

NO CLAIM IS MADE TO THE EXCLUSIVE RIGHT TO USE "JEANS", APART FROM THE MARK AS SHOWN.
FOR CLOTHING, NAMELY, TOPS, PANTS, JACKETS, SHIRTS, SKIRTS, AND JEANS (U.S. CLS. 22 AND 39). FIRST USE 4-25-2007; IN COMMERCE 4-25-2007.

CLASS 25—(Continued).

3,314,338. REDCATS USA, L.P., INDIANAPOLIS, IN. SN 78-811,997. PUB. 8-8-2006, FILED 2-10-2006.

KING'S COURT PLATINUM

THE MARK CONSISTS OF STANDARD CHARACTERS WITHOUT CLAIM TO ANY PARTICULAR FONT, STYLE, SIZE, OR COLOR.

OWNER OF U.S. REG. NO. 2,635,986.
FOR JACKETS; PANTS; SHIRTS; TIES; VESTS (U.S. CLS. 22 AND 39).
FIRST USE 9-0-2006; IN COMMERCE 9-0-2006.

3,314,354. SP LICENSING, LLC, LOS ANGELES, CA. SN 78-814,706. PUB. 9-19-2006, FILED 2-14-2006.

IMAGINE PEACE

THE MARK CONSISTS OF STANDARD CHARACTERS WITHOUT CLAIM TO ANY PARTICULAR FONT, STYLE, SIZE, OR COLOR.

FOR BLOUSES; BOXER SHORTS; DRESS SHIRTS; FOOTWEAR; HEADGEAR, NAMELY, HATS AND CAPS; NECKWEAR; PANTS; POLO SHIRTS; SHIRTS; SHORTS; SKIRTS AND DRESSES; SWEAT PANTS; SWEAT SHIRTS; SWEAT SHORTS; SWIMSUITS; T-SHIRTS; UNDERWEAR (U.S. CLS. 22 AND 39).
FIRST USE 2-0-2007; IN COMMERCE 2-0-2007.

3,314,355. DOMINGUEZ, KIM H., IRVINE, CA. SN 78-814,941. PUB. 10-17-2006, FILED 2-15-2006.

MINIAC

THE MARK CONSISTS OF STANDARD CHARACTERS WITHOUT CLAIM TO ANY PARTICULAR FONT, STYLE, SIZE, OR COLOR.

FOR CLOTHING, NAMELY, T-SHIRTS (U.S. CLS. 22 AND 39).
FIRST USE 1-1-2007; IN COMMERCE 1-1-2007.

CLASS 25—(Continued).

3,314,364. ACUSHNET COMPANY, FAIRHAVEN, MA. SN 78-817,345. PUB. 8-22-2006, FILED 2-17-2006.

ReoFit

FOR GOLF SHOES (U.S. CLS. 22 AND 39).
FIRST USE 6-1-2006; IN COMMERCE 6-1-2006.

3,314,387. ROYAL ROBBINS, INC., MODESTO, CA. SN 78-820,069. PUB. 10-10-2006, FILED 2-21-2006.



OWNER OF U.S. REG. NO. 1,303,905.
THE MARK CONSISTS OF THE SILHOUETTE OF A WALKING MAN WITH HAT, BACKPACK AND WALKING STICK.

FOR DRESSES, SKIRTS, CAPRIS, BELTS, BLOUSES; JACKETS, ANORAKS, COATS, PARKAS, VESTS, PULL-OVERS, FLEECE PULLOVERS, RAINWEAR, WIND-SHIRTS, WINDCHEATERS; HEADWEAR, CAPS, VISORS, BEANIES; SWIMWEAR (U.S. CLS. 22 AND 39).
FIRST USE 7-8-2005; IN COMMERCE 7-8-2005.

CLASS 25—(Continued).

3,314,392. AMARU ENTERTAINMENT, INC., WEST HOLLYWOOD, CA. SN 78-820,817. PUB. 3-20-2007, FILED 2-22-2006.



FOR CLOTHING, NAMELY T-SHIRTS, SHIRTS, JACKETS, PANTS, SWEATSHIRTS, PANTS, SHORTS, BLOUSES, JEANS, HEADWEAR, AND FOOTWEAR (U.S. CLS. 22 AND 39).

FIRST USE 11-1-2003; IN COMMERCE 11-1-2003.

CLASS 25—(Continued).

3,314,493. RENA ENTERPRISES, INC., SINKING SPRING, PA. SN 78-850,548. PUB. 10-31-2006, FILED 3-30-2006.



NO CLAIM IS MADE TO THE EXCLUSIVE RIGHT TO USE "WATERPROOF", APART FROM THE MARK AS SHOWN.

FOR CLOTHING, NAMELY PANTS, GLOVES, HATS AND JACKETS (U.S. CLS. 22 AND 39).

FIRST USE 2-22-2006; IN COMMERCE 2-22-2006.

3,314,441. O'SULLIVAN, JAMES P. SR., LEESBURG, FL. SN 78-831,914. PUB. 10-31-2006, FILED 3-8-2006.

FOREARMS

THE MARK CONSISTS OF STANDARD CHARACTERS WITHOUT CLAIM TO ANY PARTICULAR FONT, STYLE, SIZE, OR COLOR.

FOR GOLF SHIRTS (U.S. CLS. 22 AND 39).

FIRST USE 2-15-2007; IN COMMERCE 2-15-2007.

3,314,511. PATSCHULL, GREGORY S., SAN PEDRO, CA. SN 78-858,746. PUB. 11-21-2006, FILED 4-11-2006.



FOR CLOTHING NAMELY, T-SHIRTS AND HATS (U.S. CLS. 22 AND 39).

FIRST USE 0-0-1999; IN COMMERCE 0-0-1999.

3,314,459. SOLE CREATIONS INC., FLUSHING, NY. SN 78-835,430. PUB. 2-20-2007, FILED 3-13-2006.

CREATIVE SOLES

THE MARK CONSISTS OF STANDARD CHARACTERS WITHOUT CLAIM TO ANY PARTICULAR FONT, STYLE, SIZE, OR COLOR.

NO CLAIM IS MADE TO THE EXCLUSIVE RIGHT TO USE "SOLES", APART FROM THE MARK AS SHOWN.

FOR FOOTWEAR (U.S. CLS. 22 AND 39).

FIRST USE 5-0-2006; IN COMMERCE 6-0-2006.

3,314,512. THORP DIRECT SALES, INC., DORAVILLE, GA. SN 78-858,791. PUB. 11-14-2006, FILED 4-11-2006.

AUSTIN LIGHTS

THE MARK CONSISTS OF STANDARD CHARACTERS WITHOUT CLAIM TO ANY PARTICULAR FONT, STYLE, SIZE, OR COLOR.

FOR BOOTS (U.S. CLS. 22 AND 39).

FIRST USE 5-8-2006; IN COMMERCE 5-8-2006.

CLASS 25—(Continued).

3,314,513. PARIS ACCESSORIES, INC., NEW YORK, NY. SN 78-859,580. PUB. 12-5-2006, FILED 4-12-2006.



THE MARK CONSISTS OF DESIGN OF BACKWARD "S" WITH TOES AND THE WORD "SANDBEANS". FOR FOOTWEAR; NAMELY, FLIP FLOPS, SHOES, SOCKS AND HOSIERY (U.S. CLS. 22 AND 39). FIRST USE 7-7-2006; IN COMMERCE 7-7-2006.

3,314,530. TLS INTERNATIONAL, LLC, NEEDHAM, MA. SN 78-864,456. PUB. 11-28-2006, FILED 4-19-2006.



FOR HEADWEAR, NAMELY HATS (U.S. CLS. 22 AND 39). FIRST USE 6-30-2006; IN COMMERCE 6-30-2006.

3,314,569. SUBLIMATION FACTORY, INC., LOS ANGELES, CA. SN 78-879,282. PUB. 12-12-2006, FILED 5-8-2006.

1976

THE MARK CONSISTS OF STANDARD CHARACTERS WITHOUT CLAIM TO ANY PARTICULAR FONT, STYLE, SIZE, OR COLOR.

FOR MEN'S AND WOMEN'S CLOTHING, NAMELY JEANS, PANTS, SHIRTS, SWEATERS, SWEATSHIRTS, SHORTS, SKIRTS, DRESSES AND TANK TOPS (U.S. CLS. 22 AND 39). FIRST USE 3-20-2007; IN COMMERCE 3-20-2007.

CLASS 25—(Continued).

3,314,572. CEO SHIRT CORPORATION, THE, NEW YORK, NY. SN 78-879,710. PUB. 2-27-2007, FILED 5-9-2006.



NO CLAIM IS MADE TO THE EXCLUSIVE RIGHT TO USE "SHIRT", APART FROM THE MARK AS SHOWN. FOR SHIRTS (U.S. CLS. 22 AND 39). FIRST USE 4-4-2007; IN COMMERCE 4-4-2007.

3,314,589. THE RESOURCE CLUB LTD., NEW YORK, NY. SN 78-884,444. PUB. 12-26-2006, FILED 5-16-2006.



FOR MEN'S AND WOMEN'S CLOTHING AND FOOTWEAR, NAMELY, KNIT TOPS AND BOTTOMS, WOVEN TOPS AND BOTTOMS, SHIRTS, PANTS, JEANS, SWEATERS, SKIRTS DRESSES, SUITS, PANTSUITS, COATS, BELTS, SHOES, HOSIERY AND SOCKS (U.S. CLS. 22 AND 39). FIRST USE 6-15-2006; IN COMMERCE 6-15-2006.

3,314,590. THE RESOURCE CLUB LTD., NEW YORK, NY. SN 78-884,450. PUB. 12-12-2006, FILED 5-16-2006.



THE MARK CONSISTS OF A STYLIZED LINE IN FRONT OF THE STYLIZED LETTERS R X AND B.

FOR MEN'S AND WOMEN'S CLOTHING AND FOOTWEAR, NAMELY, KNIT TOPS AND BOTTOMS, WOVEN TOPS AND BOTTOMS, SHIRTS, PANTS, JEANS, SWEATERS, SKIRTS DRESSES, SUITS, PANTSUITS, COATS, BELTS, SHOES, HOSIERY AND SOCKS (U.S. CLS. 22 AND 39). FIRST USE 6-15-2006; IN COMMERCE 6-15-2006.

CLASS 25—(Continued).

3,314,604. ARANA, KARI L., BRENTWOOD, CA. SN 78-887,378. PUB. 1-9-2007, FILED 5-19-2006.



THE COLOR(S) BLACK, WHITE AND GREEN IS/ARE CLAIMED AS A FEATURE OF THE MARK.

THE COLOR GREEN APPEARS IN THE WINE BOTTLE, THE COLOR BLACK APPEARS IN THE WORDS "WINE NOT?", IN THE RECTANGULAR BORDER AROUND THE MARK, IN THE SHADING OF THE BOTTLE AND IN THE BACKGROUND OF THE RIGHT SIDE OF THE MARK BEHIND THE BOTTLE, THE COLOR WHITE APPEAR IN THE BACKGROUND OF THE LEFT SIDE OF THE MARK BEHIND THE WORDS "WINE NOT?" AND IN THE BOTTLE CORK.

FOR SHIRTS AND HATS (U.S. CLS. 22 AND 39).
FIRST USE 9-2-2006; IN COMMERCE 9-2-2006.

3,314,606. KING OF FLEECE, LLC, WILLIAMSVILLE, NY. SN 78-887,565. PUB. 1-2-2007, FILED 5-19-2006.

SPLITWEIGHT

THE MARK CONSISTS OF STANDARD CHARACTERS WITHOUT CLAIM TO ANY PARTICULAR FONT, STYLE, SIZE, OR COLOR.

FOR BELTS; CAMP SHIRTS; CAPS; CLOTH BIBS; CLOTHING, NAMELY, ARM WARMERS; CLOTHING, NAMELY, FOLK COSTUMES; CLOTHING, NAMELY, KNEE WARMERS; CLOTHING, NAMELY, WRAP-AROUNDS; CORSETS; DRESS SHIRTS; DUSTERS; FOULARDS; HEADBANDS AGAINST SWEATING; HOODS; JERSEYS; LEATHER BELTS; MANTLES; MUFFLERS; NIGHT SHIRTS; OPEN-NECKED SHIRTS; PARTS OF CLOTHING, NAMELY, GUSSETS FOR TIGHTS, GUSSETS FOR STOCKINGS, GUSSETS FOR BATHING SUITS, GUSSETS FOR UNDERWEAR, GUSSETS FOR LEOTARDS AND GUSSETS FOR FOOTLETS; PERSPIRATION ABSORBENT UNDERWEAR CLOTHING; PIQUET SHIRTS; SHIRTS; SHIRTS; SHORT SETS; SHOULDER PADS FOR CLOTHING; SHOULDER WRAPS; SLEEP SHIRTS; SPORT SHIRTS; SPORTS BRA; SPORTS JACKETS; SPORTS JERSEYS; SPORTS JERSEYS AND BREECHES FOR SPORTS; SPORTS OVERUNIFORMS; SPORTS SHIRTS; SPORTS SHIRTS WITH SHORT SLEEVES; STOCKINGS; SWEAT BANDS; SWEAT PANTS; SWEAT SHIRTS; SWEAT SHORTS; SWEAT SUITS; T-SHIRTS; TOPS; TROUSERS FOR SWEATING; UNDERARM CLOTHING SHIELDS; WIND SHIRTS; WRAPS (U.S. CLS. 22 AND 39).

FIRST USE 10-6-2006; IN COMMERCE 10-6-2006.

CLASS 25—(Continued).

3,314,627. SIX COMPANIONS FABRIC INDUSTRY CO., LTD., SHE-TOU SHIANG, TAIWAN. SN 78-893,830. PUB. 5-22-2007, FILED 5-26-2006.



FOR PANTY STOCKINGS; STOCKINGS; SOCKS; UNDERWEAR; GIRDLES; PAJAMAS; NIGHTWEAR; PANTS; DRESSES; SKIRTS; LOUNGEWEAR; BLOUSES; HEADGEAR; GLOVES; BELTS; SWIMWEAR; LEOTARDS; JACKETS; SUITS; ANORAKS; SPORTS BRAS; WAISTCOATS; AND SHOES (U.S. CLS. 22 AND 39).
FIRST USE 5-17-1985; IN COMMERCE 5-17-1985.

3,314,629. FRANCZEK, ROBERT A., CHICAGO, IL. SN 78-895,528. PUB. 1-9-2007, FILED 5-30-2006.

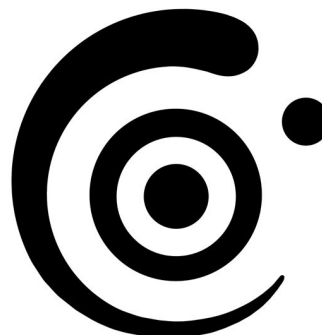

FOR SHIRTS AND HATS (U.S. CLS. 22 AND 39).
FIRST USE 6-1-2005; IN COMMERCE 8-12-2007.

3,314,645. WOLVERINE OUTDOORS, INC., ROCKFORD, MI. SN 78-897,776. PUB. 12-19-2006, FILED 6-1-2006.

TRAILSPRING

THE MARK CONSISTS OF STANDARD CHARACTERS WITHOUT CLAIM TO ANY PARTICULAR FONT, STYLE, SIZE, OR COLOR.

FOR FOOTWEAR (U.S. CLS. 22 AND 39).
FIRST USE 6-30-2005; IN COMMERCE 6-30-2005.

CLASS 25—(Continued).

3,314,650. S.W.B. APPAREL, INC., NEW YORK, NY. SN 78-899,343. PUB. 3-20-2007, FILED 6-2-2006.

HAMA

THE MARK CONSISTS OF STANDARD CHARACTERS WITHOUT CLAIM TO ANY PARTICULAR FONT, STYLE, SIZE, OR COLOR.

THE FOREIGN WORDING IN THE MARK TRANSLATES INTO ENGLISH AS HIPPOPOTAMUS.

FOR CLOTHING NAMELY, T-SHIRTS, SHIRTS, SWEATSHIRTS, SWEATERS, JACKETS, RAINCOATS, JEANS, SHORTS, PANTS, TRACK SUITS, JOGGING SUITS, SWEATPANTS, FLEECE SHIRTS, FLEECE JACKETS, FLEECE PULLOVERS, SLEEPWEAR, UNDERWEAR, CAPRI PANTS, VESTS, POLO SHIRTS, DRESS SHIRTS, MESH SHIRTS, MESH SHORTS, JERSEYS, TANK TOPS, DOWN JACKETS, TRACK JACKETS, LEATHER JACKETS, SUEDE JACKETS, DENIM JACKETS, LEATHER PANTS, BELTS, GLOVES, SUSPENDERS, CAPS, HATS, VISORS, BASEBALL CAPS, SHOES AND SNEAKERS (U.S. CLS. 22 AND 39).

FIRST USE 8-28-2006; IN COMMERCE 8-28-2006.

3,314,664. POINTE NOIR PTY LTD., PYRMONT, AUSTRALIA. SN 78-902,228. PUB. 3-20-2007, FILED 6-6-2006.

THERMO MORPH TECHNOLOGY

THE MARK CONSISTS OF STANDARD CHARACTERS WITHOUT CLAIM TO ANY PARTICULAR FONT, STYLE, SIZE, OR COLOR.

NO CLAIM IS MADE TO THE EXCLUSIVE RIGHT TO USE "TECHNOLOGY", APART FROM THE MARK AS SHOWN.

FOR FOOTWEAR (U.S. CLS. 22 AND 39).
FIRST USE 9-30-2006; IN COMMERCE 9-30-2006.

3,314,682. KIM, HYUN, LOS ANGELES, CA. SN 78-906,489. PUB. 1-30-2007, FILED 6-13-2006.

MYSTREE

THE MARK CONSISTS OF STANDARD CHARACTERS WITHOUT CLAIM TO ANY PARTICULAR FONT, STYLE, SIZE, OR COLOR.

FOR BLOUSES; DRESSES; JACKETS; KNIT SHIRTS; PANTS; SKIRTS; TOPS (U.S. CLS. 22 AND 39).
FIRST USE 6-19-2007; IN COMMERCE 6-19-2007.

CLASS 25—(Continued).

3,314,712. COLAVECCHIO-GOODINE, WENDY, BANGOR, ME. AND COMMEAU, CINDY, BANGOR, ME. SN 78-913,988. PUB. 2-13-2007, FILED 6-22-2006.

WOODBOOGAH

THE MARK CONSISTS OF STANDARD CHARACTERS WITHOUT CLAIM TO ANY PARTICULAR FONT, STYLE, SIZE, OR COLOR.

FOR T-SHIRTS AND HATS (U.S. CLS. 22 AND 39).
FIRST USE 1-1-2007; IN COMMERCE 1-1-2007.

3,314,774. SYLA LLC, NEW YORK, NY. SN 78-935,524. PUB. 3-20-2007, FILED 7-23-2006.



THE NAME(S), PORTRAIT(S), AND/OR SIGNATURE(S) SHOWN IN THE MARK IDENTIFIES SYLVIE CACHAY, WHOSE CONSENT(S) TO REGISTER IS SUBMITTED.

THE MARK CONSISTS OF A STYLIZED SEAHORSE AND STYLIZED LETTERS FOR THE WORDS SYLA BY SYLVIE CACHAY.

FOR CLOTHING NAMELY, SHORTS, PANTS, SWEATERS, DRESSES, BATH AND BEACH ROBES, SHAWLS, JACKETS (U.S. CLS. 22 AND 39).

FIRST USE 5-3-2007; IN COMMERCE 5-3-2007.

3,314,803. SASCHA LLC, PORTLAND, OR. SN 78-946,839. PUB. 3-20-2007, FILED 8-7-2006.

THERMOTRILE

THE MARK CONSISTS OF STANDARD CHARACTERS WITHOUT CLAIM TO ANY PARTICULAR FONT, STYLE, SIZE, OR COLOR.

FOR GLOVES (U.S. CLS. 22 AND 39).
FIRST USE 1-10-2007; IN COMMERCE 1-10-2007.

CLASS 25—(Continued).

3,314,814. JJ DENIM, LLC, LOS ANGELES, CA. SN 78-950,332.
PUB. 4-3-2007, FILED 8-11-2006.

VOLTA

THE MARK CONSISTS OF STANDARD CHARACTERS WITHOUT CLAIM TO ANY PARTICULAR FONT, STYLE, SIZE, OR COLOR.
FOR DENIMS, JEANS; PANTS (U.S. CLS. 22 AND 39).
FIRST USE 1-29-2007; IN COMMERCE 1-29-2007.

3,314,825. 2 BB UNLIMITED, INC., LOS ANGELES, CA. SN 78-953,326. PUB. 4-10-2007, FILED 8-16-2006.

garçon

THE ENGLISH TRANSLATION OF THE FRENCH WORD GARÇON IN THE MARK IS "YOUNG MAN" OR "WAITER".
FOR CLOTHING, NAMELY, SHIRTS, PANTS, SKIRTS, DRESSES, SHORTS, JACKETS, COATS, SWEATSHIRTS, SWEATERS AND TEE SHIRTS (U.S. CLS. 22 AND 39).
FIRST USE 8-1-2006; IN COMMERCE 8-1-2006.

3,314,849. DMBM LLC, VERNON, CA. SN 78-959,472. PUB. 4-17-2007, FILED 8-24-2006.

PINKCURIONINE

NO CLAIM IS MADE TO THE EXCLUSIVE RIGHT TO USE "PINK", APART FROM THE MARK AS SHOWN.
FOR APPAREL, NAMELY MEN'S, WOMEN'S AND CHILDREN'S PANTS, JEANS, SLACKS, SHIRTS, SHORTS, JACKETS, COATS, SHIRTS, SWEATERS, BLOUSES, TOPS AND VESTS (U.S. CLS. 22 AND 39).
FIRST USE 11-27-2006; IN COMMERCE 11-27-2006.

CLASS 25—(Continued).

3,314,854. OLAES ENTERPRISES, INC., DBA ODM, POWAY, CA. SN 78-959,936. PUB. 4-17-2007, FILED 8-24-2006.

MUSIC IS MY WEAPON

THE MARK CONSISTS OF STANDARD CHARACTERS WITHOUT CLAIM TO ANY PARTICULAR FONT, STYLE, SIZE, OR COLOR.
FOR CLOTHING APPAREL, NAMELY, SHIRTS (U.S. CLS. 22 AND 39).
FIRST USE 9-25-2006; IN COMMERCE 9-25-2006.

CLASS 26—FANCY GOODS

3,313,436. PEGGY KNIGHT SOLUTIONS, INC., SAUSALITO, CA. SN 78-385,946. PUB. 12-7-2004, FILED 3-17-2004.

PEGGY KNIGHT COOL SOLUTIONS

THE MARK CONSISTS OF STANDARD CHARACTERS WITHOUT CLAIM TO ANY PARTICULAR FONT, STYLE, SIZE, OR COLOR.
FOR HAIRPIECES AND WIGS (U.S. CLS. 37, 39, 40, 42 AND 50).
FIRST USE 1-1-2007; IN COMMERCE 1-1-2007.

3,314,376. COME TO WIN, FORT WASHINGTON, MD. SN 78-818,448. PUB. 10-17-2006, FILED 2-18-2006.

Come To Win



FOR HAIR BANDS (U.S. CLS. 37, 39, 40, 42 AND 50).
FIRST USE 4-1-2007; IN COMMERCE 4-1-2007.

CLASS 26—(Continued).

3,314,808. HICKFORD, MICHELE, DEERFIELD BEACH, FL. SN 78-948,263. PUB. 3-27-2007, FILED 8-9-2006.



THE MARK CONSISTS OF A STYLIZED LETTER "M" OVER THE WORD MULEOS.

FOR SHOE BUCKLES; SHOE LACES; SHOE ORNAMENTS NOT OF PRECIOUS METAL (U.S. CLS. 37, 39, 40, 42 AND 50).

FIRST USE 1-1-2007; IN COMMERCE 1-1-2007.

CLASS 27—FLOOR COVERINGS

3,313,662. GENESYS INTERIORS, LLC, ATLANTA, GA. SN 78-619,142. PUB. 8-8-2006, FILED 4-28-2005.

(SET)

THE MARK CONSISTS OF STANDARD CHARACTERS WITHOUT CLAIM TO ANY PARTICULAR FONT, STYLE, SIZE, OR COLOR.

FOR VINYL WALL COVERINGS; WALLPAPER; WALLPAPER PRINTED WITH MURAL SCENES (U.S. CLS. 19, 20, 37, 42 AND 50).

FIRST USE 9-15-2005; IN COMMERCE 9-15-2005.

CLASS 27—(Continued).

3,313,852. GENESYS INTERIORS, LLC, ATLANTA, GA. SN 78-701,520. PUB. 7-4-2006, FILED 8-26-2005.

WRITEWALLS

THE MARK CONSISTS OF STANDARD CHARACTERS WITHOUT CLAIM TO ANY PARTICULAR FONT, STYLE, SIZE, OR COLOR.

FOR DRY ERASABLE WALLPAPER UPON WHICH WRITTEN MATERIAL AND IMAGES MAY BE APPLIED AND THEREAFTER REMOVED (U.S. CLS. 19, 20, 37, 42 AND 50).

FIRST USE 1-21-2007; IN COMMERCE 1-21-2007.

3,314,216. JOHN RICH & SONS INVESTMENT HOLDING COMPANY, WILMINGTON, DE. SN 78-788,892. PUB. 9-5-2006, FILED 1-10-2006.



THE COLOR(S) RED AND BLACK IS/ARE CLAIMED AS A FEATURE OF THE MARK.

THE MARK CONSISTS OF A SQUARE MADE UP OF FOUR SMALLER SQUARES. THE UPPER LEFT SQUARE IS BLACK. THE LOWER RIGHT SQUARE IS RED. THE UPPER RIGHT AND LOWER LEFT SQUARES ARE DIAGONAL BLACK AND RED STRIPES.

FOR RUGS (U.S. CLS. 19, 20, 37, 42 AND 50).

FIRST USE 1-31-2007; IN COMMERCE 1-31-2007.

3,314,399. BEAULIEU GROUP, LLC, DALTON, GA. SN 78-821,706. PUB. 11-21-2006, FILED 2-23-2006.

EVERCLEAN BY CORONET

THE MARK CONSISTS OF STANDARD CHARACTERS WITHOUT CLAIM TO ANY PARTICULAR FONT, STYLE,

CLASS 27—(Continued).

SIZE, OR COLOR.

OWNER OF U.S. REG. NOS. 2,512,286, 2,512,297, AND 2,890,301.

FOR CARPETS (U.S. CLS. 19, 20, 37, 42 AND 50).
FIRST USE 9-15-2006; IN COMMERCE 9-15-2006.**CLASS 28—(Continued).**

3,313,119. SHEEHY, SUSAN M., NEW MILFORD, CT. SN 76-635,574. PUB. 7-18-2006, FILED 4-7-2005.

CLASS 28—TOYS AND SPORTING GOODS

3,313,039. EASTMAN, GARY L., SAN DIEGO, CA. SN 76-553,400. PUB. 8-17-2004, FILED 10-22-2003.

**THE BUG**

FOR SPORTING GOODS, NAMELY, BASEBALL BAT SWING TRAINING DEVICES (U.S. CLS. 22, 23, 38 AND 50).

FIRST USE 4-1-2007; IN COMMERCE 4-1-2007.

FOR BAGS SPECIALLY ADAPTED FOR SPORTS OR EXERCISE EQUIPMENT, NAMELY, GOLF BAGS, TENNIS BAGS AND YOGA BAGS (U.S. CLS. 22, 23, 38 AND 50).

FIRST USE 6-1-2005; IN COMMERCE 6-1-2005.

3,313,104. MILLERSPORT INC., COMMACK, NY. SN 76-631,539. PUB. 2-14-2006, FILED 2-18-2005.

3,313,165. LANGER, TODD A., LAFAYETTE, CO. SN 76-646,402. PUB. 5-23-2006, FILED 9-8-2005.

ALL TERRAIN BALL

THE MARK CONSISTS OF STANDARD CHARACTERS WITHOUT CLAIM TO ANY PARTICULAR FONT, STYLE, SIZE, OR COLOR.

NO CLAIM IS MADE TO THE EXCLUSIVE RIGHT TO USE "BALL", APART FROM THE MARK AS SHOWN.

FOR TOYS, NAMELY, SPORTS BALLS (U.S. CLS. 22, 23, 38 AND 50).

FIRST USE 3-19-2007; IN COMMERCE 3-19-2007.

P.A.S.T.

THE MARK CONSISTS OF STANDARD CHARACTERS WITHOUT CLAIM TO ANY PARTICULAR FONT, STYLE, SIZE, OR COLOR.

FOR EXERCISE EQUIPMENT, NAMELY PUSH-UP GRIPS, STRETCH CORDS FOR EXERCISE, AND BALANCE BOARD (U.S. CLS. 22, 23, 38 AND 50).

FIRST USE 2-18-2006; IN COMMERCE 2-18-2006.

3,313,110. GREENE PLASTICS CORPORATION, HOPE VALLEY, RI. SN 76-633,552. PUB. 5-9-2006, FILED 3-17-2005.

3,313,203. OUTERWEARS, INC., SCHOOLCRAFT, MI. SN 76-658,653. PUB. 12-5-2006, FILED 4-18-2006.

BEADS-N-BEAMS

THE MARK CONSISTS OF STANDARD CHARACTERS WITHOUT CLAIM TO ANY PARTICULAR FONT, STYLE, SIZE, OR COLOR.

FOR TOY CONSTRUCTION SETS CONSISTING OF PIECES USING STRAIGHT AND CURVED SEGMENTS, CONNECTORS, SPOOLS, WHEELS, HUBS, RINGS, AND BEADS, ALL OF VARIOUS SIZES, SHAPES, AND COLORS (U.S. CLS. 22, 23, 38 AND 50).

FIRST USE 3-29-2006; IN COMMERCE 3-29-2006.

SKATEJACKETS

THE MARK CONSISTS OF STANDARD CHARACTERS WITHOUT CLAIM TO ANY PARTICULAR FONT, STYLE, SIZE, OR COLOR.

FOR COVERS FOR ICE SKATE BLADES (U.S. CLS. 22, 23, 38 AND 50).

FIRST USE 4-20-2006; IN COMMERCE 4-20-2006.

CLASS 28—(Continued).

3,313,252. WINDSWELL DESIGNS, LLC, CARY, NC. SN 77-005,283. PUB. 5-8-2007, FILED 9-22-2006.



THE MARK CONSISTS OF A STYLIZED HUMAN FIGURE OVERLAYED ON A CIRCLE WITH A SMALLER DIAMETER CIRCLE ON CENTER, AND THE STYLIZED CAPITAL LETTERS FATHOM BELOW THE FIGURE AND CIRCLES ON CENTER.

FOR BAGS ESPECIALLY DESIGNED FOR SURFBOARDS; SURFBOARD FINS; SURFBOARD LEASHES; SURFBOARD WAX; SURFBOARDS (U.S. CLS. 22, 23, 38 AND 50).

FIRST USE 10-20-2006; IN COMMERCE 10-20-2006.

3,313,285. SHIMANO INC., SAKAI CITY, JAPAN. SN 77-017,442. PUB. 3-13-2007, FILED 10-10-2006.

SAROS

THE MARK CONSISTS OF THE STYLIZED WORD "SAROS".

FOR FISHING REELS; FISHING TACKLE (U.S. CLS. 22, 23, 38 AND 50).

FIRST USE 7-11-2007; IN COMMERCE 7-11-2007.

CLASS 28—(Continued).

3,313,310. THOMSON, EDWARD M. JR., SAN BERNARDINO, CA. SN 77-030,853. PUB. 5-29-2007, FILED 10-27-2006.

GRAMPASKITS.COM

THE MARK CONSISTS OF STANDARD CHARACTERS WITHOUT CLAIM TO ANY PARTICULAR FONT, STYLE, SIZE, OR COLOR.

FOR CHILDREN'S MULTIPLE ACTIVITY TOYS (U.S. CLS. 22, 23, 38 AND 50).

FIRST USE 1-1-2007; IN COMMERCE 8-29-2007.

3,313,365. T-INK, INC., NEW YORK, NY. SN 78-188,995. PUB. 2-3-2004, FILED 11-26-2002.

INKERACTIVE

FOR TOYS, GAMES AND PROMOTIONAL ITEMS FOR TOYS AND GAMES, NAMELY, HAND HELD UNIT FOR PLAYING ELECTRONIC GAMES, BATTERY OPERATED ACTION TOYS AND EDUCATIONAL LEARNING TOYS (U.S. CLS. 22, 23, 38 AND 50).

FIRST USE 9-1-2003; IN COMMERCE 9-1-2003.

3,313,368. NISSAN JIDOSHA KABUSHIKI KAISHA, TA NISSAN MOTOR CO., LTD., TOKYO, JAPAN. SN 78-196,734. PUB. 2-17-2004, FILED 12-20-2002.

NISMO

OWNER OF U.S. REG. NO. 1,536,313.
FOR TOYS AND PLAYTHINGS, NAMELY, TOY VEHICLES, MODEL VEHICLES AND RELATED ACCESSORIES SOLD AS A UNIT (U.S. CLS. 22, 23, 38 AND 50).

FIRST USE 6-30-2006; IN COMMERCE 6-30-2006.

CLASS 28—(Continued).

3,313,372. SOP SERVICES, INC., LAS VEGAS, NV. SN 78-228,132. PUB. 7-5-2005, FILED 3-20-2003.

XI SPORTS

OWNER OF U.S. REG. NO. 1,547,510.
NO CLAIM IS MADE TO THE EXCLUSIVE RIGHT TO USE "SPORTS", APART FROM THE MARK AS SHOWN.

FOR DARTS, BILLIARD CUES, BILLIARD CUE CASES, AND BILLIARD GAME PLAYING EQUIPMENT; GAME TABLES, NAMELY, HOCKEY TABLES, HOCKEY MALLETS AND PUCKS, AND HOCKEY TABLE GAME PLAYING EQUIPMENT; GAME TABLES, NAMELY, SOCCER TABLES AND SOCCER TABLE GAME PLAYING EQUIPMENT; MULTI-GAME TABLES AND GAME PLAYING EQUIPMENT, NAMELY, SOCCER, HOCKEY, BILLIARDS, TABLE TENNIS, BOWLING, SHUFFLE BOARD, CHESS, CHECKERS, BACKGAMMON AND CARD PLAYING EQUIPMENT; TABLE TENNIS RACKETS, TABLE TENNIS BALLS, NETS, AND TABLE TENNIS GAME PLAYING EQUIPMENT (U.S. CLS. 22, 23, 38 AND 50).

FIRST USE 10-0-2004; IN COMMERCE 10-0-2004.

3,313,425. NEPTUNE RESEARCH GROUP, INC., SAMMAMISH, WA. SN 78-367,409. PUB. 7-12-2005, FILED 2-12-2004.

FOLD YOUR BRAIN

THE MARK CONSISTS OF STANDARD CHARACTERS WITHOUT CLAIM TO ANY PARTICULAR FONT, STYLE, SIZE, OR COLOR.

FOR TOYS, NAMELY, HOBBY CRAFT KITS FOR ORIGAMI FOLDING AND MAKING ORIGAMI FIGURES AND FIGURINES (U.S. CLS. 22, 23, 38 AND 50).

FIRST USE 1-0-2004; IN COMMERCE 7-0-2004.

3,313,456. LITTLE TIKES COMPANY, THE, FREEPORT, IL. SN 78-430,816. PUB. 9-13-2005, FILED 6-7-2004.

ENDLESS ADVENTURES

THE MARK CONSISTS OF STANDARD CHARACTERS WITHOUT CLAIM TO ANY PARTICULAR FONT, STYLE, SIZE, OR COLOR.

FOR OUTDOOR PLAYGROUND EQUIPMENT COMPRISING SWING SETS AND CLIMBERS (U.S. CLS. 22, 23, 38 AND 50).

FIRST USE 12-31-2004; IN COMMERCE 12-31-2004.

CLASS 28—(Continued).

3,313,461. MATTEL, INC., EL SEGUNDO, CA. SN 78-437,370. PUB. 10-11-2005, FILED 6-17-2004.

HOT BIRD

THE MARK CONSISTS OF STANDARD CHARACTERS WITHOUT CLAIM TO ANY PARTICULAR FONT, STYLE, SIZE, OR COLOR.

FOR TOYS, GAMES AND PLAYTHINGS, NAMELY, TOY VEHICLES AND ACCESSORIES THEREFOR (U.S. CLS. 22, 23, 38 AND 50).

FIRST USE 12-31-2006; IN COMMERCE 12-31-2006.

3,313,503. MADSHUS A/S, BIRI, NORWAY. SN 78-493,256. PUB. 9-13-2005, FILED 10-1-2004.

NANOSONIC

THE MARK CONSISTS OF STANDARD CHARACTERS WITHOUT CLAIM TO ANY PARTICULAR FONT, STYLE, SIZE, OR COLOR.

FOR NORDIC SKIS (U.S. CLS. 22, 23, 38 AND 50).

FIRST USE 12-1-2006; IN COMMERCE 12-1-2006.

CLASS 28—(Continued).

3,313,510. JONES, LORRAINE WELLEN, BOYDS, MD. SN 78-504,175. PUB. 10-4-2005, FILED 10-22-2004.

JOZA

THE MARK CONSISTS OF STANDARD CHARACTERS WITHOUT CLAIM TO ANY PARTICULAR FONT, STYLE, SIZE, OR COLOR.

FOR CARD GAMES (U.S. CLS. 22, 23, 38 AND 50).
FIRST USE 4-21-2007; IN COMMERCE 4-21-2007.

3,313,612. DC COMICS, NEW YORK, NY. SN 78-595,165. PUB. 12-27-2005, FILED 3-25-2005.

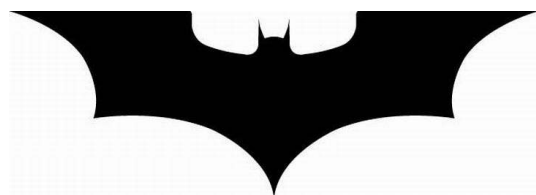

THE MARK CONSISTS OF DESIGN OF BAT.
FOR TOYS AND SPORTING GOODS, INCLUDING GAMES AND PLAYTHINGS— NAMELY, ACTION FIGURES AND ACCESSORIES THEREFOR; PLUSH TOYS; BALLOONS; EQUIPMENT SOLD AS A UNIT FOR PLAYING CARD GAMES; TOY VEHICLES; DOLLS; FLYING DISCS; ELECTRONIC HAND-HELD GAME UNIT; GAME EQUIPMENT SOLD AS A UNIT FOR PLAYING A BOARD GAME, A CARD GAME, A MANIPULATIVE GAME, A PARLOR GAME AND AN ACTION TYPE TARGET GAME; JIGSAW AND MANIPULATIVE PUZZLES; SKATEBOARDS; BALLS— NAMELY, PLAYGROUND BALLS, BASEBALLS, BASEBALL GLOVES; SWIMMING FLOATS FOR RECREATIONAL USE; KICKBOARD FLOTATION DEVICES FOR RECREATIONAL USE; SWIM BOARDS FOR RECREATIONAL USE; SWIM FINS; TOY BANKS; AND CHRISTMAS TREE ORNAMENTS (U.S. CLS. 22, 23, 38 AND 50).
FIRST USE 6-0-2005; IN COMMERCE 6-0-2005.

CLASS 28—(Continued).

3,313,640. JANE MYERS DREW PH.D. A PSYCHOLOGY CORPORATION, NEWPORT BEACH, CA. SN 78-610,290. PUB. 1-17-2006, FILED 4-15-2005.

LET'S CONNECT!

THE MARK CONSISTS OF STANDARD CHARACTERS WITHOUT CLAIM TO ANY PARTICULAR FONT, STYLE, SIZE, OR COLOR.

FOR PARTY GAMES; CARD GAMES; EQUIPMENT SOLD AS A UNIT FOR PLAYING PARTY GAMES AND CARD GAMES, NAMELY QUESTION AND ANSWER CARDS (U.S. CLS. 22, 23, 38 AND 50).
FIRST USE 10-8-2006; IN COMMERCE 10-8-2006.

3,313,657. YOKOMI, DARRICK, FOUNTAIN VALLEY, CA. SN 78-617,009. PUB. 8-1-2006, FILED 4-26-2005.



THE STIPPLING IS A FEATURE OF THE MARK.
THE MARK CONSISTS OF THE TEXT "BATTLE ROC", WITH STYLIZED AXES FORMING THE "T'S IN THE WORD "BATTLE" AND A STYLIZED GEM STONE FORMING THE "O" IN THE WORD "ROC".

FOR ACTION SKILL GAMES; EQUIPMENT SOLD AS A UNIT FOR PLAYING ACTION TYPE TARGET GAMES; ROLE PLAYING GAMES; TARGET GAMES (U.S. CLS. 22, 23, 38 AND 50).
FIRST USE 4-14-2006; IN COMMERCE 4-25-2006.

3,313,664. ASSOCIATED ELECTRICS, INC., COSTA MESA, CA. SN 78-619,321. PUB. 9-12-2006, FILED 4-28-2005.

FACTORY TEAM

THE MARK CONSISTS OF STANDARD CHARACTERS WITHOUT CLAIM TO ANY PARTICULAR FONT, STYLE, SIZE, OR COLOR.

FOR RADIO CONTROLLED TOY CARS AND RELATED ACCESSORIES THEREFOR (U.S. CLS. 22, 23, 38 AND 50).
FIRST USE 12-15-1998; IN COMMERCE 12-15-1998.

CLASS 28—(Continued).

3,313,721. LINKS CHOICE LLC, SCOTTSVILLE, VA. SN 78-642,874. PUB. 10-25-2005, FILED 6-3-2005.

TEE IT AGAIN

THE MARK CONSISTS OF STANDARD CHARACTERS WITHOUT CLAIM TO ANY PARTICULAR FONT, STYLE, SIZE, OR COLOR.

FOR GOLF BALLS, USED GOLF BALLS, RECONDITIONED GOLF BALLS AND REFURBISHED GOLF BALLS (U.S. CLS. 22, 23, 38 AND 50).

FIRST USE 1-0-2005; IN COMMERCE 1-0-2005.

CLASS 28—(Continued).

3,313,808. MATTEL, INC., EL SEGUNDO, CA. SN 78-680,954. PUB. 10-10-2006, FILED 7-28-2005.

PREYING MENACE

THE MARK CONSISTS OF STANDARD CHARACTERS WITHOUT CLAIM TO ANY PARTICULAR FONT, STYLE, SIZE, OR COLOR.

FOR TOYS, GAMES AND PLAYTHINGS, NAMELY, TOY VEHICLES AND ACCESSORIES THEREFOR (U.S. CLS. 22, 23, 38 AND 50).

FIRST USE 12-31-2006; IN COMMERCE 12-31-2006.

3,313,748. HARRIS COMPANIES, LLC, SPANISH FORT, AL. SN 78-654,493. PUB. 9-12-2006, FILED 6-20-2005.

Edgefield

THE MARK CONSISTS OF STANDARD CHARACTERS WITHOUT CLAIM TO ANY PARTICULAR FONT, STYLE, SIZE, OR COLOR.

FOR HUNTING EQUIPMENT, NAMELY SCENT DISPENSERS FOR ATTRACTING OR REPELLING ANIMALS, ANIMAL ATTRACTANT SCENTS, HUNTING SCENT CAMOUFLAGE, HUNTING SCENT LURE (U.S. CLS. 22, 23, 38 AND 50).

FIRST USE 10-1-2003; IN COMMERCE 10-1-2003.

3,313,814. PURE FISHING, INC., SPIRIT LAKE, IA. SN 78-683,273. PUB. 4-25-2006, FILED 8-2-2005.

EASY CLIP

THE MARK CONSISTS OF STANDARD CHARACTERS WITHOUT CLAIM TO ANY PARTICULAR FONT, STYLE, SIZE, OR COLOR.

NO CLAIM IS MADE TO THE EXCLUSIVE RIGHT TO USE "CLIP", APART FROM THE MARK AS SHOWN.

FOR TERMINAL TACKLE, NAMELY, CONNECTORS FOR THE TERMINAL END OF FISHING LINE (U.S. CLS. 22, 23, 38 AND 50).

FIRST USE 3-1-2004; IN COMMERCE 9-1-2004.

3,313,797. HIREKO TRADING COMPANY, INC., CITY OF INDUSTRY, CA. SN 78-675,825. PUB. 5-8-2007, FILED 7-21-2005.

OBSESSION

THE MARK CONSISTS OF STANDARD CHARACTERS WITHOUT CLAIM TO ANY PARTICULAR FONT, STYLE, SIZE, OR COLOR.

FOR GOLF CLUBS AND STRUCTURAL COMPONENTS THEREOF, INCLUDING GOLF CLUB HEADS, SHAFTS AND GRIPS (U.S. CLS. 22, 23, 38 AND 50).

FIRST USE 5-0-2006; IN COMMERCE 5-0-2006.

3,313,836. THINKING TECHNOLOGY INC., NASSAU, BAHAMAS. SN 78-696,357. PUB. 8-15-2006, FILED 8-19-2005.

AQUA ZOOMBAS

THE MARK CONSISTS OF STANDARD CHARACTERS WITHOUT CLAIM TO ANY PARTICULAR FONT, STYLE, SIZE, OR COLOR.

NO CLAIM IS MADE TO THE EXCLUSIVE RIGHT TO USE "AQUA", APART FROM THE MARK AS SHOWN.

FOR TOYS, NAMELY, BATTERY-OPERATED, PROPELLER-DRIVEN WATER TOYS (U.S. CLS. 22, 23, 38 AND 50).

FIRST USE 12-1-2005; IN COMMERCE 12-1-2005.

CLASS 28—(Continued).

3,313,893. SHOWDOWN CREATIONS, INC., SAN ANTONIO, TX. SN 78-715,649. PUB. 12-5-2006, FILED 9-19-2005.

Texas Showdown

THE MARK CONSISTS OF STANDARD CHARACTERS WITHOUT CLAIM TO ANY PARTICULAR FONT, STYLE, SIZE, OR COLOR.

NO CLAIM IS MADE TO THE EXCLUSIVE RIGHT TO USE "TEXAS", APART FROM THE MARK AS SHOWN. FOR BOARD GAMES (U.S. CLS. 22, 23, 38 AND 50). FIRST USE 12-31-1992; IN COMMERCE 1-1-2007.

3,313,921. SAN FRANCISCO BASEBALL ASSOCIATES L.P., SAN FRANCISCO, CA. SN 78-729,862. PUB. 6-27-2006, FILED 10-10-2005.



OWNER OF U.S. REG. NOS. 1,340,707, 1,661,650, AND OTHERS.

FOR TOYS AND SPORTING GOODS, NAMELY STUFFED TOYS, PLUSH TOYS, FOAM TOYS, FOAM NOVELTY ITEMS, NAMELY, FOAM FINGERS, BALLOONS, CHECKER SETS, CHESS SETS, DOMINOES, BOARD GAMES, CARD GAMES, PLAYING CARDS, DART BOARDS AND DART BOARD ACCESSORIES, NAMELY, DARTS, DART SHAFTS AND DART FLIGHTS, TOY CARS AND TRUCKS, TOY MOBILES, JIGSAW AND MANIPULATIVE PUZZLES, YO-YO'S, TOY BANKS, TOY FIGURES, TOY VEHICLES, DOLLS AND DOLL ACCESSORIES, BOBBING HEAD DOLLS, INFLATABLE BASEBALL BATS, DECORATIVE WIND SOCKS, MINIATURE BASEBALL BATS, MINI BATTING HELMET REPLICAS, TOY NECKLACES, MINIATURE TOY BASEBALLS, BASEBALLS, HOLDERS FOR BASEBALLS, AUTOGRAPHED BASEBALLS, PLAYGROUND BALLS, RUBBER ACTION BALLS, GOLF BALLS, GOLF CLUB HEAD COVERS, GOLF CLUB BAGS, GOLF PUTTERS, BILLIARD ACCESSORIES, NAMELY, CUES, BILLIARD BALLS, BASEBALL BASES, BASEBALL BATS, CATCHER'S MASKS, BATTING GLOVES, BASEBALL GLOVES, INFLATABLE TOYS; COSTUME MASKS; CHRISTMAS TREE ORNAMENTS, EXCLUDING CONFECTIONERY AND ILLUMINATION ARTICLES, AND CHRISTMAS STOCKINGS (U.S. CLS. 22, 23, 38 AND 50). FIRST USE 4-0-1996; IN COMMERCE 4-0-1996.

CLASS 28—(Continued).

3,314,020. MATTEL, INC., EL SEGUNDO, CA. SN 78-755,024. PUB. 1-9-2007, FILED 11-16-2005.

MOTOBLADE

THE MARK CONSISTS OF STANDARD CHARACTERS WITHOUT CLAIM TO ANY PARTICULAR FONT, STYLE, SIZE, OR COLOR.

FOR TOYS, GAMES AND PLAYTHINGS, NAMELY, TOY VEHICLES AND ACCESSORIES THEREFOR (U.S. CLS. 22, 23, 38 AND 50).

FIRST USE 12-31-2006; IN COMMERCE 12-31-2006.

3,314,049. LEARNING RESOURCES, INC., VERNON HILLS, IL. SN 78-761,865. PUB. 12-26-2006, FILED 11-28-2005.

SMART SAFARI

THE MARK CONSISTS OF STANDARD CHARACTERS WITHOUT CLAIM TO ANY PARTICULAR FONT, STYLE, SIZE, OR COLOR.

OWNER OF U.S. REG. NO. 2,799,341.

FOR MANIPULATIVES IN THE NATURE OF A TOY OR A GAME AND PRINTED ACTIVITY GUIDES FOR TEACHING LETTERS, COUNTING AND SHAPES ALL SOLD AS A UNIT (U.S. CLS. 22, 23, 38 AND 50).

FIRST USE 2-21-2006; IN COMMERCE 2-21-2006.

3,314,059. JARYL INTERNATIONAL INC., ORADELL, NJ. SN 78-764,133. PUB. 8-1-2006, FILED 11-30-2005.



THE MARK CONSISTS OF STANDARD CHARACTERS WITHOUT CLAIM TO ANY PARTICULAR FONT, STYLE, SIZE, OR COLOR.

FOR RADIO CONTROLLED TOY AND HOBBY AIRCRAFT, LAND, AND WATER VEHICLES, AND PARTS AND ACCESSORIES THEREFOR (U.S. CLS. 22, 23, 38 AND 50).

FIRST USE 4-16-2007; IN COMMERCE 4-16-2007.

CLASS 28—(Continued).

3,314,061. JARYL INTERNATIONAL, INC., ORADELL, NJ. SN 78-764,138. PUB. 8-1-2006, FILED 11-30-2005.

HIGHDEFINITIONR/C

THE MARK CONSISTS OF STANDARD CHARACTERS WITHOUT CLAIM TO ANY PARTICULAR FONT, STYLE, SIZE, OR COLOR.

FOR RADIO CONTROLLED TOY AND HOBBY AIRCRAFT, LAND, AND WATER VEHICLES, AND PARTS AND ACCESSORIES THEREFOR (U.S. CLS. 22, 23, 38 AND 50).

FIRST USE 4-16-2007; IN COMMERCE 4-16-2007.

CLASS 28—(Continued).

3,314,176. ELMER'S PRODUCTS, INC., COLUMBUS, OH. SN 78-781,823. PUB. 3-20-2007, FILED 12-28-2005.

DISGUSTING ANATOMY BRAIN

THE MARK CONSISTS OF STANDARD CHARACTERS WITHOUT CLAIM TO ANY PARTICULAR FONT, STYLE, SIZE, OR COLOR.

NO CLAIM IS MADE TO THE EXCLUSIVE RIGHT TO USE "ANATOMY BRAIN", APART FROM THE MARK AS SHOWN.

FOR TOYS AND PLAYTHINGS, NAMELY SCIENCE AND ACTIVITY KITS FOR CHILDREN (U.S. CLS. 22, 23, 38 AND 50).

FIRST USE 6-14-2006; IN COMMERCE 6-14-2006.

3,314,064. THREE RIDGES, LLC, BREVARD, NC. SN 78-764,452. PUB. 8-8-2006, FILED 12-1-2005.

VIBRATEASE

THE MARK CONSISTS OF STANDARD CHARACTERS WITHOUT CLAIM TO ANY PARTICULAR FONT, STYLE, SIZE, OR COLOR.

FOR VIBRATION EMITTING DEVICE FOR VIBRATING A FISHING ROD, FISHING LINE, FISH BAIT AND FISHING LURE (U.S. CLS. 22, 23, 38 AND 50).

FIRST USE 8-27-2006; IN COMMERCE 8-27-2006.

3,314,177. ELMER'S PRODUCTS, INC., COLUMBUS, OH. SN 78-781,826. PUB. 3-20-2007, FILED 12-28-2005.

DISGUSTING ANATOMY HEART

THE MARK CONSISTS OF STANDARD CHARACTERS WITHOUT CLAIM TO ANY PARTICULAR FONT, STYLE, SIZE, OR COLOR.

NO CLAIM IS MADE TO THE EXCLUSIVE RIGHT TO USE "ANATOMY HEART", APART FROM THE MARK AS SHOWN.

FOR TOYS AND PLAYTHINGS, NAMELY, SCIENCE AND ACTIVITY KITS FOR CHILDREN (U.S. CLS. 22, 23, 38 AND 50).

FIRST USE 6-14-2006; IN COMMERCE 6-14-2006.

3,314,168. FIELD LOGIC, INC., SUPERIOR, WI. SN 78-780,071. PUB. 8-29-2006, FILED 12-23-2005.

RAGE

THE MARK CONSISTS OF STANDARD CHARACTERS WITHOUT CLAIM TO ANY PARTICULAR FONT, STYLE, SIZE, OR COLOR.

FOR ARCHERY ARROWS (U.S. CLS. 22, 23, 38 AND 50).

FIRST USE 6-19-2006; IN COMMERCE 6-19-2006.

3,314,233. PURE FISHING, INC., SPIRIT LAKE, IA. SN 78-792,461. PUB. 8-1-2006, FILED 1-16-2006.

REVO

THE MARK CONSISTS OF STANDARD CHARACTERS WITHOUT CLAIM TO ANY PARTICULAR FONT, STYLE, SIZE, OR COLOR.

FOR FISHING REELS (U.S. CLS. 22, 23, 38 AND 50).

FIRST USE 1-0-2006; IN COMMERCE 7-0-2006.

CLASS 28—(Continued).

3,314,271. GOLF INNOVATIONS, LLC, CORDOVA, TN. SN 78-798,076. PUB. 9-19-2006, FILED 1-24-2006.

BallBrella

THE MARK CONSISTS OF STANDARD CHARACTERS WITHOUT CLAIM TO ANY PARTICULAR FONT, STYLE, SIZE, OR COLOR.

FOR COMBINATION GOLF UMBRELLA AND GOLF BALL RETRIEVER (U.S. CLS. 22, 23, 38 AND 50).
FIRST USE 1-0-2006; IN COMMERCE 1-0-2006.

CLASS 28—(Continued).

3,314,322. JAKKS PACIFIC, INC., MALIBU, CA. SN 78-809,246. PUB. 10-3-2006, FILED 2-7-2006.

POWER BOOSTER

THE MARK CONSISTS OF STANDARD CHARACTERS WITHOUT CLAIM TO ANY PARTICULAR FONT, STYLE, SIZE, OR COLOR.

FOR TOYS GAMES AND PLAYTHINGS, NAMELY, TOY VEHICLES AND ACCESSORIES THEREFOR; RADIO CONTROLLED TOY VEHICLES (U.S. CLS. 22, 23, 38 AND 50).
FIRST USE 10-6-2006; IN COMMERCE 10-6-2006.

3,314,292. ALIPIO, BYRON P., DICKINSON, TX. SN 78-803,330. PUB. 5-8-2007, FILED 1-31-2006.



THE ENGLISH TRANSLATION OF THE WORD JAMBO IN THE MARK IS "HELLO".

FOR GAMES, PLAYTHINGS, AND TOYS, NAMELY, BOARD GAMES FOR SIMULATING FOOTBALL GAMES (U.S. CLS. 22, 23, 38 AND 50).
FIRST USE 6-30-2006; IN COMMERCE 6-30-2006.

3,314,359. HEIDEN, MICHAEL, WOODCLIFF LAKE, NJ. SN 78-815,964. PUB. 9-19-2006, FILED 2-15-2006.

Glow Train

THE MARK CONSISTS OF STANDARD CHARACTERS WITHOUT CLAIM TO ANY PARTICULAR FONT, STYLE, SIZE, OR COLOR.

NO CLAIM IS MADE TO THE EXCLUSIVE RIGHT TO USE "TRAIN", APART FROM THE MARK AS SHOWN.
FOR TOYS, GAMES, AND PLAYTHINGS, NAMELY, TOY TRAINS, TOY TRAIN TRACK SETS, TOY TRAIN PLAYSETS AND ACCESSORIES FOR ALL OF THE FOREGOING (U.S. CLS. 22, 23, 38 AND 50).
FIRST USE 10-3-2006; IN COMMERCE 10-3-2006.

3,314,305. PLAYMATES TOYS INC., COSTA MESA, CA. SN 78-806,312. PUB. 9-26-2006, FILED 2-3-2006.

R.E.V.'S RADICALLY ENGINEERED VEHICLES

THE MARK CONSISTS OF STANDARD CHARACTERS WITHOUT CLAIM TO ANY PARTICULAR FONT, STYLE, SIZE, OR COLOR.

NO CLAIM IS MADE TO THE EXCLUSIVE RIGHT TO USE "VEHICLES", APART FROM THE MARK AS SHOWN.
FOR TOY VEHICLES AND ACCESSORIES THEREFOR (U.S. CLS. 22, 23, 38 AND 50).
FIRST USE 10-0-2005; IN COMMERCE 11-0-2006.

3,314,365. CABOODLE! TOYS LLC, NEW YORK, NY. SN 78-817,420. PUB. 9-5-2006, FILED 2-17-2006.

Noah's Pals

THE MARK CONSISTS OF STANDARD CHARACTERS WITHOUT CLAIM TO ANY PARTICULAR FONT, STYLE, SIZE, OR COLOR.

FOR COLLECTABLE TOY FIGURES; MODELED PLASTIC TOY FIGURINES; MOLDED TOY FIGURES; TOY ANIMALS AND ACCESSORIES THEREFOR; TOY FIGURES (U.S. CLS. 22, 23, 38 AND 50).
FIRST USE 1-26-2007; IN COMMERCE 1-26-2007.

CLASS 28—(Continued).

3,314,378. KLUGE, ERIC M, BAMBERG, FED REP GER-MANY. SN 78-818,564. PUB. 10-10-2006, FILED 2-19-2006.



FOR PLUSH TOYS (U.S. CLS. 22, 23, 38 AND 50).
FIRST USE 1-28-2007; IN COMMERCE 1-28-2007.

3,314,393. JAKKS PACIFIC, INC., MALIBU, CA. SN 78-821,280. PUB. 9-26-2006, FILED 2-23-2006.

TOTALLY TAYLOR

THE MARK CONSISTS OF STANDARD CHARACTERS WITHOUT CLAIM TO ANY PARTICULAR FONT, STYLE, SIZE, OR COLOR.
OWNER OF U.S. REG. NO. 1,916,630.
FOR DOLLS AND ACCESSORIES THEREFOR (U.S. CLS. 22, 23, 38 AND 50).
FIRST USE 5-13-2006; IN COMMERCE 5-13-2006.

3,314,406. PURE FISHING, INC., SPIRIT LAKE, IA. SN 78-822,981. PUB. 8-22-2006, FILED 2-24-2006.

G-STRING

THE MARK CONSISTS OF STANDARD CHARACTERS WITHOUT CLAIM TO ANY PARTICULAR FONT, STYLE, SIZE, OR COLOR.
FOR FISHING LINE (U.S. CLS. 22, 23, 38 AND 50).
FIRST USE 3-9-2006; IN COMMERCE 6-30-2006.

CLASS 28—(Continued).

3,314,438. JOHNSON, CHRISTY M., RICHMOND, TX. SN 78-830,941. PUB. 10-24-2006, FILED 3-7-2006.



FOR GREETING BALLS/NOVELTY ITEM- NAMELY PLASTIC CHILDREN'S PLAY BALLS IMPRINTED WITH MESSAGES AND ARTWORK REGARDING A PARTICULAR OCCASION OR THEME (U.S. CLS. 22, 23, 38 AND 50).
FIRST USE 2-15-2006; IN COMMERCE 7-11-2006.

3,314,484. ROCKWOOD, AMY, MODESTO, CA. SN 78-846,736. PUB. 11-14-2006, FILED 3-27-2006.

GOUGHNUTS

THE MARK CONSISTS OF STANDARD CHARACTERS WITHOUT CLAIM TO ANY PARTICULAR FONT, STYLE, SIZE, OR COLOR.
FOR PET PRODUCTS, NAMELY, CHEW TOYS MADE OF RUBBER (U.S. CLS. 22, 23, 38 AND 50).
FIRST USE 1-1-2007; IN COMMERCE 4-1-2007.

3,314,533. DAIWA SEIKO, INC., TOKYO, JAPAN. SN 78-865,713. PUB. 1-2-2007, FILED 4-20-2006.

I'ZE FACTORY

THE MARK CONSISTS OF STANDARD CHARACTERS WITHOUT CLAIM TO ANY PARTICULAR FONT, STYLE, SIZE, OR COLOR.
FOR FISHING REELS, FISHING RODS, FISHING LURES, FISHING TACKLE BOX, FISHING SINKERS, FISHING FLOATS, FISHING LINES AND FISHING CREELS (U.S. CLS. 22, 23, 38 AND 50).
FIRST USE 7-0-2006; IN COMMERCE 7-0-2006.

CLASS 28—(Continued).

3,314,543. DEEGAN, BRIAN, TEMECULA, CA. SN 78-869,894. PUB. 11-28-2006, FILED 4-26-2006.

HEVY HITTERS

THE MARK CONSISTS OF STANDARD CHARACTERS WITHOUT CLAIM TO ANY PARTICULAR FONT, STYLE, SIZE, OR COLOR.

FOR HAND-HELD UNIT FOR PLAYING VIDEO GAMES; STAND-ALONE VIDEO GAME MACHINES; ACTION FIGURES AND ACCESSORIES THEREFOR; TOY MODEL VEHICLES, NAMELY, MOTORCROSS BIKES AND MOTORCYCLES, AND RELATED ACCESSORIES SOLD AS UNITS; TOY MODEL CARS AND MOTORCYCLES; REMOTE CONTROL TOYS, NAMELY, MOTORCYCLES AND MOTORCROSS BIKES; SKATEBOARDS; AND SNOWBOARDS (U.S. CLS. 22, 23, 38 AND 50).

FIRST USE 1-31-2006; IN COMMERCE 1-31-2006.

3,314,599. LEAPFROG ENTERPRISES, INC., EMERYVILLE, CA. SN 78-886,125. PUB. 11-21-2006, FILED 5-17-2006.



THE MARK CONSISTS OF A TOWN CONSISTING OF THE SUN, CLOUDS, A DOOR, A FENSE, AND A WINDOW.

FOR TOYS AND PLAYTHINGS, NAMELY CHILDREN'S MULTIPLE ACTIVITY TOYS AND INTERACTIVE BLOCK SETS (U.S. CLS. 22, 23, 38 AND 50).

FIRST USE 8-24-2006; IN COMMERCE 8-24-2006.

3,314,607. TOBESMART, LLC, LITTLETON, CO. SN 78-887,907. PUB. 12-26-2006, FILED 5-19-2006.

Signing Simon

CLASS 28—(Continued).

THE MARK CONSISTS OF STANDARD CHARACTERS WITHOUT CLAIM TO ANY PARTICULAR FONT, STYLE, SIZE, OR COLOR.

NO CLAIM IS MADE TO THE EXCLUSIVE RIGHT TO USE "SIGNING", APART FROM THE MARK AS SHOWN.

FOR STUFFED PUPPETS (U.S. CLS. 22, 23, 38 AND 50). FIRST USE 5-19-2006; IN COMMERCE 9-30-2006.

3,314,625. BIBLEQUEST L.P., ARLINGTON, TX. SN 78-893,208. PUB. 12-26-2006, FILED 5-25-2006.

2 BY 2

THE MARK CONSISTS OF STANDARD CHARACTERS WITHOUT CLAIM TO ANY PARTICULAR FONT, STYLE, SIZE, OR COLOR.

FOR BOARD GAMES (U.S. CLS. 22, 23, 38 AND 50). FIRST USE 10-31-2006; IN COMMERCE 10-31-2006.

3,314,632. GLOBAL WASHERS LLC, SAN ANTONIO, TX. SN 78-896,003. PUB. 2-27-2007, FILED 5-30-2006.



NO CLAIM IS MADE TO THE EXCLUSIVE RIGHT TO USE "WASHERS", APART FROM THE MARK AS SHOWN.

THE COLOR(S) RED, BROWN, WHITE, YELLOW, GREEN AND BLACK IS/ARE CLAIMED AS A FEATURE OF THE MARK.

THE MARK CONSISTS OF THE WORD GLOBAL WASHERS IS SHADED IN BROWN AND WHITE WITH A BLACK OUTLINE AND THE "O" IN GLOBAL IS PORTRAYED AS A RED WASHER WITH BLACK SWOOSH AS IF BEING TOSSED. THE GAME BOARD IS GREEN ON TOP WITH A WHITE HOLE IN THE MIDDLE AND WHITE TRIM AROUND THE EDGES. THERE IS ALSO A YELLOW WASHER BEING TOSSED ONTO THE BOARD WITH A RED SWOOSH.

FOR OUTDOOR PORTABLE WASHER GAME SETS COMPRISING GAME BOARDS AND WASHERS SOLD AS A UNIT (U.S. CLS. 22, 23, 38 AND 50). FIRST USE 6-15-2007; IN COMMERCE 6-15-2007.

CLASS 28—(Continued).

3,314,660. MATTEL, INC., EL SEGUNDO, CA. SN 78-902,043.
PUB. 1-9-2007, FILED 6-6-2006.

PRINCESS BOUTIQUE

THE MARK CONSISTS OF STANDARD CHARACTERS WITHOUT CLAIM TO ANY PARTICULAR FONT, STYLE, SIZE, OR COLOR.

FOR TOYS, GAMES AND PLAYTHINGS, NAMELY, DOLL PLAYSETS AND ACCESSORIES THEREFOR (U.S. CLS. 22, 23, 38 AND 50).

FIRST USE 8-15-2007; IN COMMERCE 8-15-2007.



3,314,661. MATTEL, INC., EL SEGUNDO, CA. SN 78-902,086.
PUB. 2-27-2007, FILED 6-6-2006.

HULA-LICIOUS

THE MARK CONSISTS OF STANDARD CHARACTERS WITHOUT CLAIM TO ANY PARTICULAR FONT, STYLE, SIZE, OR COLOR.

FOR TOYS, GAMES AND PLAYTHINGS, NAMELY, DOLLS, DOLL CLOTHING AND DOLL ACCESSORIES, DOLL PLAYSETS, TOY FIGURES, AND ACCESSORIES FOR ALL OF THE FOREGOING (U.S. CLS. 22, 23, 38 AND 50).

FIRST USE 8-29-2007; IN COMMERCE 8-29-2007.



3,314,696. DONNA DOWNEY, LLC, HUNTERSVILLE, NC.
SN 78-909,703. PUB. 3-6-2007, FILED 6-16-2006.



THE NAME(S), PORTRAIT(S), AND/OR SIGNATURE(S) SHOWN IN THE MARK IDENTIFIES DONNA DOWNEY, WHOSE CONSENT(S) TO REGISTER IS SUBMITTED.

FOR HOBBY CRAFT KITS FOR SCRAPBOOKING COMPOSED PRIMARILY OF MINI-ALBUMS, BRADS, RIBBON, AND CARDBOARD (U.S. CLS. 22, 23, 38 AND 50).

FIRST USE 2-7-2007; IN COMMERCE 2-7-2007.

CLASS 28—(Continued).

3,314,702. MATTEL, INC., EL SEGUNDO, CA. SN 78-911,090.
PUB. 2-27-2007, FILED 6-19-2006.

BALLET-LICIOUS

THE MARK CONSISTS OF STANDARD CHARACTERS WITHOUT CLAIM TO ANY PARTICULAR FONT, STYLE, SIZE, OR COLOR.

FOR TOYS, GAMES AND PLAYTHINGS, NAMELY, DOLLS, DOLL CLOTHING AND DOLL ACCESSORIES, DOLL PLAYSETS, TOY FIGURES, AND ACCESSORIES FOR ALL OF THE FOREGOING (U.S. CLS. 22, 23, 38 AND 50).

FIRST USE 3-19-2007; IN COMMERCE 3-19-2007.



3,314,710. CALLAWAY GOLF COMPANY, CARLSBAD, CA.
SN 78-913,003. PUB. 5-8-2007, FILED 6-21-2006.

CX3

THE MARK CONSISTS OF STANDARD CHARACTERS WITHOUT CLAIM TO ANY PARTICULAR FONT, STYLE, SIZE, OR COLOR.

FOR GOLF BALLS (U.S. CLS. 22, 23, 38 AND 50).
FIRST USE 11-21-2006; IN COMMERCE 11-21-2006.



3,314,711. CALLAWAY GOLF COMPANY, CARLSBAD, CA.
SN 78-913,016. PUB. 5-8-2007, FILED 6-21-2006.

CXB

THE MARK CONSISTS OF STANDARD CHARACTERS WITHOUT CLAIM TO ANY PARTICULAR FONT, STYLE, SIZE, OR COLOR.

FOR GOLF BALLS (U.S. CLS. 22, 23, 38 AND 50).
FIRST USE 11-13-2006; IN COMMERCE 11-13-2006.

CLASS 28—(Continued).

3,314,718. TOY STATE INDUSTRIAL LTD., TSTE, KOW-
LOON, HONG KONG. SN 78-916,513. PUB. 2-13-2007,
FILED 6-26-2006.

RIM ROCKERS

THE MARK CONSISTS OF STANDARD CHARACTERS
WITHOUT CLAIM TO ANY PARTICULAR FONT, STYLE,
SIZE, OR COLOR.

FOR TOY VEHICLES (U.S. CLS. 22, 23, 38 AND 50).
FIRST USE 5-28-2007; IN COMMERCE 5-28-2007.

3,314,794. KLEINSPORTS LLC, MONTGOMERY, IL. SN 78-
942,158. PUB. 3-13-2007, FILED 8-1-2006.

CABLENET

THE MARK CONSISTS OF STANDARD CHARACTERS
WITHOUT CLAIM TO ANY PARTICULAR FONT, STYLE,
SIZE, OR COLOR.

FOR BASKETBALL NETS (U.S. CLS. 22, 23, 38 AND
50).
FIRST USE 1-1-2007; IN COMMERCE 1-1-2007.

3,314,817. WALSH, STEPHEN W., BRIDGTON, ME. SN 78-
951,359. PUB. 4-3-2007, FILED 8-14-2006.

PUTTLINE

THE MARK CONSISTS OF STANDARD CHARACTERS
WITHOUT CLAIM TO ANY PARTICULAR FONT, STYLE,
SIZE, OR COLOR.

FOR GOLF CLUB SWING AIDS, NAMELY CLUB
ATTACHMENTS FOR USE IN DEVELOPING A CON-
SISTENTLY PROPER SWING (U.S. CLS. 22, 23, 38 AND
50).
FIRST USE 1-27-2007; IN COMMERCE 1-27-2007.

CLASS 28—(Continued).

3,314,865. EXTREME TECHNOLOGIES, INC., DBA BOW-
TECH, EUGENE, OR. SN 78-964,784. PUB. 4-24-2007, FILED
8-31-2006.

AIROW GUN

THE MARK CONSISTS OF STANDARD CHARACTERS
WITHOUT CLAIM TO ANY PARTICULAR FONT, STYLE,
SIZE, OR COLOR.

NO CLAIM IS MADE TO THE EXCLUSIVE RIGHT TO
USE "GUN", APART FROM THE MARK AS SHOWN.

FOR ARCHERY EQUIPMENT, NAMELY, A PNEU-
MATIC DEVICE ATTACHED TO AN ARCHERY BOW
FOR SHOOTING SMALL PROJECTILES (U.S. CLS. 22, 23,
38 AND 50).

FIRST USE 10-0-2006; IN COMMERCE 10-0-2006.

3,314,866. EATON CORPORATION, CLEVELAND, OH. SN
78-965,098. PUB. 2-13-2007, FILED 8-31-2006.

DD2

THE MARK CONSISTS OF STANDARD CHARACTERS
WITHOUT CLAIM TO ANY PARTICULAR FONT, STYLE,
SIZE, OR COLOR.

FOR GOLF CLUB GRIPS, HANDLE GRIPS FOR
SPORTING EQUIPMENT (U.S. CLS. 22, 23, 38 AND 50).
FIRST USE 1-24-2007; IN COMMERCE 1-24-2007.

3,314,878. OWNER AMERICAN CORP., COSTA MESA, CA.
SN 78-967,449. PUB. 4-24-2007, FILED 9-5-2006.

TWISTLOCK

THE MARK CONSISTS OF STANDARD CHARACTERS
WITHOUT CLAIM TO ANY PARTICULAR FONT, STYLE,
SIZE, OR COLOR.

FOR FISHING HOOKS; FISHING LEADERS; FISHING
LURES; FISHING LURES, NAMELY, PLASTIC WORMS;
FISHING TACKLE; LURES FOR FISHING (U.S. CLS. 22,
23, 38 AND 50).

FIRST USE 5-1-2007; IN COMMERCE 5-1-2007.

CLASS 28—(Continued).

3,314,910. MUPPETS STUDIO, LLC, THE, BURBANK, CA. SN 78-978,908. PUB. 9-19-2006, FILED 5-23-2005.

MUPPETS

THE MARK CONSISTS OF STANDARD CHARACTERS WITHOUT CLAIM TO ANY PARTICULAR FONT, STYLE, SIZE, OR COLOR.

OWNER OF U.S. REG. NOS. 948,503, 949,135, AND 1,137,985.

FOR ACTION FIGURES; BALLOONS; DOLLS; DOLL PLAYSETS; JIGSAW PUZZLES AND PLUSH TOYS (U.S. CLS. 22, 23, 38 AND 50).

FIRST USE 1-3-2005; IN COMMERCE 1-3-2005.

CLASS 29—(Continued).

3,313,130. MARQUEZ BROTHERS INTERNATIONAL, INC., SAN JOSE, CA. SN 76-637,917. PUB. 8-22-2006, FILED 5-5-2005.

Marquez Family.

THE MARK CONSISTS OF STANDARD CHARACTERS WITHOUT CLAIM TO ANY PARTICULAR FONT, STYLE, SIZE, OR COLOR.

FOR CREAM (U.S. CL. 46).

FIRST USE 5-8-2007; IN COMMERCE 5-8-2007.

3,313,237. MARS, INCORPORATED, MCLEAN, VA. SN 76-978,630. PUB. 4-5-2005, FILED 10-18-2004.

CLASS 29—MEATS AND PROCESSED FOODS

3,313,004. INCREDIBLY EDIBLE DELITES, INC., BROOKMALL, PA. SN 76-419,412. PUB. 12-3-2002, FILED 6-11-2002.

FRUITFLOWERS

FOR FLORAL FRUIT AND VEGETABLE ARRANGEMENTS CONSISTING OF CUT OR SLICED FRUITS AND VEGETABLES (U.S. CL. 46).

FIRST USE 0-0-2002; IN COMMERCE 0-0-2002.

DOVE

THE MARK CONSISTS OF STANDARD CHARACTERS WITHOUT CLAIM TO ANY PARTICULAR FONT, STYLE, SIZE, OR COLOR.

OWNER OF U.S. REG. NOS. 1,798,051, 2,012,056, AND OTHERS.

FOR DAIRY-BASED CHOCOLATE FOOD BEVERAGES (U.S. CL. 46).

FIRST USE 2-0-2007; IN COMMERCE 2-0-2007.

3,313,105. GLORY FOODS, INC., COLUMBUS, OH. SN 76-631,949. PUB. 4-18-2006, FILED 2-9-2005.

SENSIBLY SEASONED

THE MARK CONSISTS OF STANDARD CHARACTERS WITHOUT CLAIM TO ANY PARTICULAR FONT, STYLE, SIZE, OR COLOR.

NO CLAIM IS MADE TO THE EXCLUSIVE RIGHT TO USE "SEASONED", APART FROM THE MARK AS SHOWN.

FOR CANNED VEGETABLES (U.S. CL. 46).

FIRST USE 1-24-2006; IN COMMERCE 1-24-2006.

3,313,268. SCHREIBER FOODS, INC., GREEN BAY, WI. SN 77-009,320. PUB. 3-27-2007, FILED 9-28-2006.

SOPHISTICATED CHEESE MADE SIMPLE.

THE MARK CONSISTS OF STANDARD CHARACTERS WITHOUT CLAIM TO ANY PARTICULAR FONT, STYLE, SIZE, OR COLOR.

FOR CHEESE (U.S. CL. 46).

FIRST USE 1-7-2007; IN COMMERCE 1-7-2007.

CLASS 29—(Continued).

3,313,293. KASIM INTERNATIONAL CORP., MIAMI, FL. SN 77-023,498. PUB. 5-22-2007, FILED 10-18-2006.



FOR PROCESSED OLIVES, OLIVE OIL (U.S. CL. 46).
FIRST USE 5-24-2007; IN COMMERCE 5-24-2007.

3,313,318. GENERAL MILLS, INC., MINNEAPOLIS, MN. SN 77-035,967. PUB. 4-3-2007, FILED 11-3-2006.

FRUIT ROLL-UPS FRUIT
STACKERZ

THE MARK CONSISTS OF STANDARD CHARACTERS
WITHOUT CLAIM TO ANY PARTICULAR FONT, STYLE,
SIZE, OR COLOR.

OWNER OF U.S. REG. NO. 1,127,591.
NO CLAIM IS MADE TO THE EXCLUSIVE RIGHT TO
USE "FRUIT", APART FROM THE MARK AS SHOWN.
FOR FRUIT-BASED SNACK FOOD (U.S. CL. 46).
FIRST USE 5-28-2007; IN COMMERCE 5-28-2007.

3,313,526. AMERICAN SEAFOODS GROUP LLC, SEATTLE,
WA. SN 78-526,603. PUB. 3-7-2006, FILED 12-3-2004.

OCEAN CUTS

THE MARK CONSISTS OF STANDARD CHARACTERS
WITHOUT CLAIM TO ANY PARTICULAR FONT, STYLE,
SIZE, OR COLOR.

OWNER OF U.S. REG. NOS. 1,879,289 AND 2,519,116.
FOR SEAFOOD (U.S. CL. 46).
FIRST USE 8-7-1995; IN COMMERCE 8-7-1995.

CLASS 29—(Continued).

3,313,536. HQ SUSTAINABLE MARITIME MARKETING
INC., NEW YORK, NY. SN 78-534,739. PUB. 10-25-2005,
FILED 12-17-2004.

TILOVEYA

THE MARK CONSISTS OF STANDARD CHARACTERS
WITHOUT CLAIM TO ANY PARTICULAR FONT, STYLE,
SIZE, OR COLOR.

FOR FISH, NAMELY, TILAPIA (U.S. CL. 46).
FIRST USE 4-30-2007; IN COMMERCE 4-30-2007.

3,313,580. VILLACRESES, LUIS ALFREDO, ELMHURST,
NY. SN 78-576,514. PUB. 2-28-2006, FILED 2-28-2005.

Tropicmax

THE MARK CONSISTS OF STANDARD CHARACTERS
WITHOUT CLAIM TO ANY PARTICULAR FONT, STYLE,
SIZE, OR COLOR.

FOR PRESERVED, DRIED AND COOKED FRUITS
AND VEGETABLES, NAMELY PLANTAIN CHIPS, CAS-
SAVA CHIPS AND OTHER TROPICAL FRUITS AND
VEGETABLES (U.S. CL. 46).

FIRST USE 5-30-2006; IN COMMERCE 5-30-2006.

CLASS 29—(Continued).

3,313,604. TOPCO ASSOCIATES, LLC, SKOKIE, IL. SN 78-589,826. PUB. 8-15-2006, FILED 3-17-2005.

CLEAR VALUE

THE MARK CONSISTS OF STANDARD CHARACTERS WITHOUT CLAIM TO ANY PARTICULAR FONT, STYLE, SIZE, OR COLOR.

FOR MILK, EVAPORATED MILK, BUTTERMILK, EGGS, BUTTER, PEANUT BUTTER, SHORTENING, VEGETABLE OIL, COOKING VEGETABLE OIL SPRAY; CANNED VEGETABLES, NAMELY CORN, SWEET PEAS, GREEN BEANS, KIDNEY BEANS, MUSHROOMS, CARROTS, MIXED VEGETABLES, POTATOES, BEETS; CANNED TOMATOES, NAMELY, DICED, WHOLE-PEELED, STEWED; FROZEN VEGETABLES, NAMELY CORN, GREEN PEAS, SWEET PEAS, GREEN BEANS, MIXED VEGETABLES, BROCCOLI; NON-DAIRY POWDERED CREAMER, FRUIT PRESERVES, NAMELY, STRAWBERRY PRESERVES, GRAPE JELLY, MARASCHINO CHERRIES; CANNED FRUIT, NAMELY PEACHES, PINEAPPLE, MANDARIN ORANGES, PEARS; CANNED FRUIT COCKTAIL, CANNED TUNA FISH; COOKED CHICKEN, HAM AND TURKEY; ROAST BEEF, GROUND BEEF, BEEF PATTIES, BACON, SALMON, PROCESSED MIXED NUTS, PROCESSED PEANUTS, PROCESSED OLIVES, POTATO CHIPS, IMITATION SHREDDED CHEESE, PICKLES, SOUPS, HOT DOGS, SAUSAGES, CANNED PORK AND BEANS, BEEF STEW, INSTANT POTATOES, APPLESAUCE (U.S. CL. 46).

FIRST USE 8-1-2006; IN COMMERCE 8-1-2006.

3,313,715. PERDUE HOLDINGS, INC., WILMINGTON, DE. SN 78-640,452. PUB. 2-14-2006, FILED 5-31-2005.

**A FAMILY COMMITMENT TO
QUALITY SINCE 1920**

THE MARK CONSISTS OF STANDARD CHARACTERS WITHOUT CLAIM TO ANY PARTICULAR FONT, STYLE, SIZE, OR COLOR.

NO CLAIM IS MADE TO THE EXCLUSIVE RIGHT TO USE "SINCE 1920", APART FROM THE MARK AS SHOWN. FOR POULTRY AND PARTS THEREOF AND PROCESSED MEATS MADE FROM POULTRY AND PARTS THEREOF (U.S. CL. 46).

FIRST USE 8-1-2005; IN COMMERCE 8-1-2005.

CLASS 29—(Continued).

3,313,716. BETTMAN, JAY, CINCINNATI, OH. SN 78-641,429. PUB. 1-23-2007, FILED 6-1-2005.

CHEFS CAFE

THE MARK CONSISTS OF STANDARD CHARACTERS WITHOUT CLAIM TO ANY PARTICULAR FONT, STYLE, SIZE, OR COLOR.

NO CLAIM IS MADE TO THE EXCLUSIVE RIGHT TO USE "CAFE", APART FROM THE MARK AS SHOWN. FOR CHICKEN SALAD AND HAM SALAD (U.S. CL. 46).

FIRST USE 10-1-2005; IN COMMERCE 10-1-2005.

3,313,776. CARITAS RANCH BAR-B-Q, CO., BOERNE, TX. SN 78-665,936. PUB. 3-28-2006, FILED 7-7-2005.

CARITAS RANCH

THE MARK CONSISTS OF STANDARD CHARACTERS WITHOUT CLAIM TO ANY PARTICULAR FONT, STYLE, SIZE, OR COLOR.

OWNER OF U.S. REG. NO. 2,270,500. THE ENGLISH TRANSLATION OF THE WORD "CARITAS" IN THE MARK IS "MESQUITE".

SEC. 2(F).

FOR MEATS AND POULTRY (U.S. CL. 46).

FIRST USE 10-1-1996; IN COMMERCE 10-1-1996.

3,313,799. OLIVINA, LLC, LIVERMORE, CA. SN 78-676,571. PUB. 1-9-2007, FILED 7-22-2005.

Olivina

THE MARK CONSISTS OF STANDARD CHARACTERS WITHOUT CLAIM TO ANY PARTICULAR FONT, STYLE, SIZE, OR COLOR.

FOR OLIVE OIL (U.S. CL. 46).

FIRST USE 11-15-1992; IN COMMERCE 11-15-1992.

CLASS 29—(Continued).

3,313,806. C.K.F. FOODS, INC., MOUNT PROSPECT, IL. SN 78-680,434. PUB. 11-21-2006, FILED 7-28-2005.

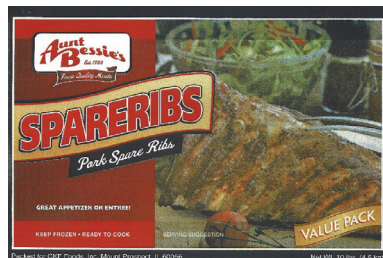

NO CLAIM IS MADE TO THE EXCLUSIVE RIGHT TO USE "EST. 1958", "FINEST QUALITY MEATS", "SPARERIBS", "PORK SPARE RIBS", "GREAT APPETIZER OR ENTRÉE!", "KEEP FROZEN . READY TO COOK", "SERVING SUGGESTION", "VALUE PACK; "PACKED FOR CKF FOODS, INC. MOUNT PROSPECT, IL 60056"; AND "NET WT. 10 LBS. (4.5 KG)", APART FROM THE MARK AS SHOWN.

THE COLOR(S) WHITE, YELLOW, ORANGE, RED, GREEN, GOLD, BROWN, SILVER, BLACK AND TAN IS/ARE CLAIMED AS A FEATURE OF THE MARK.

THE MARK CONSISTS OF THE COLOR RED APPEARS ON THE TOMATO, ON THE SPARERIBS, IN THE STYLIZED WORDS AUNT BESSIE'S EST. 1958, IN THE BANNER FOR THE STYLIZED WORDS FINEST QUALITY MEATS, IN THE STYLIZED WORD SPARERIBS, IN THE SALAD, AS A RECTANGULAR BACKGROUND ON THE LEFT SIDE OF THE MARK, AS AN OUTLINE OF THE GOLD BANNER FOR THE STYLIZED WORDS VALUE PACK, AND AS SHADOWING/SHADING FOR THE STYLIZED WORDS VALUE PACK. THE COLOR BROWN APPEARS ON THE SPARERIBS, AS AN OUTLINE OF THE GOLD BANNER FOR THE STYLIZED WORDS VALUE PACK AND IN THE CONTAINER. THE COLOR GREEN APPEARS ON THE STEMS OF THE TOMATO, IN AND NEXT TO THE SALAD, AND IN THE JAR. THE COLOR GOLD APPEARS IN THE BANNER FOR THE STYLIZED WORDS VALUE PACK, IN THE BANNER FOR THE STYLIZED WORD SPARERIBS, AND ON THE SPARERIBS. THE COLOR YELLOW APPEARS IN THE BANNER FOR THE STYLIZED WORDS VALUE PACK, IN THE BANNER FOR THE STYLIZED WORD SPARERIBS, AND ON THE SPARERIBS. THE COLOR ORANGE APPEARS IN THE CARROTS IN THE SALAD. THE COLOR BLACK APPEARS ON THE SPARERIBS, ON THE CAP FOR THE JAR, IN AND NEXT TO THE JAR, AS AN OUTLINE FOR THE WHITE BANNER FOR THE STYLIZED WORDS AUNT BESSIE'S EST. 1958, AS SHADOWING/SHADING FOR THE STYLIZED WORD SPARERIBS, AS AN OUTLINE FOR THE BANNER FOR THE STYLIZED WORD SPARERIBS, AND AS A BACKGROUND IN THE BANNER FOR THE STYLIZED WORDS PORK SPARE RIBS. THE COLOR WHITE APPEARS IN THE BACKGROUND OF THE RECTANGULAR BANNER WITH ROUNDED CORNERS FOR THE STYLIZED WORDS AUNT BESSIE'S EST. 1958, IN THE STYLIZED WORDS FINEST QUALITY MEATS, AS AN OUTLINE FOR THE RED BANNER FOR THE STYLIZED WORDS FINEST QUALITY MEATS, AS SHADOWING/SHADING FOR THE STYLIZED WORD SPARERIBS, IN THE STYLIZED WORDS PORK SPARE RIBS, IN THE STYLIZED WORDS VALUE PACK, IN THE WORDS GREAT APPETIZER OR ENTRÉE!, IN THE WORDS KEEP FROZEN. READY TO COOK, IN THE WORDS SERVING SUGGESTION, IN THE SALAD, AND ON THE SPARERIBS. THE COLOR SILVER APPEARS IN THE FORK, IN THE KNIFE, IN THE GLASS BOWL CONTAINING THE SALAD, IN THE JAR, AND ON THE CLAMP FOR THE CONTAINER. THE COLOR TAN APPEARS ON THE TABLE AND ON THE SPARERIBS.

FOR PORK; PORK SPARE RIBS; MEAT; FROZEN ENTREES CONSISTING PRIMARILY OF MEAT; PREPARED ENTREES CONSISTING PRIMARILY OF MEAT; PACKAGED ENTREES CONSISTING PRIMARILY OF MEAT; FROZEN MEAT; PREPARED MEAT; AND PROCESSED MEAT, NAMELY, PORK (U.S. CL. 46).
FIRST USE 5-31-2005; IN COMMERCE 5-31-2005.

CLASS 29—(Continued).

3,313,871. HEB GROCERY COMPANY, L.P., SAN ANTONIO, TX. SN 78-709,231. PUB. 8-15-2006, FILED 9-8-2005.

LETTUCE SCOOPS

THE MARK CONSISTS OF STANDARD CHARACTERS WITHOUT CLAIM TO ANY PARTICULAR FONT, STYLE, SIZE, OR COLOR.

NO CLAIM IS MADE TO THE EXCLUSIVE RIGHT TO USE LETTUCE, APART FROM THE MARK AS SHOWN. FOR FRESH CUT OR SLICED LETTUCE (U.S. CL. 46).
FIRST USE 1-0-2006; IN COMMERCE 1-0-2006.

3,313,941. STARR, DWAIN S, HESSEL, MI. AND STARR, SHARON M, HESSEL, MI. AND STARR, BRITNEY L, HESSEL, MI. SN 78-739,619. PUB. 7-11-2006, FILED 10-25-2005.

Dad's Chili

THE MARK CONSISTS OF STANDARD CHARACTERS WITHOUT CLAIM TO ANY PARTICULAR FONT, STYLE, SIZE, OR COLOR.

NO CLAIM IS MADE TO THE EXCLUSIVE RIGHT TO USE "CHILI", APART FROM THE MARK AS SHOWN. FOR CHILI (U.S. CL. 46).
FIRST USE 5-27-2007; IN COMMERCE 5-27-2007.

3,313,975. KELLOGG NORTH AMERICA COMPANY, BATTLE CREEK, MI. SN 78-748,706. PUB. 7-11-2006, FILED 11-7-2005.

TRIPLE LIGHTNING TWIST

THE MARK CONSISTS OF STANDARD CHARACTERS WITHOUT CLAIM TO ANY PARTICULAR FONT, STYLE, SIZE, OR COLOR.

OWNER OF U.S. REG. NO. 3,091,433.
FOR FRUIT-BASED SNACK FOOD; FRUIT JUICE-BASED SNACK FOOD (U.S. CL. 46).
FIRST USE 1-2-2006; IN COMMERCE 1-2-2006.

CLASS 29—(Continued).

3,313,982. UNILEVER SUPPLY CHAIN, INC., CLINTON, CT.
SN 78-749,542. PUB. 10-3-2006, FILED 11-8-2005.

CLASS 29—(Continued).

3,314,026. SUN-MAID GROWERS OF CALIFORNIA, KINGS-
BURG, CA. SN 78-756,487. PUB. 7-25-2006, FILED 11-17-
2005.

EASY BISTRO

THE MARK CONSISTS OF STANDARD CHARACTERS
WITHOUT CLAIM TO ANY PARTICULAR FONT, STYLE,
SIZE, OR COLOR.
FOR SOUPS (U.S. CL. 46).
FIRST USE 1-0-2006; IN COMMERCE 1-0-2006.

JUST GRAPES & SUNSHINE

THE MARK CONSISTS OF STANDARD CHARACTERS
WITHOUT CLAIM TO ANY PARTICULAR FONT, STYLE,
SIZE, OR COLOR.
FOR PRESERVED FRUITS, DRIED FRUITS, RAISINS,
AND DRIED GRAPES (U.S. CL. 46).
FIRST USE 5-12-2006; IN COMMERCE 5-12-2006.

3,313,995. ROTH KASE U.S.A. LTD., MONROE, WI. SN 78-
750,387. PUB. 7-18-2006, FILED 11-9-2005.

3,314,027. SUN-MAID GROWERS OF CALIFORNIA, KINGS-
BURG, CA. SN 78-756,494. PUB. 7-25-2006, FILED 11-17-
2005.

RHAPSODY

THE MARK CONSISTS OF STANDARD CHARACTERS
WITHOUT CLAIM TO ANY PARTICULAR FONT, STYLE,
SIZE, OR COLOR.
FOR CHEESE (U.S. CL. 46).
FIRST USE 12-7-2006; IN COMMERCE 12-7-2006.

JUST GRAPES AND SUNSHINE

THE MARK CONSISTS OF STANDARD CHARACTERS
WITHOUT CLAIM TO ANY PARTICULAR FONT, STYLE,
SIZE, OR COLOR.
FOR PRESERVED FRUITS, DRIED FRUITS, RAISINS
AND DRIED GRAPES (U.S. CL. 46).
FIRST USE 5-12-2006; IN COMMERCE 5-12-2006.

3,313,996. ROTH KASE U.S.A. LTD., MONROE, WI. SN 78-
750,428. PUB. 7-18-2006, FILED 11-9-2005.

3,314,032. SIWIN FOODS LTD., LEDUC, ALBERTA, CANA-
DA. SN 78-758,313. PUB. 8-22-2006, FILED 11-21-2005.

SERENADE

THE MARK CONSISTS OF STANDARD CHARACTERS
WITHOUT CLAIM TO ANY PARTICULAR FONT, STYLE,
SIZE, OR COLOR.
FOR CHEESE (U.S. CL. 46).
FIRST USE 1-12-2007; IN COMMERCE 1-12-2007.

XIWANG

THE MARK CONSISTS OF STANDARD CHARACTERS
WITHOUT CLAIM TO ANY PARTICULAR FONT, STYLE,
SIZE, OR COLOR.
THE FOREIGN WORDING IN THE MARK TRANSLATES
INTO ENGLISH AS HAPPINESS AND PERSPERITY.
FOR CANNED OR BOTTLED FRUITS; JAMS; JELLIES;
MILK; FROZEN, COOKED AND CANNED MEALS
CONSISTING PRIMARILY OF MEAT, FISH, POULTRY
OR VEGETABLES (U.S. CL. 46).
FIRST USE 4-13-2007; IN COMMERCE 4-13-2007.

CLASS 29—(Continued).

3,314,033. SIWIN FOODS LTD., LEDUC, ALBERTA, CANADA. SN 78-758,333. PUB. 2-6-2007, FILED 11-21-2005.

XIZHIWEI

THE MARK CONSISTS OF STANDARD CHARACTERS WITHOUT CLAIM TO ANY PARTICULAR FONT, STYLE, SIZE, OR COLOR.

FOR CANNED OR BOTTLED FRUITS; JAMS; JELLIES; MILK; FROZEN, COOKED AND CANNED MEALS CONSISTING PRIMARILY OF MEAT, FISH, POULTRY OR VEGETABLES (U.S. CL. 46).

FIRST USE 3-2-2006; IN COMMERCE 4-2-2007.

3,314,042. EMBUTIDOS Y JAMONES FERMIN, S.L., LA ALBERCA (SALAMANCA), SPAIN. SN 78-760,503. PUB. 8-22-2006, FILED 11-23-2005.



FOR HAMS, PROCESSED COLD CUTS, NAMELY, LOINS, HIGHLY SEASONED SAUSAGES, SALAMI TYPE SAUSAGES, ALL OF THEM MADE OF PORK (U.S. CL. 46).

FIRST USE 12-2-1990; IN COMMERCE 7-9-2006.

3,314,068. FOODTECH INTERNATIONAL, INC., NEW HAVEN, CT. SN 78-765,005. PUB. 1-2-2007, FILED 12-1-2005.

BISTRO AU NATUREL

THE MARK CONSISTS OF STANDARD CHARACTERS WITHOUT CLAIM TO ANY PARTICULAR FONT, STYLE, SIZE, OR COLOR.

NO CLAIM IS MADE TO THE EXCLUSIVE RIGHT TO USE "AU NATUREL", APART FROM THE MARK AS SHOWN.

THE ENGLISH TRANSLATION OF THE WORD "AU NATUREL" IN THE MARK IS "NATURAL."

FOR VEGETABLE-BASED MEAT SUBSTITUTES AND VEGETABLE-BASED ENTREES AND SNACKS (U.S. CL. 46).

FIRST USE 1-31-2006; IN COMMERCE 1-31-2006.

CLASS 29—(Continued).

3,314,325. WINN-DIXIE STORES, INC., JACKSONVILLE, FL. SN 78-809,678. PUB. 2-6-2007, FILED 2-8-2006.

TATER BUDS

THE MARK CONSISTS OF STANDARD CHARACTERS WITHOUT CLAIM TO ANY PARTICULAR FONT, STYLE, SIZE, OR COLOR.

NO CLAIM IS MADE TO THE EXCLUSIVE RIGHT TO USE "TATER", APART FROM THE MARK AS SHOWN.

FOR PROCESSED POTATOES (U.S. CL. 46).

FIRST USE 10-19-2005; IN COMMERCE 3-29-2006.

3,314,335. PET INCORPORATED, MINNEAPOLIS, MN. SN 78-811,085. PUB. 1-16-2007, FILED 2-9-2006.

HEALTHY FAVORITES

THE MARK CONSISTS OF STANDARD CHARACTERS WITHOUT CLAIM TO ANY PARTICULAR FONT, STYLE, SIZE, OR COLOR.

NO CLAIM IS MADE TO THE EXCLUSIVE RIGHT TO USE "HEALTHY", APART FROM THE MARK AS SHOWN.

FOR SOUPS (U.S. CL. 46).

FIRST USE 7-24-2006; IN COMMERCE 7-24-2006.

3,314,358. KRAFT FOODS HOLDINGS, INC., NORTHFIELD, IL. SN 78-815,614. PUB. 9-19-2006, FILED 2-15-2006.

GRATE-IT-FRESH

THE MARK CONSISTS OF STANDARD CHARACTERS WITHOUT CLAIM TO ANY PARTICULAR FONT, STYLE, SIZE, OR COLOR.

FOR CHEESE (U.S. CL. 46).

FIRST USE 6-0-2006; IN COMMERCE 6-0-2006.

CLASS 29—(Continued).

3,314,430. CONAGRA FOODS PACKAGED FOODS, LLC, OMAHA, NE. SN 78-828,986. PUB. 8-29-2006, FILED 3-3-2006.

MY FRIES

THE MARK CONSISTS OF STANDARD CHARACTERS WITHOUT CLAIM TO ANY PARTICULAR FONT, STYLE, SIZE, OR COLOR.

NO CLAIM IS MADE TO THE EXCLUSIVE RIGHT TO USE "FRIES", APART FROM THE MARK AS SHOWN.

FOR FROZEN PROCESSED POTATOES, AND FRENCH FRIED POTATOES (U.S. CL. 46).

FIRST USE 8-0-2006; IN COMMERCE 8-0-2006.

3,314,432. HEB GROCERY COMPANY, L.P., SAN ANTONIO, TX. SN 78-829,808. PUB. 8-29-2006, FILED 3-6-2006.

BAMBOO GARDEN BLEND

THE MARK CONSISTS OF STANDARD CHARACTERS WITHOUT CLAIM TO ANY PARTICULAR FONT, STYLE, SIZE, OR COLOR.

NO CLAIM IS MADE TO THE EXCLUSIVE RIGHT TO USE "BLEND", APART FROM THE MARK AS SHOWN.

FOR FROZEN VEGETABLES (U.S. CL. 46).

FIRST USE 2-0-2006; IN COMMERCE 2-0-2006.

3,314,433. THE PROCTER & GAMBLE COMPANY, CINCINNATI, OH. SN 78-830,125. PUB. 10-17-2006, FILED 3-6-2006.

READ 'EM AND EAT 'EM

THE MARK CONSISTS OF STANDARD CHARACTERS WITHOUT CLAIM TO ANY PARTICULAR FONT, STYLE, SIZE, OR COLOR.

FOR SNACK FOODS, NAMELY, POTATO CHIPS (U.S. CL. 46).

FIRST USE 6-30-2006; IN COMMERCE 6-30-2006.

CLASS 29—(Continued).

3,314,453. CONAGRA FOODS PACKAGED FOODS, LLC, OMAHA, NE. SN 78-833,828. PUB. 8-22-2006, FILED 3-9-2006.

i3 ADVANTAGE

THE MARK CONSISTS OF STANDARD CHARACTERS WITHOUT CLAIM TO ANY PARTICULAR FONT, STYLE, SIZE, OR COLOR.

FOR FROZEN PROCESSED POTATOES, AND FRENCH FRIED POTATOES (U.S. CL. 46).

FIRST USE 8-0-2006; IN COMMERCE 8-0-2006.

3,314,554. WMK HOLDINGS, INC., WILMINGTON, DE. SN 78-875,098. PUB. 3-13-2007, FILED 5-3-2006.

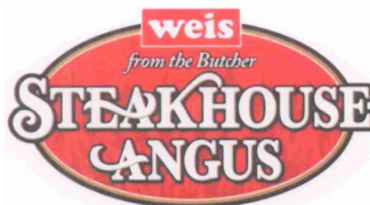

NO CLAIM IS MADE TO THE EXCLUSIVE RIGHT TO USE "ANGUS" AND "FROM THE BUTCHER", APART FROM THE MARK AS SHOWN.

THE COLOR(S) RED, BLACK, WHITE, GRAY, AND TAN IS/ARE CLAIMED AS A FEATURE OF THE MARK.

THE COLOR RED APPEARS IN THE SHADING OF THE RECTANGLE AND THE OVAL; BLACK APPEARS IN THE OUTLINE OF THE LETTERING AND IN THE OUTER RING OF THE OVAL; WHITE APPEARS IN THE LETTERING, THE OUTLINE OF THE RECTANGLE, AND THE INNERMOST RING OF THE OVAL; GRAY APPEARS IN THE FLAME DESIGN BEHIND THE LETTERING IN THE OVAL; AND TAN APPEARS IN THE MIDDLE RING OF THE OVAL BETWEEN THE BLACK AND WHITE RINGS.

FOR ANGUS MEAT (U.S. CL. 46).

FIRST USE 1-1-2007; IN COMMERCE 1-1-2007.

CLASS 29—(Continued).

3,314,565. P. EAST TRADING CORP., BRONX, NY. SN 78-878,661. PUB. 12-5-2006, FILED 5-8-2006.

JAMAICAN STAR

THE MARK CONSISTS OF STANDARD CHARACTERS WITHOUT CLAIM TO ANY PARTICULAR FONT, STYLE, SIZE, OR COLOR.

NO CLAIM IS MADE TO THE EXCLUSIVE RIGHT TO USE "JAMAICAN", APART FROM THE MARK AS SHOWN. FOR EDIBLE OIL; JELLIES; PROCESSED VEGETABLES AND FRUITS (U.S. CL. 46).

FIRST USE 10-1-2006; IN COMMERCE 10-1-2006.

3,314,588. THE FIZZY FRUIT COMPANY, PORTLAND, OR. SN 78-883,911. PUB. 12-26-2006, FILED 5-15-2006.

ALL NATURAL. 100% FUN!

THE MARK CONSISTS OF STANDARD CHARACTERS WITHOUT CLAIM TO ANY PARTICULAR FONT, STYLE, SIZE, OR COLOR.

NO CLAIM IS MADE TO THE EXCLUSIVE RIGHT TO USE "ALL NATURAL", APART FROM THE MARK AS SHOWN.

FOR CARBONATED FRUITS AND VEGETABLES (U.S. CL. 46).

FIRST USE 12-10-2006; IN COMMERCE 12-10-2006.

3,314,701. CEDAR RIDGE FINANCIAL SERVICES, INC., ELIZABETH, IL. SN 78-910,934. PUB. 2-6-2007, FILED 6-19-2006.



NO CLAIM IS MADE TO THE EXCLUSIVE RIGHT TO USE "GALENA BEEF", APART FROM THE MARK AS SHOWN.

THE COLOR(S) GREEN AND BLACK IS/ARE CLAIMED AS A FEATURE OF THE MARK.

THE COLOR GREEN APPEARS IN THE STYLIZED MOUNTAIN AND THE WORDING GALENA BEEF; THE COLOR BLACK APPEARS IN THE SILHOUETTE OF A STEER OR BULL, AND THE SHADOWING OF THE STYLIZED MOUNTAIN AND THE WORDING GALENA BEEF.

FOR BEEF (U.S. CL. 46).

FIRST USE 7-17-2007; IN COMMERCE 7-17-2007.

CLASS 29—(Continued).

3,314,785. KEN'S CAVE, INC., NEW YORK, NY. SN 78-940,838. PUB. 3-13-2007, FILED 7-31-2006.

THERMAL BAR

THE MARK CONSISTS OF STANDARD CHARACTERS WITHOUT CLAIM TO ANY PARTICULAR FONT, STYLE, SIZE, OR COLOR.

NO CLAIM IS MADE TO THE EXCLUSIVE RIGHT TO USE "BAR", APART FROM THE MARK AS SHOWN.

FOR SOY-BASED FOOD BARS ALSO CONTAINING WHEAT FLOUR, CORNMEAL, OATS, WALNUTS, FLAX SEED, SUNFLOWER BUTTER, HONEY, OILS, NIACIN AND SPICES (U.S. CL. 46).

FIRST USE 1-14-2007; IN COMMERCE 1-14-2007.

3,314,792. PROGRESSIVE GROUP ALLIANCE, LLC, RICHMOND, VA. SN 78-941,912. PUB. 1-2-2007, FILED 8-1-2006.

HARVEST GOLD

THE MARK CONSISTS OF STANDARD CHARACTERS WITHOUT CLAIM TO ANY PARTICULAR FONT, STYLE, SIZE, OR COLOR.

OWNER OF U.S. REG. NOS. 823,020, 1,922,268, AND OTHERS.

FOR BUTTER, CHEESE, AND SOUR CREAM (U.S. CL. 46).

FIRST USE 6-1-2007; IN COMMERCE 6-1-2007.

3,314,880. TROPICAL NUT & FRUIT CO., CHARLOTTE, NC. SN 78-968,338. PUB. 1-30-2007, FILED 9-6-2006.

Buffalo Nuts

THE MARK CONSISTS OF STANDARD CHARACTERS WITHOUT CLAIM TO ANY PARTICULAR FONT, STYLE, SIZE, OR COLOR.

NO CLAIM IS MADE TO THE EXCLUSIVE RIGHT TO USE "NUTS", APART FROM THE MARK AS SHOWN.

FOR PROCESSED NUTS (U.S. CL. 46).

FIRST USE 2-1-2007; IN COMMERCE 2-1-2007.

CLASS 29—(Continued).

3,314,898. POLANER, INC., PARSIPPANY, NJ. SN 78-978,038. PUB. 3-14-2006, FILED 6-23-2005.

NOTHING BUT THE GOOD STUFF

THE MARK CONSISTS OF STANDARD CHARACTERS WITHOUT CLAIM TO ANY PARTICULAR FONT, STYLE, SIZE, OR COLOR.

FOR JAMS, JELLY, MARMALADE, FRUIT AND BERRY PRESERVES, FRUIT SPREADS, FRUIT TOPPING, MINT JELLY, CURRANT JELLY, PEANUT BUTTER AND SALAD, EXCEPT MACARONI, RICE AND PASTA SALADS, AND SUN DRIED TOMATOES (U.S. CL. 46).

FIRST USE 1-8-2006; IN COMMERCE 1-8-2006.

CLASS 30—STAPLE FOODS

3,312,994. ARCOR S.A.I.C., (1006) BUENOS AIRES, ARGENTINA. SN 76-292,742. PUB. 7-16-2002, FILED 7-30-2001.

CABSHA

FOR CHOCOLATE, CHOCOLATE BARS, CHOCOLATE COVERED NUTS, CHOCOLATE CANDIES, CHOCOLATE COATED COOKIES, WAFERS, COATED SANDWICH COOKIES, COOKIES, BONBONS (U.S. CL. 46).

FIRST USE 1-31-1960; IN COMMERCE 11-30-2003.

3,313,005. MADLER PTY LIMITED, ST. IVES NSW 2075, AUSTRALIA. SN 76-424,501. PUB. 2-28-2006, FILED 6-25-2002.



NO CLAIM IS MADE TO THE EXCLUSIVE RIGHT TO USE THE GEOGRAPHIC REPRESENTATION OF AUSTRALIA, APART FROM THE MARK AS SHOWN.

THE MARK CONSISTS OF THE OUTLINE OF THE AUSTRALIAN CONTINENT ENCLOSING A STYLIZED REPRESENTATION OF AN ELEPHANT.

FOR TEAS (U.S. CL. 46).
FIRST USE 10-30-1999; IN COMMERCE 10-30-1999.

CLASS 30—(Continued).

3,313,009. SUMMIT FOODS, INC., ST. PAUL, MN. SN 76-456,457. PUB. 8-3-2004, FILED 10-7-2002.

MADISON CREEK

FOR BARBEQUE SAUCE, SALSA, SALAD DRESSINGS, AND CONDIMENTS, NAMELY, CHUTNEY (U.S. CL. 46).

FIRST USE 4-13-2007; IN COMMERCE 4-13-2007.

3,313,016. ESPRESSAROMA S.P.A., 00155 ROMA, ITALY. SN 76-508,061. PUB. 3-28-2006, FILED 4-21-2003.



OWNER OF U.S. REG. NO. 2,622,077.
NO CLAIM IS MADE TO THE EXCLUSIVE RIGHT TO USE "ESPRESSO" AND "ROMA", APART FROM THE MARK AS SHOWN.

FOR COFFEE, DECAFFEINATED COFFEE, SOLUBLE COFFEE, COFFEE BEANS, COFFEE SUBSTITUTES, COFFEE BASED BEVERAGES (U.S. CL. 46).
FIRST USE 10-20-2002; IN COMMERCE 10-20-2002.

3,313,031. RENFROW, JESSICA ASHLEY, SARASOTA, FL. AND RENFROW, JUSTIN ERIC, SARASOTA, FL. SN 76-529,234. PUB. 6-15-2004, FILED 7-15-2003.

International House of Coffee

NO CLAIM IS MADE TO THE EXCLUSIVE RIGHT TO USE COFFEE, APART FROM THE MARK AS SHOWN.
FOR COFFEE (U.S. CL. 46).
FIRST USE 8-5-2002; IN COMMERCE 9-5-2003.

CLASS 30—(Continued).

3,313,043. FANTE, INC., DBA CASA SANCHEZ FOODS, SAN FRANCISCO, CA. SN 76-560,903. PUB. 8-31-2004, FILED 11-18-2003.

JULIANA'S GOURMET

NO CLAIM IS MADE TO THE EXCLUSIVE RIGHT TO USE "GOURMET", APART FROM THE MARK AS SHOWN. FOR SALSA AND TORTILLA CHIPS (U.S. CL. 46). FIRST USE 2-1-2007; IN COMMERCE 5-10-2007.

3,313,170. MULBERRY GREEN TEA LTD., PART., HUAYKWANG, BANGKOK 10310, THAILAND. SN 76-648,452. PUB. 8-29-2006, FILED 10-14-2005.



NO CLAIM IS MADE TO THE EXCLUSIVE RIGHT TO USE "RANONG TEA", APART FROM THE MARK AS SHOWN.

THE NON-LATIN CHARACTERS IN THE MARK TRANSLITERATE INTO "RA NONG TAE E" WHICH HAS NO MEANING IN ENGLISH.

FOR TEA (U.S. CL. 46). FIRST USE 4-30-2005; IN COMMERCE 4-30-2005.

3,313,178. O'NEIL, DIANNE, NASHVILLE, TN. SN 76-651,653. PUB. 8-8-2006, FILED 12-8-2005.

CLUCK 'N' COFFEE

THE MARK CONSISTS OF STANDARD CHARACTERS WITHOUT CLAIM TO ANY PARTICULAR FONT, STYLE, SIZE, OR COLOR.

FOR PRE-PACKAGED ROASTED COFFEE BEANS (U.S. CL. 46). FIRST USE 11-8-2006; IN COMMERCE 11-22-2006.

CLASS 30—(Continued).

3,313,227. ANGELAKIS, ANNA MARIA, DBA ANGELI GOURMET GREEK FOODS, ROCKVILLE, MD. SN 76-665,736. PUB. 5-1-2007, FILED 9-6-2006.

THE MARK CONSISTS OF THE WORD ANGELI IN DESIGN FORM WITH A HALO OVER THE LETTER A. THE ENGLISH TRANSLATION OF THE WORD ANGELI IN THE MARK IS "ANGELS".

FOR SALAD DRESSINGS (U.S. CL. 46). FIRST USE 5-4-2007; IN COMMERCE 5-4-2007.

3,313,248. HUNTINGTON COUNTRY STORE LLC, HUNTINGTON, MA. SN 77-003,845. PUB. 5-22-2007, FILED 9-20-2006.

WRAPPLE

THE MARK CONSISTS OF STANDARD CHARACTERS WITHOUT CLAIM TO ANY PARTICULAR FONT, STYLE, SIZE, OR COLOR.

FOR BAKERY PASTRY PRODUCTS COMPRISING FRUITS, JAMS AND OTHER FILLINGS WRAPPED OR ROLLED IN A PIE CRUST, DRIZZLED WITH FROSTING (U.S. CL. 46).

FIRST USE 6-24-2007; IN COMMERCE 6-24-2007.

3,313,417. PF BRANDS, INC., NEWARK, DE. SN 78-351,963. PUB. 7-25-2006, FILED 1-14-2004.

**PEPPERIDGE FARM
CARB STYLE**

THE MARK CONSISTS OF STANDARD CHARACTERS WITHOUT CLAIM TO ANY PARTICULAR FONT, STYLE, SIZE, OR COLOR.

OWNER OF U.S. REG. NOS. 360,512, 2,396,052, AND OTHERS.

NO CLAIM IS MADE TO THE EXCLUSIVE RIGHT TO USE "CARB STYLE", APART FROM THE MARK AS SHOWN.

FOR BREAD (U.S. CL. 46). FIRST USE 5-31-2004; IN COMMERCE 5-31-2004.

CLASS 30—(Continued).

3,313,457. INNER MONGOLIA MENGNIU DAIRY (GROUP) CO., LTD., HUHROT, INNER MONGOLIA, CHINA. SN 78-431,373. PUB. 2-28-2006, FILED 6-7-2004.



THE MARK CONSISTS OF TWO CHINESE CHARACTERS AND A BLACK SQUARE DEVICE WITH A LINE SEPARATING A MOON DEVICE AND A WORD MENGNIU BEING THE TRANSLITERATION OF THE TWO CHINESE CHARACTERS.

THE ENGLISH TRANSLATION OF THE MARK IS MENGNIU, AND THIS MEANS COVER AND COW.

THE NON-LATIN CHARACTER(S) IN THE MARK TRANSLITERATES INTO MENGNIU, AND THIS MEANS COVER AND COW IN ENGLISH.

FOR TEA-BASED BEVERAGES, NAMELY, TEA-BASED BEVERAGES WITH FRUIT FLAVORING; SWEETMEATS; CANDY; CARAMELS; BISCUITS; CUSTARDS; ICE CREAM; CHOCOLATE FOOD BEVERAGES NOT BEING DAIRY-BASED OR VEGETABLE BASED; HOT CHOCOLATE; COCOA PRODUCTS, NAMELY, BISCUITS, CANDY AND PASTRIES; COFFEE; COFFEE-BASED BEVERAGES CONTAINING MILK; PREPARED COFFEE AND COFFEE-BASED BEVERAGES; PREPARED COCOA AND COCOA-BASED BEVERAGES; CHOCOLATE; ALIMENTARY PASTE; PUDDINGS; BREAD; PASTRIES; CONVENIENT NOODLES; FROZEN YOGURT; FLAVORED ICES; ICE CUBES; EDIBLE FRUIT ICES; SEASONINGS; SPICES; COCOA-BASED BEVERAGES CONTAINING MILK (U.S. CL. 46).

FIRST USE 8-1-2005; IN COMMERCE 10-28-2005.

3,313,465. FRIEDMANN, ALEXANDER, ANTIOCH, TN. SN 78-442,871. PUB. 5-31-2005, FILED 6-29-2004.

Moo Juicers

THE MARK CONSISTS OF STANDARD CHARACTERS WITHOUT CLAIM TO ANY PARTICULAR FONT, STYLE, SIZE, OR COLOR.

FOR FLAVORING SYRUPS FOR CREATING FLAVORED MILK DRINKS (U.S. CL. 46).

FIRST USE 5-3-2007; IN COMMERCE 5-3-2007.

CLASS 30—(Continued).

3,313,541. GODIVA BRANDS, INC., NEWARK, DE. SN 78-539,400. PUB. 11-29-2005, FILED 12-29-2004.



OWNER OF U.S. REG. NOS. 836,376, 1,010,810, AND OTHERS.

NO CLAIM IS MADE TO THE EXCLUSIVE RIGHT TO USE "CHOCOLATIER", APART FROM THE MARK AS SHOWN.

THE MARK CONSISTS OF A DESIGN DEPICTING A WOMAN ON HORSEBACK AND A STYLIZED "GODIVA CHOCOLATIER".

FOR CHOCOLATES; ICE CREAM; BAKED GOODS, NAMELY, COOKIES, MUFFINS, SCONES, BISCUITS, BISCOTTI, PASTRIES, CAKES, AND BREADS; HOT CHOCOLATE AND CHOCOLATE CONTAINING COCOA FOR MAKING HOT CHOCOLATE (U.S. CL. 46).

FIRST USE 0-0-2004; IN COMMERCE 0-0-2004.

3,313,542. GODIVA BRANDS, INC., NEWARK, DE. SN 78-539,407. PUB. 2-21-2006, FILED 12-29-2004.



OWNER OF U.S. REG. NOS. 873,139, 1,792,806, AND OTHERS.

THE MARK CONSISTS OF A DESIGN DEPICTING A WOMAN ON HORSEBACK.

FOR CHOCOLATES; ICE CREAM; BAKED GOODS, NAMELY, COOKIES, MUFFINS, SCONES, BISCUITS, PASTRIES, CAKES, AND BREADS; HOT CHOCOLATE AND CHOCOLATE CONTAINING COCOA FOR MAKING HOT CHOCOLATE (U.S. CL. 46).

FIRST USE 0-0-2004; IN COMMERCE 0-0-2004.

CLASS 30—(Continued).

3,313,584. MS. O'S EXCLUSIVE CATERING, INC., DETROIT, MI. SN 78-578,976. PUB. 3-14-2006, FILED 3-3-2005.

**MS. O'S ALL
PURPOSE
SEASONING**

THE MARK CONSISTS OF STANDARD CHARACTERS WITHOUT CLAIM TO ANY PARTICULAR FONT, STYLE, SIZE, OR COLOR.

NO CLAIM IS MADE TO THE EXCLUSIVE RIGHT TO USE "ALL PURPOSE SEASONING", APART FROM THE MARK AS SHOWN.

THE PRESENT MARK DOES NOT SPECIFY OR IDENTIFY A LIVING INDIVIDUAL.

FOR GENERAL ALL PURPOSE SEASONING (U.S. CL. 46).

FIRST USE 6-1-2006; IN COMMERCE 6-1-2006.

3,313,630. MARTIN, VICTOR L., SR., IRWINDALE, CA. SN 78-606,771. PUB. 7-4-2006, FILED 4-12-2005.

DEL SUR

THE MARK CONSISTS OF STANDARD CHARACTERS WITHOUT CLAIM TO ANY PARTICULAR FONT, STYLE, SIZE, OR COLOR.

THE ENGLISH TRANSLATION OF THE WORDS "DEL SUR" IS "FROM THE SOUTH".

FOR BARBECUE SAUCE (U.S. CL. 46).

FIRST USE 2-20-2007; IN COMMERCE 2-20-2007.

3,313,674. SCHWAN'S IP, LLC, MARSHALL, MN. SN 78-622,647. PUB. 3-6-2007, FILED 5-4-2005.

TONY'S PIZZA DIPPERS

THE MARK CONSISTS OF STANDARD CHARACTERS WITHOUT CLAIM TO ANY PARTICULAR FONT, STYLE, SIZE, OR COLOR.

OWNER OF U.S. REG. NOS. 1,255,465, 2,849,630, AND OTHERS.

NO CLAIM IS MADE TO THE EXCLUSIVE RIGHT TO

CLASS 30—(Continued).

USE "PIZZA", APART FROM THE MARK AS SHOWN.

THE NAME TONY'S DOES NOT IDENTIFY A LIVING INDIVIDUAL.

FOR STUFFED BREADSTICKS CONTAINING CHEESE, SAUCE AND VARIOUS SPICES WITH OR WITHOUT MEAT (U.S. CL. 46).

FIRST USE 10-1-2006; IN COMMERCE 10-1-2006.

3,313,755. SHIPLEY DO-NUT FLOUR AND SUPPLY CO., INC., HOUSTON, TX. SN 78-656,270. PUB. 3-7-2006, FILED 6-22-2005.

TRULY A HOLEY FOOD

THE MARK CONSISTS OF STANDARD CHARACTERS WITHOUT CLAIM TO ANY PARTICULAR FONT, STYLE, SIZE, OR COLOR.

NO CLAIM IS MADE TO THE EXCLUSIVE RIGHT TO USE FOOD, APART FROM THE MARK AS SHOWN.

FOR DOUGHNUTS, PASTRIES, TURNOVERS, CREAM-FILLED BAKERY BARS, CINNAMON ROLLS, ECLAIRS, FILLINGS OF CHOCOLATE AND CREAM NATURE FOR BAKERY PRODUCTS, FLOUR AND PASTRY ICINGS (U.S. CL. 46).

FIRST USE 5-1-2007; IN COMMERCE 5-1-2007.

3,313,826. RAVENWOLFE, OVERLAND, MO. SN 78-690,190. PUB. 10-17-2006, FILED 8-10-2005.



THE MARK CONSISTS OF WOLF HEAD IN CIRCLE. FOR SALSA (U.S. CL. 46).

FIRST USE 9-10-2005; IN COMMERCE 9-10-2005.

CLASS 30—(Continued).

3,313,959. GUMLINK A/S, VEJLE, DENMARK. SN 78-744,223.
PUB. 7-25-2006, FILED 11-1-2005.

ARCTIC AIR

THE MARK CONSISTS OF STANDARD CHARACTERS WITHOUT CLAIM TO ANY PARTICULAR FONT, STYLE, SIZE, OR COLOR.

FOR CONFECTIONERY, NAMELY NON-MEDICATED CHEWING GUM (U.S. CL. 46).
FIRST USE 10-31-2006; IN COMMERCE 10-31-2006.

3,313,960. GUMLINK A/S, VEJLE, DENMARK. SN 78-744,250.
PUB. 7-25-2006, FILED 11-1-2005.

BUBBLE BOOST

THE MARK CONSISTS OF STANDARD CHARACTERS WITHOUT CLAIM TO ANY PARTICULAR FONT, STYLE, SIZE, OR COLOR.

NO CLAIM IS MADE TO THE EXCLUSIVE RIGHT TO USE "BUBBLE", APART FROM THE MARK AS SHOWN.

FOR CONFECTIONERY, NAMELY NON-MEDICATED CHEWING GUM (U.S. CL. 46).
FIRST USE 10-31-2006; IN COMMERCE 10-31-2006.

3,314,038. FRITO-LAY NORTH AMERICA, INC., PLANO, TX. SN 78-759,978. PUB. 8-22-2006, FILED 11-23-2005.

CHEESE FIX

THE MARK CONSISTS OF STANDARD CHARACTERS WITHOUT CLAIM TO ANY PARTICULAR FONT, STYLE, SIZE, OR COLOR.

NO CLAIM IS MADE TO THE EXCLUSIVE RIGHT TO USE "CHEESE", APART FROM THE MARK AS SHOWN.

FOR SNACK MIX CONSISTING PRIMARILY OF TORTILLA CHIPS, CHEESE-FLAVORED PUFFED CORN SNACKS, PRETZELS AND MULTIGRAIN SNACK CHIPS (U.S. CL. 46).
FIRST USE 7-31-2005; IN COMMERCE 7-31-2005.

CLASS 30—(Continued).

3,314,267. LEGAL SEA FOODS, BOSTON, MA. SN 78-797,101.
PUB. 4-3-2007, FILED 1-23-2006.

LEGAL INDULGENCES

THE MARK CONSISTS OF STANDARD CHARACTERS WITHOUT CLAIM TO ANY PARTICULAR FONT, STYLE, SIZE, OR COLOR.

FOR DESSERTS, NAMELY, ICE CREAMS, CAKES, PIES, PUDDINGS, MOUSSES, COOKIES, TARTS, CHOCOLATE SQUARES AND FRUIT SQUARES (U.S. CL. 46).
FIRST USE 12-31-2006; IN COMMERCE 12-31-2006.

3,314,285. MR. GOODNUTTS, INC., LAS VEGAS, NV. SN 78-801,845. PUB. 3-20-2007, FILED 1-29-2006.

JOEY NUTZ

THE MARK CONSISTS OF STANDARD CHARACTERS WITHOUT CLAIM TO ANY PARTICULAR FONT, STYLE, SIZE, OR COLOR.

NO CLAIM IS MADE TO THE EXCLUSIVE RIGHT TO USE "NUTS", APART FROM THE MARK AS SHOWN.

THE NAME "JOEY NUTZ" DOES NOT IDENTIFY A LIVING INDIVIDUAL.

FOR CHOCOLATE COVERED NUTS, CHOCOLATE AND CARAMEL COVERED NUTS, CHOCOLATE AND CARAMEL COVERED POPCORN, CINNAMON AND SUGAR COATED NUTS, CINNAMON AND SUGAR COATED POPCORN (U.S. CL. 46).
FIRST USE 6-1-2006; IN COMMERCE 6-1-2006.

3,314,339. HESSON, LYNN ANTHONY, NEENAH, WI. SN 78-812,792. PUB. 10-17-2006, FILED 2-11-2006.

POP'RS

THE MARK CONSISTS OF STANDARD CHARACTERS WITHOUT CLAIM TO ANY PARTICULAR FONT, STYLE, SIZE, OR COLOR.

FOR TOPPING FOR FOOD CONSISTING OF CARBONATED SUGARS BLENDED WITH OTHER DRY INGREDIENTS AND FLAVORS (U.S. CL. 46).
FIRST USE 3-1-2006; IN COMMERCE 3-15-2006.

CLASS 30—(Continued).

3,314,352. MARS, INCORPORATED, MCLEAN, VA. SN 78-814,608. PUB. 4-17-2007, FILED 2-14-2006.

DISCO BERRY

THE MARK CONSISTS OF STANDARD CHARACTERS WITHOUT CLAIM TO ANY PARTICULAR FONT, STYLE, SIZE, OR COLOR.

NO CLAIM IS MADE TO THE EXCLUSIVE RIGHT TO USE "BERRY", APART FROM THE MARK AS SHOWN.

FOR CONFECTIONERY, NAMELY, CANDY (U.S. CL. 46).

FIRST USE 5-0-2007; IN COMMERCE 5-0-2007.

3,314,361. MERISANT COMPANY, CHICAGO, IL. SN 78-816,285. PUB. 5-15-2007, FILED 2-16-2006.



OWNER OF U.S. REG. NOS. 1,158,683 AND 1,318,800. THE COLOR(S) WHITE, BLUE, PINK, YELLOW, GREEN AND ORANGE IS/ARE CLAIMED AS A FEATURE OF THE MARK.

THE MARK CONSISTS OF THE WORD EQUAL AND A SERIES OF COLORED DOTS ABOVE THE WORD. THE COLOR WHITE APPEARS IN THE WORD EQUAL AND A CIRCLE, THE COLOR BLUE APPEARS IN THE RECTANGLE AND CIRCLES AND THE COLORS PINK, YELLOW, GREEN, AND ORANGE APPEAR IN CIRCLES.

FOR SUGAR SUBSTITUTES; FLAVORED POWDERED SWEETENER, PRINCIPALLY BY WEIGHT OF NATURAL SWEETENER; FLAVORED GRANULATED SWEETENER, PRINCIPALLY OF NATURAL SWEETENER; POWDERED OR GRANULATED NON-NUTRITIONAL FLAVORINGS FOR USE AS ADDITIVES TO BEVERAGES, NAMELY, COFFEE, TEA, BOTTLED WATER, AND OTHER BEVERAGES (U.S. CL. 46).

FIRST USE 6-23-2006; IN COMMERCE 6-23-2006.

3,314,473. CHOCOLADEFABRIKEN LINDT & SPRÜNGLI AG, KILCHBERG, SWITZERLAND. SN 78-842,036. PUB. 12-12-2006, FILED 3-21-2006.

MINT BLISS

THE MARK CONSISTS OF STANDARD CHARACTERS WITHOUT CLAIM TO ANY PARTICULAR FONT, STYLE, SIZE, OR COLOR.

CLASS 30—(Continued).

NO CLAIM IS MADE TO THE EXCLUSIVE RIGHT TO USE "MINT", APART FROM THE MARK AS SHOWN. FOR CHOCOLATE BARS (U.S. CL. 46). FIRST USE 10-31-2006; IN COMMERCE 10-31-2006.

3,314,519. KYOKUYO CO., LTD., TOKYO, JAPAN. SN 78-860,937. PUB. 11-21-2006, FILED 4-13-2006.

POLAR SEAS

THE MARK CONSISTS OF STANDARD CHARACTERS WITHOUT CLAIM TO ANY PARTICULAR FONT, STYLE, SIZE, OR COLOR.

OWNER OF U.S. REG. NO. 1,388,450. FOR FROZEN OR REFRIGERATED SUSHI (U.S. CL. 46).

FIRST USE 11-1-2006; IN COMMERCE 11-1-2006.

3,314,520. SAVE-A-LOT FOOD STORES, LTD., EARTH CITY, MO. SN 78-861,118. PUB. 10-31-2006, FILED 4-13-2006.

CHIPTASTIC!

THE MARK CONSISTS OF STANDARD CHARACTERS WITHOUT CLAIM TO ANY PARTICULAR FONT, STYLE, SIZE, OR COLOR.

FOR COOKIES (U.S. CL. 46). FIRST USE 4-14-2007; IN COMMERCE 4-14-2007.

3,314,527. CADBURY ADAMS CANADA INC., TORONTO, CANADA. SN 78-863,549. PUB. 11-28-2006, FILED 4-18-2006.

SOUR PATCH XPLODERZ

THE MARK CONSISTS OF STANDARD CHARACTERS WITHOUT CLAIM TO ANY PARTICULAR FONT, STYLE, SIZE, OR COLOR.

OWNER OF U.S. REG. NOS. 2,304,261, 2,595,207, AND 2,927,021.

NO CLAIM IS MADE TO THE EXCLUSIVE RIGHT TO USE "SOUR", APART FROM THE MARK AS SHOWN.

FOR CONFECTIONERY, NAMELY CANDY (U.S. CL. 46).

FIRST USE 5-14-2007; IN COMMERCE 5-14-2007.

CLASS 30—(Continued).

3,314,546. SNIKIDDY, LLC, BETHESDA, MD. SN 78-870,850.
PUB. 11-28-2006, FILED 4-27-2006.

Banana Nibbles

THE MARK CONSISTS OF STANDARD CHARACTERS WITHOUT CLAIM TO ANY PARTICULAR FONT, STYLE, SIZE, OR COLOR.

NO CLAIM IS MADE TO THE EXCLUSIVE RIGHT TO USE "BANANA", APART FROM THE MARK AS SHOWN.

FOR FOOD PACKAGE COMBINATIONS CONSISTING PRIMARILY OF BREAD, CRACKERS AND/OR COOKIES; WHEAT-BASED SNACK FOODS (U.S. CL. 46).
FIRST USE 7-31-2006; IN COMMERCE 9-30-2006.

3,314,547. BESOS INC., INDIALANTIC, FL. SN 78-871,001.
PUB. 12-5-2006, FILED 4-27-2006.

Rica Mala Chica

THE MARK CONSISTS OF STANDARD CHARACTERS WITHOUT CLAIM TO ANY PARTICULAR FONT, STYLE, SIZE, OR COLOR.

THE ENGLISH TRANSLATION OF THE SPANISH WORDING "RICA MALA CHICA" IS "RICH BAD GIRL".
FOR COFFEE (U.S. CL. 46).

FIRST USE 3-1-2007; IN COMMERCE 3-1-2007.

3,314,581. LEWIS BROTHERS BAKERIES, INCORPORATED, DBA LEWIS BAKERIES, INC., EVANSVILLE, IN. SN 78-882,348. PUB. 12-12-2006, FILED 5-12-2006.

WHOLEHEARTEDLY

THE MARK CONSISTS OF STANDARD CHARACTERS WITHOUT CLAIM TO ANY PARTICULAR FONT, STYLE, SIZE, OR COLOR.

FOR BAKERY PRODUCTS (U.S. CL. 46).

FIRST USE 1-17-2006; IN COMMERCE 1-17-2006.

CLASS 30—(Continued).

3,314,583. CHOCOFRESH, INC., BUFFALO, NY. SN 78-882,691. PUB. 12-26-2006, FILED 5-12-2006.

NEW WORLD CHOCOLATE

THE MARK CONSISTS OF STANDARD CHARACTERS WITHOUT CLAIM TO ANY PARTICULAR FONT, STYLE, SIZE, OR COLOR.

NO CLAIM IS MADE TO THE EXCLUSIVE RIGHT TO USE "CHOCOLATE", APART FROM THE MARK AS SHOWN.

FOR CHOCOLATE (U.S. CL. 46).

FIRST USE 6-1-2006; IN COMMERCE 6-1-2006.

3,314,628. HAWAIIAN HOST, INC., HONOLULU, HI. SN 78-894,469. PUB. 12-26-2006, FILED 5-26-2006.

KONA CARAMACS

THE MARK CONSISTS OF STANDARD CHARACTERS WITHOUT CLAIM TO ANY PARTICULAR FONT, STYLE, SIZE, OR COLOR.

OWNER OF U.S. REG. NOS. 1,402,389 AND 1,439,353.

NO CLAIM IS MADE TO THE EXCLUSIVE RIGHT TO USE "KONA", APART FROM THE MARK AS SHOWN.

FOR CONFECTIONERY, NAMELY CHOCOLATE COVERED CANDIES AND NUTS; CANDY MINTS; CARAMEL AND NUT CANDIES; PEANUT BRITTLES; CANDIED POPCORN; GLAZED POPCORN; COOKIES; AND COFFEE (U.S. CL. 46).

FIRST USE 4-26-2007; IN COMMERCE 4-26-2007.

3,314,681. GUTHRIE, ARLO D., PITTSFIELD, MA. SN 78-906,136. PUB. 1-30-2007, FILED 6-12-2006.



OWNER OF U.S. REG. NO. 3,123,394.
NO CLAIM IS MADE TO THE EXCLUSIVE RIGHT TO USE "SYRUP", "ORIGINAL MAPLE & MOLASSES", "ALL NATURAL INGREDIENTS: CANE SUGAR SYRUP PURE MAPLE SYRUP GRADE A MOLASSES", "MANUFACTURED BY CHARLES H. BALDWIN & SONS WEST STOCKBRIDGE, MA", "EXCLUSIVELY FOR RISING SON INTERNATIONAL, LTD", "COMMENTS: BATTLEGROUND@RISINGSON.COM," AND "REFRIGERATE AFTER OPENING", APART FROM THE MARK AS SHOWN.

THE PORTRAIT IN THE MARK OF THE FEMALE WITH RED HAIR DOES NOT IDENTIFY A LIVING INDIVIDUAL.

CLASS 30—(Continued).

THE COLOR(S) BLUE BROWN BLACK WHITE ORANGE YELLOW RED GRAY PINK BEIGE IS/ARE CLAIMED AS A FEATURE OF THE MARK.

THE MARK CONSISTS OF THE TRADE DRESS OF A LABEL, COMPRISING A BLUE FIELD BEHIND A BROWN TREE TRUNK WITH BRANCHES AND YELLOW AND ORANGE LEAVES; AN IMAGE OF A FICTIONAL WOMAN WITH PINKISH SKIN, RED AND ORANGE HAIR, WEARING A BEIGE BUSTIER AND SKIRT AND HOLDING A BROWN, COVERED BUCKET; A PICTURE OF THE APPLICANT, ARLO D. GUTHRIE'S, FACE, WITH PINKISH SKIN AND WHITE AND GRAY HAIR, SURROUNDED BY BLACK AND WHITE BORDER; BLACK, WHITE, YELLOW, ORANGE AND RED LETTERING.

FOR MAPLE SYRUP, MOLASSES SYRUP, PANCAKE SYRUP, TABLE SYRUP, TOPPING SYRUP (U.S. CL. 46).
FIRST USE 11-1-2006; IN COMMERCE 11-1-2006.

3,314,758. THE HAIN CELESTIAL GROUP, INC., MELVILLE, NY. SN 78-930,676. PUB. 3-27-2007, FILED 7-17-2006.

ROSETTO GOURMET

THE MARK CONSISTS OF STANDARD CHARACTERS WITHOUT CLAIM TO ANY PARTICULAR FONT, STYLE, SIZE, OR COLOR.

OWNER OF U.S. REG. NOS. 1,026,312 AND 2,099,331.
NO CLAIM IS MADE TO THE EXCLUSIVE RIGHT TO USE "GOURMET", APART FROM THE MARK AS SHOWN.
FOR RAVIOLI (U.S. CL. 46).
FIRST USE 1-1-2007; IN COMMERCE 1-1-2007.

3,314,778. ARAMARK CORPORATION, PHILADELPHIA, PA. SN 78-938,739. PUB. 1-2-2007, FILED 7-27-2006.

QUICHE-ADILLA

THE MARK CONSISTS OF STANDARD CHARACTERS WITHOUT CLAIM TO ANY PARTICULAR FONT, STYLE, SIZE, OR COLOR.

FOR TORTILLA-BASED SHELLS WITH FILLING CONSISTING PRIMARILY OF VEGETABLES, CHEESE, MEATS, POULTRY, FISH, AND FRUITS (U.S. CL. 46).
FIRST USE 11-1-2006; IN COMMERCE 11-1-2006.

CLASS 30—(Continued).

3,314,819. CAMBIASO HERMANOS SAC, VALPARAISO, CHILE. SN 78-951,884. PUB. 2-20-2007, FILED 8-14-2006.

**STRAIGHT FROM OUR GARDEN
TO YOU**

THE MARK CONSISTS OF STANDARD CHARACTERS WITHOUT CLAIM TO ANY PARTICULAR FONT, STYLE, SIZE, OR COLOR.

FOR BLACK TEA; FRUIT TEAS; GREEN TEA; HERB TEA; HERBAL TEA; JAPANESE GREEN TEA; TEA (U.S. CL. 46).
FIRST USE 11-27-2006; IN COMMERCE 11-27-2006.

3,314,820. FORD GUM & MACHINE CO., INC., AKRON, NY. SN 78-952,266. PUB. 4-10-2007, FILED 8-15-2006.

**EASTER EGG SURPRISE
LOLLIPOPS**

THE MARK CONSISTS OF STANDARD CHARACTERS WITHOUT CLAIM TO ANY PARTICULAR FONT, STYLE, SIZE, OR COLOR.

NO CLAIM IS MADE TO THE EXCLUSIVE RIGHT TO USE "LOLLIPOPS", APART FROM THE MARK AS SHOWN.
FOR CANDY (U.S. CL. 46).
FIRST USE 12-0-2006; IN COMMERCE 12-0-2006.

3,314,897. CAPCO ENTERPRISES INC., EAST HANOVER, NJ. SN 78-977,301. PUB. 9-12-2006, FILED 11-21-2005.

NUTIBLES

THE MARK CONSISTS OF STANDARD CHARACTERS WITHOUT CLAIM TO ANY PARTICULAR FONT, STYLE, SIZE, OR COLOR.

FOR LICORICE MINI'S (U.S. CL. 46).
FIRST USE 11-6-2006; IN COMMERCE 11-6-2006.

CLASS 31—NATURAL AGRICULTURAL PRODUCTS

CLASS 31—(Continued).

3,313,063. SUNTORY FLOWERS LIMITED, TOKYO, JAPAN.
SN 76-604,823. PUB. 10-3-2006, FILED 7-30-2004.

ILUMINA

THE MARK CONSISTS OF STANDARD CHARACTERS WITHOUT CLAIM TO ANY PARTICULAR FONT, STYLE, SIZE, OR COLOR.

FOR SEEDLINGS, LIVE PLANTS AND LIVE FLOWERS, NOT INCLUDING BEGONIA BULBS OR PLANTS (U.S. CLS. 1 AND 46).

FIRST USE 4-2-2004; IN COMMERCE 4-2-2004.

3,313,323. SOCIETE DES PRODUITS NESTLE S.A., VEVEY, SWITZERLAND. SN 77-038,601. PUB. 3-20-2007, FILED 11-7-2006.

SEAFOOD SENSATIONS

THE MARK CONSISTS OF STANDARD CHARACTERS WITHOUT CLAIM TO ANY PARTICULAR FONT, STYLE, SIZE, OR COLOR.

NO CLAIM IS MADE TO THE EXCLUSIVE RIGHT TO USE "SEAFOOD", APART FROM THE MARK AS SHOWN.

FOR PET FOOD (U.S. CLS. 1 AND 46).
FIRST USE 6-18-2007; IN COMMERCE 6-18-2007.

3,313,325. MARS, INCORPORATED, MCLEAN, VA. SN 77-041,072. PUB. 3-27-2007, FILED 11-9-2006.



THE MARK CONSISTS OF A SPECIAL PARALLELOGRAM CONTAINING THE WORDS THE GOODLIFE RECIPE IN STYLIZED LETTERING WITH TWO HEART-SHAPED DOTTED "I".

FOR PET FOOD (U.S. CLS. 1 AND 46).
FIRST USE 12-13-2006; IN COMMERCE 12-13-2006.

CLASS 31—(Continued).

3,313,327. SOCIETE DES PRODUITS NESTLE S.A., VEVEY, SWITZERLAND. SN 77-045,257. PUB. 3-20-2007, FILED 11-16-2006.

TENDER MOMENTS

THE MARK CONSISTS OF STANDARD CHARACTERS WITHOUT CLAIM TO ANY PARTICULAR FONT, STYLE, SIZE, OR COLOR.

FOR PET FOOD (U.S. CLS. 1 AND 46).
FIRST USE 4-2-2007; IN COMMERCE 4-2-2007.

3,313,356. THE REGENTS OF THE UNIVERSITY OF CALIFORNIA, OAKLAND, CA. SN 78-140,320. PUB. 2-3-2004, FILED 7-1-2002.

SHASTA GOLD

FOR FRESH CITRUS FRUIT AND LIVING CITRUS TREES (U.S. CLS. 1 AND 46).
FIRST USE 3-10-2003; IN COMMERCE 3-10-2003.

3,313,589. WINDSET GREENHOUSES LIMITED PARTNERSHIP, BRITISH COLUMBIA, CANADA. SN 78-582,285. PUB. 8-29-2006, FILED 3-8-2005.

MAESTRO

THE MARK CONSISTS OF STANDARD CHARACTERS WITHOUT CLAIM TO ANY PARTICULAR FONT, STYLE, SIZE, OR COLOR.

PRIORITY CLAIMED UNDER SEC. 44(D) ON CANADA APPLICATION NO. 1248006, FILED 2-21-2005, REG. NO. TMA661.261, DATED 3-23-2006, EXPIRES 3-23-2021.

FOR UNPROCESSED BELL PEPPERS (U.S. CLS. 1 AND 46).
FIRST USE 3-15-2005; IN COMMERCE 3-15-2005.

CLASS 31—(Continued).

3,313,644. J.R. SIMPLOT COMPANY, BOISE, ID. SN 78-610,701. PUB. 1-24-2006, FILED 4-18-2005.

CAMAS

THE MARK CONSISTS OF STANDARD CHARACTERS WITHOUT CLAIM TO ANY PARTICULAR FONT, STYLE, SIZE, OR COLOR.
FOR GRASS SEED (U.S. CLS. 1 AND 46).
FIRST USE 8-0-2005; IN COMMERCE 8-0-2005.

3,313,685. BALL HORTICULTURAL COMPANY, WEST CHICAGO, IL. SN 78-626,290. PUB. 8-29-2006, FILED 5-10-2005.

ZESTY

THE MARK CONSISTS OF STANDARD CHARACTERS WITHOUT CLAIM TO ANY PARTICULAR FONT, STYLE, SIZE, OR COLOR.
FOR LIVING HORTICULTURAL PLANTS AND PLANT SEEDS (U.S. CLS. 1 AND 46).
FIRST USE 11-1-2005; IN COMMERCE 11-1-2005.

3,313,693. EUROAMERICAN PROPAGATORS, LLC, BONSALL, CA. SN 78-628,007. PUB. 9-5-2006, FILED 5-11-2005.

BY MARGEE

THE MARK CONSISTS OF STANDARD CHARACTERS WITHOUT CLAIM TO ANY PARTICULAR FONT, STYLE, SIZE, OR COLOR.
FOR LIVE PLANT CUTTINGS; WREATHS, KISSING BALLS AND CUSTOM FORM TOPIARIES FORMED BY LIVE PLANTS (U.S. CLS. 1 AND 46).
FIRST USE 4-15-2007; IN COMMERCE 4-15-2007.

CLASS 31—(Continued).

3,313,696. LAS 5 ESTACIONES S.P.R. DE R.L., GUANAJUATO, MEXICO. SN 78-630,125. PUB. 8-1-2006, FILED 5-15-2005.

HAPPY VEGGIES

THE MARK CONSISTS OF STANDARD CHARACTERS WITHOUT CLAIM TO ANY PARTICULAR FONT, STYLE, SIZE, OR COLOR.

NO CLAIM IS MADE TO THE EXCLUSIVE RIGHT TO USE "VEGGIES", APART FROM THE MARK AS SHOWN.
FOR UNPROCESSED, RAW AND FRESH VEGETABLES, NAMELY, CARROTS, BABY CARROTS, BROCCOLI, LETTUCE, CELERY, ZUCCHINI, CUCUMBERS, TOMATOES, CAULIFLOWER, ONIONS, PEAS, CORN, CORNCOBS, RAW SWEET PEPPERS, AND RAW CILANTRO (U.S. CLS. 1 AND 46).
FIRST USE 5-2-2005; IN COMMERCE 4-6-2006.

3,313,847. EFFEM EQUINE LIMITED, SLOUGH BERKSHIRE, UNITED KINGDOM. SN 78-700,253. PUB. 9-5-2006, FILED 8-25-2005.

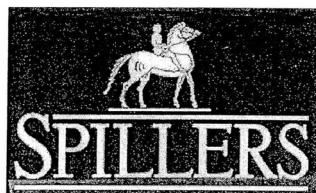

OWNER OF U.S. REG. NOS. 2,083,302 AND 2,118,688.
THE MARK CONSISTS OF THE WORD "SPILLERS" PLACED BETWEEN TWO HORIZONTAL LINES. CENTERED ABOVE THE WORD "SPILLERS" IS A MAN RIDING A HORSE, WHICH IS STANDING ON A HORIZONTAL LINE.
FOR FEED AND FOODSTUFFS FOR ANIMALS (U.S. CLS. 1 AND 46).
FIRST USE 0-0-1996; IN COMMERCE 0-0-1996.

3,313,904. DARDEN CONCEPTS, INC., ORLANDO, FL. SN 78-723,103. PUB. 9-19-2006, FILED 9-29-2005.

NOURISH AND DELIGHT

THE MARK CONSISTS OF STANDARD CHARACTERS WITHOUT CLAIM TO ANY PARTICULAR FONT, STYLE, SIZE, OR COLOR.
FOR FRESH FRUITS; FRESH VEGETABLES (U.S. CLS. 1 AND 46).
FIRST USE 1-31-2006; IN COMMERCE 1-31-2006.

CLASS 31—(Continued).

3,313,958. TEXAS FARM PRODUCTS HOLDING COMPANY, NACOGDOCHES, TX. SN 78-744,159. PUB. 9-12-2006, FILED 11-1-2005.

NUTRITIONAL HEALTH FOR LIFE

THE MARK CONSISTS OF STANDARD CHARACTERS WITHOUT CLAIM TO ANY PARTICULAR FONT, STYLE, SIZE, OR COLOR.

NO CLAIM IS MADE TO THE EXCLUSIVE RIGHT TO USE "NUTRITIONAL HEALTH", APART FROM THE MARK AS SHOWN.

FOR PET FOOD AND ANIMAL FEED (U.S. CLS. 1 AND 46).

FIRST USE 1-22-2007; IN COMMERCE 1-22-2007.

3,314,076. CLEAR CHOICE GREENHOUSES, LLC., THONOTOSASSA, FL. SN 78-765,454. PUB. 9-19-2006, FILED 12-2-2005.



NO CLAIM IS MADE TO THE EXCLUSIVE RIGHT TO USE "ORGANIC STRAWBERRIES", APART FROM THE MARK AS SHOWN.

THE COLOR(S) RED, GREEN, AND DARK GREEN IS/ ARE CLAIMED AS A FEATURE OF THE MARK.

THE MARK CONSISTS OF RED IS USED ON THE WORDS CLEAR CHOICE AND THE IMAGE OF THE STRAWBERRY FRUIT. GREEN IS USED ON STEM AND LEAVES, THE LINE UNDERNEATH THE WORDS CLEAR CHOICE, AND THE TEXT "ORGANIC STRAWBERRIES". DARK GREEN IS USED ON THE LEAVES ON THE IMAGE OF THE STRAWBERRY.

FOR FRUITS, NAMELY, STRAWBERRIES (U.S. CLS. 1 AND 46).

FIRST USE 11-0-2005; IN COMMERCE 11-0-2005.

CLASS 31—(Continued).

3,314,091. SIMMONS PET FOOD, INC., SILOAM SPRINGS, AR. SN 78-767,860. PUB. 8-1-2006, FILED 12-6-2005.

HEALTHY BY DESIGN

THE MARK CONSISTS OF STANDARD CHARACTERS WITHOUT CLAIM TO ANY PARTICULAR FONT, STYLE, SIZE, OR COLOR.

FOR PET FOOD, NAMELY, NUTRITIONAL DOG FOOD AND CAT FOOD AND NUTRITIONAL SNACKS FOR DOGS AND CATS (U.S. CLS. 1 AND 46).

FIRST USE 5-5-2006; IN COMMERCE 5-5-2006.

3,314,161. WAGNER GREENHOUSES, INC., MINNEAPOLIS, MN. SN 78-778,179. PUB. 8-22-2006, FILED 12-21-2005.

MERRY BERRY

THE MARK CONSISTS OF STANDARD CHARACTERS WITHOUT CLAIM TO ANY PARTICULAR FONT, STYLE, SIZE, OR COLOR.

FOR LIVING PLANTS AND LIVE FLOWERING PLANTS (U.S. CLS. 1 AND 46).

FIRST USE 12-0-2006; IN COMMERCE 12-0-2006.

3,314,250. SUN SEED COMPANY, INC., BOWLING GREEN, OH. SN 78-794,533. PUB. 9-12-2006, FILED 1-19-2006.

ROAST TOASTIES

THE MARK CONSISTS OF STANDARD CHARACTERS WITHOUT CLAIM TO ANY PARTICULAR FONT, STYLE, SIZE, OR COLOR.

NO CLAIM IS MADE TO THE EXCLUSIVE RIGHT TO USE "ROAST", APART FROM THE MARK AS SHOWN.

FOR ANIMAL TREATS, ANIMAL SNACKS, FOOD FOR ANIMALS, PET SNACKS, PET TREATS, PET FOOD, DOG TREATS (U.S. CLS. 1 AND 46).

FIRST USE 10-0-2005; IN COMMERCE 10-0-2005.

CLASS 31—(Continued).

3,314,306. PERI, DAVID J., YERINGTON, NV. SN 78-806,511. PUB. 5-8-2007, FILED 2-3-2006.

SWEETIE SWEET

THE MARK CONSISTS OF STANDARD CHARACTERS WITHOUT CLAIM TO ANY PARTICULAR FONT, STYLE, SIZE, OR COLOR.
NO CLAIM IS MADE TO THE EXCLUSIVE RIGHT TO USE "SWEET", APART FROM THE MARK AS SHOWN.
FOR FRESH ONIONS (U.S. CLS. 1 AND 46).
FIRST USE 9-1-2006; IN COMMERCE 9-1-2006.

3,314,723. HUBBARD FEEDS INC., MANKATO, MN. SN 78-917,059. PUB. 2-13-2007, FILED 6-26-2006.

FRONT RUNNER COOL COMMAND

THE MARK CONSISTS OF STANDARD CHARACTERS WITHOUT CLAIM TO ANY PARTICULAR FONT, STYLE, SIZE, OR COLOR.
OWNER OF U.S. REG. NO. 941,615.
FOR HORSE FEED (U.S. CLS. 1 AND 46).
FIRST USE 9-30-2006; IN COMMERCE 9-30-2006.

3,314,750. COSTA NURSERY FARMS LLC, GOULDS, FL. SN 78-925,964. PUB. 2-20-2007, FILED 7-10-2006.

Florennials

THE MARK CONSISTS OF STANDARD CHARACTERS WITHOUT CLAIM TO ANY PARTICULAR FONT, STYLE, SIZE, OR COLOR.
FOR LIVE FLOWERS AND LIVING PLANTS (U.S. CLS. 1 AND 46).
FIRST USE 4-15-2007; IN COMMERCE 4-15-2007.

CLASS 31—(Continued).

3,314,793. AGRICOLA EL ROSAL, S.A. DE C.V., NUMARAN, MEXICO. SN 78-942,145. PUB. 3-13-2007, FILED 8-1-2006.

GOLDEN SUN

THE MARK CONSISTS OF STANDARD CHARACTERS WITHOUT CLAIM TO ANY PARTICULAR FONT, STYLE, SIZE, OR COLOR.
FOR FRESH PEPPERS (U.S. CLS. 1 AND 46).
FIRST USE 10-0-2006; IN COMMERCE 10-0-2006.

3,314,796. HUBBARD FEEDS INC., MANKATO, MN. SN 78-943,461. PUB. 1-23-2007, FILED 8-2-2006.

COOL COMMAND

THE MARK CONSISTS OF STANDARD CHARACTERS WITHOUT CLAIM TO ANY PARTICULAR FONT, STYLE, SIZE, OR COLOR.
FOR ANIMAL FEED (U.S. CLS. 1 AND 46).
FIRST USE 9-30-2006; IN COMMERCE 9-30-2006.

3,314,811. SOCIETE DES PRODUITS NESTLE S.A., VEVEY, SWITZERLAND. SN 78-949,173. PUB. 4-3-2007, FILED 8-10-2006.



OWNER OF U.S. REG. NOS. 523,420, 2,709,802, AND OTHERS.
NO CLAIM IS MADE TO THE EXCLUSIVE RIGHT TO USE "VETERINARY DIETS", APART FROM THE MARK AS SHOWN.
THE MARK CONSISTS OF A THREE LINE DEVICE OF THREE STACKED WORDS: FIRST LINE IS A 9-SQUARE CHECKERBOARD INSIDE A SQUARE AND THE WORD PURINA INSIDE A DARKEN RECTANGLE; SECOND LINE IS THE WORD VETERINARY WITH A STYLIZED LETTER R; THIRD LINE IS THE WORD DIETS.
FOR PET FOOD (U.S. CLS. 1 AND 46).
FIRST USE 11-1-2006; IN COMMERCE 11-1-2006.

CLASS 31—(Continued).

3,314,886. MAT, INC., FLOODWOOD, MN. SN 78-970,364.
PUB. 5-8-2007, FILED 9-8-2006.

Flex Guard

THE MARK CONSISTS OF STANDARD CHARACTERS WITHOUT CLAIM TO ANY PARTICULAR FONT, STYLE, SIZE, OR COLOR.

FOR MULCH (U.S. CLS. 1 AND 46).
FIRST USE 12-1-2006; IN COMMERCE 12-1-2006.

3,314,891. GC ORGANICS LLC, CEDAR CREEK, TX. SN 78-972,173. PUB. 5-1-2007, FILED 9-12-2006.

RELIABLE ORGANICS

THE MARK CONSISTS OF STANDARD CHARACTERS WITHOUT CLAIM TO ANY PARTICULAR FONT, STYLE, SIZE, OR COLOR.

NO CLAIM IS MADE TO THE EXCLUSIVE RIGHT TO USE "ORGANICS", APART FROM THE MARK AS SHOWN.

FOR FRESH AND RAW FRUITS AND VEGETABLES; UNPROCESSED FRUITS AND VEGETABLES (U.S. CLS. 1 AND 46).

FIRST USE 9-15-2006; IN COMMERCE 9-15-2006.

CLASS 32—LIGHT BEVERAGES

3,313,240. A J BARBATO, OAKLAND PARK, FL. SN 77-000,255. PUB. 4-3-2007, FILED 9-15-2006.

AMMUNITION

THE MARK CONSISTS OF STANDARD CHARACTERS WITHOUT CLAIM TO ANY PARTICULAR FONT, STYLE, SIZE, OR COLOR.

FOR NON-ALCOHOLIC BEVERAGES, NAMELY, FRUIT FLAVORED DRINKS AND CONCENTRATES (U.S. CLS. 45, 46 AND 48).

FIRST USE 1-10-2007; IN COMMERCE 5-3-2007.

CLASS 32—(Continued).

3,313,514. KABUSHIKI KAISHA HITA TENRYOSUI, OITAKEN, JAPAN. SN 78-508,656. PUB. 2-7-2006, FILED 10-29-2004.



THE MARK CONSISTS OF THE WORDS H WITH ENERGY AND A GLOBE DESIGN.

FOR MINERAL WATER, DRINKING WATER (U.S. CLS. 45, 46 AND 48).

FIRST USE 2-22-2000; IN COMMERCE 12-0-2006.

3,313,553. THE COCA-COLA COMPANY, ATLANTA, GA. SN 78-550,657. PUB. 8-29-2006, FILED 1-20-2005.

COCA-COLA BLĀK

PRIORITY CLAIMED UNDER SEC. 44(D) ON AUSTRALIA APPLICATION NO. 1023596, FILED 10-5-2004.

OWNER OF U.S. REG. NOS. 22,406, 1,432,152, AND OTHERS.

FOR NON-ALCOHOLIC BEVERAGES, NAMELY, CARBONATED SOFT DRINKS; SYRUPS AND CONCENTRATES FOR MAKING BEVERAGES, NAMELY CARBONATED SOFT DRINKS (U.S. CLS. 45, 46 AND 48).

FIRST USE 4-3-2006; IN COMMERCE 4-3-2006.

CLASS 32—(Continued).

3,313,608. FLOREZ, STAN R., BONNEY LAKE, WA. SN 78-591,250. PUB. 6-6-2006, FILED 3-21-2005.

FIRE WATER

THE MARK CONSISTS OF STANDARD CHARACTERS WITHOUT CLAIM TO ANY PARTICULAR FONT, STYLE, SIZE, OR COLOR.

NO CLAIM IS MADE TO THE EXCLUSIVE RIGHT TO USE "WATER", APART FROM THE MARK AS SHOWN.

FOR BOTTLED DRINKING WATER (U.S. CLS. 45, 46 AND 48).

FIRST USE 1-1-2005; IN COMMERCE 1-1-2005.

3,313,786. JEANNIE, INC., MILWAUKEE, WI. SN 78-670,972. PUB. 4-11-2006, FILED 7-14-2005.

WILD RIDE

THE MARK CONSISTS OF STANDARD CHARACTERS WITHOUT CLAIM TO ANY PARTICULAR FONT, STYLE, SIZE, OR COLOR.

FOR CARBONATED ENERGY DRINKS (U.S. CLS. 45, 46 AND 48).

FIRST USE 8-0-2005; IN COMMERCE 8-0-2005.

3,314,051. ARCTIC NATURAL WATERS LIMITED, LONDON, ENGLAND. SN 78-761,898. PUB. 3-27-2007, FILED 11-28-2005.

Isboks

THE MARK CONSISTS OF STANDARD CHARACTERS WITHOUT CLAIM TO ANY PARTICULAR FONT, STYLE, SIZE, OR COLOR.

THE FOREIGN WORDING IN THE MARK TRANSLATES INTO ENGLISH AS ICEBERG.

FOR BOTTLED WATER, NAMELY, MINERAL AND AERATED (U.S. CLS. 45, 46 AND 48).

FIRST USE 7-1-2007; IN COMMERCE 7-1-2007.

CLASS 32—(Continued).

3,314,248. VERYFINE PRODUCTS, INC., NORTHFIELD, IL. SN 78-794,105. PUB. 9-26-2006, FILED 1-18-2006.



OWNER OF U.S. REG. NOS. 2,419,817 AND 2,848,822.
NO CLAIM IS MADE TO THE EXCLUSIVE RIGHT TO USE "NO CALORIES", APART FROM THE MARK AS SHOWN.

THE MARK CONSISTS OF A STRAWBERRY WITH A DROPLET DESCENDING AS THE DOT IN THE "I" IN FRUIT AND A DROPLET DESCENDING FROM THE LETTER "O".

FOR NON-ALCOHOLIC BEVERAGES, NAMELY, NON CARBONATED FRUIT JUICES, FRUIT DRINKS, FRUIT PUNCHES, FRUIT COCKTAILS AND FRUIT FLAVORED DRINKING WATER (U.S. CLS. 45, 46 AND 48).

FIRST USE 1-0-2006; IN COMMERCE 1-0-2006.

3,314,504. NESTLE WATERS NORTH AMERICA INC., GREENWICH, CT. SN 78-855,545. PUB. 10-10-2006, FILED 4-6-2006.

AQUAPOD

THE MARK CONSISTS OF STANDARD CHARACTERS WITHOUT CLAIM TO ANY PARTICULAR FONT, STYLE, SIZE, OR COLOR.

FOR NATURAL SPRING WATER; BOTTLED DRINKING WATERS (U.S. CLS. 45, 46 AND 48).

FIRST USE 2-5-2006; IN COMMERCE 2-5-2006.

3,314,539. KRAFT FOODS HOLDINGS, INC., NORTHFIELD, IL. SN 78-868,855. PUB. 12-12-2006, FILED 4-25-2006.

LIGHTLY LEMON

CLASS 32—(Continued).

THE MARK CONSISTS OF STANDARD CHARACTERS WITHOUT CLAIM TO ANY PARTICULAR FONT, STYLE, SIZE, OR COLOR.

NO CLAIM IS MADE TO THE EXCLUSIVE RIGHT TO USE "LEMON", APART FROM THE MARK AS SHOWN.

FOR MINERAL AND AERATED WATERS AND OTHER NON-ALCOHOLIC DRINKS, NAMELY, FRUIT DRINKS, FRUIT JUICES, FRUIT FLAVORED WATERS; SYRUPS, POWDERED MIXES AND OTHER PREPARATIONS FOR MAKING BEVERAGES (U.S. CLS. 45, 46 AND 48).

FIRST USE 1-22-2007; IN COMMERCE 1-22-2007.

3,314,601. THE COCA-COLA COMPANY, ATLANTA, GA. SN 78-887,022. PUB. 8-15-2006, FILED 5-18-2006.

ENJOY COKE-NESS

THE MARK CONSISTS OF STANDARD CHARACTERS WITHOUT CLAIM TO ANY PARTICULAR FONT, STYLE, SIZE, OR COLOR.

OWNER OF U.S. REG. NOS. 415,755 AND 2,780,469. FOR NON-ALCOHOLIC BEVERAGES, NAMELY SOFT DRINKS (U.S. CLS. 45, 46 AND 48).

FIRST USE 6-15-2006; IN COMMERCE 6-15-2006.

3,314,617. BOA ENERGY DRINK, LLC, DENVER, CO. SN 78-890,685. PUB. 1-16-2007, FILED 5-23-2006.

BOA ENERGY DRINK

THE MARK CONSISTS OF STANDARD CHARACTERS WITHOUT CLAIM TO ANY PARTICULAR FONT, STYLE, SIZE, OR COLOR.

NO CLAIM IS MADE TO THE EXCLUSIVE RIGHT TO USE "ENERGY DRINK", APART FROM THE MARK AS SHOWN.

FOR ENERGY DRINK; SPORTS DRINK (U.S. CLS. 45, 46 AND 48).

FIRST USE 7-28-2007; IN COMMERCE 7-28-2007.

CLASS 32—(Continued).

3,314,646. NESTLE WATERS NORTH AMERICA INC., GREENWICH, CT. SN 78-897,924. PUB. 1-2-2007, FILED 6-1-2006.

A BLAST OF FUN

THE MARK CONSISTS OF STANDARD CHARACTERS WITHOUT CLAIM TO ANY PARTICULAR FONT, STYLE, SIZE, OR COLOR.

FOR SPRING WATER, DRINKING WATER AND PURIFIED WATER (U.S. CLS. 45, 46 AND 48).

FIRST USE 2-5-2006; IN COMMERCE 2-5-2006.

3,314,678. WOLVERINE BEER LLC, ANN ARBOR, MI. SN 78-905,323. PUB. 1-9-2007, FILED 6-9-2006.

Wolverine

THE MARK CONSISTS OF STANDARD CHARACTERS WITHOUT CLAIM TO ANY PARTICULAR FONT, STYLE, SIZE, OR COLOR.

FOR BEER (U.S. CLS. 45, 46 AND 48).

FIRST USE 7-5-2007; IN COMMERCE 7-5-2007.

3,314,684. WOLVERINE BEER LLC, ANN ARBOR, MI. SN 78-906,636. PUB. 1-9-2007, FILED 6-13-2006.



THE MARK CONSISTS OF A STYLIZED LETTER W FORMED BY INTERSECTING LINES REPRESENTATIVE OF SLASH MARKS.

FOR BEER (U.S. CLS. 45, 46 AND 48).

FIRST USE 7-5-2007; IN COMMERCE 7-5-2007.

CLASS 32—(Continued).

3,314,818. MATEVEZA, LLC, SAN FRANCISCO, CA. SN 78-951,396. PUB. 4-3-2007, FILED 8-14-2006.

MATEVEZA

THE MARK CONSISTS OF STANDARD CHARACTERS WITHOUT CLAIM TO ANY PARTICULAR FONT, STYLE, SIZE, OR COLOR.

FOR BEER (U.S. CLS. 45, 46 AND 48).
FIRST USE 11-0-2006; IN COMMERCE 11-0-2006.

3,314,846. CITRUS WORLD, INC., LAKE WALES, FL. SN 78-958,261. PUB. 1-9-2007, FILED 8-23-2006.

FLORIDA'S NATURAL EARTH'S
OWN ORGANICS

THE MARK CONSISTS OF STANDARD CHARACTERS WITHOUT CLAIM TO ANY PARTICULAR FONT, STYLE, SIZE, OR COLOR.

OWNER OF U.S. REG. NOS. 1,745,985, 3,101,253, AND OTHERS.

NO CLAIM IS MADE TO THE EXCLUSIVE RIGHT TO USE "ORGANICS", APART FROM THE MARK AS SHOWN.

SEC. 2(F) AS TO FLORIDA'S NATURAL.
FOR FRUIT DRINKS; FRUIT JUICES (U.S. CLS. 45, 46 AND 48).

FIRST USE 10-15-2006; IN COMMERCE 10-15-2006.

3,314,852. FOX & HOUND RESTAURANT GROUP, WICHITA, KS. SN 78-959,637. PUB. 4-24-2007, FILED 8-24-2006.

RED FOX AMBER ALE

THE MARK CONSISTS OF STANDARD CHARACTERS WITHOUT CLAIM TO ANY PARTICULAR FONT, STYLE, SIZE, OR COLOR.

NO CLAIM IS MADE TO THE EXCLUSIVE RIGHT TO USE "AMBER ALE", APART FROM THE MARK AS SHOWN.

FOR BEER, NAMELY, AMBER ALE (U.S. CLS. 45, 46 AND 48).

FIRST USE 1-1-2007; IN COMMERCE 1-1-2007.

CLASS 32—(Continued).

3,314,860. DC BRANDS INTERNATIONAL, WHEAT RIDGE, CO. SN 78-963,248. PUB. 4-24-2007, FILED 8-29-2006.

TURN LEFT

THE MARK CONSISTS OF STANDARD CHARACTERS WITHOUT CLAIM TO ANY PARTICULAR FONT, STYLE, SIZE, OR COLOR.

FOR NON-ALCOHOLIC BEVERAGES, NAMELY ENERGY DRINKS (U.S. CLS. 45, 46 AND 48).

FIRST USE 11-0-2006; IN COMMERCE 11-0-2006.

CLASS 33—WINES AND SPIRITS

3,313,050. GARVEY III, LLC, ST. HELENA, CA. SN 76-582,839. PUB. 8-30-2005, FILED 3-24-2004.

KAIROS

THE MARK CONSISTS OF STANDARD CHARACTERS WITHOUT CLAIM TO ANY PARTICULAR FONT, STYLE, SIZE, OR COLOR.

THE ENGLISH TRANSLATION OF THE WORD KAIROS IN THE MARK IS "COMES TO COMPLETION" OR "THE TIME IS RIGHT".

FOR WINE (U.S. CLS. 47 AND 49).

FIRST USE 5-21-2007; IN COMMERCE 5-21-2007.

3,313,148. DAVIS, BRANT STEWART, ACAMPO, CA. SN 76-642,839. PUB. 3-28-2006, FILED 7-14-2005.

TANTALIZE

THE MARK CONSISTS OF STANDARD CHARACTERS WITHOUT CLAIM TO ANY PARTICULAR FONT, STYLE, SIZE, OR COLOR.

FOR WINE (U.S. CLS. 47 AND 49).

FIRST USE 2-27-2007; IN COMMERCE 2-27-2007.

CLASS 33—(Continued).

3,313,243. FLORIDA ORANGE GROVES, INC., SOUTH PASADENA, FL. SN 77-002,068. PUB. 5-1-2007, FILED 9-19-2006.

CLASS 33—(Continued).

3,313,525. DOMEQ WINES ESPANA, S.A., SAN SEBASTIAN, SPAIN. SN 78-523,086. PUB. 3-14-2006, FILED 11-26-2004.

Finally, wines that taste
good!

GRAN CAMPO VIEJO

THE MARK CONSISTS OF STANDARD CHARACTERS WITHOUT CLAIM TO ANY PARTICULAR FONT, STYLE, SIZE, OR COLOR.

FOR RED WINE; WHITE WINE; WINES (U.S. CLS. 47 AND 49).

FIRST USE 11-30-2006; IN COMMERCE 11-30-2006.

THE MARK CONSISTS OF STANDARD CHARACTERS WITHOUT CLAIM TO ANY PARTICULAR FONT, STYLE, SIZE, OR COLOR.

OWNER OF U.S. REG. NO. 1,221,136.

THE FOREIGN WORDING IN THE MARK TRANSLATES INTO ENGLISH AS OLD FIELD.

FOR WINES (U.S. CLS. 47 AND 49).

FIRST USE 11-0-2006; IN COMMERCE 11-0-2006.

3,313,408. KILMER, RICHARD M., EL DORADO HILLS, CA. SN 78-325,728. PUB. 9-14-2004, FILED 11-10-2003.

3,313,566. SA ACKERMAN-REMY PANNIER, SAINT FLOR-ENT 49400 SAUMUR, FRANCE. SN 78-567,792. PUB. 10-10-2006, FILED 2-15-2005.

POSTCARD

HAIKU BRIDGE

THE MARK CONSISTS OF STANDARD CHARACTERS WITHOUT CLAIM TO ANY PARTICULAR FONT, STYLE, SIZE, OR COLOR.

FOR WINE (U.S. CLS. 47 AND 49).

FIRST USE 2-4-2007; IN COMMERCE 2-4-2007.

THE MARK CONSISTS OF STANDARD CHARACTERS WITHOUT CLAIM TO ANY PARTICULAR FONT, STYLE, SIZE, OR COLOR.

FOR ALCOHOLIC BEVERAGES, NAMELY WINE (U.S. CLS. 47 AND 49).

FIRST USE 1-20-2006; IN COMMERCE 1-20-2006.

CLASS 33—(Continued).

3,313,570. JEAN-CLAUDE BOISSET WINES, USA, INC., SAUSALITO, CA. SN 78-572,165. PUB. 11-14-2006, FILED 2-22-2005.

LULU B.

THE MARK CONSISTS OF STANDARD CHARACTERS WITHOUT CLAIM TO ANY PARTICULAR FONT, STYLE, SIZE, OR COLOR.

THE MARK "LULU B." DOES NOT IDENTIFY ANY PARTICULAR INDIVIDUAL LIVING OR DECEASED. FOR WINES (U.S. CLS. 47 AND 49). FIRST USE 8-1-2005; IN COMMERCE 8-1-2005.

3,313,656. MCCULLOCH, JOHN, MORROW, OH. SN 78-617,008. PUB. 9-5-2006, FILED 4-26-2005.



OWNER OF U.S. REG. NO. 2,990,696. THE MARK CONSISTS OF A HORSE SHOE WITH THE WORDS GREEN RIVER. FOR WHISKEY (U.S. CLS. 47 AND 49). FIRST USE 1-27-2006; IN COMMERCE 1-27-2006.

3,313,738. SANFORD WINERY CORPORATION, BUELLTON, CA. SN 78-651,626. PUB. 2-21-2006, FILED 6-15-2005.

ALMA ROSA

CLASS 33—(Continued).

THE MARK CONSISTS OF STANDARD CHARACTERS WITHOUT CLAIM TO ANY PARTICULAR FONT, STYLE, SIZE, OR COLOR.

THE FOREIGN WORDING IN THE MARK TRANSLATES INTO ENGLISH AS SOUL OF THE ROSE.

FOR WINE (U.S. CLS. 47 AND 49). FIRST USE 10-31-2006; IN COMMERCE 10-31-2006.

3,313,768. ESTABLISSEMENTS ROULLET FRANSAC, CHERMIGNAC THENAC, FRANCE. SN 78-662,138. PUB. 9-26-2006, FILED 6-30-2005.

RASPBERRY XO BY BAUCHANT

THE MARK CONSISTS OF STANDARD CHARACTERS WITHOUT CLAIM TO ANY PARTICULAR FONT, STYLE, SIZE, OR COLOR.

OWNER OF U.S. REG. NO. 1,348,427. NO CLAIM IS MADE TO THE EXCLUSIVE RIGHT TO USE "RASPBERRY XO", APART FROM THE MARK AS SHOWN.

FOR ALCOHOLIC BEVERAGES, NAMELY, COGNAC AND LIQUEURS (U.S. CLS. 47 AND 49). FIRST USE 2-1-2006; IN COMMERCE 2-1-2006.

3,314,023. VINOS SANTA EMA S.A., ISLA DE MAIPO, CHILE. SN 78-756,226. PUB. 8-29-2006, FILED 11-17-2005.

RIVALTA

THE MARK CONSISTS OF STANDARD CHARACTERS WITHOUT CLAIM TO ANY PARTICULAR FONT, STYLE, SIZE, OR COLOR.

FOR WINES (U.S. CLS. 47 AND 49). FIRST USE 9-6-2006; IN COMMERCE 9-6-2006.

3,314,039. RUIZ ROZILES, HECTOR DANIEL, ZAPOPAN, JALISCO, MEXICO. SN 78-760,102. PUB. 9-5-2006, FILED 11-23-2005.

PERSONAL SHOT

THE MARK CONSISTS OF STANDARD CHARACTERS WITHOUT CLAIM TO ANY PARTICULAR FONT, STYLE, SIZE, OR COLOR.

CLASS 33—(Continued).

PRIORITY CLAIMED UNDER SEC. 44(D) ON MEXICO APPLICATION NO. 752214, FILED 11-22-2005.
NO CLAIM IS MADE TO THE EXCLUSIVE RIGHT TO USE "SHOT", APART FROM THE MARK AS SHOWN.
FOR TEQUILA (U.S. CLS. 47 AND 49).
FIRST USE 11-23-2005; IN COMMERCE 11-23-2005.

3,314,062. SPIER WINES (PTY) LTD, STELLENBOSCH, SOUTH AFRICA. SN 78-764,261. PUB. 8-8-2006, FILED 12-1-2005.

Discovering The Art In Wine Since 1692

THE MARK CONSISTS OF STANDARD CHARACTERS WITHOUT CLAIM TO ANY PARTICULAR FONT, STYLE, SIZE, OR COLOR.
FOR WINE (U.S. CLS. 47 AND 49).
FIRST USE 8-1-2004; IN COMMERCE 6-1-2005.

3,314,086. DOMINUS ESTATE CORPORATION, YOUNTVILLE, CA. SN 78-767,062. PUB. 8-1-2006, FILED 12-5-2005.

EX TERRA

THE MARK CONSISTS OF STANDARD CHARACTERS WITHOUT CLAIM TO ANY PARTICULAR FONT, STYLE, SIZE, OR COLOR.
THE FOREIGN WORDING IN THE MARK TRANSLATES INTO ENGLISH AS FROM THE EARTH.
FOR WINE (U.S. CLS. 47 AND 49).
FIRST USE 9-7-2006; IN COMMERCE 9-7-2006.

3,314,202. VINOS SANTA EMA S.A., ISLA DE MAIPO, CHILE. SN 78-785,757. PUB. 8-29-2006, FILED 1-5-2006.

AMPLUS

THE MARK CONSISTS OF STANDARD CHARACTERS WITHOUT CLAIM TO ANY PARTICULAR FONT, STYLE, SIZE, OR COLOR.
FOR WINES (U.S. CLS. 47 AND 49).
FIRST USE 10-8-2006; IN COMMERCE 10-8-2006.

CLASS 33—(Continued).

3,314,209. MARTIN RAY WINERY, INC., SANTA ROSA, CA. SN 78-787,897. PUB. 8-29-2006, FILED 1-9-2006.

COURTNEY'S ANGELS

THE MARK CONSISTS OF STANDARD CHARACTERS WITHOUT CLAIM TO ANY PARTICULAR FONT, STYLE, SIZE, OR COLOR.
FOR WINES (U.S. CLS. 47 AND 49).
FIRST USE 5-15-2006; IN COMMERCE 5-15-2006.

3,314,263. ROUND HILL CELLARS, DBA RUTHERFORD WINE COMPANY, ST. HELENA, CA. SN 78-796,062. PUB. 9-12-2006, FILED 1-20-2006.

GRAND PACIFIC

THE MARK CONSISTS OF STANDARD CHARACTERS WITHOUT CLAIM TO ANY PARTICULAR FONT, STYLE, SIZE, OR COLOR.
FOR WINES (U.S. CLS. 47 AND 49).
FIRST USE 8-15-2006; IN COMMERCE 8-15-2006.

3,314,291. CANTINE SETTESOLI SOCIETA COOPERATIVA AGRICOLA, MENFI (AG), ITALY. AND ENOTRIA WINE-CELLARS LTD., LONDON, UNITED KINGDOM. SN 78-803,329. PUB. 9-26-2006, FILED 1-31-2006.

BIBO

THE MARK CONSISTS OF STANDARD CHARACTERS WITHOUT CLAIM TO ANY PARTICULAR FONT, STYLE, SIZE, OR COLOR.
FOR WINES (U.S. CLS. 47 AND 49).
FIRST USE 7-24-2006; IN COMMERCE 7-24-2006.

CLASS 33—(Continued).

3,314,436. K BEITLER LLC, RUTHERFORD, CA. SN 78-830,576. PUB. 2-13-2007, FILED 3-6-2006.

BOHEME

THE MARK CONSISTS OF STANDARD CHARACTERS WITHOUT CLAIM TO ANY PARTICULAR FONT, STYLE, SIZE, OR COLOR.

THE FOREIGN WORDING IN THE MARK TRANSLATES INTO ENGLISH AS BOHEMIA.

FOR GRAPE WINE; RED WINE; WHITE WINE; WINE; WINES (U.S. CLS. 47 AND 49).

FIRST USE 6-30-2007; IN COMMERCE 7-2-2007.

3,314,535. UNITED STATES DISTILLED PRODUCTS COMPANY, PRINCETON, MN. SN 78-868,011. PUB. 11-28-2006, FILED 4-24-2006.

TROPIC ISLE PALMS

THE MARK CONSISTS OF STANDARD CHARACTERS WITHOUT CLAIM TO ANY PARTICULAR FONT, STYLE, SIZE, OR COLOR.

FOR RUM (U.S. CLS. 47 AND 49).

FIRST USE 8-31-2006; IN COMMERCE 8-31-2006.

3,314,659. STONEWRITER, LLC, CALISTOGA, CA. SN 78-901,760. PUB. 1-9-2007, FILED 6-6-2006.

WATERMARK

THE MARK CONSISTS OF STANDARD CHARACTERS WITHOUT CLAIM TO ANY PARTICULAR FONT, STYLE, SIZE, OR COLOR.

FOR WINE (U.S. CLS. 47 AND 49).

FIRST USE 12-15-2006; IN COMMERCE 4-15-2007.

CLASS 33—(Continued).

3,314,670. KONGSGAARD WINE LLC, ST. HELENA, CA. SN 78-903,028. PUB. 1-2-2007, FILED 6-7-2006.

VIOROUS

THE MARK CONSISTS OF STANDARD CHARACTERS WITHOUT CLAIM TO ANY PARTICULAR FONT, STYLE, SIZE, OR COLOR.

FOR WINE (U.S. CLS. 47 AND 49).

FIRST USE 8-7-2007; IN COMMERCE 8-7-2007.

3,314,687. KUTCH WINES LLC., SAN FRANCISCO, CA. SN 78-907,773. PUB. 1-30-2007, FILED 6-14-2006.

Kutch

THE MARK CONSISTS OF STANDARD CHARACTERS WITHOUT CLAIM TO ANY PARTICULAR FONT, STYLE, SIZE, OR COLOR.

FOR WINE (U.S. CLS. 47 AND 49).

FIRST USE 6-15-2005; IN COMMERCE 2-9-2007.

3,314,704. BIAGIO CRU & ESTATE WINES, LLC., ROSLYN HEIGHTS, NY. SN 78-911,503. PUB. 12-19-2006, FILED 6-19-2006.

RIGATONI RED

THE MARK CONSISTS OF STANDARD CHARACTERS WITHOUT CLAIM TO ANY PARTICULAR FONT, STYLE, SIZE, OR COLOR.

NO CLAIM IS MADE TO THE EXCLUSIVE RIGHT TO USE "RED", APART FROM THE MARK AS SHOWN.

FOR WINE COOLERS; WINES (U.S. CLS. 47 AND 49).

FIRST USE 4-27-2007; IN COMMERCE 4-27-2007.

CLASS 33—(Continued).

3,314,727. DIAGEO NORTH AMERICA, INC., NORWALK, CT. SN 78-918,439. PUB. 2-13-2007, FILED 6-28-2006.



OWNER OF U.S. REG. NOS. 2,094,877, 3,022,956, AND OTHERS.
FOR ALCOHOLIC BEVEAGES, NAMELY, WHISKY (U.S. CLS. 47 AND 49).
FIRST USE 6-30-2006; IN COMMERCE 6-30-2006.

3,314,735. GRGICH HILLS CELLAR, RUTHERFORD, CA. SN 78-922,974. PUB. 2-20-2007, FILED 7-5-2006.

GRGICH HILLS ESTATE

THE MARK CONSISTS OF STANDARD CHARACTERS WITHOUT CLAIM TO ANY PARTICULAR FONT, STYLE, SIZE, OR COLOR.

OWNER OF U.S. REG. NOS. 1,362,311, 1,388,360, AND OTHERS.

NO CLAIM IS MADE TO THE EXCLUSIVE RIGHT TO USE "ESTATE", APART FROM THE MARK AS SHOWN, FOR WINE (U.S. CLS. 47 AND 49).

FIRST USE 9-6-2006; IN COMMERCE 1-5-2007.

3,314,802. ADLER FELS WINERY, LLC, SANTA ROSA, CA. SN 78-946,178. PUB. 3-27-2007, FILED 8-7-2006.

SIDE YARD

THE MARK CONSISTS OF STANDARD CHARACTERS WITHOUT CLAIM TO ANY PARTICULAR FONT, STYLE, SIZE, OR COLOR.

FOR WINE (U.S. CLS. 47 AND 49).

FIRST USE 10-5-2006; IN COMMERCE 10-5-2006.

CLASS 33—(Continued).

3,314,857. TEQUILAS RANCHO VIEJO SA DE CV, TEPATILAN, MEXICO. SN 78-961,858. PUB. 4-24-2007, FILED 8-28-2006.



THE COLOR(S) BROWN AND GOLD IS/ARE CLAIMED AS A FEATURE OF THE MARK.

THE NAME COMISARIO IN BROWN, WITH THE LETTERS OUTLINED IN GOLD. IN THE LETTER C APPEARS AN AGAVE PLANT ALSO IN BROWN. ABOVE THE WORD APPEARS A MEXICAN WITH A BIG HAT ALSO IN BROWN.

THE FOREIGN WORDING IN THE MARK TRANSLATES INTO ENGLISH AS SHERIFF, COMISSARY, COMISIONER.

FOR TEQUILA (U.S. CLS. 47 AND 49).

FIRST USE 3-3-2007; IN COMMERCE 3-3-2007.

CLASS 34—SMOKERS' ARTICLES

3,313,061. JONATHAN DREW INC., MIAMI, FL. SN 76-603,215. PUB. 6-21-2005, FILED 7-19-2004.

ADOBE

THE MARK CONSISTS OF STANDARD CHARACTERS WITHOUT CLAIM TO ANY PARTICULAR FONT, STYLE, SIZE, OR COLOR.

FOR CIGARS AND TOBACCO LEAF WRAPS (U.S. CLS. 2, 8, 9 AND 17).

FIRST USE 7-0-2004; IN COMMERCE 7-0-2004.

CLASS 34—(Continued).

3,313,078. DA BOMB PRODUCTS, INC., GLENDALE, AZ. SN 76-614,833. PUB. 8-8-2006, FILED 10-7-2004.

ORANGE TANG

THE MARK CONSISTS OF STANDARD CHARACTERS WITHOUT CLAIM TO ANY PARTICULAR FONT, STYLE, SIZE, OR COLOR.

NO CLAIM IS MADE TO THE EXCLUSIVE RIGHT TO USE "ORANGE", APART FROM THE MARK AS SHOWN.

FOR TOBACCO PRODUCTS, NAMELY, FLAVORED TOBACCO, CIGARS, CIGAR WRAPS AND CIGARETTES (U.S. CLS. 2, 8, 9 AND 17).

FIRST USE 10-19-2005; IN COMMERCE 10-19-2005.

3,313,093. PT DJARUM, KUDUS 59317, INDONESIA. SN 76-623,780. PUB. 6-13-2006, FILED 12-9-2004.



OWNER OF U.S. REG. NOS. 1,398,758, 1,398,759, AND 1,398,760.

NO CLAIM IS MADE TO THE EXCLUSIVE RIGHT TO USE "SPICE ISLANDS", "WORLD'S FIRST PREMIUM KRETEK CIGARILLOS" AND THE MAP OF THE ISLANDS OF SUMATRA, JAVA, KALIMANTAN, ALSO KNOWN AS BORNEO, SULAWESI, ALSO KNOWN AS CELEBES, AND BALI WHICH ARE PART OF THE INDONESIAN ARCHIPELAGO, APART FROM THE MARK AS SHOWN.

THE ENGLISH TRANSLATION OF THE WORD DJARUM IS NEEDLE, WHILE A KRETEK IS A CLOVE CIGARETTE. FOR CIGARS AND CIGARETTES, BOTH CONTAINING TOBACCO AND CLOVES (U.S. CLS. 2, 8, 9 AND 17). FIRST USE 5-0-2005; IN COMMERCE 7-0-2006.

CLASS 34—(Continued).

3,313,250. COMPTON POINT, INC., CINCINNATI, OH. SN 77-003,985. PUB. 3-20-2007, FILED 9-21-2006.

BUCKEYE'S BEST

THE MARK CONSISTS OF STANDARD CHARACTERS WITHOUT CLAIM TO ANY PARTICULAR FONT, STYLE, SIZE, OR COLOR.

NO CLAIM IS MADE TO THE EXCLUSIVE RIGHT TO USE "BEST", APART FROM THE MARK AS SHOWN.

FOR CUT TOBACCO; SHREDDED TOBACCO (U.S. CLS. 2, 8, 9 AND 17).

FIRST USE 12-20-2006; IN COMMERCE 12-20-2006.

3,313,832. JONATHAN DREW, INC., DBA DREW ESTATE, MIAMI, FL. SN 78-692,596. PUB. 1-24-2006, FILED 8-15-2005.

WAFE

THE MARK CONSISTS OF STANDARD CHARACTERS WITHOUT CLAIM TO ANY PARTICULAR FONT, STYLE, SIZE, OR COLOR.

FOR CIGARS, TOBACCO AND CIGARETTES (U.S. CLS. 2, 8, 9 AND 17).

FIRST USE 1-26-2005; IN COMMERCE 1-26-2005.

3,314,179. OHIO BRANDS, INC., SUNNY ISLES, FL. SN 78-782,304. PUB. 8-22-2006, FILED 12-29-2005.

JED'S

THE MARK CONSISTS OF STANDARD CHARACTERS WITHOUT CLAIM TO ANY PARTICULAR FONT, STYLE, SIZE, OR COLOR.

FOR CIGARETTES (U.S. CLS. 2, 8, 9 AND 17).

FIRST USE 8-16-2006; IN COMMERCE 8-16-2006.

CLASS 34—(Continued).

3,314,289. BLUNT WRAP U.S.A., INC, MANDEVILLE, LA. SN 78-802,366. PUB. 9-19-2006, FILED 1-30-2006.

ZING

THE MARK CONSISTS OF STANDARD CHARACTERS WITHOUT CLAIM TO ANY PARTICULAR FONT, STYLE, SIZE, OR COLOR.

FOR TOBACCO PRODUCTS AND ACCESSORIES, NAMELY, CIGARETTES, CIGARS, ROLLING PAPERS MADE OUT OF PAPER AND/OR TOBACCO FOR CIGARETTES AND CIGARS, AND ROLLING TOBACCO FOR CIGARETTES AND CIGARS (U.S. CLS. 2, 8, 9 AND 17).

FIRST USE 4-13-2007; IN COMMERCE 4-13-2007.

3,314,694. UNITED TOBACCO DISTRIBUTORS INC, SUNRISE, FL. SN 78-909,073. PUB. 4-10-2007, FILED 6-15-2006.



NO CLAIM IS MADE TO THE EXCLUSIVE RIGHT TO USE "NICARAGUA", APART FROM THE MARK AS SHOWN.

FOR CIGARS (U.S. CLS. 2, 8, 9 AND 17).
FIRST USE 6-1-2006; IN COMMERCE 9-1-2006.

3,314,766. S.T.T.H., INC., SUNNY ISLES BEACH, FL. SN 78-933,438. PUB. 3-6-2007, FILED 7-20-2006.

blue collar

THE MARK CONSISTS OF STANDARD CHARACTERS WITHOUT CLAIM TO ANY PARTICULAR FONT, STYLE, SIZE, OR COLOR.

FOR SNUFF (U.S. CLS. 2, 8, 9 AND 17).
FIRST USE 10-0-2006; IN COMMERCE 10-0-2006.

CLASS 34—(Continued).

3,314,873. REAL TABACALERA SANCHEZ-ROMAY, S.A., SANTIAGO, DOMINICAN REP. SN 78-966,849. PUB. 5-1-2007, FILED 9-5-2006.

El Botin Dominicano

THE MARK CONSISTS OF STANDARD CHARACTERS WITHOUT CLAIM TO ANY PARTICULAR FONT, STYLE, SIZE, OR COLOR.

NO CLAIM IS MADE TO THE EXCLUSIVE RIGHT TO USE "DOMINICANO", APART FROM THE MARK AS SHOWN.

THE FOREIGN WORDING IN THE MARK TRANSLATES INTO ENGLISH AS BOOTY FROM THE DOMINICAN REPUBLIC.

FOR CIGARS FROM THE DOMINICAN REPUBLIC AND CIGARS MADE FROM SEEDS GROWN IN THE DOMINICAN REPUBLIC (U.S. CLS. 2, 8, 9 AND 17).

FIRST USE 8-1-2007; IN COMMERCE 8-1-2007.

SERVICE MARKS**CLASS 35—ADVERTISING AND BUSINESS**

3,312,983. ADVANCE MERCHANDISING COMPANY, INC., ROANOKE, VA. SN 76-060,218. PUB. 2-3-2004, FILED 5-30-2000.

RIGHT PART. RIGHT AWAY.

FOR DISTRIBUTORSHIP SERVICES IN THE FIELD OF AUTOMOTIVE PARTS (U.S. CLS. 100, 101 AND 102).
FIRST USE 1-0-1999; IN COMMERCE 1-0-1999.

CLASS 35—(Continued).

3,312,987. MARINE BOULEVARD NO. 9 CC, BLOUBERG, 7441, SOUTH AFRICA. SN 76-166,563. PUB. 2-22-2005, FILED 11-16-2000.

KLIKETY-KLIK

THE MARK CONSISTS OF STANDARD CHARACTERS WITHOUT CLAIM TO ANY PARTICULAR FONT, STYLE, SIZE, OR COLOR.

PRIORITY CLAIMED UNDER SEC. 44(D) ON SOUTH AFRICA APPLICATION NO. ZA2000/11143, FILED 6-1-2000, REG. NO. 2000/11143, DATED 6-1-2000, EXPIRES 6-1-2010.

FOR BUSINESS AND ADVERTISING SERVICES PROVIDED TO OTHERS, NAMELY, ELECTRONIC COMMERCE ADVERTISING AND COMPUTERIZED ONLINE BUYING SERVICES FOR CONSUMER GOODS; BUSINESS CONSULTING SERVICES RELATING TO ELECTRONIC COMMERCE IN THE NATURE OF ONLINE SALES OF GOODS AND SERVICES; PROVIDING A DIRECTORY OF THIRD PARTY WEB SITES TO FACILITATE BUSINESS TRANSACTIONS; COMPUTERIZED ONLINE ORDER; PROVIDING A DIRECTORY OF THIRD PARTY WEB SITES TO FACILITATE BUSINESS TRANSACTIONS; IMPORT-EXPORT AGENCY SERVICES, COMPUTERIZED DATABASE MANAGEMENT; SALES PROMOTION FOR OTHERS, NAMELY, PROMOTING THE SALE OF GOODS AND SERVICES OF OTHERS BY PREPARING AND PLACING ADVERTISEMENTS IN AN ELECTRONIC MAGAZINE ACCESSED THROUGH A GLOBAL COMPUTER NETWORK AND BY PROVIDING HYPERTEXT LINKS TO THE WEB SITES OF OTHERS; DIRECT MAIL ADVERTISING; ELECTRONIC MAIL SERVICES; AND SAMPLE DISTRIBUTION (U.S. CLS. 100, 101 AND 102).

FIRST USE 6-1-2002; IN COMMERCE 11-1-2006.

3,313,038. PREMIER DESIGNS, INC., IRVING, TX. SN 76-552,759. PUB. 1-30-2007, FILED 10-1-2003.

**PREMIER DESIGNS
INCENTIVES**

NO CLAIM IS MADE TO THE EXCLUSIVE RIGHT TO USE DESIGNS INCENTIVES, APART FROM THE MARK AS SHOWN.

FOR RETAIL SERVICES BY DIRECT SOLICITATION BY SALES AGENT IN THE FIELD OF HIGH-FASHION JEWELRY, EXCLUDING FINE JEWELRY AND PRECIOUS GEMS; DIRECT MARKETING SERVICES, NAMELY, PROMOTING THE RETAIL SERVICES IN THE FIELD OF HIGH-FASHION JEWELRY BY DISTRIBUTING MARKETING MATERIALS, INCLUDING APPAREL, MIRRORS, PURSES, TOTE BAGS, WALLETS, RIBBONS, TISSUE PAPER, SUNGLASSES, SUNGLASS CASES, ROLLING CARTS, STATIONERY, CALCULATORS, NOTEBOOKS, JEWELRY CLEANERS AND NAIL FILES TO SALES AGENTS (U.S. CLS. 100, 101 AND 102).

FIRST USE 8-0-2005; IN COMMERCE 8-0-2005.

CLASS 35—(Continued).

3,313,057. CRN INTERNATIONAL, INC., HAMDEN, CT. SN 76-593,129. PUB. 8-9-2005, FILED 5-18-2004.

JUST IN TIME MARKETING

THE MARK CONSISTS OF STANDARD CHARACTERS WITHOUT CLAIM TO ANY PARTICULAR FONT, STYLE, SIZE, OR COLOR.

NO CLAIM IS MADE TO THE EXCLUSIVE RIGHT TO USE "MARKETING", APART FROM THE MARK AS SHOWN.

FOR MARKETING SERVICES, NAMELY, DEVELOPING PROMOTIONAL RADIO PROGRAMS, PROMOTIONAL CAMPAIGNS, PROMOTIONAL CONTESTS AND RELATED PROMOTIONAL EVENTS FOR OTHERS TO MEET THEIR SPECIFIC CONSUMER AND TRADE MARKETING OBJECTIVES (U.S. CLS. 100, 101 AND 102).

FIRST USE 4-30-2007; IN COMMERCE 4-30-2007.

3,313,070. PROTRADES CONNECTION, SAN JOSE, CA. SN 76-608,173. PUB. 10-4-2005, FILED 8-23-2004.

PROTRADES CONNECTION

THE MARK CONSISTS OF STANDARD CHARACTERS WITHOUT CLAIM TO ANY PARTICULAR FONT, STYLE, SIZE, OR COLOR.

NO CLAIM IS MADE TO THE EXCLUSIVE RIGHT TO USE "CONNECTION", APART FROM THE MARK AS SHOWN.

FOR EMPLOYMENT AGENCIES (U.S. CLS. 100, 101 AND 102).

FIRST USE 2-28-2005; IN COMMERCE 5-3-2005.

3,313,082. GHANIMOGHADAM, SAEED, THORNHILL, ONTARIO, CANADA. SN 76-618,510. PUB. 10-4-2005, FILED 10-29-2004.

7MSG.COM

THE MARK CONSISTS OF STANDARD CHARACTERS WITHOUT CLAIM TO ANY PARTICULAR FONT, STYLE, SIZE, OR COLOR.

FOR PROVIDING AN ONLINE MARKETPLACE FOR BUYERS AND SELLERS OF ELECTRONIC CONTENT, INCLUDING RING TONES, WALLPAPER, GAMES, VIDEO CLIPS, MESSAGES AND MULTIMEDIA MESSAGES, FOR USE ON MOBILE ELECTRONIC DEVICES (U.S. CLS. 100, 101 AND 102).

FIRST USE 5-13-2004; IN COMMERCE 5-13-2004.

CLASS 35—(Continued).

3,313,100. MEGA LIFE AND HEALTH INSURANCE COMPANY, THE, NORTH RICHLAND HILLS, TX. SN 76-628,223. PUB. 8-8-2006, FILED 1-18-2005.



THE MARK CONSISTS IN PART OF A STYLIZED EAGLE DESIGN.

FOR PROMOTION OF INSURANCE SERVICES ON BEHALF OF THIRD PARTIES; INSURANCE LEAD COLLECTION AND MATCHING SERVICES, NAMELY, MATCHING CONSUMER REQUESTS FOR INSURANCE POLICY QUOTES COLLECTED OVER THE INTERNET TO PRE-QUALIFIED INSURANCE BROKERS, AGENTS AND AGENCIES INTERESTED IN THOSE REQUESTS; BUSINESS ORGANIZATION CONSULTING IN THE NATURE OF RECRUITING PARTICIPATION IN A NETWORK OF INDEPENDENT INSURANCE AGENTS AND AGENCIES; ASSOCIATION SERVICES, NAMELY, PROMOTION OF BUSINESS OPPORTUNITIES, NAMELY, PROMOTING THE INTERESTS OF SMALL BUSINESSES AND THE SELF-EMPLOYED; DEVELOPMENT OF MARKETING STRATEGIES AND CONCEPTS FOR INDEPENDENT INSURANCE AGENTS; BUSINESS CONSULTING SERVICES FOR INDEPENDENT INSURANCE AGENTS; BUSINESS CONSULTING SERVICES IN THE FIELD OF INSURANCE (U.S. CLS. 100, 101 AND 102).

FIRST USE 3-1-2004; IN COMMERCE 3-1-2004.

3,313,149. ONGISTICS CORPORATION, HOUSTON, TX. SN 76-642,947. PUB. 10-10-2006, FILED 7-15-2005.

ONGISTICS

THE MARK CONSISTS OF STANDARD CHARACTERS WITHOUT CLAIM TO ANY PARTICULAR FONT, STYLE, SIZE, OR COLOR.

FOR PROCUREMENT, NAMELY PURCHASING OFFICE SUPPLIES, PRINT-RELATED ITEMS, AND PROMOTIONAL ITEMS FOR OTHERS; PREPARING PROMOTIONAL MATERIALS FOR OTHERS; DOCUMENT COPYING TASKS; ORDER FULFILLMENT SERVICES, NAMELY RECEIVING, ASSEMBLING, PICKING, CONSOLIDATING, AND PREPARING MERCHANDISE FOR SHIPMENT; DOCUMENT AND FORMS MANAGEMENT SERVICES, NAMELY INVENTORYING, ORGANIZING, CLASSIFYING AND REORDERING; DIRECT MAIL ADVERTISING SERVICES (U.S. CLS. 100, 101 AND 102).

FIRST USE 7-5-2002; IN COMMERCE 5-1-2006.

CLASS 35—(Continued).

3,313,158. ALABAMA STAFF, INC., BIRMINGHAM, AL. SN 76-644,893. PUB. 3-6-2007, FILED 8-15-2005.

CORPORATE ROCKET FUEL

THE MARK CONSISTS OF STANDARD CHARACTERS WITHOUT CLAIM TO ANY PARTICULAR FONT, STYLE, SIZE, OR COLOR.

NO CLAIM IS MADE TO THE EXCLUSIVE RIGHT TO USE "CORPORATE", APART FROM THE MARK AS SHOWN.

FOR EMPLOYEE LEASING SERVICES (U.S. CLS. 100, 101 AND 102).

FIRST USE 1-10-2006; IN COMMERCE 1-10-2006.

3,313,167. IMPRIMIS GROUP, INC., DALLAS, TX. SN 76-647,298. PUB. 6-6-2006, FILED 9-22-2005.

MSQUAD

THE MARK CONSISTS OF STANDARD CHARACTERS WITHOUT CLAIM TO ANY PARTICULAR FONT, STYLE, SIZE, OR COLOR.

FOR PERSONNEL STAFFING SERVICES (U.S. CLS. 100, 101 AND 102).

FIRST USE 1-0-2007; IN COMMERCE 1-0-2007.

3,313,168. CLICKMOTIVE, LP, MURPHY, TX. SN 76-647,663. PUB. 12-26-2006, FILED 9-29-2005.

clickmotive

FOR ON-LINE MARKETING AND ADVERTISING SERVICES IN THE AUTOMOTIVE INDUSTRY, NAMELY PROVIDING MARKETING AND ADVERTISING SERVICES DESIGNED TO INCREASE SEARCH ENGINE HITS ON A CUSTOMER'S WEBSITE (U.S. CLS. 100, 101 AND 102).

FIRST USE 10-1-2005; IN COMMERCE 10-1-2005.

CLASS 35—(Continued).

3,313,191. COMPREHENSIVE HEALTH EDUCATION FOUNDATION, SEATTLE, WA. SN 76-654,764. PUB. 2-6-2007, FILED 2-8-2006.

BUILDING HEALTHIER NONPROFITS

THE MARK CONSISTS OF STANDARD CHARACTERS WITHOUT CLAIM TO ANY PARTICULAR FONT, STYLE, SIZE, OR COLOR.

NO CLAIM IS MADE TO THE EXCLUSIVE RIGHT TO USE "NONPROFITS", APART FROM THE MARK AS SHOWN.

FOR BUSINESS CONSULTING SERVICES TO HEALTH AND HUMAN SERVICES NONPROFIT ORGANIZATIONS IN THE AREAS OF BUSINESS PLANNING, CAPACITY BUILDING, AND SUSTAINABILITY (U.S. CLS. 100, 101 AND 102).

FIRST USE 8-1-2005; IN COMMERCE 11-1-2005.

3,313,204. NETWORK SOLUTIONS, LLC, HERNDON, VA. SN 76-658,758. PUB. 11-14-2006, FILED 4-20-2006.

PERFORMANCECLICKS

THE MARK CONSISTS OF STANDARD CHARACTERS WITHOUT CLAIM TO ANY PARTICULAR FONT, STYLE, SIZE, OR COLOR.

FOR PROMOTION, ADVERTISING AND MARKETING OF ON-LINE WEBSITES (U.S. CLS. 100, 101 AND 102).

FIRST USE 8-13-2006; IN COMMERCE 8-13-2006.

3,313,226. M. M. FOWLER, INC., DURHAM, NC. SN 76-665,554. PUB. 5-1-2007, FILED 9-5-2006.

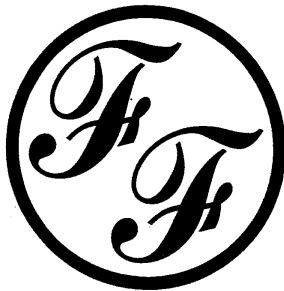

FOR RETAIL STORE SERVICES FEATURING CONVENIENCE STORE ITEMS AND GASOLINE AND WITHOUT GASOLINE (U.S. CLS. 100, 101 AND 102).

FIRST USE 1-1-2007; IN COMMERCE 1-1-2007.

CLASS 35—(Continued).

3,313,251. EXCLUSIVE LIGHTING, INC., TORRANCE, CA. SN 77-005,168. PUB. 5-8-2007, FILED 9-22-2006.

DREAM ON LIGHTING

THE MARK CONSISTS OF STANDARD CHARACTERS WITHOUT CLAIM TO ANY PARTICULAR FONT, STYLE, SIZE, OR COLOR.

NO CLAIM IS MADE TO THE EXCLUSIVE RIGHT TO USE "LIGHTING", APART FROM THE MARK AS SHOWN.

FOR ON-LINE RETAIL STORE SERVICES FEATURING LIGHTING FIXTURES, LIGHTING ACCESSORIES, LAMPS, AND RELATED ITEMS IN THE FIELD OF LIGHTING; RETAIL OUTLETS FEATURING LIGHTING FIXTURES, LIGHTING ACCESSORIES, LAMPS, AND RELATED ITEMS IN THE FIELD OF LIGHTING; RETAIL SHOPS FEATURING LIGHTING FIXTURES, LIGHTING ACCESSORIES, LAMPS, AND RELATED ITEMS IN THE FIELD OF LIGHTING; RETAIL STORES FEATURING LIGHTING FIXTURES, LIGHTING ACCESSORIES, LAMPS, AND RELATED ITEMS IN THE FIELD OF LIGHTING; RETAIL LIGHTING STORES (U.S. CLS. 100, 101 AND 102).

FIRST USE 3-31-2006; IN COMMERCE 3-31-2006.

3,313,254. ADKNOWLEDGE, INC., KANSAS CITY, MO. SN 77-005,628. PUB. 5-1-2007, FILED 9-22-2006.

ADSTATION

THE MARK CONSISTS OF STANDARD CHARACTERS WITHOUT CLAIM TO ANY PARTICULAR FONT, STYLE, SIZE, OR COLOR.

FOR ADVERTISING AND COMMERCIAL INFORMATION SERVICES, VIA THE INTERNET; ADVERTISING VIA ELECTRONIC MEDIA AND SPECIFICALLY THE INTERNET; DISSEMINATION OF ADVERTISING FOR OTHERS VIA AN ON-LINE COMMUNICATIONS NETWORK ON THE INTERNET; DISSEMINATION OF ADVERTISING FOR OTHERS VIA THE INTERNET (U.S. CLS. 100, 101 AND 102).

FIRST USE 9-22-2006; IN COMMERCE 9-27-2006.

CLASS 35—(Continued).

3,313,256. CHARLESBERND AG, MÜNCHEN, FED REP GERMANY. SN 77-006,013. PUB. 1-9-2007, FILED 9-23-2006.

EDITMENTION

THE MARK CONSISTS OF STANDARD CHARACTERS WITHOUT CLAIM TO ANY PARTICULAR FONT, STYLE, SIZE, OR COLOR.

FOR DISSEMINATION OF ADVERTISING FOR OTHERS VIA THE INTERNET (U.S. CLS. 100, 101 AND 102).

FIRST USE 9-23-2006; IN COMMERCE 8-16-2007.

3,313,264. MIKOLAJCZYK, WILLIAM C., ANTHEM, AZ. SN 77-007,741. PUB. 5-8-2007, FILED 9-26-2006.

Dusty Paws

THE MARK CONSISTS OF STANDARD CHARACTERS WITHOUT CLAIM TO ANY PARTICULAR FONT, STYLE, SIZE, OR COLOR.

FOR RETAIL PET STORES (U.S. CLS. 100, 101 AND 102).

FIRST USE 8-3-2007; IN COMMERCE 8-3-2007.

3,313,275. ACHIM'S FRANCHISING, LLC, ATHENS, GA. SN 77-012,947. PUB. 4-10-2007, FILED 10-3-2006.



NO CLAIM IS MADE TO THE EXCLUSIVE RIGHT TO USE "EUROPEAN EATERY", APART FROM THE MARK AS SHOWN.

THE COLOR(S) RED, YELLOW AND WHITE IS/ARE CLAIMED AS A FEATURE OF THE MARK.

THE MARK CONSISTS OF A DRAWING OF THE FACE OF A MAN, WHICH APPEARS IN RED, ABOVE THE WORDS "UNCLE OTTO'S," WHICH APPEAR IN YELLOW, ABOVE A RED OVAL CONTAINING THE WORDS "EUROPEAN EATERY," WHICH APPEAR IN WHITE.

FOR RESTAURANT FRANCHISING (U.S. CLS. 100, 101 AND 102).

FIRST USE 10-4-2006; IN COMMERCE 10-4-2006.

CLASS 35—(Continued).

3,313,276. ACHIM'S FRANCHISING, LLC, ATHENS, GA. SN 77-012,950. PUB. 4-10-2007, FILED 10-3-2006.

UNCLE OTTO'S EUROPEAN EATERY

THE MARK CONSISTS OF STANDARD CHARACTERS WITHOUT CLAIM TO ANY PARTICULAR FONT, STYLE, SIZE, OR COLOR.

NO CLAIM IS MADE TO THE EXCLUSIVE RIGHT TO USE "EUROPEAN EATERY", APART FROM THE MARK AS SHOWN.

FOR RESTAURANT FRANCHISING (U.S. CLS. 100, 101 AND 102).

FIRST USE 10-4-2006; IN COMMERCE 10-4-2006.

3,313,280. TERROR-FREE OIL INITIATIVE, CORAL SPRINGS, FL. SN 77-015,546. PUB. 5-22-2007, FILED 10-6-2006.

TERROR-FREE

THE MARK CONSISTS OF STANDARD CHARACTERS WITHOUT CLAIM TO ANY PARTICULAR FONT, STYLE, SIZE, OR COLOR.

FOR RETAIL STORE SERVICES FEATURING CONVENIENCE STORE ITEMS AND GASOLINE (U.S. CLS. 100, 101 AND 102).

FIRST USE 5-5-2006; IN COMMERCE 2-1-2007.

3,313,305. ERMENEGILDO ZEGNA CORPORATION, ENGLEWOOD, NJ. SN 77-030,280. PUB. 3-20-2007, FILED 10-26-2006.

GREAT MINDS THINK ALIKE

THE MARK CONSISTS OF STANDARD CHARACTERS WITHOUT CLAIM TO ANY PARTICULAR FONT, STYLE, SIZE, OR COLOR.

FOR RETAIL STORES AND DEPARTMENTS IN RETAIL STORES FEATURING MEN'S CLOTHING AND ACCESSORIES (U.S. CLS. 100, 101 AND 102).

FIRST USE 2-0-2007; IN COMMERCE 2-0-2007.

CLASS 35—(Continued).

3,313,308. POLITICAL WORLD COMMUNICATIONS, LLC, PLAINSBORO, NJ. SN 77-030,703. PUB. 6-5-2007, FILED 10-27-2006.



THE MARK CONSISTS OF A STYLIZED CHECKMARK IN A BOX, AS IN A VOTING BOOTH, WITH THE WORDS "THE LATEST LINE" IN ALL CAPS TO THE CHECKBOX'S RIGHT.

FOR PUBLIC OPINION POLLING (U.S. CLS. 100, 101 AND 102).

FIRST USE 10-20-2006; IN COMMERCE 10-20-2006.

3,313,329. THE SHADE STORE LLC, LONG ISLAND CITY, NY. SN 77-049,603. PUB. 5-8-2007, FILED 11-22-2006.

CUSTOM MADE SIMPLE

THE MARK CONSISTS OF STANDARD CHARACTERS WITHOUT CLAIM TO ANY PARTICULAR FONT, STYLE, SIZE, OR COLOR.

NO CLAIM IS MADE TO THE EXCLUSIVE RIGHT TO USE "CUSTOM MADE", APART FROM THE MARK AS SHOWN.

FOR ON-LINE RETAIL STORE SERVICES, FEATURING WINDOW BLINDS, CURTAINS AND DECORATIVE WINDOW TREATMENTS (U.S. CLS. 100, 101 AND 102).

FIRST USE 5-10-2007; IN COMMERCE 5-10-2007.

3,313,363. SECURE ASSET REPORTING SERVICES, INC., BELLEVUE, WA. SN 78-183,882. PUB. 10-11-2005, FILED 11-11-2002.

SARS ROADTRAC

NO CLAIM IS MADE TO THE EXCLUSIVE RIGHT TO USE "ROADTRAC", APART FROM THE MARK AS SHOWN.

FOR TRACKING, LOCATING, AND MONITORING OF VEHICLES, MARITIME VESSELS, AIRCRAFT, ROLLING RAILROAD STOCK, CARGO CONTAINERS, AND LIQUIDS STORED IN BULK (U.S. CLS. 100, 101 AND 102).

FIRST USE 10-23-2004; IN COMMERCE 10-23-2004.

CLASS 35—(Continued).

3,313,405. FORMAN MILLS, INC., PENNSAUKEN, NJ. SN 78-317,508. PUB. 5-10-2005, FILED 10-23-2003.

WE'VE GOT THE LOOK

FOR RETAIL STORE SERVICES FEATURING CLOTHING (U.S. CLS. 100, 101 AND 102).

FIRST USE 12-0-1988; IN COMMERCE 12-0-1988.

3,313,418. SUNSHINE ACE HARDWARE, INC., NAPLES, FL. SN 78-353,164. PUB. 8-16-2005, FILED 1-16-2004.

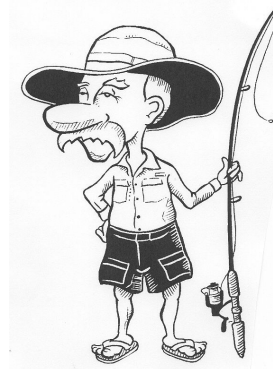

THE LINING IS A FEATURE OF THE MARK AND DOES NOT INDICATE COLOR.

FOR RETAIL STORE SERVICES IN THE FIELDS OF HARDWARE, INDOOR AND OUTDOOR ACCESSORIES, SPORTING GOODS, HOME IMPROVEMENT AND HOUSEWARES (U.S. CLS. 100, 101 AND 102).

FIRST USE 5-8-2007; IN COMMERCE 5-8-2007.

3,313,426. PANNELL-FINDLEY, PAMELA D., WEST FARGO, ND. SN 78-371,653. PUB. 1-18-2005, FILED 2-20-2004.

DISCOUNT SPENDERS

THE MARK CONSISTS OF STANDARD CHARACTERS WITHOUT CLAIM TO ANY PARTICULAR FONT, STYLE, SIZE, OR COLOR.

NO CLAIM IS MADE TO THE EXCLUSIVE RIGHT TO USE "DISCOUNT", APART FROM THE MARK AS SHOWN.

FOR RETAIL AND WHOLESALE STORE, AND MAIL ORDER AND ON-LINE STORE SERVICES FEATURING GENERAL MERCHANDISE, MUSIC, CLOTHING, FOOD, ELECTRONICS, FURNITURE, VITAMINS, VITAMIN SUPPLEMENTS, BOOKS, VIDEOS, MULTIMEDIA, AND COMPUTER SOFTWARE (U.S. CLS. 100, 101 AND 102).

FIRST USE 2-20-2004; IN COMMERCE 4-4-2007.

CLASS 35—(Continued).

3,313,464. KOP-FLEX, INC., HANOVER, MD. SN 78-442,440. PUB. 9-6-2005, FILED 6-28-2004.

ICAP

THE MARK CONSISTS OF STANDARD CHARACTERS WITHOUT CLAIM TO ANY PARTICULAR FONT, STYLE, SIZE, OR COLOR.

FOR PROVIDING AN INTERACTIVE WEBSITE FOR ASSISTING CUSTOMERS IN THE SELECTION OF COMMERCIAL AND INDUSTRIAL TRANSMISSION COUPLING PRODUCTS (U.S. CLS. 100, 101 AND 102).

FIRST USE 11-30-2004; IN COMMERCE 11-30-2004.

CLASS 35—(Continued).

3,313,482. THYSSENKRUPP ELEVATOR CAPITAL CORPORATION, TROY, MI. SN 78-479,917. PUB. 10-11-2005, FILED 9-8-2004.

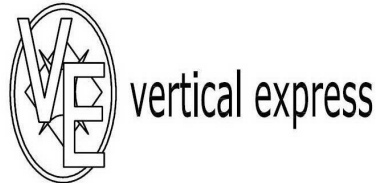

THE MARK CONSISTS OF THE LETTERS "V" AND "E" IN AN OVAL WITH THE WORDS "VERTICAL EXPRESS" ADJACENT TO THE RIGHT OF THE OVAL.

FOR DISTRIBUTORSHIP SERVICES IN THE FIELD OF ELEVATORS AND ELEVATOR PARTS (U.S. CLS. 100, 101 AND 102).

FIRST USE 3-8-2006; IN COMMERCE 3-8-2006.

3,313,474. UNITED STATES MARINE CORPS, A COMPONENT OF THE DEPARTMENT OF THE NAVY, ARLINGTON, VA. SN 78-461,142. PUB. 7-5-2005, FILED 8-3-2004.

M4L

THE MARK CONSISTS OF STANDARD CHARACTERS WITHOUT CLAIM TO ANY PARTICULAR FONT, STYLE, SIZE, OR COLOR.

FOR PROVIDING REFERRALS IN THE FIELDS OF EMPLOYMENT COUNSELING, OUTPLACEMENT AND CAREER NETWORKING SERVICES; PROVIDING REFERRALS IN THE FIELDS OF PRIMARY, SECONDARY AND POSTSECONDARY EDUCATION INCLUDING VOCATIONAL/TECHNICAL EDUCATION; PROVIDING REFERRALS IN THE FIELD OF CHILDCARE; PROVIDING REFERRALS IN THE FIELD OF MILITARY VETERAN'S BENEFITS; PROVIDING ON-LINE DIRECTORY SERVICES FEATURING THE SERVICES OF OTHERS IN THE FIELDS OF EMPLOYMENT COUNSELING, OUTPLACEMENT AND CAREER NETWORKING, PRIMARY, SECONDARY AND POSTSECONDARY EDUCATION INCLUDING VOCATIONAL/TECHNICAL EDUCATION, CHILDCARE, AND MILITARY VETERAN'S BENEFITS (U.S. CLS. 100, 101 AND 102).

FIRST USE 12-2-2006; IN COMMERCE 12-2-2006.

3,313,497. STAPLES THE OFFICE SUPERSTORE, LLC, FRAMINGHAM, MA. SN 78-485,187. PUB. 10-25-2005, FILED 9-17-2004.



NO CLAIM IS MADE TO THE EXCLUSIVE RIGHT TO USE "EASY REBATES", APART FROM THE MARK AS SHOWN.

FOR RETAIL STORE SERVICES, MAIL ORDER CATALOG SERVICES, AND COMPUTERIZED ONLINE RETAIL STORE SERVICES FEATURING OFFICE SUPPLIES, OFFICE EQUIPMENT, INCLUDING COMPUTER HARDWARE, COPIERS AND TELEPHONES, AND OFFICE FURNITURE (U.S. CLS. 100, 101 AND 102).

FIRST USE 9-0-2004; IN COMMERCE 9-0-2004.

CLASS 35—(Continued).

3,313,512. FEIGIN, MICHAEL, SPRING, TX. SN 78-507,461.
PUB. 2-28-2006, FILED 10-28-2004.

MAINSTREET AMERICA

THE MARK CONSISTS OF STANDARD CHARACTERS WITHOUT CLAIM TO ANY PARTICULAR FONT, STYLE, SIZE, OR COLOR.

NO CLAIM IS MADE TO THE EXCLUSIVE RIGHT TO USE "AMERICA", APART FROM THE MARK AS SHOWN. FOR RESIDENTIAL HOME, CONSUMER GOOD, AND BUILDING PRODUCTS PROMOTIONAL SERVICES, NAMELY, CONDUCTING HOME TOURS SHOWCASING RESIDENTIAL HOME, CONSUMER GOOD, AND BUILDING PRODUCTS (U.S. CLS. 100, 101 AND 102).
FIRST USE 12-31-2005; IN COMMERCE 12-31-2005.

3,313,527. ERICKSSON ASSOCIATES, ATLANTA, GA. SN 78-528,613. PUB. 9-27-2005, FILED 12-7-2004.

**EXPERIENCE LEADS
TO RESULTS IN
BLACK & WHITE.**

THE MARK CONSISTS OF STANDARD CHARACTERS WITHOUT CLAIM TO ANY PARTICULAR FONT, STYLE, SIZE, OR COLOR.

FOR EMPLOYMENT HIRING, RECRUITING, PLACEMENT, STAFFING AND CAREER NETWORKING SERVICES (U.S. CLS. 100, 101 AND 102).
FIRST USE 10-1-2003; IN COMMERCE 10-1-2003.

3,313,531. PEPPER NA INC., CHICAGO, IL. SN 78-531,741.
PUB. 8-8-2006, FILED 12-13-2004.

PEPPER

THE MARK CONSISTS OF STANDARD CHARACTERS WITHOUT CLAIM TO ANY PARTICULAR FONT, STYLE, SIZE, OR COLOR.

FOR CONSULTANCY SERVICES REGARDING INTEGRATED BUSINESS STRATEGIES FOR EMPLOYEE, CUSTOMER AND SHAREHOLDER RELATIONSHIP MANAGEMENT (U.S. CLS. 100, 101 AND 102).
FIRST USE 11-1-2004; IN COMMERCE 11-1-2004.

CLASS 35—(Continued).

3,313,538. CHAMPAGNE TENNIS ETCETERA LTD., NORTH VENICE, FL. SN 78-537,004. PUB. 4-4-2006, FILED 12-22-2004.

CHAMPAGNE TENNIS

THE MARK CONSISTS OF STANDARD CHARACTERS WITHOUT CLAIM TO ANY PARTICULAR FONT, STYLE, SIZE, OR COLOR.

NO CLAIM IS MADE TO THE EXCLUSIVE RIGHT TO USE "TENNIS", APART FROM THE MARK AS SHOWN.

FOR BUSINESS CONSULTING AND INFORMATION SERVICES; BUSINESS MARKETING CONSULTING SERVICES; CONSULTING SERVICES RELATING TO PUBLICITY; MARKETING CONSULTING; AGENCY REPRESENTATION FOR ATHLETES, MAINLY PUBLICITY AGENTS FOR ATHLETES; MANAGEMENT OF PROFESSIONAL ATHLETES; ADVERTISING AGENCY SERVICES; ADVERTISING SERVICES, NAMELY PROMOTING THE GOODS AND SERVICES OF OTHERS (U.S. CLS. 100, 101 AND 102).

FIRST USE 5-4-2006; IN COMMERCE 5-4-2006.

3,313,543. CAPRIOLA CORP., SARASOTA, FL. SN 78-540,183.
PUB. 1-31-2006, FILED 12-30-2004.

**MAKING IDEAS A
REALITY**

THE MARK CONSISTS OF STANDARD CHARACTERS WITHOUT CLAIM TO ANY PARTICULAR FONT, STYLE, SIZE, OR COLOR.

FOR WHOLESALE AND RETAIL STORE SERVICES FEATURING INVENTIONS AND NEW PRODUCTS IN A WIDE VARIETY OF FIELDS (U.S. CLS. 100, 101 AND 102).

FIRST USE 10-0-2005; IN COMMERCE 10-0-2005.

CLASS 35—(Continued).

3,313,554. JONES, PATRICK W., HAMPTON COVE, AL. SN 78-550,911. PUB. 11-14-2006, FILED 1-20-2005.

GARRUS

THE MARK CONSISTS OF STANDARD CHARACTERS WITHOUT CLAIM TO ANY PARTICULAR FONT, STYLE, SIZE, OR COLOR.

FOR BUSINESS MANAGEMENT CONSULTING SERVICES WITH REGARD TO THE RETAIL AND WHOLESALE ISSUES OF BUSINESSES ACROSS ALL BUSINESS INDUSTRIES (U.S. CLS. 100, 101 AND 102).

FIRST USE 2-0-2005; IN COMMERCE 2-0-2005.

3,313,557. GREATER DES MOINES COMMUNITY FOUNDATION, DES MOINES, IA. SN 78-552,567. PUB. 12-6-2005, FILED 1-24-2005.

LifeTown Legacy

THE MARK CONSISTS OF STANDARD CHARACTERS WITHOUT CLAIM TO ANY PARTICULAR FONT, STYLE, SIZE, OR COLOR.

FOR PROMOTING PUBLIC AWARENESS OF THE NEED FOR CHARITABLE ESTATE PLANNING AT THE COMMUNITY LEVEL (U.S. CLS. 100, 101 AND 102).

FIRST USE 5-11-2005; IN COMMERCE 5-11-2005.

CLASS 35—(Continued).

3,313,563. AMERICAN GIRL, LLC, EL SEGUNDO, CA. SN 78-562,095. PUB. 9-26-2006, FILED 2-7-2005.

EVERY STORY HAS A STAR

THE MARK CONSISTS OF STANDARD CHARACTERS WITHOUT CLAIM TO ANY PARTICULAR FONT, STYLE, SIZE, OR COLOR.

FOR DIRECT MAIL CATALOG SERVICES, RETAIL STORE SERVICES AND ON-LINE RETAIL SERVICES ALL FEATURING DOLLS, DOLL CLOTHING, DOLL ACCESSORIES, DOLL FURNITURE, TOYS, CHILDREN'S PARTY GAMES, STUFFED TOY ANIMALS, CLOTHING AND ACCESSORIES FOR STUFFED TOY ANIMALS, CHILDREN'S FICTION AND NON-FICTION BOOKS AND OTHER PUBLICATIONS FOR CHILDREN, SCHOOL SUPPLIES NAMELY NOTEBOOKS, PENCILS, AND PENS, LUGGAGE, HANDBAGS, WALLETS, PURSES, BACKPACKS, TOTE BAGS, DUFFEL BAGS, HAIR ORNAMENTS, BARRETTES, HAIR CLIPS, HAIR-BRUSHES, BATH AND SHOWER GELS, BAR SOAPS FOR HANDS FACE AND BODY, BATH CRYSTALS, HAIR SHAMPOO, SHAMPOO CONDITIONERS, HAIR CONDITIONERS, SKIN MOISTURIZERS, SKIN LOTION, NON-MEDICATED LIP BALM (U.S. CLS. 100, 101 AND 102).

FIRST USE 9-1-2006; IN COMMERCE 9-1-2006.

3,313,564. AMERICAN GIRL, LLC, EL SEGUNDO, CA. SN 78-562,096. PUB. 9-26-2006, FILED 2-7-2005.

YOUR STORY YOUR STAR

THE MARK CONSISTS OF STANDARD CHARACTERS WITHOUT CLAIM TO ANY PARTICULAR FONT, STYLE, SIZE, OR COLOR.

FOR DIRECT MAIL CATALOG SERVICES, RETAIL STORE SERVICES AND ON-LINE RETAIL SERVICES ALL FEATURING DOLLS, DOLL CLOTHING, DOLL ACCESSORIES, DOLL FURNITURE, TOYS, CHILDREN'S PARTY GAMES, STUFFED TOY ANIMALS, CLOTHING AND ACCESSORIES FOR STUFFED TOY ANIMALS, CHILDREN'S FICTION AND NON-FICTION BOOKS AND OTHER PUBLICATIONS FOR CHILDREN, SCHOOL SUPPLIES NAMELY NOTEBOOKS, PENCILS, AND PENS, LUGGAGE, HANDBAGS, WALLETS, PURSES, BACKPACKS, TOTE BAGS, DUFFEL BAGS, HAIR ORNAMENTS, BARRETTES, HAIR CLIPS, HAIR-BRUSHES, BATH AND SHOWER GELS, BAR SOAPS FOR HANDS FACE AND BODY, BATH CRYSTALS, HAIR SHAMPOO, SHAMPOO CONDITIONERS, HAIR CONDITIONERS, SKIN MOISTURIZERS, SKIN LOTION, NON-MEDICATED LIP BALM (U.S. CLS. 100, 101 AND 102).

FIRST USE 9-1-2006; IN COMMERCE 9-1-2006.

CLASS 35—(Continued).

3,313,582. GIFT CERTIFICATE CENTER, INC., MINNEAPOLIS, MN. SN 78-578,121. PUB. 1-31-2006, FILED 3-2-2005.

THE INVENTIVE INCENTIVE PEOPLE

THE MARK CONSISTS OF STANDARD CHARACTERS WITHOUT CLAIM TO ANY PARTICULAR FONT, STYLE, SIZE, OR COLOR.

NO CLAIM IS MADE TO THE EXCLUSIVE RIGHT TO USE "INCENTIVE PEOPLE", APART FROM THE MARK AS SHOWN.

FOR PROMOTING BY TELEPHONE, FACSIMILE, MAIL, ELECTRONIC MAIL, OR THE WORLD WIDE WEB THE GOODS AND SERVICES OF OTHERS THROUGH THE DISTRIBUTION OF ACTUAL OR VIRTUAL GIFT CERTIFICATES, GIFT CARDS, DEBIT CARDS OR STORED VALUE CARDS TO EMPLOYEES TO REWARD LOYALTY, PERFORMANCE, SALES OR OTHER ACHIEVEMENTS OR EVENTS, OR TO CONSUMERS TO PROMOTE PARTICULAR PRODUCTS, SERVICES, BRANDS OR COMPANIES; PROVIDING BUSINESS CONSULTING SERVICES IN THE FIELD OF EMPLOYEE AND CONSUMER RECOGNITION PROGRAMS TO IMPROVE AND REWARD THE PERFORMANCE, ACQUISITION, RETENTION AND LOYALTY OF EMPLOYEES, CUSTOMERS, AND PARTNERS; CONDUCTING EMPLOYEE AND CONSUMER RECOGNITION PROGRAMS TO IMPROVE AND REWARD THE PERFORMANCE, ACQUISITION, RETENTION AND LOYALTY OF EMPLOYEES, CUSTOMERS AND PARTNERS; AND BUSINESS MANAGEMENT AND CONSULTATION IN THE FIELD OF EMPLOYEE AND CONSUMER RECOGNITION PROGRAMS TO IMPROVE AND REWARD THE PERFORMANCE, ACQUISITION, RETENTION AND LOYALTY OF EMPLOYEES, CUSTOMERS AND PARTNERS (U.S. CLS. 100, 101 AND 102).
FIRST USE 4-19-2007; IN COMMERCE 4-19-2007.

3,313,583. BURKE READ GROUP, SAUSALITO, CA. SN 78-578,403. PUB. 8-1-2006, FILED 3-2-2005.

BRAND ENGINE

THE MARK CONSISTS OF STANDARD CHARACTERS WITHOUT CLAIM TO ANY PARTICULAR FONT, STYLE, SIZE, OR COLOR.

NO CLAIM IS MADE TO THE EXCLUSIVE RIGHT TO USE "BRAND", APART FROM THE MARK AS SHOWN.

FOR CONSULTING SERVICES IN THE FIELDS OF CORPORATE IDENTITY DEVELOPMENT, PRODUCT AND SERVICE BRANDING, STRATEGIC BRANDING, AND BRAND POSITIONING; CREATING, EVALUATING, AND MANAGING BRAND NAMES, TRADEMARKS, SERVICE MARKS AND BUSINESS NAMES FOR OTHERS (U.S. CLS. 100, 101 AND 102).
FIRST USE 4-20-2005; IN COMMERCE 9-14-2005.

CLASS 35—(Continued).

3,313,591. LEAPFROG ONLINE CUSTOMER ACQUISITION, LLC, EVANSTON, IL. SN 78-582,979. PUB. 12-13-2005, FILED 3-8-2005.

LFO PROMOTIONS

THE MARK CONSISTS OF STANDARD CHARACTERS WITHOUT CLAIM TO ANY PARTICULAR FONT, STYLE, SIZE, OR COLOR.

NO CLAIM IS MADE TO THE EXCLUSIVE RIGHT TO USE "PROMOTIONS", APART FROM THE MARK AS SHOWN.

FOR ONLINE RETAIL ORDERING SERVICES FEATURING GENERAL MERCHANDISE AND GENERAL CONSUMER GOODS; MARKETING SERVICES FEATURING GOODS AND SERVICES OF OTHER VENDORS (U.S. CLS. 100, 101 AND 102).

FIRST USE 10-31-2005; IN COMMERCE 10-31-2005.

3,313,599. NATIONALWAY HEALTHCARE ASSOCIATION, HOUSTON, TX. SN 78-586,661. PUB. 11-29-2005, FILED 3-14-2005.

NationalWay

THE MARK CONSISTS OF STANDARD CHARACTERS WITHOUT CLAIM TO ANY PARTICULAR FONT, STYLE, SIZE, OR COLOR.

FOR ASSOCIATION SERVICES, NAMELY, PROMOTING THE INTERESTS OF CONSUMERS WHO DESIRE AND REQUIRE ACCESS TO HEALTHCARE AND RELATED PRODUCTS AND SERVICES (U.S. CLS. 100, 101 AND 102).

FIRST USE 8-19-2005; IN COMMERCE 8-19-2005.

CLASS 35—(Continued).

3,313,618. COMPONENT ELECTRONICS CORPORATION, LEWISVILLE, TX. SN 78-597,492. PUB. 11-21-2006, FILED 3-29-2005.



THE COLOR(S) GREEN AND GRAY IS/ARE CLAIMED AS A FEATURE OF THE MARK.

THE MARK CONSISTS OF A STYLIZED LETTER "C" WITH THE LETTER "E" APPEARING IN THE CENTER. THE ENTIRE MARK IS GREEN WITH A GRAY OUTLINE.

FOR DISTRIBUTORSHIP SERVICES IN THE FIELD OF ELECTRICAL AND ELECTRONIC COMPONENTS (U.S. CLS. 100, 101 AND 102).

FIRST USE 1-1-2005; IN COMMERCE 1-1-2005.

3,313,621. MARTINI, LLC, DBA GAME TIME MARKETING, COLUMBIA, MD. SN 78-600,888. PUB. 6-27-2006, FILED 4-4-2005.

GAME TIME MARKETING

THE MARK CONSISTS OF STANDARD CHARACTERS WITHOUT CLAIM TO ANY PARTICULAR FONT, STYLE, SIZE, OR COLOR.

NO CLAIM IS MADE TO THE EXCLUSIVE RIGHT TO USE "MARKETING", APART FROM THE MARK AS SHOWN.

FOR ADVERTISING AND MARKETING SERVICES, NAMELY, YOUTH SPORTS MARKETING SERVICES; SPORTS MARKETING CONSULTING SERVICES (U.S. CLS. 100, 101 AND 102).

FIRST USE 3-0-2005; IN COMMERCE 3-0-2005.

CLASS 35—(Continued).

3,313,659. RED HAT SOCIETY, INC., FULLERTON, CA. SN 78-617,861. PUB. 8-1-2006, FILED 4-27-2005.

FUN POINTS

THE MARK CONSISTS OF STANDARD CHARACTERS WITHOUT CLAIM TO ANY PARTICULAR FONT, STYLE, SIZE, OR COLOR.

NO CLAIM IS MADE TO THE EXCLUSIVE RIGHT TO USE "POINTS", APART FROM THE MARK AS SHOWN.

FOR ADMINISTRATION OF A MEMBERSHIP CREDIT PROGRAM THAT PROMOTES THE SALE OF THE GOODS AND SERVICES OF OTHERS BY AWARDING PURCHASE POINTS FOR CREDIT CARD USE (U.S. CLS. 100, 101 AND 102).

FIRST USE 2-6-2006; IN COMMERCE 3-1-2006.

3,313,678. CANINE EXPERIENCE, LLC, JERSEY CITY, NJ. SN 78-624,363. PUB. 7-4-2006, FILED 5-5-2005.



CANISMINOR

The Small Dog Specialists

NO CLAIM IS MADE TO THE EXCLUSIVE RIGHT TO USE "THE SMALL DOG SPECIALISTS", APART FROM THE MARK AS SHOWN.

THE ENGLISH TRANSLATION OF CANIS MINOR IS "LESSER DOG".

FOR RETAIL PET SUPPLY STORE SERVICES (U.S. CLS. 100, 101 AND 102).

FIRST USE 3-0-2005; IN COMMERCE 3-0-2005.

3,313,683. GOODWILL INDUSTRIES INTERNATIONAL, INC., ROCKVILLE, MD. SN 78-625,257. PUB. 7-18-2006, FILED 5-9-2005.



OWNER OF U.S. REG. NOS. 1,224,492, 2,811,694, AND 2,811,695.

NO CLAIM IS MADE TO THE EXCLUSIVE RIGHT TO USE STAFFING, APART FROM THE MARK AS SHOWN.

FOR EMPLOYMENT, HIRING, RECRUITING, PLACEMENT, STAFFING AND COUNSELING SERVICES (U.S. CLS. 100, 101 AND 102).

FIRST USE 4-1-2005; IN COMMERCE 4-1-2005.

CLASS 35—(Continued).

3,313,704. BAILEY & WAGS INC., JUPITER, FL. SN 78-636,775. PUB. 2-7-2006, FILED 5-25-2005.

CLASS 35—(Continued).

3,313,737. LONGS DRUG STORES CALIFORNIA, INC., WALNUT CREEK, CA. SN 78-651,512. PUB. 9-5-2006, FILED 6-15-2005.

BAILEY & WAGS

THE MARK CONSISTS OF STANDARD CHARACTERS WITHOUT CLAIM TO ANY PARTICULAR FONT, STYLE, SIZE, OR COLOR.

FOR ON-LINE RETAIL STORE SERVICES FEATURING GIFTS AND NOVELTY ITEMS FOR PETS AND THEIR OWNERS (U.S. CLS. 100, 101 AND 102).
FIRST USE 1-0-2006; IN COMMERCE 1-0-2006.

ESCALANTE SOLUTIONS

THE MARK CONSISTS OF STANDARD CHARACTERS WITHOUT CLAIM TO ANY PARTICULAR FONT, STYLE, SIZE, OR COLOR.

NO CLAIM IS MADE TO THE EXCLUSIVE RIGHT TO USE "SOLUTIONS", APART FROM THE MARK AS SHOWN.
FOR PHARMACY SERVICES, RETAIL, MAIL ORDER AND ONLINE PRESCRIPTION REFILL SERVICES; PRESCRIPTION PROCESSING (U.S. CLS. 100, 101 AND 102).
FIRST USE 0-0-2001; IN COMMERCE 8-0-2002.

3,313,732. MAKEPEACE, CLAYTON, SARASOTA, FL. SN 78-650,324. PUB. 3-7-2006, FILED 6-14-2005.

MAKEPEACE MAGIC

THE MARK CONSISTS OF STANDARD CHARACTERS WITHOUT CLAIM TO ANY PARTICULAR FONT, STYLE, SIZE, OR COLOR.

THE NAME(S), PORTRAIT(S), AND/OR SIGNATURE(S) SHOWN IN THE MARK IDENTIFIES CLAYTON MAKEPEACE, WHOSE CONSENT(S) TO REGISTER IS SUBMITTED.
FOR BUSINESS MARKETING AND ADVERTISING SERVICES (U.S. CLS. 100, 101 AND 102).
FIRST USE 6-9-2005; IN COMMERCE 6-9-2005.

3,313,782. PAI SERVICES, LLC, MORRESTOWN, NJ. SN 78-669,209. PUB. 9-5-2006, FILED 7-13-2005.

PAYCHOICE

3,313,733. MAKEPEACE, CLAYTON, SARASOTA, FL. SN 78-650,329. PUB. 3-7-2006, FILED 6-14-2005.

THE MAKEPEACE MAGIC

THE MARK CONSISTS OF STANDARD CHARACTERS WITHOUT CLAIM TO ANY PARTICULAR FONT, STYLE, SIZE, OR COLOR.

THE NAME(S), PORTRAIT(S), AND/OR SIGNATURE(S) SHOWN IN THE MARK IDENTIFIES CLAYTON MAKEPEACE, WHOSE CONSENT(S) TO REGISTER IS SUBMITTED.
FOR BUSINESS MARKETING AND ADVERTISING SERVICES (U.S. CLS. 100, 101 AND 102).
FIRST USE 6-9-2005; IN COMMERCE 6-9-2005.

THE MARK CONSISTS OF STANDARD CHARACTERS WITHOUT CLAIM TO ANY PARTICULAR FONT, STYLE, SIZE, OR COLOR.

FOR ADMINISTRATION OF BUSINESS PAYROLL FOR OTHERS; PAYROLL PREPARATION FOR OTHERS (U.S. CLS. 100, 101 AND 102).
FIRST USE 6-13-2005; IN COMMERCE 8-1-2005.

CLASS 35—(Continued).

3,313,794. NU HORIZONS ELECTRONICS CORP., MELVILLE, NY. SN 78-674,408. PUB. 11-14-2006, FILED 7-20-2005.

NUXCHANGE

THE MARK CONSISTS OF STANDARD CHARACTERS WITHOUT CLAIM TO ANY PARTICULAR FONT, STYLE, SIZE, OR COLOR.

FOR OUTSOURCED SERVICES FOR ELECTRONIC BUSINESS TO BUSINESS TRANSACTION EXCHANGE WHICH INCLUDES EDI, XML OR CUSTOM DATA FORMATS, OR OTHER E-COMMERCE TRANSACTIONS IN THE NATURE OF BUSINESS MANAGEMENT, NAMELY, PERFORMING ORDER FULFILLMENT SERVICES FOR CUSTOMERS, AND CONSULTING SERVICES RELATED THERETO FOR COMPANIES WITH THEIR OWN HARDWARE AND SOFTWARE UTILIZED FOR E-COMMERCE ACTIVITIES (U.S. CLS. 100, 101 AND 102).

FIRST USE 4-29-2005; IN COMMERCE 4-29-2005.

CLASS 35—(Continued).

3,313,817. HUNTER, RACHEL PRITZKER, CHICAGO, IL. SN 78-683,947. PUB. 11-7-2006, FILED 8-2-2005.

THE LOTUS FOUNDATION

THE MARK CONSISTS OF STANDARD CHARACTERS WITHOUT CLAIM TO ANY PARTICULAR FONT, STYLE, SIZE, OR COLOR.

NO CLAIM IS MADE TO THE EXCLUSIVE RIGHT TO USE "FOUNDATION", APART FROM THE MARK AS SHOWN.

FOR FOUNDATION SERVICES, NAMELY, ASSOCIATION SERVICES PROMOTING THE INTERESTS OF THE MEMBERS OF THE ASSOCIATION AND THE GENERAL PUBLIC CONCERNING ECONOMICS, FOREIGN POLICY, HEALTHCARE, ELECTORAL PROCESSES, ENERGY INDEPENDENCE, EDUCATION, CIVIL LIBERTIES, CIVIL RIGHTS AND THE ROLES OF MEDIA AND RELIGION IN A DEMOCRATIC SOCIETY (U.S. CLS. 100, 101 AND 102).

FIRST USE 9-22-2005; IN COMMERCE 9-22-2005.

3,313,822. THE WAY, LTD, BEAR, DE. SN 78-686,435. PUB. 10-3-2006, FILED 8-5-2005.

The Leadership Caddie

THE MARK CONSISTS OF STANDARD CHARACTERS WITHOUT CLAIM TO ANY PARTICULAR FONT, STYLE, SIZE, OR COLOR.

NO CLAIM IS MADE TO THE EXCLUSIVE RIGHT TO USE "LEADERSHIP", APART FROM THE MARK AS SHOWN.

FOR BUSINESS MANAGEMENT CONSULTATION IN THE FIELD OF LEADERSHIP AND LEADERSHIP DEVELOPMENT (U.S. CLS. 100, 101 AND 102).

FIRST USE 2-0-2006; IN COMMERCE 2-0-2006.

3,313,795. ARCO CHOCOLATE COMPANY, LLC, ELK RIVER, MN. SN 78-674,486. PUB. 11-7-2006, FILED 7-20-2005.

THE CHOCOLATE CROCODILE

THE MARK CONSISTS OF STANDARD CHARACTERS WITHOUT CLAIM TO ANY PARTICULAR FONT, STYLE, SIZE, OR COLOR.

NO CLAIM IS MADE TO THE EXCLUSIVE RIGHT TO USE "CHOCOLATE", APART FROM THE MARK AS SHOWN.

FOR RETAIL STORE SERVICES FEATURING CANDIES, CONFECTIONS AND CHOCOLATES (U.S. CLS. 100, 101 AND 102).

FIRST USE 3-0-2005; IN COMMERCE 3-0-2005.

3,313,828. HILLIARD, BRIAN WESLEY, SIMPSONVILLE, SC. SN 78-691,149. PUB. 9-26-2006, FILED 8-11-2005.

LIVE LIFE ALL-IN

THE MARK CONSISTS OF STANDARD CHARACTERS WITHOUT CLAIM TO ANY PARTICULAR FONT, STYLE, SIZE, OR COLOR.

FOR ADVERTISING AND MARKETING SERVICES IN THE FIELD OF EMPLOYMENT RECRUITMENT (U.S. CLS. 100, 101 AND 102).

FIRST USE 4-1-2007; IN COMMERCE 4-1-2007.

CLASS 35—(Continued).

3,313,833. NAKED MODERN, LLC, MILWAUKEE, WI. SN 78-692,799. PUB. 9-26-2006, FILED 8-15-2005.

NAKEDMODERN

THE MARK CONSISTS OF STANDARD CHARACTERS WITHOUT CLAIM TO ANY PARTICULAR FONT, STYLE, SIZE, OR COLOR.

FOR ON-LINE ART GALLERY; PROVIDING COMPUTERIZED ON-LINE RETAIL STORE SERVICES IN THE FIELD OF ART FEATURING PHOTOGRAPHS, BOOKS, CALENDARS, GREETING CARDS AND STATIONERY (U.S. CLS. 100, 101 AND 102).

FIRST USE 5-24-2004; IN COMMERCE 5-24-2004.

3,313,855. PERSHING INVESTMENTS LLC, NEWARK, DE. SN 78-703,042. PUB. 7-11-2006, FILED 8-30-2005.



FOR PROMOTING THE GOODS AND SERVICES OF OTHERS BY PROVIDING A WEBSITE AT WHICH USERS CAN OBTAIN INFORMATION TO CONTACT OTHERS TO PURCHASE TRAVEL AND ACCOMMODATIONS, ENTERTAINMENT COMPUTERS, COMPUTER HARDWARE, COMPUTER SOFTWARE, COMMUNICATIONS EQUIPMENT, WIRELESS COMMUNICATIONS EQUIPMENT OFFICE SUPPLIES, FURNITURE, FINANCIAL NEWS PRODUCTS AND SERVICES, MARKET DATA PRODUCTS AND SERVICES, FINANCIAL RESEARCH PRODUCTS AND SERVICES, FINANCIAL PLANNING PRODUCTS AND SERVICES, COMPENSATION PRODUCT AND SERVICES, BILLING ANALYSIS PRODUCT AND SERVICES, INSURANCE PRODUCT AND SERVICES (U.S. CLS. 100, 101 AND 102).

FIRST USE 8-31-2006; IN COMMERCE 8-31-2006.

CLASS 35—(Continued).

3,313,868. SMART CIRCLE INTERNATIONAL CORP., CONCORD, ONTARIO, CANADA. SN 78-707,926. PUB. 3-20-2007, FILED 9-7-2005.

SMART CIRCLE

THE MARK CONSISTS OF STANDARD CHARACTERS WITHOUT CLAIM TO ANY PARTICULAR FONT, STYLE, SIZE, OR COLOR.

FOR PROMOTING THE PRODUCTS AND SERVICES OF OTHERS THROUGH THE DISTRIBUTION OF PROMOTIONAL OR DISCOUNT CERTIFICATES; SALES PROMOTION SERVICES OF THE PROMOTIONAL OR DISCOUNT CERTIFICATES FOR PRODUCTS AND SERVICES OF OTHERS (U.S. CLS. 100, 101 AND 102).

FIRST USE 12-0-2005; IN COMMERCE 12-0-2005.

3,313,876. DART CHART SYSTEMS, MILWAUKEE, WI. SN 78-710,912. PUB. 12-26-2006, FILED 9-12-2005.

EDART

THE MARK CONSISTS OF STANDARD CHARACTERS WITHOUT CLAIM TO ANY PARTICULAR FONT, STYLE, SIZE, OR COLOR.

FOR MANAGEMENT AND COMPILATION OF COMPUTERIZED DATABASES (U.S. CLS. 100, 101 AND 102).

FIRST USE 11-0-2005; IN COMMERCE 11-0-2005.

3,313,878. WMK HOLDINGS, INC., WILMINGTON, DE. SN 78-711,552. PUB. 1-2-2007, FILED 9-13-2005.

**SUPERPETZ PET OWNERS
WAREHOUSE**

THE MARK CONSISTS OF STANDARD CHARACTERS WITHOUT CLAIM TO ANY PARTICULAR FONT, STYLE, SIZE, OR COLOR.

OWNER OF U.S. REG. NO. 1,910,329.

NO CLAIM IS MADE TO THE EXCLUSIVE RIGHT TO USE "PET OWNERS WAREHOUSE", APART FROM THE MARK AS SHOWN.

FOR RETAIL PET SUPPLY STORE SERVICES (U.S. CLS. 100, 101 AND 102).

FIRST USE 9-13-2005; IN COMMERCE 9-13-2005.

CLASS 35—(Continued).

3,313,880. SELL-HIGH LLC, WALTHAM, MA. SN 78-712,605. PUB. 7-11-2006, FILED 9-14-2005.

AuctionPal

THE MARK CONSISTS OF STANDARD CHARACTERS WITHOUT CLAIM TO ANY PARTICULAR FONT, STYLE, SIZE, OR COLOR.

FOR BUSINESS MANAGEMENT ASSISTANCE AND PARTICULARLY CARRYING OUT TASKS NECESSARY FOR THE SMOOTH CONDUCT OF SALES BY AUCTIONS (U.S. CLS. 100, 101 AND 102).

FIRST USE 11-14-2005; IN COMMERCE 11-14-2005.

3,313,919. CURRY, ALISON DAVIS, MILFORD, NJ. SN 78-729,117. PUB. 11-21-2006, FILED 10-7-2005.

MY URBAN SHERPA

THE MARK CONSISTS OF STANDARD CHARACTERS WITHOUT CLAIM TO ANY PARTICULAR FONT, STYLE, SIZE, OR COLOR.

FOR PROVIDING CONSUMER INFORMATION IN THE FIELD OF HEALTHFUL GROCERIES, HOTELS FEATURING GYMS AND SPAS, HEALTHFUL RESTAURANTS, GYMS, SPAS, PUBLIC AND PRIVATE FITNESS FACILITIES, BEAUTY SHOPS, SPORTS TRAINERS AND SPORT SPECIFIC INFORMATION FOR RUNNERS, BIKERS, SWIMMERS AND OTHER ATHLETES VIA A GLOBAL COMPUTER NETWORK (U.S. CLS. 100, 101 AND 102).

FIRST USE 1-23-2007; IN COMMERCE 1-23-2007.

3,313,924. MERCER HR SERVICES, LLC, NORWOOD, MA. SN 78-731,674. PUB. 1-9-2007, FILED 10-12-2005.

MERCER WORKPLACE SURVEY

THE MARK CONSISTS OF STANDARD CHARACTERS WITHOUT CLAIM TO ANY PARTICULAR FONT, STYLE, SIZE, OR COLOR.

OWNER OF U.S. REG. NOS. 2,638,066 AND 2,907,461.

NO CLAIM IS MADE TO THE EXCLUSIVE RIGHT TO USE "WORKPLACE SURVEY", APART FROM THE MARK AS SHOWN.

FOR CONDUCTING BUSINESS RESEARCH AND SURVEYS; CONDUCTING EMPLOYEE OPINION POLLS (U.S. CLS. 100, 101 AND 102).

FIRST USE 9-30-2006; IN COMMERCE 9-30-2006.

CLASS 35—(Continued).

3,313,936. GONE TO THE DOGS, INC., FAIRVIEW PARK, OH. SN 78-738,799. PUB. 6-27-2006, FILED 10-23-2005.

PRIDEDOG.COM

THE MARK CONSISTS OF STANDARD CHARACTERS WITHOUT CLAIM TO ANY PARTICULAR FONT, STYLE, SIZE, OR COLOR.

FOR ON-LINE RETAIL STORE SERVICES FEATURING PET-RELATED PRODUCTS AND SUPPLIES (U.S. CLS. 100, 101 AND 102).

FIRST USE 8-5-2006; IN COMMERCE 8-5-2006.

3,313,938. FMR CORP., BOSTON, MA. SN 78-739,216. PUB. 6-27-2006, FILED 10-24-2005.

OMNES NECESSARIAS RANAS OSCULABIMUS

THE MARK CONSISTS OF STANDARD CHARACTERS WITHOUT CLAIM TO ANY PARTICULAR FONT, STYLE, SIZE, OR COLOR.

THE FOREIGN WORDING IN THE MARK TRANSLATES INTO ENGLISH AS WE KISS AS MANY FROGS AS IT TAKES.

FOR EXECUTIVE SEARCH AND PLACEMENT SERVICES (U.S. CLS. 100, 101 AND 102).

FIRST USE 6-0-2005; IN COMMERCE 6-0-2005.

3,313,970. MOBILE HQ, INC., MESA, AZ. SN 78-747,269. PUB. 7-11-2006, FILED 11-4-2005.

MOBILEHQ

THE MARK CONSISTS OF STANDARD CHARACTERS WITHOUT CLAIM TO ANY PARTICULAR FONT, STYLE, SIZE, OR COLOR.

FOR FRANCHISE SERVICES, NAMELY, OFFERING TECHNICAL AND BUSINESS MANAGEMENT ASSISTANCE IN THE ESTABLISHMENT AND OPERATION OF RETAIL STORES OFFERING TELECOMMUNICATIONS SERVICE PLANS, TELECOMMUNICATIONS SERVICE ACTIVATION, AND TELECOMMUNICATIONS DEVICES AND ACCESSORIES; RETAIL STORE SERVICES FEATURING TELECOMMUNICATIONS SERVICE PLANS, TELECOMMUNICATIONS SERVICE ACTIVATION, AND TELECOMMUNICATIONS DEVICES AND ACCESSORIES (U.S. CLS. 100, 101 AND 102).

FIRST USE 4-15-2006; IN COMMERCE 4-15-2006.

CLASS 35—(Continued).

3,313,991. TEKSYSTEMS, INC., HANOVER, MD. SN 78-749,980. PUB. 1-16-2007, FILED 11-9-2005.



OWNER OF U.S. REG. NOS. 2,287,071, 2,896,875, AND OTHERS.

NO CLAIM IS MADE TO THE EXCLUSIVE RIGHT TO USE "SYSTEMS" AND "SOLUTIONS, LLC", APART FROM THE MARK AS SHOWN.

THE MARK CONSISTS OF THE TERMS "TEK SYSTEMS EF&I SOLUTIONS, LLC" IN STYLIZED FORM.

FOR EMPLOYMENT HIRING, RECRUITING, PLACEMENT, STAFFING AND CAREER NETWORKING SERVICES; TEMPORARY EMPLOYMENT AGENCIES (U.S. CLS. 100, 101 AND 102).

FIRST USE 12-15-2005; IN COMMERCE 12-15-2005.

3,314,000. THE ELECTRIC GRAPEVINE INCORPORATED, COSTA MESA, CA. SN 78-751,384. PUB. 7-25-2006, FILED 11-10-2005.

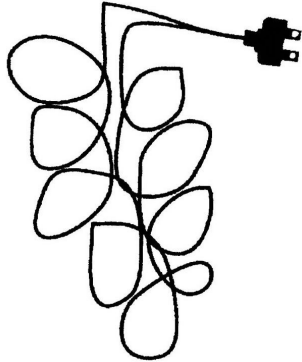

THE MARK CONSISTS OF A FANCIFUL SKETCH OF A GRAPE BUNCH WITH AN ELECTRICAL PLUG ATTACHED.

FOR ON-LINE RETAIL STORE SERVICES FEATURING CLOTHING (U.S. CLS. 100, 101 AND 102).

FIRST USE 3-30-2005; IN COMMERCE 4-17-2006.

3,314,022. SNAPBRIDGE SOFTWARE, INC., CARLSBAD, CA. SN 78-755,659. PUB. 7-11-2006, FILED 11-16-2005.

MOCHILA

THE MARK CONSISTS OF STANDARD CHARACTERS WITHOUT CLAIM TO ANY PARTICULAR FONT, STYLE, SIZE, OR COLOR.

CLASS 35—(Continued).

THE FOREIGN WORDING IN THE MARK TRANSLATES INTO ENGLISH AS BACK PACK.

FOR FACILITATING THE EXCHANGE OF NEEDED INFORMATION FOR FINANCIAL COMPENSATION VIA THE INTERNET (U.S. CLS. 100, 101 AND 102).

FIRST USE 4-1-2006; IN COMMERCE 4-1-2006.

3,314,044. MARRIOTT INTERNATIONAL, INC., BETHESDA, MD. SN 78-761,216. PUB. 8-1-2006, FILED 11-28-2005.

IN A PINCH

THE MARK CONSISTS OF STANDARD CHARACTERS WITHOUT CLAIM TO ANY PARTICULAR FONT, STYLE, SIZE, OR COLOR.

FOR RETAIL CONVENIENCE STORE SERVICES (U.S. CLS. 100, 101 AND 102).

FIRST USE 10-31-2006; IN COMMERCE 10-31-2006.

3,314,046. GALLART, RENEE, NORTHVILLE, MI. SN 78-761,446. PUB. 8-15-2006, FILED 11-28-2005.

ENGAGING EXPERIENCES. TRANSFORMING CULTURE.

THE MARK CONSISTS OF STANDARD CHARACTERS WITHOUT CLAIM TO ANY PARTICULAR FONT, STYLE, SIZE, OR COLOR.

FOR BUSINESS CONSULTATION SERVICES (U.S. CLS. 100, 101 AND 102).

FIRST USE 8-30-2006; IN COMMERCE 8-30-2006.

3,314,047. GALLART, RENEE, NORTHVILLE, MI. SN 78-761,449. PUB. 8-15-2006, FILED 11-28-2005.

KICK THE MOON

THE MARK CONSISTS OF STANDARD CHARACTERS WITHOUT CLAIM TO ANY PARTICULAR FONT, STYLE, SIZE, OR COLOR.

FOR BUSINESS CONSULTATION SERVICES (U.S. CLS. 100, 101 AND 102).

FIRST USE 9-30-2005; IN COMMERCE 9-30-2005.

CLASS 35—(Continued).

3,314,075. HILCO TRADING CO., INC., NORTHBROOK, IL. SN 78-765,446. PUB. 8-15-2006, FILED 12-2-2005.

SD RETAIL CONSULTING

THE MARK CONSISTS OF STANDARD CHARACTERS WITHOUT CLAIM TO ANY PARTICULAR FONT, STYLE, SIZE, OR COLOR.

NO CLAIM IS MADE TO THE EXCLUSIVE RIGHT TO USE "RETAIL CONSULTING", APART FROM THE MARK AS SHOWN.

FOR BUSINESS AND MANAGEMENT CONSULTING SERVICES FOR THE RETAIL INDUSTRY AND OTHERS TO ASSIST AND IMPROVE OPERATIONS (U.S. CLS. 100, 101 AND 102).

FIRST USE 1-31-2006; IN COMMERCE 1-31-2006.

3,314,079. REITZEL, ANDREW, S, MESA, AZ. SN 78-766,126. PUB. 8-8-2006, FILED 12-3-2005.

B2B Lead Machine

THE MARK CONSISTS OF STANDARD CHARACTERS WITHOUT CLAIM TO ANY PARTICULAR FONT, STYLE, SIZE, OR COLOR.

NO CLAIM IS MADE TO THE EXCLUSIVE RIGHT TO USE "B2B", APART FROM THE MARK AS SHOWN.

FOR TELEMARKETING (U.S. CLS. 100, 101 AND 102).

FIRST USE 10-1-2006; IN COMMERCE 10-1-2006.

3,314,088. STAMOR CORPORATION, NORFOLK, VA. SN 78-767,349. PUB. 8-15-2006, FILED 12-6-2005.

WHERE FASHION IS AFFORDABLE

THE MARK CONSISTS OF STANDARD CHARACTERS WITHOUT CLAIM TO ANY PARTICULAR FONT, STYLE, SIZE, OR COLOR.

OWNER OF U.S. REG. NO. 1,457,773.
FOR RETAIL CLOTHING STORE SERVICES (U.S. CLS. 100, 101 AND 102).

FIRST USE 2-1-2006; IN COMMERCE 2-1-2006.

CLASS 35—(Continued).

3,314,092. NORTHFORK ENTERPRISE, INC., SANTA CLARITA, CA. SN 78-767,863. PUB. 8-22-2006, FILED 12-6-2005.

NORTHFORK

THE MARK CONSISTS OF STANDARD CHARACTERS WITHOUT CLAIM TO ANY PARTICULAR FONT, STYLE, SIZE, OR COLOR.

FOR EMPLOYMENT COUNSELING AND RECRUITING, NAMELY, PROVIDING INFORMATION ABOUT PREVIOUS EMPLOYMENT AND EXPERIENCE OF POTENTIAL EMPLOYEES OR CONSULTANTS (U.S. CLS. 100, 101 AND 102).

FIRST USE 7-7-2005; IN COMMERCE 4-20-2007.

3,314,103. MAPCO EXPRESS, INC., BRENTWOOD, TN. SN 78-769,193. PUB. 2-6-2007, FILED 12-8-2005.

MAPCO MART

THE MARK CONSISTS OF STANDARD CHARACTERS WITHOUT CLAIM TO ANY PARTICULAR FONT, STYLE, SIZE, OR COLOR.

NO CLAIM IS MADE TO THE EXCLUSIVE RIGHT TO USE "MART", APART FROM THE MARK AS SHOWN.

FOR RETAIL CONVENIENCE STORE SERVICES (U.S. CLS. 100, 101 AND 102).

FIRST USE 12-21-2005; IN COMMERCE 12-21-2005.

3,314,104. DIVA DIAMONDS, NEW YORK, NY. SN 78-769,213. PUB. 8-22-2006, FILED 12-8-2005.

JEWELER TO THE WORLD

FOR RETAIL STORE AND WHOLESALE ORDERING, DISTRIBUTORSHIP AND STORE SERVICES FOR JEWELRY, NAMELY, WEDDING BANDS, RINGS, BRACELETS, PENDANTS, EARRINGS, NECKLACES, BROOCHES, PINS AND CHARMS (U.S. CLS. 100, 101 AND 102).

FIRST USE 10-0-2005; IN COMMERCE 9-0-2006.

CLASS 35—(Continued).

3,314,110. NUTRITION XPRESS, LLC, HOUSTON, TX. SN 78-771,175. PUB. 8-8-2006, FILED 12-12-2005.

NUTRITION CENTRAL

THE MARK CONSISTS OF STANDARD CHARACTERS WITHOUT CLAIM TO ANY PARTICULAR FONT, STYLE, SIZE, OR COLOR.

NO CLAIM IS MADE TO THE EXCLUSIVE RIGHT TO USE "NUTRITION", APART FROM THE MARK AS SHOWN.

FOR RETAIL STORE SERVICES FEATURING NUTRITIONAL SUPPLEMENTS, HEALTH SUPPLEMENTS AND VITAMINS (U.S. CLS. 100, 101 AND 102).

FIRST USE 5-1-2006; IN COMMERCE 5-1-2006.

CLASS 35—(Continued).

3,314,127. LIQUID ASSETS, L.L.C., BATON ROUGE, LA. SN 78-774,280. PUB. 10-3-2006, FILED 12-15-2005.

LIQUID ASSETS

THE MARK CONSISTS OF STANDARD CHARACTERS WITHOUT CLAIM TO ANY PARTICULAR FONT, STYLE, SIZE, OR COLOR.

FOR DISTRIBUTORSHIPS IN THE FIELD OF HAIR AND SKIN CARE PRODUCTS (U.S. CLS. 100, 101 AND 102).

FIRST USE 11-1-2003; IN COMMERCE 11-1-2003.

3,314,129. MUSTANG FASTENERS, INC., WESLEY CHAPEL, FL. SN 78-774,350. PUB. 8-22-2006, FILED 12-15-2005.

MUSTANG FASTENER & SALES

THE MARK CONSISTS OF STANDARD CHARACTERS WITHOUT CLAIM TO ANY PARTICULAR FONT, STYLE, SIZE, OR COLOR.

NO CLAIM IS MADE TO THE EXCLUSIVE RIGHT TO USE "FASTENER & SALES", APART FROM THE MARK AS SHOWN.

FOR WHOLESALE DISTRIBUTORSHIPS FEATURING METAL FASTENERS AND RELATED HARDWARE TO DISTRIBUTORS SERVING INDUSTRIAL, AGRICULTURAL, MINING AND OFF-HIGHWAY EQUIPMENT MANUFACTURERS, DEALERS AND END-USERS (U.S. CLS. 100, 101 AND 102).

FIRST USE 2-13-2007; IN COMMERCE 2-13-2007.

3,314,118. WORLD PROPERTIES INTERNATIONAL INC., WETHERSFIELD, CT. SN 78-772,297. PUB. 11-21-2006, FILED 12-13-2005.



NO CLAIM IS MADE TO THE EXCLUSIVE RIGHT TO USE "WORLD PROPERTIES INTERNATIONAL", APART FROM THE MARK AS SHOWN.

THE COLOR(S) BLUE, GOLD AND WHITE IS/ARE CLAIMED AS A FEATURE OF THE MARK.

THE MARK CONSISTS OF THE WORD INTERNATIONAL IS IN REVERSE BLUE AND WHITE. THE WORDS PROPERTIES, ONE COMPANY... ONE SOLUTION...NO BORDERS ARE IN GOLD. THE OCEANS ON THE GLOBE DESIGN ARE IN GOLD.

FOR FRANCHISING, NAMELY, OFFERING TECHNICAL ASSISTANCE IN THE ESTABLISHMENT AND/OR OPERATION OF REAL ESTATE AGENCY AND MORTGAGE BUSINESSES (U.S. CLS. 100, 101 AND 102).

FIRST USE 12-20-2004; IN COMMERCE 12-20-2004.

3,314,140. BUILD-A-BEAR RETAIL MANAGEMENT, INC., ST. LOUIS, MO. SN 78-775,926. PUB. 8-22-2006, FILED 12-19-2005.

WHERE WILD AND WONDERFUL FRIENDS ARE MADE

THE MARK CONSISTS OF STANDARD CHARACTERS WITHOUT CLAIM TO ANY PARTICULAR FONT, STYLE, SIZE, OR COLOR.

OWNER OF U.S. REG. NOS. 2,602,016 AND 2,612,934. FOR RETAIL STORE SERVICES IN THE FIELD OF STUFFED AND PLUSH ANIMALS AND ACCESSORIES THEREFOR (U.S. CLS. 100, 101 AND 102).

FIRST USE 3-30-2006; IN COMMERCE 3-30-2006.

CLASS 35—(Continued).

3,314,151. BENCHMARK BRANDS, INC., MEMPHIS, TN. SN 78-776,910. PUB. 8-29-2006, FILED 12-20-2005.

**FootSmart Keeps You Moving
In Comfort**

THE MARK CONSISTS OF STANDARD CHARACTERS WITHOUT CLAIM TO ANY PARTICULAR FONT, STYLE, SIZE, OR COLOR.

OWNER OF U.S. REG. NOS. 2,035,973, 2,767,304, AND OTHERS.

FOR MAIL ORDER AND ELECTRONIC CATALOG SERVICES FEATURING FOOTWEAR, FOOT CARE AND FOOT HEALTH PRODUCTS (U.S. CLS. 100, 101 AND 102).

FIRST USE 12-2-2005; IN COMMERCE 12-20-2005.

3,314,152. BENCHMARK BRANDS, INC., MEMPHIS, TN. SN 78-777,041. PUB. 9-19-2006, FILED 12-20-2005.

FootSmart

THE MARK CONSISTS OF STANDARD CHARACTERS WITHOUT CLAIM TO ANY PARTICULAR FONT, STYLE, SIZE, OR COLOR.

OWNER OF U.S. REG. NOS. 2,035,973, 2,767,304, AND OTHERS.

FOR ONLINE RETAIL STORE FEATURING FOOT CARE AND FOOT HEALTH PRODUCTS (U.S. CLS. 100, 101 AND 102).

FIRST USE 10-1-2000; IN COMMERCE 10-1-2000.

CLASS 35—(Continued).

3,314,201. AFFINION LOYALTY GROUP, INC., RICHMOND, VA. SN 78-785,658. PUB. 4-3-2007, FILED 1-5-2006.

**EXPERIENCE THE POWER OF
POINTS**

THE MARK CONSISTS OF STANDARD CHARACTERS WITHOUT CLAIM TO ANY PARTICULAR FONT, STYLE, SIZE, OR COLOR.

FOR PROMOTING THE GOODS AND SERVICES OF CLIENTS AND OTHERS THROUGH ON-LINE INCENTIVE AWARDS PROGRAMS, CUSTOMER LOYALTY PROGRAMS AND DISCOUNT PROGRAMS WHEREBY PARTICIPANTS ACCUMULATE POINTS BASED ON USAGE OF CREDIT CARDS, DEBIT CARDS AND OTHER CARDS AND INSTRUMENTS UTILIZED IN LOYALTY, INCENTIVE AND DISCOUNT PROGRAMS, WHICH CAN BE REDEEMED FOR FREE AND DISCOUNTED GOODS, SERVICES AND OTHER BENEFITS RELATED TO ELECTRONICS, CASH AWARDS, CHARITABLE CONTRIBUTIONS, SPORTS AND LEISURE ACTIVITIES, HOME GOODS, HEALTH AND BEAUTY PRODUCTS, MAGAZINES, ENTERTAINMENTS PRODUCTS, CONCERTS, DINING, TRAVEL, NAMELY, AIR, CAR RENTAL, HOTEL, VACATION PACKAGES AND CRUISES, AND OUTDOOR ACTIVITIES, NAMELY, RAFTING AND PARACHUTING (U.S. CLS. 100, 101 AND 102).

FIRST USE 6-1-2007; IN COMMERCE 6-1-2007.

3,314,226. AMERIPRISE FINANCIAL, INC., MINNEAPOLIS, MN. SN 78-791,481. PUB. 12-5-2006, FILED 1-13-2006.

CAPITAL INSIGHTS

THE MARK CONSISTS OF STANDARD CHARACTERS WITHOUT CLAIM TO ANY PARTICULAR FONT, STYLE, SIZE, OR COLOR.

NO CLAIM IS MADE TO THE EXCLUSIVE RIGHT TO USE "CAPITAL", APART FROM THE MARK AS SHOWN.

FOR CUSTOMER LOYALTY SERVICES AND CUSTOMER CLUB SERVICES FOR COMMERCIAL, PROMOTIONAL AND ADVERTISING PURPOSES (U.S. CLS. 100, 101 AND 102).

FIRST USE 5-8-2006; IN COMMERCE 5-8-2006.

CLASS 35—(Continued).

3,314,247. CHAMBERS, GLENN B., ST. AUGUSTINE, FL. SN 78-793,658. PUB. 9-12-2006, FILED 1-18-2006.

CHEF SAYS

THE MARK CONSISTS OF STANDARD CHARACTERS WITHOUT CLAIM TO ANY PARTICULAR FONT, STYLE, SIZE, OR COLOR.

FOR RETAIL STORE SERVICES FEATURING A WIDE VARIETY OF CONSUMER GOODS, NAMELY, GROCERIES, BEER, WINE, HOUSEWARES, PREPARED FOODS, SPICES AND BOOKS (U.S. CLS. 100, 101 AND 102).

FIRST USE 2-12-2007; IN COMMERCE 2-12-2007.

3,314,273. QWEST COMMUNICATIONS INTERNATIONAL INC., DENVER, CO. SN 78-798,509. PUB. 9-26-2006, FILED 1-24-2006.

QWEST GATE

THE MARK CONSISTS OF STANDARD CHARACTERS WITHOUT CLAIM TO ANY PARTICULAR FONT, STYLE, SIZE, OR COLOR.

FOR PROVIDING AN INTERACTIVE WEB SITE FOR VENDORS AND SUPPLIERS TO MANAGE ORDERS, INVOICES AND CONTRACTS (U.S. CLS. 100, 101 AND 102).

FIRST USE 5-8-2006; IN COMMERCE 5-8-2006.

3,314,290. HIRE TECHNOLOGIES, INC., AUSTIN, TX. SN 78-802,715. PUB. 1-2-2007, FILED 1-30-2006.

HIREPROS

THE MARK CONSISTS OF STANDARD CHARACTERS WITHOUT CLAIM TO ANY PARTICULAR FONT, STYLE, SIZE, OR COLOR.

OWNER OF U.S. REG. NO. 2,364,513.

FOR EMPLOYMENT SERVICES, NAMELY PERSONNEL PLACEMENT AND RECRUITMENT (U.S. CLS. 100, 101 AND 102).

FIRST USE 7-22-2001; IN COMMERCE 7-22-2001.

CLASS 35—(Continued).

3,314,324. K.P. AUTO CENTER, L.P., INGLEWOOD, CA. SN 78-809,422. PUB. 5-15-2007, FILED 2-7-2006.

LAX MOTORING

THE MARK CONSISTS OF STANDARD CHARACTERS WITHOUT CLAIM TO ANY PARTICULAR FONT, STYLE, SIZE, OR COLOR.

FOR AUTO MALL SERVICES, NAMELY, RETAIL AND WHOLESALE STORE AND DISTRIBUTORSHIP SERVICES FEATURING AUTOMOBILES, AUTOMOTIVE PARTS, AND AUTOMOBILE PARTS AND ACCESSORIES; AUTO MALL SERVICES, NAMELY, ON-LINE ORDERING SERVICES FEATURING AUTOMOBILES AND AUTOMOTIVE PARTS, AND AUTOMOBILE PARTS AND ACCESSORIES (U.S. CLS. 100, 101 AND 102).

FIRST USE 5-15-2007; IN COMMERCE 5-15-2007.

3,314,330. SHEFA FRANCHISES, LTD., MIAMI, FL. SN 78-810,018. PUB. 11-7-2006, FILED 2-8-2006.

AROMA ESPRESSO BAR

THE MARK CONSISTS OF STANDARD CHARACTERS WITHOUT CLAIM TO ANY PARTICULAR FONT, STYLE, SIZE, OR COLOR.

NO CLAIM IS MADE TO THE EXCLUSIVE RIGHT TO USE "ESPRESSO BAR", APART FROM THE MARK AS SHOWN.

FOR RETAIL STORE SERVICES FEATURING COFFEE, TEA, COCOA, CHOCOLATE AND ESPRESSO BEVERAGES AND BEVERAGES MADE WITH A BASE OF COFFEE, COCOA, CHOCOLATE, ESPRESSO AND/OR MILK; SODAS AND SOFT DRINKS, JUICES; BAKED GOODS; MUFFINS, COOKIES, CAKES, PASTRIES, BREADS AND SANDWICHES (U.S. CLS. 100, 101 AND 102).

FIRST USE 7-1-2006; IN COMMERCE 7-1-2006.

3,314,341. E6688, INC., POTOMAC, MD. SN 78-812,969. PUB. 10-3-2006, FILED 2-12-2006.

POROS K DESIGNS

THE MARK CONSISTS OF STANDARD CHARACTERS WITHOUT CLAIM TO ANY PARTICULAR FONT, STYLE, SIZE, OR COLOR.

NO CLAIM IS MADE TO THE EXCLUSIVE RIGHT TO

CLASS 35—(Continued).

USE "DESIGNS", APART FROM THE MARK AS SHOWN.
THE NAME POROS K DOES NOT IDENTIFY A LIVING INDIVIDUAL.

FOR RETAIL FURNITURE STORE FEATURING HOME, CONTRACT, AND HOSPITALITY FURNITURE; ONLINE RETAIL ORDERING SERVICES FEATURING HOME, CONTRACT, AND HOSPITALITY FURNITURE (U.S. CLS. 100, 101 AND 102).

FIRST USE 3-1-2006; IN COMMERCE 3-1-2006.

CLASS 35—(Continued).

3,314,370. CARTUS CORPORATION, DANBURY, CT. SN 78-817,943. PUB. 9-26-2006, FILED 2-17-2006.

3,314,366. DOLLAR TRIP INC., ALPHARETTA, GA. SN 78-817,456. PUB. 10-10-2006, FILED 2-17-2006.

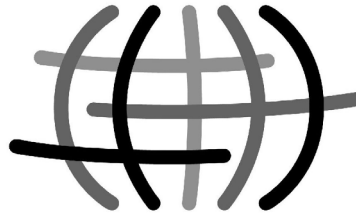

Dollar Trip

THE MARK CONSISTS OF A GLOBE MADE WITH LINES. FOR EMPLOYEE RELOCATION AND RELOCATION INFORMATION SERVICES; EMPLOYMENT COUNSELING AND EMPLOYEE OUTPLACEMENT SERVICES (U.S. CLS. 100, 101 AND 102).

FIRST USE 5-22-2006; IN COMMERCE 5-22-2006.

NO CLAIM IS MADE TO THE EXCLUSIVE RIGHT TO USE DOLLAR, APART FROM THE MARK AS SHOWN.

FOR RETAIL STORE SERVICES FEATURING GENERAL MERCHANDISE, PACKAGED FOODS, SILK FLOWERS, PARTY SUPPLIES, TOYS, GREETING CARDS, STATIONERY ITEMS, AND APPAREL, SCHOOL SUPPLIES, GENERAL HARDWARE, CLEANING SUPPLIES, CANDLES (U.S. CLS. 100, 101 AND 102).

FIRST USE 10-1-2006; IN COMMERCE 10-1-2006.

3,314,371. CARTUS CORPORATION, DANBURY, CT. SN 78-817,954. PUB. 9-26-2006, FILED 2-17-2006.

3,314,369. CARTUS CORPORATION, DANBURY, CT. SN 78-817,923. PUB. 9-26-2006, FILED 2-17-2006.



CARTUS 

THE COLOR(S) GREEN, ORANGE AND BLUE IS/ARE CLAIMED AS A FEATURE OF THE MARK.

THE MARK CONSISTS OF A GLOBE MADE WITH THREE GREEN LINES, THREE BLUE LINES AND TWO ORANGE LINES.

FOR EMPLOYEE RELOCATION AND RELOCATION INFORMATION SERVICES; EMPLOYMENT COUNSELING AND EMPLOYEE OUTPLACEMENT SERVICES (U.S. CLS. 100, 101 AND 102).

FIRST USE 5-22-2006; IN COMMERCE 5-22-2006.

FOR EMPLOYEE RELOCATION AND RELOCATION INFORMATION SERVICES; EMPLOYMENT COUNSELING AND EMPLOYEE OUTPLACEMENT SERVICES (U.S. CLS. 100, 101 AND 102).

FIRST USE 5-22-2006; IN COMMERCE 5-22-2006.

CLASS 35—(Continued).

3,314,391. SAGITTARIUS BRANDS, INC., NASHVILLE, TN. SN 78-820,672. PUB. 10-10-2006, FILED 2-22-2006.

SAGITTARIUS BRANDS

THE MARK CONSISTS OF STANDARD CHARACTERS WITHOUT CLAIM TO ANY PARTICULAR FONT, STYLE, SIZE, OR COLOR.

NO CLAIM IS MADE TO THE EXCLUSIVE RIGHT TO USE "BRANDS", APART FROM THE MARK AS SHOWN.

FOR BUSINESS MANAGEMENT AND CONSULTATION FOR RESTAURANTS AND FRANCHISE SERVICES, NAMELY, OFFERING ASSISTANCE IN THE ESTABLISHMENT AND OPERATION OF RESTAURANTS (U.S. CLS. 100, 101 AND 102).

FIRST USE 1-22-2007; IN COMMERCE 1-22-2007.

3,314,398. BILL'S GHOST & SPIRITS LLC, GUADALUPE, AZ. SN 78-821,704. PUB. 5-15-2007, FILED 2-23-2006.

BILL'S GHOST & SPIRITS

THE MARK CONSISTS OF STANDARD CHARACTERS WITHOUT CLAIM TO ANY PARTICULAR FONT, STYLE, SIZE, OR COLOR.

FOR RETAIL STORE SERVICES FEATURING CONVENIENCE STORE ITEMS AND GASOLINE (U.S. CLS. 100, 101 AND 102).

FIRST USE 6-20-2006; IN COMMERCE 6-20-2006.

3,314,412. CAPINTELLECT COMMUNICATIONS, INC., LAS VEGAS, NV. SN 78-825,692. PUB. 8-8-2006, FILED 2-28-2006.

BIG TRAFFIC

THE MARK CONSISTS OF STANDARD CHARACTERS WITHOUT CLAIM TO ANY PARTICULAR FONT, STYLE, SIZE, OR COLOR.

FOR ADVERTISING SERVICES, NAMELY, THE PLACEMENT OF ADVERTISING THROUGH THE USE OF DISPLAY PANELS AND GRAPHICS FOR USE ON VEHICLES, BILLBOARDS AND WALLS (U.S. CLS. 100, 101 AND 102).

FIRST USE 7-1-2006; IN COMMERCE 9-1-2006.

CLASS 35—(Continued).

3,314,419. DELAWARE CAPITAL FORMATION, INC., WILMINGTON, DE. SN 78-827,446. PUB. 11-14-2006, FILED 3-2-2006.



NO CLAIM IS MADE TO THE EXCLUSIVE RIGHT TO USE "BRANDS" AND "FOOD SERVICE EQUIPMENT SOLUTIONS", APART FROM THE MARK AS SHOWN.

FOR WHOLESALE DISTRIBUTORSHIP SERVICES FEATURING COMMERCIAL AND INDUSTRIAL COOKING EQUIPMENT, NAMELY, ELECTRIC AND GAS STEAM JACKETED KETTLES, ELECTRIC AND GAS POWERED STEAM JACKETED KETTLE LIDS, ELECTRIC AND GAS TILTED BRAISING PANS, ELECTRIC AND GAS CONVECTION STEAMERS, ELECTRIC AND GAS CONNECTIONLESS STEAMERS, ELECTRIC AND GAS BOILERLESS STEAMERS, COMBINATION OVENS, KITCHEN FAUCETS, STEAM PRESSURE REGULATING VALVES, PLUMBING FITTINGS, NAMELY, KITCHEN STEAM TRAPS AND STRUCTURAL COMPONENTS THEREFOR, PLUMBING FITTINGS IN THE NATURE OF KITCHEN SINK STRAINERS, WATER TREATMENT EQUIPMENT, NAMELY, CARTRIDGE FILTRATION UNITS, QUICK-DISCONNECT RUBBER GAS HOSES, STEAMER BASKETS, STEAMER BASKET INSERTS, LIP STRAINERS, DISK STRAINERS, PERFORATED STRAINERS, WIRE PAN CARRIERS, COOKWARE IN THE NATURE OF TILTED BRAISING PANS CASTORS IN THE NATURE OF CONDIMENT STANDS NOT OF PRECIOUS METALS, KITCHEN VALVE CLEANING BRUSH KITS COMPRISED PRIMARILY OF CLEANING BRUSHES (U.S. CLS. 100, 101 AND 102).

FIRST USE 1-10-2005; IN COMMERCE 1-10-2005.

3,314,426. A.M. CASTLE & CO., FRANKLIN PARK, IL. SN 78-828,562. PUB. 10-17-2006, FILED 3-3-2006.



FOR DISTRIBUTORSHIP SERVICES IN THE FIELD OF METALS (U.S. CLS. 100, 101 AND 102).

FIRST USE 2-6-2006; IN COMMERCE 3-1-2006.

CLASS 35—(Continued).

3,314,482. M & D INDUSTRIES OF LOUISIANA, INC., LAFAYETTE, LA. SN 78-846,390. PUB. 12-26-2006, FILED 3-26-2006.



NO CLAIM IS MADE TO THE EXCLUSIVE RIGHT TO USE "LOUISIANA", APART FROM THE MARK AS SHOWN. THE COLOR(S) GREEN, WHITE AND GOLD IS/ARE CLAIMED AS A FEATURE OF THE MARK.

THE MARK CONSISTS OF A GREEN FLASK WITH WHITE LINES CRISS-CROSSED, WITH GOLD ARCS JUXTAPOSED ON EACH UPRIGHT SIDE OF THE FLASK, POSITIONED ON TOP LEFT OF THE LITERAL PORTION OF THE MARK. ALL WORDING IN THE MARK IS GREEN.

FOR MARKETING SERVICES FOR CHEMICALS IN THE OIL AND GAS INDUSTRY (U.S. CLS. 100, 101 AND 102).

FIRST USE 5-1-2006; IN COMMERCE 5-1-2006.

3,314,492. KNIGHTS OF THE BAR, INC., MARIETTA, GA. SN 78-850,014. PUB. 12-12-2006, FILED 3-30-2006.

KNIGHTS OF THE BAR

THE MARK CONSISTS OF STANDARD CHARACTERS WITHOUT CLAIM TO ANY PARTICULAR FONT, STYLE, SIZE, OR COLOR.

FOR PROVIDING AN ON-LINE COMPUTER DATABASE CONSISTING OF A DIRECTORY OF LEGAL PROFESSIONALS (U.S. CLS. 100, 101 AND 102).

FIRST USE 4-2-2007; IN COMMERCE 4-20-2007.

3,314,507. LABOR FINDERS INTERNATIONAL, INC., PALM BEACH GARDENS, FL. SN 78-856,415. PUB. 11-21-2006, FILED 4-7-2006.

OUR TEAM IS BEHIND YOU

THE MARK CONSISTS OF STANDARD CHARACTERS WITHOUT CLAIM TO ANY PARTICULAR FONT, STYLE, SIZE, OR COLOR.

FOR TEMPORARY EMPLOYMENT AGENCIES (U.S. CLS. 100, 101 AND 102).

FIRST USE 5-31-2006; IN COMMERCE 8-30-2006.

CLASS 35—(Continued).

3,314,510. SAGITTARIUS BRANDS, INC., NASHVILLE, TN. SN 78-858,696. PUB. 12-12-2006, FILED 4-11-2006.



THE MARK CONSISTS OF STYLIZED STAR AND MOON. FOR BUSINESS MANAGEMENT AND CONSULTATION FOR RESTAURANTS AND FRANCHISE SERVICES, NAMELY, OFFERING ASSISTANCE IN THE ESTABLISHMENT AND OPERATION OF RESTAURANTS (U.S. CLS. 100, 101 AND 102).

FIRST USE 1-22-2007; IN COMMERCE 1-22-2007.

3,314,516. WEB GRAPHICS, INC., MILFORD, IA. SN 78-860,016. PUB. 11-21-2006, FILED 4-12-2006.

PRINT Rx

THE MARK CONSISTS OF STANDARD CHARACTERS WITHOUT CLAIM TO ANY PARTICULAR FONT, STYLE, SIZE, OR COLOR.

NO CLAIM IS MADE TO THE EXCLUSIVE RIGHT TO USE "PRINT", APART FROM THE MARK AS SHOWN.

FOR BUSINESS CONSULTING SERVICES FOR THE PRINT MARKETING INDUSTRY, NAMELY, BUSINESS CONSULTING IN THE FIELD OF INCREASING THE EFFICIENCY OF BOTH PRINT PRODUCTION AND ADVERTISING DISTRIBUTION (U.S. CLS. 100, 101 AND 102).

FIRST USE 7-10-2006; IN COMMERCE 3-2-2007.

CLASS 35—(Continued).

3,314,517. CONNECTICUT ASSOCIATION OF OPTOMETRISTS, ROCKY HILL, CT. SN 78-860,682. PUB. 3-27-2007, FILED 4-13-2006.

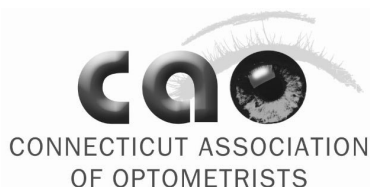

NO CLAIM IS MADE TO THE EXCLUSIVE RIGHT TO USE "CONNECTICUT ASSOCIATION OF OPTOMETRISTS", APART FROM THE MARK AS SHOWN.

THE MARK CONSISTS OF THE STYLIZED LETTERS "CAO" AND A STYLIZED DESIGN OF AN EYE, BELOW WHICH APPEARS THE WORDS "CONNECTICUT ASSOCIATION OF OPTOMETRISTS".

FOR PROMOTING THE PUBLIC AWARENESS OF THE IMPORTANCE OF EYE AND VISION CARE (U.S. CLS. 100, 101 AND 102).

FIRST USE 3-11-2006; IN COMMERCE 3-11-2006.

3,314,523. MOORE, DANIAL, COVINGTON, GA. AND MOORE, NAIMA, COVINGTON, GA. SN 78-862,416. PUB. 1-9-2007, FILED 4-16-2006.

MEGAGLOBE CARD

THE MARK CONSISTS OF STANDARD CHARACTERS WITHOUT CLAIM TO ANY PARTICULAR FONT, STYLE, SIZE, OR COLOR.

NO CLAIM IS MADE TO THE EXCLUSIVE RIGHT TO USE "CARD", APART FROM THE MARK AS SHOWN.

FOR CREDIT CARD MEMBERSHIP SERVICES, NAMELY ADMINISTRATION OF A DISCOUNT PROGRAM FOR ENABLING PARTICIPANTS TO OBTAIN DISCOUNTS ON GOODS AND SERVICES (U.S. CLS. 100, 101 AND 102).

FIRST USE 4-0-2006; IN COMMERCE 1-0-2007.

CLASS 35—(Continued).

3,314,525. GREATER MINNEAPOLIS CONVENTION & VISITORS ASSOCIATION, MINNEAPOLIS, MN. SN 78-863,181. PUB. 11-21-2006, FILED 4-17-2006.

Meet Minneapolis

THE MARK CONSISTS OF STANDARD CHARACTERS WITHOUT CLAIM TO ANY PARTICULAR FONT, STYLE, SIZE, OR COLOR.

NO CLAIM IS MADE TO THE EXCLUSIVE RIGHT TO USE "MINNEAPOLIS", APART FROM THE MARK AS SHOWN.

FOR PROMOTING BUSINESS, TOURISM, CONVENTION CENTER SERVICES, TRADE SHOWS, MEETINGS, LEISURE TRAVEL, AND EVENTS IN THE GREATER MINNEAPOLIS AREA (U.S. CLS. 100, 101 AND 102).

FIRST USE 8-1-2006; IN COMMERCE 8-1-2006.

3,314,526. ER MARKS, INC., WILMINGTON, DE. SN 78-863,404. PUB. 3-20-2007, FILED 4-18-2006.



NO CLAIM IS MADE TO THE EXCLUSIVE RIGHT TO USE "ON DEMAND", APART FROM THE MARK AS SHOWN.

THE MARK CONSISTS OF THE WORDS QVC ON DEMAND WITH THE WORD DEMAND IN A HORIZONTALLY ELONGATED RECTANGLE WITH THE LETTER "A" THEREOF COMPRISED OF A TRIANGLE MADE OF THREE VERTICAL BARS.

FOR PROVIDING HOME SHOPPING SERVICES IN THE FIELD OF GENERAL MERCHANDISE BY MEANS OF TELEVISION; RETAIL STORE SERVICES AVAILABLE THROUGH INTERACTIVE TELEVISION FEATURING GENERAL MERCHANDISE; AND RETAIL SHOPPING SERVICES IN THE FIELD OF GENERAL MERCHANDISE BY MEANS OF INTERNET, MOBILE PHONE AND PORTABLE AND HANDHELD DIGITAL AND ELECTRONIC DEVICES (U.S. CLS. 100, 101 AND 102).

FIRST USE 6-18-2006; IN COMMERCE 6-18-2006.

CLASS 35—(Continued).

3,314,529. BPAI, INC., SHELTON, CT. AND EXHIBIT SURVEYS, INC., RED BANK, NJ. SN 78-864,059. PUB. 4-3-2007, FILED 4-18-2006.



NO CLAIM IS MADE TO THE EXCLUSIVE RIGHT TO USE "EVENT", APART FROM THE MARK AS SHOWN.

THE MARK CONSISTS OF AN ARROW DESIGN POINTING TO THE WORD EVENT WITH THE WORD INSIGHTS BELOW.

FOR BUSINESS AUDITING SERVICES OF TRADE AND CONSUMER SHOW, CONFERENCE AND SEMINAR ATTENDEES; AND CONDUCTING BUSINESS RESEARCH AND SURVEYS RELATING TO TRADE AND CONSUMER SHOW, CONFERENCE AND SEMINAR ATTENDEES (U.S. CLS. 100, 101 AND 102).
FIRST USE 3-17-2006; IN COMMERCE 3-17-2006.

3,314,532. ALL HOUSE BUYERS, LLC, PHOENIX, AZ. SN 78-865,340. PUB. 12-5-2006, FILED 4-19-2006.

SELL US YOUR HOUSE

THE MARK CONSISTS OF STANDARD CHARACTERS WITHOUT CLAIM TO ANY PARTICULAR FONT, STYLE, SIZE, OR COLOR.

FOR REAL ESTATE ADVERTISING SERVICES (U.S. CLS. 100, 101 AND 102).

FIRST USE 10-6-2005; IN COMMERCE 4-13-2006.

3,314,545. COPYRIGHT CLEARANCE CENTER, INC., DANVERS, MA. SN 78-870,420. PUB. 11-28-2006, FILED 4-26-2006.

RIGHTSPHERE

THE MARK CONSISTS OF STANDARD CHARACTERS WITHOUT CLAIM TO ANY PARTICULAR FONT, STYLE, SIZE, OR COLOR.

FOR MANAGING LICENSED RIGHTS FOR USERS OF THE COPYRIGHTED WORKS OF OTHERS (U.S. CLS. 100, 101 AND 102).

FIRST USE 6-11-2006; IN COMMERCE 6-11-2006.

CLASS 35—(Continued).

3,314,593. SPIEGELHOFF'S MARKET, LLC, BURLINGTON, WI. SN 78-884,822. PUB. 2-20-2007, FILED 5-16-2006.



NO CLAIM IS MADE TO THE EXCLUSIVE RIGHT TO USE "FRESH FOOD MARKET", APART FROM THE MARK AS SHOWN.

THE MARK IS NOT IN COLOR AND THE GRAY APPEARS AS SHADING.

FOR RETAIL GROCERY SUPERMARKET SERVICES (U.S. CLS. 100, 101 AND 102).

FIRST USE 7-13-2006; IN COMMERCE 7-13-2006.

3,314,596. DOYLE, PETER, CHAPEL HILL, NC. SN 78-885,606. PUB. 2-13-2007, FILED 5-17-2006.



FOR BUSINESS SERVICES, NAMELY, AN ONLINE MULTIMEDIA SERVICE MATCHING POTENTIAL PRIVATE INVESTORS WITH INVENTORS NEEDING FUNDING (U.S. CLS. 100, 101 AND 102).

FIRST USE 3-5-2007; IN COMMERCE 3-5-2007.

3,314,603. WEBCONSULS, LLC, NEWPORT BEACH, CA. SN 78-887,348. PUB. 11-28-2006, FILED 5-18-2006.

PASSPORT TO RECOVERY

THE MARK CONSISTS OF STANDARD CHARACTERS WITHOUT CLAIM TO ANY PARTICULAR FONT, STYLE, SIZE, OR COLOR.

FOR PROVIDING ON-LINE DIRECTORY INFORMATION SERVICES ALSO FEATURING HYPERLINKS TO OTHER WEB SITES (U.S. CLS. 100, 101 AND 102).

FIRST USE 3-1-2007; IN COMMERCE 3-1-2007.

CLASS 35—(Continued).

3,314,616. FAMILY NETWORK, INC., NEW YORK, NY. SN 78-890,548. PUB. 12-26-2006, FILED 5-23-2006.

AUTOMATIC ADVANTAGES

THE MARK CONSISTS OF STANDARD CHARACTERS WITHOUT CLAIM TO ANY PARTICULAR FONT, STYLE, SIZE, OR COLOR.

FOR DEVELOPING AND OPERATING CUSTOMER AND CLIENT MEMBERSHIP, LOYALTY, DISCOUNT AND REWARD SERVICE PROGRAMS FOR OTHER COMPANIES BY MEANS OF THE INTERNET AND BY DIRECT MAILINGS; CUSTOMER LOYALTY SERVICES AND CUSTOMER CLUB SERVICES, FOR COMMERCIAL, PROMOTIONAL AND/OR ADVERTISING PURPOSES (U.S. CLS. 100, 101 AND 102).

FIRST USE 7-5-2006; IN COMMERCE 7-5-2006.

3,314,630. DOYLE, PETER, CHAPEL HILL, NC. SN 78-895,849. PUB. 2-20-2007, FILED 5-30-2006.



FOR BUSINESS SERVICES, NAMELY, AN ON-LINE MULTIMEDIA SERVICE MATCHING POTENTIAL PRIVATE INVESTORS WITH INVENTORS NEEDING FUNDING (U.S. CLS. 100, 101 AND 102).

FIRST USE 8-16-2006; IN COMMERCE 8-16-2006.

3,314,641. WINELOVERS, LLC, BOCA RATON, FL. SN 78-897,158. PUB. 2-13-2007, FILED 5-31-2006.

WINE-FRIENDLY

THE MARK CONSISTS OF STANDARD CHARACTERS WITHOUT CLAIM TO ANY PARTICULAR FONT, STYLE, SIZE, OR COLOR.

FOR ONLINE RESTAURANT RATINGS, WHERE RATING CRITERIA IS BASED ON WINE POLICIES (U.S. CLS. 100, 101 AND 102).

FIRST USE 8-25-2006; IN COMMERCE 8-25-2006.

CLASS 35—(Continued).

3,314,649. COCHRAN, R. KEITH, IRVING, TX. SN 78-898,985. PUB. 1-30-2007, FILED 6-2-2006.

TAR

THE MARK CONSISTS OF STANDARD CHARACTERS WITHOUT CLAIM TO ANY PARTICULAR FONT, STYLE, SIZE, OR COLOR.

FOR BUSINESS AUDITING SERVICES, NAMELY FORENSIC AUDITING UTILIZING ELECTRONIC AND MANUAL METHODOLOGIES TO RECTIFY ERRONEOUS ACCOUNTING TRANSACTIONS MADE IN COMPLIANCE WITH GAAP (U.S. CLS. 100, 101 AND 102).

FIRST USE 10-1-2006; IN COMMERCE 10-1-2006.

3,314,677. RUSS WHITE & ASSOCIATES, L.L.C., DBA RWA FLOORING SOLUTIONS, GRAPEVINE, TX. SN 78-904,873. PUB. 2-20-2007, FILED 6-9-2006.

YOU CAN STAND ON OUR PERFORMANCE

THE MARK CONSISTS OF STANDARD CHARACTERS WITHOUT CLAIM TO ANY PARTICULAR FONT, STYLE, SIZE, OR COLOR.

FOR RETAIL STORE SERVICES FEATURING FLOORING (U.S. CLS. 100, 101 AND 102).

FIRST USE 5-31-2006; IN COMMERCE 5-31-2006.

3,314,730. ICF INTERNATIONAL, INC., FAIRFAX, VA. SN 78-919,228. PUB. 5-1-2007, FILED 6-28-2006.

RESPIRE

THE MARK CONSISTS OF STANDARD CHARACTERS WITHOUT CLAIM TO ANY PARTICULAR FONT, STYLE, SIZE, OR COLOR.

FOR BUSINESS CONSULTING SERVICES IN THE FIELD OF PRIORITIZING AND SELECTING BETWEEN ALTERNATIVE PROJECTS, METHODS AND TECHNIQUES FOR REDUCING ENERGY CONSUMPTION AND CARBON EMISSIONS, EMPLOYING QUANTITIES NAMELY, PROJECT RISK, OUTCOME RISK, BRAND VALUE AND FINANCIAL RETURN (U.S. CLS. 100, 101 AND 102).

FIRST USE 5-10-2006; IN COMMERCE 5-10-2006.

CLASS 35—(Continued).

3,314,736. THE FOLEY GROUP, MINNEAPOLIS, MN. SN 78-923,756. PUB. 3-6-2007, FILED 7-6-2006.

LEVEL

THE MARK CONSISTS OF STANDARD CHARACTERS WITHOUT CLAIM TO ANY PARTICULAR FONT, STYLE, SIZE, OR COLOR.

FOR ADVERTISING SERVICES, NAMELY, CREATING CORPORATE AND BRAND IDENTITY FOR OTHERS; BUSINESS MARKETING CONSULTING SERVICES; MARKET RESEARCH FOR OTHERS; MARKET RESEARCH SERVICES; PROMOTING THE GOODS AND SERVICES OF OTHERS THROUGH THE CREATION AND DISTRIBUTION OF PRINTED, ELECTRONIC, AUDIO AND VISUAL MATERIAL AND INCENTIVE PROGRAMS; BUSINESS CONSULTING SERVICES, NAMELY, MATERIAL AND INCENTIVE PROGRAMS; BUSINESS CONSULTING SERVICES, NAMELY, CONSULTING AND ADVISING MANAGEMENT AND OTHER EMPLOYEES, IN THE NATURE OF BUSINESS PLANNING, ORGANIZATIONAL, PROCESS AND STRATEGIC PLANNING, ADVERTISING SUPPORT, MARKETING, TEAM BUILDING, QUALITY MANAGEMENT, PERFORMANCE ANALYSIS, BUSINESS PROCESS REENGINEERING AND DEVELOPMENT; BUSINESS RESEARCH AND SURVEYS; AND PUBLIC RELATIONS AND REPUTATION MANAGEMENT FOR BUSINESSES (U.S. CLS. 100, 101 AND 102).
FIRST USE 1-20-2006; IN COMMERCE 1-20-2006.

3,314,737. MAUMEE PLUMBING & HEATING SUPPLY, INC., PERRYSBURG, OH. SN 78-924,214. PUB. 5-29-2007, FILED 7-7-2006.

Waterhouse
bath & kitchen studio

NO CLAIM IS MADE TO THE EXCLUSIVE RIGHT TO USE "BATH & KITCHEN STUDIO", APART FROM THE MARK AS SHOWN.

THE COLOR(S) GRAY, BLUE AND BLACK IS/ARE CLAIMED AS A FEATURE OF THE MARK.

THE WORD WATER IS GRAY; THE WORD HOUSE AND THE WORDING BATH & KITCHEN STUDIO ARE BLACK; THE NUMBER 2 IS BLUE.

FOR RETAIL STORE SERVICES FEATURING KITCHEN AND BATH FIXTURES OF OTHERS (U.S. CLS. 100, 101 AND 102).

FIRST USE 4-10-2007; IN COMMERCE 5-11-2007.

CLASS 35—(Continued).

3,314,749. DEUTCH, RONI LYNN, NORTH HIGHLANDS, DE. SN 78-925,563. PUB. 2-27-2007, FILED 7-10-2006.

Roni Deutch

THE MARK CONSISTS OF STANDARD CHARACTERS WITHOUT CLAIM TO ANY PARTICULAR FONT, STYLE, SIZE, OR COLOR.

FOR INCOME TAX CONSULTATION; INCOME TAX PREPARATION; TAX ADVISORY SERVICES; TAX AND TAXATION PLANNING, ADVICE, INFORMATION AND CONSULTANCY SERVICES; TAX CONSULTATION; TAX FILING SERVICES; TAX PREPARATION (U.S. CLS. 100, 101 AND 102).

FIRST USE 1-2-2007; IN COMMERCE 1-2-2007.

3,314,751. ONAIRFUNDRAISING, LLC, ROSEVILLE, MN. SN 78-926,520. PUB. 2-20-2007, FILED 7-11-2006.

ONAIRFUNDRAISING

THE MARK CONSISTS OF STANDARD CHARACTERS WITHOUT CLAIM TO ANY PARTICULAR FONT, STYLE, SIZE, OR COLOR.

FOR BUSINESS CONSULTATION SERVICES IN CONNECTION WITH PLANNING, MANAGING, AND CONDUCTING FUNDRAISING ACTIVITIES (U.S. CLS. 100, 101 AND 102).

FIRST USE 7-27-2006; IN COMMERCE 7-27-2006.

3,314,763. CARE LEVEL MANAGEMENT GROUP, LLC, WOODLAND HILLS, CA. SN 78-933,406. PUB. 1-23-2007, FILED 7-19-2006.

PVP

THE MARK CONSISTS OF STANDARD CHARACTERS WITHOUT CLAIM TO ANY PARTICULAR FONT, STYLE, SIZE, OR COLOR.

FOR MEDICAL COST MANAGEMENT (U.S. CLS. 100, 101 AND 102).

FIRST USE 1-1-2007; IN COMMERCE 1-1-2007.

CLASS 35—(Continued).

3,314,767. WF ALLIANCE CORPORATION, ST. LOUIS, MO.
SN 78-933,703. PUB. 2-13-2007, FILED 7-20-2006.

THE RIGHT PRODUCT AT THE
RIGHT PRICE

THE MARK CONSISTS OF STANDARD CHARACTERS
WITHOUT CLAIM TO ANY PARTICULAR FONT, STYLE,
SIZE, OR COLOR.

FOR DISTRIBUTORSHIPS IN THE FIELD OF FURNI-
TURE; WHOLESALE DISTRIBUTORSHIPS FEATURING
FURNITURE; RETAIL DISTRIBUTORSHIPS FEATUR-
ING FURNITURE (U.S. CLS. 100, 101 AND 102).
FIRST USE 8-15-2006; IN COMMERCE 8-15-2006.

3,314,769. IT'S HIP TO BE ROUND, INC., RICHMOND, VA.
SN 78-934,744. PUB. 3-6-2007, FILED 7-21-2006.

IT'S HIP TO BE ROUND

THE MARK CONSISTS OF STANDARD CHARACTERS
WITHOUT CLAIM TO ANY PARTICULAR FONT, STYLE,
SIZE, OR COLOR.

FOR RETAIL STORE SERVICES FEATURING MA-
TERNITY AND NURSING CLOTHING FOR WOMEN,
CLOTHING FOR BABIES AND CHILDREN, MATER-
NITY-RELATED AND BABY-RELATED ACCESSORIES,
AND STROLLERS; ONLINE RETAIL STORE SERVICES
FEATURING MATERNITY AND NURSING CLOTHING
FOR WOMEN, CLOTHING FOR BABIES AND CHIL-
DREN, MATERNITY-RELATED AND BABY-RELATED
ACCESSORIES, AND STROLLERS (U.S. CLS. 100, 101
AND 102).

FIRST USE 11-2-2006; IN COMMERCE 1-31-2007.

CLASS 35—(Continued).

3,314,773. BUCHER, TODD J, CLEVELS, OH. SN 78-935,422.
PUB. 3-6-2007, FILED 7-22-2006.



THE COLOR(S) GREEN AND BLACK IS/ARE CLAIMED
AS A FEATURE OF THE MARK.

THE MARK CONSISTS OF THE BLACK LETTERED
WORDS "NO WORRIES" WITH THE "W" HAVING A CROSS
ATTACHED TO THE UPPER RIGHT SLASH. UNDER-
NEATH THE "NO WORRIES" IS A GREEN CIRCLE WITH
A SEMI-WAVY ARROW POINTING TO THE RIGHT..

FOR ASSOCIATION SERVICES, NAMELY, PROMOT-
ING THE INTERESTS OF CHRISTIANS; PRODUCT
MERCHANDISING (U.S. CLS. 100, 101 AND 102).

FIRST USE 6-19-2007; IN COMMERCE 6-19-2007.

3,314,804. TRAJAH, INC., BUFFALO GROVE, IL. SN 78-
946,943. PUB. 4-24-2007, FILED 8-8-2006.

TRAJAH

THE MARK CONSISTS OF STANDARD CHARACTERS
WITHOUT CLAIM TO ANY PARTICULAR FONT, STYLE,
SIZE, OR COLOR.

FOR ONLINE EXCHANGE SERVICES, NAMELY BAR-
TERING OF GOODS AND SERVICES FOR OTHERS;
PROVIDING AN ON-LINE SEARCHABLE DATABASE
FEATURING CLASSIFIED AD LISTINGS (U.S. CLS. 100,
101 AND 102).

FIRST USE 5-24-2007; IN COMMERCE 5-24-2007.

CLASS 35—(Continued).

3,314,806. LEWIS, OWEN M. CWMBRAN, UNITED KINGDOM. SN 78-947,321. PUB. 3-20-2007, FILED 8-8-2006.

Whose Time?

THE MARK CONSISTS OF STANDARD CHARACTERS WITHOUT CLAIM TO ANY PARTICULAR FONT, STYLE, SIZE, OR COLOR.

FOR ADVERTISING AND COMMERCIAL INFORMATION SERVICES, VIA THE INTERNET; ADVERTISING VIA ELECTRONIC MEDIA AND SPECIFICALLY THE INTERNET; DISSEMINATION OF ADVERTISING FOR OTHERS VIA THE INTERNET; PROVIDING A SEARCHABLE ONLINE ADVERTISING GUIDE FEATURING THE GOODS AND SERVICES OF OTHER ONLINE VENDORS ON THE INTERNET; PROVIDING AND RENTAL OF ADVERTISING SPACE ON THE INTERNET (U.S. CLS. 100, 101 AND 102).

FIRST USE 1-8-2007; IN COMMERCE 5-1-2007.

3,314,816. CHAN LUU INC., LOS ANGELES, CA. SN 78-950,793. PUB. 4-3-2007, FILED 8-11-2006.

CHAN LUU

THE MARK CONSISTS OF STANDARD CHARACTERS WITHOUT CLAIM TO ANY PARTICULAR FONT, STYLE, SIZE, OR COLOR.

OWNER OF U.S. REG. NOS. 2,869,029 AND 3,028,982. THE NAME(S), PORTRAIT(S), AND/OR SIGNATURE(S) SHOWN IN THE MARK IDENTIFIES A LIVING INDIVIDUAL, WHOSE CONSENT(S) TO REGISTER IS SUBMITTED.

FOR ONLINE RETAIL STORE SERVICES IN THE FIELD OF JEWELRY AND OTHER FASHION ACCESSORIES (U.S. CLS. 100, 101 AND 102).

FIRST USE 12-4-2006; IN COMMERCE 12-4-2006.

3,314,845. BLATT, STEPHEN, WAYNESVILLE, NC. SN 78-958,215. PUB. 4-24-2007, FILED 8-23-2006.

DOCLOC

THE MARK CONSISTS OF STANDARD CHARACTERS WITHOUT CLAIM TO ANY PARTICULAR FONT, STYLE, SIZE, OR COLOR.

FOR TEMPORARY PHYSICIAN PLACEMENT SERVICES (U.S. CLS. 100, 101 AND 102).

FIRST USE 9-23-2006; IN COMMERCE 9-23-2006.

CLASS 35—(Continued).

3,314,850. HOT DISH ADVERTISING, LLC, MINNEAPOLIS, MN. SN 78-959,506. PUB. 4-24-2007, FILED 8-24-2006.

Franfocused

THE MARK CONSISTS OF STANDARD CHARACTERS WITHOUT CLAIM TO ANY PARTICULAR FONT, STYLE, SIZE, OR COLOR.

FOR ADVERTISING AGENCIES; ADVERTISING AGENCIES, NAMELY, PROMOTING THE SERVICES OF THE FRANCHISING INDUSTRY THROUGH THE DISTRIBUTION OF PRINTED AND AUDIO PROMOTIONAL MATERIALS AND BY RENDERING SALES PROMOTION ADVICE; ADVERTISING AND COMMERCIAL INFORMATION SERVICES, VIA THE INTERNET; ADVERTISING AND MARKETING; ADVERTISING CONSULTATION; ADVERTISING SERVICES; ADVERTISING THROUGH ALL PUBLIC COMMUNICATION MEANS; ADVERTISING VIA ELECTRONIC MEDIA AND SPECIFICALLY THE INTERNET; ADVERTISING, MARKETING AND PROMOTION SERVICES (U.S. CLS. 100, 101 AND 102).

FIRST USE 9-1-2006; IN COMMERCE 9-1-2006.

3,314,864. KENSINGTON NANNY DEVELOPMENT, ORANGE PARK, FL. SN 78-964,316. PUB. 4-24-2007, FILED 8-30-2006.

KENSINGTON NANNY & HOME SERVICES

THE MARK CONSISTS OF STANDARD CHARACTERS WITHOUT CLAIM TO ANY PARTICULAR FONT, STYLE, SIZE, OR COLOR.

NO CLAIM IS MADE TO THE EXCLUSIVE RIGHT TO USE "NANNY & HOME SERVICES", APART FROM THE MARK AS SHOWN.

FOR EMPLOYMENT HIRING, RECRUITING, PLACEMENT, STAFFING AND CAREER NETWORKING SERVICES (U.S. CLS. 100, 101 AND 102).

FIRST USE 10-15-2004; IN COMMERCE 11-1-2006.

CLASS 35—(Continued).

3,314,879. ABUNGA.COM, KNOXVILLE, TN. SN 78-968,025. PUB. 4-24-2007, FILED 9-6-2006.

ABUNGA.COM

THE MARK CONSISTS OF STANDARD CHARACTERS WITHOUT CLAIM TO ANY PARTICULAR FONT, STYLE, SIZE, OR COLOR.

FOR ON-LINE RETAIL STORE SERVICES FEATURING FAMILY-FRIENDLY BOOKS, COMPACT DISCS, PRINTED MATTERS, GAMES, ELECTRONIC PUBLICATIONS, MERCHANDISE AND CONSUMER GOODS; ON-LINE MAIL ORDER SERVICES FEATURING FAMILY-FRIENDLY BOOKS, COMPACT DISCS, PRINTED MATTERS, GAMES, ELECTRONIC PUBLICATIONS, MERCHANDISE AND CONSUMER GOODS; DISTRIBUTORSHIP SERVICES FEATURING FAMILY-FRIENDLY BOOKS, COMPACT DISCS, PRINTED MATTERS, GAMES, ELECTRONIC PUBLICATIONS, MERCHANDISE AND CONSUMER GOODS; PROMOTION OF FAMILY-FRIENDLY GOODS AND SERVICES OF OTHERS (U.S. CLS. 100, 101 AND 102).

FIRST USE 4-1-2006; IN COMMERCE 4-30-2007.

3,314,881. KENTUCKY SCHOOL PLANT MANAGEMENT ASSOCIATION, LEXINGTON, KY. SN 78-968,931. PUB. 4-24-2007, FILED 9-7-2006.

"Caretakers of the Educational Environment"

THE MARK CONSISTS OF STANDARD CHARACTERS WITHOUT CLAIM TO ANY PARTICULAR FONT, STYLE, SIZE, OR COLOR.

FOR ASSOCIATION SERVICES, NAMELY, PROMOTING THE INTERESTS OF NON-PROFIT EDUCATION (U.S. CLS. 100, 101 AND 102).

FIRST USE 7-20-2007; IN COMMERCE 7-20-2007.

CLASS 35—(Continued).

3,314,883. CITIQUEST.COM, LLC, INDIANAPOLIS, IN. SN 78-969,621. PUB. 4-24-2007, FILED 9-7-2006.

CitiQuest

THE MARK CONSISTS OF STANDARD CHARACTERS WITHOUT CLAIM TO ANY PARTICULAR FONT, STYLE, SIZE, OR COLOR.

FOR PROVIDING A WEB SITE THAT ENABLES USERS TO POST ITEMS FOR SALE THROUGH ON-LINE CLASSIFIED ADVERTISEMENTS; PROVIDING AN ON-LINE SEARCHABLE DATABASE FEATURING CLASSIFIED AD LISTINGS AND EMPLOYMENT OPPORTUNITIES (U.S. CLS. 100, 101 AND 102).

FIRST USE 6-1-2007; IN COMMERCE 6-1-2007.

3,314,893. EBSCO INDUSTRIES, INC., BIRMINGHAM, AL. SN 78-972,559. PUB. 4-3-2007, FILED 9-12-2006.

PUBLINX

THE MARK CONSISTS OF STANDARD CHARACTERS WITHOUT CLAIM TO ANY PARTICULAR FONT, STYLE, SIZE, OR COLOR.

FOR PROVIDING A WEB SITE PORTAL WHERE PUBLISHERS CAN CHECK NEW AND RENEWAL SUBSCRIPTION ORDER STATUS FOR THEIR TITLES. SEND AND RETRIEVE VITAL JOURNAL MANAGEMENT DATA ELECTRONICALLY, RECEIVE PERTINENT ORDER PAYMENT RECORDS, ANALYZE AND BUILD CUSTOMIZED REPORTS FOR ALL OF THEIR SUBSCRIPTION DATA, AND MANAGE THEIR CLAIMS RESPONSE PROCESSES (U.S. CLS. 100, 101 AND 102).

FIRST USE 12-6-2006; IN COMMERCE 1-1-2007.

CLASS 36—INSURANCE AND FINANCIAL

3,312,999. APPLICATION NETWORKS, INC., PALO ALTO, CA. SN 76-361,647. PUB. 1-13-2004, FILED 1-23-2002.

APPLICATION NETWORKS

FOR FINANCIAL ADVISORY SERVICES FOR LARGE FINANCIAL INSTITUTIONS TO ACCOUNT FOR, AND MANAGE, THEIR FINANCIAL ASSETS, NAMELY, FOR THE DEVELOPMENT OF RISK MANAGEMENT AND TRADING SYSTEMS (U.S. CLS. 100, 101 AND 102).

FIRST USE 1-1-1999; IN COMMERCE 12-1-2006.

CLASS 36—(Continued).

3,313,048. MIDLAND STATES BANCORP, INC., EFFINGHAM, IL. SN 76-575,321. PUB. 12-19-2006, FILED 2-12-2004.



NO CLAIM IS MADE TO THE EXCLUSIVE RIGHT TO USE "BANK", APART FROM THE MARK AS SHOWN.

FOR BANKING SERVICES, NAMELY, SAVINGS ACCOUNT SERVICES, CHECKING ACCOUNT SERVICES, TRUST ACCOUNT SERVICES, ATM SERVICES AND DEBIT CARD SERVICES (U.S. CLS. 100, 101 AND 102).

FIRST USE 6-0-2005; IN COMMERCE 6-0-2005.

3,313,118. TEEL ENTERPRISES, INC, DALLAS, TX. SN 76-635,373. PUB. 8-22-2006, FILED 4-6-2005.

STRATVISOR

THE MARK CONSISTS OF STANDARD CHARACTERS WITHOUT CLAIM TO ANY PARTICULAR FONT, STYLE, SIZE, OR COLOR.

FOR REAL ESTATE SERVICES, NAMELY, REAL ESTATE ACQUISITION SERVICES, REAL ESTATE DEVELOPMENT, REAL ESTATE BROKERAGE AND REAL ESTATE CONSULTATION (U.S. CLS. 100, 101 AND 102).

FIRST USE 2-2-2006; IN COMMERCE 2-2-2006.

3,313,129. DIVERSIFIED INVESTMENT ADVISORS, INC., PURCHASE, NY. SN 76-637,326. PUB. 2-14-2006, FILED 4-28-2005.

GET COMFORTABLE WITH YOUR RETIREMENT PLAN

THE MARK CONSISTS OF STANDARD CHARACTERS WITHOUT CLAIM TO ANY PARTICULAR FONT, STYLE, SIZE, OR COLOR.

FOR INVESTMENT MANAGEMENT AND ADMINISTRATION OF DEFINED CONTRIBUTION PLANS, NAMELY, 401(K) AND 403(B) AND DEFINED BENEFIT PLANS (U.S. CLS. 100, 101 AND 102).

FIRST USE 7-31-2006; IN COMMERCE 7-31-2006.

CLASS 36—(Continued).

3,313,156. ALLIANCE BANK, BROOMALL, PA. SN 76-644,171. PUB. 11-21-2006, FILED 8-1-2005.

Customer First

THE MARK CONSISTS OF STANDARD CHARACTERS WITHOUT CLAIM TO ANY PARTICULAR FONT, STYLE, SIZE, OR COLOR.

FOR SERVICES CUSTOMARY IN THE BANKING INDUSTRY, NAMELY, BANKING, BANKING CONSULTATION, INVESTMENT BANKING SERVICES, MORTGAGE AND PERSONAL BANKING SERVICES, NAMELY, ORIGINATION, ACQUISITION SERVICING, SECURITIZATION, AND BROKERAGE OF COMMERCIAL AND PERSONAL MORTGAGE LOANS AND ONLINE BANKING SERVICES (U.S. CLS. 100, 101 AND 102).

FIRST USE 3-31-2006; IN COMMERCE 3-31-2006.

3,313,159. ALI, CHI, HALLANDALE, FL. SN 76-645,098. PUB. 5-9-2006, FILED 8-17-2005.

CHI ALI

THE MARK CONSISTS OF STANDARD CHARACTERS WITHOUT CLAIM TO ANY PARTICULAR FONT, STYLE, SIZE, OR COLOR.

FOR REAL ESTATE ACQUISITION AND INVESTMENT SERVICES (U.S. CLS. 100, 101 AND 102).

FIRST USE 7-15-2006; IN COMMERCE 7-15-2006.

3,313,162. PROPERTY PROFESSIONALS, INC., BOCA RATON, FL. SN 76-645,318. PUB. 7-25-2006, FILED 8-22-2005.

 The logo for Property Professionals features a circular icon containing a stylized house with a roof. Below the icon, the words "Property Professionals" are written in a serif font. Underneath that, the slogan "The Name Says It All" is written in a cursive script.

Property Professionals
"The Name Says It All"

NO CLAIM IS MADE TO THE EXCLUSIVE RIGHT TO USE "PROPERTY PROFESSIONALS", APART FROM THE MARK AS SHOWN.

FOR REAL ESTATE BROKERAGE SERVICES (U.S. CLS. 100, 101 AND 102).

FIRST USE 3-1-2005; IN COMMERCE 3-1-2005.

CLASS 36—(Continued).

3,313,164. MERRILL LYNCH & CO., INC., NEW YORK, NY.
SN 76-646,397. PUB. 6-6-2006, FILED 9-7-2005.

EZ NOTES

THE MARK CONSISTS OF STANDARD CHARACTERS WITHOUT CLAIM TO ANY PARTICULAR FONT, STYLE, SIZE, OR COLOR.

NO CLAIM IS MADE TO THE EXCLUSIVE RIGHT TO USE "NOTES", APART FROM THE MARK AS SHOWN.

FOR FINANCIAL SERVICES, NAMELY, THE ISSUANCE OF ENHANCED ZERO COUPON BOND INSTRUMENTS (U.S. CLS. 100, 101 AND 102).

FIRST USE 11-28-2005; IN COMMERCE 11-28-2005.

3,313,180. T. ROWE PRICE GROUP, INC., BALTIMORE, MD.
SN 76-651,825. PUB. 8-22-2006, FILED 12-13-2005.

PLAN METER

THE MARK CONSISTS OF STANDARD CHARACTERS WITHOUT CLAIM TO ANY PARTICULAR FONT, STYLE, SIZE, OR COLOR.

NO CLAIM IS MADE TO THE EXCLUSIVE RIGHT TO USE "PLAN", APART FROM THE MARK AS SHOWN.

FOR PROVIDING CUSTOM FINANCIAL ANALYSIS FOR RETIREMENT PLAN SPONSORS IN THE FIELD OF RETIREMENT PLAN ADMINISTRATION PRESENTED IN PRINTED FORM (U.S. CLS. 100, 101 AND 102).

FIRST USE 3-0-2006; IN COMMERCE 3-0-2006.

3,313,185. FBL FINANCIAL GROUP, INC., WEST DES MOINES, IA. SN 76-652,710. PUB. 8-29-2006, FILED 1-3-2006.

CERTAINTY SELECT

THE MARK CONSISTS OF STANDARD CHARACTERS WITHOUT CLAIM TO ANY PARTICULAR FONT, STYLE, SIZE, OR COLOR.

FOR FINANCIAL SERVICES, NAMELY, MANAGEMENT AND DISTRIBUTION OF MULTI-YEAR GUARANTEED FIXED ANNUITIES (U.S. CLS. 100, 101 AND 102).

FIRST USE 3-30-2007; IN COMMERCE 3-30-2007.

CLASS 36—(Continued).

3,313,196. MARCH COMMUNITY CREDIT UNION, MORENO VALLEY, CA. SN 76-656,371. PUB. 3-13-2007, FILED 3-8-2006.

VISTERRA

credit union

NO CLAIM IS MADE TO THE EXCLUSIVE RIGHT TO USE "CREDIT UNION", APART FROM THE MARK AS SHOWN.

THE COLOR(S) TEAL AND TERRACOTTA (REDDISH-BROWN) IS/ARE CLAIMED AS A FEATURE OF THE MARK.

THE MARK CONSISTS OF THE STYLIZED WORDS VISTERRA CREDIT UNION. THE COLOR TEAL APPEARS IN THE WORD VISTERRA, WHICH IS LOCATED ABOVE THE WORDS CREDIT UNION. THE COLOR TERRACOTTA (REDDISH-BROWN) APPEARS IN THE WORDS CREDIT UNION, WHICH IS LOCATED BELOW THE WORD VISTERRA.

FOR CREDIT UNION SERVICES; CONSUMER AND COMMERCIAL LENDING SERVICES; DEPOSIT ACCOUNT SERVICES IN THE NATURE OF CHECKING ACCOUNTS AND ADMINISTRATION OF SAVINGS ACCOUNTS; CREDIT UNION SERVICES, NAMELY, CERTIFICATES OF DEPOSIT (U.S. CLS. 100, 101 AND 102).

FIRST USE 3-6-2006; IN COMMERCE 3-6-2006.

3,313,199. FROM A TO B INVESTMENTS, ANCHORAGE, AK. SN 76-657,750. PUB. 12-26-2006, FILED 4-3-2006.

FROM A TO B INVESTMENTS

THE MARK CONSISTS OF STANDARD CHARACTERS WITHOUT CLAIM TO ANY PARTICULAR FONT, STYLE, SIZE, OR COLOR.

NO CLAIM IS MADE TO THE EXCLUSIVE RIGHT TO USE INVESTMENTS, APART FROM THE MARK AS SHOWN.

FOR REAL ESTATE INVESTMENTS (U.S. CLS. 100, 101 AND 102).

FIRST USE 1-1-2006; IN COMMERCE 1-1-2006.

3,313,205. CROSS COUNTRY HOME SERVICES, INC., FT. LAUDERDALE, FL. SN 76-659,366. PUB. 12-12-2006, FILED 5-1-2006.

OUTSIDE GAS LINEPROTECT

THE MARK CONSISTS OF STANDARD CHARACTERS WITHOUT CLAIM TO ANY PARTICULAR FONT, STYLE, SIZE, OR COLOR.

CLASS 36—(Continued).

OWNER OF U.S. REG. NOS. 2,265,347, 2,750,666, AND OTHERS.

NO CLAIM IS MADE TO THE EXCLUSIVE RIGHT TO USE "OUTSIDE GAS", APART FROM THE MARK AS SHOWN.

FOR PROVIDING EXTENDED WARRANTY OR SERVICE CONTRACTS IN THE FIELD OF NATURAL GAS SERVICE CONDUITS (U.S. CLS. 100, 101 AND 102).

FIRST USE 2-15-2007; IN COMMERCE 2-15-2007.

CLASS 36—(Continued).

3,313,232. MERRILL LYNCH & CO., INC., NEW YORK, NY. SN 76-666,763. PUB. 2-6-2007, FILED 9-28-2006.

FAS-TRAK(r)

THE MARK CONSISTS OF STANDARD CHARACTERS WITHOUT CLAIM TO ANY PARTICULAR FONT, STYLE, SIZE, OR COLOR.

FOR FINANCIAL SERVICES, NAMELY THE OFFERING OF FINANCIAL REPORTING SERVICES TO EMPLOYEE BENEFITS PROGRAM ADMINISTRATORS REGARDING ACCOUNTING STANDARDS COMPLIANCE FOR EQUITY COMPENSATION (U.S. CLS. 100, 101 AND 102).

FIRST USE 9-0-2006; IN COMMERCE 9-0-2006.

3,313,206. CROSS COUNTRY HOME SERVICES, INC., FT. LAUDERDALE, FL. SN 76-659,367. PUB. 12-12-2006, FILED 5-1-2006.

INSIDE ELECTRIC LINEPROTECT

THE MARK CONSISTS OF STANDARD CHARACTERS WITHOUT CLAIM TO ANY PARTICULAR FONT, STYLE, SIZE, OR COLOR.

OWNER OF U.S. REG. NOS. 2,265,347, 2,750,666, AND OTHERS.

NO CLAIM IS MADE TO THE EXCLUSIVE RIGHT TO USE "INSIDE ELECTRIC", APART FROM THE MARK AS SHOWN.

FOR PROVIDING EXTENDED WARRANTY OR SERVICE CONTRACTS IN THE FIELD OF ELECTRIC SERVICE CONDUITS (U.S. CLS. 100, 101 AND 102).

FIRST USE 2-15-2007; IN COMMERCE 2-15-2007.

3,313,244. HIGHWAY 12 VENTURES II, INC., BOISE, ID. SN 77-002,251. PUB. 4-17-2007, FILED 9-19-2006.



3,313,207. CROSS COUNTRY HOME SERVICES, INC., FT. LAUDERDALE, FL. SN 76-659,368. PUB. 12-12-2006, FILED 5-1-2006.

INSIDE GAS LINEPROTECT

THE MARK CONSISTS OF STANDARD CHARACTERS WITHOUT CLAIM TO ANY PARTICULAR FONT, STYLE, SIZE, OR COLOR.

OWNER OF U.S. REG. NOS. 2,265,347, 2,750,666, AND OTHERS.

NO CLAIM IS MADE TO THE EXCLUSIVE RIGHT TO USE "INSIDE GAS", APART FROM THE MARK AS SHOWN.

FOR PROVIDING EXTENDED WARRANTY OR SERVICE CONTRACTS IN THE FIELD OF NATURAL GAS SERVICE CONDUITS (U.S. CLS. 100, 101 AND 102).

FIRST USE 2-15-2007; IN COMMERCE 2-15-2007.

NO CLAIM IS MADE TO THE EXCLUSIVE RIGHT TO USE "VENTURES", APART FROM THE MARK AS SHOWN. THE MARK CONSISTS OF AN IMAGE OF A SIGN WITH HIGHWAY 12 VENTURES.

FOR FINANCIAL AND INVESTMENT SERVICES, NAMELY, INVESTMENT AND MANAGEMENT SERVICES RELATED TO THE OPERATION OF VENTURE CAPITAL FUNDS; MANAGING VENTURE CAPITAL FUNDS FOR OTHERS; VENTURE CAPITAL SERVICES, NAMELY, PROVIDING VENTURE CAPITAL FOR ESTABLISHMENT, OPERATION AND EXPANSION OF EMERGING TECHNOLOGY COMPANIES; AND VENTURE CAPITAL FINANCING SERVICES (U.S. CLS. 100, 101 AND 102).

FIRST USE 2-1-2007; IN COMMERCE 2-1-2007.

CLASS 36—(Continued).

3,313,245. HANDHELD POWER, LLC, NAPERVILLE, IL. SN 77-002,664. PUB. 5-15-2007, FILED 9-19-2006.

CLASS 36—(Continued).

3,313,253. ALLIANCE TRADING, INC., COVINGTON, LA. SN 77-005,565. PUB. 3-27-2007, FILED 9-22-2006.

RATEPLUG

THE MARK CONSISTS OF STANDARD CHARACTERS WITHOUT CLAIM TO ANY PARTICULAR FONT, STYLE, SIZE, OR COLOR.

FOR PROVIDING MORTGAGE LENDING INFORMATION TO REAL ESTATE BROKERS AND AGENTS, LENDERS, AND HOMEBUYERS VIA THE INTERNET (U.S. CLS. 100, 101 AND 102).

FIRST USE 3-0-2005; IN COMMERCE 3-0-2005.

POOLCROP FINANCIAL

THE MARK CONSISTS OF STANDARD CHARACTERS WITHOUT CLAIM TO ANY PARTICULAR FONT, STYLE, SIZE, OR COLOR.

NO CLAIM IS MADE TO THE EXCLUSIVE RIGHT TO USE "FINANCIAL", APART FROM THE MARK AS SHOWN.

FOR MORTGAGE BROKERAGE SERVICES (U.S. CLS. 100, 101 AND 102).

FIRST USE 11-20-2006; IN COMMERCE 11-20-2006.

3,313,247. RYAN HILL REALTY, LLC, NAPERVILLE, IL. SN 77-003,523. PUB. 5-1-2007, FILED 9-20-2006.

OWN YOUR ROOF

THE MARK CONSISTS OF STANDARD CHARACTERS WITHOUT CLAIM TO ANY PARTICULAR FONT, STYLE, SIZE, OR COLOR.

FOR REAL ESTATE BROKERAGE SERVICES; LEASING OF RESIDENTIAL AND COMMERCIAL REAL ESTATE; AND RESIDENTIAL AND COMMERCIAL REAL ESTATE MANAGEMENT (U.S. CLS. 100, 101 AND 102).

FIRST USE 5-0-2006; IN COMMERCE 5-0-2006.

3,313,291. AMERICAN EXPRESS MARKETING & DEVELOPMENT CORP., NEW YORK, NY. SN 77-021,880. PUB. 5-22-2007, FILED 10-16-2006.



3,313,249. MILITARY BENEFIT ASSOCIATION, INC., CHANTILLY, VA. SN 77-003,964. PUB. 4-3-2007, FILED 9-21-2006.

NEXGEN

THE MARK CONSISTS OF STANDARD CHARACTERS WITHOUT CLAIM TO ANY PARTICULAR FONT, STYLE, SIZE, OR COLOR.

FOR INSURANCE SERVICES, NAMELY, UNDERWRITING, ISSUING AND ADMINISTRATION OF LIFE INSURANCE (U.S. CLS. 100, 101 AND 102).

FIRST USE 6-5-2007; IN COMMERCE 6-5-2007.

FOR CREDIT CARD SERVICES (U.S. CLS. 100, 101 AND 102).

FIRST USE 9-1-2006; IN COMMERCE 9-1-2006.

CLASS 36—(Continued).

3,313,300. PROTECTIVE LIFE INSURANCE COMPANY, BIRMINGHAM, AL. SN 77-026,973. PUB. 3-13-2007, FILED 10-23-2006.

PROTECTIVE HERITAGEGUARD
SPWL

THE MARK CONSISTS OF STANDARD CHARACTERS WITHOUT CLAIM TO ANY PARTICULAR FONT, STYLE, SIZE, OR COLOR.

OWNER OF U.S. REG. NO. 694,701.

NO CLAIM IS MADE TO THE EXCLUSIVE RIGHT TO USE "SPWL", APART FROM THE MARK AS SHOWN.

FOR LIFE INSURANCE UNDERWRITING SERVICES, NAMELY, SINGLE PREMIUM WHOLE LIFE POLICIES (U.S. CLS. 100, 101 AND 102).

FIRST USE 2-26-2007; IN COMMERCE 2-26-2007.

3,313,321. GENWORTH FINANCIAL, INC., RICHMOND, VA. SN 77-036,371. PUB. 5-1-2007, FILED 11-3-2006.

MYCLEARCOURSE

THE MARK CONSISTS OF STANDARD CHARACTERS WITHOUT CLAIM TO ANY PARTICULAR FONT, STYLE, SIZE, OR COLOR.

OWNER OF U.S. REG. NO. 3,106,615.

FOR ANNUITY UNDERWRITING; INVESTMENT MANAGEMENT OF AND DISTRIBUTION OF ANNUITIES (U.S. CLS. 100, 101 AND 102).

FIRST USE 1-26-2007; IN COMMERCE 1-26-2007.

3,313,330. AGORA, INC., BALTIMORE, MD. SN 77-052,625. PUB. 5-22-2007, FILED 11-29-2006.

TFN

THE MARK CONSISTS OF STANDARD CHARACTERS WITHOUT CLAIM TO ANY PARTICULAR FONT, STYLE, SIZE, OR COLOR.

FOR FINANCIAL SERVICES, NAMELY PROVIDING INFORMATION IN THE FIELD OF INVESTMENT OPPORTUNITIES VIA THE INTERNET AND INTRANET SYSTEMS (U.S. CLS. 100, 101 AND 102).

FIRST USE 8-1-2007; IN COMMERCE 8-1-2007.

CLASS 36—(Continued).

3,313,333. THE GUARDIAN LIFE INSURANCE COMPANY OF AMERICA, NEW YORK, NY. SN 77-056,548. PUB. 4-17-2007, FILED 12-4-2006.

LIFETIME FOCUS

THE MARK CONSISTS OF STANDARD CHARACTERS WITHOUT CLAIM TO ANY PARTICULAR FONT, STYLE, SIZE, OR COLOR.

FOR FINANCIAL SERVICES, NAMELY VARIABLE ANNUITY UNDERWRITING AND INVESTMENT MANAGEMENT OF AND DISTRIBUTION OF VARIABLE ANNUITIES (U.S. CLS. 100, 101 AND 102).

FIRST USE 1-22-2007; IN COMMERCE 1-22-2007.

3,313,335. KEYCORP, CLEVELAND, OH. SN 77-060,127. PUB. 4-24-2007, FILED 12-8-2006.

SAVEDAY

THE MARK CONSISTS OF STANDARD CHARACTERS WITHOUT CLAIM TO ANY PARTICULAR FONT, STYLE, SIZE, OR COLOR.

FOR ADMINISTRATION OF A SAVINGS PROGRAM FOR ENABLING PARTICIPANTS TO OBTAIN SAVINGS ON A VARIETY OF FINANCIAL SERVICES, NAMELY, CHECKING ACCOUNT SERVICES; CREDIT CARD SERVICES; EDUCATION FINANCING ADVISORY SERVICES; EDUCATIONAL LENDING SERVICES; ELECTRONIC AND ON-LINE BANKING SERVICES; FINANCIAL MANAGEMENT, PLANNING AND PORTFOLIO MANAGEMENT SERVICES; HOME EQUITY LENDING SERVICES; LEASE FINANCING SERVICES; LOAN FINANCING SERVICES; MORTGAGE BANKING AND MORTGAGE LENDING SERVICES; SAVINGS ACCOUNT SERVICES; AND SMALL BUSINESS LENDING SERVICES (U.S. CLS. 100, 101 AND 102).

FIRST USE 1-17-2007; IN COMMERCE 1-17-2007.

3,313,337. FRANKLIN RESOURCES, INC., SAN MATEO, CA. SN 77-067,664. PUB. 5-22-2007, FILED 12-19-2006.

FRANKLIN TEMPLETON REAL
ESTATE ADVISORS

THE MARK CONSISTS OF STANDARD CHARACTERS WITHOUT CLAIM TO ANY PARTICULAR FONT, STYLE, SIZE, OR COLOR.

OWNER OF U.S. REG. NOS. 1,607,629, 2,860,051, AND OTHERS.

CLASS 36—(Continued).

NO CLAIM IS MADE TO THE EXCLUSIVE RIGHT TO USE "REAL ESTATE ADVISORS", APART FROM THE MARK AS SHOWN.

FOR INVESTMENT ADVISORY SERVICES; INVESTMENT MANAGEMENT; MUTUAL FUND INVESTMENT; REAL ESTATE INVESTMENT SERVICES; REAL ESTATE INVESTMENT TRUST MANAGEMENT SERVICES; REAL ESTATE INVESTMENT ADVISORY SERVICES (U.S. CLS. 100, 101 AND 102).

FIRST USE 1-1-2007; IN COMMERCE 1-1-2007.

3,313,366. MIROMAR DEVELOPMENT CORPORATION, ESTERO, FL. SN 78-191,726. PUB. 1-20-2004, FILED 12-5-2002.

IDCFL

FOR LEASING OF RETAIL STORE FLOOR SPACE; LEASING OF SHOPPING MALL SPACE; AND LEASING OF WHOLESALE STORE SPACE (U.S. CLS. 100, 101 AND 102).

FIRST USE 1-3-2003; IN COMMERCE 1-3-2003.

3,313,378. COINSTAR, INC., BELLEVUE, WA. SN 78-250,279. PUB. 9-14-2004, FILED 5-15-2003.

CASH IN YOUR COINS!

THE MARK CONSISTS OF STANDARD CHARACTERS WITHOUT CLAIM TO ANY PARTICULAR FONT, STYLE, SIZE, OR COLOR.

FOR FINANCIAL SERVICES, NAMELY, PROVIDING KIOSKS WHICH CONVERT COINS INTO VOUCHERS REDEEMABLE FOR CASH AND ISSUE COUPONS OFFERING DISCOUNTS TO SHOPPERS; FINANCIAL SERVICES, NAMELY, CREDIT CARD TRANSACTION PROCESSING SERVICES; CHARITABLE FUND RAISING SERVICES, NAMELY, PROVIDING AUTOMATED KIOSKS TO PROCESS COINS THAT HAVE BEEN DONATED TO CIVIC AND NOT-FOR-PROFIT ORGANIZATIONS (U.S. CLS. 100, 101 AND 102).

FIRST USE 11-17-1996; IN COMMERCE 11-17-1996.

3,313,397. DEZER, MICHAEL, SUNNY ISLES BEACH, FL. SN 78-291,239. PUB. 12-27-2005, FILED 8-22-2003.

REAL ESTATE SHOWPLACE

NO CLAIM IS MADE TO THE EXCLUSIVE RIGHT TO USE "REAL ESTATE", APART FROM THE MARK AS SHOWN.

FOR REAL ESTATE BROKERAGE SERVICES (U.S. CLS. 100, 101 AND 102).

FIRST USE 11-30-2006; IN COMMERCE 11-30-2006.

CLASS 36—(Continued).

3,313,424. FREEDOM FIRST CAPITAL, LLC, BETHESDA, MD. SN 78-363,564. PUB. 11-14-2006, FILED 2-6-2004.

**FREEDOM FIRST
CAPITAL**

THE MARK CONSISTS OF STANDARD CHARACTERS WITHOUT CLAIM TO ANY PARTICULAR FONT, STYLE, SIZE, OR COLOR.

NO CLAIM IS MADE TO THE EXCLUSIVE RIGHT TO USE "CAPITAL", APART FROM THE MARK AS SHOWN.

FOR FINANCIAL SERVICES, NAMELY THE PURCHASE OF FUTURE PAYMENTS OF LOTTERY AND CONTEST WINNINGS, STRUCTURED SETTLEMENTS, AND SECURED INSURANCE SETTLEMENTS (U.S. CLS. 100, 101 AND 102).

FIRST USE 5-18-2007; IN COMMERCE 5-18-2007.

3,313,571. NETBANK, INC., ALPHARETTA, GA. SN 78-572,790. PUB. 2-28-2006, FILED 2-23-2005.

POWERPOST

THE MARK CONSISTS OF STANDARD CHARACTERS WITHOUT CLAIM TO ANY PARTICULAR FONT, STYLE, SIZE, OR COLOR.

FOR ACCOUNTS PAYABLE DEBITING SERVICES FOR SMALL BUSINESS OWNERS AND ELECTRONIC CASH DEPOSIT TRANSACTIONS FOR SMALL BUSINESS OWNERS (U.S. CLS. 100, 101 AND 102).

FIRST USE 3-24-2005; IN COMMERCE 3-24-2005.

CLASS 36—(Continued).

3,313,658. BPG PROPERTIES, LTD., YARDLEY, PA. SN 78-617,149. PUB. 1-24-2006, FILED 4-26-2005.

CLASS 36—(Continued).

3,313,744. RICHARDS, ANN, DANVILLE, CA. AND RICHARDS, CARISSA, DANVILLE, CA. SN 78-653,515. PUB. 1-16-2007, FILED 6-17-2005.

**CREATING COMMUNITY.
ENRICHING HISTORY.**

THE MARK CONSISTS OF STANDARD CHARACTERS WITHOUT CLAIM TO ANY PARTICULAR FONT, STYLE, SIZE, OR COLOR.

FOR COMMERCIAL AND RESIDENTIAL REAL ESTATE MANAGEMENT SERVICES (U.S. CLS. 100, 101 AND 102).

FIRST USE 1-1-2006; IN COMMERCE 1-1-2006.

GOT REALTY?

THE MARK CONSISTS OF STANDARD CHARACTERS WITHOUT CLAIM TO ANY PARTICULAR FONT, STYLE, SIZE, OR COLOR.

NO CLAIM IS MADE TO THE EXCLUSIVE RIGHT TO USE "REALTY", APART FROM THE MARK AS SHOWN.

FOR AGENCIES OR BROKERAGE SERVICES FOR LEASING OR RENTING OF REAL PROPERTY, NAMELY RESIDENTIAL PROPERTIES, LOTS, LAND, MOBILE HOMES, MULTI-UNIT PROPERTIES, COMMERCIAL PROPERTIES AND LAND, INDUSTRIAL PROPERTIES AND LAND, BUSINESS PROPERTIES AND LAND, AND PROFESSIONAL PROPERTIES AND LAND; LAND AND BUILDINGS ACQUISITION, NAMELY, REAL ESTATE BROKERAGE, PURCHASING, AND SELLING LAND AND BUILDINGS FOR OTHERS; REAL ESTATE AGENCIES, REAL ESTATE SERVICES, NAMELY, CONSULTATION, APPRAISAL, LISTING, INVESTMENT, MANAGEMENT AND LEASING AND FACILITATION AND ARRANGING FOR THE FINANCING OF REAL PROPERTY, NAMELY RESIDENTIAL PROPERTIES, LOTS, LAND, MOBILE HOMES, MULTI-UNIT PROPERTIES, COMMERCIAL PROPERTIES AND LAND, INDUSTRIAL PROPERTIES AND LAND, BUSINESS PROPERTIES AND LAND, AND PROFESSIONAL PROPERTIES AND LAND; PROVIDING INFORMATION IN THE FIELD OF REAL ESTATE BY MEANS OF LINKING THE WEB SITE TO OTHER WEB SITES FEATURING REAL ESTATE INFORMATION (U.S. CLS. 100, 101 AND 102).

FIRST USE 8-31-2005; IN COMMERCE 8-31-2005.

3,313,677. PEOPLES BANK, PARIS, TX. SN 78-624,283. PUB. 9-5-2006, FILED 5-5-2005.

3,313,772. UNITED SERVICES AUTOMOBILE ASSOCIATION, SAN ANTONIO, TX. SN 78-663,573. PUB. 9-5-2006, FILED 7-5-2005.

EFINITY

THE MARK CONSISTS OF STANDARD CHARACTERS WITHOUT CLAIM TO ANY PARTICULAR FONT, STYLE, SIZE, OR COLOR.

FOR BANKING SERVICES; FINANCIAL SERVICES, NAMELY, MONEY LENDING SERVICES; CREDIT CARD SERVICES; AND DEBIT CARD SERVICES (U.S. CLS. 100, 101 AND 102).

FIRST USE 5-19-2007; IN COMMERCE 5-19-2007.

USAA DEBT PROTECTION

THE MARK CONSISTS OF STANDARD CHARACTERS WITHOUT CLAIM TO ANY PARTICULAR FONT, STYLE, SIZE, OR COLOR.

OWNER OF U.S. REG. NOS. 806,520, 2,190,979, AND OTHERS.

NO CLAIM IS MADE TO THE EXCLUSIVE RIGHT TO USE "DEBT PROTECTION", APART FROM THE MARK AS SHOWN.

FOR LOAN SERVICES FEATURING A DEBT CANCELLATION PROGRAM, NAMELY, PAYING COVERED DEBTS IN THE EVENT OF A TRIGGERING OCCURRENCE, NAMELY DISABILITY, UNEMPLOYMENT, UNFORESEEN DEATH, MILITARY SERVICE ACTIVATION, AND FAMILY LEAVE (U.S. CLS. 100, 101 AND 102).

FIRST USE 8-0-2005; IN COMMERCE 8-0-2005.

CLASS 36—(Continued).

3,313,773. BON SECOUR VILLAGE, LLC, CULLMAN, AL. SN 78-665,422. PUB. 4-4-2006, FILED 7-7-2005.



FOR REAL ESTATE INVESTMENT, BROKERAGE, ASSESSMENT, CONSULTANCY, LEASING, MANAGEMENT, APPRAISAL, LAND ACQUISITION AND ESCROW SERVICES (U.S. CLS. 100, 101 AND 102).
FIRST USE 5-29-2007; IN COMMERCE 5-29-2007.

3,313,796. SEVEN HILLS SETTLEMENTS, LLC, ROME, GA. SN 78-674,628. PUB. 9-26-2006, FILED 7-20-2005.

SEVEN HILLS SETTLEMENTS

THE MARK CONSISTS OF STANDARD CHARACTERS WITHOUT CLAIM TO ANY PARTICULAR FONT, STYLE, SIZE, OR COLOR.

NO CLAIM IS MADE TO THE EXCLUSIVE RIGHT TO USE "SETTLEMENTS", APART FROM THE MARK AS SHOWN.

FOR VIATICAL SETTLEMENT AND LIFE SETTLEMENT SERVICES (U.S. CLS. 100, 101 AND 102).

FIRST USE 7-0-2005; IN COMMERCE 7-0-2005.

3,313,807. GREENLIGHT REINSURANCE, LTD., GRAND CAYMAN, CAYMAN ISLANDS. SN 78-680,727. PUB. 10-10-2006, FILED 7-28-2005.

GREENLIGHT RE

THE MARK CONSISTS OF STANDARD CHARACTERS WITHOUT CLAIM TO ANY PARTICULAR FONT, STYLE, SIZE, OR COLOR.

NO CLAIM IS MADE TO THE EXCLUSIVE RIGHT TO USE "RE", APART FROM THE MARK AS SHOWN.

FOR REINSURANCE UNDERWRITING (U.S. CLS. 100, 101 AND 102).

FIRST USE 4-0-2006; IN COMMERCE 4-0-2006.

CLASS 36—(Continued).

3,313,865. FIA CARD SERVICES, NATIONAL ASSOCIATION, WILMINGTON, DE. SN 78-707,165. PUB. 12-12-2006, FILED 9-6-2005.

HOME ADVANTAGE

THE MARK CONSISTS OF STANDARD CHARACTERS WITHOUT CLAIM TO ANY PARTICULAR FONT, STYLE, SIZE, OR COLOR.

FOR CREDIT CARD SERVICES (U.S. CLS. 100, 101 AND 102).

FIRST USE 8-0-2005; IN COMMERCE 8-0-2005.

3,313,883. ROYSE CITY FINANCIAL, INC., ROCKWALL, TX. SN 78-713,861. PUB. 5-23-2006, FILED 9-15-2005.

TEXAS LEADERSHIP BANK

THE MARK CONSISTS OF STANDARD CHARACTERS WITHOUT CLAIM TO ANY PARTICULAR FONT, STYLE, SIZE, OR COLOR.

NO CLAIM IS MADE TO THE EXCLUSIVE RIGHT TO USE "TEXAS" OR "BANK", APART FROM THE MARK AS SHOWN.

FOR BANKING SERVICES; FINANCIAL MANAGEMENT AND CONSULTATION SERVICES; CASH MANAGEMENT SERVICES; FINANCIAL MANAGEMENT, NAMELY, TRUST SERVICES; FINANCIAL ASSET MANAGEMENT SERVICES; INVESTMENT MANAGEMENT AND CONSULTATION SERVICES; MANAGEMENT OF PORTFOLIOS COMPRISING SECURITIES; FINANCIAL CONSULTATION REGARDING MANAGEMENT OF PORTFOLIOS COMPRISING SECURITIES; INSURANCE AGENCY FOR ALL TYPES OF INSURANCE; MORTGAGE BANKING SERVICES; FINANCIAL SERVICES, NAMELY MONEY LENDING; COMMERCIAL LENDING SERVICES; MORTGAGE LENDING SERVICES; CONSUMER LENDING SERVICES; COMMERCIAL REAL ESTATE LENDING SERVICES; AND CAPITAL FUNDING INVESTMENT ASSISTANCE AND CONSULTATION SERVICES (U.S. CLS. 100, 101 AND 102).

FIRST USE 10-10-2006; IN COMMERCE 10-10-2006.

3,313,905. ARKANSAS BLUE CROSS AND BLUE SHIELD, LITTLE ROCK, AR. SN 78-723,708. PUB. 9-26-2006, FILED 9-29-2005.

USABLE LIFE CONNECT PPO

CLASS 36—(Continued).

THE MARK CONSISTS OF STANDARD CHARACTERS WITHOUT CLAIM TO ANY PARTICULAR FONT, STYLE, SIZE, OR COLOR.

OWNER OF U.S. REG. NOS. 1,482,030, 1,482,689, AND OTHERS.

NO CLAIM IS MADE TO THE EXCLUSIVE RIGHT TO USE "PPO", APART FROM THE MARK AS SHOWN.

FOR ADMINISTRATION OF PREFERRED PROVIDER PLANS IN THE FIELD OF HEALTH CARE (U.S. CLS. 100, 101 AND 102).

FIRST USE 12-1-2005; IN COMMERCE 12-1-2005.

3,313,943. GUIDANT FINANCIAL GROUP, INC., BELLEVUE, WA. SN 78-740,453. PUB. 7-4-2006, FILED 10-25-2005.

AUDEO

THE MARK CONSISTS OF STANDARD CHARACTERS WITHOUT CLAIM TO ANY PARTICULAR FONT, STYLE, SIZE, OR COLOR.

FOR RETIREMENT ACCOUNT FACILITATION, NAMELY, STRUCTURING SELF-DIRECTED RETIREMENT ACCOUNTS FOR OTHERS AND ASSISTING OTHERS IN STRUCTURING RETIREMENT ACCOUNTS TO COMPLY WITH TAX AND ERISA RULES AND REGULATIONS (U.S. CLS. 100, 101 AND 102).

FIRST USE 1-0-2006; IN COMMERCE 1-0-2006.

3,313,944. GUIDANT FINANCIAL GROUP, INC., BELLEVUE, WA. SN 78-740,456. PUB. 7-4-2006, FILED 10-25-2005.

EMBARK ON A NEW WORLD OF INVESTMENT

THE MARK CONSISTS OF STANDARD CHARACTERS WITHOUT CLAIM TO ANY PARTICULAR FONT, STYLE, SIZE, OR COLOR.

FOR RETIREMENT ACCOUNT FACILITATION, NAMELY, STRUCTURING SELF-DIRECTED RETIREMENT ACCOUNTS FOR OTHERS AND ASSISTING OTHERS IN STRUCTURING RETIREMENT ACCOUNTS TO COMPLY WITH TAX AND ERISA RULES AND REGULATIONS (U.S. CLS. 100, 101 AND 102).

FIRST USE 1-0-2006; IN COMMERCE 1-0-2006.

CLASS 36—(Continued).

3,313,973. SOUTH DAKOTA BOARD OF REGENTS, PIERRE, SD. SN 78-747,894. PUB. 8-15-2006, FILED 11-5-2005.

SDePay

THE MARK CONSISTS OF STANDARD CHARACTERS WITHOUT CLAIM TO ANY PARTICULAR FONT, STYLE, SIZE, OR COLOR.

FOR ELECTRONIC BILL PAYMENT SERVICES PROVIDED BY MEANS OF THE GLOBAL INFORMATION NETWORK (U.S. CLS. 100, 101 AND 102).

FIRST USE 0-0-2006; IN COMMERCE 0-0-2006.

3,313,978. AMERICAN EXPRESS MARKETING & DEVELOPMENT CORP., NEW YORK, NY. SN 78-749,138. PUB. 7-18-2006, FILED 11-8-2005.

HOTEL FOLIO

THE MARK CONSISTS OF STANDARD CHARACTERS WITHOUT CLAIM TO ANY PARTICULAR FONT, STYLE, SIZE, OR COLOR.

NO CLAIM IS MADE TO THE EXCLUSIVE RIGHT TO USE "HOTEL", APART FROM THE MARK AS SHOWN.

FOR CREDIT AND CASH CARD SERVICES (U.S. CLS. 100, 101 AND 102).

FIRST USE 10-0-2005; IN COMMERCE 10-0-2005.

3,313,987. LEE CAPITAL MANAGEMENT L.P., BOSTON, MA. SN 78-749,643. PUB. 7-11-2006, FILED 11-8-2005.

TRI FIN FUND

THE MARK CONSISTS OF STANDARD CHARACTERS WITHOUT CLAIM TO ANY PARTICULAR FONT, STYLE, SIZE, OR COLOR.

NO CLAIM IS MADE TO THE EXCLUSIVE RIGHT TO USE "FUND", APART FROM THE MARK AS SHOWN.

FOR INVESTMENT OF FUNDS FOR OTHERS; INVESTMENT ADVICE; INVESTMENT CONSULTATION; INVESTMENT MANAGEMENT; MANAGEMENT OF A CAPITAL INVESTMENT FUND (U.S. CLS. 100, 101 AND 102).

FIRST USE 12-31-2005; IN COMMERCE 12-31-2005.

CLASS 36—(Continued).

3,314,017. AFFILIATED WEALTH RESOURCES, INC., CARLSBAD, CA. SN 78-754,343. PUB. 7-25-2006, FILED 11-15-2005.

GET A GRIP ON YOUR RETIREMENT

THE MARK CONSISTS OF STANDARD CHARACTERS WITHOUT CLAIM TO ANY PARTICULAR FONT, STYLE, SIZE, OR COLOR.

FOR RETIREMENT INCOME PLANNING SERVICES (U.S. CLS. 100, 101 AND 102).

FIRST USE 12-1-2005; IN COMMERCE 12-1-2005.

3,314,040. UNION SECURITY INSURANCE COMPANY, KANSAS CITY, MO. SN 78-760,166. PUB. 2-6-2007, FILED 11-23-2005.

VOLUNTARY DISABILITY SPECTRUM

THE MARK CONSISTS OF STANDARD CHARACTERS WITHOUT CLAIM TO ANY PARTICULAR FONT, STYLE, SIZE, OR COLOR.

NO CLAIM IS MADE TO THE EXCLUSIVE RIGHT TO USE "VOLUNTARY DISABILITY", APART FROM THE MARK AS SHOWN.

FOR UNDERWRITING AND ADMINISTRATION OF DISABILITY INSURANCE (U.S. CLS. 100, 101 AND 102).

FIRST USE 11-0-2005; IN COMMERCE 11-0-2005.

3,314,043. SYSTRAN FINANCIAL SERVICES CORPORATION, LAKE OSWEGO, OR. SN 78-760,682. PUB. 8-1-2006, FILED 11-23-2005.

POWER OF TWO F2+ PROGRAM

THE MARK CONSISTS OF STANDARD CHARACTERS WITHOUT CLAIM TO ANY PARTICULAR FONT, STYLE, SIZE, OR COLOR.

NO CLAIM IS MADE TO THE EXCLUSIVE RIGHT TO USE "PROGRAM", APART FROM THE MARK AS SHOWN.

FOR COMMERCIAL LENDING SERVICES (U.S. CLS. 100, 101 AND 102).

FIRST USE 3-0-2005; IN COMMERCE 3-0-2005.

CLASS 36—(Continued).

3,314,099. INDYMAC BANK, F.S.B., PASADENA, CA. SN 78-768,539. PUB. 9-5-2006, FILED 12-7-2005.

DYNAMICASH

THE MARK CONSISTS OF STANDARD CHARACTERS WITHOUT CLAIM TO ANY PARTICULAR FONT, STYLE, SIZE, OR COLOR.

FOR FINANCIAL, BANKING, AND LENDING SERVICES, NAMELY DEBIT AND ATM CARD SERVICES (U.S. CLS. 100, 101 AND 102).

FIRST USE 4-1-2007; IN COMMERCE 4-1-2007.

3,314,101. INDYMAC BANK, F.S.B., PASADENA, CA. SN 78-769,098. PUB. 9-5-2006, FILED 12-8-2005.

DYNAMICLINE

THE MARK CONSISTS OF STANDARD CHARACTERS WITHOUT CLAIM TO ANY PARTICULAR FONT, STYLE, SIZE, OR COLOR.

FOR FINANCIAL, BANKING, AND LENDING SERVICES, NAMELY CREDIT CARD SERVICES (U.S. CLS. 100, 101 AND 102).

FIRST USE 12-20-2006; IN COMMERCE 12-20-2006.

3,314,111. PRESTON CAPITAL MANAGEMENT LLC, LUTHERVILLE, MD. SN 78-771,216. PUB. 8-22-2006, FILED 12-12-2005.

PRESTON CAPITAL MANAGEMENT LLC

THE MARK CONSISTS OF STANDARD CHARACTERS WITHOUT CLAIM TO ANY PARTICULAR FONT, STYLE, SIZE, OR COLOR.

NO CLAIM IS MADE TO THE EXCLUSIVE RIGHT TO USE "CAPITAL MANAGEMENT LLC", APART FROM THE MARK AS SHOWN.

FOR REAL ESTATE INVESTMENT MANAGEMENT (U.S. CLS. 100, 101 AND 102).

FIRST USE 1-0-2006; IN COMMERCE 1-0-2006.

CLASS 36—(Continued).

3,314,112. PRESTON CAPITAL MANAGEMENT LLC, LUTHERVILLE, MD. SN 78-771,226. PUB. 8-22-2006, FILED 12-12-2005.

1177

THE MARK CONSISTS OF STANDARD CHARACTERS WITHOUT CLAIM TO ANY PARTICULAR FONT, STYLE, SIZE, OR COLOR.

FOR REAL ESTATE INVESTMENT MANAGEMENT (U.S. CLS. 100, 101 AND 102).

FIRST USE 1-0-2006; IN COMMERCE 1-0-2006.

3,314,115. GUIDANT FINANCIAL GROUP, INC, BELLEVUE, WA. SN 78-771,781. PUB. 7-4-2006, FILED 12-13-2005.



audeo

THE MARK CONSISTS OF THE DESIGN OF A SAIL, DISPLAYED AGAINST A BACKGROUND IMAGE THAT TAPERS BOTH DOWNWARDLY AND SIDWARDLY, WITH THE IMAGE OF AN UNDULATING BAND BELOW THE SAIL.

FOR RETIREMENT ACCOUNT FACILITATION, NAMELY, STRUCTURING SELF-DIRECTED RETIREMENT ACCOUNTS FOR OTHERS AND ASSISTING OTHERS IN STRUCTURING RETIREMENT ACCOUNTS TO COMPLY WITH TAX AND ERISA RULES AND REGULATIONS (U.S. CLS. 100, 101 AND 102).

FIRST USE 1-0-2006; IN COMMERCE 1-0-2006.

3,314,126. FOUNDATION FOR GRIEVING CHILDREN, INC., NEW YORK, NY. SN 78-774,278. PUB. 8-22-2006, FILED 12-15-2005.

RESTORE THE SMILES. REBUILD THE JOY.

THE MARK CONSISTS OF STANDARD CHARACTERS WITHOUT CLAIM TO ANY PARTICULAR FONT, STYLE, SIZE, OR COLOR.

FOR CHARITABLE SERVICES, NAMELY, FUND RAISING TO PROVIDE GRANTS TO NONPROFIT ORGANIZATIONS THAT ASSIST CHILDREN AND FAMILIES WHO HAVE EXPERIENCED THE DEATH OF A LOVED ONE (U.S. CLS. 100, 101 AND 102).

FIRST USE 12-7-2005; IN COMMERCE 12-7-2005.

CLASS 36—(Continued).

3,314,133. DRIVETIME SALES AND FINANCE CORPORATION, PHOENIX, AZ. SN 78-774,756. PUB. 8-15-2006, FILED 12-16-2005.

DT ACCEPTANCE

THE MARK CONSISTS OF STANDARD CHARACTERS WITHOUT CLAIM TO ANY PARTICULAR FONT, STYLE, SIZE, OR COLOR.

OWNER OF U.S. REG. NOS. 3,041,161 AND 3,077,527.

NO CLAIM IS MADE TO THE EXCLUSIVE RIGHT TO USE "ACCEPTANCE", APART FROM THE MARK AS SHOWN.

FOR AUTOMOBILE FINANCING SERVICES (U.S. CLS. 100, 101 AND 102).

FIRST USE 8-0-2005; IN COMMERCE 8-0-2005.

3,314,143. WEALTH ADVISOR GROUP LLC, HENDERSONVILLE, NC. SN 78-776,316. PUB. 8-15-2006, FILED 12-19-2005.

THE PROSPERITY MODEL

THE MARK CONSISTS OF STANDARD CHARACTERS WITHOUT CLAIM TO ANY PARTICULAR FONT, STYLE, SIZE, OR COLOR.

NO CLAIM IS MADE TO THE EXCLUSIVE RIGHT TO USE "MODEL", APART FROM THE MARK AS SHOWN.

FOR FINANCIAL ANALYSIS AND CONSULTATION; FINANCIAL INVESTMENT IN THE FIELD OF SECURITIES; FINANCIAL PLANNING (U.S. CLS. 100, 101 AND 102).

FIRST USE 4-1-2006; IN COMMERCE 6-1-2006.

CLASS 36—(Continued).

3,314,156. TRIANON PROPERTIES, INC., NAPLES, FL. SN 78-777,319. PUB. 9-5-2006, FILED 12-20-2005.

TRIANON

THE MARK CONSISTS OF STANDARD CHARACTERS WITHOUT CLAIM TO ANY PARTICULAR FONT, STYLE, SIZE, OR COLOR.

OWNER OF U.S. REG. NOS. 2,170,201 AND 2,236,377.

FOR REAL ESTATE AGENCIES SERVICES; REAL ESTATE LISTING SERVICES; REAL ESTATE BROKERAGE SERVICES; PROVIDING INFORMATION ABOUT REAL ESTATE AGENCIES, BROKERAGE, INVESTMENT, APPRAISAL, PROCUREMENT, TIME-SHARING, RENTAL AND LEASING TO OTHERS; MORTGAGE LENDING, MORTGAGE BANKING, MORTGAGE BROKERAGE, MORTGAGE SERVICES, NAMELY MORTGAGE PROCUREMENT FOR OTHERS AND MAINTAINING MORTGAGE ESCROW ACCOUNTS, AND FINANCING SERVICES PERTAINING TO REAL ESTATE; OPERATING MARKETPLACES FOR SELLERS OF GOODS AND/OR SERVICES; PROVIDING INFORMATION IN THE FIELD OF REAL ESTATE BY LINKING THE WEB SITE TO OTHER WEB SITES FEATURING REAL ESTATE INFORMATION; REAL ESTATE MANAGEMENT; REAL ESTATE INVESTMENT; REAL ESTATE APPRAISAL; REAL ESTATE PROCUREMENT FOR OTHERS; REAL ESTATE TIME-SHARING; RENTAL OF APARTMENTS, CONDOMINIUMS, OFFICE SPACE AND REAL ESTATE; LEASING OF APARTMENTS, OFFICE SPACE, REAL ESTATE AND SHOPPING MALL SPACE; TRUST SERVICES, NAMELY INVESTMENT AND TRUST COMPANY SERVICES; REPRESENTATIVE SERVICES AND TRUST ADMINISTRATION; FINANCIAL ANALYSIS AND CONSULTATION; PLANNING; FINANCIAL PORTFOLIO MANAGEMENT; CAPITAL INVESTMENT CONSULTATION AND ADVICE; REAL ESTATE INVESTMENT; CAPITAL INVESTMENT CONSULTATION; OF FUNDS FOR OTHERS; INVESTMENT OF FUNDS, MUTUAL FUNDS AND REAL ESTATE; CAPITAL INVESTMENT; INVESTMENT OF TRUST FUNDS FOR OTHERS; INVESTMENT AND FINANCIAL INVESTMENT IN THE FIELD OF REAL ESTATE AND SECURITIES; INTERNET (U.S. CLS. 100, 101 AND 102).

FIRST USE 1-23-2004; IN COMMERCE 1-23-2004.

3,314,159. ADVANTAGE NATIONAL BANK, ELK GROVE VILLAGE, IL. SN 78-777,854. PUB. 10-3-2006, FILED 12-21-2005.

OLD TOWN BANK & TRUST OF BLOOMINGDALE

THE MARK CONSISTS OF STANDARD CHARACTERS WITHOUT CLAIM TO ANY PARTICULAR FONT, STYLE, SIZE, OR COLOR.

NO CLAIM IS MADE TO THE EXCLUSIVE RIGHT TO USE "BANK & TRUST OF BLOOMINGDALE", APART FROM THE MARK AS SHOWN.

FOR BANKING SERVICES (U.S. CLS. 100, 101 AND 102).

FIRST USE 5-1-2007; IN COMMERCE 5-1-2007.

CLASS 36—(Continued).

3,314,171. AMERICAN INTERNATIONAL GROUP, INC., NEW YORK, NY. SN 78-780,288. PUB. 8-29-2006, FILED 12-23-2005.

PRIME EXPRESS

THE MARK CONSISTS OF STANDARD CHARACTERS WITHOUT CLAIM TO ANY PARTICULAR FONT, STYLE, SIZE, OR COLOR.

FOR INSURANCE UNDERWRITING IN THE FIELD OF EXCESS LIABILITY (U.S. CLS. 100, 101 AND 102).

FIRST USE 4-16-2007; IN COMMERCE 4-16-2007.

3,314,189. PLATINUM FUNDING GROUP LLC, NEW YORK, NY. SN 78-784,683. PUB. 9-5-2006, FILED 1-4-2006.

A FACTOR IN YOUR SUCCESS

THE MARK CONSISTS OF STANDARD CHARACTERS WITHOUT CLAIM TO ANY PARTICULAR FONT, STYLE, SIZE, OR COLOR.

FOR FINANCIAL AND FACTORING SERVICES; NAMELY, ACCOUNTS RECEIVABLES PURCHASING, ASSET-BASED FINANCING, INVENTORY FINANCING AND SECURE AND UNSECURED LOANS (U.S. CLS. 100, 101 AND 102).

FIRST USE 2-0-2006; IN COMMERCE 2-0-2006.

3,314,204. AMERICA'S REAL ESTATE CONNECTION, INC., WOODSTOCK, GA. SN 78-786,503. PUB. 2-6-2007, FILED 1-6-2006.

America's Real Estate Connection

THE MARK CONSISTS OF STANDARD CHARACTERS WITHOUT CLAIM TO ANY PARTICULAR FONT, STYLE, SIZE, OR COLOR.

NO CLAIM IS MADE TO THE EXCLUSIVE RIGHT TO USE "AMERICA'S REAL ESTATE", APART FROM THE MARK AS SHOWN.

FOR REAL ESTATE SERVICES, NAMELY, LISTING AND MANAGING OF REAL ESTATE, AND REAL ESTATE AGENCIES (U.S. CLS. 100, 101 AND 102).

FIRST USE 11-30-2003; IN COMMERCE 11-30-2003.

CLASS 36—(Continued).

3,314,225. AMERIPRISE FINANCIAL, INC., MINNEAPOLIS, MN. SN 78-791,159. PUB. 8-22-2006, FILED 1-13-2006.

GWB FOR LIFE

THE MARK CONSISTS OF STANDARD CHARACTERS WITHOUT CLAIM TO ANY PARTICULAR FONT, STYLE, SIZE, OR COLOR.

FOR FINANCIAL SERVICES, NAMELY, INVESTMENT ADVISORY SERVICES; INVESTMENT MANAGEMENT OF AND DISTRIBUTION OF ANNUITIES (U.S. CLS. 100, 101 AND 102).

FIRST USE 5-1-2006; IN COMMERCE 5-1-2006.

3,314,227. AMERIPRISE FINANCIAL, INC., MINNEAPOLIS, MN. SN 78-791,485. PUB. 12-5-2006, FILED 1-13-2006.

CAPITAL INSIGHTS

THE MARK CONSISTS OF STANDARD CHARACTERS WITHOUT CLAIM TO ANY PARTICULAR FONT, STYLE, SIZE, OR COLOR.

NO CLAIM IS MADE TO THE EXCLUSIVE RIGHT TO USE "CAPITAL", APART FROM THE MARK AS SHOWN.

FOR FINANCIAL SERVICES, NAMELY, ADVICE RELATING TO INVESTMENTS, ASSET MANAGEMENT, CASH MANAGEMENT; FINANCIAL PLANNING CONSULTATION, FINANCIAL PORTFOLIO MANAGEMENT (U.S. CLS. 100, 101 AND 102).

FIRST USE 5-8-2006; IN COMMERCE 5-8-2006.

3,314,246. LIONESS FINANCIAL SERVICES, INC., SACRAMENTO, CA. SN 78-793,367. PUB. 9-26-2006, FILED 1-17-2006.

Lioness Financial Services, Inc.

THE MARK CONSISTS OF STANDARD CHARACTERS WITHOUT CLAIM TO ANY PARTICULAR FONT, STYLE, SIZE, OR COLOR.

NO CLAIM IS MADE TO THE EXCLUSIVE RIGHT TO USE "FINANCIAL SERVICES, INC.", APART FROM THE MARK AS SHOWN.

FOR FINANCIAL SERVICES, NAMELY, ASSISTING AUTOMOBILE DEALERSHIPS IN LOAN PROCUREMENT FOR CAR BUYERS (U.S. CLS. 100, 101 AND 102).

FIRST USE 1-2-2007; IN COMMERCE 1-2-2007.

CLASS 36—(Continued).

3,314,257. CARGILL, INCORPORATED, WAYZATA, MN. SN 78-795,552. PUB. 4-10-2007, FILED 1-20-2006.

Harvest Health

THE MARK CONSISTS OF STANDARD CHARACTERS WITHOUT CLAIM TO ANY PARTICULAR FONT, STYLE, SIZE, OR COLOR.

NO CLAIM IS MADE TO THE EXCLUSIVE RIGHT TO USE "HEALTH", APART FROM THE MARK AS SHOWN.

FOR FUNDING A HEALTH SAVINGS ACCOUNT IN EXCHANGE FOR FARMERS' GRAIN SALE COMMITMENT (U.S. CLS. 100, 101 AND 102).

FIRST USE 2-28-2006; IN COMMERCE 2-28-2006.

3,314,372. CARTUS CORPORATION, DANBURY, CT. SN 78-818,045. PUB. 9-26-2006, FILED 2-17-2006.

CARTUS



THE MARK CONSISTS OF A GLOBE MADE WITH LINES. FOR BROKERAGE, MANAGEMENT AND LEASING SERVICES, ALL RELATING TO REAL ESTATE (U.S. CLS. 100, 101 AND 102).

FIRST USE 5-22-2006; IN COMMERCE 5-22-2006.

3,314,373. CARTUS CORPORATION, DANBURY, CT. SN 78-818,047. PUB. 9-26-2006, FILED 2-17-2006.

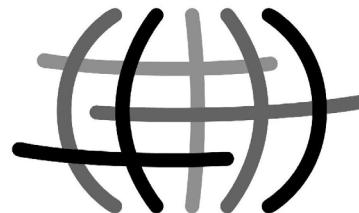

THE MARK CONSISTS OF A GLOBE MADE WITH LINES. FOR BROKERAGE, MANAGEMENT AND LEASING SERVICES, ALL RELATING TO REAL ESTATE (U.S. CLS. 100, 101 AND 102).

FIRST USE 5-22-2006; IN COMMERCE 5-22-2006.

CLASS 36—(Continued).

3,314,374. CARTUS CORPORATION, DANBURY, CT. SN 78-818,055. PUB. 9-26-2006, FILED 2-17-2006.



THE COLOR(S) GREEN, ORANGE AND BLUE IS/ARE CLAIMED AS A FEATURE OF THE MARK.

THE MARK CONSISTS OF A GLOBE MADE WITH THREE GREEN LINES, THREE BLUE LINES AND TWO ORANGE LINES.

FOR BROKERAGE, MANAGEMENT AND LEASING SERVICES, ALL RELATING TO REAL ESTATE (U.S. CLS. 100, 101 AND 102).

FIRST USE 5-22-2006; IN COMMERCE 5-22-2006.

3,314,381. RANDOLPH, ROBERT RICHARD JR., OXNARD, CA. SN 78-818,841. PUB. 11-7-2006, FILED 2-20-2006.

Protect and Defend

THE MARK CONSISTS OF STANDARD CHARACTERS WITHOUT CLAIM TO ANY PARTICULAR FONT, STYLE, SIZE, OR COLOR.

FOR CHARITABLE FUND RAISING (U.S. CLS. 100, 101 AND 102).

FIRST USE 5-1-2006; IN COMMERCE 7-7-2006.

3,314,384. INDYMAC BANK, F.S.B., PASADENA, CA. SN 78-819,296. PUB. 9-12-2006, FILED 2-21-2006.

LET THE FUND BEGIN

THE MARK CONSISTS OF STANDARD CHARACTERS WITHOUT CLAIM TO ANY PARTICULAR FONT, STYLE, SIZE, OR COLOR.

FOR FINANCIAL SERVICES, NAMELY MORTGAGE AND LOAN ORIGINATION, BROKERAGE AND SERVICING; ORIGINATING, BROKERING AND SERVICING MORTGAGES AND LOANS TO SECONDARY MARKET INVESTORS; PROVISION OF MORTGAGE MANAGEMENT, SERVICING, AND CONSULTATION SERVICES TO BROKERS, BANKERS AND OTHER FINANCIAL PROFESSIONALS (U.S. CLS. 100, 101 AND 102).

FIRST USE 6-16-2006; IN COMMERCE 6-16-2006.

CLASS 36—(Continued).

3,314,395. HICKS, MUSE, TATE & FURST INCORPORATED, DALLAS, TX. SN 78-821,500. PUB. 10-17-2006, FILED 2-23-2006.

HM CAPITAL PARTNERS

THE MARK CONSISTS OF STANDARD CHARACTERS WITHOUT CLAIM TO ANY PARTICULAR FONT, STYLE, SIZE, OR COLOR.

NO CLAIM IS MADE TO THE EXCLUSIVE RIGHT TO USE "CAPITAL PARTNERS", APART FROM THE MARK AS SHOWN.

FOR PRIVATE INVESTMENT AND ACQUISITION RELATED ACTIVITIES, NAMELY, INVESTMENT OF FUNDS OF OTHERS AND INVESTMENT AND PORTFOLIO COMPANY MANAGEMENT (U.S. CLS. 100, 101 AND 102).

FIRST USE 3-1-2006; IN COMMERCE 3-1-2006.

3,314,396. WADENA INSURANCE COMPANY, WEST DES MOINES, IA. SN 78-821,614. PUB. 1-2-2007, FILED 2-23-2006.

WADENA

THE MARK CONSISTS OF STANDARD CHARACTERS WITHOUT CLAIM TO ANY PARTICULAR FONT, STYLE, SIZE, OR COLOR.

FOR UNDERWRITING INSURANCE IN THE FIELDS OF PROPERTY, CASUALTY, LIABILITY AND WORKERS COMPENSATION, AND UNDERWRITING FIDELITY AND SURETY BONDS (U.S. CLS. 100, 101 AND 102).

FIRST USE 1-1-2007; IN COMMERCE 1-1-2007.

CLASS 36—(Continued).

3,314,397. WADENA INSURANCE COMPANY, WEST DES MOINES, IA. SN 78-821,648. PUB. 12-5-2006, FILED 2-23-2006.



THE COLOR(S) RED, BLACK AND WHITE IS/ARE CLAIMED AS A FEATURE OF THE MARK.

THE MARK CONSISTS OF A STYLIZED LETTER W IN RED WITHIN A BLACK DIAMOND. THE BACKGROUND WITHIN THE BLACK DIAMOND IS WHITE.

FOR UNDERWRITING INSURANCE IN THE FIELDS OF PROPERTY, CASUALTY, LIABILITY AND WORKERS COMPENSATION, AND UNDERWRITING FIDELITY AND SURETY BONDS (U.S. CLS. 100, 101 AND 102).

FIRST USE 1-1-2007; IN COMMERCE 1-1-2007.

3,314,402. AMERICAN INTERNATIONAL GROUP, INC., NEW YORK, NY. SN 78-821,890. PUB. 9-26-2006, FILED 2-23-2006.

CHOICELECT

THE MARK CONSISTS OF STANDARD CHARACTERS WITHOUT CLAIM TO ANY PARTICULAR FONT, STYLE, SIZE, OR COLOR.

FOR INSURANCE UNDERWRITING IN THE FIELD OF MORTGAGE GUARANTY INSURANCE AND INVOLUNTARY UNEMPLOYMENT INSURANCE (U.S. CLS. 100, 101 AND 102).

FIRST USE 8-31-2006; IN COMMERCE 8-31-2006.

CLASS 36—(Continued).

3,314,437. CHAPTER IV INVESTORS, LLC, CHARLOTTE, NC. SN 78-830,740. PUB. 11-14-2006, FILED 3-7-2006.

CHAPTER IV INVESTORS

THE MARK CONSISTS OF STANDARD CHARACTERS WITHOUT CLAIM TO ANY PARTICULAR FONT, STYLE, SIZE, OR COLOR.

NO CLAIM IS MADE TO THE EXCLUSIVE RIGHT TO USE "INVESTORS", APART FROM THE MARK AS SHOWN. FOR SECURITIES INVESTING AND RELATED INVESTMENT MANAGEMENT AND ADVISORY SERVICES (U.S. CLS. 100, 101 AND 102).

FIRST USE 9-18-2006; IN COMMERCE 9-18-2006.

3,314,439. SOVEREIGN BANK, WYOMISSING, PA. SN 78-831,082. PUB. 9-26-2006, FILED 3-7-2006.

SOVTRADE

THE MARK CONSISTS OF STANDARD CHARACTERS WITHOUT CLAIM TO ANY PARTICULAR FONT, STYLE, SIZE, OR COLOR.

FOR BANKING SERVICES, NAMELY, INITIATION, PROCESSING, AND REPORTING OF INTERNATIONAL BANKING TRANSACTIONS OVER THE INTERNET (U.S. CLS. 100, 101 AND 102).

FIRST USE 2-28-2004; IN COMMERCE 2-28-2004.

3,314,470. PROMONTORY INTERFINANCIAL NETWORK, LLC, ARLINGTON, VA. SN 78-839,908. PUB. 5-15-2007, FILED 3-17-2006.

IND

THE MARK CONSISTS OF STANDARD CHARACTERS WITHOUT CLAIM TO ANY PARTICULAR FONT, STYLE, SIZE, OR COLOR.

FOR FINANCIAL SERVICES, NAMELY, ASSISTING FINANCIAL INSTITUTIONS WITH THE MANAGEMENT OF DEPOSIT ACCOUNTS AND THE FACILITATING OF THE AUTOMATIC TRANSFER OF FUNDS BETWEEN FUND SOURCES AND DEPOSIT ACCOUNTS (U.S. CLS. 100, 101 AND 102).

FIRST USE 6-30-2006; IN COMMERCE 6-30-2006.

CLASS 36—(Continued).

3,314,483. CRENSHAW WHITLEY & ASSOCIATES, L.L.C., GEORGETOWN, TX. SN 78-846,672. PUB. 11-14-2006, FILED 3-27-2006.

EDUBENEFIT

THE MARK CONSISTS OF STANDARD CHARACTERS WITHOUT CLAIM TO ANY PARTICULAR FONT, STYLE, SIZE, OR COLOR.

FOR INSURANCE AGENCY AND BROKERAGE SERVICES (U.S. CLS. 100, 101 AND 102).

FIRST USE 6-1-2006; IN COMMERCE 6-1-2006.

3,314,485. PAN-AMERICAN LIFE INSURANCE COMPANY, NEW ORLEANS, LA. SN 78-846,948. PUB. 2-20-2007, FILED 3-27-2006.

PAN-AMERICAN LIFE INSURANCE GROUP

THE MARK CONSISTS OF STANDARD CHARACTERS WITHOUT CLAIM TO ANY PARTICULAR FONT, STYLE, SIZE, OR COLOR.

OWNER OF U.S. REG. NOS. 1,705,412, 2,615,927, AND OTHERS.

NO CLAIM IS MADE TO THE EXCLUSIVE RIGHT TO USE "LIFE INSURANCE GROUP", APART FROM THE MARK AS SHOWN.

SEC. 2(F) AS TO PAN-AMERICAN.

FOR INSURANCE SERVICES, NAMELY, INSURANCE, ADMINISTRATION AND UNDERWRITING IN THE FIELDS OF LIFE, HEALTH, DENTAL, AND ACCIDENT DISABILITY; AND ISSUANCE, ADMINISTRATION AND UNDERWRITING OF ANNUITIES (U.S. CLS. 100, 101 AND 102).

FIRST USE 4-1-2007; IN COMMERCE 4-1-2007.

3,314,491. BANK OF AMERICA CORPORATION, CHARLOTTE, NC. SN 78-849,697. PUB. 1-9-2007, FILED 3-30-2006.

**COLUMBIA MANAGEMENT
LEARNING CENTER**

THE MARK CONSISTS OF STANDARD CHARACTERS WITHOUT CLAIM TO ANY PARTICULAR FONT, STYLE, SIZE, OR COLOR.

OWNER OF U.S. REG. NOS. 1,397,111 AND 2,106,825.

NO CLAIM IS MADE TO THE EXCLUSIVE RIGHT TO USE "MANAGEMENT LEARNING CENTER", APART FROM THE MARK AS SHOWN.

FOR BANKING AND RELATED FINANCIAL SERVICES, NAMELY, PROVIDING FINANCIAL INFORMATION TO FINANCIAL ADVISORS AND INVESTORS (U.S. CLS. 100, 101 AND 102).

FIRST USE 1-0-2005; IN COMMERCE 1-0-2005.

CLASS 36—(Continued).

3,314,502. C & G SAVINGS BANK, ALTOONA, PA. SN 78-855,212. PUB. 1-16-2007, FILED 4-6-2006.

IN & OUT LOANS

THE MARK CONSISTS OF STANDARD CHARACTERS WITHOUT CLAIM TO ANY PARTICULAR FONT, STYLE, SIZE, OR COLOR.

NO CLAIM IS MADE TO THE EXCLUSIVE RIGHT TO USE "LOANS", APART FROM THE MARK AS SHOWN.

FOR BANKING; SAVINGS AND LOAN SERVICES (U.S. CLS. 100, 101 AND 102).

FIRST USE 4-30-2007; IN COMMERCE 4-30-2007.

3,314,503. C & G SAVINGS BANK, ALTOONA, PA. SN 78-855,221. PUB. 1-16-2007, FILED 4-6-2006.



NO CLAIM IS MADE TO THE EXCLUSIVE RIGHT TO USE "LOANS", APART FROM THE MARK AS SHOWN.

FOR BANKING; SAVINGS AND LOAN SERVICES (U.S. CLS. 100, 101 AND 102).

FIRST USE 4-30-2007; IN COMMERCE 4-30-2007.

3,314,522. STORAGE CONDOS, L.L.C., BILLINGS, MT. SN 78-862,041. PUB. 11-21-2006, FILED 4-14-2006.

ULTIMATE SPACE

THE MARK CONSISTS OF STANDARD CHARACTERS WITHOUT CLAIM TO ANY PARTICULAR FONT, STYLE, SIZE, OR COLOR.

FOR CONDOMINIUM REAL ESTATE MANAGEMENT AND CONDOMINIUM PROPERTY MANAGEMENT; REAL ESTATE MANAGEMENT SERVICES, NAMELY, MANAGEMENT OF CONDOMINIUM STORAGE UNITS (U.S. CLS. 100, 101 AND 102).

FIRST USE 5-4-2006; IN COMMERCE 5-4-2006.

CLASS 36—(Continued).

3,314,537. SUPERIOR CAPITAL PARTNERS LLC, DETROIT, MI. SN 78-868,636. PUB. 1-16-2007, FILED 4-25-2006.

THE SUPERIOR FUND, L.P.

THE MARK CONSISTS OF STANDARD CHARACTERS WITHOUT CLAIM TO ANY PARTICULAR FONT, STYLE, SIZE, OR COLOR.

NO CLAIM IS MADE TO THE EXCLUSIVE RIGHT TO USE "THE" AND "FUND, L.P.", APART FROM THE MARK AS SHOWN.

FOR INVESTMENT AND ASSET MANAGEMENT SERVICES, NAMELY, RAISING CAPITAL FROM PRIVATE AND INSTITUTIONAL SOURCES AND INVESTING THE CAPITAL IN PRIVATE AND PUBLIC COMPANIES AND BUSINESSES (U.S. CLS. 100, 101 AND 102).

FIRST USE 1-25-2007; IN COMMERCE 1-25-2007.

3,314,566. TERCET CAPITAL, LLC, SMITHFIELD, RI. SN 78-89,932. PUB. 2-27-2007, FILED 5-8-2006.

THE TERCET GROWTH SOLUTION

THE MARK CONSISTS OF STANDARD CHARACTERS WITHOUT CLAIM TO ANY PARTICULAR FONT, STYLE, SIZE, OR COLOR.

NO CLAIM IS MADE TO THE EXCLUSIVE RIGHT TO USE "GROWTH", APART FROM THE MARK AS SHOWN.

FOR FINANCIAL SERVICES, NAMELY, INVESTMENT MANAGEMENT SERVICES, FINANCIAL PLANNING SERVICES, MUTUAL FUND INVESTMENT SERVICES, SECURITIES BROKERAGE SERVICES, VARIABLE ANNUITY INVESTMENT ADVISORY SERVICES, VARIABLE LIFE INSURANCE ADVISORY SERVICES AND 401(K) INVESTMENT ADVISORY SERVICES (U.S. CLS. 100, 101 AND 102).

FIRST USE 4-1-2006; IN COMMERCE 4-1-2006.

3,314,582. JUST RIGHT REALTY CO., FORT MYERS, FL. SN 78-882,658. PUB. 1-9-2007, FILED 5-12-2006.



NO CLAIM IS MADE TO THE EXCLUSIVE RIGHT TO USE "REALTY CO.", APART FROM THE MARK AS

CLASS 36—(Continued).

SHOWN.

THE COLOR(S) BLUE AND ORANGE IS/ARE CLAIMED AS A FEATURE OF THE MARK.

THE COLORS IN THE MARK ARE BLUE AND ORANGE. THE COLOR(S) BLUE APPEARS IN THE WORDING JUST RIGHT REALTY CO.. THE COLOR(S) ORANGE APPEARS IN THE HOUSE DESIGN AND UNDERLINING.

FOR REAL ESTATE AGENCIES (U.S. CLS. 100, 101 AND 102).

FIRST USE 3-21-2005; IN COMMERCE 3-25-2005.

3,314,584. GMAC MORTGAGE LLC, WILMINGTON, DE. SN 78-883,555. PUB. 12-26-2006, FILED 5-15-2006.

REAL LIFE. REAL SOLUTIONS.

THE MARK CONSISTS OF STANDARD CHARACTERS WITHOUT CLAIM TO ANY PARTICULAR FONT, STYLE, SIZE, OR COLOR.

FOR HOME EQUITY LOANS; MORTGAGE LENDING (U.S. CLS. 100, 101 AND 102).

FIRST USE 9-0-2004; IN COMMERCE 9-0-2004.

3,314,586. HRB ROYALTY, INC., NASSAU, BAHAMAS. SN 78-883,739. PUB. 1-2-2007, FILED 5-15-2006.

SECOND LOOK CERTIFICATION

THE MARK CONSISTS OF STANDARD CHARACTERS WITHOUT CLAIM TO ANY PARTICULAR FONT, STYLE, SIZE, OR COLOR.

NO CLAIM IS MADE TO THE EXCLUSIVE RIGHT TO USE "CERTIFICATION", APART FROM THE MARK AS SHOWN.

FOR WARRANTY SERVICES, NAMELY, WARRANTING A REVIEW OF A TAX RETURN AND PROVIDING AUDIT REPRESENTATION FOR A TAX RETURN WHICH HAS BEEN REVIEWED (U.S. CLS. 100, 101 AND 102).

FIRST USE 2-19-2007; IN COMMERCE 2-19-2007.

3,314,657. THE S. HEKEMIAN GROUP, LLC, PARAMUS, NJ. SN 78-901,270. PUB. 3-13-2007, FILED 6-6-2006.

THE NEXT GREAT NEIGHBORHOOD

CLASS 36—(Continued).

THE MARK CONSISTS OF STANDARD CHARACTERS WITHOUT CLAIM TO ANY PARTICULAR FONT, STYLE, SIZE, OR COLOR.

FOR REAL ESTATE SERVICES, NAMELY, REAL ESTATE LISTING, REAL ESTATE BROKERAGE, REAL ESTATE LEASING, REAL ESTATE SALES MANAGEMENT AND MANAGEMENT OF COMMERCIAL AND RESIDENTIAL PROPERTY (U.S. CLS. 100, 101 AND 102).

FIRST USE 5-8-2006; IN COMMERCE 5-8-2006.

3,314,719. PLISE COMPANIES, LLC, LAS VEGAS, NV. SN 78-916,730. PUB. 2-13-2007, FILED 6-26-2006.

CITY CROSSING

THE MARK CONSISTS OF STANDARD CHARACTERS WITHOUT CLAIM TO ANY PARTICULAR FONT, STYLE, SIZE, OR COLOR.

FOR COMMERCIAL REAL ESTATE BROKERAGE, LEASING AND MANAGEMENT (U.S. CLS. 100, 101 AND 102).

FIRST USE 5-25-2006; IN COMMERCE 5-25-2006.

3,314,721. PERKINS, MATTHEW J., BOISE, ID. SN 78-916,846. PUB. 2-13-2007, FILED 6-26-2006.

TUBE, TROT, AND TRIKE

THE MARK CONSISTS OF STANDARD CHARACTERS WITHOUT CLAIM TO ANY PARTICULAR FONT, STYLE, SIZE, OR COLOR.

FOR CHARITABLE FUND RAISING (U.S. CLS. 100, 101 AND 102).

FIRST USE 7-31-2006; IN COMMERCE 8-31-2006.

CLASS 36—(Continued).

3,314,725. GOVERNMENT EMPLOYEES INSURANCE COMPANY, WASHINGTON, DC. SN 78-917,870. PUB. 2-20-2007, FILED 6-28-2006.

Real service. Real savings.

THE MARK CONSISTS OF STANDARD CHARACTERS WITHOUT CLAIM TO ANY PARTICULAR FONT, STYLE, SIZE, OR COLOR.

FOR INSURANCE BROKERAGE; INSURANCE UNDERWRITING SERVICES FOR ALL TYPES OF INSURANCE, INSURANCE CLAIMS PROCESSING, INSURANCE CLAIMS ADMINISTRATION, AND PROVIDING INFORMATION ABOUT INSURANCE VIA THE INTERNET; PROVIDING INSURANCE UNDERWRITING SERVICES FOR ALL TYPES OF INSURANCE VIA THE INTERNET (U.S. CLS. 100, 101 AND 102).

FIRST USE 7-27-2006; IN COMMERCE 7-27-2006.

3,314,757. FIA CARD SERVICES, NATIONAL ASSOCIATION, WILMINGTON, DE. SN 78-930,555. PUB. 3-6-2007, FILED 7-17-2006.

SHARE LIFE'S ADVENTURES

THE MARK CONSISTS OF STANDARD CHARACTERS WITHOUT CLAIM TO ANY PARTICULAR FONT, STYLE, SIZE, OR COLOR.

FOR CREDIT CARD SERVICES (U.S. CLS. 100, 101 AND 102).

FIRST USE 10-0-2006; IN COMMERCE 10-0-2006.

CLASS 36—(Continued).

3,314,760. THE PRUDENTIAL INSURANCE COMPANY OF AMERICA, NEWARK, NJ. SN 78-931,094. PUB. 1-30-2007, FILED 7-17-2006.

PRUDENTIAL INCOME FLEX

THE MARK CONSISTS OF STANDARD CHARACTERS WITHOUT CLAIM TO ANY PARTICULAR FONT, STYLE, SIZE, OR COLOR.

FOR FINANCIAL SERVICES, NAMELY, UNDERWRITING AND ADMINISTERING ANNUITIES, INSURANCE UNDERWRITING FOR ALL TYPES OF INSURANCE AND DEFINED CONTRIBUTION PLANS; INVESTMENT SERVICES, NAMELY, INVESTMENT MANAGEMENT SERVICES FOR FUNDING RETIREMENT; AND RETIREMENT SERVICES, NAMELY, INVESTMENT, PLANNING AND ADMINISTERING RETIREMENT PLANS (U.S. CLS. 100, 101 AND 102).

FIRST USE 12-13-2006; IN COMMERCE 12-13-2006.

3,314,799. AMERICAN INTERNATIONAL GROUP, INC., NEW YORK, NY. SN 78-944,427. PUB. 3-6-2007, FILED 8-3-2006.

AIG GLOBAL MARINE AND ENERGY SPECTRUM

THE MARK CONSISTS OF STANDARD CHARACTERS WITHOUT CLAIM TO ANY PARTICULAR FONT, STYLE, SIZE, OR COLOR.

OWNER OF U.S. REG. NO. 2,939,990.

NO CLAIM IS MADE TO THE EXCLUSIVE RIGHT TO USE "GLOBAL MARINE AND ENERGY", APART FROM THE MARK AS SHOWN.

FOR INSURANCE UNDERWRITING IN THE FIELD OF ALTERNATIVE RISK SOLUTIONS (U.S. CLS. 100, 101 AND 102).

FIRST USE 8-28-2006; IN COMMERCE 8-28-2006.

CLASS 36—(Continued).

3,314,813. AMERI-NATIONAL CORPORATION, OVERLAND PARK, KS. SN 78-949,536. PUB. 3-27-2007, FILED 8-10-2006.

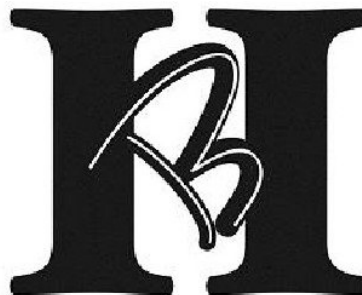

FOR BANKING SERVICES (U.S. CLS. 100, 101 AND 102).

FIRST USE 9-18-2006; IN COMMERCE 9-18-2006.

3,314,822. CHRISTENSEN, BART, SANDY, UT. SN 78-953,149. PUB. 4-10-2007, FILED 8-16-2006.



Engineering Wealth

NO CLAIM IS MADE TO THE EXCLUSIVE RIGHT TO USE "FINANCIAL ADVISORS", APART FROM THE MARK AS SHOWN.

THE MARK CONSISTS OF A RENDITION OF A CASTLE CHESS PIECE WITH AN OVAL CONTAINING THE WORDING "ENRICH FINANCIAL ADVISORS" SUPERIMPOSED AGAINST THE DESIGN OF THE CHESS PIECE AND UNDERNEATH THE DESIGN OF THE CHESS PIECE IS A LINE AND UNDERNEATH THE LINE IS THE WORDING "ENGINEERING WEALTH".

FOR ADVICE RELATING TO INVESTMENTS; FINANCIAL EVALUATION FOR INSURANCE PURPOSES; FINANCIAL SERVICES IN THE NATURE OF AN INVESTMENT SECURITY; INSURANCE CONSULTATION; INSURANCE SUBROGATION; INVESTMENT ADVICE; INVESTMENT ADVISORY SERVICES; INVESTMENT BROKERAGE; INVESTMENT CLUBS; INVESTMENT CONSULTATION; LIFE INSURANCE BROKERAGE; MUTUAL FUND INVESTMENT; PROVIDING INFORMATION IN INSURANCE MATTERS (U.S. CLS. 100, 101 AND 102).

FIRST USE 7-1-2004; IN COMMERCE 7-1-2004.

CLASS 36—(Continued).

3,314,824. FIA CARD SERVICES, NATIONAL ASSOCIATION, WILMINGTON, DE. SN 78-953,242. PUB. 2-20-2007, FILED 8-16-2006.

EMERGENCY RELIEF

THE MARK CONSISTS OF STANDARD CHARACTERS WITHOUT CLAIM TO ANY PARTICULAR FONT, STYLE, SIZE, OR COLOR.

FOR BANKING AND RELATED FINANCIAL SERVICES, NAMELY, PREPAID DEBIT CARDS (U.S. CLS. 100, 101 AND 102).

FIRST USE 10-0-2006; IN COMMERCE 10-0-2006.

3,314,829. GREATER KANSAS CITY SPORTS FOUNDATION, THE, KANSAS CITY, MO. SN 78-955,280. PUB. 4-17-2007, FILED 8-18-2006.

CHARITIX

THE MARK CONSISTS OF STANDARD CHARACTERS WITHOUT CLAIM TO ANY PARTICULAR FONT, STYLE, SIZE, OR COLOR.

FOR CHARITABLE FUND RAISING SERVICES BY MEANS OF SOLICITATION, RECEIPT AND RESALE OF DONATED TICKETS TO SPORTS AND ENTERTAINMENT EVENTS (U.S. CLS. 100, 101 AND 102).

FIRST USE 8-1-2007; IN COMMERCE 8-1-2007.

3,314,842. FEDERATED MUTUAL INSURANCE COMPANY, OWATONNA, MN. SN 78-957,244. PUB. 4-10-2007, FILED 8-22-2006.

FEDERATED CLICK 2 PAY

THE MARK CONSISTS OF STANDARD CHARACTERS WITHOUT CLAIM TO ANY PARTICULAR FONT, STYLE, SIZE, OR COLOR.

OWNER OF U.S. REG. NOS. 701,534, 2,997,739, AND OTHERS.

NO CLAIM IS MADE TO THE EXCLUSIVE RIGHT TO USE "CLICK TO PAY", APART FROM THE MARK AS SHOWN.

FOR INSURANCE SERVICES, NAMELY, PROVIDING ONLINE PAYMENT PROCESSING OF INSURANCE PREMIUMS (U.S. CLS. 100, 101 AND 102).

FIRST USE 7-17-2006; IN COMMERCE 11-1-2006.

CLASS 36—(Continued).

3,314,884. DEDHAM INSTITUTION FOR SAVINGS, DEDHAM, MA. SN 78-969,962. PUB. 4-24-2007, FILED 9-8-2006.

LIFEBANKING

THE MARK CONSISTS OF STANDARD CHARACTERS WITHOUT CLAIM TO ANY PARTICULAR FONT, STYLE, SIZE, OR COLOR.

FOR BANKING (U.S. CLS. 100, 101 AND 102).

FIRST USE 4-24-2007; IN COMMERCE 4-24-2007.

3,314,894. ST. LOUIS COMMUNITY CREDIT UNION, ST. LOUIS, MO. SN 78-972,637. PUB. 4-24-2007, FILED 9-12-2006.

HERE FOR YOU. HERE FOR LIFE.

THE MARK CONSISTS OF STANDARD CHARACTERS WITHOUT CLAIM TO ANY PARTICULAR FONT, STYLE, SIZE, OR COLOR.

FOR CREDIT UNION SERVICES (U.S. CLS. 100, 101 AND 102).

FIRST USE 1-29-2007; IN COMMERCE 1-29-2007.

CLASS 37—CONSTRUCTION AND REPAIR

3,313,286. RUBIN WELLNESS ASSETS LLC, NIWOT, CO. SN 77-017,709. PUB. 5-22-2007, FILED 10-10-2006.

XACT NATURAL PEST MANAGEMENT

THE MARK CONSISTS OF STANDARD CHARACTERS WITHOUT CLAIM TO ANY PARTICULAR FONT, STYLE, SIZE, OR COLOR.

NO CLAIM IS MADE TO THE EXCLUSIVE RIGHT TO USE "NATURAL PEST MANAGEMENT", APART FROM THE MARK AS SHOWN.

FOR PEST CONTROL SERVICES (U.S. CLS. 100, 103 AND 106).

FIRST USE 10-1-2006; IN COMMERCE 10-1-2006.

CLASS 37—(Continued).

3,313,511. ZAWADZKI, JEFFREY JOSEPH, GRAND RAPIDS, MI. SN 78-507,121. PUB. 11-1-2005, FILED 10-27-2004.



NO CLAIM IS MADE TO THE EXCLUSIVE RIGHT TO USE "BUILDERS, LLC" AND THE REPRESENTATION OF A HOUSE, APART FROM THE MARK AS SHOWN.
FOR BUILDING CONSTRUCTION (U.S. CLS. 100, 103 AND 106).

FIRST USE 1-1-2003; IN COMMERCE 5-14-2007.

3,313,561. ROEM CORPORATION, SANTA CLARA, CA. SN 78-560,385. PUB. 1-2-2007, FILED 2-3-2005.

ROEM CORPORATION

THE MARK CONSISTS OF STANDARD CHARACTERS WITHOUT CLAIM TO ANY PARTICULAR FONT, STYLE, SIZE, OR COLOR.

NO CLAIM IS MADE TO THE EXCLUSIVE RIGHT TO USE CORPORATION, APART FROM THE MARK AS SHOWN.

SEC. 2(F).

FOR CONSTRUCTION AND RENOVATION OF BUILDINGS; CONSTRUCTION OF RESIDENTIAL HOMES (U.S. CLS. 100, 103 AND 106).

FIRST USE 0-0-1978; IN COMMERCE 0-0-1978.

3,313,598. CINTAS HOLDINGS LLC, MASON, OH. SN 78-586,359. PUB. 1-2-2007, FILED 3-14-2005.

SANIS ULTRACLEAN

THE MARK CONSISTS OF STANDARD CHARACTERS WITHOUT CLAIM TO ANY PARTICULAR FONT, STYLE, SIZE, OR COLOR.

FOR RESTROOM CLEANING AND SANITIZING SERVICES FOR COMMERCIAL AND INDUSTRIAL FACILITIES (U.S. CLS. 100, 103 AND 106).

FIRST USE 3-16-2005; IN COMMERCE 3-16-2005.

CLASS 37—(Continued).

3,313,774. BON SECOUR VILLAGE, LLC, CULLMAN, AL. SN 78-665,425. PUB. 4-4-2006, FILED 7-7-2005.



FOR BUILDING CONSTRUCTION AND SITE SELECTION SERVICES (U.S. CLS. 100, 103 AND 106).
FIRST USE 5-29-2007; IN COMMERCE 5-29-2007.

3,313,886. JOHMER, INC., ST. PETERSBURG, FL. SN 78-714,446. PUB. 7-18-2006, FILED 9-16-2005.



THE MARK CONSISTS IN PART OF THE SYMBOL OF A HURRICANE WITH A STOP SIGN INSIDE.

FOR CONSTRUCTION AND RENOVATION OF BUILDINGS (U.S. CLS. 100, 103 AND 106).

FIRST USE 11-30-2005; IN COMMERCE 11-30-2005.

3,313,926. XTREME COIL DRILLING CORP., CALGARY, ALBERTA, CANADA. SN 78-732,569. PUB. 1-23-2007, FILED 10-13-2005.

XTREME COIL

THE MARK CONSISTS OF STANDARD CHARACTERS WITHOUT CLAIM TO ANY PARTICULAR FONT, STYLE, SIZE, OR COLOR.

FOR DRILLING OF EARTH BOREHOLES, NAMELY, OIL WELLS, GAS WELLS, WATER WELLS, COAL BED METHANE WELLS, DISPOSAL WELLS, OFFSET WELLS AND MINING BOREHOLES (U.S. CLS. 100, 103 AND 106).

FIRST USE 6-6-2007; IN COMMERCE 6-6-2007.

CLASS 37—(Continued).

3,313,992. HPT TA PROPERTIES TRUST, NEWTON, MA. SN 78-749,996. PUB. 8-15-2006, FILED 11-9-2005.

TA ROAD SQUAD

THE MARK CONSISTS OF STANDARD CHARACTERS WITHOUT CLAIM TO ANY PARTICULAR FONT, STYLE, SIZE, OR COLOR.

OWNER OF U.S. REG. NOS. 1,167,657, 2,709,717, AND 2,872,031.

FOR ROADSIDE ASSISTANCE SERVICES (U.S. CLS. 100, 103 AND 106).

FIRST USE 8-1-2006; IN COMMERCE 8-1-2006.

3,314,030. AWR GROUP, INC., LONG ISLAND CITY, NY. SN 78-757,858. PUB. 8-1-2006, FILED 11-20-2005.



NO CLAIM IS MADE TO THE EXCLUSIVE RIGHT TO USE "GROUP, INC.", "WATERPROOFING" AND "RESTORATION", APART FROM THE MARK AS SHOWN.

FOR CONSTRUCTION, REPAIR AND RESTORATION OF BUILDINGS (U.S. CLS. 100, 103 AND 106).

FIRST USE 11-30-2006; IN COMMERCE 11-30-2006.

CLASS 37—(Continued).

3,314,069. POINTE PEST CONTROL, L.L.C., PROVO, UT. SN 78-765,009. PUB. 1-16-2007, FILED 12-1-2005.

POINTE PEST CONTROL

THE MARK CONSISTS OF STANDARD CHARACTERS WITHOUT CLAIM TO ANY PARTICULAR FONT, STYLE, SIZE, OR COLOR.

NO CLAIM IS MADE TO THE EXCLUSIVE RIGHT TO USE "PEST CONTROL", APART FROM THE MARK AS SHOWN.

FOR PEST CONTROL AND TERMITE CONTROL SERVICES (U.S. CLS. 100, 103 AND 106).

FIRST USE 3-1-2006; IN COMMERCE 4-30-2006.

3,314,169. ADAMS-HARRIS, LORRAINE, NEW HAVEN, CT. AND HARRIS, SHAUN L., NEW HAVEN, CT. SN 78-780,116. PUB. 8-29-2006, FILED 12-23-2005.



FOR COMPUTER REPAIR AND INSTALLATION AND MAINTENANCE OF COMPUTER NETWORKS (U.S. CLS. 100, 103 AND 106).

FIRST USE 2-15-2005; IN COMMERCE 2-15-2005.

3,314,198. M REAL ESTATE, PORTLAND, ME. SN 78-785,265. PUB. 2-13-2007, FILED 1-5-2006.

REGFURD

THE MARK CONSISTS OF STANDARD CHARACTERS WITHOUT CLAIM TO ANY PARTICULAR FONT, STYLE, SIZE, OR COLOR.

FOR CLEANING OF RESIDENTIAL HOUSES (U.S. CLS. 100, 103 AND 106).

FIRST USE 12-1-2005; IN COMMERCE 7-31-2006.

CLASS 37—(Continued).

3,314,231. JUNO-LOUDOUN, LLC, NORTH PALM BEACH, FL. SN 78-791,945. PUB. 9-5-2006, FILED 1-14-2006.

CREIGHTON FARMS

THE MARK CONSISTS OF STANDARD CHARACTERS WITHOUT CLAIM TO ANY PARTICULAR FONT, STYLE, SIZE, OR COLOR.

FOR PLANNING AND LAYING OUT OF RESIDENTIAL COMMUNITIES; REAL ESTATE DEVELOPMENT (U.S. CLS. 100, 103 AND 106).

FIRST USE 3-0-2007; IN COMMERCE 3-0-2007.

3,314,295. ACU-HON CORP, LAS VEGAS, NV. SN 78-804,365. PUB. 9-26-2006, FILED 2-1-2006.

COLLISION AUTHORITY

THE MARK CONSISTS OF STANDARD CHARACTERS WITHOUT CLAIM TO ANY PARTICULAR FONT, STYLE, SIZE, OR COLOR.

NO CLAIM IS MADE TO THE EXCLUSIVE RIGHT TO USE "COLLISION", APART FROM THE MARK AS SHOWN. FOR AUTOMOBILE BODY REPAIR AND FINISHING FOR OTHERS; AUTOMOBILE REPAIR AND MAINTENANCE; CAR REPAIR AND MAINTENANCE (U.S. CLS. 100, 103 AND 106).

FIRST USE 12-1-2005; IN COMMERCE 12-1-2005.

3,314,313. LOGANENERGY CORP., ROSWELL, GA. SN 78-808,586. PUB. 2-6-2007, FILED 2-7-2006.

THE POWER OF FUEL CELLS

THE MARK CONSISTS OF STANDARD CHARACTERS WITHOUT CLAIM TO ANY PARTICULAR FONT, STYLE, SIZE, OR COLOR.

NO CLAIM IS MADE TO THE EXCLUSIVE RIGHT TO USE "FUEL CELLS", APART FROM THE MARK AS SHOWN.

FOR INSTALLATION AND MAINTENANCE OF FUEL CELLS, FUEL CELL POWER PLANTS, AND FUEL CELL PROJECTS, NAMELY, INSTALLATION AND MAINTENANCE OF ALL CIVIL, ELECTRICAL AND MECHANICAL WORKS AND INSTALLATION AND MAINTENANCE OF FUEL CELL GENERATORS THAT PROVIDE POWER AND HEAT ENERGY SERVICES TO CUSTOMER SITES (U.S. CLS. 100, 103 AND 106).

FIRST USE 1-12-2006; IN COMMERCE 3-6-2006.

CLASS 37—(Continued).

3,314,345. 670 N MICHIGAN LLC, CHICAGO, IL. SN 78-813,668. PUB. 9-26-2006, FILED 2-13-2006.

EXPECT THE EXTRAORDINARY

THE MARK CONSISTS OF STANDARD CHARACTERS WITHOUT CLAIM TO ANY PARTICULAR FONT, STYLE, SIZE, OR COLOR.

FOR REAL ESTATE DEVELOPMENT SERVICES (U.S. CLS. 100, 103 AND 106).

FIRST USE 2-28-2006; IN COMMERCE 2-28-2006.

3,314,431. ULTIMATE ACQUISITION PARTNERS, L.P., THORNTON, CO. SN 78-829,048. PUB. 9-12-2006, FILED 3-3-2006.

IT'S YOUR RIDE, DON'T SETTLE.

THE MARK CONSISTS OF STANDARD CHARACTERS WITHOUT CLAIM TO ANY PARTICULAR FONT, STYLE, SIZE, OR COLOR.

FOR AUTO INSTALLATION SERVICES, NAMELY, INSTALLATION OF ELECTRONICS IN AUTOMOBILES (U.S. CLS. 100, 103 AND 106).

FIRST USE 3-0-2006; IN COMMERCE 3-0-2006.

3,314,458. ROBERT J., WHITTINGHAM, ORANGE, CA. SN 78-835,197. PUB. 10-24-2006, FILED 3-12-2006.



FOR MOTORCYCLE CUSTOMIZATION SERVICES (U.S. CLS. 100, 103 AND 106).

FIRST USE 1-1-1984; IN COMMERCE 3-6-2007.

CLASS 37—(Continued).

3,314,705. PRIME WEST JORDANELLE, LLC, OREM, UT. SN 78-911,674. PUB. 1-30-2007, FILED 6-19-2006.

TALISMAN

THE MARK CONSISTS OF STANDARD CHARACTERS WITHOUT CLAIM TO ANY PARTICULAR FONT, STYLE, SIZE, OR COLOR.

FOR REAL ESTATE DEVELOPMENT IN THE AREA OF RESIDENTIAL COMMUNITIES; LAND DEVELOPMENT SERVICES, NAMELY, PLANNING, LAYING OUT AND CONSTRUCTION OF RESORT RESIDENTIAL COMMUNITIES (U.S. CLS. 100, 103 AND 106).

FIRST USE 10-7-2006; IN COMMERCE 10-7-2006.

3,314,720. PLISE COMPANIES, LLC, LAS VEGAS, NV. SN 78-916,755. PUB. 2-13-2007, FILED 6-26-2006.

CITY CROSSING

THE MARK CONSISTS OF STANDARD CHARACTERS WITHOUT CLAIM TO ANY PARTICULAR FONT, STYLE, SIZE, OR COLOR.

FOR REAL ESTATE DEVELOPMENT (U.S. CLS. 100, 103 AND 106).

FIRST USE 5-25-2006; IN COMMERCE 5-25-2006.

CLASS 38—COMMUNICATION

3,312,985. MARINE BOULEVARD NO. 9 CC, BLOUBERG, 7441, SOUTH AFRICA. SN 76-166,267. PUB. 2-22-2005, FILED 11-16-2000.

KLIKETY-KLIK

THE MARK CONSISTS OF STANDARD CHARACTERS WITHOUT CLAIM TO ANY PARTICULAR FONT, STYLE, SIZE, OR COLOR.

PRIORITY CLAIMED UNDER SEC. 44(D) ON SOUTH AFRICA APPLICATION NO. ZA2000/11140, FILED 6-1-2000, REG. NO. 2000/11140, DATED 6-1-2000, EXPIRES 6-1-2010.

FOR TELECOMMUNICATIONS, NAMELY, ELECTRONIC MAIL SERVICES, COMMUNICATION SERVICES BY COMPUTER TERMINALS, ELECTRONIC DATA AND DOCUMENT TRANSMISSION SERVICES VIA COMPUTER TERMINALS, AND COMPUTER AIDED TRANSMISSION OF MESSAGES AND IMAGES (U.S. CLS. 100, 101 AND 104).

FIRST USE 6-1-2002; IN COMMERCE 11-1-2006.

CLASS 38—(Continued).

3,313,288. FOX SPORTS NET, INC., LOS ANGELES, CA. SN 77-020,267. PUB. 2-13-2007, FILED 10-12-2006.



FOR TELEVISION TRANSMISSION SERVICES (U.S. CLS. 100, 101 AND 104).

FIRST USE 10-13-2006; IN COMMERCE 10-13-2006.

3,313,647. AMERICATEL CORPORATION, MIAMI, FL. SN 78-610,962. PUB. 7-11-2006, FILED 4-18-2005.

LÍNEA PAÍS AMERICATEL

THE MARK CONSISTS OF STANDARD CHARACTERS WITHOUT CLAIM TO ANY PARTICULAR FONT, STYLE, SIZE, OR COLOR.

OWNER OF U.S. REG. NOS. 1,892,369, 2,314,351, AND 2,913,762.

THE FOREIGN WORDING IN THE MARK TRANSLATES INTO ENGLISH AS LINE COUNTRY.

FOR TELECOMMUNICATION SERVICES, NAMELY LOCAL, LONG DISTANCE AND INTERNATIONAL VOICE, TEXT, FACSIMILE, VIDEO, IMAGE, DATA AND WIRELESS TRANSMISSION VIA SATELLITE, TERRESTRIAL AND UNDERSEA COMMUNICATION LINKS; TELEPHONE TELECOMMUNICATIONS SERVICES PROVIDED VIA PREPAID TELEPHONE CALLING CARDS; PROVIDING MULTIPLE USER ACCESS TO A GLOBAL COMPUTER NETWORK (U.S. CLS. 100, 101 AND 104).

FIRST USE 3-30-2005; IN COMMERCE 3-30-2005.

3,313,837. DIGITALBRIDGE COMMUNICATIONS CORP., ASHBURN, VA. SN 78-696,605. PUB. 11-28-2006, FILED 8-19-2005.



NO CLAIM IS MADE TO THE EXCLUSIVE RIGHT TO USE "COMMUNICATIONS", APART FROM THE MARK AS SHOWN.

FOR BROADBAND COMMUNICATION SERVICES OR PROVIDING MULTIPLE USER DIAL UP AND DEDICATED ACCESS TO THE INTERNET (U.S. CLS. 100, 101 AND 104).

FIRST USE 1-0-2006; IN COMMERCE 1-0-2006.

CLASS 38—(Continued).

3,313,911. VIACOM INTERNATIONAL INC., NEW YORK, NY. SN 78-725,074. PUB. 6-20-2006, FILED 10-3-2005.

ANIMATION CAPITAL OF THE
WORLD

THE MARK CONSISTS OF STANDARD CHARACTERS WITHOUT CLAIM TO ANY PARTICULAR FONT, STYLE, SIZE, OR COLOR.

FOR TELEVISION BROADCASTING SERVICES VIA CABLE, SATELLITE AND OTHER MEANS; CABLE RADIO BROADCASTING AND TRANSMISSION; MOBILE RADIO COMMUNICATION; RADIO BROADCASTING; RADIO COMMUNICATION (U.S. CLS. 100, 101 AND 104).

FIRST USE 5-9-2007; IN COMMERCE 5-9-2007.

CLASS 38—(Continued).

3,314,130. PLAYBOY ENTERPRISES INTERNATIONAL, INC., CHICAGO, IL. SN 78-774,375. PUB. 7-18-2006, FILED 12-15-2005.

PLAYBOY MOBILE TV

THE MARK CONSISTS OF STANDARD CHARACTERS WITHOUT CLAIM TO ANY PARTICULAR FONT, STYLE, SIZE, OR COLOR.

OWNER OF U.S. REG. NOS. 2,190,905, 2,894,179, AND OTHERS.

NO CLAIM IS MADE TO THE EXCLUSIVE RIGHT TO USE "MOBILE TV", APART FROM THE MARK AS SHOWN.

FOR WIRELESS COMMUNICATIONS SERVICES, NAMELY, TRANSMISSION OF GRAPHICS, VIDEOS AND TELEVISION PROGRAMS IN THE FIELD OF ADULT ENTERTAINMENT TO MOBILE TELEPHONES (U.S. CLS. 100, 101 AND 104).

FIRST USE 10-31-2006; IN COMMERCE 10-31-2006.

3,314,488. VIRGIN MOBILE USA, LLC, WARREN, NJ. SN 78-848,824. PUB. 12-5-2006, FILED 3-29-2006.

SUGAR MAMA

THE MARK CONSISTS OF STANDARD CHARACTERS WITHOUT CLAIM TO ANY PARTICULAR FONT, STYLE, SIZE, OR COLOR.

FOR TELECOMMUNICATIONS SERVICES FEATURING A BONUS INCENTIVE PROGRAM WHEREBY CONSUMERS OF A MOBILE TELEPHONE SERVICE MAY OBTAIN AIRTIME MINUTES BY REVIEWING AND RATING ADVERTISEMENTS AND MARKETING MATERIALS OR BY PARTICIPATING IN ONLINE SURVEYS (U.S. CLS. 100, 101 AND 104).

FIRST USE 6-14-2006; IN COMMERCE 6-14-2006.

3,314,021. SNAPBRIDGE SOFTWARE, INC., CARLSBAD, CA. SN 78-755,653. PUB. 7-11-2006, FILED 11-16-2005.

MOCHILA

THE MARK CONSISTS OF STANDARD CHARACTERS WITHOUT CLAIM TO ANY PARTICULAR FONT, STYLE, SIZE, OR COLOR.

THE FOREIGN WORDING IN THE MARK TRANSLATES INTO ENGLISH AS BACK PACK.

FOR ELECTRONIC DELIVERY OF IMAGES, PHOTOGRAPHS, ART, GRAPHIC IMAGES AND GRAPHIC DESIGN, CLIP ART, NEWS IMAGES, TEXT CONTENT, ILLUSTRATIONS, DIGITAL ANIMATION, VIDEO CLIPS, FILM FOOTAGE, AND AUDIO DATA VIA A GLOBAL COMPUTER NETWORK AND LOCAL AREA NETWORKS (U.S. CLS. 100, 101 AND 104).

FIRST USE 4-1-2006; IN COMMERCE 4-1-2006.

3,314,542. INLAND TELEPHONE COMPANY, ROSLYN, WA. SN 78-869,414. PUB. 11-28-2006, FILED 4-25-2006.

Your Hometown Connection

THE MARK CONSISTS OF STANDARD CHARACTERS WITHOUT CLAIM TO ANY PARTICULAR FONT, STYLE, SIZE, OR COLOR.

FOR LOCAL AND LONG DISTANCE TELEPHONE SERVICES (U.S. CLS. 100, 101 AND 104).

FIRST USE 5-10-2007; IN COMMERCE 5-10-2007.

CLASS 38—(Continued).

3,314,662. AZTECA MOBILE, L.L.C., OVERLAND PARK, KS. SN 78-902,094. PUB. 11-14-2006, FILED 6-6-2006.

CLASS 38—(Continued).

3,314,729. FRANCE, JOHN, MR., WESTLAKE, OH. SN 78-918,846. PUB. 11-21-2006, FILED 6-28-2006.

PLAN CONTACTO

THE MARK CONSISTS OF STANDARD CHARACTERS WITHOUT CLAIM TO ANY PARTICULAR FONT, STYLE, SIZE, OR COLOR.

THE FOREIGN WORDING IN THE MARK TRANSLATES INTO ENGLISH AS PLAN CONTACT.

FOR TELECOMMUNICATIONS RESELLER SERVICES, NAMELY, PROVIDING LONG DISTANCE TELECOMMUNICATION SERVICES; CELLULAR TELEPHONE AND WIRELESS BROADBAND COMMUNICATIONS SERVICES; TWO-WAY RADIO COMMUNICATIONS SERVICES; AND TELECOMMUNICATIONS SERVICES PROVIDED VIA PREPAID CALLING CARDS (U.S. CLS. 100, 101 AND 104).
FIRST USE 4-1-2007; IN COMMERCE 4-1-2007.

LOCAL CALL TO THE WORLD

THE MARK CONSISTS OF STANDARD CHARACTERS WITHOUT CLAIM TO ANY PARTICULAR FONT, STYLE, SIZE, OR COLOR.

FOR TELEPHONE COMMUNICATION SERVICES, NAMELY, LOCAL, DOMESTIC, INTERNATIONAL, AND LONG DISTANCE TELEPHONE SERVICES (U.S. CLS. 100, 101 AND 104).

FIRST USE 5-1-2005; IN COMMERCE 5-1-2005.

3,314,790. TOP SPEED INTERNET SERVICE, LLC, SPARKS, NV. SN 78-941,258. PUB. 3-13-2007, FILED 7-31-2006.

3,314,663. AZTECA MOBILE, L.L.C., OVERLAND PARK, KS. SN 78-902,104. PUB. 11-21-2006, FILED 6-6-2006.

PLAN SIN FRONTERAS

THE MARK CONSISTS OF STANDARD CHARACTERS WITHOUT CLAIM TO ANY PARTICULAR FONT, STYLE, SIZE, OR COLOR.

THE FOREIGN WORDING IN THE MARK TRANSLATES INTO ENGLISH AS PLAN WITHOUT BORDERS.

FOR TELECOMMUNICATIONS RESELLER SERVICES, NAMELY, PROVIDING LONG DISTANCE TELECOMMUNICATION SERVICES; CELLULAR TELEPHONE AND WIRELESS BROADBAND COMMUNICATIONS SERVICES; TWO-WAY RADIO COMMUNICATIONS SERVICES; AND TELECOMMUNICATIONS SERVICES PROVIDED VIA PREPAID CALLING CARDS (U.S. CLS. 100, 101 AND 104).
FIRST USE 4-1-2007; IN COMMERCE 4-1-2007.



THE COLOR(S) RED AND BLACK IS/ARE CLAIMED AS A FEATURE OF THE MARK.

THE MARK CONSISTS OF THE WORD NEXCENT WITH A STYLIZED "X". THE "X" CONSISTS OF A BLACK ARC CROSSED BY A RED STYLIZED SWOOP. THE FONT IS HESKETH FONT.

FOR BROADCASTING SERVICES AND PROVISION OF TELECOMMUNICATION ACCESS TO VIDEO AND AUDIO CONTENT PROVIDED VIA A VIDEO-ON-DEMAND SERVICE VIA THE INTERNET; COMMUNICATIONS VIA MULTINATIONAL TELECOMMUNICATION NETWORKS; DATA TRANSMISSION AND RECEPTION SERVICES VIA TELECOMMUNICATION MEANS; ELECTRONIC EXCHANGE OF DATA STORED IN DATABASES ACCESSIBLE VIA TELECOMMUNICATION NETWORKS; HIGH BIT-RATE DATA TRANSMISSION SERVICES FOR TELECOMMUNICATION NETWORK OPERATORS; LEASING OF TELECOMMUNICATION EQUIPMENT; LEASING OF TELECOMMUNICATIONS LINES; PROVIDING ACCESS TO TELECOMMUNICATION NETWORKS; PROVIDING ELECTRONIC TELECOMMUNICATION CONNECTIONS; PROVIDING TELECOMMUNICATIONS CONNECTIONS TO A GLOBAL COMPUTER NETWORK; PROVIDING THIRD PARTY USERS WITH ACCESS TO TELECOMMUNICATION INFRASTRUCTURE; RENTAL OF EQUIPMENT FOR TELECOMMUNICATIONS; RENTAL OF TELECOMMUNICATION EQUIPMENT; RENTAL OF TELECOMMUNICATION EQUIPMENT INCLUDING TELEPHONES AND FACSIMILE APPARATUS; RENTAL OF TELECOMMUNICATIONS LINES; SIGNAL TRANS-

CLASS 38—(Continued).

MISSION FOR ELECTRONIC COMMERCE VIA TELECOMMUNICATION SYSTEMS AND DATA COMMUNICATION SYSTEMS; TELECOMMUNICATION ACCESS SERVICES; TELECOMMUNICATION SERVICES IN THE FIELD OF PROVIDING LONG DISTANCE SERVICE WITH AUDIO ADVERTISING FOR OTHERS AS A COMPONENT OF THE LONG DISTANCE SERVICE; TELECOMMUNICATION SERVICES, NAMELY, CALL HUNTING; TELECOMMUNICATION SERVICES, NAMELY, LOCAL AND LONG DISTANCE TRANSMISSION OF VOICE, DATA, GRAPHICS BY MEANS OF TELEPHONE, TELEGRAPHIC, CABLE, AND SATELLITE TRANSMISSIONS; TELECOMMUNICATIONS BY E-MAIL; TELECOMMUNICATIONS CONSULTATION; TELECOMMUNICATIONS GATEWAY SERVICES; TELECOMMUNICATIONS RESELLER SERVICES, NAMELY, PROVIDING LONG DISTANCE TELECOMMUNICATION SERVICES; TELECOMMUNICATIONS ROUTING AND JUNCTION SERVICES; TRANSFER OF DATA BY TELECOMMUNICATION; TRANSFER OF DATA BY TELECOMMUNICATIONS (U.S. CLS. 100, 101 AND 104).
FIRST USE 8-1-2006; IN COMMERCE 1-1-2007.

3,314,831. VOICE GENESIS, INC., HUNTINGTON BEACH, CA. SN 78-955,779. PUB. 4-3-2007, FILED 8-18-2006.

VMOBCASTER

THE MARK CONSISTS OF STANDARD CHARACTERS WITHOUT CLAIM TO ANY PARTICULAR FONT, STYLE, SIZE, OR COLOR.

FOR COMMUNICATION SERVICES, NAMELY, TRANSMISSION OF TEXT, IMAGES, AUDIO, AND VIDEO VIA A GLOBAL COMPUTER NETWORK, MOBILE TELEPHONE OR OTHER ELECTRONIC OR DIGITAL COMMUNICATIONS NETWORK OR DEVICE; ELECTRONIC AND DIGITAL TRANSMISSION AND DELIVERY OF VOICE, DATA, TEXT, IMAGES, GRAPHICS, SIGNALS, FEEDS, NAMELY PODCASTS, AND MESSAGES VIA A GLOBAL COMPUTER NETWORK, MOBILE TELEPHONE OR OTHER ELECTRONIC OR DIGITAL COMMUNICATIONS NETWORK OR DEVICE; PROVIDING MULTIPLE-USER ACCESS VIA THE GLOBAL COMPUTER NETWORK FOR THE TRANSFER, DISSEMINATION, AND RECEPTION OF A WIDE RANGE OF INFORMATION (U.S. CLS. 100, 101 AND 104).

FIRST USE 10-13-2006; IN COMMERCE 10-13-2006.

CLASS 38—(Continued).

3,314,832. VOICE GENESIS, INC., HUNTINGTON BEACH, CA. SN 78-955,787. PUB. 4-3-2007, FILED 8-18-2006.

VMOBLOGGER

THE MARK CONSISTS OF STANDARD CHARACTERS WITHOUT CLAIM TO ANY PARTICULAR FONT, STYLE, SIZE, OR COLOR.

FOR COMMUNICATION SERVICES, NAMELY, TRANSMISSION OF TEXT, IMAGES, AUDIO, AND VIDEO VIA A GLOBAL COMPUTER NETWORK, MOBILE TELEPHONE OR OTHER ELECTRONIC OR DIGITAL COMMUNICATIONS NETWORK OR DEVICE; ELECTRONIC AND DIGITAL TRANSMISSION AND DELIVERY OF VOICE, DATA, TEXT, IMAGES, GRAPHICS, SIGNALS, FEEDS, LINKS, AND MESSAGES VIA A GLOBAL COMPUTER NETWORK, MOBILE TELEPHONE OR OTHER ELECTRONIC OR DIGITAL COMMUNICATIONS NETWORK OR DEVICE; THE TRANSFER, AND DISSEMINATION OF A WIDE RANGE OF INFORMATION VIA ELECTRONIC BULLETIN BOARDS AND WEBLOGS VIA THE GLOBAL COMPUTER NETWORK, MOBILE TELEPHONE OR OTHER ELECTRONIC OR DIGITAL COMMUNICATIONS NETWORK OR DEVICE (U.S. CLS. 100, 101 AND 104).

FIRST USE 10-11-2006; IN COMMERCE 10-11-2006.

3,314,835. TURNER NETWORK TELEVISION, INC., ATLANTA, GA. SN 78-956,240. PUB. 4-10-2007, FILED 8-21-2006.

DRAMAVISION

THE MARK CONSISTS OF STANDARD CHARACTERS WITHOUT CLAIM TO ANY PARTICULAR FONT, STYLE, SIZE, OR COLOR.

FOR TELECOMMUNICATION SERVICES, NAMELY, ELECTRONIC TRANSMISSION OF DATA, DOCUMENTS, MUSIC, VIDEOS, IMAGES, TEXT AND OTHER DATA VIA A GLOBAL COMPUTER NETWORK (U.S. CLS. 100, 101 AND 104).

FIRST USE 8-8-2006; IN COMMERCE 8-8-2006.

CLASS 38—(Continued).

3,314,895. SKYPE LIMITED, DUBLIN 2, IRELAND. SN 78-977,231. PUB. 12-26-2006, FILED 10-18-2005.

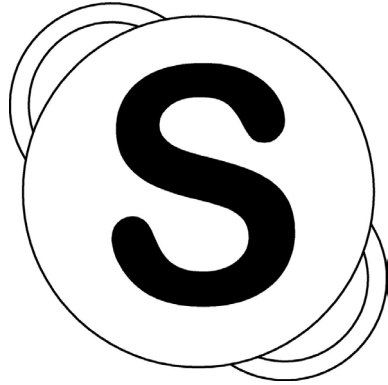

THE MARK CONSISTS OF A STYLIZED LETTER "S" WITHIN A CIRCLE, SUPERIMPOSED OVER THE DESIGN OF AN OVAL.

FOR PROVIDING VOICE OVER INTERNET PROTOCOL (VOIP) SERVICES; ELECTRONIC TRANSMISSION OF DATA AND DOCUMENTS OVER COMPUTER TERMINALS; INSTANT MESSAGING SERVICES; AND PROVIDING A HIGH SPEED ACCESS TO AREA NETWORKS AND A GLOBAL COMPUTER INFORMATION NETWORK (U.S. CLS. 100, 101 AND 104).

FIRST USE 8-29-2003; IN COMMERCE 8-29-2003.

3,314,896. SKYLIGHT HEALTHCARE SYSTEMS, INC., SAN DIEGO, CA. SN 78-977,240. PUB. 9-5-2006, FILED 5-10-2005.

SKYLIGHT

THE MARK CONSISTS OF STANDARD CHARACTERS WITHOUT CLAIM TO ANY PARTICULAR FONT, STYLE, SIZE, OR COLOR.

FOR PROVIDING A HIGH SPEED ACCESS TO AREA NETWORKS AND REMOTE INTERNET ACCESS AND ELECTRONIC MAIL SERVICES TO HEALTHCARE FACILITIES; CABLE TELEVISION AND TELEVISION BROADCASTING IN HEALTHCARE FACILITIES; PROVIDING INTERACTIVE COMMUNICATIONS SERVICES, NAMELY, ELECTRONIC MAIL SERVICES AND ELECTRONIC BULLETIN BOARDS FEATURING HEALTHCARE FACILITY INFORMATION RELATED TO PATIENTS' DISEASE STATUS, PATIENT-SPECIFIC DAILY SCHEDULES, AND DIETARY MENU SERVICES (U.S. CLS. 100, 101 AND 104).

FIRST USE 7-1-2004; IN COMMERCE 7-1-2004.

CLASS 39—TRANSPORTATION AND STORAGE**CLASS 39—(Continued).**

3,313,026. AVACUS CORPORATION, SANTA MONICA, CA. SN 76-523,356. PUB. 1-20-2004, FILED 6-18-2003.

STRATUS REWARDS

FOR AIR TRANSPORTATION SERVICES (U.S. CLS. 100 AND 105).

FIRST USE 11-30-2003; IN COMMERCE 11-30-2003.

3,313,123. TEMBIZI, INC., WEST NEWBURY, MA. SN 76-636,491. PUB. 8-8-2006, FILED 4-11-2005.

TravelGator

THE MARK CONSISTS OF STANDARD CHARACTERS WITHOUT CLAIM TO ANY PARTICULAR FONT, STYLE, SIZE, OR COLOR.

FOR TRAVEL INFORMATION SERVICES, NAMELY, PROVIDING TRAVEL PLANNING INFORMATION TO USERS OF A GLOBAL COMPUTER NETWORK, WHERE SUCH INFORMATION IS ORGANIZED BY CROSS-REFERENCING TRAVEL THEMES TO VACATION PLANNING INFORMATION (U.S. CLS. 100 AND 105).

FIRST USE 6-6-2006; IN COMMERCE 6-6-2006.

3,313,154. VALGARD OF PINECREST, LLP, MIAMI, FL. SN 76-643,889. PUB. 10-10-2006, FILED 7-29-2005.

SAVING YOU SPACE

THE MARK CONSISTS OF STANDARD CHARACTERS WITHOUT CLAIM TO ANY PARTICULAR FONT, STYLE, SIZE, OR COLOR.

FOR SELF STORAGE SERVICES; WINE STORAGE SERVICES (U.S. CLS. 100 AND 105).

FIRST USE 10-0-2005; IN COMMERCE 10-0-2005.

CLASS 39—(Continued).

3,313,534. AQUILA, INC., KANSAS CITY, MO. SN 78-533,914.
PUB. 5-2-2006, FILED 12-16-2004.

PROVIDING ENERGY
FOR BETTER LIVING

THE MARK CONSISTS OF STANDARD CHARACTERS WITHOUT CLAIM TO ANY PARTICULAR FONT, STYLE, SIZE, OR COLOR.

FOR CONSULTING SERVICES RELATING TO ENERGY DISTRIBUTION; REGULATED AND NONREGULATED UTILITY SERVICES, NAMELY, TRANSMISSION, STORAGE AND DISTRIBUTION OF ELECTRICITY AND DISTRIBUTION AND STORAGE OF NATURAL GAS; TRANSMISSION OF ELECTRICITY AND NATURAL GAS, NAMELY, A REPLACEMENT OPTION THAT PROVIDES FIXED PRICE REPLACEMENT POWER WHEN A COMPONENT FAILURE, OTHER EMERGENCY CONDITION OR A SYSTEM CONDITION PREVENTS POWER FROM BEING TRANSMITTED OVER A GIVEN PATH; TRANSMISSION OF ELECTRICITY AND NATURAL GAS, NAMELY, A REPLACEMENT OPTION THAT PROVIDES FIXED PRICE REPLACEMENT POWER WHEN A COMPONENT FAILURE OR OTHER EMERGENCY CONDITION REQUIRES A POWER-GENERATING UNIT TO BE REMOVED FROM SERVICE OR ITS GENERATING CAPACITY BE DERATED OR A SYSTEM CONDITION PREVENTS POWER FROM BEING TRANSMITTED OVER A GIVEN PATH; DELIVERY OF AND MAKING AVAILABLE FOR ACQUISITION POWER AND ITS BY-PRODUCTS FOR AND TO OTHERS, NAMELY, POWER AND ITS BY-PRODUCTS GENERATED FROM COGENERATION, DIESEL FUEL, NATURAL GAS, OIL, NATURAL GAS LIQUIDS, LIQUEFIED PETROLEUM GAS, COAL, AND RELATED ENERGY SOURCES; DISTRIBUTION OF NATURAL GAS, OIL, NATURAL GAS LIQUIDS, LIQUEFIED PETROLEUM GAS, PETROCHEMICALS TO AND FROM OTHERS (U.S. CLS. 100 AND 105).

FIRST USE 3-1-2005; IN COMMERCE 3-1-2005.

CLASS 39—(Continued).

3,313,595. MERIDIAN ENTERPRISES CORPORATION, HAZELWOOD, MO. SN 78-584,713. PUB. 9-12-2006, FILED 3-10-2005.

PASSPORT TO THE
WORLD

THE MARK CONSISTS OF STANDARD CHARACTERS WITHOUT CLAIM TO ANY PARTICULAR FONT, STYLE, SIZE, OR COLOR.

FOR PROVIDING GROUP TRAVEL INFORMATION SERVICES TO GROUP TRAVEL PLANNERS VIA A GLOBAL COMPUTER NETWORK, NAMELY, PROVIDING INFORMATION CONCERNING GROUP TRAVEL DESTINATIONS AROUND THE WORLD AND INFORMATION CONCERNING GROUP TRAVEL LODGING, ALL BASED UPON SEARCH CRITERIA CONSISTING OF GEOGRAPHIC REGION, CLIMATIC SEASON, TRAVEL BUDGET, NUMBER OF HOTEL ROOMS REQUIRED, MEETING SPACE REQUIRED, DESIRED FLIGHT TIMES AND DESIRED RECREATIONAL ACTIVITIES (U.S. CLS. 100 AND 105).

FIRST USE 5-30-2005; IN COMMERCE 6-30-2005.

3,313,829. HENDERSON, WAYNE C., DOYLESTOWN, PA. SN 78-691,272. PUB. 4-18-2006, FILED 8-12-2005.



THE COLOR(S) MAROON, GOLDEN YELLOW AND COOL GREY IS/ARE CLAIMED AS A FEATURE OF THE MARK.

THE MARK CONSISTS OF THE COLOR MAROON IN THE OVAL FADES INTO THE COLOR GOLDEN YELLOW IN THE OVAL. THE COLOR MAROON ALSO APPEARS IN THE PLANE AND THE WORD JET. THE COLOR COOL GREY APPEARS IN THE WORD THERE. THERE IS THE SHAPE OF A JET, IN MAROON COLOR, DEPARTING IN AN UPWARD DIRECTION FROM THE UPPER RIGHT SIDE OF THE OVAL.

FOR AIR TRANSPORTATION (U.S. CLS. 100 AND 105).

FIRST USE 5-31-2006; IN COMMERCE 5-31-2006.

CLASS 39—(Continued).

3,314,041. SPACE TO GO, L.P., MONONGAHELA, PA. SN 78-760,473. PUB. 7-25-2006, FILED 11-23-2005.

SPACE TO GO

THE MARK CONSISTS OF STANDARD CHARACTERS WITHOUT CLAIM TO ANY PARTICULAR FONT, STYLE, SIZE, OR COLOR.

FOR SELF STORAGE SERVICES UTILIZING TRANSPORTABLE STORAGE MODULES (U.S. CLS. 100 AND 105).

FIRST USE 12-15-2005; IN COMMERCE 12-15-2005.

3,314,363. 1-866-MR-TRASH. TORONTO, CANADA. SN 78-816,876. PUB. 2-27-2007, FILED 2-16-2006.

1-866-MR-TRASH

THE COLOR(S) RED AND PURPLE IS/ARE CLAIMED AS A FEATURE OF THE MARK.

THE WORD STRING "1-866-" IS RED AND THE WORD STRING "MR.TRASH" IS PURPLE.

FOR TRANSPORTATION AND DELIVERY SERVICES, NAMELY, SAME DAY SHIPMENT SERVICES (U.S. CLS. 100 AND 105).

FIRST USE 11-2-2006; IN COMMERCE 3-5-2007.

3,314,464. CROWN TRAVEL SERVICE, INC., BLOOMFIELD, NJ. SN 78-836,713. PUB. 10-24-2006, FILED 3-14-2006.

ABC DESTINATIONS

THE MARK CONSISTS OF STANDARD CHARACTERS WITHOUT CLAIM TO ANY PARTICULAR FONT, STYLE, SIZE, OR COLOR.

OWNER OF U.S. REG. NOS. 2,446,165, 3,086,611, AND OTHERS.

NO CLAIM IS MADE TO THE EXCLUSIVE RIGHT TO USE "DESTINATIONS", APART FROM THE MARK AS SHOWN.

FOR TRAVEL AGENCY SERVICES, NAMELY CONDUCTING AND ARRANGING TRAVEL TOURS FOR OTHERS, MAKING RESERVATIONS AND BOOKINGS FOR TRANSPORTATION, CRUISE SHIP SERVICES (U.S. CLS. 100 AND 105).

FIRST USE 7-0-2006; IN COMMERCE 7-0-2006.

CLASS 40—MATERIAL TREATMENT

CLASS 40—(Continued).

3,314,187. REBERLAND EQUIPMENT, INC., APPLE CREEK, OH. SN 78-784,528. PUB. 9-12-2006, FILED 1-4-2006.

FIROKOTE

THE MARK CONSISTS OF STANDARD CHARACTERS WITHOUT CLAIM TO ANY PARTICULAR FONT, STYLE, SIZE, OR COLOR.

FOR CUSTOM FABRICATION OF COATINGS FOR PROTECTING THE INTERIOR OF TANKERS AND ESPECIALLY WATER TANKERS (U.S. CLS. 100, 103 AND 106).

FIRST USE 1-31-2006; IN COMMERCE 1-31-2006.

3,314,241. ENERGYSOLUTIONS, LLC, SALT LAKE CITY, UT. SN 78-793,088. PUB. 3-20-2007, FILED 1-17-2006.

WE'RE PART OF THE SOLUTION

THE MARK CONSISTS OF STANDARD CHARACTERS WITHOUT CLAIM TO ANY PARTICULAR FONT, STYLE, SIZE, OR COLOR.

FOR WASTE MANAGEMENT SERVICES; NUCLEAR AND RADIOACTIVE MATERIALS WASTE MANAGEMENT SERVICES (U.S. CLS. 100, 103 AND 106).

FIRST USE 2-5-2006; IN COMMERCE 2-5-2006.

3,314,418. SAFE SHREDDING, LLC, ROSELAND, NJ. SN 78-826,665. PUB. 10-24-2006, FILED 3-1-2006.

Stop Dreading Your Shredding

THE MARK CONSISTS OF STANDARD CHARACTERS WITHOUT CLAIM TO ANY PARTICULAR FONT, STYLE, SIZE, OR COLOR.

NO CLAIM IS MADE TO THE EXCLUSIVE RIGHT TO USE "SHREDDING", APART FROM THE MARK AS SHOWN.

FOR DOCUMENT DESTRUCTION (U.S. CLS. 100, 103 AND 106).

FIRST USE 10-30-2006; IN COMMERCE 10-30-2006.

CLASS 40—(Continued).

3,314,693. PHOENIX INTANGIBLES HOLDING COMPANY, GREENVILLE, DE. SN 78-909,059. PUB. 12-19-2006, FILED 6-15-2006.

PHOTO BAR

THE MARK CONSISTS OF STANDARD CHARACTERS WITHOUT CLAIM TO ANY PARTICULAR FONT, STYLE, SIZE, OR COLOR.

NO CLAIM IS MADE TO THE EXCLUSIVE RIGHT TO USE "PHOTO", APART FROM THE MARK AS SHOWN.

FOR DIGITAL PHOTOGRAPHIC PRINT PROCESSING SERVICES (U.S. CLS. 100, 103 AND 106).

FIRST USE 7-0-2006; IN COMMERCE 7-0-2006.

CLASS 41—EDUCATION AND ENTERTAINMENT

3,313,024. HEARST COMMUNICATIONS, INC., NEW YORK, NY. SN 76-521,258. PUB. 9-7-2004, FILED 5-29-2003.

THE BEDSIDE ASTROLOGER

NO CLAIM IS MADE TO THE EXCLUSIVE RIGHT TO USE "ASTROLOGER", APART FROM THE MARK AS SHOWN.

FOR ENTERTAINMENT SERVICES IN THE NATURE OF INTERACTIVE PRE-RECORDED TELEPHONE MESSAGES ABOUT ASTROLOGY (U.S. CLS. 100, 101 AND 107).

FIRST USE 12-2-2006; IN COMMERCE 12-2-2006.

3,313,064. GRYGOROVYCH, SERGIY, KYIV 04211, UKRAINE. SN 76-605,648. PUB. 11-1-2005, FILED 8-4-2004.

S.T.A.L.K.E.R.: SHADOW OF CHERNOBYL

THE MARK CONSISTS OF STANDARD CHARACTERS WITHOUT CLAIM TO ANY PARTICULAR FONT, STYLE, SIZE, OR COLOR.

NO CLAIM IS MADE TO THE EXCLUSIVE RIGHT TO USE "CHERNOBYL", APART FROM THE MARK AS SHOWN.

FOR ENTERTAINMENT SERVICES, NAMELY, PROVIDING ON-LINE COMPUTER GAMES, PRERECORDED MUSIC AND MUSIC INFORMATION VIA A GLOBAL COMPUTER NETWORK AND WIRELESS DEVICES; PROVIDING INFORMATION RELATING TO COMPUTER GAMES, ELECTRONIC GAMES, AND COMPUTER GAME SOFTWARE; PROVIDING INFORMATION SERVICES RELATING TO ENTERTAINMENT MEDIA, NAMELY, VIDEO GAMES, MOTION PICTURES, TELEVISION AND MUSIC; PROVIDING ENTERTAINMENT-RELATED INFORMATION ON-LINE FROM COMPUTER DATABASES ON THE INTERNET; RENTAL OF VIDEO GAMES, COMPUTER GAME SOFTWARE, ELECTRONIC GAMES, VIDEO GAME PLAYERS, INTERACTIVE GAME SOFTWARE (U.S. CLS. 100, 101 AND 107).

FIRST USE 2-2-2007; IN COMMERCE 2-2-2007.

CLASS 41—(Continued).

3,313,067. INDEPENDENT DISTRIBUTORS ASSOCIATION, LLC, COLUMBIA, SC. SN 76-606,360. PUB. 11-8-2005, FILED 8-9-2004.

IDEACOM UNIVERSITY

THE MARK CONSISTS OF STANDARD CHARACTERS WITHOUT CLAIM TO ANY PARTICULAR FONT, STYLE, SIZE, OR COLOR.

OWNER OF U.S. REG. NOS. 2,509,085 AND 2,596,796.

NO CLAIM IS MADE TO THE EXCLUSIVE RIGHT TO USE "UNIVERSITY", APART FROM THE MARK AS SHOWN.

FOR EDUCATIONAL SERVICES NAMELY PROVIDING COURSES OF INSTRUCTION FOR MARKETING, INSTALLING, MAINTAINING AND UPDATING TELECOMMUNICATIONS SYSTEMS (U.S. CLS. 100, 101 AND 107).

FIRST USE 10-10-2005; IN COMMERCE 10-11-2005.

3,313,085. B.L.P. INTERNATIONAL, INC., PHILADELPHIA, PA. SN 76-621,964. PUB. 8-15-2006, FILED 11-23-2004.



THE MARK SPELLS OUT THE WORDS "LIVING LIFE IN THE ZONE" AND CONSISTS OF A LETTER "Z" HAVING THE TOP EDGE CURVING COUNTER-CLOCKWISE INTO A SEMI-CIRCLE ENVELOPING THE "Z", SUPERIMPOSED ON TOP OF THE "Z" IS THE LETTER "O". NEXT TO THE "O" ARE THE LETTERS "N" AND "E". ABOVE THIS DRAWING, ON A CURVED ANGLE, THE WORDS "LIVING LIFE IN THE..." ARE WRITTEN.

FOR EDUCATIONAL SERVICES, NAMELY, CONDUCTING SEMINARS, CLASSES AND WORKSHOPS IN THE AREA OF MOTIVATION, INSPIRATION, AND SPIRITUAL PERSONAL AND PROFESSIONAL DEVELOPMENT; CHARITABLE SERVICES, NAMELY, MENTORING OF SCHOOL AGE CHILDREN IN THE AREA OF MOTIVATION, INSPIRATION, AND SPIRITUAL PERSONAL DEVELOPMENT TO IMPROVE ACADEMIC PERFORMANCE; CONDUCTING WORKSHOPS AND SEMINARS IN PERSONAL AWARENESS; CONDUCTING WORKSHOPS AND SEMINARS IN SELF AWARENESS; CONDUCTING WORKSHOPS AND SEMINARS IN THE AREA OF MOTIVATION, INSPIRATION, AND SPIRITUAL PERSONAL AND PROFESSIONAL DEVELOPMENT; DANCE STUDIOS; EDUCATIONAL SERVICES, NAMELY, ONE-ON-ONE MENTORING IN THE FIELD OF MOTIVATION, INSPIRATION, AND SPIRITUAL PERSONAL DEVELOPMENT TO IMPROVE ACADEMIC PERFORMANCE; PERSONAL COACHING SERVICES IN THE FIELD OF MOTIVATION, INSPIRA-

CLASS 41—(Continued).

TION, AND SPIRITUAL PERSONAL AND PROFESSIONAL DEVELOPMENT; PUBLICATION OF BOOKS, MAGAZINES, JOURNALS, NEWSPAPERS, PERIODICALS, CATALOGUES, MANUALS AND BROCHURES IN THE AREA OF MOTIVATION, INSPIRATION AND SPIRITUAL PERSONAL AND PROFESSIONAL DEVELOPMENT; PUBLISHING OF ELECTRONIC PUBLICATIONS IN THE NATURE OF NEWSLETTERS IN THE AREA OF MOTIVATION, INSPIRATION AND SPIRITUAL PERSONAL AND PROFESSIONAL DEVELOPMENT; RELIGIOUS INSTRUCTION SERVICES, TEACHING AT ELEMENTARY SCHOOLS IN THE AREA OF MOTIVATION, INSPIRATION, AND SPIRITUAL PERSONAL DEVELOPMENT TO IMPROVE ACADEMIC PERFORMANCE; TEACHING AT JUNIOR HIGH SCHOOLS IN THE AREA OF MOTIVATION, INSPIRATION, AND SPIRITUAL PERSONAL DEVELOPMENT TO IMPROVE ACADEMIC PERFORMANCE; TEACHING IN THE FIELD OF MOTIVATION, INSPIRATION AND SPIRITUAL PERSONAL AND PROFESSIONAL DEVELOPMENT (U.S. CLS. 100, 101 AND 107).

FIRST USE 12-1-2004; IN COMMERCE 12-1-2004.

3,313,086. GRANTHAM EDUCATION CORPORATION, SLIDELL, LA. SN 76-622,271. PUB. 2-21-2006, FILED 11-26-2004.

GRANTHAM UNIVERSITY ONLINE

THE MARK CONSISTS OF STANDARD CHARACTERS WITHOUT CLAIM TO ANY PARTICULAR FONT, STYLE, SIZE, OR COLOR.

NO CLAIM IS MADE TO THE EXCLUSIVE RIGHT TO USE "UNIVERSITY ONLINE", APART FROM THE MARK AS SHOWN.

FOR EDUCATIONAL SERVICES, PROVIDING ACCREDITED AND CERTIFIED COURSES OF INSTRUCTION AT THE POST-SECONDARY AND COLLEGE LEVEL (U.S. CLS. 100, 101 AND 107).

FIRST USE 5-1-2007; IN COMMERCE 5-1-2007.

3,313,145. LEAVITT, CAROLYN R., MIAMI, FL. SN 76-641,585. PUB. 9-5-2006, FILED 6-24-2005.



FOR EDUCATIONAL SERVICES, NAMELY PROVIDING LECTURES, CONSULTATIONS, GROUPS, AND SEMINARS IN THE FIELDS OF PSYCHIATRY, PSYCHOANALYSIS, AND MENTAL HEALTH RELATING TO CHILDREN, ADOLESCENTS AND ADULTS (U.S. CLS. 100, 101 AND 107).

FIRST USE 12-31-2005; IN COMMERCE 9-30-2006.

CLASS 41—(Continued).

3,313,197. SUMMIT SPORTS, INC., FORT WAYNE, IN. SN 76-656,420. PUB. 3-27-2007, FILED 3-10-2006.

THE MARK CONSISTS OF STANDARD CHARACTERS WITHOUT CLAIM TO ANY PARTICULAR FONT, STYLE, SIZE, OR COLOR.

FOR ENTERTAINMENT SERVICES, NAMELY, ORGANIZING AND CONDUCTING PROFESSIONAL SPORTING EVENTS IN THE FORM OF HOCKEY GAMES AND EXHIBITIONS (U.S. CLS. 100, 101 AND 107).

FIRST USE 6-20-2007; IN COMMERCE 6-20-2007.

3,313,211. SUTTON, JOSEPH, WEST HOLLYWOOD, CA. SN 76-661,499. PUB. 1-16-2007, FILED 6-6-2006.

THE HEART OF HOLLYWOOD

THE MARK CONSISTS OF STANDARD CHARACTERS WITHOUT CLAIM TO ANY PARTICULAR FONT, STYLE, SIZE, OR COLOR.

OWNER OF U.S. REG. NO. 2,283,293.

NO CLAIM IS MADE TO THE EXCLUSIVE RIGHT TO USE "HOLLYWOOD", APART FROM THE MARK AS SHOWN.

FOR ENTERTAINMENT SERVICES IN THE NATURE OF TELEVISION SERIES, NAMELY A TALK SHOW PROGRAM VIA TELEVISION AND A GLOBAL COMPUTER NETWORK (U.S. CLS. 100, 101 AND 107).

FIRST USE 4-22-2006; IN COMMERCE 4-22-2006.

3,313,212. ULTRAECHO, LTD., ROCHESTER, MN. SN 76-661,592. PUB. 12-5-2006, FILED 6-15-2006.

**CARDIOVASCULAR ULTRASOUND:
FROM PICTURES TO INFORMATION**

THE MARK CONSISTS OF STANDARD CHARACTERS WITHOUT CLAIM TO ANY PARTICULAR FONT, STYLE, SIZE, OR COLOR.

NO CLAIM IS MADE TO THE EXCLUSIVE RIGHT TO USE "CARDIOVASCULAR ULTRASOUND", APART FROM THE MARK AS SHOWN.

FOR EDUCATIONAL SERVICES, NAMELY, CONDUCTING CONFERENCES, CLASSES, SEMINARS AND WORKSHOPS INCIDENT TO TRAINING IN THE FIELD OF CARDIOLOGY (U.S. CLS. 100, 101 AND 107).

FIRST USE 7-6-2006; IN COMMERCE 7-6-2006.

CLASS 41—(Continued).

3,313,260. HELIUM ENTERTAINMENT ASSOCIATES LLC, ANDOVER, MA. SN 77-006,842. PUB. 5-8-2007, FILED 9-25-2006.

OurStage

THE MARK CONSISTS OF STANDARD CHARACTERS WITHOUT CLAIM TO ANY PARTICULAR FONT, STYLE, SIZE, OR COLOR.

FOR ENTERTAINMENT SERVICES NAMELY PROVIDING A WEBSITE FEATURING, PHOTOGRAPHIC, AUDIO, VIDEO AND PROSE PRESENTATIONS FEATURING THE FINE ARTS (U.S. CLS. 100, 101 AND 107). FIRST USE 2-10-2007; IN COMMERCE 2-24-2007.

3,313,265. GNLV CORP., LAS VEGAS, NV. SN 77-007,994. PUB. 4-24-2007, FILED 9-26-2006.



The Tank
THE POOL AT THE GOLDEN NUGGET

NO CLAIM IS MADE TO THE EXCLUSIVE RIGHT TO USE "TANK", APART FROM THE MARK AS SHOWN.

THE MARK CONSISTS OF THE WORDS "THE TANK" SEPARATED BY A PICTURE OF A SHARK INSIDE A CIRCLE, OVER A LINE. UNDER THE LINE ARE THE WORDS "THE POOL AT THE GOLDEN NUGGET".

FOR ENTERTAINMENT SERVICES IN THE NATURE OF AN AQUARIUM; PROVIDING SWIMMING POOLS (U.S. CLS. 100, 101 AND 107).

FIRST USE 10-15-2006; IN COMMERCE 10-15-2006.

3,313,279. NORTH TEXAS PUBLIC BROADCASTING, INC., DALLAS, TX. SN 77-015,135. PUB. 5-15-2007, FILED 10-5-2006.

THINK

THE MARK CONSISTS OF STANDARD CHARACTERS WITHOUT CLAIM TO ANY PARTICULAR FONT, STYLE, SIZE, OR COLOR.

FOR RADIO ENTERTAINMENT SERVICES, NAMELY RADIO PROGRAMS FEATURING PERFORMANCES BY A RADIO PERSONALITY (U.S. CLS. 100, 101 AND 107). FIRST USE 11-6-2006; IN COMMERCE 11-6-2006.

CLASS 41—(Continued).

3,313,316. HC LANGUAGE SOLUTIONS, INC., FOSTER CITY, CA. SN 77-033,427. PUB. 5-8-2007, FILED 10-31-2006.

hc language solutions

THE MARK CONSISTS OF STANDARD CHARACTERS WITHOUT CLAIM TO ANY PARTICULAR FONT, STYLE, SIZE, OR COLOR.

NO CLAIM IS MADE TO THE EXCLUSIVE RIGHT TO USE "LANGUAGE", APART FROM THE MARK AS SHOWN.

FOR TRANSLATION SERVICES AND LANGUAGE TRANSLATION SERVICES (U.S. CLS. 100, 101 AND 107). FIRST USE 10-20-2006; IN COMMERCE 10-20-2006.

3,313,320. ADVANCED FITNESS TECHNOLOGIES LLC, WELLESLEY, MA. SN 77-036,346. PUB. 6-5-2007, FILED 11-3-2006.

THE BODY YOU LOVE, THE BODY YOU DESERVE

THE MARK CONSISTS OF STANDARD CHARACTERS WITHOUT CLAIM TO ANY PARTICULAR FONT, STYLE, SIZE, OR COLOR.

FOR CONDUCTING WORKSHOPS AND SEMINARS IN PERSONAL AWARENESS; CONDUCTING WORKSHOPS AND SEMINARS IN SELF AWARENESS; ENCOURAGING AMATEUR SPORTS AND PHYSICAL EDUCATION BY ORGANIZING, PROMOTING, SPONSORING, SANCTIONING, CONDUCTING, ADMINISTERING, REGULATING AND GOVERNING AMATEUR ATHLETIC PROGRAMS AND ACTIVITIES; GYMNASIUMS; HEALTH CLUB SERVICES, NAMELY PROVIDING INSTRUCTION AND EQUIPMENT IN THE FIELD OF PHYSICAL EXERCISE; OPERATION OF SPORTS CAMPS; PERSONAL TRAINER SERVICES; PERSONAL TRAINING SERVICES, NAMELY, STRENGTH AND CONDITIONING TRAINING; PHYSICAL EDUCATION SERVICES; PHYSICAL FITNESS CONDITIONING CLASSES; PHYSICAL FITNESS CONSULTATION; PHYSICAL FITNESS INSTRUCTION; PROVIDING A WEBSITE FEATURING SPORTING INFORMATION; PROVIDING AN ON-LINE COMPUTER DATABASE FEATURING INFORMATION REGARDING EXERCISE AND FITNESS BEFORE AND AFTER PREGNANCY; PROVIDING FACILITIES FOR RECREATION ACTIVITIES; PROVIDING FACILITIES FOR SPORTS TOURNAMENTS; PROVIDING FITNESS AND EXERCISE FACILITIES; PROVIDING GYMNASIUMS; PROVIDING GYMNASIUMS; PROVIDING INFORMATION AND INSTRUCTION IN THE FIELD OF TRIATHLON EVENTS; PROVIDING INFORMATION IN THE FIELD OF EXERCISE TRAINING; PROVIDING SPORTS FACILITIES; PROVIDING SPORTS INFORMATION BY MEANS OF TELEPHONE PRERECORDED MESSAGES; PROVIDING VARIOUS FACILITIES FOR AN ARRAY OF SPORTING EVENTS, SPORTS AND ATHLETIC COMPETITIONS AND AWARDS PROGRAMMES; TRAINING IN THE USE AND OPERATION OF FITNESS EQUIPMENT AND FACILITIES (U.S. CLS. 100, 101 AND 107).

FIRST USE 5-1-2007; IN COMMERCE 5-1-2007.

CLASS 41—(Continued).

3,313,412. BESCHEN, MICHELE D, VAN METER, IA. SN 78-340,784. PUB. 1-4-2005, FILED 12-15-2003.

Michele Beschen's
Courage to Create

THE MARK CONSISTS OF STANDARD CHARACTERS WITHOUT CLAIM TO ANY PARTICULAR FONT, STYLE, SIZE, OR COLOR.

FOR ENTERTAINMENT AND EDUCATIONAL SERVICES IN THE NATURE OF AN ON-GOING TELEVISION PROGRAM IN THE FIELD OF CREATIVITY COVERING HOME AND GARDEN, LIFESTYLE, BUSINESS, ENTERTAINING, HOW-TO APPLICATIONS, WEDDINGS, COOKING, WOODWORKING, PAINTING, HOLIDAY PLANNING, PERSONAL APPEARANCES, AUDIO/VIDEO AND PRINT MEDIA (U.S. CLS. 100, 101 AND 107).

FIRST USE 12-15-2003; IN COMMERCE 12-15-2003.

3,313,415. OLYMPUS AMERICA, INC., CENTER VALLEY, PA. SN 78-348,853. PUB. 2-7-2006, FILED 1-7-2004.

ENVISION YOUR
WORLD

THE MARK CONSISTS OF STANDARD CHARACTERS WITHOUT CLAIM TO ANY PARTICULAR FONT, STYLE, SIZE, OR COLOR.

FOR PROVIDING ONLINE INFORMATION IN THE FIELD OF DIGITAL IMAGING AND PHOTOGRAPHY (U.S. CLS. 100, 101 AND 107).

FIRST USE 1-31-2004; IN COMMERCE 1-31-2004.

CLASS 41—(Continued).

3,313,421. PALO CREATIVE, LLP, BOARDMAN, OH. SN 78-360,647. PUB. 1-31-2006, FILED 1-31-2004.



THE COLOR(S) RED, GREEN AND BLACK IS/ARE CLAIMED AS A FEATURE OF THE MARK.

THE MARK CONSISTS OF A GUN SIGHT OR SCOPE WITH THE INTERIOR CIRCLE IN RED, THE EXTERIOR CIRCLE IN GREEN AND THE STRAIGHT LINES AND RECTANGULAR BLOCK IN BLACK. THE WORD "OUTDOOR" APPEARS IN GREEN LETTERS, AS DO THE DOTS BETWEEN THE LETTERS IN THE WORD "ICON." THE LETTERS IN THE WORD "ICON" ARE IN BLACK.

FOR ENTERTAINMENT SERVICES, NAMELY, A RADIO AND TELEVISION PROGRAM BROADCAST FROM OUTDOORS CONCERNING OUTDOOR SPORTS AND HOBBIES, NATURE TOPICS, AND ENVIRONMENTAL ISSUES (U.S. CLS. 100, 101 AND 107).

FIRST USE 2-1-2000; IN COMMERCE 2-1-2000.

3,313,441. GEMSTONE TECHNOLOGIES, INC., SOUTHAMPTON, NJ. SN 78-398,305. PUB. 2-7-2006, FILED 4-7-2004.

EXPLORATECH

THE MARK CONSISTS OF STANDARD CHARACTERS WITHOUT CLAIM TO ANY PARTICULAR FONT, STYLE, SIZE, OR COLOR.

FOR PROVIDING INTERACTIVE EXPLORATION, ENTERTAINMENT, AND EDUCATION SERVICES, NAMELY PROVIDING CLASSES, TUTORING SESSIONS, AND OTHER EDUCATIONAL PROGRAMS IN THE AREAS OF ROBOTICS, COMPUTER-BASED DIGITAL MUSIC AND SOUND EFFECTS, COMPUTER-BASED DIGITAL MOVIE MAKING, COMPUTER-BASED DIGITAL CARTOONING, COMPUTER-BASED DIGITAL ART AND PHOTOGRAPHY, COMPUTER-BASED VIRTUAL REALITY, COMPUTER-BASED GESTURE RECOGNITION, COMPUTER-BASED GAMES, COMPUTER PROGRAMMING, AND COMPUTER WEB SITE DESIGN FOR PEOPLE OF ALL AGES; ORGANIZING AND CONDUCTING CHILDREN'S PARTIES; ORGANIZING AND CONDUCTING CHILDREN'S ENTERTAINMENT EVENTS (U.S. CLS. 100, 101 AND 107).

FIRST USE 3-24-2007; IN COMMERCE 3-24-2007.

CLASS 41—(Continued).

3,313,446. PEACEWORKS FOUNDATION, NEW YORK, NY.
SN 78-404,817. PUB. 9-5-2006, FILED 4-20-2004.

ONE VOICE

THE MARK CONSISTS OF STANDARD CHARACTERS WITHOUT CLAIM TO ANY PARTICULAR FONT, STYLE, SIZE, OR COLOR.

FOR ORGANIZING CULTURAL AND EDUCATIONAL EVENTS AND PROGRAMS, NAMELY CLASSES, SEMINARS, CONFERENCES, WORKSHOPS, AND KIOSKS TO INCREASE AWARENESS ABOUT PEACE INITIATIVES AND TO PROMOTE TOLERANCE AND PEACEFUL COEXISTENCE (U.S. CLS. 100, 101 AND 107).

FIRST USE 8-0-2002; IN COMMERCE 8-0-2002.

3,313,453. BESSELLIEU, LINDA, FREEPORT, NY. SN 78-426,956. PUB. 5-24-2005, FILED 5-28-2004.

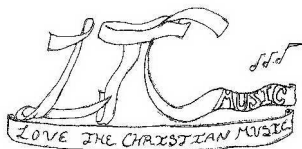

NO CLAIM IS MADE TO THE EXCLUSIVE RIGHT TO USE "CHRISTIAN MUSIC", APART FROM THE MARK AS SHOWN.

FOR RECORD PRODUCTION SERVICES (U.S. CLS. 100, 101 AND 107).

FIRST USE 7-9-2004; IN COMMERCE 7-9-2004.

3,313,475. SUNKIST GROWERS, INC., SHERMAN OAKS, CA. SN 78-461,390. PUB. 1-9-2007, FILED 8-3-2004.

SUNKIST CITRUS CÉLÉBRÉ

THE MARK CONSISTS OF STANDARD CHARACTERS WITHOUT CLAIM TO ANY PARTICULAR FONT, STYLE, SIZE, OR COLOR.

OWNER OF U.S. REG. NOS. 72,087, 2,858,174, AND OTHERS.

NO CLAIM IS MADE TO THE EXCLUSIVE RIGHT TO USE "CITRUS", APART FROM THE MARK AS SHOWN.

THE FOREIGN WORDING IN THE MARK TRANSLATES INTO ENGLISH AS "CELEBRATED".

FOR EDUCATIONAL SERVICES, NAMELY, CONDUCTING CONFERENCES IN THE FIELD OF COOKERY UTILIZING FRUIT; AND THE DISTRIBUTION OF PRINTED MATERIALS THEREWITH (U.S. CLS. 100, 101 AND 107).

FIRST USE 1-31-2006. THE MARK WAS FIRST USED ANYWHERE IN A DIFFERENT FORM OTHER THAN THAT SOUGHT TO BE REGISTERED ON 11/01/2001.; IN COMMERCE 1-31-2006. THE MARK WAS FIRST USED IN COMMERCE IN A DIFFERENT FORM OTHER THAN THAT SOUGHT TO BE REGISTERED ON 03/18/2002..

CLASS 41—(Continued).

3,313,523. OUTDOOR LIFE NETWORK, L.L.C., STAMFORD, CT. SN 78-519,374. PUB. 3-7-2006, FILED 11-18-2004.



OWNER OF U.S. REG. NOS. 2,464,289, 2,522,255, AND 2,872,255.

NO CLAIM IS MADE TO THE EXCLUSIVE RIGHT TO USE "GAMES", APART FROM THE MARK AS SHOWN.

THE MARK CONSISTS OF A STYLIZED LETTER "G" TURNED SIDWAYS WITH THE WORDS GRAVITY GAMES BELOW IT. THE ARROW IN THE STYLIZED "G" SERVES AS THE "V" IN THE WORD GRAVITY.

FOR ENTERTAINMENT SERVICES IN THE NATURE OF ON-GOING TELEVISION PROGRAMS IN THE FIELD OF EXTREME SPORTS EXHIBITIONS AND COMPETITIONS; PRODUCTION AND DISTRIBUTION OF SAME TELEVISION PROGRAMS; PROVIDING INFORMATION AND ENTERTAINMENT VIA A GLOBAL COMPUTER NETWORK, NAMELY, SCHEDULES, SYNOPSIS, PHOTOGRAPHS, VIDEO CLIPS AND INTERVIEWS, ALL RELATED TO SAME TELEVISION PROGRAMS (U.S. CLS. 100, 101 AND 107).

FIRST USE 5-0-1999; IN COMMERCE 5-0-1999.

3,313,547. SWINMURN VENTURES LLC, HENDERSON, NV. SN 78-542,860. PUB. 7-25-2006, FILED 1-5-2005.

speed quarters

THE MARK CONSISTS OF STANDARD CHARACTERS WITHOUT CLAIM TO ANY PARTICULAR FONT, STYLE, SIZE, OR COLOR.

NO CLAIM IS MADE TO THE EXCLUSIVE RIGHT TO USE "QUARTERS", APART FROM THE MARK AS SHOWN.

FOR ENTERTAINMENT SERVICES IN THE NATURE OF CONDUCTING AND ORGANIZING AN EXHIBIT IN THE NATURE OF GAME OF SKILL EVENTS USING A "QUARTER" COIN, RENDERED LIVE; PRODUCTION OF CABLE TELEVISION PROGRAM IN THE NATURE OF A COIN GAME; AND ENTERTAINMENT SERVICES, NAMELY, PROVIDING AN ON-LINE COMPUTER GAME IN THE FIELD OF GAME OF SKILLS USING A COIN (U.S. CLS. 100, 101 AND 107).

FIRST USE 3-1-2007; IN COMMERCE 3-1-2007.

CLASS 41—(Continued).

3,313,597. THE MCGRAW-HILL COMPANIES, INC., NEW YORK, NY. SN 78-585,648. PUB. 3-7-2006, FILED 3-11-2005.

STUDY CENTRAL

THE MARK CONSISTS OF STANDARD CHARACTERS WITHOUT CLAIM TO ANY PARTICULAR FONT, STYLE, SIZE, OR COLOR.

NO CLAIM IS MADE TO THE EXCLUSIVE RIGHT TO USE "STUDY", APART FROM THE MARK AS SHOWN.

FOR EDUCATIONAL SERVICES, NAMELY, PROVIDING AN ONLINE HOMEWORK TUTORIAL FOR STUDENTS IN GRADES 6-12 IN THE FIELDS OF LANGUAGE ARTS, READING, LITERATURE, MATH, SCIENCE, SOCIAL STUDIES, WORLD LANGUAGES, ART, MUSIC, HEALTH, BUSINESS, MARKETING, CAREERS, COMPUTER EDUCATION, FAMILY AND CONSUMER SCIENCES, AND TRADE AND TECHNOLOGY (U.S. CLS. 100, 101 AND 107).

FIRST USE 10-0-2004; IN COMMERCE 10-0-2004.

3,313,629. ATTLEBORO MUSEUM, INC., ATTLEBORO, MA. SN 78-606,650. PUB. 7-18-2006, FILED 4-12-2005.

**ATTLEBORO
ARTS MUSEUM**

NO CLAIM IS MADE TO THE EXCLUSIVE RIGHT TO USE "ATTLEBORO ARTS MUSEUM", APART FROM THE MARK AS SHOWN.

THE MARK CONSISTS OF THE STYLIZED LETTERS "A", "A", AND "M", AS WELL AS THE WORDS ATTLEBORO ARTS MUSEUM.

FOR OPERATION OF AN ART MUSEUM; ART EXHIBITIONS; MUSEUM SERVICES; PROVIDING GUIDED MUSEUM TOURS; CONDUCTING ENTERTAINMENT EXHIBITIONS IN THE FIELD OF THE VISUAL AND PERFORMING ARTS; ENTERTAINMENT EXHIBITIONS IN THE NATURE OF ART FESTIVALS; EDUCATIONAL AND ENTERTAINMENT SERVICES, NAMELY, PROVIDING COURSES OF INSTRUCTION, CLASSES, SEMINARS AND LECTURES IN THE FIELD OF ART, AND PROVIDING LIVE DANCE, MUSICAL AND DRAMATIC PERFORMANCES IN THE FIELD OF THE VISUAL AND PERFORMING ARTS (U.S. CLS. 100, 101 AND 107).

FIRST USE 9-28-2005; IN COMMERCE 9-28-2005.

CLASS 41—(Continued).

3,313,650. ARCATI, ANTHONY, GLEN COVE, NY. SN 78-613,189. PUB. 8-29-2006, FILED 4-20-2005.

Mystery Sound Records

THE MARK CONSISTS OF STANDARD CHARACTERS WITHOUT CLAIM TO ANY PARTICULAR FONT, STYLE, SIZE, OR COLOR.

NO CLAIM IS MADE TO THE EXCLUSIVE RIGHT TO USE "SOUND RECORDS", APART FROM THE MARK AS SHOWN.

FOR MUSIC PUBLISHING AND PRODUCTION SERVICES (U.S. CLS. 100, 101 AND 107).

FIRST USE 9-0-2005; IN COMMERCE 9-0-2005.

3,313,652. CALIFORNIA WESTERN SCHOOL OF LAW, SAN DIEGO, CA. SN 78-614,814. PUB. 7-18-2006, FILED 4-22-2005.

**CALIFORNIA WESTERN
SCHOOL OF LAW | San Diego**

NO CLAIM IS MADE TO THE EXCLUSIVE RIGHT TO USE CALIFORNIA, SCHOOL OF LAW, AND SAN DIEGO, APART FROM THE MARK AS SHOWN.

FOR EDUCATIONAL SERVICES, NAMELY, CONDUCTING CLASSES, SEMINARS, CONFERENCES AND WORKSHOPS IN THE FIELD OF LEGAL EDUCATION; PROVIDING POST-GRADUATE EDUCATIONAL CLASSES, COURSES OF INSTRUCTION, SEMINARS, CONFERENCES AND WORKSHOPS IN THE FIELD OF LAW; LAW SCHOOL ALUMNI PROGRAMS AND SERVICES, NAMELY, SPORTING AND CULTURAL EVENTS FOR LAW SCHOOL ALUMNI (U.S. CLS. 100, 101 AND 107).

FIRST USE 5-2-2005; IN COMMERCE 5-2-2005.

3,313,660. RADIO LOTTERY, INC., AURORA, CO. SN 78-617,876. PUB. 1-24-2006, FILED 4-27-2005.



NO CLAIM IS MADE TO THE EXCLUSIVE RIGHT TO USE "RADIO LOTTERY", APART FROM THE MARK AS SHOWN.

FOR LOTTERY SERVICES AND ADMINISTRATION OF LOTTERIES FOR OTHERS VIA RADIO AND ELECTRONIC MEDIA AND SPECIFICALLY THE INTERNET (U.S. CLS. 100, 101 AND 107).

FIRST USE 7-20-2005; IN COMMERCE 7-20-2005.

CLASS 41—(Continued).

3,313,665. AWADA, YEHIA, MR., LAS VEGAS, NV. SN 78-619,332. PUB. 9-26-2006, FILED 4-28-2005.

HIGH TIE BLACKJACK

THE MARK CONSISTS OF STANDARD CHARACTERS WITHOUT CLAIM TO ANY PARTICULAR FONT, STYLE, SIZE, OR COLOR.

NO CLAIM IS MADE TO THE EXCLUSIVE RIGHT TO USE "BLACKJACK", APART FROM THE MARK AS SHOWN.

FOR CASINO SERVICES FEATURING A CARD GAME (U.S. CLS. 100, 101 AND 107).

FIRST USE 1-11-2007; IN COMMERCE 1-11-2007.

3,313,700. NATURAL MOTION MARTIAL ARTS, INC., SCARBOROUGH, ME. SN 78-633,944. PUB. 2-21-2006, FILED 5-20-2005.

THE C.R.I.T.I.C.A.L. APPROACH

THE MARK CONSISTS OF STANDARD CHARACTERS WITHOUT CLAIM TO ANY PARTICULAR FONT, STYLE, SIZE, OR COLOR.

FOR MARTIAL ARTS INSTRUCTION (U.S. CLS. 100, 101 AND 107).

FIRST USE 11-13-2006; IN COMMERCE 11-13-2006.

3,313,702. VIACOM INTERNATIONAL INC., NEW YORK, NY. SN 78-636,196. PUB. 8-15-2006, FILED 5-24-2005.

CMT HOME BLITZ

THE MARK CONSISTS OF STANDARD CHARACTERS WITHOUT CLAIM TO ANY PARTICULAR FONT, STYLE, SIZE, OR COLOR.

NO CLAIM IS MADE TO THE EXCLUSIVE RIGHT TO USE "HOME", APART FROM THE MARK AS SHOWN.

FOR ENTERTAINMENT SERVICES IN THE NATURE OF AN ON-GOING TELEVISION SERIES, FEATURING LIVE ACTION, COMEDY AND DRAMA; PROVIDING ONLINE INFORMATION IN THE FIELD OF ENTERTAINMENT CONCERNING TELEVISION PROGRAMS (U.S. CLS. 100, 101 AND 107).

FIRST USE 2-16-2007; IN COMMERCE 2-16-2007.

CLASS 41—(Continued).

3,313,708. VIACOM INTERNATIONAL INC., NEW YORK, NY. SN 78-638,184. PUB. 2-21-2006, FILED 5-26-2005.

SMALL TOWN SECRETS

THE MARK CONSISTS OF STANDARD CHARACTERS WITHOUT CLAIM TO ANY PARTICULAR FONT, STYLE, SIZE, OR COLOR.

FOR ENTERTAINMENT SERVICES IN THE NATURE OF AN ON-GOING TELEVISION SERIES, FEATURING LIVE ACTION, COMEDY AND DRAMA; PROVIDING ONLINE INFORMATION IN THE FIELD OF ENTERTAINMENT CONCERNING TELEVISION PROGRAMS (U.S. CLS. 100, 101 AND 107).

FIRST USE 3-15-2007; IN COMMERCE 3-15-2007.

3,313,775. BON SECOUR VILLAGE, LLC, CULLMAN, AL. SN 78-665,431. PUB. 4-4-2006, FILED 7-7-2005.



FOR RECREATIONAL PARK SERVICES (U.S. CLS. 100, 101 AND 107).

FIRST USE 5-29-2007; IN COMMERCE 5-29-2007.

CLASS 41—(Continued).

3,313,787. FONA INTERNATIONAL INC., GENEVA, IL. SN 78-671,308. PUB. 8-1-2006, FILED 7-15-2005.

CLASS 41—(Continued).

3,313,845. THE CARTOON NETWORK, INC., ATLANTA, GA. SN 78-699,067. PUB. 9-12-2006, FILED 8-24-2005.

CONFECTION FLAVOR 201

THE MARK CONSISTS OF STANDARD CHARACTERS WITHOUT CLAIM TO ANY PARTICULAR FONT, STYLE, SIZE, OR COLOR.

OWNER OF U.S. REG. NO. 2,055,459.
NO CLAIM IS MADE TO THE EXCLUSIVE RIGHT TO USE "CONFECTION FLAVOR", APART FROM THE MARK AS SHOWN.

FOR EDUCATIONAL SERVICES, NAMELY, PROVIDING SEMINARS AND WORKSHOPS IN THE FIELD OF FLAVORS (U.S. CLS. 100, 101 AND 107).

FIRST USE 5-3-2006; IN COMMERCE 5-3-2006.

BUS STOP TALK

THE MARK CONSISTS OF STANDARD CHARACTERS WITHOUT CLAIM TO ANY PARTICULAR FONT, STYLE, SIZE, OR COLOR.

FOR ENTERTAINMENT AND EDUCATION SERVICES IN THE NATURE OF A CONTINUING COMEDY, DRAMA, ACTION, ADVENTURE AND/OR ANIMATION PROGRAM SERIES AND MOTION PICTURE FILM PRODUCTION, PROVIDED THROUGH TELEVISION, RADIO, AND THE GLOBAL COMPUTER INFORMATION NETWORK; PROVIDING ON-LINE INTERACTIVE GAMES PLAYED VIA GLOBAL COMPUTER NETWORKS AND GLOBAL COMMUNICATIONS NETWORKS (U.S. CLS. 100, 101 AND 107).

FIRST USE 10-2-2005; IN COMMERCE 10-2-2005.

3,313,816. SIMMONS-BOARDMAN PUBLISHING CORPORATION, NEW YORK, NY. SN 78-683,880. PUB. 10-17-2006, FILED 8-2-2005.

SBI UPDATE

THE MARK CONSISTS OF STANDARD CHARACTERS WITHOUT CLAIM TO ANY PARTICULAR FONT, STYLE, SIZE, OR COLOR.

OWNER OF U.S. REG. NO. 2,703,645.
NO CLAIM IS MADE TO THE EXCLUSIVE RIGHT TO USE "UPDATE", APART FROM THE MARK AS SHOWN.

FOR PROVIDING NEWSLETTERS IN THE FIELD OF GENERAL INFORMATION CONCERNING THE SIGN INDUSTRY VIA EMAIL (U.S. CLS. 100, 101 AND 107).

FIRST USE 8-31-2005; IN COMMERCE 8-31-2005.

3,313,864. MWM AND ASSOCIATES INCORPORATED, FORT WAYNE, IN. SN 78-707,054. PUB. 11-28-2006, FILED 9-6-2005.

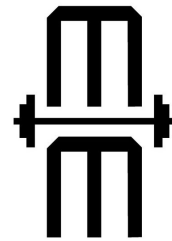

**MANAGEMENT
WITH MUSCLE**

NO CLAIM IS MADE TO THE EXCLUSIVE RIGHT TO USE "MANAGEMENT", APART FROM THE MARK AS SHOWN.

FOR EDUCATIONAL SERVICES, NAMELY CONDUCTING SEMINARS IN THE FIELD OF BUSINESS MANAGEMENT AND DISTRIBUTING COURSE MATERIALS IN CONNECTION THEREWITH (U.S. CLS. 100, 101 AND 107).

FIRST USE 3-8-2007; IN COMMERCE 3-8-2007.

CLASS 41—(Continued).

3,313,916. HASCO IA LIMITED, RENO, NV. SN 78-727,657.
PUB. 6-20-2006, FILED 10-6-2005.

WebNursery
Growing Family

OWNER OF U.S. REG. NOS. 2,369,918, 2,753,587, AND OTHERS.

FOR PORTRAIT PHOTOGRAPHY SERVICES (U.S. CLS. 100, 101 AND 107).
FIRST USE 9-0-2005; IN COMMERCE 9-0-2005.

3,313,955. PADRES L.P., SAN DIEGO, CA. SN 78-743,067. PUB. 7-4-2006, FILED 10-28-2005.

COMPADRES

THE MARK CONSISTS OF STANDARD CHARACTERS WITHOUT CLAIM TO ANY PARTICULAR FONT, STYLE, SIZE, OR COLOR.

OWNER OF U.S. REG. NOS. 2,178,024 AND 2,473,844.
THE FOREIGN WORDING IN THE MARK TRANSLATES INTO ENGLISH AS FRIENDS.

FOR ENTERTAINMENT SERVICES, NAMELY, BASEBALL GAMES, COMPETITIONS AND EXHIBITIONS RENDERED LIVE AND THROUGH BROADCAST MEDIA INCLUDING TELEVISION AND RADIO, AND VIA A GLOBAL COMPUTER NETWORK OR A COMMERCIAL ON-LINE SERVICE; INFORMATION SERVICES, NAMELY, PROVIDING INFORMATION IN THE FIELD OF SPORTS, ENTERTAINMENT AND RELATED TOPICS, AND PROVIDING FOR INFORMATIONAL MESSAGES RELATING THERETO; EDUCATIONAL SERVICES IN THE NATURE OF BASEBALL SKILLS PROGRAMS, BASEBALL CAMPS, SEMINARS AND CLINICS OFFERED LIVE; ENTERTAINMENT SERVICES, NAMELY, PROVIDING FACILITIES FOR SPORTS TOURNAMENTS AND COMPETITIONS RELATING TO BASEBALL; ORGANIZING AND CONDUCTING SPORTS CONTESTS AND SWEEPSTAKES; FAN CLUBS (U.S. CLS. 100, 101 AND 107).
FIRST USE 3-2-1996; IN COMMERCE 3-2-1996.

CLASS 41—(Continued).

3,313,979. SSM CARDINAL GLENNON CHILDREN'S HOSPITAL, ST. LOUIS, MO. SN 78-749,248. PUB. 7-25-2006, FILED 11-8-2005.

MY BRAVE JOURNEY

THE MARK CONSISTS OF STANDARD CHARACTERS WITHOUT CLAIM TO ANY PARTICULAR FONT, STYLE, SIZE, OR COLOR.

FOR PROVIDING RECOGNITION AND INCENTIVES BY MEANS OF AWARDS TO ENCOURAGE PERSISTENCE OF TERMINALLY OR CHRONICALLY ILL CHILDREN TO ACHIEVE GOALS AND MILESTONES BY COMPLETION OF HEALTHCARE TREATMENT AND PROCEDURES (U.S. CLS. 100, 101 AND 107).
FIRST USE 11-0-2005; IN COMMERCE 11-0-2005.

3,313,990. AXN NETWORK, INC., CULVER CITY, CA. SN 78-749,978. PUB. 9-5-2006, FILED 11-9-2005.



OWNER OF U.S. REG. NO. 3,046,503.
THE MARK CONSISTS OF THE LETTERS "AXN" IN A STYLIZED FORM CONTAINED WITHIN A RECTANGLE.

FOR ENTERTAINMENT SERVICES IN THE NATURE OF LIVE OR ANIMATED TELEVISION PROGRAMMING FEATURING ACTION AND ADVENTURE THEMES; PRODUCTION AND DISTRIBUTION OF ACTION AND ADVENTURE TELEVISION PROGRAMMING (U.S. CLS. 100, 101 AND 107).
FIRST USE 3-26-2007; IN COMMERCE 3-26-2007.

CLASS 41—(Continued).

3,313,993. PLANET3 WIRELESS, INC., ATLANTA, GA. SN 78-750,103. PUB. 8-15-2006, FILED 11-9-2005.

Wireless#

THE MARK CONSISTS OF STANDARD CHARACTERS WITHOUT CLAIM TO ANY PARTICULAR FONT, STYLE, SIZE, OR COLOR.

FOR EDUCATION SERVICES, NAMELY, PROVIDING EXAMINATION SERVICES IN THE FIELD OF DESIGN, MANAGEMENT, INSTALLATION, CONFIGURATION, AND TROUBLESHOOTING OF WIRELESS COMPUTER HARDWARE AND SOFTWARE NETWORKING SYSTEMS, AND PROVIDING STUDY GUIDES IN CONNECTION THEREWITH (U.S. CLS. 100, 101 AND 107).

FIRST USE 9-1-2006; IN COMMERCE 9-1-2006.

CLASS 41—(Continued).

3,314,013. MONEY GAMING CORPORATION LTD., THE, LONDON, UNITED KINGDOM. SN 78-753,664. PUB. 7-18-2006, FILED 11-14-2005.

THE BETTER YOU PLAY - THE MORE YOU WIN

THE MARK CONSISTS OF STANDARD CHARACTERS WITHOUT CLAIM TO ANY PARTICULAR FONT, STYLE, SIZE, OR COLOR.

FOR PROVIDING GAMBLING AND GAMING SERVICES; ENTERTAINMENT SERVICES, NAMELY, PROVIDING INTERACTIVE ONLINE COMPUTER GAMES VIA LOCAL COMPUTER NETWORKS AND GLOBAL COMMUNICATION NETWORKS; CONDUCTING SPECIAL EVENTS FEATURING GAMBLING AND GAMING CONTESTS AND TOURNAMENTS (U.S. CLS. 100, 101 AND 107).

FIRST USE 7-16-2005; IN COMMERCE 7-16-2005.

3,314,018. TAYLOR, ADAM S., FALMOUTH, ME. SN 78-754,972. PUB. 8-29-2006, FILED 11-16-2005.

3,314,010. BERARDELLI, JEFFREY R., NEW YORK, NY. SN 78-752,729. PUB. 2-13-2007, FILED 11-12-2005.

Weather Professor



THE COLORS DARK RED, LIGHT RED, BLACK, WHITE, BROWN, AND BEIGE ARE CLAIMED AS A FEATURE OF THE MARK.

THE MARK CONSISTS OF A DARK RED LOBSTER CARTOON WITH A LIGHT RED BELLY AND A BLACK MOUSTACHE, STANDING UP SMILING WITH A WHITE TOOTHY SMILE CARRYING A BLACK FISHING ROD WITH LINE AND WORM ON SUSPENDED FISHING HOOK ATTACHED IN ITS CLAWS AND A BROWN GOLF BAG WITH A BEIGE STRAP OVER ITS TORSO. THE GOLF BAG CONTAINS GOLF CLUBS COVERED WITH BEIGE CLUB COVERS.

FOR ENTERTAINMENT IN THE NATURE OF GOLF AND FISHING TOURNAMENTS (U.S. CLS. 100, 101 AND 107).

FIRST USE 7-31-2005; IN COMMERCE 5-1-2006.

THE MARK CONSISTS OF STANDARD CHARACTERS WITHOUT CLAIM TO ANY PARTICULAR FONT, STYLE, SIZE, OR COLOR.

NO CLAIM IS MADE TO THE EXCLUSIVE RIGHT TO USE "WEATHER", APART FROM THE MARK AS SHOWN.

FOR EDUCATIONAL AND ENTERTAINMENT SERVICES, NAMELY, COURSES, SEMINARS, AND PUBLIC SPEAKING ENGAGEMENTS ABOUT WEATHER-RELATED ISSUES VIA TELEVISION, RADIO, AND INTERNET (U.S. CLS. 100, 101 AND 107).

FIRST USE 10-3-2006; IN COMMERCE 10-3-2006.

CLASS 41—(Continued).

3,314,028. PHILADELPHIA CHURCH OF GOD, EDMOND, OK. SN 78-757,163. PUB. 7-25-2006, FILED 11-18-2005.

**HERBERT W. ARMSTRONG
COLLEGE**

THE MARK CONSISTS OF STANDARD CHARACTERS WITHOUT CLAIM TO ANY PARTICULAR FONT, STYLE, SIZE, OR COLOR.

OWNER OF U.S. REG. NO. 2,827,724.

NO CLAIM IS MADE TO THE EXCLUSIVE RIGHT TO USE "COLLEGE", APART FROM THE MARK AS SHOWN.

THE NAME(S), PORTRAIT(S), AND/OR SIGNATURE(S) SHOWN IN THE MARK DOES NOT IDENTIFY A PARTICULAR LIVING INDIVIDUAL.

FOR EDUCATIONAL SERVICES, NAMELY, CONDUCTING COURSES OF INSTRUCTION IN THE FIELD OF LIBERAL ARTS AND THEOLOGY AT THE PRIMARY, SECONDARY AND COLLEGIATE LEVEL (U.S. CLS. 100, 101 AND 107).

FIRST USE 1-1-2006; IN COMMERCE 1-1-2006.

3,314,066. THE KNOT, INC., NEW YORK, NY. SN 78-764,483. PUB. 8-8-2006, FILED 12-1-2005.

PARTYSPOT

THE MARK CONSISTS OF STANDARD CHARACTERS WITHOUT CLAIM TO ANY PARTICULAR FONT, STYLE, SIZE, OR COLOR.

FOR PROVIDING PARTY PLANNING, PARTY ADVICE AND INFORMATION, AND AN INTERACTIVE PARTY PLANNING GUIDE AND LIST OVER THE INTERNET (U.S. CLS. 100, 101 AND 107).

FIRST USE 1-10-2006; IN COMMERCE 1-10-2006.

CLASS 41—(Continued).

3,314,094. HICKEY, KENNETH, STATEN ISLAND, NY. SN 78-767,883. PUB. 8-8-2006, FILED 12-6-2005.

Seventh Void

THE MARK CONSISTS OF STANDARD CHARACTERS WITHOUT CLAIM TO ANY PARTICULAR FONT, STYLE, SIZE, OR COLOR.

FOR ENTERTAINMENT IN THE NATURE OF LIVE MUSICAL PERFORMANCES AND ENTERTAINMENT SERVICES, NAMELY, PROVIDING PRERECORDED MUSIC, INFORMATION IN THE FIELD OF MUSIC, AND COMMENTARY AND ARTICLES ABOUT MUSIC, ALL ON-LINE VIA THE INTERNET (U.S. CLS. 100, 101 AND 107).

FIRST USE 8-14-2005; IN COMMERCE 9-1-2006.

3,314,105. DENTAL DIRECTIONS INC., TULSA, OK. SN 78-770,012. PUB. 1-30-2007, FILED 12-9-2005.



CLARY SAGE

THE NAME "CLARY SAGE" DOES NOT IDENTIFY A LIVING INDIVIDUAL.

THE MARK CONSISTS OF THREE INTERTWINED LEAVES.

FOR EDUCATING AT UNIVERSITY OR COLLEGES; EDUCATIONAL SERVICES IN THE NATURE OF BEAUTY SCHOOLS (U.S. CLS. 100, 101 AND 107).

FIRST USE 12-1-2005; IN COMMERCE 12-1-2005.

3,314,108. WILSON, DARRICK, ROCHESTER, NY. SN 78-770,666. PUB. 8-22-2006, FILED 12-9-2005.

WILSONWORKS

THE MARK CONSISTS OF STANDARD CHARACTERS WITHOUT CLAIM TO ANY PARTICULAR FONT, STYLE, SIZE, OR COLOR.

FOR ANIMATION PRODUCTION SERVICES (U.S. CLS. 100, 101 AND 107).

FIRST USE 5-9-2007; IN COMMERCE 5-9-2007.

CLASS 41—(Continued).

3,314,131. PLAYBOY ENTERPRISES INTERNATIONAL, INC., CHICAGO, IL. SN 78-774,392. PUB. 7-18-2006, FILED 12-15-2005.

CLASS 41—(Continued).

3,314,144. CHIQUE EVENT PRODUCTIONS, INC., ORLANDO, FL. SN 78-776,392. PUB. 3-27-2007, FILED 12-19-2005.

**PLAYBOY MOBILE TV**

NO CLAIM IS MADE TO THE EXCLUSIVE RIGHT TO USE "EVENTS", APART FROM THE MARK AS SHOWN.

THE STIPPLING IS FOR SHADING PURPOSES ONLY.

THE MARK CONSISTS OF TREE FROG HUGGING THE "C" IN THE WORD CHIQUE.

THE FOREIGN WORDING IN THE MARK TRANSLATES INTO ENGLISH AS PLUG.

FOR ARRANGING FOR TICKET RESERVATIONS FOR SHOWS AND OTHER ENTERTAINMENT EVENTS; CONDUCTING AND PROVIDING FACILITIES FOR SPECIAL EVENTS FEATURING CASINO AND GAMING CONTESTS AND TOURNAMENTS; DANCE EVENTS; DISC JOCKEYS FOR PARTIES AND SPECIAL EVENTS; ENTERTAINMENT SERVICES, NAMELY BODY PAINTING SERVICES HELD AT SPECIAL EVENTS; ENTERTAINMENT SERVICES, NAMELY PERFORMING AND COMPETING IN MOTOR SPORTS EVENTS; HANDICAPING FOR SPORTING EVENTS; MASTER OF CEREMONY SERVICES FOR PARTIES AND SPECIAL EVENTS; ORGANISATION OF SPORTS EVENTS IN THE FIELD OF FOOTBALL; ORGANIZATION OF DANCING EVENTS; ORGANIZING COMMUNITY FESTIVALS FEATURING A VARIETY OF ACTIVITIES, NAMELY SPORTING EVENTS, ART EXHIBITIONS, FLEA MARKETS, ETHNIC DANCES AND THE LIKE; ORGANIZING COMMUNITY SPORTING AND CULTURAL EVENTS; PARTY PLANNING; PARTY PLANNING CONSULTATION; PLANNING ARRANGEMENT OF SHOWING MOVIES, SHOWS, PLAYS OR MUSICAL PERFORMANCES; PREPARING SURTITLES FOR LIVE THEATRICAL EVENTS; PROVIDING NEWS IN THE NATURE OF CURRENT EVENT REPORTING; PROVIDING VARIOUS FACILITIES FOR AN ARRAY OF SPORTING EVENTS, SPORTS AND ATHLETIC COMPETITIONS AND AWARDS PROGRAMMES; SPECIAL EVENT PLANNING; SPECIAL EVENT PLANNING CONSULTATION; COORDINATION OF SEMINARS; TIMING OF SPORTS EVENTS; TRAINING COURSES IN STRATEGIC PLANNING RELATING TO ADVERTISING, PROMOTION, MARKETING AND BUSINESS (U.S. CLS. 100, 101 AND 107).

FIRST USE 1-1-2006; IN COMMERCE 1-1-2006.

THE MARK CONSISTS OF STANDARD CHARACTERS WITHOUT CLAIM TO ANY PARTICULAR FONT, STYLE, SIZE, OR COLOR.

OWNER OF U.S. REG. NOS. 2,190,905, 2,894,179, AND OTHERS.

NO CLAIM IS MADE TO THE EXCLUSIVE RIGHT TO USE "MOBILE TV", APART FROM THE MARK AS SHOWN.

FOR PRODUCTION AND DISTRIBUTION OF TELEVISION PROGRAMS AND VIDEO CLIPS IN THE FIELD OF ADULT ENTERTAINMENT (U.S. CLS. 100, 101 AND 107).

FIRST USE 10-31-2006; IN COMMERCE 10-31-2006.

CLASS 41—(Continued).

3,314,155. HOME EDUCATION CONSULTATION, INC., FALLBROOK, CA. SN 78-777,219. PUB. 10-31-2006, FILED 12-20-2005.



NO CLAIM IS MADE TO THE EXCLUSIVE RIGHT TO USE "HOME EDUCATION CONSULTATION", APART FROM THE MARK AS SHOWN.

FOR CONSULTATION ABOUT EDUCATION (U.S. CLS. 100, 101 AND 107).

FIRST USE 6-1-2006; IN COMMERCE 7-1-2006.

3,314,182. ALL STAR ESSAYS, LLC, VIENNA, VA. SN 78-783,233. PUB. 9-5-2006, FILED 12-30-2005.

MAKE YOUR ESSAYS SPARKLE!

THE MARK CONSISTS OF STANDARD CHARACTERS WITHOUT CLAIM TO ANY PARTICULAR FONT, STYLE, SIZE, OR COLOR.

FOR WRITTEN TEXT EDITING (U.S. CLS. 100, 101 AND 107).

FIRST USE 1-1-2006; IN COMMERCE 1-1-2006.

CLASS 41—(Continued).

3,314,207. STRACCIA, PIETRO, SAN FRANCISCO, CA. AND LUPINACCI, PAOLO GIORDANO, SAN FRANCISCO, CA. SN 78-787,210. PUB. 10-24-2006, FILED 1-9-2006.

THE MARK CONSISTS OF THE WORD "APSIDE". THE LETTERS "A" AND "E" ARE REPRESENTED BY TWO CIRCLES OF THE SAME DIAMETER. THE LETTERS "P" AND "D" ARE MADE WITH TWO SEMI CIRCLES OF THE SAME DIAMETER OF "A" AND "E".

FOR ANIMATION PRODUCTION SERVICES; AUDIO RECORDING AND PRODUCTION; COMPOSITION OF MUSIC FOR OTHERS; ENTERTAINMENT IN THE NATURE OF ORCHESTRA PERFORMANCES; ENTERTAINMENT IN THE NATURE OF VISUAL AND AUDIO PERFORMANCES, AND MUSICAL, VARIETY, NEWS AND COMEDY SHOWS; ENTERTAINMENT IN THE NATURE OF VISUAL AND AUDIO PERFORMANCES, NAMELY, MUSICAL BAND, ROCK GROUP, GYMNAS-TIC, DANCE, AND BALLET PERFORMANCES; ENTERTAINMENT NAMELY, LIGHTING PRODUCTION; ENTERTAINMENT NAMELY, LIVE PERFORMANCES BY A MUSICAL BAND; ENTERTAINMENT SERVICES, NAMELY, PROVIDING A WEB SITE FEATURING MUSICAL PERFORMANCES, MUSICAL VIDEOS, RELATED FILM CLIPS, PHOTOGRAPHS, AND OTHER MULTIMEDIA MATERIALS; ENTERTAINMENT, NAMELY LIVE MUSIC CONCERTS; ENTERTAINMENT, NAMELY LIVE PERFORMANCES BY MUSICAL BANDS; ENTERTAINMENT, NAMELY, LIVE PERFORMANCES BY ROCK GROUPS; LIVE PERFORMANCES FEATURING PRERECORDED VOCAL AND INSTRUMENTAL PERFORMANCES VIEWED ON A BIG SCREEN; MOTION PICTURE FILM PRODUCTION; MOTION PICTURE SONG PRODUCTION; MULTIMEDIA ENTERTAINMENT SOFTWARE PRODUCTION SERVICES; MUSIC COMPOSITION AND TRANSCRIPTION FOR OTHERS; MUSIC COMPOSITION FOR OTHERS; MUSIC PRODUCTION SERVICES; OPERATION OF VIDEO EQUIPMENT OR AUDIO EQUIPMENT FOR PRODUCTION OF RADIO OR TELEVISION PROGRAMS; PHOTOGRAPHIC COMPOSITION FOR OTHERS; PLANNING ARRANGEMENT OF SHOWING MOVIES, SHOWS, PLAYS OR MUSICAL PERFORMANCES; PRESENTATION OF LIVE SHOW PERFORMANCES; PRODUCTION AND DISTRIBUTION OF MOTION PICTURES; PRODUCTION OF RADIO AND TELEVISION PROGRAMS; PRODUCTION OF RADIO OR TELEVISION PROGRAMS; RADIO ENTERTAINMENT PRODUCTION; RECORD PRODUCTION; RECORDING STUDIOS; RENTAL OF SOUND RECORDINGS; SONG WRITING SERVICES; TELEVISION PRODUCTION; VIDEOTAPE PRODUCTION (U.S. CLS. 100, 101 AND 107).

FIRST USE 1-1-2003; IN COMMERCE 1-1-2003.

CLASS 41—(Continued).

3,314,208. BERNSTEIN, ANDREW, NEW YORK, NY. SN 78-787,332. PUB. 10-17-2006, FILED 1-9-2006.

Resilience 101

THE MARK CONSISTS OF STANDARD CHARACTERS WITHOUT CLAIM TO ANY PARTICULAR FONT, STYLE, SIZE, OR COLOR.

FOR CONDUCTING WORKSHOPS AND SEMINARS IN SELF AWARENESS (U.S. CLS. 100, 101 AND 107).
FIRST USE 3-15-2006; IN COMMERCE 10-13-2006.

3,314,235. INNOVATIVE IDEAS AND INFLUENCE CORPS, LLC, FORT MILL, SC. SN 78-792,613. PUB. 9-12-2006, FILED 1-16-2006.

SUCCESS Selling System

THE MARK CONSISTS OF STANDARD CHARACTERS WITHOUT CLAIM TO ANY PARTICULAR FONT, STYLE, SIZE, OR COLOR.

NO CLAIM IS MADE TO THE EXCLUSIVE RIGHT TO USE "SELLING SYSTEM", APART FROM THE MARK AS SHOWN.

FOR TRAINING IN THE FIELD OF SALES AND DISTRIBUTION OF COURSE MATERIAL IN CONNECTION THEREWITH (U.S. CLS. 100, 101 AND 107).

FIRST USE 6-10-2006; IN COMMERCE 6-10-2006.

3,314,275. SAFE DAUGHTERS, LAKE ZURICH, IL. SN 78-799,152. PUB. 9-19-2006, FILED 1-25-2006.

Safe Daughters

THE MARK CONSISTS OF STANDARD CHARACTERS WITHOUT CLAIM TO ANY PARTICULAR FONT, STYLE, SIZE, OR COLOR.

FOR EDUCATIONAL SERVICES, NAMELY, PROVIDING EDUCATIONAL ACTIVITIES IN THE NATURE OF CLASSES, SEMINARS AND WORKSHOPS IN THE FIELD OF SELF-DEFENSE (U.S. CLS. 100, 101 AND 107).
FIRST USE 5-1-2006; IN COMMERCE 5-1-2006.

CLASS 41—(Continued).

3,314,276. BEHAVIOR FRONTIERS, LLC, GARDENA, CA. SN 78-799,507. PUB. 10-3-2006, FILED 1-25-2006.



NO CLAIM IS MADE TO THE EXCLUSIVE RIGHT TO USE "BEHAVIOR", APART FROM THE MARK AS SHOWN. THE MARK CONSISTS OF A STYLIZED SUNRISE WITHIN A CIRCLE.

FOR EDUCATIONAL SERVICES, NAMELY, PROVIDING INDIVIDUALIZED INSTRUCTION AND REMEDIAL EDUCATION IN THE FIELD OF APPLIED BEHAVIOR ANALYSIS AND DEVELOPMENTAL DISORDERS SUCH AS AUTISM; CONDUCTING TRAINING, SEMINARS AND WORKSHOPS IN THE FIELDS OF APPLIED BEHAVIOR ANALYSIS AND DEVELOPMENTAL DISORDERS SUCH AS AUTISM (U.S. CLS. 100, 101 AND 107).

FIRST USE 8-4-2004; IN COMMERCE 3-24-2005.

3,314,312. PEAK DEVELOPMENT, LLC, SPEARFISH, SD. SN 78-808,107. PUB. 10-3-2006, FILED 2-6-2006.

MANAGER TO MENTOR

THE MARK CONSISTS OF STANDARD CHARACTERS WITHOUT CLAIM TO ANY PARTICULAR FONT, STYLE, SIZE, OR COLOR.

FOR PROVIDING A COMPREHENSIVE, INTEGRATED TRAINING PROGRAM FOR SALES MANAGERS TO IMPROVE THEIR ABILITY TO LEAD AND DEVELOP SALESPeOPLE AND TO ACQUIRE SALES PERFORMANCE COACHING SKILLS, COMPRISING, ONLINE TRAINING MODULES, HALF-DAY TRAINING MEETINGS, AND CONSULTANT FACILITATED JOINT COACHING ASSIGNMENTS (U.S. CLS. 100, 101 AND 107).

FIRST USE 10-31-2005; IN COMMERCE 10-31-2005.

CLASS 41—(Continued).

3,314,323. HALPERIN CREATIVE COMMUNICATIONS, L.P., DOYLESTOWN, PA. SN 78-809,295. PUB. 4-17-2007, FILED 2-7-2006.



THE MARK CONSISTS OF THE WORDS BABYMETV PRECEDED BY A STYLIZED THREE-QUARTER CHILD'S FACE.

FOR EDUCATIONAL SERVICES, NAMELY, CONDUCTING INFORMAL PROGRAMS IN THE FIELD OF PARENTING AND CARING FOR BABIES AND YOUNG CHILDREN, USING AUDIOVISUAL MATERIALS AND PRINTABLE MATERIALS DISTRIBUTED THEREWITH ON-LINE AND ON VIDEOTAPES AND DVDS (U.S. CLS. 100, 101 AND 107).

FIRST USE 9-22-2006; IN COMMERCE 9-22-2006.

3,314,340. HAPPY HIPPO PRESCHOOL, ORANGE, CA. SN 78-812,872. PUB. 12-19-2006, FILED 2-11-2006.

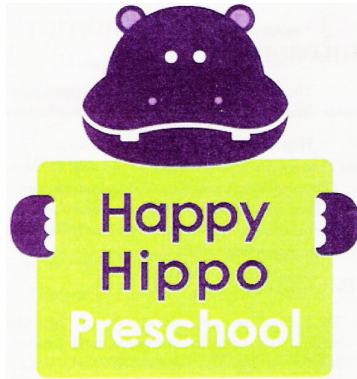

NO CLAIM IS MADE TO THE EXCLUSIVE RIGHT TO USE "PRESCHOOL", APART FROM THE MARK AS SHOWN.

THE COLOR(S) GREEN, PURPLE AND WHITE IS/ARE CLAIMED AS A FEATURE OF THE MARK.

THE COLORS PURPLE AND WHITE APPEAR ON THE HIPPO AND THE SIGN IT IS HOLDING IS LIGHT GREEN WITH PURPLE AND WHITE LETTERING.

FOR EDUCATIONAL SERVICES, NAMELY, PROVIDING COURSES OF INSTRUCTION AT THE PRESCHOOL LEVEL (U.S. CLS. 100, 101 AND 107).

FIRST USE 5-1-2006; IN COMMERCE 5-1-2006.

CLASS 41—(Continued).

3,314,344. DIGITALHATCH, INC., PEACHTREE CITY, GA. SN 78-813,530. PUB. 10-3-2006, FILED 2-13-2006.

VALUE FORWARD SELLING

THE MARK CONSISTS OF STANDARD CHARACTERS WITHOUT CLAIM TO ANY PARTICULAR FONT, STYLE, SIZE, OR COLOR.

NO CLAIM IS MADE TO THE EXCLUSIVE RIGHT TO USE "SELLING", APART FROM THE MARK AS SHOWN.

FOR PROVIDING TRAINING AND COURSES OF INSTRUCTION IN THE FIELD OF SALES AND MARKETING (U.S. CLS. 100, 101 AND 107).

FIRST USE 6-15-2005; IN COMMERCE 6-15-2005.

3,314,379. LEADERSHIP CARES FOUNDATION, GAITHERSBURG, MD. SN 78-818,740. PUB. 10-10-2006, FILED 2-20-2006.

LeadershipCares

THE MARK CONSISTS OF STANDARD CHARACTERS WITHOUT CLAIM TO ANY PARTICULAR FONT, STYLE, SIZE, OR COLOR.

FOR EDUCATIONAL SERVICES, NAMELY, DEVELOPING LEADERSHIP SKILLS THROUGH MENTORING ON THE SUBJECTS OF LITERACY AWARENESS AND HUNGER RELIEF (U.S. CLS. 100, 101 AND 107).

FIRST USE 1-1-2006; IN COMMERCE 1-1-2006.

3,314,389. CUNNINGHAM, CATHERINE, NEWPORT COAST, CA. SN 78-820,392. PUB. 10-3-2006, FILED 2-22-2006.

EIKOSPHERE

THE MARK CONSISTS OF STANDARD CHARACTERS WITHOUT CLAIM TO ANY PARTICULAR FONT, STYLE, SIZE, OR COLOR.

FOR EDUCATIONAL SERVICES, NAMELY, LECTURES, VISUAL PRESENTATIONS AND CONFERENCES COVERING ENVIRONMENTAL MATTERS; PHOTOGRAPHY SERVICES, NAMELY, PHOTOGRAPHY FOR USE IN MAGAZINES, COMMERCIAL CAMPAIGNS AND VISUAL PRESENTATIONS (U.S. CLS. 100, 101 AND 107).

FIRST USE 3-9-2007; IN COMMERCE 3-9-2007.

CLASS 41—(Continued).

3,314,409. CORNBELLY'S, INC., SPANISH FORK, UT. SN 78-824,029. PUB. 10-17-2006, FILED 2-27-2006.

CORNBELLYS

THE MARK CONSISTS OF STANDARD CHARACTERS WITHOUT CLAIM TO ANY PARTICULAR FONT, STYLE, SIZE, OR COLOR.

FOR ENTERTAINMENT SERVICES IN THE NATURE OF A HUMAN WALK THROUGH TYPE MAZE, AGRICULTURAL PARTIES AND HARVEST FESTIVALS (U.S. CLS. 100, 101 AND 107).

FIRST USE 9-23-2006; IN COMMERCE 9-23-2006.

3,314,417. SMITH, TIMOTHY C., ST. CHARLES, IL. SN 78-826,393. PUB. 10-24-2006, FILED 3-1-2006.

CRASHPROOF YOUR KIDS

THE MARK CONSISTS OF STANDARD CHARACTERS WITHOUT CLAIM TO ANY PARTICULAR FONT, STYLE, SIZE, OR COLOR.

FOR EDUCATIONAL SERVICES, NAMELY, CONDUCTING CLASSES, SEMINARS, CONFERENCES AND WORKSHOPS IN THE FIELD OF VEHICLE DRIVING INSTRUCTION AND DISTRIBUTING COURSE MATERIALS IN CONNECTION THEREWITH; DRIVER SAFETY TRAINING; VEHICLE DRIVING INSTRUCTION; PROVIDING NEWSLETTERS IN THE FIELD OF VEHICLE DRIVING INSTRUCTION VIA E-MAIL; PUBLISHING OF WEB MAGAZINES RELATING TO VEHICLE DRIVING INSTRUCTION; PUBLISHING OF ARTICLES IN PRINT MAGAZINES AND NEWSPAPERS PERTAINING TO TEEN DRIVING; AND PRODUCTION OF RADIO AND TELEVISION PROGRAMS PERTAINING TO TEEN DRIVING (U.S. CLS. 100, 101 AND 107).

FIRST USE 10-1-2006; IN COMMERCE 10-1-2006.

CLASS 41—(Continued).

3,314,435. SHUFFLE MASTER INC., LAS VEGAS, NV. SN 78-830,545. PUB. 6-13-2006, FILED 3-6-2006.

Shuffle Up Productions

THE MARK CONSISTS OF STANDARD CHARACTERS WITHOUT CLAIM TO ANY PARTICULAR FONT, STYLE, SIZE, OR COLOR.

OWNER OF U.S. REG. NOS. 1,766,013, 2,266,946, AND OTHERS.

NO CLAIM IS MADE TO THE EXCLUSIVE RIGHT TO USE "PRODUCTIONS", APART FROM THE MARK AS SHOWN.

FOR ENTERTAINMENT SERVICES, NAMELY, ORGANIZING, CONDUCTING, PRODUCING AND EXHIBITING GAMING EVENTS RENDERED LIVE AND ONLINE; ENTERTAINMENT IN THE NATURE OF ONGOING TELEVISION PROGRAMS IN THE FIELD OF GAMING EVENTS; PROVIDING INFORMATION IN THE FIELD OF CASINO AND ENTERTAINMENT GAME RELATED TIPS AND STRATEGY, AND PROVIDING NEWS AND INFORMATION IN THE FIELD OF CASINO EVENTS, TOURNAMENTS, SCHEDULES, PLAYERS AND OTHER RELATED TOPICS OF INTEREST TO THE CASINO AND WAGERING GAME PLAYING COMMUNITY (U.S. CLS. 100, 101 AND 107).

FIRST USE 1-0-2005; IN COMMERCE 1-0-2005.

3,314,447. METROMEDIA TECHNOLOGIES, INC., NEW YORK, NY. SN 78-833,112. PUB. 10-31-2006, FILED 3-9-2006.

HOW WILL YOU RE:ACT?

THE MARK CONSISTS OF STANDARD CHARACTERS WITHOUT CLAIM TO ANY PARTICULAR FONT, STYLE, SIZE, OR COLOR.

FOR DIGITAL IMAGING SERVICES FOR VISUAL DISPLAYS SUCH AS BILLBOARDS AND PICTORIAL ADVERTISEMENTS (U.S. CLS. 100, 101 AND 107).

FIRST USE 2-1-2006; IN COMMERCE 2-1-2006.

CLASS 41—(Continued).

3,314,451. WORDSWORTH, CHLOE FAITH, SCOTTSDALE, AZ. SN 78-833,799. PUB. 10-17-2006, FILED 3-9-2006.

QUANTUM CHANGE MADE EASY

THE MARK CONSISTS OF STANDARD CHARACTERS WITHOUT CLAIM TO ANY PARTICULAR FONT, STYLE, SIZE, OR COLOR.

FOR CONDUCTING SEMINARS, TUTORIALS, CLASSES, EDUCATIONAL DEMONSTRATIONS AND CONFERENCES IN THE FIELD OF HOLISTIC SELF HEALING METHODS OF PERSONAL DEVELOPMENT (U.S. CLS. 100, 101 AND 107).

FIRST USE 5-0-2006; IN COMMERCE 5-0-2006.

3,314,452. WORDSWORTH, CHLOE FAITH, SCOTTSDALE, AZ. SN 78-833,804. PUB. 10-17-2006, FILED 3-9-2006.



THE COLOR GRAY IS INTENDED TO INDICATE CONTRAST ONLY, THE MARK IS NOT IN COLOR.

FOR CONDUCTING SEMINARS, TUTORIALS, CLASSES, EDUCATIONAL DEMONSTRATIONS AND CONFERENCES IN THE FIELD OF HOLISTIC SELF HEALING METHODS OF PERSONAL DEVELOPMENT (U.S. CLS. 100, 101 AND 107).

FIRST USE 5-0-2006; IN COMMERCE 5-0-2006.

CLASS 41—(Continued).

3,314,460. ADVANTAGE ENTERTAINMENT CENTERS, INC., POMONA, NY. SN 78-835,997. PUB. 12-19-2006, FILED 3-13-2006.

Krazy City

THE MARK CONSISTS OF STANDARD CHARACTERS WITHOUT CLAIM TO ANY PARTICULAR FONT, STYLE, SIZE, OR COLOR.

FOR CHILD-BASED EDUCATION AND ENTERTAINMENT CENTER SERVICES, NAMELY, PROVISION OF CHILDREN'S PLAY AREAS AT RESTAURANTS, PROVISION OF ARCADE GAMES, AMUSEMENT ARCADES AND AMUSEMENT ARCADE RIDES (U.S. CLS. 100, 101 AND 107).

FIRST USE 12-1-2006; IN COMMERCE 12-1-2006.

3,314,471. SOUTH CAROLINA EDUCATION LOTTERY COMMISSION, COLUMBIA, SC. SN 78-839,937. PUB. 8-8-2006, FILED 3-17-2006.



NO CLAIM IS MADE TO THE EXCLUSIVE RIGHT TO USE "CAROLINA" AND THE REPRESENTATION OF THE MAP OF THE STATE OF SOUTH CAROLINA, APART FROM THE MARK AS SHOWN.

THE MARK CONSISTS OF THE WORDS CAROLINA POWER DEAL SUPERIMPOSED ON A CONTRASTING MAP OF THE STATE OF SOUTH CAROLINA, WITH THE LETTERS COMPRISING WORDS POWER DEAL EACH WITHIN A CIRCLE.

FOR LOTTERY SERVICES (U.S. CLS. 100, 101 AND 107).

FIRST USE 7-10-2006; IN COMMERCE 7-10-2006.

3,314,481. JULIA KEEFER, NEW YORK, NY. SN 78-845,599. PUB. 11-21-2006, FILED 3-24-2006.

Knockout Step/Slide/Strike

THE MARK CONSISTS OF STANDARD CHARACTERS WITHOUT CLAIM TO ANY PARTICULAR FONT, STYLE, SIZE, OR COLOR.

CLASS 41—(Continued).

NO CLAIM IS MADE TO THE EXCLUSIVE RIGHT TO USE "STEP SLIDE STRIKE", APART FROM THE MARK AS SHOWN.

FOR EDUCATIONAL SERVICES, NAMELY, CONDUCTING CLASSES IN THE FIELD OF HEALTH AND FITNESS, AND DISTRIBUTING COURSE MATERIALS IN CONNECTION THEREWITH (U.S. CLS. 100, 101 AND 107).

FIRST USE 2-1-2007; IN COMMERCE 2-1-2007.

3,314,496. VIACOM INTERNATIONAL INC., NEW YORK, NY. SN 78-852,356. PUB. 10-24-2006, FILED 4-3-2006.

HERE'S THE STORY

THE MARK CONSISTS OF STANDARD CHARACTERS WITHOUT CLAIM TO ANY PARTICULAR FONT, STYLE, SIZE, OR COLOR.

FOR ENTERTAINMENT SERVICES IN THE NATURE OF AN ON-GOING TELEVISION SERIES, FEATURING LIVE ACTION, COMEDY AND DRAMA; PROVIDING ONLINE INFORMATION IN THE FIELD OF ENTERTAINMENT CONCERNING TELEVISION PROGRAMS (U.S. CLS. 100, 101 AND 107).

FIRST USE 5-9-2007; IN COMMERCE 5-9-2007.

3,314,514. MICHAEL KICKARO'S MARTIAL ARTS AND FITNESS, LLC, BROOKFIELD, CT. SN 78-859,613. PUB. 12-26-2006, FILED 4-12-2006.



NO CLAIM IS MADE TO THE EXCLUSIVE RIGHT TO USE "MARTIAL ARTS" AND "FITNESS", APART FROM THE MARK AS SHOWN.

THE NAME(S), PORTRAIT(S), AND/OR SIGNATURE(S) SHOWN IN THE MARK IDENTIFIES MICHAEL COCCARO, WHOSE CONSENT(S) TO REGISTER IS SUBMITTED.

THE COLOR(S) RED AND BLUE IS/ARE CLAIMED AS A FEATURE OF THE MARK.

THE MARK CONSISTS OF THE WORDS MICHAEL KICKARO'S MARTIAL ARTS AND FITNESS, TOGETHER WITH A STAR ON THE LEFTHAND SIDE OF THE MARK. THE COLOR RED APPEARS IN THE LETTERS KICK AND THE CHEVRON DESIGN TO THE RIGHT THEREOF AND THE COLOR BLUE APPEARS IN THE REMAINDER OF THE MARK.

FOR MARTIAL ARTS INSTRUCTION, OPERATION OF MARTIAL ARTS SCHOOL (U.S. CLS. 100, 101 AND 107).

FIRST USE 1-1-2007; IN COMMERCE 1-1-2007.

CLASS 41—(Continued).

3,314,609. THINKING PAYS, INC., BOCA RATON, FL. SN 78-888,926. PUB. 12-26-2006, FILED 5-22-2006.

SPARKS OF GENIUS

THE MARK CONSISTS OF STANDARD CHARACTERS WITHOUT CLAIM TO ANY PARTICULAR FONT, STYLE, SIZE, OR COLOR.

FOR EDUCATION SERVICES, NAMELY, COMPUTER-BASED TRAINING IN THE AREAS OF COGNITIVE ABILITIES, INTELLIGENCE AND CREATIVITY (U.S. CLS. 100, 101 AND 107).

FIRST USE 8-24-2006; IN COMMERCE 1-17-2007.

3,314,703. XES ENTERTAINMENT LLC, STOUGHTON, MA. SN 78-911,478. PUB. 10-10-2006, FILED 6-19-2006.

ATHENA DREAM

THE MARK CONSISTS OF STANDARD CHARACTERS WITHOUT CLAIM TO ANY PARTICULAR FONT, STYLE, SIZE, OR COLOR.

THE NAME ATHENA DREAM DOES NOT IDENTIFY A LIVING INDIVIDUAL.

FOR ENTERTAINMENT IN THE NATURE OF PROVIDING ADULT THEMED PHOTOGRAPHS AND VIDEOS VIA THE INTERNET (U.S. CLS. 100, 101 AND 107).

FIRST USE 5-16-2007; IN COMMERCE 5-16-2007.

3,314,715. 8 PAWS LLC, EAST HAMPTON, NY. SN 78-915,212. PUB. 3-27-2007, FILED 6-23-2006.

CAT CHAT

THE MARK CONSISTS OF STANDARD CHARACTERS WITHOUT CLAIM TO ANY PARTICULAR FONT, STYLE, SIZE, OR COLOR.

NO CLAIM IS MADE TO THE EXCLUSIVE RIGHT TO USE "CAT", APART FROM THE MARK AS SHOWN.

FOR ENTERTAINMENT SERVICES, NAMELY, CONDUCTING A TALK RADIO SHOW ON CATS (U.S. CLS. 100, 101 AND 107).

FIRST USE 11-29-2006; IN COMMERCE 11-29-2006.

CLASS 41—(Continued).

3,314,716. SKY HIGH PROMOTIONS, INC., LOUISVILLE, KY. SN 78-915,292. PUB. 3-27-2007, FILED 6-23-2006.

SANTA'S HOTLINE

THE MARK CONSISTS OF STANDARD CHARACTERS WITHOUT CLAIM TO ANY PARTICULAR FONT, STYLE, SIZE, OR COLOR.

NO CLAIM IS MADE TO THE EXCLUSIVE RIGHT TO USE "SANTA'S", APART FROM THE MARK AS SHOWN.

FOR ENTERTAINMENT IN THE NATURE OF PRE-RECORDED SCHEDULED AND PERSONALIZED TELEPHONE CALLS TO CHILDREN FROM A SANTA CLAUS IMPERSONATOR (U.S. CLS. 100, 101 AND 107).

FIRST USE 10-0-2006; IN COMMERCE 10-0-2006.

3,314,731. PLANET HOTTIEWOOD, COCONUT CREEK, FL. SN 78-919,466. PUB. 3-13-2007, FILED 6-28-2006.

Planet Hottiewood

THE MARK CONSISTS OF STANDARD CHARACTERS WITHOUT CLAIM TO ANY PARTICULAR FONT, STYLE, SIZE, OR COLOR.

FOR ENTERTAINMENT SERVICES, NAMELY, PROVIDING A WEBSITE FEATURING, PHOTOGRAPHIC, AUDIO, VIDEO AND PROSE PRESENTATIONS FEATURING FEMALE MODELS (U.S. CLS. 100, 101 AND 107).

FIRST USE 12-1-2005; IN COMMERCE 1-1-2006.

3,314,783. ALAMELU'S CULINARY ENTERPRISE LLC, WHITEFISH BAY, WI. SN 78-940,537. PUB. 3-6-2007, FILED 7-29-2006.

CURRYONWHEELS

THE MARK CONSISTS OF STANDARD CHARACTERS WITHOUT CLAIM TO ANY PARTICULAR FONT, STYLE, SIZE, OR COLOR.

FOR EDUCATIONAL SERVICES, NAMELY, PROVIDING TRAINING AND INSTRUCTION ON HEALTHY COOKING AND WELLNESS THROUGH THE USE OF SOUTH INDIAN COOKING TECHNIQUES (U.S. CLS. 100, 101 AND 107).

FIRST USE 5-15-2006; IN COMMERCE 5-15-2006.

CLASS 41—(Continued).

3,314,786. BRIGHTON PRODUCTIONS, LLC, WASHINGTON, DC. SN 78-940,875. PUB. 4-10-2007, FILED 7-31-2006.

PLANET WASHINGTON

THE MARK CONSISTS OF STANDARD CHARACTERS WITHOUT CLAIM TO ANY PARTICULAR FONT, STYLE, SIZE, OR COLOR.

NO CLAIM IS MADE TO THE EXCLUSIVE RIGHT TO USE "WASHINGTON", APART FROM THE MARK AS SHOWN.

FOR ENTERTAINMENT SERVICES, NAMELY SERIES OF MUSICAL AND LIVE-ACTION POLITICAL PARODY PERFORMANCES (U.S. CLS. 100, 101 AND 107).

FIRST USE 11-5-2006; IN COMMERCE 11-5-2006.

3,314,833. TRASK INDUSTRIES, LLC, KISSIMMEE, FL. SN 78-955,803. PUB. 4-17-2007, FILED 8-18-2006.

CINEMERSION

THE MARK CONSISTS OF STANDARD CHARACTERS WITHOUT CLAIM TO ANY PARTICULAR FONT, STYLE, SIZE, OR COLOR.

FOR ENTERTAINMENT SERVICES, NAMELY, FANTASY ENACTMENTS WHERE PARTICIPANTS RE-ENACT CONDITIONS, SITUATIONS, OR EVENTS SEEN IN MOVIES FROM THEIR OWN POINT OF VIEW (U.S. CLS. 100, 101 AND 107).

FIRST USE 10-10-2006; IN COMMERCE 7-10-2007.

3,314,836. TURNER NETWORK TELEVISION, INC., ATLANTA, GA. SN 78-956,245. PUB. 4-10-2007, FILED 8-21-2006.

DRAMAVISION

THE MARK CONSISTS OF STANDARD CHARACTERS WITHOUT CLAIM TO ANY PARTICULAR FONT, STYLE, SIZE, OR COLOR.

FOR ENTERTAINMENT SERVICES, NAMELY, PROVIDING VIDEO AND AUDIO CONTENT, NAMELY, ONGOING MOVIES OR TELEVISION PROGRAMMING AND ONLINE INTERACTIVE COMPUTER GAMES, ALL IN THE FIELD OF GENERAL INTEREST PROVIDED THROUGH, BROADCAST RADIO AND THE GLOBAL COMPUTER INFORMATION NETWORK AND GLOBAL COMMUNICATIONS NETWORKS (U.S. CLS. 100, 101 AND 107).

FIRST USE 8-8-2006; IN COMMERCE 8-8-2006.

CLASS 41—(Continued).

3,314,848. BVC SPORTS AND ENTERTAINMENT, LLC, ORLANDO, FL. SN 78-958,592. PUB. 5-22-2007, FILED 8-23-2006.

ORLANDO SHARKS

THE MARK CONSISTS OF STANDARD CHARACTERS WITHOUT CLAIM TO ANY PARTICULAR FONT, STYLE, SIZE, OR COLOR.

NO CLAIM IS MADE TO THE EXCLUSIVE RIGHT TO USE "ORLANDO", APART FROM THE MARK AS SHOWN. FOR ENTERTAINMENT IN THE NATURE OF SOCCER GAMES; ORGANIZING SPORTING EVENTS, NAMELY, SOCCER GAMES AND SOCCER EXHIBITIONS (U.S. CLS. 100, 101 AND 107).

FIRST USE 2-21-2007; IN COMMERCE 2-21-2007.

CLASS 41—(Continued).

3,314,900. MIROTZNIK, CHARLES M., NEW YORK, NY. SN 78-978,830. PUB. 3-21-2006, FILED 6-29-2005.

LUNIT

THE MARK CONSISTS OF STANDARD CHARACTERS WITHOUT CLAIM TO ANY PARTICULAR FONT, STYLE, SIZE, OR COLOR.

FOR EDUCATIONAL SERVICES, NAMELY CONDUCTING CLASSES, SEMINARS, LECTURES, EXHIBITS, AND WORKSHOPS IN THE FIELD OF ARCHITECTURE AND DESIGN AND DISTRIBUTING COURSE MATERIALS IN CONNECTION HERewith; PROVIDING TRAINING SERVICES, NAMELY TRAINING OTHERS IN THE CONSTRUCTION OF RESIDENTIAL BUILDINGS (U.S. CLS. 100, 101 AND 107).

FIRST USE 9-0-2006; IN COMMERCE 9-0-2006.

3,314,906. KIDS GOLF USA, LOS ANGELES, CA. SN 78-978,885. PUB. 10-31-2006, FILED 2-24-2006.

FIELD GOLF

THE MARK CONSISTS OF STANDARD CHARACTERS WITHOUT CLAIM TO ANY PARTICULAR FONT, STYLE, SIZE, OR COLOR.

NO CLAIM IS MADE TO THE EXCLUSIVE RIGHT TO USE "GOLF", APART FROM THE MARK AS SHOWN.

FOR ENTERTAINMENT IN THE NATURE OF GOLF PLAYED USING A GOLF GAME CONSISTING OF PORTABLE OBSTACLES AND SIMULATED WATER HAZARDS, GOLF TEES, AND GOLF CLUBS FOR PLAY ON A SIMULATED GOLF COURSE (U.S. CLS. 100, 101 AND 107).

FIRST USE 5-20-2007; IN COMMERCE 5-20-2007.

3,314,887. KAUFFMAN IMAGING LLC, CORDOVA, TN. SN 78-970,892. PUB. 5-15-2007, FILED 9-10-2006.



NO CLAIM IS MADE TO THE EXCLUSIVE RIGHT TO USE "ULTRASOUND", APART FROM THE MARK AS SHOWN.

THE COLOR(S) BROWN AND PINK IS/ARE CLAIMED AS A FEATURE OF THE MARK.

THE MARK CONSISTS OF SEVERAL OVERLAPPING CIRCLES IMITATING A MOTHER AND CHILD, THE MOTHER'S HEAD AND CHILD BEING BROWN IN COLOR AND THE LOWER HALF OF THE MOTHER BEING PINK. THE WORDS 'FIRST IMPRESSIONS ULTRASOUND' APPEAR BELOW THE LOGO WITH THE WORD 'FIRST' AND 'ULTRASOUND' IN BROWN AND THE WORD 'IMPRESIONS' IN PINK.

FOR DIGITAL IMAGING SERVICES (U.S. CLS. 100, 101 AND 107).

FIRST USE 9-15-2006; IN COMMERCE 11-25-2006.

3,314,907. DAVID LEAN FILMS LIMITED, STOKE ON TRENT, UNITED KINGDOM. SN 78-978,891. PUB. 6-13-2006, FILED 6-22-2004.

DAVID LEAN

CLASS 41—(Continued).

THE MARK CONSISTS OF STANDARD CHARACTERS WITHOUT CLAIM TO ANY PARTICULAR FONT, STYLE, SIZE, OR COLOR.

THE NAME DAVID LEAN DOES NOT IDENTIFY A LIVING INDIVIDUAL.

FOR PROVIDING RECOGNITION AND INCENTIVES BY THE WAY OF AWARDS TO DEMONSTRATE EXCELLENCE IN THE ENTERTAINMENT INDUSTRIES; PROVISION OF ENTERTAINMENT IN THE FORM OF MOTION PICTURES (U.S. CLS. 100, 101 AND 107).

FIRST USE 0-0-2001; IN COMMERCE 0-0-2001.

CLASS 42—SCIENTIFIC AND COMPUTER SERVICES

3,312,986. MARINE BOULEVARD NO. 9 CC, BLOUBERG, 7441, SOUTH AFRICA. SN 76-166,473. PUB. 2-22-2005, FILED 11-16-2000.

KLIKETY-KLIK

THE MARK CONSISTS OF STANDARD CHARACTERS WITHOUT CLAIM TO ANY PARTICULAR FONT, STYLE, SIZE, OR COLOR.

PRIORITY CLAIMED UNDER SEC. 44(D) ON SOUTH AFRICA APPLICATION NO. ZA2000/11139, FILED 6-1-2000, REG. NO. 2000/11139, DATED 6-1-2000, EXPIRES 6-1-2010.

FOR COMPUTER PROGRAMMING FOR OTHERS; LEASING ACCESS TIME TO A COMPUTER DATABASE; CONSULTING IN THE FIELD OF COMPUTER HARDWARE; RENTAL OF COMPUTERS; MAINTENANCE OF COMPUTER SOFTWARE; UPDATING OF COMPUTER SOFTWARE; COMPUTER SOFTWARE DESIGN FOR OTHERS; AND COMPUTER SYSTEMS ANALYSIS (U.S. CLS. 100 AND 101).

FIRST USE 6-1-2002; IN COMMERCE 11-1-2006.

3,313,010. ROBBINS-GIOIA, LLC. ALEXANDRIA, VA. SN 76-456,539. PUB. 12-16-2003, FILED 10-3-2002.

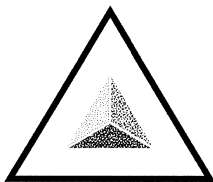

ROBBINSGIOIA

THE STIPPLING SHOWN IN THE DRAWING IS FOR SHADING PURPOSES ONLY AND IS NOT INTENDED TO INDICATE COLOR.

THE ENGLISH TRANSLATION OF THE ITALIAN WORD "GIOIA" IS "GLEE" OR "JOY."

FOR COMPUTER PROJECT MANAGEMENT SERVICES (U.S. CLS. 100 AND 101).

FIRST USE 10-0-2002; IN COMMERCE 10-0-2002.

CLASS 42—(Continued).

3,313,013. TERCICA, INC., BRISBANE, CA. SN 76-466,227. PUB. 8-17-2004, FILED 11-12-2002.



FOR PHARMACEUTICAL RESEARCH AND DEVELOPMENT SERVICES FOR OTHERS (U.S. CLS. 100 AND 101).

FIRST USE 5-8-2007; IN COMMERCE 5-8-2007.

3,313,019. COALESCE CONSULTING, INC., LITTLETON, CO. SN 76-513,547. PUB. 9-14-2004, FILED 5-12-2003.



NO CLAIM IS MADE TO THE EXCLUSIVE RIGHT TO USE "CONSULTING, INC.", APART FROM THE MARK AS SHOWN.

THE COLOR(S) BLUE AND BLACK ARE CLAIMED AS A FEATURE OF THE MARK.

THE MARK CONSISTS OF THE STYLIZED WORD "COALESCE", A HORIZONTAL LINE AND VERTICAL LINES ALL IN BLUE. THE MOLECULAR DESIGN AND THE WORDING CONSULTING, INC. ARE ALL IN BLACK.

FOR CONSULTING SERVICES IN THE FIELDS OF DESIGN, SELECTION, IMPLEMENTATION AND USE OF COMPUTER HARDWARE AND SOFTWARE SYSTEMS FOR OTHERS, CUSTOMIZATION OF COMPUTER HARDWARE AND SOFTWARE, COMPUTER SOFTWARE DESIGN FOR OTHERS, COMPUTER SOFTWARE DEVELOPMENT, INSTALLATION, MAINTENANCE AND REPAIR OF COMPUTER SOFTWARE, TROUBLE SHOOTING OF COMPUTER HARDWARE AND SOFTWARE PROBLEMS, COMPUTER CONSULTATION, COMPUTER DIAGNOSTIC SERVICES, COMPUTER NETWORK DESIGN FOR OTHERS, COMPUTER PROGRAMMING FOR OTHERS, COMPUTER PROJECT MANAGEMENT SERVICES, COMPUTER SITE DESIGN, COMPUTER SYSTEMS ANALYSIS, INTEGRATION OF COMPUTER SYSTEMS AND NETWORKS, DESIGNING, CREATING, IMPLEMENTING, MAINTAINING AND MANAGING WEB SITES FOR OTHERS; DISPLAYING THE WEB SITES AND IMAGES OF OTHERS ON A COMPUTER SERVER, HOSTING THE WEB SITES OF OTHERS ON A COMPUTER SERVER FOR A GLOBAL COMPUTER NETWORK, DATA RECOVERY SERVICES, COMPUTER DISASTER RECOVERY PLANNING, AND PROVISION OF BACK-UP COMPUTER PROGRAMS AND FACILITIES (U.S. CLS. 100 AND 101).

FIRST USE 7-19-2003; IN COMMERCE 7-19-2003.

CLASS 42—(Continued).

3,313,080. DALLAB SDN BHD (619727-A), 11900 BAYAN LEPAS, PENANG, MALAYSIA. SN 76-616,327. PUB. 12-12-2006, FILED 10-14-2004.

DALLAB

THE MARK CONSISTS OF STANDARD CHARACTERS WITHOUT CLAIM TO ANY PARTICULAR FONT, STYLE, SIZE, OR COLOR.

FOR BASIC AND APPLIED RESEARCH IN THE FIELD OF SCIENCES, ENGINEERING, COMPUTER PROGRAMMING, INFORMATION TECHNOLOGY, RADIO FREQUENCY IDENTIFICATION DEVICES AND TELECOMMUNICATIONS; RESEARCH AND DEVELOPMENT OF NEW PRODUCTS FOR OTHERS IN THE FIELD OF COMPUTER SERVICES; INTEGRATION OF COMPUTER SYSTEMS AND NETWORKS; AND COMPUTER CONSULTING SERVICES; RESEARCH AND DEVELOPMENT OF FIRMWARE AND HARDWARE INCLUSIVE OF MOBILE COMPUTING, MOBILE ACCESS, AND RADIO FREQUENCY IDENTIFICATION DEVICES FOR OTHERS; RESEARCH AND DEVELOPMENT OF NEW PRODUCTS FOR OTHERS IN THE FIELDS OF TELECOMMUNICATIONS AND INFORMATION TECHNOLOGY AND DIGITAL TELECOMMUNICATIONS SYSTEM; INDUSTRIAL AND MECHANICAL DESIGN AND DEVELOPMENT SERVICES OF NEW PRODUCTS FOR OTHERS (U.S. CLS. 100 AND 101).

FIRST USE 9-0-2005; IN COMMERCE 9-0-2005.

3,313,087. PRESENTATION STRATEGIES, INC., DURHAM, NC. SN 76-622,418. PUB. 8-1-2006, FILED 11-29-2004.

INTELLITAG

THE MARK CONSISTS OF STANDARD CHARACTERS WITHOUT CLAIM TO ANY PARTICULAR FONT, STYLE, SIZE, OR COLOR.

FOR DATA COLLECTION SERVICE USING PROPRIETARY SOFTWARE TO CODE SALES, ADVERTISING AND PROMOTIONAL MULTIMEDIA PRESENTATIONS, SUCH AS PRESENTATIONS CONTAINED ON A COMPACT DISK, FOR ADVERTISING AGENCIES AND MARKETING DEPARTMENTS OF BUSINESSES TO MONITOR AND MEASURE USAGE OF THE MULTIMEDIA PRESENTATIONS (U.S. CLS. 100 AND 101).

FIRST USE 10-0-2004; IN COMMERCE 10-0-2004.

CLASS 42—(Continued).

3,313,091. BIG COMMUNICATIONS, INC., FERNDALE, MI. SN 76-623,716. PUB. 11-14-2006, FILED 12-8-2004.

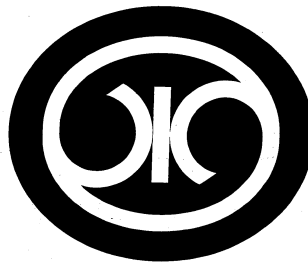

FOR WEB DEVELOPMENT SERVICES, NAMELY WEBSITE DESIGN CONSULTATION SERVICES FOR THE PURPOSE OF HELPING CLIENTS DEVELOP EFFECTIVE WEB EXPERIENCES FOR THE CUSTOMER; DESIGNING COMPUTER SOFTWARE, WEBSITES AND HOMEPAGES FOR OTHERS IN THE FIELD OF ONLINE AND DOWNLOADABLE SALES FORCE COMMUNICATION SOFTWARE AND WEBSITES AND SALES FORCE TRAINING SOFTWARE AND WEBSITES (U.S. CLS. 100 AND 101).

FIRST USE 9-15-2004; IN COMMERCE 9-15-2004.

3,313,099. ENVIRONMENTAL DATA RESOURCES, INC., MILFORD, CT. SN 76-627,452. PUB. 9-12-2006, FILED 1-10-2005.

EDR ON DEMAND

THE MARK CONSISTS OF STANDARD CHARACTERS WITHOUT CLAIM TO ANY PARTICULAR FONT, STYLE, SIZE, OR COLOR.

OWNER OF U.S. REG. NOS. 1,793,630, 2,887,305, AND OTHERS.

NO CLAIM IS MADE TO THE EXCLUSIVE RIGHT TO USE "ON DEMAND", APART FROM THE MARK AS SHOWN.

FOR ONLINE ENVIRONMENTAL INFORMATION SERVICES, NAMELY, PROVIDING ENVIRONMENTAL RISK ASSESSMENT SERVICES AND ENVIRONMENTAL DATABASE SEARCH SERVICES; HISTORICAL REAL PROPERTY USE INFORMATION SERVICES PERTAINING TO ENVIRONMENTAL RISK FACTORS; REAL PROPERTY RISK ASSESSMENT INFORMATION SERVICES, AND RESEARCH SERVICES PROVIDING REVIEW OF FEDERAL, STATE AND LOCAL GOVERNMENT RECORDS TO ASCERTAIN EXISTENCE OF SPECIFIC PARCELS OF REAL PROPERTY IN ONE OR MORE GOVERNMENT DATABASES; BY MEANS OF A GLOBAL COMPUTER NETWORK (U.S. CLS. 100 AND 101).

FIRST USE 3-1-2007; IN COMMERCE 3-1-2007.

CLASS 42—(Continued).

3,313,132. HOUGHTON MIFFLIN COMPANY, BOSTON, MA. SN 76-638,654. PUB. 8-22-2006, FILED 5-11-2005.

TURNING INFORMATION INTO ACHIEVEMENT

THE MARK CONSISTS OF STANDARD CHARACTERS WITHOUT CLAIM TO ANY PARTICULAR FONT, STYLE, SIZE, OR COLOR.

FOR PROVIDING NON-DOWNLOADABLE WEB-BASED COMPUTER SOFTWARE FOR DESIGNING, SCANNING, PREPARING, DEVELOPING, MANAGING, MAINTAINING, SCORING, TRACKING, REPORTING, AND ANALYZING TESTS IN THE FIELD OF EDUCATIONAL ASSESSMENT FOR GRADES K-12 (U.S. CLS. 100 AND 101).

FIRST USE 1-0-2003; IN COMMERCE 1-0-2003.

3,313,153. TRALLIANCE CORPORATION, NEW YORK, NY. SN 76-643,524. PUB. 6-20-2006, FILED 7-25-2005.



NO CLAIM IS MADE TO THE EXCLUSIVE RIGHT TO USE "TRAVEL", APART FROM THE MARK AS SHOWN.

THE COLOR(S) GREEN AND BLUE IS/ARE CLAIMED AS A FEATURE OF THE MARK.

THE COLOR GREEN APPEARS IN THE WORD "TRAVEL" AND THE PRECEDING PERIOD; AND TWO SHADES OF BLUE APPEAR IN THE SPHERE DESIGN.

FOR REGISTRATION OF SPONSORED DOMAIN NAMES TO SERVE THE TRAVEL AND TOURISM COMMUNITY ON A GLOBAL COMPUTER NETWORK (U.S. CLS. 100 AND 101).

FIRST USE 9-7-2005; IN COMMERCE 9-7-2005.

CLASS 42—(Continued).

3,313,175. WINK TECHNOLOGIES INC. (A DELAWARE CORPORATION), LOS ALTOS, CA. SN 76-650,668. PUB. 3-27-2007, FILED 11-21-2005.



THE MARK CONSISTS OF STANDARD CHARACTERS WITHOUT CLAIM TO ANY PARTICULAR FONT, STYLE, SIZE, OR COLOR.

FOR COMPUTER SERVICES, NAMELY, PROVIDING SEARCH ENGINES FOR OBTAINING DATA ON A GLOBAL COMPUTER NETWORK (U.S. CLS. 100 AND 101).

FIRST USE 10-5-2005; IN COMMERCE 10-5-2005.

3,313,217. GRAVITY TECHNOLOGIES, SAN FRANCISCO, CA. SN 76-662,973. PUB. 4-24-2007, FILED 7-13-2006.



THE MARK CONSISTS OF STANDARD CHARACTERS WITHOUT CLAIM TO ANY PARTICULAR FONT, STYLE, SIZE, OR COLOR.

FOR PROVIDING TEMPORARY USE OF ONLINE, NON-DOWNLOADABLE SOFTWARE FOR TRACKING EMPLOYEES, PERFORMANCE MANAGEMENT, TESTING EMPLOYEES, AND DATABASE MANAGEMENT, ALL IN THE FIELDS OF EMPLOYMENT HIRING, RECRUITING, PLACEMENT AND STAFFING (U.S. CLS. 100 AND 101).

FIRST USE 6-21-2004; IN COMMERCE 11-0-2006.

3,313,230. UNITY POWER LLC, ALEXANDRIA, VA. SN 76-666,250. PUB. 5-1-2007, FILED 9-15-2006.



THE MARK CONSISTS OF STANDARD CHARACTERS WITHOUT CLAIM TO ANY PARTICULAR FONT, STYLE, SIZE, OR COLOR.

FOR CONSULTING SERVICES IN THE FIELD OF ENGINEERING (U.S. CLS. 100 AND 101).

FIRST USE 9-18-2006; IN COMMERCE 1-1-2007.

CLASS 42—(Continued).

3,313,287. KIMBALL, RONALD W., MOUNTAIN VIEW, CA. SN 77-017,849. PUB. 5-22-2007, FILED 10-10-2006.

kimballstock

THE MARK CONSISTS OF STANDARD CHARACTERS WITHOUT CLAIM TO ANY PARTICULAR FONT, STYLE, SIZE, OR COLOR.

FOR STOCK PHOTOGRAPHY SERVICES, NAMELY, LEASING REPRODUCTION RIGHTS OF PHOTOGRAPHS AND TRANSPARENCIES TO OTHERS (U.S. CLS. 100 AND 101).

FIRST USE 11-1-2006; IN COMMERCE 11-1-2006.

3,313,297. BRIDGES, SHEILA, NEW YORK, NY. SN 77-026,236. PUB. 5-1-2007, FILED 10-20-2006.

THE NESTMAKER

THE MARK CONSISTS OF STANDARD CHARACTERS WITHOUT CLAIM TO ANY PARTICULAR FONT, STYLE, SIZE, OR COLOR.

FOR PROVIDING INFORMATION ON-LINE IN THE FIELDS OF ARCHITECTURE, INTERIOR DESIGN, AND DECORATION (U.S. CLS. 100 AND 101).

FIRST USE 2-14-2007; IN COMMERCE 2-14-2007.

3,313,331. VELTEK ASSOCIATES, INC., MALVERN, PA. SN 77-053,167. PUB. 5-15-2007, FILED 11-29-2006.



THE MARK CONSISTS OF A CIRCLE WITH STRIPES AND THE WORD CORE WITH A CHECK MARK THROUGH THE O.

FOR LABORATORY AND CONSULTING SERVICES, NAMELY, TESTING OF LABORATORY AND MANUFACTURING FACILITIES DRUG PRODUCTION SURFACES (U.S. CLS. 100 AND 101).

FIRST USE 3-0-2007; IN COMMERCE 3-0-2007.

CLASS 42—(Continued).

3,313,369. TIAX LLC, CAMBRIDGE, MA. SN 78-212,760. PUB. 3-2-2004, FILED 2-10-2003.

SUPPORTIVE HOME

NO CLAIM IS MADE TO THE EXCLUSIVE RIGHT TO USE "HOME", APART FROM THE MARK AS SHOWN.

FOR DESIGN AND TESTING FOR NEW PRODUCT DEVELOPMENT FOR PRODUCTS AND SERVICES FOR RESIDENTIAL USE; PRODUCT DEVELOPMENT FOR PRODUCTS FOR RESIDENTIAL USE (U.S. CLS. 100 AND 101).

FIRST USE 5-12-2004; IN COMMERCE 5-12-2004.

3,313,430. ALBERT S. HAGOOD, PORTLAND, OR. SN 78-377,137. PUB. 3-1-2005, FILED 3-2-2004.

MADE

THE MARK CONSISTS OF STANDARD CHARACTERS WITHOUT CLAIM TO ANY PARTICULAR FONT, STYLE, SIZE, OR COLOR.

FOR DESIGN OF FURNITURE, DESIGN SERVICES IN THE FIELD OF INTERIOR DESIGN AND INTERIOR SPACE LAYOUT (U.S. CLS. 100 AND 101).

FIRST USE 7-3-2003; IN COMMERCE 5-17-2006.

CLASS 42—(Continued).

3,313,448. VANILLASOFT, INC, PLANO, TX. SN 78-416,892. PUB. 5-31-2005, FILED 5-11-2004.



THE COLOR(S) BLUE AND ORANGE IS/ARE CLAIMED AS A FEATURE OF THE MARK.

THE MARK CONSISTS OF ENLARGED, CAPITAL LETTER V, AND STYLIZED, CAPITAL LETTER S IN WORD VANILLASOFT; VANILLA IS IN COLOR BLUE AND SOFT IS IN COLOR ORANGE.

FOR COMPUTER SERVICES, NAMELY, DESIGNING, DEVELOPING, IMPLEMENTING, INSTALLING, MAINTENANCE, UPGRADING, AND CONFIGURING COMPUTER SOFTWARE FOR OTHERS AND PROVIDING RELATED CONSULTATION THERETO; PROVIDING TECHNICAL SUPPORT IN THE NATURE OF TROUBLE-SHOOTING COMPUTER HARDWARE AND SOFTWARE PROBLEMS; PROVIDING TEMPORARY USE OF ON-LINE NON-DOWNLOADABLE SOFTWARE TO STORE, MANAGE, TRACK, ANALYZE AND REPORT DATA IN THE FIELD OF MARKETING, PROMOTION, SALES, CUSTOMER INFORMATION, CUSTOMER RELATIONSHIP MANAGEMENT, EMPLOYEE EFFICIENCY, NON-PROFIT FUNDRAISING AND CUSTOMER AND PROSPECT SURVEYING; PROVIDING ONLINE INFORMATION REGARDING COMPUTER SOFTWARE AND COMPUTER SERVICES (U.S. CLS. 100 AND 101).

FIRST USE 8-25-2003; IN COMMERCE 8-25-2003.

3,313,471. HEARTLAND HEALTH SOLUTIONS, BRENTWOOD, TN. SN 78-452,953. PUB. 9-27-2005, FILED 7-19-2004.

Saatwic

THE MARK CONSISTS OF STANDARD CHARACTERS WITHOUT CLAIM TO ANY PARTICULAR FONT, STYLE, SIZE, OR COLOR.

THE FOREIGN WORDING IN THE MARK TRANSLATES INTO ENGLISH AS PURITY, STRENGTH OR HAPPINESS, FOR FOOD PRODUCT DEVELOPMENT (U.S. CLS. 100 AND 101).

FIRST USE 5-7-2007; IN COMMERCE 5-7-2007.

CLASS 42—(Continued).

3,313,480. FEDERAL NATIONAL MORTGAGE ASSOCIATION, DBA FANNIE MAE, WASHINGTON, DC. SN 78-472,927. PUB. 1-31-2006, FILED 8-24-2004.

ECOMMITONE

THE MARK CONSISTS OF STANDARD CHARACTERS WITHOUT CLAIM TO ANY PARTICULAR FONT, STYLE, SIZE, OR COLOR.

FOR APPLICATION SERVICE PROVIDER (ASP) SERVICES FEATURING COMPUTER SOFTWARE FOR USE IN THE FIELD OF PROCESSING MORTGAGE LOANS (U.S. CLS. 100 AND 101).

FIRST USE 8-30-2004; IN COMMERCE 8-30-2004.

3,313,499. BRIAN MADDEN COMPANY, LLC, THE, SILVER SPRINGS, MD. SN 78-488,097. PUB. 12-13-2005, FILED 9-22-2004.

BRIFORUM

THE MARK CONSISTS OF STANDARD CHARACTERS WITHOUT CLAIM TO ANY PARTICULAR FONT, STYLE, SIZE, OR COLOR.

FOR CONSULTING SERVICES IN THE FIELD OF DESIGN, SELECTION, IMPLEMENTATION AND USE OF COMPUTER HARDWARE AND SOFTWARE SYSTEMS (U.S. CLS. 100 AND 101).

FIRST USE 9-1-2004; IN COMMERCE 9-1-2004.

CLASS 42—(Continued).

3,313,529. JOHNSTON-MAIN, IAN GEORGE, ARLINGTON, TX. SN 78-530,508. PUB. 7-25-2006, FILED 12-10-2004.

CLASS 42—(Continued).

3,313,556. DESIGNBOMB SOLUTIONS INC., VANCOUVER, CANADA. SN 78-551,281. PUB. 12-5-2006, FILED 1-20-2005.



designbomb

NO CLAIM IS MADE TO THE EXCLUSIVE RIGHT TO USE "GRAPHICS", APART FROM THE MARK AS SHOWN. FOR GRAPHIC DESIGN SERVICES FEATURING VEHICLE GRAPHICS, BANNERS AND SIGNS (U.S. CLS. 100 AND 101).
FIRST USE 1-14-2004; IN COMMERCE 3-23-2005.

THE MARK CONSISTS OF STANDARD CHARACTERS WITHOUT CLAIM TO ANY PARTICULAR FONT, STYLE, SIZE, OR COLOR.
PRIORITY CLAIMED UNDER SEC. 44(D) ON CANADA APPLICATION NO. 1244331, FILED 1-20-2005, REG. NO. TMA661489, DATED 3-24-2006, EXPIRES 3-24-2021.
FOR INDUSTRIAL DESIGN (U.S. CLS. 100 AND 101).
FIRST USE 6-1-2002; IN COMMERCE 7-1-2006.

3,313,546. HODGES TRANSPORTATION, INC., DBA NEVADA AUTOMOTIVE TEST CENTER, CARSON CITY, NV. SN 78-542,039. PUB. 12-13-2005, FILED 1-4-2005.

3,313,613. GUYTECH USA, INC., HILLSDALE, NY. SN 78-595,912. PUB. 12-12-2006, FILED 3-28-2005.



DRAGONFLY

FOR MOTOR VEHICLE PRODUCT TESTING SERVICES FOR OTHERS, NAMELY TESTING AND EVALUATING MOTOR VEHICLE PERFORMANCE FOR THE ROADS, TRAILS AND TERRAIN OVER WHICH THE MOTOR VEHICLE WILL OPERATE (U.S. CLS. 100 AND 101).
FIRST USE 4-30-2007; IN COMMERCE 4-30-2007.

THE MARK CONSISTS OF STANDARD CHARACTERS WITHOUT CLAIM TO ANY PARTICULAR FONT, STYLE, SIZE, OR COLOR.
FOR PROVIDING TEMPORARY USE OF ONLINE NON-DOWNLOADABLE MULTIMEDIA SOFTWARE FOR ALLOWING USERS TO VIEW INTERNET WEBSITES AND OTHER DIGITAL FILES AND THEN SHARE THE RESULTS VIA ELECTRONIC MAIL OR DOWNLOADABLE LISTINGS (U.S. CLS. 100 AND 101).
FIRST USE 4-1-2005; IN COMMERCE 5-1-2005.

CLASS 42—(Continued).

3,313,697. THE KRAMER GROUP, INC., ORLANDO, FL. SN 78-632,641. PUB. 9-12-2006, FILED 5-18-2005.

VRFi

THE MARK CONSISTS OF STANDARD CHARACTERS WITHOUT CLAIM TO ANY PARTICULAR FONT, STYLE, SIZE, OR COLOR.

FOR QUALITY CONTROL SERVICES FOR OTHERS, NAMELY, MONITORING OF HEALTH CARE FORM QUALITY VIA A WEB-BASED SYSTEM (U.S. CLS. 100 AND 101).

FIRST USE 6-8-2005; IN COMMERCE 6-8-2005.

3,313,717. WEST PUBLISHING CORPORATION, EAGAN, MN. SN 78-641,972. PUB. 9-5-2006, FILED 6-2-2005.

WEST RESEARCH PARTNER

THE MARK CONSISTS OF STANDARD CHARACTERS WITHOUT CLAIM TO ANY PARTICULAR FONT, STYLE, SIZE, OR COLOR.

NO CLAIM IS MADE TO THE EXCLUSIVE RIGHT TO USE "RESEARCH", APART FROM THE MARK AS SHOWN.

FOR COMPUTER SERVICES, NAMELY, PROVIDING LAW FIRMS AN ONLINE NON-DOWNLOADABLE COMPUTER SOFTWARE INTERFACE WHICH PROVIDES USERS WITH SINGLE SIGN-ON ACCESS TO INTERNET RESEARCH WEBSITES, THEREBY PROVIDING MANAGEMENT THE ABILITY TO MONITOR USE, ALLOCATE RESEARCH COSTS, AND CUSTOMIZE RATES OF THOSE RESEARCH WEBSITES (U.S. CLS. 100 AND 101).

FIRST USE 7-18-2005; IN COMMERCE 7-18-2005.

3,313,762. INSPECTORATE HOLDINGS PLC, WITHAM, UNITED KINGDOM. SN 78-660,079. PUB. 10-10-2006, FILED 6-28-2005.

INSPECTORATE

THE MARK CONSISTS OF STANDARD CHARACTERS WITHOUT CLAIM TO ANY PARTICULAR FONT, STYLE, SIZE, OR COLOR.

FOR TECHNOLOGY, SUPERVISION, INSPECTION AND TESTING IN THE FIELD OF PRODUCT QUALITY CONTROL (U.S. CLS. 100 AND 101).

FIRST USE 0-0-1987; IN COMMERCE 0-0-1987.

CLASS 42—(Continued).

3,313,872. SPECK PRODUCT DESIGN INC., PALO ALTO, CA. SN 78-709,454. PUB. 5-16-2006, FILED 9-8-2005.

Speck Design

THE MARK CONSISTS OF STANDARD CHARACTERS WITHOUT CLAIM TO ANY PARTICULAR FONT, STYLE, SIZE, OR COLOR.

NO CLAIM IS MADE TO THE EXCLUSIVE RIGHT TO USE "DESIGN", APART FROM THE MARK AS SHOWN.

FOR PRODUCT DESIGN AND DEVELOPMENT, INDUSTRIAL DESIGN, MECHANICAL DESIGN AND ENGINEERING, ELECTRICAL ENGINEERING, PRODUCT RESEARCH (U.S. CLS. 100 AND 101).

FIRST USE 3-0-2006; IN COMMERCE 3-0-2006.

3,313,895. SCHMID, CHRISTIAN, HERBOLZHEIM, FED REP GERMANY. SN 78-717,634. PUB. 8-8-2006, FILED 9-21-2005.

RAPID SHARE

THE MARK CONSISTS OF STANDARD CHARACTERS WITHOUT CLAIM TO ANY PARTICULAR FONT, STYLE, SIZE, OR COLOR.

FOR WEB HOSTING, NAMELY, HOSTING THE WEB SITES OF OTHERS ON A COMPUTER SERVER FOR A GLOBAL COMPUTER NETWORK, LOCAL AREA NETWORKS, WIDE AREA NETWORKS, PRIVATE NETWORKS; CONSULTING AND DESIGN SERVICES IN THE FIELD OF INFORMATION TECHNOLOGY AND GLOBAL COMPUTER COMMUNICATION NETWORKS; PROVIDING HOSTING SERVICES FOR THE WEB SITES AND DIGITAL CONTENT OF RESELLERS WHO HOST THE WEBSITES, DATA, E-MAIL, AUDIO, VIDEO, GRAPHICS AND CONTENT OF OTHERS ON COMPUTER SERVERS FOR COMPUTER NETWORKS, LOCAL AREA NETWORKS, WIDE AREA NETWORKS, PRIVATE NETWORKS AND THE INTERNET; COMPUTER SERVICES, NAMELY, PROVIDING TEMPORARY USE OF ON-LINE NON-DOWNLOADABLE SOFTWARE FOR STORAGE, TRANSMISSION AND MANIPULATION OF DIGITAL CONTENT; COMPUTER HARDWARE AND SOFTWARE CONSULTATION; CONSULTING SERVICES IN THE FIELD OF COMPUTER DATA BACKUP AND RECOVERY (U.S. CLS. 100 AND 101).

FIRST USE 11-1-2006; IN COMMERCE 11-1-2006.

CLASS 42—(Continued).

3,313,934. ALLION TEST LABS, INC., TAIPEI CITY, TAIWAN. SN 78-737,663. PUB. 1-9-2007, FILED 10-20-2005.



FOR CONSUMER PRODUCT PERFORMANCE TESTING; CONSUMER PRODUCT FUNCTION TESTING; PRODUCT COMPATIBILITY AND INTEROPERABILITY TESTING; CONSUMER PRODUCT SAFETY TESTING; PRODUCT SAFETY TESTING FOR OTHERS; TESTING, ANALYSIS AND EVALUATION OF THE GOODS AND SERVICES OF OTHERS FOR THE PURPOSE OF CERTIFICATION; INSPECTION OF EQUIPMENT FOR OTHERS; TECHNOLOGY SUPERVISION AND INSPECTION IN THE FIELD OF PRODUCT QUALITY CONTROL (U.S. CLS. 100 AND 101).

FIRST USE 7-1-2005; IN COMMERCE 7-1-2005.

3,314,004. CONDENET INC., NEW YORK, NY. SN 78-751,881. PUB. 10-24-2006, FILED 11-11-2005.



THE MARK CONSISTS OF STANDARD CHARACTERS WITHOUT CLAIM TO ANY PARTICULAR FONT, STYLE, SIZE, OR COLOR.

FOR COMPUTER SERVICES NAMELY HOSTING DIGITAL CONTENT IN THE NATURE OF USER GENERATED PROFILE AND CUSTOMIZABLE PHOTOBOOKS ACCESSIBLE VIA THE INTERNET AND VIA MOBILE BASED TECHNOLOGY; COMPUTER SERVICES NAMELY PROVIDING NON-DOWNLOADABLE COMPUTER SOFTWARE THAT FACILITATES PEER TO PEER AND GROUP COMMUNICATION, INTERACTION AND CONNECTIONS BASED ON INTERESTS (U.S. CLS. 100 AND 101).

FIRST USE 12-27-2006; IN COMMERCE 12-27-2006.

CLASS 42—(Continued).

3,314,005. CONDENET INC., NEW YORK, NY. SN 78-751,892. PUB. 10-24-2006, FILED 11-11-2005.



THE MARK CONSISTS OF STANDARD CHARACTERS WITHOUT CLAIM TO ANY PARTICULAR FONT, STYLE, SIZE, OR COLOR.

FOR COMPUTER SERVICES NAMELY HOSTING DIGITAL CONTENT IN THE NATURE OF USER GENERATED PROFILE AND CUSTOMIZABLE PHOTOBOOKS ACCESSIBLE VIA THE INTERNET AND VIA MOBILE BASED TECHNOLOGY; COMPUTER SERVICES NAMELY PROVIDING NON-DOWNLOADABLE COMPUTER SOFTWARE THAT FACILITATES PEER TO PEER AND GROUP COMMUNICATION, INTERACTION AND CONNECTIONS BASED ON INTERESTS (U.S. CLS. 100 AND 101).

FIRST USE 12-27-2006; IN COMMERCE 12-27-2006.

3,314,019. HUNTER DOUGLAS INC., UPPER SADDLE RIVER, NJ. SN 78-755,012. PUB. 8-1-2006, FILED 11-16-2005.



THE MARK CONSISTS OF STANDARD CHARACTERS WITHOUT CLAIM TO ANY PARTICULAR FONT, STYLE, SIZE, OR COLOR.

FOR PROVIDING ONLINE NON-DOWNLOADABLE SOFTWARE FOR CALENDARING, TRACKING MARKETING AND SALES PROJECTS, AND CUSTOMER ACCOUNT AND CUSTOMER DATABASE MANAGEMENT IN THE FIELD OF WINDOW TREATMENTS (U.S. CLS. 100 AND 101).

FIRST USE 7-1-2005; IN COMMERCE 7-1-2005.

3,314,085. SPROOSE, INC., DANVILLE, CA. SN 78-766,839. PUB. 8-8-2006, FILED 12-5-2005.



THE MARK CONSISTS OF STANDARD CHARACTERS WITHOUT CLAIM TO ANY PARTICULAR FONT, STYLE, SIZE, OR COLOR.

FOR COMPUTER SERVICES, NAMELY, PROVIDING SEARCH ENGINES FOR OBTAINING DATA ON A GLOBAL COMPUTER NETWORK; DESIGN AND DEVELOPMENT OF ONLINE COMPUTER SOFTWARE SYSTEMS (U.S. CLS. 100 AND 101).

FIRST USE 11-1-2005; IN COMMERCE 11-1-2005.

CLASS 42—(Continued).

3,314,096. SOCIETY OF PETROLEUM ENGINEERS (SPE), INC., RICHARDSON, TX. SN 78-768,423. PUB. 3-6-2007, FILED 12-7-2005.

LOOKUPSTREAM

THE MARK CONSISTS OF STANDARD CHARACTERS WITHOUT CLAIM TO ANY PARTICULAR FONT, STYLE, SIZE, OR COLOR.

FOR COMPUTER SERVICES, NAMELY, PROVIDING SEARCH ENGINES FOR OBTAINING DATA RELATED TO THE WORLDWIDE OIL AND GAS INDUSTRY (U.S. CLS. 100 AND 101).

FIRST USE 7-0-2006; IN COMMERCE 7-0-2006.

3,314,098. CONGOLEUM CORPORATION, MERCERVILLE, NJ. SN 78-768,495. PUB. 9-12-2006, FILED 12-7-2005.

KITCHENVISION

THE MARK CONSISTS OF STANDARD CHARACTERS WITHOUT CLAIM TO ANY PARTICULAR FONT, STYLE, SIZE, OR COLOR.

FOR PROVIDING INFORMATION WITH RESPECT TO HOME DESIGN BY MEANS OF A GLOBAL COMPUTER NETWORK (U.S. CLS. 100 AND 101).

FIRST USE 3-31-2006; IN COMMERCE 3-31-2006.

3,314,135. TSENG, ALTA K., SAN FRANCISCO, CA. SN 78-775,166. PUB. 8-22-2006, FILED 12-16-2005.

FEMPIRE

THE MARK CONSISTS OF STANDARD CHARACTERS WITHOUT CLAIM TO ANY PARTICULAR FONT, STYLE, SIZE, OR COLOR.

FOR HOSTING OF DIGITAL CONTENT ON THE INTERNET; PROVIDING CUSTOMIZED ON-LINE WEB PAGES FEATURING USER-DEFINED INFORMATION (U.S. CLS. 100 AND 101).

FIRST USE 1-1-2003; IN COMMERCE 4-26-2006.

CLASS 42—(Continued).

3,314,153. INFORMATION DYNAMICS, INC., INDIANAPOLIS, IN. SN 78-777,080. PUB. 3-20-2007, FILED 12-20-2005.

SINGLEPOINT

THE MARK CONSISTS OF STANDARD CHARACTERS WITHOUT CLAIM TO ANY PARTICULAR FONT, STYLE, SIZE, OR COLOR.

FOR PROVIDING ONLINE NON-DOWNLOADABLE BUSINESS MANAGEMENT SOFTWARE THAT ENABLES EMPLOYERS TO PRESENT, STORE, MANAGE, TRACK AND ANALYZE DATA IN THE FIELD OF HUMAN RESOURCES, PAYROLL AND WORKFORCE MANAGEMENT (U.S. CLS. 100 AND 101).

FIRST USE 1-30-2006; IN COMMERCE 3-30-2006.

3,314,272. XENCOR, INC., MONROVIA, CA. SN 78-798,351. PUB. 8-8-2006, FILED 1-24-2006.

IMMUNOFILTER

THE MARK CONSISTS OF STANDARD CHARACTERS WITHOUT CLAIM TO ANY PARTICULAR FONT, STYLE, SIZE, OR COLOR.

FOR PROVIDING DATABASES USED IN CONNECTION WITH PHARMACEUTICAL RESEARCH AND DEVELOPMENT AND PROTIOMICS; DEVELOPMENT, UPDATING AND MAINTENANCE OF SOFTWARE AND DATABASES (U.S. CLS. 100 AND 101).

FIRST USE 12-16-2005; IN COMMERCE 12-16-2005.

3,314,298. ON24, INC., SAN FRANCISCO, CA. SN 78-804,843. PUB. 10-10-2006, FILED 2-1-2006.

LEADVANTAGE

THE MARK CONSISTS OF STANDARD CHARACTERS WITHOUT CLAIM TO ANY PARTICULAR FONT, STYLE, SIZE, OR COLOR.

FOR PROVIDING ONLINE NON-DOWNLOADABLE SOFTWARE FOR USE IN CUSTOMER RELATIONSHIP MANAGEMENT, FOR TRACKING, SORTING, AND ANALYZING INFORMATION AND DATA AND CREATING REPORTS, IN THE FIELD OF BUSINESS MANAGEMENT AND PRODUCT AND SERVICE SALES PROSPECTS (U.S. CLS. 100 AND 101).

FIRST USE 4-0-2006; IN COMMERCE 5-0-2006.

CLASS 42—(Continued).

3,314,321. BAILEY, VINCENT P., LAGUNA NIGUEL, CA. SN 78-809,179. PUB. 10-3-2006, FILED 2-7-2006.

CLASS 42—(Continued).

3,314,375. TORRE, DAVID, P, EL GRANADA, CA. SN 78-818,331. PUB. 10-31-2006, FILED 2-18-2006.

WE COMPLETE YOUR BRAND

THE MARK CONSISTS OF STANDARD CHARACTERS WITHOUT CLAIM TO ANY PARTICULAR FONT, STYLE, SIZE, OR COLOR.

FOR LEGAL SERVICES (U.S. CLS. 100 AND 101).
FIRST USE 10-23-2006; IN COMMERCE 4-4-2007.



3,314,331. QUALITY ASSURE SERVICES, INC., ORLANDO, FL. SN 78-810,066. PUB. 5-15-2007, FILED 2-8-2006.

INRCARE

THE MARK CONSISTS OF STANDARD CHARACTERS WITHOUT CLAIM TO ANY PARTICULAR FONT, STYLE, SIZE, OR COLOR.

FOR APPLICATION SERVICE PROVIDER (ASP) FEATURING HIPPA COMPLIANT SOFTWARE FOR USE IN WEB-BASED DATABASE MANAGEMENT SYSTEMS FOR MONITORING BLOOD LEVELS OF PATIENTS THAT ARE TAKING ANTI-COAGULATION MEDICINE (U.S. CLS. 100 AND 101).

FIRST USE 1-13-2006; IN COMMERCE 1-13-2006.

THE COLOR(S) PURPLE, BLACK, WHITE, AND BLUE IS/ARE CLAIMED AS A FEATURE OF THE MARK.

THE MARK CONSISTS OF THE DESIGN OF A MOLECULAR STRUCTURE SHADED IN PURPLE AND OUTLINED IN BLACK AND THE WORDING ATOMIC FISSION APPEARING SHADED IN BLUE WITH A BLACK OUTLINE AS AN OVERLAY TO THE MOLECULAR STRUCTURE DESIGN. THE BACKGROUND OF THE MARK IS WHITE.

FOR APPLICATION SERVICE PROVIDER (ASP), NAMELY, HOSTING COMPUTER SOFTWARE APPLICATIONS OF OTHERS (U.S. CLS. 100 AND 101).

FIRST USE 2-18-2006; IN COMMERCE 5-10-2007.

3,314,465. SITE MANAGEWARE, INC., FORT LAUDERDALE, FL. SN 78-837,344. PUB. 1-16-2007, FILED 3-15-2006.

SITE MANAGEWARE

3,314,348. KINNUNEN, NANCY, SAN FRANCISCO, CA. SN 78-814,189. PUB. 10-17-2006, FILED 2-14-2006.

ENERGETIC AESTHETIX

THE MARK CONSISTS OF STANDARD CHARACTERS WITHOUT CLAIM TO ANY PARTICULAR FONT, STYLE, SIZE, OR COLOR.

FOR INTERIOR DECORATING SERVICES EMPHASIZING BALANCE AND HARMONY FOR THE SOPHISTICATED HOME AND/OR BUSINESS (U.S. CLS. 100 AND 101).

FIRST USE 5-2-2007; IN COMMERCE 5-2-2007.

THE MARK CONSISTS OF STANDARD CHARACTERS WITHOUT CLAIM TO ANY PARTICULAR FONT, STYLE, SIZE, OR COLOR.

NO CLAIM IS MADE TO THE EXCLUSIVE RIGHT TO USE "SITE", APART FROM THE MARK AS SHOWN.

FOR PROVIDING TEMPORARY USE OF NON-DOWNLOADABLE COMPUTER SOFTWARE FOR MONITORING AND CONTROLLING THE PROCESS OF SELLING UNITS OF REAL ESTATE (U.S. CLS. 100 AND 101).

FIRST USE 1-31-2002; IN COMMERCE 1-31-2002.

CLASS 42—(Continued).

3,314,536. ENFUSION2, LLC, FAYETTEVILLE, AR. SN 78-868,508. PUB. 11-28-2006, FILED 4-24-2006.

enFusion[®]

THE MARK CONSISTS OF SPACED LETTERS WITH A SUPERSCRIP 2 AFTER THE LAST LETTER FORMING A NAME.

FOR ARCHITECTURAL DESIGN; COMPUTER AIDED DESIGN FOR OTHERS; DESIGN OF SPECIALTY INTERIOR AND EXTERIOR ENVIRONMENT SETTINGS; INTERIOR DECORATION CONSULTATION; SHOP INTERIOR DESIGN (U.S. CLS. 100 AND 101).

FIRST USE 4-13-2006; IN COMMERCE 4-1-2007.

3,314,550. CONNELLY, THOMAS E, NATICK, MA. SN 78-873,698. PUB. 12-5-2006, FILED 5-1-2006.

NetWatch

THE MARK CONSISTS OF STANDARD CHARACTERS WITHOUT CLAIM TO ANY PARTICULAR FONT, STYLE, SIZE, OR COLOR.

FOR CONSULTING SERVICES IN THE FIELD OF DESIGN, SELECTION, IMPLEMENTATION AND USE OF COMPUTER HARDWARE AND SOFTWARE SYSTEMS FOR OTHERS (U.S. CLS. 100 AND 101).

FIRST USE 8-1-2006; IN COMMERCE 8-1-2006.

3,314,559. APPLIED LOGIC SYSTEMS, INC., CAMBRIDGE, MA. SN 78-877,185. PUB. 12-26-2006, FILED 5-5-2006.

STRONG BRAIN

THE MARK CONSISTS OF STANDARD CHARACTERS WITHOUT CLAIM TO ANY PARTICULAR FONT, STYLE, SIZE, OR COLOR.

FOR PROVIDING TEMPORARY USE OF ON-LINE NON-DOWNLOADABLE SOFTWARE FOR USE IN ADULT MENTAL DEVELOPMENT AND PRESERVATION OF MENTAL FUNCTIONS VIA INTERACTIVE ACTIVITY (U.S. CLS. 100 AND 101).

FIRST USE 10-5-2006; IN COMMERCE 1-8-2007.

CLASS 42—(Continued).

3,314,580. BIO-REFERENCE LABORATORIES, INC., ELMWOOD PARK, NJ. SN 78-882,321. PUB. 1-16-2007, FILED 5-12-2006.

CAREINDEX

THE MARK CONSISTS OF STANDARD CHARACTERS WITHOUT CLAIM TO ANY PARTICULAR FONT, STYLE, SIZE, OR COLOR.

FOR MEDICAL LABORATORY SERVICES, NAMELY, PROVIDING TEST RESULTS ANALYSIS AND EVALUATION FOR THE HEALTH CARE AND HEALTH CARE INSURANCE INDUSTRIES (U.S. CLS. 100 AND 101).

FIRST USE 6-18-2007; IN COMMERCE 6-18-2007.

3,314,594. HERITAGE PRESERVATION CORPORATION, SPARTANBURG, SC. SN 78-885,275. PUB. 12-26-2006, FILED 5-17-2006.

OneSite

THE MARK CONSISTS OF STANDARD CHARACTERS WITHOUT CLAIM TO ANY PARTICULAR FONT, STYLE, SIZE, OR COLOR.

FOR PROVIDING TEMPORARY USE OF NON-DOWNLOADABLE SOFTWARE FOR GENERATING REPORTS RELATING TO THE PRODUCTION AND DELIVERY OF MAIL, EXCLUDING ELECTRONIC MAIL (U.S. CLS. 100 AND 101).

FIRST USE 7-26-2006; IN COMMERCE 7-26-2006.

3,314,622. VERACODE, INC., BURLINGTON, MA. SN 78-892,326. PUB. 1-2-2007, FILED 5-24-2006.

VERACODE

THE MARK CONSISTS OF STANDARD CHARACTERS WITHOUT CLAIM TO ANY PARTICULAR FONT, STYLE, SIZE, OR COLOR.

FOR COMPUTER SOFTWARE RISK ASSESSMENT SERVICES (U.S. CLS. 100 AND 101).

FIRST USE 1-22-2007; IN COMMERCE 1-22-2007.

CLASS 42—(Continued).

3,314,691. GALLEGOS, JESUS, GUADALAJARA, MEXICO.
SN 78-908,905. PUB. 1-9-2007, FILED 6-15-2006.



NO CLAIM IS MADE TO THE EXCLUSIVE RIGHT TO USE "DESIGN CENTER", APART FROM THE MARK AS SHOWN.

THE COLORS RED, BLACK AND WHITE ARE CLAIMED AS A FEATURE OF THE MARK.

THE MARK CONSISTS OF A RED RECTANGLE WITH THE WORD "GA" AT ITS BOTTOM WRITTEN IN WHITE LETTERS WITH THE WORDING : DESIGN CENTER IN BLACK BENEATH. OVER THE RECTANGLE, THE WORD "GU" IS WRITTEN IN BLACK LETTERS, THE LETTER "U" LEANING OVER THE LETTER "G" AT ITS LEFT.

FOR ARCHITECTURAL DESIGN; COMMERCIAL ART DESIGN; DESIGN OF SPECIALTY INTERIOR AND EXTERIOR ENVIRONMENT SETTINGS; DESIGN SKETCHING OF PACKAGING, CONTAINERS, DINERWARE AND TABLE UTENSILS; GRAPHIC ART DESIGN; GRAPHIC DESIGN SERVICES; INDUSTRIAL DESIGN (U.S. CLS. 100 AND 101).

FIRST USE 7-20-2006; IN COMMERCE 7-20-2006.

3,314,692. HIGH INDUSTRIES, INC., LANCASTER, PA. SN
78-908,944. PUB. 3-27-2007, FILED 6-15-2006.

SpeciFacts

THE MARK CONSISTS OF STANDARD CHARACTERS WITHOUT CLAIM TO ANY PARTICULAR FONT, STYLE, SIZE, OR COLOR.

FOR PROVIDING INFORMATION REGARDING TECHNICAL SPECIFICATIONS IN THE FIELD OF PRECAST CONCRETE (U.S. CLS. 100 AND 101).

FIRST USE 6-0-2006; IN COMMERCE 6-0-2006.

CLASS 42—(Continued).

3,314,700. SWANGIN, TERICA LYNN, LUMBERTON, NJ. SN
78-910,618. PUB. 1-30-2007, FILED 6-16-2006.

PediNatural

THE MARK CONSISTS OF STANDARD CHARACTERS WITHOUT CLAIM TO ANY PARTICULAR FONT, STYLE, SIZE, OR COLOR.

FOR PRODUCT DEVELOPMENT; PRODUCT DEVELOPMENT CONSULTATION; PRODUCT DEVELOPMENT FOR OTHERS; PRODUCT RESEARCH; PRODUCT RESEARCH AND DEVELOPMENT; RESEARCH AND DEVELOPMENT AND CONSULTATION RELATED THERETO IN THE FIELD OF EARLY CHILDHOOD EDUCATION, CURRICULUM DEVELOPMENT, NATUROPATHY, NATURAL HEALTH; RESEARCH AND DEVELOPMENT FOR NEW PRODUCTS FOR OTHERS; SCIENTIFIC AND TECHNICAL CONSULTING AND RESEARCH SERVICES RELATING TO FOODS AND DIETARY SUPPLEMENTS; SCIENTIFIC RESEARCH; SCIENTIFIC RESEARCH AND DEVELOPMENT (U.S. CLS. 100 AND 101).

FIRST USE 7-1-2006; IN COMMERCE 8-21-2006.

3,314,744. NOSA, INC., TOLEDO, OH. SN 78-924,592. PUB. 3-27-2007, FILED 7-7-2006.

NO CLAIM IS MADE TO THE EXCLUSIVE RIGHT TO USE "ISCRIP", APART FROM THE MARK AS SHOWN.

FOR INTERNET BASED SOFTWARE FOR SCRIP PROGRAMS, NAMELY PROVIDING ON-LINE NON-DOWNLOADABLE SOFTWARE FOR TRACKING SCRIP RELATED PURCHASES, SALES AND OTHER SCRIP PROGRAM FINANCIAL ACTIVITIES (U.S. CLS. 100 AND 101).

FIRST USE 1-1-2007; IN COMMERCE 1-1-2007.

CLASS 42—(Continued).

3,314,761. PRACTICEMATCH SERVICES, LLC, SAINT LOUIS, MO. SN 78-931,899. PUB. 2-27-2007, FILED 7-18-2006.

PORTFOLIO

THE MARK CONSISTS OF STANDARD CHARACTERS WITHOUT CLAIM TO ANY PARTICULAR FONT, STYLE, SIZE, OR COLOR.

FOR PROVIDING TEMPORARY USE OF ON-LINE NON-DOWNLOADABLE SOFTWARE FOR USE IN DATABASE MANAGEMENT IN THE FIELD OF PHYSICIAN RECRUITMENT (U.S. CLS. 100 AND 101).

FIRST USE 7-0-2006; IN COMMERCE 7-0-2006.

3,314,776. E.MAGINATION NETWORK, LLC, BALTIMORE, MD. SN 78-936,874. PUB. 5-1-2007, FILED 7-25-2006.

e.magine-it

THE MARK CONSISTS OF STANDARD CHARACTERS WITHOUT CLAIM TO ANY PARTICULAR FONT, STYLE, SIZE, OR COLOR.

FOR ANIMATION AND SPECIAL-EFFECTS DESIGN FOR OTHERS; COMPUTER AIDED DESIGN FOR OTHERS; COMPUTER NETWORK DESIGN FOR OTHERS; COMPUTER SERVICES, NAMELY, DESIGNING AND IMPLEMENTING NETWORK WEB PAGES FOR OTHERS; COMPUTER SERVICES, NAMELY, DESIGNING AND IMPLEMENTING WEB SITES FOR OTHERS; COMPUTER SITE DESIGN; COMPUTER SOFTWARE DESIGN FOR OTHERS; COMPUTER SOFTWARE DESIGN, COMPUTER PROGRAMMING, OR MAINTENANCE OF COMPUTER SOFTWARE; CONSULTANCY IN THE FIELD OF SOFTWARE DESIGN; CONSULTING SERVICES IN THE FIELD OF DESIGN, SELECTION, IMPLEMENTATION AND USE OF COMPUTER HARDWARE AND SOFTWARE SYSTEMS FOR OTHERS; DESIGN AND DEVELOPMENT OF INFORMATION AND DATA BASES; DESIGN AND DEVELOPMENT OF MULTIMEDIA PRODUCTS; DESIGN AND DEVELOPMENT OF NETWORKS; DESIGN AND DEVELOPMENT OF ONLINE COMPUTER SOFTWARE SYSTEMS; DESIGN AND MAINTENANCE OF COMPU-

CLASS 42—(Continued).

TER SITES FOR THIRD PARTIES; DESIGN AND TESTING FOR NEW PRODUCT DEVELOPMENT; DESIGN AND TESTING OF NEW PRODUCTS FOR OTHERS; DESIGN OF COMPUTER HARDWARE, INTEGRATED CIRCUITS, COMMUNICATIONS HARDWARE AND SOFTWARE AND COMPUTER NETWORKS FOR OTHERS; DESIGN OF COMPUTERS FOR OTHERS; DESIGN OF HOME PAGES; DESIGN OF HOME PAGES, COMPUTER SOFTWARE AND WEB SITES; DESIGN OF HOMEPAGES AND WEB-SITES; DESIGN OF HOMEPAGES AND WEBSITES; DESIGN, CREATION, HOSTING AND MAINTENANCE OF INTERNET SITES FOR THIRD PARTIES; DESIGN, CREATION, HOSTING, MAINTENANCE OF WEBSITES FOR OTHERS; DESIGN, DEVELOPMENT AND IMPLEMENTATION OF SOFTWARE; DESIGNING WEBSITES FOR ADVERTISING PURPOSES; DEVELOPMENT, DESIGN AND UPDATING OF HOME PAGES; E-MAIL SYSTEM DESIGN AND IMPLEMENTATION FOR OTHERS; GRAPHIC ART DESIGN; GRAPHIC DESIGN SERVICES (U.S. CLS. 100 AND 101).

FIRST USE 9-1-2006; IN COMMERCE 9-1-2006.

3,314,777. RETIREMENT BRIDGE, LLC, SAN FRANCISCO, CA. SN 78-938,311. PUB. 3-6-2007, FILED 7-26-2006.

RETIREMENT BRIDGE

THE MARK CONSISTS OF STANDARD CHARACTERS WITHOUT CLAIM TO ANY PARTICULAR FONT, STYLE, SIZE, OR COLOR.

NO CLAIM IS MADE TO THE EXCLUSIVE RIGHT TO USE "RETIREMENT", APART FROM THE MARK AS SHOWN.

FOR APPLICATION SERVICE PROVIDER (ASP) FEATURING SOFTWARE USED TO ADMINISTER RETIREMENT RELATIONSHIP BUILDING TOOL FOR USE BETWEEN FINANCIAL PROFESSIONALS AND THEIR CLIENTS/PROSPECTS AND FOR PREPARING AND ELECTRONICALLY DISTRIBUTING WRITTEN REPORTS IN CONNECTION THEREWITH (U.S. CLS. 100 AND 101).

FIRST USE 11-16-2006; IN COMMERCE 11-16-2006.

3,314,834. MICHAELSTEVEN SHERMAN, P.C., WEXFORD, PA. SN 78-956,224. PUB. 4-17-2007, FILED 8-21-2006.

GO TO GUY FOR DUI

THE MARK CONSISTS OF STANDARD CHARACTERS WITHOUT CLAIM TO ANY PARTICULAR FONT, STYLE, SIZE, OR COLOR.

NO CLAIM IS MADE TO THE EXCLUSIVE RIGHT TO USE "DUI", APART FROM THE MARK AS SHOWN.

FOR LEGAL SERVICES (U.S. CLS. 100 AND 101).

FIRST USE 10-1-2006; IN COMMERCE 10-1-2006.

CLASS 42—(Continued).

3,314,870. HONINGFORD, JASON M., CAPE CORAL, FL. SN
78-966,598. PUB. 4-24-2007, FILED 9-3-2006.

PortVista

THE MARK CONSISTS OF STANDARD CHARACTERS WITHOUT CLAIM TO ANY PARTICULAR FONT, STYLE, SIZE, OR COLOR.

FOR COMPUTER SOFTWARE DESIGN, COMPUTER PROGRAMMING, OR MAINTENANCE OF COMPUTER SOFTWARE; DESIGN, CREATION, HOSTING, MAINTENANCE OF WEBSITES FOR OTHERS (U.S. CLS. 100 AND 101).

FIRST USE 1-1-2007; IN COMMERCE 1-1-2007.

CLASS 43—(Continued).

3,313,136. WA GOLF COMPANY, L.L.C., NEWTON, MA. SN
76-639,938. PUB. 2-14-2006, FILED 6-2-2005.



FOR CATERING SERVICES; RESTAURANTS; SNACK BARS; BAR SERVICES; BEVERAGE CART BAR SERVICES; ARRANGING TEMPORARY HOUSING ACCOMMODATIONS; HEALTH RESORT SERVICES, NAMELY, PROVIDING FOOD AND LODGING THAT SPECIALIZE IN PROMOTING PATRONS' GENERAL HEALTH AND WELL-BEING; PROVIDING BANQUET AND SOCIAL FUNCTION FACILITIES FOR SPECIAL OCCASIONS; RESORT HOTEL SERVICES (U.S. CLS. 100 AND 101).

FIRST USE 6-14-2006; IN COMMERCE 6-14-2006.

3,313,273. ACHIM'S FRANCHISING, LLC, ATHENS, GA. SN
77-012,942. PUB. 4-10-2007, FILED 10-3-2006.

UNCLE OTTO'S EUROPEAN EATERY

THE MARK CONSISTS OF STANDARD CHARACTERS WITHOUT CLAIM TO ANY PARTICULAR FONT, STYLE, SIZE, OR COLOR.

NO CLAIM IS MADE TO THE EXCLUSIVE RIGHT TO USE "EUROPEAN EATERY", APART FROM THE MARK AS SHOWN.

FOR RESTAURANT SERVICES (U.S. CLS. 100 AND 101).

FIRST USE 10-4-2006; IN COMMERCE 10-4-2006.

3,313,274. ACHIM'S FRANCHISING, LLC, ATHENS, GA. SN
77-012,946. PUB. 4-17-2007, FILED 10-3-2006.

JOHNNIE'S DOG HOUSE

THE MARK CONSISTS OF STANDARD CHARACTERS WITHOUT CLAIM TO ANY PARTICULAR FONT, STYLE, SIZE, OR COLOR.

NO CLAIM IS MADE TO THE EXCLUSIVE RIGHT TO USE "DOG HOUSE", APART FROM THE MARK AS SHOWN.

FOR RESTAURANT SERVICES; AND CATERING SERVICES (U.S. CLS. 100 AND 101).

FIRST USE 3-1-2004; IN COMMERCE 4-25-2007.



NO CLAIM IS MADE TO THE EXCLUSIVE RIGHT TO USE "EUROPEAN EATERY", APART FROM THE MARK AS SHOWN.

THE COLOR(S) RED, YELLOW, AND WHITE IS/ARE CLAIMED AS A FEATURE OF THE MARK.

CLASS 43—(Continued).

THE MARK CONSISTS OF A DRAWING OF THE FACE OF A MAN, WHICH APPEARS IN RED, ABOVE THE WORDS "UNCLE OTTO'S", WHICH APPEAR IN YELLOW, ABOVE A RED OVAL CONTAINING THE WORDS "EUROPEAN EATERY", WHICH APPEAR IN WHITE.

FOR RESTAURANT SERVICES (U.S. CLS. 100 AND 101).

FIRST USE 10-4-2006; IN COMMERCE 10-4-2006.

CLASS 43—(Continued).

3,313,610. MARRIOTT INTERNATIONAL, INC., BETHESDA, MD. SN 78-593,086. PUB. 7-4-2006, FILED 3-23-2005.

3,313,324. WYNDHAM TM CORP., LAS VEGAS, NV. SN 77-039,197. PUB. 4-17-2007, FILED 11-8-2006.

BIN 1700**FIELDS & SUN**

THE MARK CONSISTS OF STANDARD CHARACTERS WITHOUT CLAIM TO ANY PARTICULAR FONT, STYLE, SIZE, OR COLOR.

FOR RESTAURANT SERVICES PROVIDED IN HOTELS AND MOTELS (U.S. CLS. 100 AND 101).

FIRST USE 10-0-2006; IN COMMERCE 10-0-2006.

THE MARK CONSISTS OF STANDARD CHARACTERS WITHOUT CLAIM TO ANY PARTICULAR FONT, STYLE, SIZE, OR COLOR.

FOR RESTAURANT, CATERING, BAR AND COCKTAIL LOUNGE SERVICES (U.S. CLS. 100 AND 101).

FIRST USE 6-1-2005; IN COMMERCE 6-1-2005.

3,313,498. THE DINEX GROUP, LLC, NEW YORK, NY. SN 78-486,885. PUB. 8-29-2006, FILED 9-21-2004.



**DANIEL
BOULUD**
BRASSERIE

OWNER OF U.S. REG. NO. 2,886,530.
NO CLAIM IS MADE TO THE EXCLUSIVE RIGHT TO USE "BRASSERIE", APART FROM THE MARK AS SHOWN.
THE NAME "DANIEL BOULUD" IDENTIFIES A LIVING INDIVIDUAL WHOSE CONSENT IS OF RECORD.

THE MARK CONSISTS OF OVERLAPPING SWIRLS IN OPPOSING DIRECTIONS WITH THE MARK DANIEL BOULUD BRASSERIE APPEARING BENEATH THE DESIGN.

FOR RESTAURANT, BAR AND CAFE SERVICES (U.S. CLS. 100 AND 101).

FIRST USE 4-8-2005; IN COMMERCE 4-8-2005.

3,313,624. DISNEY ENTERPRISES, INC., BURBANK, CA. SN 78-604,303. PUB. 8-8-2006, FILED 4-7-2005.



NO CLAIM IS MADE TO THE EXCLUSIVE RIGHT TO USE "SODA FOUNTAIN", APART FROM THE MARK AS SHOWN.

FOR RESTAURANT SERVICES (U.S. CLS. 100 AND 101).

FIRST USE 6-19-2005; IN COMMERCE 6-19-2005.

CLASS 43—(Continued).

3,313,655. TIJUANA TAXI EXPRESS, INC., DALLAS, TX. SN 78-616,484. PUB. 9-12-2006, FILED 4-25-2005.

Tijuana Bar & Grill

THE MARK CONSISTS OF STANDARD CHARACTERS WITHOUT CLAIM TO ANY PARTICULAR FONT, STYLE, SIZE, OR COLOR.

NO CLAIM IS MADE TO THE EXCLUSIVE RIGHT TO USE "BAR & GRILL", APART FROM THE MARK AS SHOWN.

FOR RESTAURANT SERVICES (U.S. CLS. 100 AND 101).

FIRST USE 6-15-2005; IN COMMERCE 6-15-2005.

CLASS 43—(Continued).

3,313,726. HOT STUFF FOODS, LLC, SIOUX FALLS, SD. SN 78-646,185. PUB. 4-25-2006, FILED 6-8-2005.



NO CLAIM IS MADE TO THE EXCLUSIVE RIGHT TO USE "GRILL", APART FROM THE MARK AS SHOWN.

FOR RESTAURANTS AND CAFES (U.S. CLS. 100 AND 101).

FIRST USE 3-20-2006; IN COMMERCE 3-20-2006.

3,313,682. DANNY & CLYDE'S FOOD STORE INC., GRETNA, LA. SN 78-625,066. PUB. 1-24-2006, FILED 5-6-2005.

DANNY & CLYDE'S PO-BOYS & MORE

THE MARK CONSISTS OF STANDARD CHARACTERS WITHOUT CLAIM TO ANY PARTICULAR FONT, STYLE, SIZE, OR COLOR.

OWNER OF U.S. REG. NOS. 2,968,806 AND 2,974,684.

NO CLAIM IS MADE TO THE EXCLUSIVE RIGHT TO USE "PO-BOYS", APART FROM THE MARK AS SHOWN.

FOR RESTAURANT AND DELICATESSEN SERVICES (U.S. CLS. 100 AND 101).

FIRST USE 11-1-2006; IN COMMERCE 11-1-2006.

3,313,727. 1610 RESTAURANT, LLC, ARLINGTON, VA. SN 78-646,570. PUB. 2-21-2006, FILED 6-8-2005.

BIG SKY

THE MARK CONSISTS OF STANDARD CHARACTERS WITHOUT CLAIM TO ANY PARTICULAR FONT, STYLE, SIZE, OR COLOR.

FOR RESTAURANT AND TAVERN SERVICES (U.S. CLS. 100 AND 101).

FIRST USE 4-0-2006; IN COMMERCE 4-0-2006.

3,313,711. ONIEAL, KATHERINE, MUNCIE, IN. SN 78-639,149. PUB. 7-18-2006, FILED 5-27-2005.

YOUR DOG'S FAVORITE HANGOUT

THE MARK CONSISTS OF STANDARD CHARACTERS WITHOUT CLAIM TO ANY PARTICULAR FONT, STYLE, SIZE, OR COLOR.

FOR BOARDING FOR ANIMALS AND PET DAY CARE SERVICES (U.S. CLS. 100 AND 101).

FIRST USE 8-31-2004; IN COMMERCE 8-31-2004.

3,313,753. JIMMY JOHN'S ENTERPRISES, LLC, CHAMPAIGN, IL. SN 78-655,990. PUB. 4-4-2006, FILED 6-22-2005.

FAST. FRESH. TASTY.

THE MARK CONSISTS OF STANDARD CHARACTERS WITHOUT CLAIM TO ANY PARTICULAR FONT, STYLE, SIZE, OR COLOR.

FOR RESTAURANT SERVICES (U.S. CLS. 100 AND 101).

FIRST USE 6-0-2005; IN COMMERCE 6-0-2005.

CLASS 43—(Continued).

3,313,854. MAPCO EXPRESS, INC., BRENTWOOD, TN. SN 78-702,660. PUB. 4-24-2007, FILED 8-29-2005.

GRILLE MARX

THE MARK CONSISTS OF STANDARD CHARACTERS WITHOUT CLAIM TO ANY PARTICULAR FONT, STYLE, SIZE, OR COLOR.

NO CLAIM IS MADE TO THE EXCLUSIVE RIGHT TO USE "GRILLE", APART FROM THE MARK AS SHOWN. FOR RESTAURANT SERVICES (U.S. CLS. 100 AND 101).

FIRST USE 12-21-2005; IN COMMERCE 12-21-2005.

3,313,875. CHAPMAN, JAMES A., HARTSELLE, AL. SN 78-710,199. PUB. 1-2-2007, FILED 9-9-2005.

Cabin Grill

THE MARK CONSISTS OF STANDARD CHARACTERS WITHOUT CLAIM TO ANY PARTICULAR FONT, STYLE, SIZE, OR COLOR.

NO CLAIM IS MADE TO THE EXCLUSIVE RIGHT TO USE "GRILL", APART FROM THE MARK AS SHOWN. FOR DINE-IN RESTAURANT SERVICES (U.S. CLS. 100 AND 101).

FIRST USE 3-1-2006; IN COMMERCE 3-1-2006.

3,313,885. HONEYCUTT, RHODNEY, HICKORY, NC. SN 78-714,152. PUB. 8-1-2006, FILED 9-15-2005.



NO CLAIM IS MADE TO THE EXCLUSIVE RIGHT TO USE "ICE CREAM" AND "AMERICA", APART FROM THE MARK AS SHOWN.

THE MARK CONSISTS OF A VESSEL FOR MAKING ICE CREAM, AND A BOWL OF ICE CREAM.

FOR CAFE-RESTAURANTS; CARRY-OUT RESTAURANTS; RESTAURANT SERVICES; RESTAURANTS (U.S. CLS. 100 AND 101).

FIRST USE 9-16-2005; IN COMMERCE 9-16-2005.

CLASS 43—(Continued).

3,313,928. BAM VENTURES, LLC, ST. AUGUSTINE, FL. SN 78-733,713. PUB. 8-1-2006, FILED 10-14-2005.



NO CLAIM IS MADE TO THE EXCLUSIVE RIGHT TO USE "ITALIAN STEAK HOUSE", APART FROM THE MARK AS SHOWN.

THE COLOR(S) RED AND GREEN IS/ARE CLAIMED AS A FEATURE OF THE MARK.

THE MARK CONSISTS OF THE COLOR RED APPEARS IN THE WORD AUGUSTINOS AND THE COLOR GREEN APPEARS IN THE WORDS ITALIAN STEAKHOUSE.

FOR RESTAURANT, BAR AND RESTAURANT CARRY-OUT SERVICES (U.S. CLS. 100 AND 101).

FIRST USE 11-10-2005; IN COMMERCE 11-10-2005.

3,313,942. KEFALONIA, LLC, MURRAY, UT. SN 78-739,884. PUB. 9-26-2006, FILED 10-25-2005.

Z BEST GREEK

THE MARK CONSISTS OF STANDARD CHARACTERS WITHOUT CLAIM TO ANY PARTICULAR FONT, STYLE, SIZE, OR COLOR.

NO CLAIM IS MADE TO THE EXCLUSIVE RIGHT TO USE "BEST GREEK", APART FROM THE MARK AS SHOWN.

FOR RESTAURANT SERVICES (U.S. CLS. 100 AND 101).

FIRST USE 2-0-2007; IN COMMERCE 2-0-2007.

CLASS 43—(Continued).

3,313,965. CORNER CAPITAL, L.L.C., DBA STICKLERS, PHOENIX, AZ. SN 78-746,211. PUB. 9-12-2006, FILED 11-3-2005.



THE COLOR(S) YELLOW, RED AND BLACK IS/ARE CLAIMED AS A FEATURE OF THE MARK.

THE MARK CONSISTS OF THE COLOR YELLOW FOR THE LETTER S IN THE CIRCLE AND FOR THE WORD STICKLERS. THE COLOR RED APPEARS AS THE OUTER EDGE OF THE CIRCLE DESIGN AND THE COLOR BLACK APPEARS IN THE CENTER OF THE CIRCLE DESIGN.

FOR CAFE-RESTAURANTS; CAFES; CAFETERIAS; CARRY-OUT RESTAURANTS; CATERING; COFFEE SHOPS; COFFEE-HOUSE AND SNACK-BAR SERVICES; DELICATESSENS; FAST-FOOD RESTAURANTS AND SNACKBARS; FOOD PREPARATION; PREPARATION OF FOOD AND BEVERAGES; RESTAURANT SERVICES; RESTAURANTS; SALAD BARS; SELF-SERVICE RESTAURANTS; SNACK BARS; TAKE-OUT RESTAURANT SERVICES (U.S. CLS. 100 AND 101).

FIRST USE 2-28-2004; IN COMMERCE 1-31-2006.

3,313,977. GRIZZA, LLC, PRINCETON, NJ. SN 78-749,058. PUB. 7-25-2006, FILED 11-8-2005.

MAGMA

THE MARK CONSISTS OF STANDARD CHARACTERS WITHOUT CLAIM TO ANY PARTICULAR FONT, STYLE, SIZE, OR COLOR.

FOR RESTAURANT SERVICES (U.S. CLS. 100 AND 101).

FIRST USE 6-19-2006; IN COMMERCE 6-19-2006.

CLASS 43—(Continued).

3,314,146. TRAN, TUONG VI, SAN JOSE, CA. SN 78-776,672. PUB. 10-31-2006, FILED 12-19-2005.

PHO VIET TRAN HUNG DAO

THE MARK CONSISTS OF STANDARD CHARACTERS WITHOUT CLAIM TO ANY PARTICULAR FONT, STYLE, SIZE, OR COLOR.

NO CLAIM IS MADE TO THE EXCLUSIVE RIGHT TO USE "PHO", APART FROM THE MARK AS SHOWN.

THE ENGLISH TRANSLATION OF "PHO VIET TRAN HUNG DAO" IS "VIETNAM GENERAL'S NOODLE." FOR RESTAURANT SERVICES (U.S. CLS. 100 AND 101).

FIRST USE 3-15-2006; IN COMMERCE 3-15-2006.

3,314,160. CAFFE PAZZESCO, LLC, SPOKANE, WA. SN 78-777,880. PUB. 4-3-2007, FILED 12-21-2005.

CAFFE PAZZESCO - THE COFFEE SHOP AT WORK

THE MARK CONSISTS OF STANDARD CHARACTERS WITHOUT CLAIM TO ANY PARTICULAR FONT, STYLE, SIZE, OR COLOR.

NO CLAIM IS MADE TO THE EXCLUSIVE RIGHT TO USE "CAFFE", APART FROM THE MARK AS SHOWN.

THE ENGLISH TRANSLATION OF THE WORDS "CAFFE PAZZESCO" IN THE MARK ARE "COFFEE CRAZY" FOR BEVERAGE SUPPLY SERVICES FOR OFFICES (U.S. CLS. 100 AND 101).

FIRST USE 1-2-2006; IN COMMERCE 1-2-2006.

3,314,163. TWIN CITIES PASTA CO., LLC, MINNEAPOLIS, MN. SN 78-778,688. PUB. 8-29-2006, FILED 12-21-2005.



NO CLAIM IS MADE TO THE EXCLUSIVE RIGHT TO USE "ITALIAN KITCHEN", APART FROM THE MARK AS SHOWN.

THE ENGLISH TRANSLATION OF THE WORD CABINA IN THE MARK IS "CABIN".

FOR RESTAURANT SERVICES (U.S. CLS. 100 AND 101).

FIRST USE 10-31-2005; IN COMMERCE 10-31-2005.

CLASS 43—(Continued).

3,314,192. POLSGROVE, JEFFREY, MANCHESTER, MO. SN 78-784,858. PUB. 8-29-2006, FILED 1-4-2006.

CLASS 43—(Continued).

3,314,349. VINNY'S, LLC, UNIONTOWN, PA. SN 78-814,315. PUB. 10-3-2006, FILED 2-14-2006.

PIG CITY

THE MARK CONSISTS OF STANDARD CHARACTERS WITHOUT CLAIM TO ANY PARTICULAR FONT, STYLE, SIZE, OR COLOR.
FOR RESTAURANT, CATERING AND BAR SERVICES (U.S. CLS. 100 AND 101).
FIRST USE 9-1-2006; IN COMMERCE 9-1-2006.

3,314,252. KAHNUNA ENTERTAINMENT, LLC, BROOMFIELD, CO. SN 78-794,689. PUB. 9-19-2006, FILED 1-19-2006.

THE EXCHANGE TAVERN

THE MARK CONSISTS OF STANDARD CHARACTERS WITHOUT CLAIM TO ANY PARTICULAR FONT, STYLE, SIZE, OR COLOR.
NO CLAIM IS MADE TO THE EXCLUSIVE RIGHT TO USE "TAVERN", APART FROM THE MARK AS SHOWN.
FOR RESTAURANT AND BAR SERVICES (U.S. CLS. 100 AND 101).
FIRST USE 11-1-2005; IN COMMERCE 11-1-2005.

3,314,304. THE DORADO BEACH COMPANY, LLC, SAN JUAN, PUERTO RICO. SN 78-805,561. PUB. 9-12-2006, FILED 2-2-2006.

ZAFRA

THE MARK CONSISTS OF STANDARD CHARACTERS WITHOUT CLAIM TO ANY PARTICULAR FONT, STYLE, SIZE, OR COLOR.
THE FOREIGN WORDING IN THE MARK TRANSLATES INTO ENGLISH AS SUGAR CANE HARVEST TIME.
FOR RESTAURANT AND BAR SERVICES (U.S. CLS. 100 AND 101).
FIRST USE 7-1-2006; IN COMMERCE 7-1-2006.

Vinny's International

THE MARK CONSISTS OF STANDARD CHARACTERS WITHOUT CLAIM TO ANY PARTICULAR FONT, STYLE, SIZE, OR COLOR.
NO CLAIM IS MADE TO THE EXCLUSIVE RIGHT TO USE "INTERNATIONAL", APART FROM THE MARK AS SHOWN.
THE NAME "VINNY" DOES NOT IDENTIFY A LIVING INDIVIDUAL.
FOR CARRY-OUT RESTAURANTS; FAST FOOD AND NON-STOP RESTAURANT SERVICES; FAST-FOOD RESTAURANTS; FAST-FOOD RESTAURANTS AND SNACKBARS; RESTAURANT SERVICES; RESTAURANTS; RESTAURANTS FEATURING HOME DELIVERY; TAKE-OUT RESTAURANT SERVICES (U.S. CLS. 100 AND 101).
FIRST USE 6-1-2006; IN COMMERCE 6-1-2006.

CLASS 43—(Continued).

3,314,353. VINNY'S, LLC, UNIONTOWN, PA. SN 78-814,610.
PUB. 10-10-2006, FILED 2-14-2006.



NO CLAIM IS MADE TO THE EXCLUSIVE RIGHT TO USE "INTERNATIONAL", APART FROM THE MARK AS SHOWN.

THE NAME "VINNY" DOES NOT IDENTIFY A LIVING INDIVIDUAL.

THE COLOR(S) RED, GREEN, BLACK AND WHITE ARE CLAIMED AS A FEATURE OF THE MARK.

THE MARK CONSISTS OF A LARGE STYLIZED GREEN CAPITAL "V"; THE STYLIZED TITLE-CASE WORD "VINNY'S" IN RED PLACED ACROSS THE UPPER-CENTER OF THE "V" WITH THE "Y" OF "VINNY'S" EXTENDING BENEATH THE ENTIRE WORD; A "SMILEY FACE" INSIDE OF THE DOT OF THE "I" IN "VINNY'S"; A DRAWING OF A PEPPERONI PIZZA SLICE, OUTLINED IN RED WITH FOUR RED PEPPERONI PIECES, ATTACHED AT AN ANGLE TO AND FLUSH WITH THE CENTER RIGHT-SIDE OF THE "V"; THE WORD "INTERNATIONAL" PLACED BELOW THE PIZZA SLICE IN RED AND IN ALL CAPS; THE "V" AND "VINNY'S" OUTLINED IN BLACK AND PORTIONS OF "VINNY'S" ALSO OUTLINED IN WHITE TO SHOW CONTRAST.

FOR CARRY-OUT RESTAURANTS; FAST FOOD AND NON-STOP RESTAURANT SERVICES; FAST-FOOD RESTAURANTS; FAST-FOOD RESTAURANTS AND SNACKBARS; RESTAURANT SERVICES; RESTAURANTS; RESTAURANTS FEATURING HOME DELIVERY; TAKE-OUT RESTAURANT SERVICES (U.S. CLS. 100 AND 101).

FIRST USE 6-1-2006; IN COMMERCE 6-1-2006.

3,314,440. DIXIE RESTAURANTS, INC., LITTLE ROCK, AR.
SN 78-831,889. PUB. 10-17-2006, FILED 3-8-2006.



THE COLOR(S) BLACK, RED AND BLUE IS/ARE CLAIMED AS A FEATURE OF THE MARK.

CLASS 43—(Continued).

THE MARK CONSISTS OF THE RED LETTER "F" AND THE BLUE LETTER "F" FACING EACH OTHER IN A BLACK EIGHT POINTED STAR.

FOR RESTAURANT, BAR AND CATERING SERVICES, PROVIDING OF FOOD AND DRINK (U.S. CLS. 100 AND 101).

FIRST USE 11-1-2005; IN COMMERCE 11-1-2005.

3,314,476. CROWN TRAVEL SERVICE, INC., BLOOMFIELD, NJ. SN 78-843,019. PUB. 10-24-2006, FILED 3-22-2006.

ABC DESTINATIONS

THE MARK CONSISTS OF STANDARD CHARACTERS WITHOUT CLAIM TO ANY PARTICULAR FONT, STYLE, SIZE, OR COLOR.

OWNER OF U.S. REG. NOS. 2,446,165, 3,086,611, AND OTHERS.

NO CLAIM IS MADE TO THE EXCLUSIVE RIGHT TO USE "DESTINATIONS", APART FROM THE MARK AS SHOWN.

FOR MAKING RESERVATIONS AND BOOKINGS FOR TEMPORARY LODGING (U.S. CLS. 100 AND 101).

FIRST USE 7-0-2006; IN COMMERCE 7-0-2006.

3,314,669. LANGOLF, AARON D, SAN DIEGO, CA. SN 78-902,770. PUB. 2-6-2007, FILED 6-7-2006.



NO CLAIM IS MADE TO THE EXCLUSIVE RIGHT TO USE "THE KEBAB SHOP", "THE ORIGINAL DÖNER KEBAB", APART FROM THE MARK AS SHOWN.

THE LIKENESS (OR, "PORTRAIT") IN THE MARK IDENTIFIES A LIVING INDIVIDUAL WHOSE CONSENT IS OF RECORD.

THE COLOR(S) ORANGE AND BLACK IS/ARE CLAIMED AS A FEATURE OF THE MARK.

THE MARK CONSISTS OF THE COLOR ORANGE AS IT APPEARS IN THE DESIGN OF THE MEAT, THE KNIFE AND THE MALE CUTTING THE MEAT AND THE WORDS "THE KEBAB SHOP". THE COLOR BLACK APPEARS IN THE TOOL ON WHICH THE MEAT IS TURNING AND IN THE WORDING "THE ORIGINAL DÖNER KEBAB".

THE FOREIGN WORDING IN THE MARK TRANSLATES INTO ENGLISH AS ROTATING MEAT.

FOR CAFE-RESTAURANTS; CARRY-OUT RESTAURANTS; FAST FOOD AND NON-STOP RESTAURANT SERVICES; FAST-FOOD RESTAURANTS; RESTAURANTS (U.S. CLS. 100 AND 101).

FIRST USE 1-1-2007; IN COMMERCE 6-2-2007.

CLASS 43—(Continued).

3,314,709. HOLIDAY HAM & TURKEY, INC., MEMPHIS, TN. SN 78-912,951. PUB. 2-13-2007, FILED 6-21-2006.

PIMENTO'S CAFÉ & MARKET

THE MARK CONSISTS OF STANDARD CHARACTERS WITHOUT CLAIM TO ANY PARTICULAR FONT, STYLE, SIZE, OR COLOR.

NO CLAIM IS MADE TO THE EXCLUSIVE RIGHT TO USE "CAFE & MARKET", APART FROM THE MARK AS SHOWN.

FOR RESTAURANT, DELICATESSEN, CATERING AND CARRY-OUT RESTAURANT SERVICES (U.S. CLS. 100 AND 101).

FIRST USE 12-15-2006; IN COMMERCE 12-15-2006.

3,314,734. DEMAR, MATT, AMITYVILLE, NY. SN 78-922,679. PUB. 2-13-2007, FILED 7-5-2006.

HOLLYROCK

THE MARK CONSISTS OF STANDARD CHARACTERS WITHOUT CLAIM TO ANY PARTICULAR FONT, STYLE, SIZE, OR COLOR.

FOR RESTAURANT SERVICES (U.S. CLS. 100 AND 101).

FIRST USE 4-24-2007; IN COMMERCE 4-24-2007.

3,314,738. GREENWICH VILLAGE ENTERTAINMENT GROUP LLC, NEW YORK, NY. SN 78-924,409. PUB. 5-1-2007, FILED 7-7-2006.

HIGHLINE

THE MARK CONSISTS OF STANDARD CHARACTERS WITHOUT CLAIM TO ANY PARTICULAR FONT, STYLE, SIZE, OR COLOR.

FOR RESTAURANT AND BAR SERVICES, NAMELY, PREPARATION AND SERVICE OF FOOD AND BEVERAGES FOR CONSUMPTION (U.S. CLS. 100 AND 101).

FIRST USE 3-28-2007; IN COMMERCE 3-28-2007.

CLASS 44—MEDICAL, BEAUTY AND AGRICULTURAL SERVICES

CLASS 44—(Continued).

3,313,003. ST. MARY'S HEALTH CARE SYSTEM, INC., ATHENS, GA. SN 76-410,854. PUB. 12-30-2003, FILED 5-15-2002.

ST. MARY'S
HEALTH CARE SYSTEM

OWNER OF U.S. REG. NOS. 1,880,182, 2,485,445, AND OTHERS.

NO CLAIM IS MADE TO THE EXCLUSIVE RIGHT TO USE "HEALTH CARE SYSTEM", APART FROM THE MARK AS SHOWN.

FOR HEALTH CARE SERVICES, INCLUDING HOSPITAL SERVICES, LONG-TERM CARE FACILITY SERVICES, HOSPICE SERVICES, HOME HEALTH CARE SERVICES, PERSONAL CARE HOMES, AND URGENT CARE CENTERS (U.S. CLS. 100 AND 101).

FIRST USE 0-0-1993; IN COMMERCE 0-0-1993.

3,313,041. NINE STONES, LLC, PORTLAND, ME. SN 76-558,660. PUB. 4-11-2006, FILED 11-10-2003.

**nine
stones**
face • body • spa

NO CLAIM IS MADE TO THE EXCLUSIVE RIGHT TO USE "FACE BODY SPA", APART FROM THE MARK AS SHOWN.

FOR DAY SPA SERVICES, NAMELY, MASSAGE, BODY TREATMENTS, FACIAL TREATMENTS AND MANICURE/ PEDICURES (U.S. CLS. 100 AND 101).

FIRST USE 7-5-2006; IN COMMERCE 7-5-2006.

3,313,081. THE AMBAGE, LLC, GILBERT, AZ. SN 76-616,586. PUB. 10-11-2005, FILED 10-18-2004.

THE AMBAGE

THE MARK CONSISTS OF STANDARD CHARACTERS WITHOUT CLAIM TO ANY PARTICULAR FONT, STYLE, SIZE, OR COLOR.

NO CLAIM IS MADE TO THE EXCLUSIVE RIGHT TO USE "THE", APART FROM THE MARK AS SHOWN.

FOR HEALTH SPA-SERVICES, NAMELY, COSMETIC AND BEAUTY CARE SERVICES; HEALTH SPA SERVICES FOR HEALTH AND WELLNESS OF THE BODY, MIND AND SPIRIT OFFERED AT A HEALTH RESORT (U.S. CLS. 100 AND 101).

FIRST USE 11-3-2006; IN COMMERCE 11-3-2006.

CLASS 44—(Continued).

3,313,090. ORANBURG, PHILIP R., BOCA RATON, FL. SN 76-623,269. PUB. 11-21-2006, FILED 12-6-2004.



NO CLAIM IS MADE TO THE EXCLUSIVE RIGHT TO USE "PROACTIVE HEART HEALTH", APART FROM THE MARK AS SHOWN.

THE COLOR(S) BLUE AND YELLOW IS/ARE CLAIMED AS A FEATURE OF THE MARK.

THE MARK CONSISTS OF THE COLOR YELLOW WHICH APPEARS IN THE LETTER "I" IN "PROACTIVE" AND CONTINUES TO FORM HALF OF A HEART CRADLING THE REMAINING LETTERS. THE COLOR BLUE APPEARS IN THE WORDING.

FOR MEDICAL EVALUATION SERVICES, NAMELY, RISK ASSESSMENT PROGRAM FOR PATIENTS, FOR PURPOSES OF GUIDING TREATMENT AND ASSESSING DIETARY, LIFESTYLE AND MEDICATION MODIFICATIONS (U.S. CLS. 100 AND 101).

FIRST USE 11-1-2004; IN COMMERCE 11-1-2004.

3,313,186. HOLLAND HOME, GRAND RAPIDS, MI. SN 76-652,874. PUB. 9-12-2006, FILED 1-4-2006.

FAITH HOSPICE

THE MARK CONSISTS OF STANDARD CHARACTERS WITHOUT CLAIM TO ANY PARTICULAR FONT, STYLE, SIZE, OR COLOR.

NO CLAIM IS MADE TO THE EXCLUSIVE RIGHT TO USE "HOSPICE", APART FROM THE MARK AS SHOWN.

FOR PROVIDING HOSPICE SERVICES AND FACILITIES (U.S. CLS. 100 AND 101).

FIRST USE 12-0-2006; IN COMMERCE 3-0-2007.

CLASS 44—(Continued).

3,313,210. PROFESSIONAL CLINICAL LABRATORY, INC., FORT WORTH, TX. SN 76-661,240. PUB. 1-16-2007, FILED 6-8-2006.

PROLAB

THE MARK CONSISTS OF STANDARD CHARACTERS WITHOUT CLAIM TO ANY PARTICULAR FONT, STYLE, SIZE, OR COLOR.

FOR MEDICAL SERVICES (U.S. CLS. 100 AND 101). FIRST USE 2-19-1999; IN COMMERCE 2-19-1999.

3,313,269. NOURISHE, L.L.C., JUPITER, FL. SN 77-010,990. PUB. 4-17-2007, FILED 9-29-2006.

Kinetic

THE MARK CONSISTS OF STANDARD CHARACTERS WITHOUT CLAIM TO ANY PARTICULAR FONT, STYLE, SIZE, OR COLOR.

FOR SKIN CARE SERVICES, NAMELY SKIN TREATMENTS AND SKIN HEALTH RESTORATION, INCLUDING PROCEDURES FOR EXFOLIATION AND REJUVENATION OF THE SKIN, ADMINISTERED BY PHYSICIANS OR LICENSED PROFESSIONALS; BEAUTY SERVICES FOR SKIN, NAMELY NON-SURGICAL FACIAL REJUVENATION (U.S. CLS. 100 AND 101). FIRST USE 2-15-2007; IN COMMERCE 2-15-2007.

3,313,352. HETZEL, DAVID JOHN, ASHEVILLE, NC. SN 78-090,498. PUB. 12-17-2002, FILED 10-27-2001.

MEDWATCH SYSTEM

NO CLAIM IS MADE TO THE EXCLUSIVE RIGHT TO USE "SYSTEM", APART FROM THE MARK AS SHOWN.

FOR COMPILING AND MAINTAINING A COMPUTER DATABASE OF MEDICATION DATA AND PERSONAL MEDICAL HISTORY INFORMATION, FOR OTHERS (U.S. CLS. 100 AND 101).

FIRST USE 10-1-2006; IN COMMERCE 10-1-2006.

3,313,385. FONAR CORPORATION, MELVILLE, NY. SN 78-262,128. PUB. 2-10-2004, FILED 6-13-2003.

POSITION

FOR RADIOLOGY SERVICES (U.S. CLS. 100 AND 101). FIRST USE 5-17-2006; IN COMMERCE 5-17-2006.

CLASS 44—(Continued).

3,313,587. CAMPBELL, ROBERT B., FOLSOM, CA. SN 78-581,767. PUB. 11-29-2005, FILED 3-7-2005.

Sbarkles

THE MARK CONSISTS OF STANDARD CHARACTERS WITHOUT CLAIM TO ANY PARTICULAR FONT, STYLE, SIZE, OR COLOR.

FOR BEAUTY CARE FOR ANIMALS, NAMELY PROVIDING ANIMAL GROOMING FACILITIES (U.S. CLS. 100 AND 101).

FIRST USE 4-10-2007; IN COMMERCE 4-10-2007.

3,313,673. HAZELDEN FOUNDATION, CENTER CITY, MN. SN 78-622,373. PUB. 1-24-2006, FILED 5-4-2005.

MORE MY ONGOING RECOVERY
EXPERIENCE

THE MARK CONSISTS OF STANDARD CHARACTERS WITHOUT CLAIM TO ANY PARTICULAR FONT, STYLE, SIZE, OR COLOR.

FOR CONTINUING ADDICTION TREATMENT CARE AFTER DISCHARGE FROM TREATMENT FOR ALCOHOLISM AND OTHER DRUG ADDICTIONS (U.S. CLS. 100 AND 101).

FIRST USE 7-12-2006; IN COMMERCE 7-12-2006.

3,313,735. CATHOLIC HEALTHCARE WEST, SAN FRANCISCO, CA. SN 78-650,769. PUB. 3-28-2006, FILED 6-14-2005.

COMMITTED TO CARE,
ADVOCATING FOR CHANGE

THE MARK CONSISTS OF STANDARD CHARACTERS WITHOUT CLAIM TO ANY PARTICULAR FONT, STYLE, SIZE, OR COLOR.

FOR HEALTHCARE (U.S. CLS. 100 AND 101).
FIRST USE 11-1-2005; IN COMMERCE 11-1-2005.

CLASS 44—(Continued).

3,313,922. SAMY MARK, INC., MIAMI, FL. SN 78-731,307. PUB. 1-2-2007, FILED 10-12-2005.

OWNER OF U.S. REG. NOS. 2,746,851, 2,835,229, AND OTHERS.

NO CLAIM IS MADE TO THE EXCLUSIVE RIGHT TO USE "BEAUTY LOUNGE", APART FROM THE MARK AS SHOWN.

THE NAME SAMUEL SUAREZ IDENTIFIES A LIVING INDIVIDUAL WHOSE CONSENT IS OF RECORD.

FOR HAIR SALONS AND BEAUTY SALONS (U.S. CLS. 100 AND 101).

FIRST USE 2-6-2007; IN COMMERCE 2-6-2007.

3,313,933. ON SITE DERMATOLOGY, LLC, BOCA RATON, FL. SN 78-737,296. PUB. 8-1-2006, FILED 10-20-2005.

NO CLAIM IS MADE TO THE EXCLUSIVE RIGHT TO USE "ONSITE DERMATOLOGY", APART FROM THE MARK AS SHOWN.

THE GRAY SHADING IN THE MARK IS NOT CLAIMED AS A FEATURE OF THE MARK.

FOR DERMATOLOGY SERVICES (U.S. CLS. 100 AND 101).

FIRST USE 9-1-2005; IN COMMERCE 10-1-2005.

CLASS 44—(Continued).

3,314,114. ALTICOR INC., ADA, MI. SN 78-771,403. PUB. 3-20-2007, FILED 12-12-2005.

NUTRILITE

THE MARK CONSISTS OF STANDARD CHARACTERS WITHOUT CLAIM TO ANY PARTICULAR FONT, STYLE, SIZE, OR COLOR.

OWNER OF U.S. REG. NOS. 402,891, 2,145,912, AND OTHERS.

FOR HEALTH CARE TESTING, NAMELY, GENETIC TESTING, BIOMARKER TESTING AND LIFESTYLE ASSESSMENTS FOR HEALTH PURPOSES; CONSULTING SERVICES IN THE FIELD OF NUTRITION, DIET AND LIFESTYLE PRACTICES TO ENHANCE HEALTH; PROVIDING INFORMATION IN THE FIELD OF HEALTH AND NUTRITION BY MEANS OF THE INTERNET (U.S. CLS. 100 AND 101).

FIRST USE 2-1-2006; IN COMMERCE 2-1-2006.

3,314,124. VISION SERVICE PLAN, RANCHO CORDOVA, CA. SN 78-773,929. PUB. 8-22-2006, FILED 12-15-2005.



OWNER OF U.S. REG. NOS. 1,039,379, 2,370,513, AND OTHERS.

NO CLAIM IS MADE TO THE EXCLUSIVE RIGHT TO USE "STUDENTS" OR "PROGRAM", APART FROM THE MARK AS SHOWN.

THE COLORS BLUE AND GREEN ARE CLAIMED AS A FEATURE OF THE MARK.

THE EYE DESIGN AND THE WORDING "FOR" AND "A VSP PROGRAM" ARE BLUE. "SIGHT" AND "STUDENTS" ARE GREEN.

THE MARK CONSISTS IN PART OF A STYLIZED REPRESENTATION OF AN EYE WITH EYELASHES.

SEC. 2(F) AS TO "SIGHT FOR STUDENTS".

FOR CHARITABLE SERVICES, NAMELY, PROVIDING OPTOMETRY FOR NEEDY STUDENTS IN THE NATURE OF VISION TESTING AND EYEGLASS FITTING (U.S. CLS. 100 AND 101).

FIRST USE 7-0-2005. THE MARK WAS FIRST USED ANYWHERE IN A DIFFERENT FORM OTHER THAN THAT SOUGHT TO BE REGISTERED ON 05/00/1994.; IN COMMERCE 2-0-2006, THE MARK WAS FIRST USED IN COMMERCE IN A DIFFERENT FORM OTHER THAN THAT SOUGHT TO BE REGISTERED ON 07/00/1997..

CLASS 44—(Continued).

3,314,174. 10MINMANICURE LLC, MIAMI, FL. SN 78-781,784. PUB. 10-10-2006, FILED 12-28-2005.

NO CLAIM IS MADE TO THE EXCLUSIVE RIGHT TO USE "10 MINUTE MANICURE", APART FROM THE MARK AS SHOWN.

THE COLOR(S) GRAY, RED, BLACK AND WHITE IS/ARE CLAIMED AS A FEATURE OF THE MARK.

THE MARK CONSISTS OF A GRAY COLON SYMBOL FOLLOWED BY THE NUMBER 10, WITH A RED FORWARD SLASH FOLLOWED BY THE WORDS MINUTE MANICURE IN LOWER CASE LETTERS IN BLACK ON A WHITE BACKGROUND.

FOR MANICURING (U.S. CLS. 100 AND 101).

FIRST USE 1-6-2006; IN COMMERCE 1-6-2006.

3,314,178. INSIGHT IMAGING, INC., HUNTSVILLE, AL. SN 78-782,120. PUB. 9-12-2006, FILED 12-29-2005.

THE CENTER OF IMAGING EXCELLENCE

THE MARK CONSISTS OF STANDARD CHARACTERS WITHOUT CLAIM TO ANY PARTICULAR FONT, STYLE, SIZE, OR COLOR.

NO CLAIM IS MADE TO THE EXCLUSIVE RIGHT TO USE "IMAGING EXCELLENCE", APART FROM THE MARK AS SHOWN.

FOR MEDICAL IMAGING SERVICES (U.S. CLS. 100 AND 101).

FIRST USE 5-0-2006; IN COMMERCE 5-0-2006.

CLASS 44—(Continued).

3,314,281. PFIZER INC., NEW YORK, NY. SN 78-800,923.
PUB. 8-22-2006, FILED 1-27-2006.

**WORKING FOR A HEALTHIER
WORLD**

THE MARK CONSISTS OF STANDARD CHARACTERS WITHOUT CLAIM TO ANY PARTICULAR FONT, STYLE, SIZE, OR COLOR.

FOR MEDICAL INFORMATION SERVICES, NAMELY, PROVIDING INFORMATION TO PHYSICIANS, HEALTHCARE PROFESSIONALS AND PATIENTS ON THE TOPICS OF HEALTH ISSUES, PHARMACEUTICAL PRODUCTS AND HEALTH AWARENESS; ON-LINE INFORMATION SERVICES, NAMELY, PROVIDING INFORMATION TO PHYSICIANS, HEALTHCARE PROFESSIONALS AND PATIENTS ON THE TOPICS OF HEALTH ISSUES, PHARMACEUTICAL PRODUCTS AND HEALTH AWARENESS (U.S. CLS. 100 AND 101).

FIRST USE 7-20-2006; IN COMMERCE 7-20-2006.

3,314,351. UNIVERSITY OF SOUTH FLORIDA, TAMPA, FL.
SN 78-814,538. PUB. 3-20-2007, FILED 2-14-2006.

**USF HEALTH MAKING LIFE
BETTER**

THE MARK CONSISTS OF STANDARD CHARACTERS WITHOUT CLAIM TO ANY PARTICULAR FONT, STYLE, SIZE, OR COLOR.

OWNER OF U.S. REG. NOS. 2,829,973, 2,995,827, AND 3,002,650.

NO CLAIM IS MADE TO THE EXCLUSIVE RIGHT TO USE "HEALTH", APART FROM THE MARK AS SHOWN.

FOR HOSPITAL AND HEALTHCARE SERVICES (U.S. CLS. 100 AND 101).

FIRST USE 8-0-2006; IN COMMERCE 8-0-2006.

3,314,461. MEDICAL SCIENTIFIC RESOURCES OF NEVADA, INC., LAS VEGAS, NV. SN 78-836,209. PUB. 10-17-2006, FILED 3-13-2006.



NO CLAIM IS MADE TO THE EXCLUSIVE RIGHT TO USE "MEDICAL SCIENTIFIC RESOURCES", APART FROM THE MARK AS SHOWN.

CLASS 44—(Continued).

THE COLOR(S) GREEN AND PURPLE IS/ARE CLAIMED AS A FEATURE OF THE MARK.

THE COLOR GREEN APPEARS IN THE DESIGN OF THE LETTER S AND THE COLOR PURPLE APPEARS AS THE SHADING FOR THE LETTER S AS WELL AS IN THE LETTERS M AND R AND IN THE WORDING MEDICAL SCIENTIFIC RESOURCES.

FOR HEALTH CARE; MENTAL HEALTH COUNSELING AND PSYCHOTHERAPY AS IT RELATES TO RELATIONSHIPS; MENTAL HEALTH SERVICES; PHYSICIAN SERVICES; PROVIDING HEALTH CARE INFORMATION BY TELEPHONE AND THE INTERNET; PROVIDING HEALTH INFORMATION (U.S. CLS. 100 AND 101).

FIRST USE 5-8-2006; IN COMMERCE 5-8-2006.

3,314,490. KINPEL MEDICAL, PC, ACCOKEEK, MD. SN 78-849,555. PUB. 12-12-2006, FILED 3-29-2006.



NO CLAIM IS MADE TO THE EXCLUSIVE RIGHT TO USE "SPINA THERAPEUTICS", APART FROM THE MARK AS SHOWN.

FOR HEALTH CARE SERVICES (U.S. CLS. 100 AND 101).

FIRST USE 1-1-2006; IN COMMERCE 5-1-2006.

3,314,570. PFIZER INC, NEW YORK, NY. SN 78-879,326. PUB. 10-17-2006, FILED 5-9-2006.

ANIMATE

THE MARK CONSISTS OF STANDARD CHARACTERS WITHOUT CLAIM TO ANY PARTICULAR FONT, STYLE, SIZE, OR COLOR.

THE ENGLISH TRANSLATION OF ANIMATE IS GO FOR IT.

FOR MEDICAL INFORMATION SERVICES, NAMELY, PROVIDING INFORMATION RELATING TO SEXUAL DYSFUNCTION AND THE DIAGNOSIS AND TREATMENT OF SEXUAL DYSFUNCTION; ON-LINE INFORMATION SERVICES, NAMELY, PROVIDING INFORMATION RELATING TO SEXUAL DYSFUNCTION VIA A GLOBAL COMPUTER NETWORK (U.S. CLS. 100 AND 101).

FIRST USE 5-16-2006; IN COMMERCE 5-16-2006.

CLASS 44—(Continued).

3,314,615. STEEL-GROOMING FOR MEN, INC., NAPLES, FL. SN 78-890,018. PUB. 3-6-2007, FILED 5-23-2006.

STEEL-GROOMING FOR MEN

THE MARK CONSISTS OF STANDARD CHARACTERS WITHOUT CLAIM TO ANY PARTICULAR FONT, STYLE, SIZE, OR COLOR.

FOR BARBERSHOPS; COSMETOLOGY SERVICES (U.S. CLS. 100 AND 101).

FIRST USE 3-2-2007; IN COMMERCE 4-2-2007.

3,314,644. GRAHAM, STEPHEN J., LEMONT, IL. SN 78-897,774. PUB. 4-17-2007, FILED 6-1-2006.

envy medspa

THE MARK CONSISTS OF STANDARD CHARACTERS WITHOUT CLAIM TO ANY PARTICULAR FONT, STYLE, SIZE, OR COLOR.

NO CLAIM IS MADE TO THE EXCLUSIVE RIGHT TO USE "MEDSPA", APART FROM THE MARK AS SHOWN.

FOR HEALTH SPA SERVICES, NAMELY, COSMETIC BODY CARE SERVICES (U.S. CLS. 100 AND 101).

FIRST USE 8-1-2006; IN COMMERCE 8-1-2006.

3,314,654. BERKEY, STEVEN, PLANO, TX. AND BERKEY, JULIE, PLANO, TX. SN 78-900,917. PUB. 1-2-2007, FILED 6-6-2006.

Dr. Spa

THE MARK CONSISTS OF STANDARD CHARACTERS WITHOUT CLAIM TO ANY PARTICULAR FONT, STYLE, SIZE, OR COLOR.

FOR HEALTH SPA SERVICES, NAMELY, COSMETIC CARE SERVICES FEATURING MANICURES AND PEDICURES (U.S. CLS. 100 AND 101).

FIRST USE 8-10-2006; IN COMMERCE 8-10-2006.

CLASS 44—(Continued).

3,314,698. MEDCO HEALTH SOLUTIONS, INC., FRANKLIN LAKES, NJ. SN 78-909,955. PUB. 2-13-2007, FILED 6-16-2006.



OWNER OF U.S. REG. NOS. 2,327,098 AND 2,449,414. NO CLAIM IS MADE TO THE EXCLUSIVE RIGHT TO USE "HEALTH", APART FROM THE MARK AS SHOWN.

FOR HEALTH CARE SERVICES, NAMELY, WELLNESS, DISEASE MANAGEMENT, CARE MANAGEMENT, CASE MANAGEMENT AND CARE SUPPORT PROGRAMS (U.S. CLS. 100 AND 101).

FIRST USE 7-19-2006; IN COMMERCE 7-19-2006.

3,314,756. VRL INTERNATIONAL LTD., GEORGETOWN, CAYMAN ISLANDS. SN 78-930,129. PUB. 3-27-2007, FILED 7-14-2006.

BLUE MAHOE SPA

THE MARK CONSISTS OF STANDARD CHARACTERS WITHOUT CLAIM TO ANY PARTICULAR FONT, STYLE, SIZE, OR COLOR.

NO CLAIM IS MADE TO THE EXCLUSIVE RIGHT TO USE "SPA", APART FROM THE MARK AS SHOWN.

FOR SPA AND HEALTH SPA SERVICES; BEAUTY, HAIR, NAIL, AND SKIN CARE SALON SERVICES (U.S. CLS. 100 AND 101).

FIRST USE 10-31-2006; IN COMMERCE 10-31-2006.

CLASS 45—PERSONAL AND LEGAL SERVICES

3,313,008. WARNER, JAN L., COLUMBIA, SC. SN 76-445,747. PUB. 12-30-2003, FILED 8-29-2002.

FINALSTEPS

FOR PROVIDING INFORMATION VIA THE INTERNET REGARDING PLANNING FOR FUNERAL AND BURIAL (U.S. CLS. 100 AND 101).

FIRST USE 3-22-2007; IN COMMERCE 3-22-2007.

CLASS 45—(Continued).

3,313,699. TALLEY, HOWARD C., BOYDE, MD. SN 78-633,376. PUB. 9-12-2006, FILED 5-19-2005.

United Hearts Christian Community Church

THE MARK CONSISTS OF STANDARD CHARACTERS WITHOUT CLAIM TO ANY PARTICULAR FONT, STYLE, SIZE, OR COLOR.

NO CLAIM IS MADE TO THE EXCLUSIVE RIGHT TO USE "CHRISTIAN COMMUNITY CHURCH", APART FROM THE MARK AS SHOWN.

FOR RELIGIOUS SERVICES, NAMELY, CHURCH SERVICES (U.S. CLS. 100 AND 101).

FIRST USE 9-11-2005; IN COMMERCE 9-11-2005.

3,313,722. ENGAGE CORPORATION, SAN MATEO, CA. SN 78-644,165. PUB. 8-29-2006, FILED 6-6-2005.

ENGAGE

THE MARK CONSISTS OF STANDARD CHARACTERS WITHOUT CLAIM TO ANY PARTICULAR FONT, STYLE, SIZE, OR COLOR.

FOR SOCIAL NETWORKING AND INTRODUCTION SERVICES; DATING AND MATCHMAKING SERVICES; INTERNET-BASED SOCIAL NETWORKING AND INTRODUCTION SERVICES; INTERNET-BASED DATING AND MATCHMAKING SERVICES (U.S. CLS. 100 AND 101).

FIRST USE 6-21-2005; IN COMMERCE 6-21-2005.

3,314,003. VOLNY, WILLIAM R.J., JR., YORKVILLE, IL. SN 78-751,636. PUB. 7-18-2006, FILED 11-10-2005.



THE SOPHISTICATED
PALATE

THE COLORS RED, BEIGE, AND WHITE ARE CLAIMED

CLASS 45—(Continued).

AS A FEATURE OF THE MARK.

THE COLOR WHITE APPEARS IN THE STYLIZED LETTERS S AND P AND IN THE BACKGROUND OF THE BOTTOM BAND. THE COLOR BEIGE APPEARS IN THE BACKGROUND OF THE TOP BAND, AND THE COLOR RED APPEARS IN THE MIDDLE BAND AND IN THE STYLIZED WORDING "THE SOPHISTICATED PALATE."

FOR PERSONAL CHEF SERVICES (U.S. CLS. 100 AND 101).

FIRST USE 10-0-2005; IN COMMERCE 10-0-2005.

3,314,084. SPROOSE, INC., DANVILLE, CA. SN 78-766,825. PUB. 8-8-2006, FILED 12-5-2005.

SPROOSE

THE MARK CONSISTS OF STANDARD CHARACTERS WITHOUT CLAIM TO ANY PARTICULAR FONT, STYLE, SIZE, OR COLOR.

FOR PROVIDING ONLINE SOCIAL NETWORKING SERVICES (U.S. CLS. 100 AND 101).

FIRST USE 11-1-2005; IN COMMERCE 11-1-2005.

3,314,224. LIVHOME, INC., LOS ANGELES, CA. SN 78-791,123. PUB. 10-24-2006, FILED 1-13-2006.

COMFRERE

THE MARK CONSISTS OF STANDARD CHARACTERS WITHOUT CLAIM TO ANY PARTICULAR FONT, STYLE, SIZE, OR COLOR.

FOR PROVIDING PERSONAL SUPPORT SERVICES FOR THE ELDERLY, NAMELY, SOCIAL SERVICES IN THE NATURE OF COMPANIONSHIP SERVICES AND EMOTIONAL SUPPORT; AND SOCIAL INTRODUCTION SERVICES (U.S. CLS. 100 AND 101).

FIRST USE 7-0-2006; IN COMMERCE 7-0-2006.

CLASS 45—(Continued).

3,314,486. A HAND OF HOPE, INC., PHOENIX, AZ. SN 78-848,261. PUB. 12-19-2006, FILED 3-28-2006.

HOPEKIDS

THE MARK CONSISTS OF STANDARD CHARACTERS WITHOUT CLAIM TO ANY PARTICULAR FONT, STYLE, SIZE, OR COLOR.

FOR CHARITABLE SERVICES, NAMELY, GRANTING WISHES OF TERMINALLY ILL YOUNG PEOPLE IN THE NATURE OF ARRANGING ACTIVITIES AND PROVIDING DONATIONS OF GOODS AND SERVICES FOR THE YOUNG PEOPLE BASED ON THEIR EXPRESSED REQUESTS (U.S. CLS. 100 AND 101).
FIRST USE 3-31-2006; IN COMMERCE 3-31-2006.

3,314,847. SEWARD, JAN STEFANACCI, GREAT BARRINGTON, MA. SN 78-958,456. PUB. 4-17-2007, FILED 8-23-2006.

FRUITION

CLASS 45—(Continued).

THE MARK CONSISTS OF STANDARD CHARACTERS WITHOUT CLAIM TO ANY PARTICULAR FONT, STYLE, SIZE, OR COLOR.

FOR PERSONAL GROWTH AND MOTIVATION CONSULTING SERVICES (U.S. CLS. 100 AND 101).
FIRST USE 3-1-2007; IN COMMERCE 3-1-2007.

3,314,901. MONITOR CLOSELY.COM, LLC, CINCINNATI, OH. SN 78-978,832. PUB. 10-24-2006, FILED 3-20-2006.

MONITORCLOSELY.COM

THE MARK CONSISTS OF STANDARD CHARACTERS WITHOUT CLAIM TO ANY PARTICULAR FONT, STYLE, SIZE, OR COLOR.

FOR PROVIDING ONLINE MONITORING, NAMELY, REMOTE VIDEO MONITORING OF VIDEO SURVEILLANCE SYSTEMS BY USERS, VIEWABLE THROUGH A GLOBAL COMPUTER NETWORK VIA A SECURE WEBSITE (U.S. CLS. 100 AND 101).
FIRST USE 6-3-2006; IN COMMERCE 6-3-2006.

* * * * *

PRIOR UNITED STATES CLASSIFICATION

APPLICATION IN ONE CLASS

COLLECTIVE MEMBERSHIP MARKS

CERTIFICATION MARKS

CLASS 200—COLLECTIVE MEMBERSHIP

CLASS A—GOODS

3,314,415. FREE SPIRIT CHAPTER SOUTHEAST MICHIGAN, WHITMORE LAKE, MI. SN 78-825,877. PUB. 12-26-2006, FILED 2-28-2006.

3,312,995. UPNP IMPLEMENTERS CORPORATION, SAN RAMON, CA. SN 76-299,334. PUB. 3-11-2003, FILED 8-13-2001.



UPNP

THE CERTIFICATION MARK, AS INTENDED TO BE USED BY AUTHORIZED PERSONS, IS INTENDED TO CERTIFY THAT REPRESENTATIVE SAMPLINGS OF THE GOODS CONFORM TO TECHNICAL REQUIREMENTS ESTABLISHED BY THE APPLICANT REGARDING THE INTEROPERABILITY OF THE GOODS ON A GLOBAL OR PRIVATE COMPUTER NETWORK. FOR COMPUTER HARDWARE AND SOFTWARE, ELECTRICAL APPLIANCES (U.S. CL. A). FIRST USE 11-10-2001; IN COMMERCE 11-10-2001.

NO CLAIM IS MADE TO THE EXCLUSIVE RIGHT TO USE "CHAPTER, SOUTHEAST MICHIGAN AND EST. 1995", APART FROM THE MARK AS SHOWN. THE COLOR(S) YELLOW, WHITE, RED, BLACK, SKY BLUE IS/ARE CLAIMED AS A FEATURE OF THE MARK. THE MARK CONSISTS OF THE WORDING IN THE MARK IS BLACK ON YELLOW BANNER. CONCENTRIC CIRCLES ARE DISPLAYED IN SKY BLUE, RED, YELLOW, BLACK AND WHITE. FOUR FEATHERS ARE WHITE, YELLOW, AND RED. THE FIVE SMALL CIRCLES ON EACH SIDE OF MARK ARE RED AND SKY BLUE. FOR INDICATING MEMBERSHIP IN A(N) MOTOR-CYCLE CLUB (U.S. CL. 200). FIRST USE 9-16-2006; IN COMMERCE 9-16-2006.

3,313,956. NLGI, KANSAS CITY, MO. SN 78-743,743. PUB. 10-10-2006, FILED 10-31-2005.



3,314,487. MAGYAR, DONALD W., WINTER SPRINGS, FL. SN 78-848,507. PUB. 11-21-2006, FILED 3-29-2006.

PATRIOT PARTY

THE MARK CONSISTS OF STANDARD CHARACTERS WITHOUT CLAIM TO ANY PARTICULAR FONT, STYLE, SIZE, OR COLOR. NO CLAIM IS MADE TO THE EXCLUSIVE RIGHT TO USE "PARTY", APART FROM THE MARK AS SHOWN. FOR INDICATING MEMBERSHIP IN A POLITICAL PARTY (U.S. CL. 200). FIRST USE 5-7-2006; IN COMMERCE 5-7-2006.

OWNER OF U.S. REG. NOS. 1,690,689 AND 2,477,127. THE CERTIFICATION MARK, AS INTENDED TO BE USED BY AUTHORIZED PERSONS, IS INTENDED TO CERTIFY THAT THE GOODS ARE MANUFACTURED IN ACCORDANCE WITH THE GREASE CATEGORIES AND THE CORRESPONDING PERFORMANCE CLASSIFICATION DESCRIPTIONS OF THE APPLICANT. FOR AUTOMOTIVE LUBRICATING GREASE (U.S. CL. A). FIRST USE 3-31-2006; IN COMMERCE 3-31-2006.

* * * * *

SUPPLEMENTAL REGISTER

These registrations are not subject to opposition.

SECTION 1.— INTERNATIONAL CLASSIFICATION

The short titles associated below with the international class numbers are terms designed merely for quick identification and are not an official part of the international classification. The full names of international classes are given in section 6.1 of the trademark rules of practice.

The designation "U.S. Cl." appearing in this section refers to the U.S. class in effect prior to Sep. 1, 1973 rather than the international class which applies to applications filed on or after that date. For adoption of international classification see notice in the OFFICIAL GAZETTE of Jun. 26, 1973 (911 O.G. TM 210).

Application in more than one class

3,314,919. KABUSHIKIGAISHA KI-AIKIDO PRODUCTS, TOKYO, 101-0003, JAPAN. SN 76-662,798. FILED P.R. 7-10-2006; AM. S.R. 8-28-2007.

3,314,920. ENDO PHARMACEUTICALS INC., CHADDS FORD, PA. SN 76-664,475. FILED P.R. 8-11-2006; AM. S.R. 6-12-2007.

KIATSU

**PARTNERSHIP FOR RESPONSIBLE
OPIOID MANAGEMENT THROUGH
INFORMATION, SUPPORT AND EDUCATION**

THE MARK CONSISTS OF STANDARD CHARACTERS WITHOUT CLAIM TO ANY PARTICULAR FONT, STYLE, SIZE, OR COLOR.

OWNER OF U.S. REG. NO. 1,399,897.

THE ENGLISH TRANSLATION OF THE WORD KIATSU IN THE MARK IS "PRESS WITH KI".

CLASS 16—PAPER GOODS AND PRINTED MATTER

FOR PRINTED PUBLICATIONS, NAMELY, INFORMATIONAL AND INSTRUCTIONAL MATERIALS NAMELY BROCHURES, PAMPHLETS, LEAFLETS, AND INFORMATION SHEETS FEATURING INFORMATION THAT PROMOTES PHYSICAL AND MENTAL HEALTH FOR BOTH CHILDREN AND ADULTS (U.S. CLS. 2, 5, 22, 23, 29, 37, 38 AND 50).

FIRST USE 0-0-1974; IN COMMERCE 0-0-1983.

CLASS 41—EDUCATION AND ENTERTAINMENT

FOR EDUCATIONAL AND INSTRUCTIONAL SERVICES, NAMELY, PROVIDING VARIOUS COURSES OF INSTRUCTION, NAMELY TRAINING INSTRUCTORS, CHILDREN, TEENAGERS, AND ADULTS IN THE FIELD OF PROMOTING PHYSICAL AND MENTAL HEALTH (U.S. CLS. 100, 101 AND 107).

FIRST USE 0-0-1981; IN COMMERCE 0-0-1983.

THE MARK CONSISTS OF STANDARD CHARACTERS WITHOUT CLAIM TO ANY PARTICULAR FONT, STYLE, SIZE, OR COLOR.

NO CLAIM IS MADE TO THE EXCLUSIVE RIGHT TO USE "OPIOID MANAGEMENT THROUGH INFORMATION, SUPPORT AND EDUCATION", APART FROM THE MARK AS SHOWN.

CLASS 41—EDUCATION AND ENTERTAINMENT

FOR MEDICAL EDUCATION SERVICES, NAMELY, WORKSHOPS, AUDIO CONFERENCES, WEBCAST CONFERENCES AND SYMPOSIA IN THE FIELD OF OPIOID MANAGEMENT (U.S. CLS. 100, 101 AND 107).

FIRST USE 6-21-2006; IN COMMERCE 6-21-2006.

CLASS 44—MEDICAL, BEAUTY AND AGRICULTURAL SERVICES

FOR MEDICAL SERVICES, NAMELY, PROVIDING INFORMATION IN THE FIELD OF OPIOID PHARMACEUTICAL ABUSE PREVENTION (U.S. CLS. 100 AND 101).

FIRST USE 6-21-2006; IN COMMERCE 6-21-2006.

3,314,930. SONY PICTURES TELEVISION INC., CULVER CITY, CA. SN 77-018,310. FILED P.R. 10-11-2006; AM. S.R. 8-1-2007.

3,314,947. INTERLEGIS, INC., DALLAS, TX. SN 77-090,022. FILED P.R. 1-24-2007; AM. S.R. 7-18-2007.

THE MINISODE NETWORK

THE MARK CONSISTS OF STANDARD CHARACTERS WITHOUT CLAIM TO ANY PARTICULAR FONT, STYLE, SIZE, OR COLOR.

NO CLAIM IS MADE TO THE EXCLUSIVE RIGHT TO USE "NETWORK", APART FROM THE MARK AS SHOWN.

CLASS 38—COMMUNICATION

FOR STREAMING OF VIDEO MATERIAL ON THE INTERNET; ELECTRONIC TRANSMISSION OF AUDIO VISUAL CONTENT IN THE NATURE OF EDITED TELEVISION PROGRAMMING VIA TELEVISION, WIRELESS MOBILE DEVICES OR THE INTERNET (U.S. CLS. 100, 101 AND 104).

FIRST USE 6-19-2007; IN COMMERCE 6-19-2007.

CLASS 41—EDUCATION AND ENTERTAINMENT

FOR ENTERTAINMENT SERVICES NAMELY, PROVIDING TELEVISION PROGRAMS IN THE FIELD OF COMEDY, DRAMA, ACTION, ADVENTURE, MUSIC AND VARIETY ENTERTAINMENT, VIA A GLOBAL COMPUTER NETWORK (U.S. CLS. 100, 101 AND 107).

FIRST USE 6-19-2007; IN COMMERCE 6-19-2007.

3,314,946. SSJ DEVELOPMENT LLC, BROOKLYN, NY. SN 77-083,049. FILED P.R. 1-15-2007; AM. S.R. 7-31-2007.

Revitalized Waterfront Living

THE MARK CONSISTS OF STANDARD CHARACTERS WITHOUT CLAIM TO ANY PARTICULAR FONT, STYLE, SIZE, OR COLOR.

NO CLAIM IS MADE TO THE EXCLUSIVE RIGHT TO USE "WATERFRONT LIVING", APART FROM THE MARK AS SHOWN.

CLASS 35—ADVERTISING AND BUSINESS

FOR REAL ESTATE MARKETING SERVICES IN THE FIELD OF WATERFRONT COMMUNITIES, HOMES, CONDOMINIUMS AND RESIDENTIAL UNITS (U.S. CLS. 100, 101 AND 102).

FIRST USE 5-15-2006; IN COMMERCE 5-15-2006.

CLASS 37—CONSTRUCTION AND REPAIR

FOR LAND DEVELOPMENT SERVICES, NAMELY, THE PLANNING, LAYING OUT, CONSTRUCTION AND MAINTENANCE OF RESIDENTIAL WATERFRONT COMMUNITIES (U.S. CLS. 100, 103 AND 106).

FIRST USE 5-15-2006; IN COMMERCE 5-15-2006.

DOCUMENT INTELLIGENCE

THE MARK CONSISTS OF STANDARD CHARACTERS WITHOUT CLAIM TO ANY PARTICULAR FONT, STYLE, SIZE, OR COLOR.

CLASS 42—SCIENTIFIC AND COMPUTER SERVICES

FOR CONVERSION OF DATA OR DOCUMENTS FROM PHYSICAL TO ELECTRONIC MEDIA; PROVIDING TEMPORARY USE OF NON-DOWNLOADABLE COMPUTER SOFTWARE FOR TRACKING DOCUMENTS OVER COMPUTER NETWORKS, INTRANETS, AND THE INTERNET; INFORMATION MANAGEMENT SERVICES, NAMELY, EXTRACTION OF METADATA, TEXT, INFORMATION, AND DATA FROM DOCUMENTS, HARD COPIES, AND ELECTRONIC MEDIA; INFORMATION MANAGEMENT SERVICES, NAMELY, COMPARISONS AND IDENTIFICATION OF METADATA, TEXT, INFORMATION AND DATA FROM DOCUMENTS, HARD COPIES, AND ELECTRONIC MEDIA; COMPUTER SERVICES, NAMELY ACTING AS AN APPLICATION SERVICE PROVIDER IN THE FIELD OF KNOWLEDGE MANAGEMENT TO HOST COMPUTER APPLICATION SOFTWARE FOR CREATING SEARCHABLE DATABASES OF INFORMATION AND DATA (U.S. CLS. 100 AND 101).

FIRST USE 3-1-2004; IN COMMERCE 3-1-2004.

CLASS 45—PERSONAL AND LEGAL SERVICES

FOR LITIGATION SUPPORT SERVICES (U.S. CLS. 100 AND 101).

FIRST USE 3-1-2004; IN COMMERCE 3-1-2004.

3,314,969. RYOHIN KEIKAKU CO., LTD., TOKYO, JAPAN. SN 78-420,067. FILED P.R. 5-17-2004; AM. S.R. 2-13-2006.

無印良品

OWNER OF JAPAN REG. NO. 3192983, DATED 8-30-1996, RENEWED AS REG. NO. 3192983, DATED 8-1-2006, EXPIRES 8-30-2016.

OWNER OF JAPAN REG. NO. 3323471, DATED 6-20-1997, RENEWED AS REG. NO. 3323471, DATED 5-15-2007, EXPIRES 6-20-2017.

OWNER OF JAPAN REG. NO. 3217445, DATED 10-31-1996, RENEWED AS REG. NO. 3217445, DATED 10-10-2006, EXPIRES 10-31-2016.

OWNER OF JAPAN REG. NO. 3217443, DATED 10-31-1996, RENEWED AS REG. NO. 3217443, DATED 10-10-2006, EXPIRES 10-31-2016.

OWNER OF JAPAN REG. NO. 3211951, DATED 10-31-1996, RENEWED AS REG. NO. 3211951, DATED 10-10-2006, EXPIRES 10-31-2016.

OWNER OF JAPAN REG. NO. 3211950, DATED 10-31-1996, RENEWED AS REG. NO. 3211950, DATED 10-10-2006, EXPIRES 10-31-2016.

OWNER OF JAPAN REG. NO. 3247784, DATED 1-31-1997, RENEWED AS REG. NO. 3247784, DATED 11-14-2006, EXPIRES 1-31-2017.

OWNER OF JAPAN REG. NO. 3234928, DATED 12-25-1996, RENEWED AS REG. NO. 3234928, DATED 11-7-2006, EXPIRES 12-25-2016.

OWNER OF JAPAN REG. NO. 3211949, DATED 10-31-1996, RENEWED AS REG. NO. 3211949, DATED 10-10-2006, EXPIRES 10-31-2016.

OWNER OF JAPAN REG. NO. 3230140, DATED 11-29-1996, RENEWED AS REG. NO. 3230140, DATED 10-24-2006, EXPIRES 11-29-2016.

OWNER OF JAPAN REG. NO. 3211948, DATED 10-31-1996, RENEWED AS REG. NO. 3211948, DATED 10-10-2006, EXPIRES 10-31-2016.

OWNER OF JAPAN REG. NO. 3186362, DATED 8-30-1996, RENEWED AS REG. NO. 3186362, DATED 8-1-2006, EXPIRES 8-30-2016.

OWNER OF JAPAN REG. NO. 3217441, DATED 10-31-1996, RENEWED AS REG. NO. 3217441, DATED 10-10-2006, EXPIRES 10-31-2016.

OWNER OF JAPAN REG. NO. 3232161, DATED 12-25-1996, RENEWED AS REG. NO. 3232161, DATED 11-7-2006, EXPIRES 12-25-2016.

OWNER OF JAPAN REG. NO. 3217440, DATED 10-31-1996, RENEWED AS REG. NO. 3217440, DATED 10-10-2006, EXPIRES 10-31-2016.

OWNER OF JAPAN REG. NO. 3230138, DATED 11-29-1996, RENEWED AS REG. NO. 3230138, DATED 10-24-2006, EXPIRES 11-29-2016.

OWNER OF JAPAN REG. NO. 3192789, DATED 8-30-1996, RENEWED AS REG. NO. 3192789, DATED 8-1-2006, EXPIRES 8-30-2016.

OWNER OF JAPAN REG. NO. 3211947, DATED 10-31-1996, RENEWED AS REG. NO. 3211947, DATED 10-10-2006, EXPIRES 10-31-2016.

OWNER OF U.S. REG. NOS. 2,351,072 AND 2,660,126. THE FOREIGN WORDING IN THE MARK TRANSLATES INTO ENGLISH AS NO BRAND GOODS.

THE NON-LATIN CHARACTER(S) IN THE MARK TRANSLITERATES INTO MUJIRUSHI RYOHIN, AND THIS MEANS NO BRAND GOODS IN ENGLISH.

CLASS 3—COSMETICS AND CLEANING PREPARATIONS

FOR (BASED ON USE IN COMMERCE) INCENSE, NAMELY INCENSE CONES AND INCENSE STICKS, BATH SALTS, PUMICE FOR COSMETIC AND PERSONAL USE, NAMELY CERAMIC PUMICE STICKS AND PUMICE STONES, NAIL POLISH REMOVER, COSMETIC PADS, COTTON SWABS, NAMELY ALL PURPOSE COTTON SWABS FOR PERSONAL USE, COTTON FOR COSMETIC PURPOSES, NAMELY COTTON PADS, GLYCERIN SOAP, TOOTHPASTE, COSMETIC PALETTES NAMELY, EMERY BOARDS; (BASED ON 44(E)) FACIAL CLEANSER, ESSENTIAL OILS FOR PERSONAL USE, PERFUME, EAU DE COLOGNE, PERFUMES, COSMETICS, SHAMPOOS, HAIR RINSES, HAIR CREAMS, HAIR MOUSSE, COTTON WOOLS FOR COSMETIC PURPOSES, BODY LOTIONS FOR COSMETIC PURPOSES, SKIN TONING LOTION, BODY LOTION, COSMETIC BEAUTY MILK, SKIN MOISTURIZER, COSMETIC CREAM, CLEANSING GEL, CLEANSING MILK FOR TOILET PURPOSES, EYEBROW PENCILS, EYE SHADOW, EYELINERS, LIPSTICKS, LIP GLOSSES, MAKE-UP POWDERS, CREAMY FOUNDATIONS, CONCEALERS, NAIL ENAMELS, NAIL POLISH, DENTIFRICES, LAUNDRY DETERGENTS, LAUNDRY BLEACH, NAMELY BLEACHING PREPARATIONS FOR LAUNDRY, BATH OILS, POLISHING PREPARATIONS (U.S. CLS. 1, 4, 6, 50, 51 AND 52).

FIRST USE 9-1-1999; IN COMMERCE 9-1-1999.

CLASS 4—LUBRICANTS AND FUELS

FOR CANDLES, PERFUMED CANDLES, SCENTED CANDLES (U.S. CLS. 1, 6 AND 15).

FIRST USE 9-1-1999; IN COMMERCE 9-1-1999.

CLASS 6—METAL GOODS

FOR (BASED ON USE IN COMMERCE) METAL KEY RINGS, METAL KEY RING HOLDERS MADE OF ALUMINUM, (BASED ON 44(E)) TIN CANS SOLD EMPTY, NAMEPLATES OF METAL, TOWEL DISPENSERS OF METAL, NAILS OF METAL, METAL HARDWARE AND FASTENERS, NAMELY WASHERS, TACKS, PLUGS, BOLTS, SCREWS, CASTERS OF METAL, ALUMINUM FOIL (U.S. CLS. 2, 12, 13, 14, 23, 25 AND 50).

FIRST USE 9-1-1999; IN COMMERCE 9-1-1999.

CLASS 8—HAND TOOLS

FOR (BASED ON USE IN COMMERCE) MULTI-FUNCTION HAND TOOLS COMPRISED OF SCREWDRIVERS, KNIVES, CAN OPENERS, FILE AND PLIERS, AND TOOL POUCHES FOR ATTACHMENT TO TOOL BELTS, HAND TOOL SETS, NAMELY SETS COMPRISED OF SCREWDRIVERS, CUTLERY, NAMELY FORKS, KNIVES, BUTTER KNIVES, SPOONS, GRAPEFRUIT SPOONS, HAND TOOLS, NAMELY CARTON CUTTERS, METAL AND NON-METAL SCISSORS, EYELASH CURLERS, NAIL CLIPPERS, NAIL SCISSORS, NAIL FILES, NAIL CARE SETS COMPRISED OF NAIL FILES AND NAIL SCISSORS, TWEEZERS; (BASED ON 44(E)) ELECTRIC RAZORS, SHAVING CASES, NON-ELECTRIC TIN CAN OPENERS, HAND TOOLS, NAMELY NON-ELECTRIC CRIMPING IRONS, SPANNERS, HAND TOOLS, NAMELY CUTTING PINCERS, ELECTRIC HAIR CLIPPERS, NAIL NIPPERS; PAPER AND NON-METAL TABLEWARE, NAMELY KNIVES FORKS, AND SPOONS, RICE SCOOPS (U.S. CLS. 23, 28 AND 44).

FIRST USE 9-1-1999; IN COMMERCE 9-1-1999.

CLASS 9—ELECTRICAL AND SCIENTIFIC APPARATUS

FOR (BASED ON USE IN COMMERCE) STEREO SPEAKERS, CD PLAYERS, CD HOLDERS, COMPACT DISC AND COMPUTER DISC CASES, IN THE NATURE OF CD STORAGE BOXES, CD TRAVEL CASES, CD STORAGE WALLETS, CD STORAGE WALLET REFILLS, AND CD FOLDERS MADE OF ALUMINUM; ELECTRONIC CALCULATORS, MOUSE PADS, METAL AND NON-METAL TAPE MEASURES, CONTACT LENS CASES, CONTACT LENS TRAVEL CASES, EYEGLASS POUCHES, TRAVEL RADIOS INCORPORATING CLOCKS; (BASED ON 44(E)) BATTERIES, CAMERAS, DISPOSABLE CAMERAS, TELEVISION RECEIVERS, RADIOS, VIDEO CAMERAS, VIDEO CASSETTE RECORDERS, ELECTRONIC CALCULATING MACHINES, WORD PROCESSORS, ELECTRIC FLAT IRONS, ELECTRICALLY HEATED HAIR-CURLERS, SUNGLASSES, CLEANING CLOTHS FOR EYEGLASSES, PRE-RECORDED COMPACT DISCS FEATURING MUSIC, MAGNETS, TELEPHONES, SCALES (U.S. CLS. 21, 23, 26, 36 AND 38).

FIRST USE 9-1-1999; IN COMMERCE 9-1-1999.

CLASS 11—ENVIRONMENTAL CONTROL APPARATUS

FOR FLASHLIGHTS; ELECTRIC LAMPS, ELECTRIC LIGHTING FIXTURES, NAMELY LIGHTING APPARATUS AND INSTALLATIONS, ICE BOXES, NAMELY ICE CHESTS, ELECTRIC FANS, ELECTRIC RICE COOKERS, ELECTRIC HEATING STOVES, ELECTRIC AND GAS KITCHEN RANGES, ELECTRIC AND GAS COOKING OVENS, AIR CONDITIONERS, MINIATURE LIGHT BULBS, OIL SPACE HEATERS, ELECTRIC SPACE HEATERS, ELECTRIC REFRIGERATORS, ELECTRIC TOASTERS, HOT PLATES, PORTABLE GAS RANGES, ELECTRIC KEFFLES, ELECTRIC COFFEE MAKERS, ELECTRIC HEATED CARPETS, HAND SHOWERS, WATER PURIFIERS, NAMELY WATER PURIFYING APPARATUS AND MACHINES, HAIR DRYERS, CLOTHES DRYERS (U.S. CLS. 13, 21, 23, 31 AND 34).

FIRST USE 9-1-1999; IN COMMERCE 9-1-1999.

CLASS 12—VEHICLES

FOR BICYCLES, PARTS AND ACCESSORIES FOR BICYCLES, NAMELY, FORKS, DRIVE CHAINS AND AIR PUMPS; BABY CARRIAGES, AUTOMOBILES, PARTS AND ACCESSORIES FOR AUTOMOBILES, NAMELY, WHEELS AND RIMS; SAFETY SEATS FOR CHILDREN FOR VEHICLES, AUTOBICYCLES, NAMELY MOPEDS, FOLDING BICYCLES, AUTOMOBILES, NAMELY LIGHT ROADSTERS (U.S. CLS. 19, 21, 23, 31, 35 AND 44).

CLASS 14—JEWELRY

FOR WATCHES, TRAVEL CLOCKS; CUFF LINKS, TIE PINS, JEWELRY, CHRONOMETRIC INSTRUMENTS, CUPS OF PRECIOUS METAL, NAMELY COMMEMORATIVE STATUARY CUPS MADE OF PRECIOUS METAL; POWDER COMPACTS OF PRECIOUS METAL, PURSES OF PRECIOUS METAL, JEWEL BOXES OF PRECIOUS METAL, WATCH BANDS, WATCH CHAINS, CLOCKS, ALARM CLOCKS, CHRONOSCOPES, CLOCKS AND WATCHES, ELECTRIC CLOCKS AND WATCHES, STRAPS FOR WRISTWATCHES, KEY HOLDERS, BELT BUCKLES OF PRECIOUS METAL, BRACELETS, BROOCHES, ORNAMENTS OF PRECIOUS METAL (U.S. CLS. 2, 27, 28 AND 50).

FIRST USE 9-1-1999; IN COMMERCE 9-1-1999.

CLASS 16—PAPER GOODS AND PRINTED MATTER

FOR CLIPBOARDS MADE OF RESIN, CLIPBOARDS MADE OF ALUMINUM, AGENDA CALENDARS, DESK PLANNERS, CALENDARS, PLASTIC PAPER CLIPS, BINDER PAPER CLIPS, CORRECTION FLUID DISPENSING PENS, DESK ORGANIZERS, ERASERS INCLUDING ERASER ROLLS AND RETRACTABLE AND REFILLABLE ERASERS, ERASER SETS; COMPRISED OF ERASERS AND ERASER ROLLS, GLUE PENS, GLUE STICKS, OFFICE HOLE PUNCHES, LETTER OPENERS, MINI-OFFICE DESK SETS, NON-METAL PENCIL CASES, PENCIL CASES MADE OF ALUMINUM, NON-METAL PEN CASES, PEN CASES MADE OF ALUMINUM, PEN TUBES MADE OF ALUMINUM, NON-METAL PEN AND PENCIL CASES, PEN AND PENCIL CASES MADE OF ALUMINUM, PEN HOLDERS, PEN HOLDERS IN THE NATURE OF PEN STORAGE CUPS FOR DESK USE, DRAWING AND DRAFTING RULERS, NAMELY NON-METAL RULERS, RULERS MADE OF ALUMINUM, MULTI-FUNCTION RULERS, PENCIL SHARPENERS, STAPLERS, STAPLES, PAPER FASTENERS, NAMELY THUMB TACKS, ADHESIVE TAPES FOR STATIONERY PURPOSES, NAMELY TRANSPARENT TAPE, CORRECTION TAPE FOR TYPING, DOCUMENT HOLDERS, DOCUMENT FOLDERS, DOCUMENT PORTFOLIO FILES, THREE-RING BINDERS, DOCUMENT FILE HOLDERS, CRAFT BOXES, NAMELY ART AND CRAFT PAINT KITS, ENVELOPE LETTER FILES, ACCORDION FILES, NAMELY PAPER EXPANDING FILES, FILE POCKETS, PHOTO ALBUMS, PHOTO FILE ALBUMS, NOTEBOOKS, SPIRAL NOTEBOOKS, NOTEBOOKS WITH ELASTIC CLOSURES, SCRIBBLE PADS, MEMO PADS, WRITING PADS, ADHESIVE PAGE MARKERS, STICK-ON NOTE PADS, PERSONAL ORGANIZERS, NAMELY NON-METAL EXECUTIVE ORGANIZERS, EXECUTIVE ORGANIZERS MADE OF ALUMINUM, EXECUTIVE ORGANIZER PAPER REFILLS, ORIGAMI PAPER, PHOTO ALBUM PAGE REFILLS, CARDBOARD PHOTO STORAGE BOXES, DESKTOP POSTCARD HOLDERS, DESKTOP BUSINESS CARD HOLDERS, COVERED LOOSE-LEAF NOTEPADS, MEMO PADS BOUND BY A METAL RING, SKETCHBOOKS, PLASTIC PAGE HOLDERS WITH ZIPPER SEALS, DOCUMENT FILES WITH CLAMPS TO SECURE PAPERS, ADHESIVE NOTE PADS, COLOR PENCILS, CRAYONS, OILED PASTELS, ART SETS, COMPRISED OF ART PAPER AND ART MOUNTS, PENS OF METAL AND NON-METAL, PENCILS OF ALUMINUM AND NON-METAL, PENCIL LEAD REFILLS, GEL PENS, FELT-TIP PENS, HIGHLIGHTER PENS, PEN REFILLS,

COSMETIC PENCIL SHARPENERS, FACIAL TISSUE IN THE NATURE OF PAPER TISSUE PACKAGES, PAPER PACKAGING CONTAINERS, PAPER TOWELS, TABLE CLOTHS OF PAPER, DIARIES, PHOTOGRAPH STANDS MADE OF PAPER AND CARDBOARD, PAPER STATIONERY, WRITING IMPLEMENTS, ADHESIVES FOR STATIONERY OR HOUSEHOLD PURPOSES, PAPER BOXES, STATIONERY SEALS, WRITING PAPER HOLDERS, ADHESIVE TAPES FOR STATIONERY PURPOSES, STATIONERY, ENVELOPES, STAPLING PRESSES, NOTEBOOKS, MEMO PADS, PRINTED MAGAZINES AND CATALOGUES IN THE FIELD OF OFFICE SUPPLIES, PACKING PAPER, PAPER AND PLASTIC BAGS FOR PACKING, NAMELY, ENVELOPES AND POUCHES, LABELS OF NON-TEXTILES, NAMELY PAPER LABELS, SHIPPING LABELS OF LEATHER FOR TRUNKS, GREETING CARDS, POSTERS, ADVERTISING PICTURES, CARDBOARD, PRINTED MATTER, NAMELY NOTE PADS, BOOKBINDING MATERIALS, NAMELY BOOK BINDINGS, BOOKBINDING WIRE, BINDERS (U.S. CLS. 2, 5, 22, 23, 29, 37, 38 AND 50).

FIRST USE 9-1-1999; IN COMMERCE 9-1-1999.

CLASS 18—LEATHER GOODS

FOR BUSINESS CARD CASES MADE OF ALUMINUM, NON-METAL BUSINESS CARD CASES, DOCUMENT CASES, MONEY POUCHES, NAMELY LEATHER BAGS FOR HOLDING CURRENCY, COSMETIC CASES SOLD EMPTY, LIPSTICK CASES SOLD EMPTY; LEATHER BAGS, LEATHER AND MESH SHOPPING BAGS, SHOULDER BAGS, BRIEFCASES, TOTE BAGS, RUCKSACKS, WALLETS, UMBRELLAS, FOLDING UMBRELLAS, LEATHER SLING BAGS FOR CARRYING INFANTS; SHAVING CASES, NAMELY SHAVING BAGS SOLD EMPTY (U.S. CLS. 1, 2, 3, 22 AND 41).

FIRST USE 9-1-1999; IN COMMERCE 9-1-1999.

CLASS 20—FURNITURE AND ARTICLES NOT OTHERWISE CLASSIFIED

FOR CLOTHES HANGERS MADE OF ALUMINUM, NAMELY, 3-TIER HANGERS, SKIRT/TROUSER HANGERS, WIRE HANGERS; TIE HANGERS, SUIT HANGERS WITH AND WITHOUT CLIPS, HANGING CANVAS HOLDERS USED TO STORE MULTIPLE PAIRS OF SHOES; HANGING CANVAS HOLDERS USED TO STORE MULTIPLE SHIRTS AND OTHER TYPES OF CLOTHING-DISPENSERS FOR PILLS OR CAPSULES SOLD EMPTY, NAMELY ALUMINUM PILL DISPENSING CASES; FURNITURE, NAMELY, COMPACT DISC AND COMPUTER DISC STANDS- ACRYLIC PICTURE FRAMES, CANVAS LAUNDRY HAMPER, NON-METAL BOXES, NAMELY FOAM STORAGE BOXES, ACRYLIC FURNITURE MIRRORS, PERSONAL COMPACT MIRRORS; FURNITURE, NAMELY CHESTS OF DRAWERS, DESKS, TABLES AND CHAIRS, NON-METAL BOXES OF WOOD AND BAMBOO, PACKAGING CONTAINERS OF PLASTIC, NAMELY, TUBS FOR CONSUMER PRODUCTS PACKAGING, CUSHIONS, PILLOWS, MATTRESSES, FLAT HAND FANS, NON-METAL TOOL BOXES, MAGAZINE RACKS, BOOKSHELVES, CURTAIN HOLDERS NOT MADE OF TEXTILE MATERIAL, NAMELY CURTAIN RODS, CURTAIN RAILS, INDOOR WINDOW BLINDS, BEDS, NON-METAL CASTERS, COAT HANGERS, SOFAS, SERVING TROLLEYS; HOUSEHOLD LINERS, NAMELY PLASTIC INSERTS FOR USE AS CONTAINER LINERS, DIVIDERS FOR UTENSIL DRAWERS, PLASTIC BOXES, NAMELY ACRYLIC STORAGE BOXES (U.S. CLS. 2, 13, 22, 25, 32 AND 50).

FIRST USE 9-1-1999; IN COMMERCE 9-1-1999.

CLASS 21—HOUSEWARES AND GLASS

FOR NON-METAL POP-UP LAUNDRY BASKETS, CLOTHES PEGS—SHOPPING BASKETS OF WOOD, DUSTPANS; BROOMS, INCENSE HOLDERS, LINT ROLLER BRUSHES AND REFILLS THEREFOR; LINT BRUSHES, NON-METAL BOXES, NON-METAL HOUSEHOLD CONTAINERS, NAMELY ACRYLIC TISSUE BOXES OF ALUMINUM AND NON-METAL, WOODEN BOWL AND SAUCER SETS, ICE CUBE TRAYS IN TRAY, BALL AND CYLINDER FORM, BEVERAGE STIRRERS, TEA POT STRAINERS; WICKER BASKETS, STORAGE POTS WITH LIDS THEREFOR; NAIL BRUSHES, COSMETIC BRUSHES, LIPSTICK BRUSHES, TRAVEL TOOTHBRUSH SETS COMPRISED OF TOOTHBRUSHES AND TOOTHBRUSH CASES, TOOTHBRUSHES, ACRYLIC STACKING POTS, PERFUME ATOMIZERS, SOLD EMPTY, BOTTLE REFILL SETS COMPRISED OF EMPTY SPRAY BOTTLES AND BOTTLE OPENERS, EMPTY SQUEEZE BOTTLES, NAMELY FLIP TOP BOTTLES, SCREW-TOP BOTTLES, AND SPRAY BOTTLES, CLOTHES BRUSHES, HAIR COMBS INCLUDING FOLDING COMBS, LENS CLEANING CLOTHS; COOKING POTS, GRIDDLES, FRYING PANS, NON-ELECTRIC COFFEE POTS NOT OF PRECIOUS METAL, KETTLES, CUPS, DRINKING GLASSES, DISHES, BOTTLES, SOLD EMPTY, LUNCH BOXES, TOILET UTENSILS, NAMELY TOILET BRUSHES, HAND-OPERATED CLEANING INSTRUMENTS AND LAUNDRY EQUIPMENT, NAMELY BUCKETS, MOPS, DUSTERS, AND DUSTBINS, WATERING CANS, SHOE HORNS, POWDER PUFFS, POWDER COMPACTS SOLD EMPTY, TOILET SPONGES, HAIR BRUSHES, IRONING BOARDS, FLOWER POTS, CANDLES, NOT OF PRECIOUS METAL, VASES NOT OF PRECIOUS METAL, TRAYS NOT OF PRECIOUS METAL, CHOPSTICKS, CUTTING BOARDS, BOTTLE OPENERS, GRATERS FOR HOUSEHOLD PURPOSES (U.S. CLS. 2, 13, 23, 29, 30, 33, 40 AND 50).

FIRST USE 9-1-1999; IN COMMERCE 9-1-1999.

CLASS 24—FABRICS

FOR BEDDING, NAMELY BED LINENS, BED SHEETS, JAPANESE WASHCLOTHS, COTTON TOWELS; CLOTHS, NAMELY HEMP CLOTH, HANDKERCHIEFS, TABLE NAPKINS OF TEXTILE, BED QUILTS, COVERS, BED QUILT CASES, CURTAINS OF TEXTILE OR PLASTIC, BED BLANKETS (U.S. CLS. 42 AND 50).

FIRST USE 9-1-1999; IN COMMERCE 9-1-1999.

CLASS 25—CLOTHING

FOR (BASED ON USE IN COMMERCE) CLOTHING, NAMELY DENIM APRONS, TRAVEL RAINCOATS, T-SHIRTS, (BASED ON 44(E)) BELTS, SHOES, BOOTS, SANDALS, JACKETS, SHIRTS, CHILDREN'S WEAR, NAMELY T-SHIRTS, SUITS, PANTS, COATS, BLOUSES, SWEATERS, NIGHTWEAR, HATS, CAPS, UNDERWEAR, NECKTIES, SPORTING SHOES, SLIPPERS, MUFFLERS, SOCKS, SKIRTS, STOCKINGS, GLOVES, TIGHTS (U.S. CLS. 22 AND 39).

FIRST USE 9-1-1999; IN COMMERCE 9-1-1999.

CLASS 26—FANCY GOODS

FOR (BASED ON USE IN COMMERCE) TRAVEL SIZE SEWING KITS, PORTABLE MINI SEWING KITS COMPRISED IN PRIMARY PART OF SEWING NEEDLES; SEWING THIMBLES, AND THREAD, (BASED ON 44(E)) RIBBONS, CLOTHING BUTTONS, NON-PRECIOUS METAL CLOTHING BUCKLES AND BUCKLES FOR CLOTHING, NON-PRECIOUS METAL AND NON-IMITATION JEWELRY BROOCHES FOR CLOTHING, HAIRPINS, HAIR BANDS, NON-ELECTRIC HAIR CURLERS, ARTIFICIAL FLOWERS, SHOE LACES (U.S. CLS. 37, 39, 40, 42 AND 50).

FIRST USE 9-1-1999; IN COMMERCE 9-1-1999.

CLASS 29—MEATS AND PROCESSED FOODS

FOR PROCESSED MARINE PRODUCTS, NAMELY SEAFOOD, INSTANT AND PRE-COOKED STEW AND SOUP, PRESERVED MEAT, PICKLES, PREPARATIONS FOR MAKING SOUP, FREEZE-DRIED FOOD AND RETORT-PACKED FOOD, NAMELY, FREEZE-DRIED FRUITS, FREEZE-DRIED VEGETABLES, FREEZE-DRIED SEEDS, RETORT-PACKED SOUP, RETORT-PACKED SAUCE; OLIVE OIL FOR FOOD, PROCESSED PREPARED NUTS, JAM, PRESERVED VEGETABLES AND PRESERVED FRUIT IN OIL AND ALCOHOL, MILK PRODUCTS, NAMELY, CHEESE, MILK, MILK POWDER, YOGURT AND CREAM; PROCESSED PRESERVED BEANS, DRIED LAYER FOR FLAVORING STEAMED RICE WITH GREEN TEA (U.S. CL. 46).

CLASS 30—STAPLE FOODS

FOR PRE-COOKED AND INSTANT CURRY, SEASONINGS, NAMELY SEASONING GRANULES FOR STEAMED RICE, COFFEE, COCOA, TEA, SEASONINGS, SPICES, SAUCES, SPAGHETTI, MACARONI, NOODLES, INSTANT CHINESE NOODLES, PROCESS CEREALS, NAMELY CEREAL PREPARATIONS, CAKES, CONFECTIONERY, NAMELY, CONFECTIONERY CHIPS FOR BAKING, CANDY; BREAD, SWEETMEATS, CHOCOLATE, CHEWING GUM, COOKIES, ICE CREAM, INSTANT CAKES, RICE, SANDWICHES, PIZZAS, PREPARED BOX LUNCHES, NAMELY PREPARED ENTREES CONSISTING PRIMARILY OF PASTA AND RICE, PIES, CHIPS, NAMELY CORN CHIPS AND CHOCOLATE CHIPS (U.S. CL. 46).

CLASS 32—LIGHT BEVERAGES

FOR (BASED ON 44(E)) NON-ALCOHOLIC BEVERAGES, NAMELY CARBONATED BEVERAGES, MINERAL WATERS, ORANGE JUICES, FRUIT JUICES, LEMONADES, SODA WATER, VEGETABLE JUICES, WHEY BEVERAGES, BEER, SYRUPS FOR BEVERAGES (U.S. CLS. 45, 46 AND 48).

CLASS 35—ADVERTISING AND BUSINESS

FOR (BASED ON USE IN COMMERCE) ON-LINE RETAIL SHOPS, RETAIL SHOPS, MAIL ORDER SERVICES, AND ON-LINE RETAIL STORE SERVICES FEATURING A WIDE VARIETY OF CONSUMER GOODS OF OTHERS, FEATURING CLOTHING, HOUSEHOLD GOODS, OFFICE SUPPLIES, INDUSTRIAL SUPPLIES, BUSINESS EQUIPMENT, FOODS AND DRINKS, COTTON PIECE GOODS, CLOTHING, CLOTHING ACCESSORIES, STATIONERY, FURNITURE, INTERIOR FURNISHINGS, DECORATIONS, HARDWARE, HOUSEHOLD DAILY NECESSITIES, PHARMACEUTICAL PREPARATIONS, CULTURAL AND EDUCATIONAL PRODUCTS, CLOCKS AND WATCHES, GLASSES, ELECTRIC AND ELECTRONIC APPLIANCES, JEWELRY, PRECIOUS METALS, PHOTOGRAPHIC APPARATUS, COSMETICS, ENTERTAINMENT AND RECREATIONAL PRODUCTS, MECHANICAL APPARATUS, BICYCLES AND THEIR PARTS AND COMPONENTS, TRICYCLES AND THEIR PARTS AND COMPONENTS, BATH PRODUCTS, TOWELS, BEDROOM PRODUCTS; ADVERTISING AGENCIES, NAMELY PROMOTING GOODS AND SERVICES VIA A GLOBAL COMPUTER NETWORK; MARKETING RESEARCH; IMPORT-EXPORT AGENCIES; PRODUCT PLANNING, NAMELY BUSINESS CONSULTATION AND MANAGEMENT REGARDING MARKETING ACTIVITIES AND LAUNCHING OF NEW PRODUCTS; MERCHANDISE PACKAGING (U.S. CLS. 100, 101 AND 102).

FIRST USE 9-1-1999; IN COMMERCE 9-1-1999.

3,314,970. RECEPTORS LLC, CHASKA, MN. SN 78-455,776.
FILED P.R. 7-23-2004; AM. S.R. 5-19-2006.

RECEPTORS LLC

THE MARK CONSISTS OF STANDARD CHARACTERS WITHOUT CLAIM TO ANY PARTICULAR FONT, STYLE, SIZE, OR COLOR.

NO CLAIM IS MADE TO THE EXCLUSIVE RIGHT TO USE "LLC", APART FROM THE MARK AS SHOWN.

CLASS 1—CHEMICALS

FOR CHEMICAL PREPARATIONS, NAMELY, CHEMICAL MICRO ARRAYS FOR SCIENTIFIC, DIAGNOSTIC AND RESEARCH USE; CHEMICAL REAGENTS, AND KITS PRIMARILY COMPRISED OF CHEMICAL PREPARATIONS, NAMELY, CHEMICAL MICROARRAYS, MODIFIED SURFACES AND REAGENTS FOR USE IN CLINICAL DIAGNOSTICS, CHEMICAL AND MEDICAL ANALYSIS, AND SCIENTIFIC AND LABORATORY RESEARCH, NAMELY, THE DETECTION OF PATHOGENS AND/OR TOXINS IN THE ENVIRONMENT (U.S. CLS. 1, 5, 6, 10, 26 AND 46).

FIRST USE 1-0-2005; IN COMMERCE 1-0-2005.

CLASS 5—PHARMACEUTICALS

FOR CHEMICAL REAGENTS FOR MEDICAL USE (U.S. CLS. 6, 18, 44, 46, 51 AND 52).

FIRST USE 1-0-2005; IN COMMERCE 1-0-2005.

CLASS 9—ELECTRICAL AND SCIENTIFIC APPARATUS

FOR LABORATORY EQUIPMENT, NAMELY, APPARATUS FOR SCREENING SAMPLES, DETECTING AND/OR IDENTIFYING ANALYTES IN SAMPLES; LABORATORY EQUIPMENT FOR MAKING AND SCREENING MOLECULAR ARRAYS; LABORATORY EQUIPMENT FOR DETECTING PATHOGENS AND/OR TOXINS IN THE ENVIRONMENT; GLASS OR PLASTIC SLIDES, GLASS OR PLASTIC PLATES, AND GLASS OR PLASTIC TUBES FOR USE WITH LABORATORY EQUIPMENT, NAMELY, APPARATUS FOR SCREENING SAMPLES, DETECTING AND/OR IDENTIFYING ANALYTES IN SAMPLES, LABORATORY EQUIPMENT FOR MAKING AND SCREENING MOLECULAR ARRAYS, AND LABORATORY EQUIPMENT FOR DETECTING PATHOGENS AND/OR TOXINS IN THE ENVIRONMENT; MODIFIED SURFACES FOR SCIENTIFIC AND RESEARCH USE, NAMELY, GLASS OR PLASTIC PLATES, GLASS OR PLASTIC SLIDES AND GLASS OR PLASTIC TUBES, SUCH SURFACES MODIFIED WITH AMINO ACIDS OR THEIR DERIVATIVES (U.S. CLS. 21, 23, 26, 36 AND 38).

FIRST USE 1-0-2005; IN COMMERCE 1-0-2005.

CLASS 10—MEDICAL APPARATUS

FOR MODIFIED SURFACES FOR DIAGNOSTIC USE, NAMELY, GLASS OR PLASTIC PLATES, GLASS OR PLASTIC SLIDES AND GLASS OR PLASTIC TUBES, SUCH SURFACES MODIFIED WITH AMINO ACIDS OR THEIR DERIVATIVES (U.S. CLS. 26, 39 AND 44).

FIRST USE 1-0-2005; IN COMMERCE 1-0-2005.

CLASS 42—SCIENTIFIC AND COMPUTER SERVICES

FOR SCIENTIFIC RESEARCH AND DEVELOPMENT SERVICES FOR OTHERS IN THE FIELDS OF DIAGNOSTICS, ANALYSIS, MICROARRAYS, AND MODIFIED SURFACES; SCIENTIFIC RESEARCH SERVICES FOR OTHERS NAMELY, DETECTING PATHOGENS AND/OR TOXINS IN THE ENVIRONMENT (U.S. CLS. 100 AND 101).

FIRST USE 1-0-2005; IN COMMERCE 1-0-2005.

3,314,971. UMG RECORDINGS, INC., SANTA MONICA, CA.
SN 78-621,357. FILED P.R. 5-2-2005; AM. S.R. 7-17-2007.

ICCLASSICS

THE MARK CONSISTS OF STANDARD CHARACTERS WITHOUT CLAIM TO ANY PARTICULAR FONT, STYLE, SIZE, OR COLOR.

CLASS 35—ADVERTISING AND BUSINESS

FOR COMPUTERIZED ON-LINE ORDERING FEATURING GENERAL MERCHANDISE AND GENERAL CONSUMER GOODS IN THE FIELD OF MUSIC; COMPUTERIZED ON-LINE RETAIL STORE SERVICES IN THE FIELD OF MUSIC; ON-LINE RETAIL STORE SERVICES FEATURING DOWNLOADABLE MUSIC AND VIDEOS; ON-LINE RETAIL STORE SERVICES FEATURING PRE-RECORDED AUDIO TAPES, DISCS, CASSETTES, VIDEO TAPES, DIGITAL AUDIO AND AUDIO VIDEO TAPES AND DISCS, CDS DVD'S, LASER DISCS AND PHONOGRAPH RECORDS FEATURING MUSIC AND ENTERTAINMENT, AND THEATRICAL MUSICAL SOUND AND VIDEO RECORDINGS. (U.S. CLS. 100, 101 AND 102).

FIRST USE 1-5-2001; IN COMMERCE 1-5-2001.

CLASS 38—COMMUNICATION

FOR PROVIDING ON-LINE ELECTRONIC BULLETIN BOARDS FOR TRANSMISSION OF MESSAGES AMONG COMPUTER USERS CONCERNING THE FIELD OF MUSIC (U.S. CLS. 100, 101 AND 104).

FIRST USE 1-5-2001; IN COMMERCE 1-5-2001.

CLASS 41—EDUCATION AND ENTERTAINMENT

FOR ENTERTAINMENT SERVICES, NAMELY PROVIDING PRERECORDED MUSIC, INFORMATION IN THE FIELD OF MUSIC, AND COMMENTARY AND ARTICLES ABOUT MUSIC, MUSICAL THEATRE, HISTORY AND TERMINOLOGY OF MUSIC, ALL ON-LINE VIA A GLOBAL COMPUTER NETWORK; PROVIDING NEWSLETTERS VIA EMAIL ABOUT MUSIC, MUSICAL THEATRE, AND THE HISTORY AND TERMINOLOGY OF MUSIC; AND PROVIDING INFORMATION ON MUSICAL EVENTS AND CONCERTS, ALL ON-LINE VIA A GLOBAL COMPUTER NETWORK (U.S. CLS. 100, 101 AND 107).

FIRST USE 1-5-2001; IN COMMERCE 1-5-2001.

3,314,972. CELULA, INC., SAN DIEGO, CA. SN 78-628,141.
FILED P.R. 5-11-2005; AM. S.R. 9-7-2007.

CELULA

THE MARK CONSISTS OF STANDARD CHARACTERS WITHOUT CLAIM TO ANY PARTICULAR FONT, STYLE, SIZE, OR COLOR.

THE TERM CELULA IS THE SPANISH WORD FOR "CELL."

CLASS 9—ELECTRICAL AND SCIENTIFIC APPARATUS

FOR LASER-BASED BIOPHOTONICS DEVICES AND MICROFLUIDICS-BASED DEVICES, BOTH COMPRISING LASER OPTICS, DETECTION OPTICS, AND MICROFLUIDIC CIRCUITS, AND LABORATORY CONSUMABLES, NAMELY, CARTRIDGES INTEGRATING MICROFLUIDIC CIRCUITS, SAMPLE RESERVOIRS AND INSTRUMENT INTERFACES, FOR SCIENTIFIC USE, NAMELY, FOR USE IN CELL OR PARTICLE SEPARATION, CELL CULTURING, AND CELL OR MOLECULAR ANALYSIS IN THE FIELDS OF COMMERCIAL AND ACADEMIC SCIENTIFIC RESEARCH, CLINICAL DIAGNOSTICS AND THERAPEUTICS (U.S. CLS. 21, 23, 26, 36 AND 38).

FIRST USE 9-7-2007; IN COMMERCE 9-7-2007.

CLASS 10—MEDICAL APPARATUS

FOR LASER-BASED BIOPHOTONICS DEVICES AND MICROFLUIDICS-BASED DEVICES, BOTH COMPRISING LASER OPTICS, DETECTION OPTICS, AND MICROFLUIDIC CIRCUITS, AND LABORATORY CONSUMABLES, NAMELY, CARTRIDGES INTEGRATING MICROFLUIDIC CIRCUITS, SAMPLE RESERVOIRS AND INSTRUMENT INTERFACES, FOR MEDICAL USE, NAMELY, FOR USE IN CELL OR PARTICLE SEPARATION, CELL CULTURING, AND CELL OR MOLECULAR ANALYSIS IN THE FIELDS OF COMMERCIAL AND ACADEMIC MEDICAL RESEARCH, CLINICAL DIAGNOSTICS AND THERAPEUTICS (U.S. CLS. 26, 39 AND 44).

FIRST USE 9-7-2007; IN COMMERCE 9-7-2007.

3,314,993. GLU MOBILE, INC., SAN MATEO, CA. SN 78-831,734. FILED P.R. 3-7-2006; AM. S.R. 8-1-2007.

SUPER KO BOXING

THE MARK CONSISTS OF STANDARD CHARACTERS WITHOUT CLAIM TO ANY PARTICULAR FONT, STYLE, SIZE, OR COLOR.

CLASS 9—ELECTRICAL AND SCIENTIFIC APPARATUS

FOR COMPUTER GAME CARTRIDGES; COMPUTER GAME DISCS; INTERACTIVE MULTIMEDIA COMPUTER GAME PROGRAMS; DOWNLOADABLE COMPUTER GAME SOFTWARE VIA A GLOBAL COMPUTER NETWORK AND WIRELESS DEVICES; COMPUTER APPLICATION SOFTWARE FOR MOBILE PHONES; COMPUTER GAME SOFTWARE AND ENTERTAINMENT SOFTWARE FOR USE ON MOBILE AND CELLULAR PHONES, HANDHELD COMPUTERS, COMPUTERS, VIDEO GAME CONSOLES, BOTH HANDHELD AND FREE STANDING, AND OTHER WIRELESS DEVICES (U.S. CLS. 21, 23, 26, 36 AND 38).

FIRST USE 6-28-2006; IN COMMERCE 6-28-2006.

CLASS 41—EDUCATION AND ENTERTAINMENT

FOR PROVIDING A COMPUTER GAME THAT MAY BE ACCESSED NETWORK-WIDE BY NETWORK USERS; PROVIDING AN ONLINE COMPUTER GAME ACCESSED AND PLAYED VIA MOBILE AND CELLULAR PHONES AND OTHER WIRELESS DEVICE (U.S. CLS. 100, 101 AND 107).

FIRST USE 6-28-2006; IN COMMERCE 6-28-2006.

3,315,003. DMG WORLD MEDIA (USA) INC., TORONTO, CANADA. SN 78-877,035. FILED P.R. 5-4-2006; AM. S.R. 8-20-2007.

CIO EXECUTIVE SUMMIT

THE MARK CONSISTS OF STANDARD CHARACTERS WITHOUT CLAIM TO ANY PARTICULAR FONT, STYLE, SIZE, OR COLOR.

NO CLAIM IS MADE TO THE EXCLUSIVE RIGHT TO USE "EXECUTIVE SUMMIT", APART FROM THE MARK AS SHOWN.

CLASS 35—ADVERTISING AND BUSINESS

FOR ARRANGING AND CONDUCTING BUSINESS CONFERENCES IN THE FIELD OF INFORMATION TECHNOLOGY (U.S. CLS. 100, 101 AND 102).

FIRST USE 5-0-2003; IN COMMERCE 5-0-2003.

CLASS 41—EDUCATION AND ENTERTAINMENT

FOR ARRANGING AND CONDUCTING EXECUTIVE EDUCATION EVENTS, NAMELY, CONFERENCES IN THE FIELD OF INFORMATION TECHNOLOGY (U.S. CLS. 100, 101 AND 107).

FIRST USE 5-0-2003; IN COMMERCE 5-0-2003.

3,315,024. FAITH COMMUNICATIONS, INC., BEVERLY HILLS, CA. SN 78-979,049. FILED P.R. 9-26-2005; AM. S.R. 7-17-2007.

THE ENGLISH TRANSLATION OF THE WORD VOCE IN THE MARK IS VOICE.

VOCE

CLASS 9—ELECTRICAL AND SCIENTIFIC APPARATUS

FOR MOBILE PHONES (U.S. CLS. 21, 23, 26, 36 AND 38).
FIRST USE 9-23-2005; IN COMMERCE 9-26-2005.

CLASS 38—COMMUNICATION

THE MARK CONSISTS OF STANDARD CHARACTERS WITHOUT CLAIM TO ANY PARTICULAR FONT, STYLE, SIZE, OR COLOR.

FOR COMMUNICATION SERVICES BY MEANS OF MOBILE PHONES (U.S. CLS. 100, 101 AND 104).
FIRST USE 9-23-2005; IN COMMERCE 9-26-2005.

* * * * *

SECTION 2.— INTERNATIONAL CLASSIFICATION

The short titles associated below with the international class numbers are terms designed merely for quick identification and are not an official part of the international classification. The full names of international classes are given in section 6.1 of the trademark rules of practice.

The designation "U.S. Cl." appearing in this section refers to the U.S. class in effect prior to Sep. 1, 1973 rather than the international class which applies to applications filed on or after that date. For adoption of international classification see notice in the OFFICIAL GAZETTE of Jun. 26, 1973 (911 O.G. TM 210).

Application in one class

CLASS 2—PAINTS

3,314,951. FIEBING COMPANY, INC., MILWAUKEE, WI. SN 77-132,185. FILED P.R. 3-15-2007; AM. S.R. 9-7-2007.

LeatherColors

THE MARK CONSISTS OF STANDARD CHARACTERS WITHOUT CLAIM TO ANY PARTICULAR FONT, STYLE, SIZE, OR COLOR.

FOR DYES FOR USE IN THE MANUFACTURE OF LEATHER (U.S. CLS. 6, 11 AND 16).

FIRST USE 5-29-2007; IN COMMERCE 5-29-2007.

CLASS 3—(Continued).

3,314,989. BUCKEYE INTERNATIONAL, INC., MARYLAND HEIGHTS, MO. SN 78-814,144. FILED P.R. 2-14-2006; AM. S.R. 7-19-2007.

VERDE

THE MARK CONSISTS OF STANDARD CHARACTERS WITHOUT CLAIM TO ANY PARTICULAR FONT, STYLE, SIZE, OR COLOR.

THE FOREIGN WORDING IN THE MARK TRANSLATES INTO ENGLISH AS GREEN.

FOR FLOOR FINISHING PREPARATION (U.S. CLS. 1, 4, 6, 50, 51 AND 52).

FIRST USE 6-9-2006; IN COMMERCE 6-9-2006.

CLASS 3—COSMETICS AND CLEANING PREPARATIONS

3,314,979. E.T. BROWNE DRUG CO., INC., ENGLEWOOD CLIFFS, NJ. SN 78-750,175. FILED P.R. 11-9-2005; AM. S.R. 9-7-2007.

CRACK BUTTER

THE MARK CONSISTS OF STANDARD CHARACTERS WITHOUT CLAIM TO ANY PARTICULAR FONT, STYLE, SIZE, OR COLOR.

FOR NON-MEDICATED SKIN CARE PREPARATIONS (U.S. CLS. 1, 4, 6, 50, 51 AND 52).

FIRST USE 2-28-2006; IN COMMERCE 2-28-2006.

CLASS 5—PHARMACEUTICALS

3,314,975. THAROS LABORATORIES, INC., SHARON, MA. SN 78-670,896. FILED P.R. 7-14-2005; AM. S.R. 1-26-2007.

Laminar

THE MARK CONSISTS OF STANDARD CHARACTERS WITHOUT CLAIM TO ANY PARTICULAR FONT, STYLE, SIZE, OR COLOR.

FOR INGREDIENT DERIVED FROM KELP SOLD AS AN INTEGRAL COMPONENT OF DIETARY SUPPLEMENTS (U.S. CLS. 6, 18, 44, 46, 51 AND 52).

FIRST USE 7-15-2005; IN COMMERCE 7-15-2005.

CLASS 5—(Continued).

3,314,997. ISS RESEARCH, LLC, CHARLOTTE, NC. SN 78-836,274. FILED P.R. 3-14-2006; AM. S.R. 9-4-2007.

SATUR8

THE MARK CONSISTS OF STANDARD CHARACTERS WITHOUT CLAIM TO ANY PARTICULAR FONT, STYLE, SIZE, OR COLOR.
FOR NUTRITIONAL SUPPLEMENT FOR WEIGHT TRAINING (U.S. CLS. 6, 18, 44, 46, 51 AND 52).
FIRST USE 10-27-2003; IN COMMERCE 10-27-2003.

3,314,999. MDR FITNESS CORP, SUNRISE, FL. SN 78-861,370. FILED P.R. 4-13-2006; AM. S.R. 7-9-2007.

KidsTabs

THE MARK CONSISTS OF STANDARD CHARACTERS WITHOUT CLAIM TO ANY PARTICULAR FONT, STYLE, SIZE, OR COLOR.
FOR DIETARY SUPPLEMENTS; NUTRITIONAL SUPPLEMENTS (U.S. CLS. 6, 18, 44, 46, 51 AND 52).
FIRST USE 3-1-1990; IN COMMERCE 3-1-1990.

3,315,005. ALACER CORPORATION, FOOTHILL RANCH, CA. SN 78-884,867. FILED P.R. 5-16-2006; AM. S.R. 9-4-2007.

HEART HEALTH POWERFUL ANTIOXIDANT FORMULA

THE MARK CONSISTS OF STANDARD CHARACTERS WITHOUT CLAIM TO ANY PARTICULAR FONT, STYLE, SIZE, OR COLOR.
OWNER OF U.S. REG. NO. 2,616,360.
FOR DIETARY SUPPLEMENTS IN THE FORM OF AN EFFERVESCENT DRINK MIX (U.S. CLS. 6, 18, 44, 46, 51 AND 52).
FIRST USE 4-30-2005; IN COMMERCE 4-30-2005.

CLASS 5—(Continued).

3,315,006. ALACER CORPORATION, FOOTHILL RANCH, CA. SN 78-884,918. FILED P.R. 5-16-2006; AM. S.R. 9-4-2007.

JOINT HEALTH FORMULA

THE MARK CONSISTS OF STANDARD CHARACTERS WITHOUT CLAIM TO ANY PARTICULAR FONT, STYLE, SIZE, OR COLOR.
OWNER OF U.S. REG. NO. 2,616,360.
FOR DIETARY SUPPLEMENTS IN THE FORM OF AN EFFERVESCENT DRINK MIX (U.S. CLS. 6, 18, 44, 46, 51 AND 52).
FIRST USE 7-30-2003; IN COMMERCE 7-30-2003.

3,315,007. ALACER CORPORATION, FOOTHILL RANCH, CA. SN 78-884,949. FILED P.R. 5-16-2006; AM. S.R. 9-4-2007.

BONE HEALTH FORMULA

THE MARK CONSISTS OF STANDARD CHARACTERS WITHOUT CLAIM TO ANY PARTICULAR FONT, STYLE, SIZE, OR COLOR.
OWNER OF U.S. REG. NO. 2,616,360.
FOR DIETARY SUPPLEMENTS IN THE FORM OF AN EFFERVESCENT DRINK MIX (U.S. CLS. 6, 18, 44, 46, 51 AND 52).
FIRST USE 3-30-2004; IN COMMERCE 3-30-2004.

CLASS 6—METAL GOODS

3,314,916. HAMPTON PRODUCTS INTERNATIONAL CORPORATION, FOOTHILL RANCH, CA. SN 76-647,624. FILED P.R. 9-28-2005; AM. S.R. 5-21-2007.

TUSCAN BRONZE

THE MARK CONSISTS OF STANDARD CHARACTERS WITHOUT CLAIM TO ANY PARTICULAR FONT, STYLE, SIZE, OR COLOR.
NO CLAIM IS MADE TO THE EXCLUSIVE RIGHT TO USE "BRONZE", APART FROM THE MARK AS SHOWN.
FOR METAL LOCKS, NAMELY, KEYED DOOR LOCKS, KEYED KNOB AND LEVER DOOR LOCKS, NON-KEYED DOOR LOCKS, NON-KEYED KNOB AND LEVER DOOR LOCKS; METAL LOCK ACCESSORIES, NAMELY, HANDLESETS, BOLTS, CHAIN LATCHES, HINGES, DOOR KNOCKERS, HOUSE NUMBERS, GARMENT HOOKS, DOOR STOPS, CHAIN AND SWING DOOR GUARDS, BARREL BOLTS, DOOR VIEWERS; METAL LOCKS AND HARDWARE FOR DOORS, NAMELY, SINGLE AND DOUBLE CYLINDER DEADBOLTS, DEADBOLTS, DOOR LATCHES, DOOR HANDLES FOR LATCHES, LOCKS, DEADBOLTS, AND DOOR SETS, CHAIN AND SWING DOOR GUARDS, KICK PLATES, STRIKE AND FACE PLATES, CABINET KNOBS AND CABINET PULLS (U.S. CLS. 2, 12, 13, 14, 23, 25 AND 50).
FIRST USE 6-0-2006; IN COMMERCE 6-0-2006.

CLASS 7—MACHINERY

3,314,998. DAISHOWA SEIKI KABUSHIKI KAISHA, DBA BIG DAISHOWA SEIKI CO LTD, OSAKA, JAPAN. SN 78-845,483. FILED P.R. 3-24-2006; AM. S.R. 8-31-2007.

AIR POWER SPINDLE

THE MARK CONSISTS OF STANDARD CHARACTERS WITHOUT CLAIM TO ANY PARTICULAR FONT, STYLE, SIZE, OR COLOR.

NO CLAIM IS MADE TO THE EXCLUSIVE RIGHT TO USE "SPINDLE", APART FROM THE MARK AS SHOWN.

FOR MACHINE TOOL HOLDERS (U.S. CLS. 13, 19, 21, 23, 31, 34 AND 35).

FIRST USE 9-6-2006; IN COMMERCE 9-6-2006.

3,315,017. KPC-MASTER'S CRAFT INTERNATIONAL, INC., MASSILLON, OH. SN 78-965,977. FILED P.R. 9-1-2006; AM. S.R. 8-2-2007.

SPACESAVER

THE MARK CONSISTS OF STANDARD CHARACTERS WITHOUT CLAIM TO ANY PARTICULAR FONT, STYLE, SIZE, OR COLOR.

FOR COMPONENTS FOR PACKAGING MACHINES, NAMELY, CONVEYORS (U.S. CLS. 13, 19, 21, 23, 31, 34 AND 35).

FIRST USE 5-31-2005; IN COMMERCE 5-31-2005.

3,315,018. E-Z BURR TOOL COMPANY, PLYMOUTH, MI. SN 78-967,474. FILED P.R. 9-5-2006; AM. S.R. 7-30-2007.

BURRFREE

THE MARK CONSISTS OF STANDARD CHARACTERS WITHOUT CLAIM TO ANY PARTICULAR FONT, STYLE, SIZE, OR COLOR.

FOR MACHINE TOOLS, NAMELY, TOOLS FOR DRILLING, TOOLS FOR BORING, TOOLS FOR CHAMFERING, AND TOOLS FOR FINISHING EDGES OF HOLES, OPENINGS, AND OTHER FEATURES OF WORKPIECES, AND PARTS THEREFOR (U.S. CLS. 13, 19, 21, 23, 31, 34 AND 35).

FIRST USE 2-0-2006; IN COMMERCE 2-0-2006.

CLASS 9—ELECTRICAL AND SCIENTIFIC APPARATUS

3,314,938. IOWA WASTE REDUCTION CENTER, A DEPARTMENT OF THE UNIVERSITY OF NORTHERN IOWA, CEDAR FALLS, IA. SN 77-058,959. FILED P.R. 12-7-2006; AM. S.R. 8-15-2007.

VIRTUALPAINT

THE MARK CONSISTS OF STANDARD CHARACTERS WITHOUT CLAIM TO ANY PARTICULAR FONT, STYLE, SIZE, OR COLOR.

FOR COMPUTERIZED TRAINING SYSTEMS FOR TEACHING SPRAY PAINTING TECHNIQUES, NAMELY COMPUTER HARDWARE AND SOFTWARE FOR OPERATING SUCH SYSTEMS, ELECTRONIC CONTROLLERS SIMULATING SPRAY PAINTING GUNS, AND VIDEO SCREEN DISPLAYS FOR DISPLAYING A VIRTUAL SURFACE TO BE PAINTED BY SUCH PAINTING GUNS (U.S. CLS. 21, 23, 26, 36 AND 38).

FIRST USE 6-1-2006; IN COMMERCE 6-30-2006.

3,314,949. CANCELMO, BYRON, WATERFORD, MI. SN 77-112,222. FILED P.R. 2-21-2007; AM. S.R. 8-1-2007.

vocal acoustic monitor

THE MARK CONSISTS OF STANDARD CHARACTERS WITHOUT CLAIM TO ANY PARTICULAR FONT, STYLE, SIZE, OR COLOR.

FOR ACOUSTIC AMPLIFIER FOR THE HUMAN VOICE FOR MONITORING THE USER'S VOICE (U.S. CLS. 21, 23, 26, 36 AND 38).

FIRST USE 7-1-2007; IN COMMERCE 7-27-2007.

3,314,950. MELENDEZ, ROBERT F., RIO RANCHO, NM. SN 77-119,224. FILED 3-1-2007.

Ophthalmology Buzzwords

THE MARK CONSISTS OF STANDARD CHARACTERS WITHOUT CLAIM TO ANY PARTICULAR FONT, STYLE, SIZE, OR COLOR.

FOR AUDIO BOOKS RECORDED ON CDS IN THE FIELD OF OPHTHALMOLOGY (U.S. CLS. 21, 23, 26, 36 AND 38).

FIRST USE 3-1-2007; IN COMMERCE 4-1-2007.

CLASS 9—(Continued).

3,314,973. A.C.E. INTERNATIONAL COMPANY, INC., TAUNTON, MA. SN 78-637,728. FILED 5-26-2005.

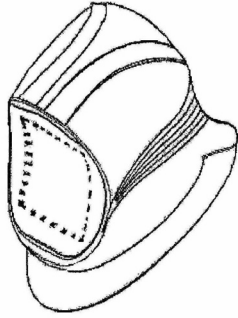

THE MARK CONSISTS OF A UNIQUE THREE-DIMENSIONAL CONFIGURATION OF A WELDING HELMET. FOR SAFETY EQUIPMENT, NAMELY, PROTECTIVE HELMETS (U.S. CLS. 21, 23, 26, 36 AND 38). FIRST USE 8-30-2004; IN COMMERCE 10-2-2004.

3,314,981. BIERMANN PRODUCTIONS LLC, WICHITA, KS. SN 78-772,207. FILED P.R. 12-13-2005; AM. S.R. 9-7-2007.

LIVE ENTERTAINMENT HD

THE MARK CONSISTS OF STANDARD CHARACTERS WITHOUT CLAIM TO ANY PARTICULAR FONT, STYLE, SIZE, OR COLOR.
NO CLAIM IS MADE TO THE EXCLUSIVE RIGHT TO USE "ENTERTAINMENT HD", APART FROM THE MARK AS SHOWN.
FOR PRERECORDED HIGH DEFINITION DIGITAL VIDEO DISKS, VIDEOTAPES, AND COMPACT DISKS FEATURING AUDIO AND VIDEO ENTERTAINMENT CONTENT IN THE NATURE OF CHILDREN'S SHOWS, MUSIC, AND TELEVISION SHOWS FOR TELEVISION, RADIO, INTERNET, AND WIRELESS MOBILE COMMUNICATIONS (U.S. CLS. 21, 23, 26, 36 AND 38). FIRST USE 3-28-2005; IN COMMERCE 1-5-2006.

3,314,982. TRANSIT REALTY ASSOCIATES, LLC, BOSTON, MA. SN 78-772,222. FILED P.R. 12-13-2005; AM. S.R. 8-9-2007.

LandTracker

CLASS 9—(Continued).

THE MARK CONSISTS OF STANDARD CHARACTERS WITHOUT CLAIM TO ANY PARTICULAR FONT, STYLE, SIZE, OR COLOR.
FOR COMPUTER SOFTWARE FOR CREATING SEARCHABLE DATABASES OF INFORMATION AND DATA; COMPUTER SOFTWARE FOR ORGANIZING AND VIEWING DIGITAL IMAGES AND PHOTOGRAPHS; COMPUTER SOFTWARE FOR MAPPING REAL ESTATE OWNERSHIP AND STORING RELATED DATA (U.S. CLS. 21, 23, 26, 36 AND 38). FIRST USE 6-26-2007; IN COMMERCE 6-26-2007.

3,314,983. CARR SCOTT SOFTWARE INCORPORATED, DUXBURY, MA. SN 78-781,473. FILED P.R. 12-28-2005; AM. S.R. 8-1-2007.

AutoDDL

THE MARK CONSISTS OF STANDARD CHARACTERS WITHOUT CLAIM TO ANY PARTICULAR FONT, STYLE, SIZE, OR COLOR.
FOR COMPUTER SOFTWARE FOR DATA REPLICATION, NAMELY, FOR AUTOMATICALLY DUPLICATING FORMATTING DATA WITHIN A COMPUTER DATA BASE AND BETWEEN COMPUTER DATABASES (U.S. CLS. 21, 23, 26, 36 AND 38). FIRST USE 12-28-2005; IN COMMERCE 12-28-2005.

3,314,987. GATOR CASES INC., TAMPA, FL. SN 78-798,630. FILED P.R. 1-24-2006; AM. S.R. 9-4-2007.

Pedal Tote

THE MARK CONSISTS OF STANDARD CHARACTERS WITHOUT CLAIM TO ANY PARTICULAR FONT, STYLE, SIZE, OR COLOR.
NO CLAIM IS MADE TO THE EXCLUSIVE RIGHT TO USE "TOTE", APART FROM THE MARK AS SHOWN.
FOR CASES FOR TRANSPORTING AND MOUNTING THE CABLING, POWER SUPPLIES, AND EFFECTS PEDALS USED WITH ELECTRIC STRINGED INSTRUMENTS, NAMELY, GUITARS AND BASS GUITARS (U.S. CLS. 21, 23, 26, 36 AND 38). FIRST USE 10-18-2004; IN COMMERCE 1-19-2006.

CLASS 9—(Continued).

3,314,988. CHANGETOOLS INC, HUNTSVILLE, AL. SN 78-807,325. FILED P.R. 2-4-2006; AM. S.R. 9-6-2007.

Remote Control of the Internet

THE MARK CONSISTS OF STANDARD CHARACTERS WITHOUT CLAIM TO ANY PARTICULAR FONT, STYLE, SIZE, OR COLOR.

FOR COMPUTER PROGRAMS FOR SEARCHING THE CONTENTS OF COMPUTERS AND COMPUTER NETWORKS BY REMOTE CONTROL; COMPUTER SOFTWARE FOR CONTROLLING AND MANAGING ACCESS SERVER APPLICATIONS (U.S. CLS. 21, 23, 26, 36 AND 38).

FIRST USE 2-3-2006; IN COMMERCE 2-3-2006.

3,314,996. CASIO KEISANKI KABUSHIKI KAISHA, DBA CASIO COMPUTER CO., LTD., TOKYO, JAPAN. SN 78-835,810. FILED P.R. 3-13-2006; AM. S.R. 8-14-2007.

PHOTO TRANSPORT

THE MARK CONSISTS OF STANDARD CHARACTERS WITHOUT CLAIM TO ANY PARTICULAR FONT, STYLE, SIZE, OR COLOR.

FOR COMPUTER SOFTWARE FOR A PERSONAL COMPUTER FOR USE IN ACHIEVING DATA EXCHANGE BETWEEN A PERSONAL COMPUTER AND A WRIST WATCH OR A DIGITAL CAMERA (U.S. CLS. 21, 23, 26, 36 AND 38).

FIRST USE 7-0-2006; IN COMMERCE 8-0-2006.

3,315,004. MOIXA ENERGY HOLDINGS LTD., LONDON, UNITED KINGDOM. SN 78-883,785. FILED P.R. 5-15-2006; AM. S.R. 4-24-2007.

USBCCELL

THE MARK CONSISTS OF STANDARD CHARACTERS WITHOUT CLAIM TO ANY PARTICULAR FONT, STYLE, SIZE, OR COLOR.

FOR ELECTRICAL POWER SOURCES, NAMELY, ELECTROCHEMICAL CELLS, BATTERIES, RECHARGEABLE BATTERY PACKS (U.S. CLS. 21, 23, 26, 36 AND 38).

FIRST USE 11-30-2006; IN COMMERCE 11-30-2006.

CLASS 11—ENVIRONMENTAL CONTROL APPARATUS

3,314,992. REMINGTON, INC., VALENCIA, CA. SN 78-829,988. FILED P.R. 3-6-2006; AM. S.R. 8-6-2007.

REMINGTON

THE MARK CONSISTS OF THE WORD "REMINGTON" WITH A STYLIZED "R."

FOR REFRIGERATION DISPENSING UNITS FOR BEVERAGES; REFRIGERATORS; WATER COOLERS; WATER HEATERS FOR DOMESTIC USE; WATER PURIFIERS (U.S. CLS. 13, 21, 23, 31 AND 34).

FIRST USE 5-1-2006; IN COMMERCE 5-1-2006.

CLASS 15—MUSICAL INSTRUMENTS

3,314,928. GABBANELLI ACCORDIONS & IMPORTS, LLC, HOUSTON, TX. SN 77-003,164. FILED P.R. 9-20-2006; AM. S.R. 7-31-2007.

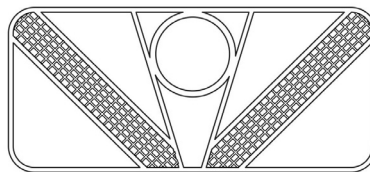

THE MARK CONSISTS OF A RECTANGLE DIVIDED INTO THREE PORTIONS BY A RIGHT AND A LEFT DIAGONAL CROSS MEMBER THAT SUBSTANTIALLY FORM A V-SHAPE IN THE CENTER PORTION OF THE RECTANGLE, THE CENTER PORTION HAVING A CIRCLE AT THE UPPER END THAT INTERSECTS THE TWO DIAGONAL CROSS MEMBERS, THE LEFT PORTION HAVING A MESHED CROSS-MEMBER STARTING IN THE UPPER LEFT CORNER AND CONTINUING TOWARD THE CENTER POINT OF THE BOTTOM BORDER OF THE RECTANGLE AND PARTIALLY INTERSECTS WITH THE LEFT DIAGONAL CROSS MEMBER, AND THE RIGHT PORTION HAVING A MESHED CROSS-MEMBER STARTING IN THE UPPER RIGHT CORNER AND CONTINUING TOWARD THE CENTER POINT OF THE BOTTOM BORDER OF THE RECTANGLE AND PARTIALLY INTERSECTS WITH THE RIGHT DIAGONAL CROSS MEMBER.

FOR ACCORDIONS (U.S. CLS. 2, 21 AND 36).
FIRST USE 8-1-2006; IN COMMERCE 8-1-2006.

CLASS 16—PAPER GOODS AND PRINTED MATTER

CLASS 16—(Continued).

3,314,923. SLAM MARKETING, LLC, CARLE PLACE, NY. SN 76-671,269. FILED P.R. 1-11-2007; AM. S.R. 9-4-2007.

BROOKLYN RESTAURANT WEEK

THE MARK CONSISTS OF STANDARD CHARACTERS WITHOUT CLAIM TO ANY PARTICULAR FONT, STYLE, SIZE, OR COLOR.

NO CLAIM IS MADE TO THE EXCLUSIVE RIGHT TO USE "RESTAURANT WEEK", APART FROM THE MARK AS SHOWN.

FOR A NEWSLETTER HAVING AS THE FOCUS THEREOF A SELECTED RESTAURANT (U.S. CLS. 2, 5, 22, 23, 29, 37, 38 AND 50).

FIRST USE 6-13-2007; IN COMMERCE 6-13-2007.

3,314,945. PIERSON, MARK R., DES MOINES, IA. SN 77-075,819. FILED P.R. 1-4-2007; AM. S.R. 7-25-2007.

UBSAFE2

THE MARK CONSISTS OF STANDARD CHARACTERS WITHOUT CLAIM TO ANY PARTICULAR FONT, STYLE, SIZE, OR COLOR.

FOR STICKERS (U.S. CLS. 2, 5, 22, 23, 29, 37, 38 AND 50).

FIRST USE 6-1-2006; IN COMMERCE 6-1-2006.

3,314,960. LO IACONO, RUBEN, PALMDALE, CA. SN 77-150,704. FILED P.R. 4-6-2007; AM. S.R. 8-6-2007.

Casas Para Ver

THE MARK CONSISTS OF STANDARD CHARACTERS WITHOUT CLAIM TO ANY PARTICULAR FONT, STYLE, SIZE, OR COLOR.

THE ENGLISH TRANSLATION OF THE WORDING "CASAS PARA VER" IS "HOUSES TO SEE."

FOR MAGAZINES FEATURING REAL ESTATE (U.S. CLS. 2, 5, 22, 23, 29, 37, 38 AND 50).

FIRST USE 5-0-2005; IN COMMERCE 5-2-2005.

CLASS 16—(Continued).

3,315,015. POLAR COMMUNICATIONS, L.L.C., ROCKFORD, MI. SN 78-963,554. FILED P.R. 8-30-2006; AM. S.R. 7-30-2007.

ASPIE

THE MARK CONSISTS OF STANDARD CHARACTERS WITHOUT CLAIM TO ANY PARTICULAR FONT, STYLE, SIZE, OR COLOR.

FOR NEWSLETTERS IN THE FIELD OF MEDICAL SYNDROMES (U.S. CLS. 2, 5, 22, 23, 29, 37, 38 AND 50).

FIRST USE 7-26-2006; IN COMMERCE 7-26-2006.

3,315,019. THE KRAUS ORGANIZATION LIMITED, NEW YORK, NY. SN 78-967,855. FILED P.R. 9-6-2006; AM. S.R. 7-30-2007.

HEALTHCARE PERFORMANCE PRESS

THE MARK CONSISTS OF STANDARD CHARACTERS WITHOUT CLAIM TO ANY PARTICULAR FONT, STYLE, SIZE, OR COLOR.

NO CLAIM IS MADE TO THE EXCLUSIVE RIGHT TO USE "PRESS", APART FROM THE MARK AS SHOWN.

FOR PUBLICATIONS, NAMELY, BOOKS AND WORKBOOKS IN THE FIELD OF HEALTHCARE (U.S. CLS. 2, 5, 22, 23, 29, 37, 38 AND 50).

FIRST USE 8-31-2006; IN COMMERCE 6-11-2007.

CLASS 17—RUBBER GOODS

3,314,961. ARANAR GLASS TECH, LLC, WEST PALM BEACH, FL. SN 77-152,081. FILED 4-9-2007.

Broken Glass Stabilizer

THE MARK CONSISTS OF STANDARD CHARACTERS WITHOUT CLAIM TO ANY PARTICULAR FONT, STYLE, SIZE, OR COLOR.

FOR SPRAY ON POLYMERIC MATERIAL FOR STABILIZING WINDOW STRUCTURES (U.S. CLS. 1, 5, 12, 13, 35 AND 50).

FIRST USE 2-24-2005; IN COMMERCE 2-24-2005.

CLASS 18—LEATHER GOODS

CLASS 18—(Continued).

3,314,937. BEAM'S INDUSTRIES, INC., OKLAHOMA CITY, OK. SN 77-056,263. FILED P.R. 12-4-2006; AM. S.R. 7-23-2007.

BUCKLEBAG

THE MARK CONSISTS OF STANDARD CHARACTERS WITHOUT CLAIM TO ANY PARTICULAR FONT, STYLE, SIZE, OR COLOR.

FOR ALL PURPOSE CARRYING BAGS, BOOK BAGS, CARRY-ALL BAGS, CLUTCH BAGS, DIAPER BAGS, HANDBAGS, SCHOOL BOOK BAGS, SHOULDER BAGS AND TRAVEL BAGS (U.S. CLS. 1, 2, 3, 22 AND 41).

FIRST USE 4-1-2006; IN COMMERCE 4-1-2006.

CLASS 24—FABRICS

3,314,991. MR. IDEA, INC., ATTLEBORO, MA. SN 78-828,719. FILED P.R. 3-3-2006; AM. S.R. 9-5-2007.

BEACH DUDS

THE MARK CONSISTS OF STANDARD CHARACTERS WITHOUT CLAIM TO ANY PARTICULAR FONT, STYLE, SIZE, OR COLOR.

OWNER OF U.S. REG. NOS. 3,017,317 AND 3,027,317.

FOR BEACH TOWELS (U.S. CLS. 42 AND 50).

FIRST USE 6-1-2004; IN COMMERCE 6-1-2004.

CLASS 25—CLOTHING

3,314,936. SMOOCH, INC., ENCINO, CA. SN 77-051,149. FILED P.R. 11-27-2006; AM. S.R. 8-2-2007.

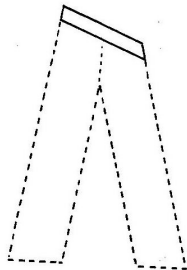
**CLASS 25—(Continued).**

THE MARK CONSISTS OF THE CONFIGURATION OF THE WAISTLINE OF JEANS, PANTS, SHORTS AND SKIRTS WHERE THE WAISTLINE IS AT AN ANGLE. THE MATTER SHOWN IN BROKEN LINES SERVES TO SHOW POSITIONING OF THE MARK AND IS NOT CLAIMED AS PART OF THE MARK.

FOR CLOTHING, NAMELY, JEANS, PANTS, SHORTS, AND SKIRTS FOR WOMEN AND MEN, CHILDREN AND ADULTS (U.S. CLS. 22 AND 39).

FIRST USE 8-28-2006; IN COMMERCE 8-28-2006.

3,314,957. FEMALE, STUDIO CITY, CA. SN 77-146,669. FILED 4-2-2007.

FEMALE

FOR CLOTHING, NAMELY, WOMEN'S TOPS, DRESSES AND SKIRTS (U.S. CLS. 22 AND 39).

FIRST USE 2-15-2006; IN COMMERCE 2-15-2007.

3,314,980. 496268 NEW YORK, INC., NORTH BOSTON, NY. SN 78-756,924. FILED P.R. 11-18-2005; AM. S.R. 8-16-2007.



THE COLOR(S) BLUE AND WHITE IS/ARE CLAIMED AS A FEATURE OF THE MARK.

THE COLORS BLUE AND WHITE APPEAR IN RANDOM WIDTH HORIZONTAL STRIPING ACROSS THE GLOVE.

THE MARK CONSISTS OF THE COLORS BLUE AND WHITE IN A HORIZONTAL STRIPING DESIGN THROUGHOUT THE ENTIRE GOOD (GLOVE) EXCEPT FOR THE BOTTOM EDGING. THE LINED OUTLINE OF THE GOOD IS INTENDED TO SHOW THE PLACEMENT OF THE MARK. THE MATTER WITHIN THE BROKEN LINE IS CLAIMED AS PART OF THE MARK.

FOR CLOTHING, NAMELY GLOVES (U.S. CLS. 22 AND 39).

FIRST USE 5-23-2005; IN COMMERCE 5-23-2005.

CLASS 26—FANCY GOODS

3,315,002. MICHAEL L LAMBERT, ATLANTA, GA. SN 78-874,772. FILED P.R. 5-2-2006; AM. S.R. 9-8-2007.

Sole Clips

THE MARK CONSISTS OF STANDARD CHARACTERS WITHOUT CLAIM TO ANY PARTICULAR FONT, STYLE, SIZE, OR COLOR.

FOR A CLIP THAT ATTACHES TO A PANT CUFF AND SHOE SOLE AND PREVENTS THE PANT CUFF FROM CONTACTING THE GROUND (U.S. CLS. 37, 39, 40, 42 AND 50).

FIRST USE 4-1-2006; IN COMMERCE 2-1-2007.

CLASS 28—TOYS AND SPORTING GOODS

3,314,933. ERN ENTERPRISES, INC., PALATINE, IL. SN 77-026,252. FILED P.R. 10-20-2006; AM. S.R. 9-4-2007.

POKER GOLF

THE MARK CONSISTS OF STANDARD CHARACTERS WITHOUT CLAIM TO ANY PARTICULAR FONT, STYLE, SIZE, OR COLOR.

NO CLAIM IS MADE TO THE EXCLUSIVE RIGHT TO USE "POKER", APART FROM THE MARK AS SHOWN.

FOR GAMES, NAMELY, A CARD AND DICE GAME WITH A GOLF RELATED THEME (U.S. CLS. 22, 23, 38 AND 50).

FIRST USE 3-0-2007; IN COMMERCE 3-0-2007.

3,314,941. TELEBRANDS CORPORATION, FAIRFIELD, NJ. SN 77-065,431. FILED P.R. 12-15-2006; AM. S.R. 8-3-2007.

FISHPEN

THE MARK CONSISTS OF STANDARD CHARACTERS WITHOUT CLAIM TO ANY PARTICULAR FONT, STYLE, SIZE, OR COLOR.

FOR FISHING ROD AND REEL (U.S. CLS. 22, 23, 38 AND 50).

FIRST USE 12-15-2006; IN COMMERCE 12-15-2006.

CLASS 28—(Continued).

3,314,978. MATTEL, INC., EL SEGUNDO, CA. SN 78-728,639. FILED P.R. 10-7-2005; AM. S.R. 9-6-2007.

PICNIC SET

THE MARK CONSISTS OF STANDARD CHARACTERS WITHOUT CLAIM TO ANY PARTICULAR FONT, STYLE, SIZE, OR COLOR.

OWNER OF U.S. REG. NOS. 2,306,429, 2,955,543, AND OTHERS.

FOR TOYS, GAMES AND PLAYTHINGS, NAMELY, DOLLS, DOLL CLOTHING AND DOLL ACCESSORIES, TOY FIGURES AND ACCESSORIES THEREFOR (U.S. CLS. 22, 23, 38 AND 50).

FIRST USE 1-23-2006; IN COMMERCE 1-23-2006.

3,315,012. COMPOUND BOW RIFLE SIGHT INC., BREESE, IL. SN 78-954,773. FILED P.R. 8-17-2006; AM. S.R. 7-23-2007.

PEEP ELIMINATOR

THE MARK CONSISTS OF STANDARD CHARACTERS WITHOUT CLAIM TO ANY PARTICULAR FONT, STYLE, SIZE, OR COLOR.

FOR ARCHERY EQUIPMENT, NAMELY, NON-TELESCOPIC BOW SIGHTS (U.S. CLS. 22, 23, 38 AND 50).

FIRST USE 3-1-2003; IN COMMERCE 3-1-2003.

3,315,023. MATTEL, INC., EL SEGUNDO, CA. SN 78-974,350. FILED P.R. 9-14-2006; AM. S.R. 7-30-2007.

TAXI RODS

THE MARK CONSISTS OF STANDARD CHARACTERS WITHOUT CLAIM TO ANY PARTICULAR FONT, STYLE, SIZE, OR COLOR.

FOR TOYS, GAMES AND PLAYTHINGS, NAMELY, TOY VEHICLES AND ACCESSORIES THEREFOR (U.S. CLS. 22, 23, 38 AND 50).

FIRST USE 5-18-2007; IN COMMERCE 5-18-2007.

CLASS 32—LIGHT BEVERAGES

CLASS 32—(Continued).

3,314,958. HOBSON, ROBERT A., NEWNAN, GA. SN 77-148,107. FILED P.R. 4-4-2007; AM. S.R. 7-19-2007.

FLAVOR INFUSION

THE MARK CONSISTS OF STANDARD CHARACTERS WITHOUT CLAIM TO ANY PARTICULAR FONT, STYLE, SIZE, OR COLOR.

OWNER OF U.S. REG. NO. 3,122,213.
FOR NON-ALCOHOLIC BEVERAGES WITH TEA FLAVOR; COFFEE-FLAVORED SOFT DRINK; SOFT DRINKS, NAMELY NON-ALCOHOLIC TEA-FLAVORED AND COFFEE-FLAVORED BEVERAGES AND SOFT DRINKS; FLAVORED WATERS; FLAVORED DRINKS, NAMELY, FRUIT-FLAVORED DRINKS, AND CONCENTRATES, SYRUPS, OR POWDERS USED IN THE PREPARATION OF SOFTDRINKS (U.S. CLS. 45, 46 AND 48).
FIRST USE 11-0-2004; IN COMMERCE 11-0-2004.

SERVICE MARKS**CLASS 35—ADVERTISING AND BUSINESS**

3,314,914. CAROLINA THEATRE PRESERVATION ASSOCIATION, INC., SPRUCE PINE, NC. SN 76-609,320. FILED P.R. 8-26-2004; AM. S.R. 8-17-2007.

THE CAROLINA BARN DANCE

THE MARK CONSISTS OF STANDARD CHARACTERS WITHOUT CLAIM TO ANY PARTICULAR FONT, STYLE, SIZE, OR COLOR.

FOR PROMOTING EVENTS OF OTHERS; PROMOTING THE CONCERTS OF OTHERS; AND PROVIDING FACILITIES FOR BUSINESS MEETINGS (U.S. CLS. 100, 101 AND 102).
FIRST USE 2-17-2007; IN COMMERCE 2-17-2007.

3,314,917. LONDON COMMERCIAL DISTRIBUTION, HIALEAH, FL. SN 76-658,168. FILED P.R. 4-10-2006; AM. S.R. 4-10-2007.

LONDON COMMERCIAL DISTRIBUTION

THE MARK CONSISTS OF STANDARD CHARACTERS WITHOUT CLAIM TO ANY PARTICULAR FONT, STYLE, SIZE, OR COLOR.

FOR RETAIL AND WHOLESALE DISTRIBUTORSHIPS FEATURING OUTDOOR, POOL, PATIO AND SPA PRODUCTS (U.S. CLS. 100, 101 AND 102).
FIRST USE 3-6-2006; IN COMMERCE 3-6-2006.

CLASS 35—(Continued).

3,314,925. NEWEDGE, INC., RICHLAND, WA. SN 77-000,978. FILED P.R. 9-15-2006; AM. S.R. 8-1-2007.

DISRUPTIVE BRANDING

THE MARK CONSISTS OF STANDARD CHARACTERS WITHOUT CLAIM TO ANY PARTICULAR FONT, STYLE, SIZE, OR COLOR.

OWNER OF U.S. REG. NO. 3,023,320.
NO CLAIM IS MADE TO THE EXCLUSIVE RIGHT TO USE "BRANDING", APART FROM THE MARK AS SHOWN.
FOR ADVERTISING SERVICES, NAMELY, CREATING CORPORATE AND BRAND IDENTITY FOR OTHERS; BUSINESS MARKETING CONSULTING SERVICES; MARKET RESEARCH CONSULTATION (U.S. CLS. 100, 101 AND 102).
FIRST USE 5-2-2006; IN COMMERCE 5-2-2006.

3,314,926. HECHT, MICHAEL A., MANHATTAN BEACH, CA. SN 77-001,858. FILED P.R. 9-18-2006; AM. S.R. 8-1-2007.

THE15DOLLARSTORE

THE MARK CONSISTS OF STANDARD CHARACTERS WITHOUT CLAIM TO ANY PARTICULAR FONT, STYLE, SIZE, OR COLOR.

FOR RETAIL STORE SERVICES IN THE FIELD OF CLOTHING AND ACCESSORIES (U.S. CLS. 100, 101 AND 102).
FIRST USE 7-7-2004; IN COMMERCE 7-7-2004.

3,314,931. EMMIS RADIO, LLC, INDIANAPOLIS, IN. SN 77-019,424. FILED P.R. 10-12-2006; AM. S.R. 8-1-2007.

CYBER REMOTE

THE MARK CONSISTS OF STANDARD CHARACTERS WITHOUT CLAIM TO ANY PARTICULAR FONT, STYLE, SIZE, OR COLOR.

FOR ADVERTISING SERVICES, NAMELY, PREPARING AND PLACING ADVERTISEMENTS FOR OTHERS PROMOTING THE GOODS AND SERVICES OF OTHERS THROUGH RADIO BROADCASTING AND VIA A GLOBAL COMMUNICATION NETWORK (U.S. CLS. 100, 101 AND 102).
FIRST USE 2-27-2004; IN COMMERCE 2-27-2004.

CLASS 35—(Continued).

3,314,932. MOVEABLE CUBICLE, INC., SAN CLEMENTE, AZ. SN 77-019,475. FILED P.R. 10-12-2006; AM. S.R. 6-1-2007.

**THE
YARD
CONTAINER MARKETPLACE**

NO CLAIM IS MADE TO THE EXCLUSIVE RIGHT TO USE "CONTAINER MARKETPLACE", APART FROM THE MARK AS SHOWN.

THE MARK CONSISTS OF THE WORDS "THE YARD CONTAINER MARKETPLACE" IN STYLIZED FONT WITH THE WORD "YARD" IN SIGNIFICANTLY LARGER PRINT.

FOR PROVIDING AN ONLINE MARKETPLACE FOR SELLERS FOR INTERMODAL CONTAINERS (U.S. CLS. 100, 101 AND 102).

FIRST USE 9-26-2006; IN COMMERCE 9-26-2006.

3,314,935. ECOM PPO ADVISORS, INC., DALLAS, TX. SN 77-047,359. FILED P.R. 11-19-2006; AM. S.R. 7-18-2007.

Member Level PPO Selection

THE MARK CONSISTS OF STANDARD CHARACTERS WITHOUT CLAIM TO ANY PARTICULAR FONT, STYLE, SIZE, OR COLOR.

FOR BUSINESS CONSULTING AND BUSINESS INFORMATION FOR ENTERPRISES; COST MANAGEMENT FOR THE HEALTH CARE BENEFIT PLANS OF OTHERS (U.S. CLS. 100, 101 AND 102).

FIRST USE 11-19-2006; IN COMMERCE 11-19-2006.

3,314,939. FLEETCOR TECHNOLOGIES, INC., NORCROSS, GA. SN 77-058,998. FILED P.R. 12-7-2006; AM. S.R. 7-30-2007.

GASCARD

THE MARK CONSISTS OF STANDARD CHARACTERS WITHOUT CLAIM TO ANY PARTICULAR FONT, STYLE, SIZE, OR COLOR.

FOR DATA PROCESSING AND BILLING SERVICES IN CONNECTION WITH AN AUTOMATED VEHICLE FUEL SYSTEM FOR COMMERCIAL COMPANIES AND INDEPENDENT JOBBERS (U.S. CLS. 100, 101 AND 102).

FIRST USE 1-1-1982; IN COMMERCE 1-1-1982.

CLASS 35—(Continued).

3,314,942. HAYDU INVESTMENTS LLC, LOMITA, CA. SN 77-066,824. FILED P.R. 12-18-2006; AM. S.R. 8-1-2007.

PILOTS YELLOWPAGES

THE MARK CONSISTS OF STANDARD CHARACTERS WITHOUT CLAIM TO ANY PARTICULAR FONT, STYLE, SIZE, OR COLOR.

NO CLAIM IS MADE TO THE EXCLUSIVE RIGHT TO USE "YELLOWPAGES", APART FROM THE MARK AS SHOWN.

FOR BUSINESS INFORMATION IN THE FIELD OF AIRPORT FACILITIES, VENDORS, AND SERVICES INFORMATION; ON-LINE BUSINESS DIRECTORIES FEATURING HOTELS, RESTAURANTS, AND NIGHTCLUBS; PROVIDING A WEB SITE WHICH FEATURES ADVERTISEMENTS FOR THE GOODS AND SERVICES OF OTHERS ON A GLOBAL COMPUTER NETWORK (U.S. CLS. 100, 101 AND 102).

FIRST USE 11-30-2006; IN COMMERCE 11-30-2006.

3,314,943. FLEETCOR TECHNOLOGIES, INC., NORCROSS, GA. SN 77-068,756. FILED P.R. 12-20-2006; AM. S.R. 7-30-2007.

GASCARD

THE MARK CONSISTS OF THE STYLIZED WORD "GASCARD".

FOR DATA PROCESSING AND BILLING SERVICES IN CONNECTION WITH AN AUTOMATED VEHICLE FUEL SYSTEM FOR COMMERCIAL COMPANIES AND INDEPENDENT JOBBERS (U.S. CLS. 100, 101 AND 102).

FIRST USE 1-1-1982; IN COMMERCE 1-1-1982.

CLASS 35—(Continued).

3,314,948. PAIDPOST INC, CEDAR GROVE, NJ. SN 77-090,923. FILED P.R. 1-25-2007; AM. S.R. 6-21-2007.

PAIDPOST

THE MARK CONSISTS OF STANDARD CHARACTERS WITHOUT CLAIM TO ANY PARTICULAR FONT, STYLE, SIZE, OR COLOR.

FOR ONLINE ADVERTISING SERVICES FOR OTHERS, NAMELY, INTERNET BASED SERVICE FOR CONNECTING ADVERTISERS WITH BLOGGERS WILLING TO BLOG ABOUT PRODUCTS AND SERVICES FOR A FEE (U.S. CLS. 100, 101 AND 102).

FIRST USE 12-3-2006; IN COMMERCE 1-21-2007.

3,314,952. LATTIMORE, LINDA, CARLSBAD, CA. SN 77-135,729. FILED P.R. 3-20-2007; AM. S.R. 8-2-2007.

WOMEN'S GLOBAL NETWORK

THE MARK CONSISTS OF STANDARD CHARACTERS WITHOUT CLAIM TO ANY PARTICULAR FONT, STYLE, SIZE, OR COLOR.

NO CLAIM IS MADE TO THE EXCLUSIVE RIGHT TO USE "NETWORK", APART FROM THE MARK AS SHOWN.

FOR ASSOCIATION SERVICES, NAMELY, PROMOTING THE INTERESTS OF PROFESSIONAL AND BUSINESS WOMEN (U.S. CLS. 100, 101 AND 102).

FIRST USE 7-20-2006; IN COMMERCE 10-1-2006.

3,314,955. MODEL HOME ACCENTS, LLC, DBA MODEL HOME ACCENTS, ZEPHYR COVE, NV. SN 77-143,347. FILED P.R. 3-29-2007; AM. S.R. 7-17-2007.

MODEL HOME ACCENTS

THE MARK CONSISTS OF STANDARD CHARACTERS WITHOUT CLAIM TO ANY PARTICULAR FONT, STYLE, SIZE, OR COLOR.

FOR SHOP-AT-HOME PARTIES FEATURING MODEL HOME DECOR ITEMS FOR THE HOME (U.S. CLS. 100, 101 AND 102).

FIRST USE 11-20-2006; IN COMMERCE 11-20-2006.

CLASS 35—(Continued).

3,314,964. ABOUTFACE CONSULTING CORPORATION, GAINESVILLE, GA. SN 77-157,254. FILED P.R. 4-16-2007; AM. S.R. 9-4-2007.

World's Premier Secret Shopping Company

THE MARK CONSISTS OF STANDARD CHARACTERS WITHOUT CLAIM TO ANY PARTICULAR FONT, STYLE, SIZE, OR COLOR.

OWNER OF U.S. REG. NO. 3,263,436.

NO CLAIM IS MADE TO THE EXCLUSIVE RIGHT TO USE "SHOPPING COMPANY", APART FROM THE MARK AS SHOWN.

FOR SHOPPING BY RESEARCHERS WHO POSE AS CUSTOMERS TO EVALUATE THE QUALITY OF SERVICE DELIVERED; MARKET RESEARCH CONSULTATION; MARKET MANIPULATION, RESEARCH AND ANALYSIS, WHETHER OR NOT VIA THE INTERNET (U.S. CLS. 100, 101 AND 102).

FIRST USE 1-1-2006; IN COMMERCE 1-1-2006.

3,314,967. SWANNER-RENNER, JACKIE, J., BAKER, MT. SN 77-183,119. FILED P.R. 5-16-2007; AM. S.R. 9-4-2007.

American Association of Caucasian Ovcharka Owners

THE MARK CONSISTS OF STANDARD CHARACTERS WITHOUT CLAIM TO ANY PARTICULAR FONT, STYLE, SIZE, OR COLOR.

NO CLAIM IS MADE TO THE EXCLUSIVE RIGHT TO USE "ASSOCIATION", APART FROM THE MARK AS SHOWN.

FOR ASSOCIATION SERVICES, NAMELY, PROMOTING THE INTERESTS OF CAUCASIAN OVCHARKA DOGS; MAINTAINING A REGISTRY OF BREEDS IN THE FIELD OF DOGS, NAMELY, CAUCASIAN OVCHARKA DOGS (U.S. CLS. 100, 101 AND 102).

FIRST USE 12-5-2003; IN COMMERCE 12-5-2003.

CLASS 35—(Continued).

3,314,976. BURLINGTON COAT FACTORY WAREHOUSE CORP., NORTH BURLINGTON, NJ. SN 78-720,420. FILED P.R. 9-26-2005; AM. S.R. 4-20-2007.

HOME DECOR

THE MARK CONSISTS OF STANDARD CHARACTERS WITHOUT CLAIM TO ANY PARTICULAR FONT, STYLE, SIZE, OR COLOR.

FOR RETAIL STORES SERVICES FEATURING BEDDING, TOWELS AND LUGGAGE (U.S. CLS. 100, 101 AND 102).

FIRST USE 12-0-2006; IN COMMERCE 12-0-2006.

3,314,984. DESIGNTECHNICA, INC., LAKE OSWEGO, OR. SN 78-788,700. FILED P.R. 1-10-2006; AM. S.R. 11-24-2006.

MediaSync.com

THE MARK CONSISTS OF STANDARD CHARACTERS WITHOUT CLAIM TO ANY PARTICULAR FONT, STYLE, SIZE, OR COLOR.

FOR PROVIDING ONLINE CONSUMER PRODUCT INFORMATION ABOUT VARIOUS ELECTRONIC MEDIA PRODUCTS THAT ENABLE USERS TO SYNCHRONIZE AUDIO, VIDEO, MULTIMEDIA, RADIO, AND TELEVISION PROGRAMMING TO PORTABLE MEDIA PLAYERS AND DIGITAL AUDIO PLAYERS (U.S. CLS. 100, 101 AND 102).

FIRST USE 2-14-2003; IN COMMERCE 2-14-2003.

CLASS 35—(Continued).

3,314,985. MARKETING TOOLS, INC., GRAND RAPIDS, MI. SN 78-795,191. FILED P.R. 1-19-2006; AM. S.R. 8-27-2007.

BUILDING YOUR COMPANY IMAGE

THE MARK CONSISTS OF STANDARD CHARACTERS WITHOUT CLAIM TO ANY PARTICULAR FONT, STYLE, SIZE, OR COLOR.

FOR ADVERTISING AND MARKETING; ADVERTISING, MARKETING AND PROMOTION SERVICES; BUSINESS MANAGEMENT CONSULTING WITH RELATION TO STRATEGY, MARKETING, PRODUCTION, PERSONNEL AND RETAIL SALE MATTERS; BUSINESS MARKETING CONSULTING SERVICES; BUSINESS MARKETING SERVICES; COMMERCIAL INFORMATION AGENCIES; DEVELOPMENT OF MARKETING STRATEGIES AND CONCEPTS; GENERAL BUSINESS MERCHANDISING SERVICES, NAMELY, MARKETING; MARKETING CONSULTING; PROMOTION AND MARKETING SERVICES AND RELATED CONSULTING (U.S. CLS. 100, 101 AND 102).

FIRST USE 12-31-1993; IN COMMERCE 12-31-1993.

3,314,994. TIMESHARE MLS INC., ORLANDO, FL. SN 78-834,758. FILED P.R. 3-10-2006; AM. S.R. 10-3-2006.

Timeshare MLS

THE MARK CONSISTS OF STANDARD CHARACTERS WITHOUT CLAIM TO ANY PARTICULAR FONT, STYLE, SIZE, OR COLOR.

FOR ADVERTISING AND MARKETING (U.S. CLS. 100, 101 AND 102).

FIRST USE 6-7-2004; IN COMMERCE 6-7-2004.

CLASS 35—(Continued).

3,315,016. NEWEDGE, INC., RICHLAND, WA. SN 78-964,877.
FILED P.R. 8-31-2006; AM. S.R. 8-1-2007.

DISRUPTIVE MARKET RESEARCH

THE MARK CONSISTS OF STANDARD CHARACTERS WITHOUT CLAIM TO ANY PARTICULAR FONT, STYLE, SIZE, OR COLOR.

OWNER OF U.S. REG. NO. 3,023,320.

NO CLAIM IS MADE TO THE EXCLUSIVE RIGHT TO USE "MARKET RESEARCH", APART FROM THE MARK AS SHOWN.

FOR BUSINESS MARKETING CONSULTING SERVICES; CREATING AND UPDATING ADVERTISING MATERIAL; MARKET ANALYSIS; MARKET RESEARCH (U.S. CLS. 100, 101 AND 102).

FIRST USE 5-15-2003; IN COMMERCE 5-15-2003.

3,315,022. FOR SALE BY INVESTOR, LLC, SALT LAKE CITY, UT. SN 78-969,646. FILED P.R. 9-8-2006; AM. S.R. 8-1-2007.

FSBI

THE MARK CONSISTS OF STANDARD CHARACTERS WITHOUT CLAIM TO ANY PARTICULAR FONT, STYLE, SIZE, OR COLOR.

FOR PROVIDING REAL ESTATE LISTINGS VIA THE INTERNET, MORTGAGE LENDING SERVICES (U.S. CLS. 100, 101 AND 102).

FIRST USE 7-1-2005; IN COMMERCE 7-1-2005.

CLASS 36—INSURANCE AND FINANCIAL

3,314,924. LIENFACTORS, LLC, NORTH HAVEN, CT. SN 76-671,993. FILED P.R. 1-29-2007; AM. S.R. 8-22-2007.

LIENFACTORS

THE MARK CONSISTS OF STANDARD CHARACTERS WITHOUT CLAIM TO ANY PARTICULAR FONT, STYLE, SIZE, OR COLOR.

FOR FINANCIAL SERVICES, NAMELY, SEARCHING FOR, LOCATING, ANALYZING AND NEGOTIATING THE PURCHASE OF UNPAID JUDGMENT LIENS IN EXCHANGE FOR CASH PAYMENTS (U.S. CLS. 100, 101 AND 102).

FIRST USE 4-30-2005; IN COMMERCE 4-30-2005.

CLASS 36—(Continued).

3,314,927. INSURANCEASSIST, INC., EL SEGUNDO, CA. SN 77-002,530. FILED P.R. 9-19-2006; AM. S.R. 8-1-2007.

EMPLOYEE-DRIVEN HEALTH CARE

THE MARK CONSISTS OF STANDARD CHARACTERS WITHOUT CLAIM TO ANY PARTICULAR FONT, STYLE, SIZE, OR COLOR.

FOR PROVIDING INSURANCE CONSULTATION AND PERSONALIZED ASSISTANCE RELATING TO FILING AND PROCESSING INSURANCE CLAIMS WITH INSURERS (U.S. CLS. 100, 101 AND 102).

FIRST USE 8-25-2006; IN COMMERCE 8-25-2006.

3,314,944. SHUSTERMAN, RICHARD, WEST CONSHOHOCKEN, PA. SN 77-073,428. FILED P.R. 12-29-2006; AM. S.R. 8-2-2007.

INTERNATIONAL PORTFOLIO,
INC.

THE MARK CONSISTS OF STANDARD CHARACTERS WITHOUT CLAIM TO ANY PARTICULAR FONT, STYLE, SIZE, OR COLOR.

NO CLAIM IS MADE TO THE EXCLUSIVE RIGHT TO USE "INC.", APART FROM THE MARK AS SHOWN.

FOR DEBT COLLECTION SERVICES (U.S. CLS. 100, 101 AND 102).

FIRST USE 12-18-2002; IN COMMERCE 12-18-2002.

3,314,954. DUNTON COMMERCIAL REAL ESTATE COMPANY, DENVER, CO. SN 77-138,360. FILED P.R. 3-23-2007; AM. S.R. 7-31-2007.

DUNTON COMMERCIAL

THE MARK CONSISTS OF STANDARD CHARACTERS WITHOUT CLAIM TO ANY PARTICULAR FONT, STYLE, SIZE, OR COLOR.

NO CLAIM IS MADE TO THE EXCLUSIVE RIGHT TO USE "COMMERCIAL", APART FROM THE MARK AS SHOWN.

FOR REAL ESTATE BROKERAGE AND PROPERTY MANAGEMENT SERVICES, NAMELY, BROKERING THE SALE OF COMMERCIAL REAL ESTATE, AND RENTING, LEASING, AND MANAGING COMMERCIAL REAL ESTATE (U.S. CLS. 100, 101 AND 102).

FIRST USE 12-1-2003; IN COMMERCE 12-1-2003.

CLASS 36—(Continued).

3,314,962. TRIAD HOSPITALS, INC., PLANO, TX. SN 77-152,723. FILED P.R. 4-10-2007; AM. S.R. 7-30-2007.

Willamette Valley Cancer Foundation

THE MARK CONSISTS OF STANDARD CHARACTERS WITHOUT CLAIM TO ANY PARTICULAR FONT, STYLE, SIZE, OR COLOR.

NO CLAIM IS MADE TO THE EXCLUSIVE RIGHT TO USE "CANCER FOUNDATION", APART FROM THE MARK AS SHOWN.

FOR CHARITABLE FUND RAISING (U.S. CLS. 100, 101 AND 102).

FIRST USE 10-31-2002; IN COMMERCE 10-31-2002.

3,314,986. WEST BEND MUTUAL INSURANCE COMPANY, WEST BEND, WI. SN 78-795,195. FILED P.R. 1-19-2006; AM. S.R. 9-5-2007.

RESPONDER

THE MARK CONSISTS OF STANDARD CHARACTERS WITHOUT CLAIM TO ANY PARTICULAR FONT, STYLE, SIZE, OR COLOR.

FOR INSURANCE SERVICES, NAMELY, MOBILE CLAIMS ADJUSTING SERVICES IN THE FIELDS OF PROPERTY AND CASUALTY INSURANCE (U.S. CLS. 100, 101 AND 102).

FIRST USE 8-29-2005; IN COMMERCE 8-29-2005.

3,315,010. RAMOS FINANCIAL, STREAMWOOD, IL. SN 78-940,556. FILED 7-29-2006.

RAMOS FINANCIAL

THE MARK CONSISTS OF STANDARD CHARACTERS WITHOUT CLAIM TO ANY PARTICULAR FONT, STYLE, SIZE, OR COLOR.

FOR REFUND ANTICIPATION LOANS (U.S. CLS. 100, 101 AND 102).

FIRST USE 3-1-2006; IN COMMERCE 6-1-2006.

CLASS 36—(Continued).

3,315,014. LONGEVITY ALLIANCE, INC., WASHINGTON, DC. SN 78-962,049. FILED P.R. 8-28-2006; AM. S.R. 7-18-2007.

LONGEVITY FINANCIAL

THE MARK CONSISTS OF STANDARD CHARACTERS WITHOUT CLAIM TO ANY PARTICULAR FONT, STYLE, SIZE, OR COLOR.

FOR INSURANCE AGENCY, BROKERAGE, AND CONSULTATION; FINANCIAL ANALYSIS AND CONSULTATION SERVICES; FINANCIAL MANAGEMENT, CONSULTING, PLANNING AND RESEARCH; AND PROVIDING DATABASES AND WEBSITES IN THE FIELDS OF INSURANCE AND FINANCE (U.S. CLS. 100, 101 AND 102).

FIRST USE 7-0-2006; IN COMMERCE 7-0-2006.

3,315,021. FLORIDA TITLE ADVISORS, INC., HIALEAH, FL. SN 78-969,174. FILED P.R. 9-7-2006; AM. S.R. 8-1-2007.

FLORIDA TITLE ADVISORS

THE MARK CONSISTS OF STANDARD CHARACTERS WITHOUT CLAIM TO ANY PARTICULAR FONT, STYLE, SIZE, OR COLOR.

FOR REAL ESTATE TITLE INSURANCE UNDERWRITING SERVICES (U.S. CLS. 100, 101 AND 102).

FIRST USE 6-6-2006; IN COMMERCE 6-12-2006.

CLASS 37—CONSTRUCTION AND REPAIR

3,314,918. KOLTER HOLDINGS FLORIDA, INC., WEST PALM BEACH, FL. SN 76-660,065. FILED P.R. 5-16-2006; AM. S.R. 8-9-2007.

KAST

THE MARK CONSISTS OF STANDARD CHARACTERS WITHOUT CLAIM TO ANY PARTICULAR FONT, STYLE, SIZE, OR COLOR.

THE NAME KAST DOES NOT IDENTIFY A LIVING INDIVIDUAL.

FOR REAL ESTATE DEVELOPMENT SERVICES (U.S. CLS. 100, 103 AND 106).

FIRST USE 6-1-2006; IN COMMERCE 6-1-2006.

CLASS 37—(Continued).

3,314,953. DAVIS, BRAD, GILBERT, AZ. SN 77-137,656.
FILED P.R. 3-22-2007; AM. S.R. 7-10-2007.

MOBILE FORCE REFUELING

THE MARK CONSISTS OF STANDARD CHARACTERS WITHOUT CLAIM TO ANY PARTICULAR FONT, STYLE, SIZE, OR COLOR.

NO CLAIM IS MADE TO THE EXCLUSIVE RIGHT TO USE "MOBILE" AND "REFUELING", APART FROM THE MARK AS SHOWN.

FOR FUELING SERVICES FOR MOTOR VEHICLES (U.S. CLS. 100, 103 AND 106).

FIRST USE 2-15-2000; IN COMMERCE 2-15-2003.

CLASS 38—COMMUNICATION

3,315,009. AOL LLC, DULLES, VA. SN 78-892,704. FILED P.R. 5-25-2006; AM. S.R. 9-6-2007.

BLOGGINGSTOCKS

THE MARK CONSISTS OF STANDARD CHARACTERS WITHOUT CLAIM TO ANY PARTICULAR FONT, STYLE, SIZE, OR COLOR.

FOR PROVIDING ONLINE ELECTRONIC BULLETIN BOARDS FOR TRANSMISSION OF MESSAGES AMONG COMPUTER USERS CONCERNING FINANCE, FINANCIAL FORECASTING AND ANALYSIS, FINANCIAL MARKETS, INVESTMENTS, SECURITIES, CORPORATE FINANCE, BUSINESS, ECONOMICS, AND COMMERCE (U.S. CLS. 100, 101 AND 104).

FIRST USE 4-27-2006; IN COMMERCE 4-27-2006.

CLASS 41—EDUCATION AND ENTERTAINMENT**CLASS 41—(Continued).**

3,314,915. CAROLINA THEATRE PRESERVATION ASSOCIATION, INC., SPRUCE PINE, NC. SN 76-609,321. FILED P.R. 8-26-2004; AM. S.R. 12-14-2006.

THE CAROLINA BARN DANCE

THE MARK CONSISTS OF STANDARD CHARACTERS WITHOUT CLAIM TO ANY PARTICULAR FONT, STYLE, SIZE, OR COLOR.

FOR ENTERTAINMENT, NAMELY LIVE PERFORMANCES BY MUSICAL BANDS; ENTERTAINMENT, NAMELY LIVE MUSIC CONCERTS; MOVIE THEATERS; ORGANIZING COMMUNITY FESTIVALS FEATURING A VARIETY OF ACTIVITIES, NAMELY, ART EXHIBITIONS, FLEA MARKETS, ETHNIC DANCES AND THE LIKE; ORGANIZING COMMUNITY CULTURAL EVENTS; ORGANIZING EXHIBITIONS FOR GEMS AND MINERALS; PROVIDING DANCE HALLS; AND PROVIDING FACILITIES FOR RECREATION ACTIVITIES (U.S. CLS. 100, 101 AND 107).

FIRST USE 2-17-2007; IN COMMERCE 2-17-2007.

3,314,921. INSTITUTE OF MANAGEMENT ACCOUNTANTS, MONTVALE, NJ. SN 76-669,693. FILED P.R. 11-29-2006; AM. S.R. 8-1-2007.

SOX ERM ONLINE

THE MARK CONSISTS OF STANDARD CHARACTERS WITHOUT CLAIM TO ANY PARTICULAR FONT, STYLE, SIZE, OR COLOR.

FOR EDUCATIONAL COURSES DEALING WITH LEGAL AND REGULATORY COMPLIANCE FOR MANAGEMENT ACCOUNTANTS AND FINANCE PROFESSIONALS (U.S. CLS. 100, 101 AND 107).

FIRST USE 6-0-2005; IN COMMERCE 6-0-2005.

3,314,922. INSTITUTE OF MANAGEMENT ACCOUNTANTS, MONTVALE, NJ. SN 76-669,694. FILED P.R. 11-29-2006; AM. S.R. 8-1-2007.



FOR EDUCATIONAL COURSES DEALING WITH LEGAL AND REGULATORY COMPLIANCE FOR MANAGEMENT ACCOUNTANTS AND FINANCE PROFESSIONALS (U.S. CLS. 100, 101 AND 107).

FIRST USE 6-0-2005; IN COMMERCE 6-0-2005.

CLASS 41—(Continued).

3,314,956. FITNESS4DIABETICS.COM LLC, NEW YORK, NY. SN 77-145,717. FILED P.R. 4-1-2007; AM. S.R. 8-2-2007.

Fitness4Diabetics

THE MARK CONSISTS OF STANDARD CHARACTERS WITHOUT CLAIM TO ANY PARTICULAR FONT, STYLE, SIZE, OR COLOR.

FOR PHYSICAL FITNESS CONSULTATION (U.S. CLS. 100, 101 AND 107).
FIRST USE 8-12-2005; IN COMMERCE 11-25-2005.

3,314,959. PRESBYTERIAN CONFERENCE ASSOCIATION, INC., HOLMES, NY. SN 77-150,258. FILED P.R. 4-5-2007; AM. S.R. 4-5-2007.

HOLMES PRESBYTERIAN CAMP AND CONFERENCE CENTER

THE MARK CONSISTS OF STANDARD CHARACTERS WITHOUT CLAIM TO ANY PARTICULAR FONT, STYLE, SIZE, OR COLOR.

NO CLAIM IS MADE TO THE EXCLUSIVE RIGHT TO USE "CAMP AND CONFERENCE CENTER", APART FROM THE MARK AS SHOWN.
FOR RECREATIONAL CAMPS (U.S. CLS. 100, 101 AND 107).
FIRST USE 2-0-2007; IN COMMERCE 2-0-2007.

3,314,965. AIA HOUSTON, HOUSTON, TX. SN 77-158,030. FILED P.R. 4-16-2007; AM. S.R. 8-2-2007.

GULF COAST GREEN

THE MARK CONSISTS OF STANDARD CHARACTERS WITHOUT CLAIM TO ANY PARTICULAR FONT, STYLE, SIZE, OR COLOR.

FOR EDUCATIONAL SERVICES, NAMELY, CONDUCTING CONFERENCES IN THE FIELD OF ENVIRONMENTALLY FRIENDLY BUILDING DESIGN AND STRATEGIES (U.S. CLS. 100, 101 AND 107).
FIRST USE 4-1-2005; IN COMMERCE 4-1-2005.

CLASS 41—(Continued).

3,314,968. WILKES UNIVERSITY/JUSC, WILKES-BARRE, PA. SN 77-190,392. FILED P.R. 5-25-2007; AM. S.R. 9-6-2007.

eToolkit

THE MARK CONSISTS OF STANDARD CHARACTERS WITHOUT CLAIM TO ANY PARTICULAR FONT, STYLE, SIZE, OR COLOR.

FOR DEVELOPMENT AND DISSEMINATION OF EDUCATIONAL MATERIALS OF OTHERS IN THE FIELD OF ECONOMIC AND COMMUNITY DEVELOPMENT, URBAN PLANNING, LAND USE PLANNING, TRANSPORTATION PLANNING, COMPREHENSIVE PLANNING, HOUSING STRATEGIES AND GOVERNMENT PLANNING (U.S. CLS. 100, 101 AND 107).
FIRST USE 8-1-2006; IN COMMERCE 5-1-2007.

3,314,974. PIECES OF EIGHT, LTD., SHERMAN OAKS, CA. SN 78-660,270. FILED P.R. 6-28-2005; AM. S.R. 12-27-2006.

Total Mental Fitness

THE MARK CONSISTS OF STANDARD CHARACTERS WITHOUT CLAIM TO ANY PARTICULAR FONT, STYLE, SIZE, OR COLOR.

FOR EDUCATIONAL SERVICES, NAMELY, CONDUCTING COURSES AND SEMINARS IN PERSONAL DEVELOPMENT, ENTERTAINMENT ACTIVITIES, SPORTING ACTIVITIES AND CULTURAL ACTIVITIES (U.S. CLS. 100, 101 AND 107).
FIRST USE 1-1-2004; IN COMMERCE 5-1-2006.

CLASS 41—(Continued).

3,314,977. NEWBAY MEDIA LLC, NEW YORK, NY. SN 78-722,594. FILED 9-28-2005.

POST INDUSTRY

THE MARK CONSISTS OF STANDARD CHARACTERS WITHOUT CLAIM TO ANY PARTICULAR FONT, STYLE, SIZE, OR COLOR.

NO CLAIM IS MADE TO THE EXCLUSIVE RIGHT TO USE "INDUSTRY", APART FROM THE MARK AS SHOWN.

FOR PROVIDING A WEB SITE FEATURING NEWS AND INFORMATION IN THE FIELDS OF PRODUCTION AND POST-PRODUCTION FOR MAKING AUDIO VISUAL MEDIA, MOTION PICTURES, DIGITAL PRESENTATIONS FOR FILM, FILMS, AND OTHER RELATED MEDIA FEATURING THE SUBJECTS OF EDITING, PRODUCTION DESIGN, SOUND RECORDING, AND DIGITAL MEDIA (U.S. CLS. 100, 101 AND 107).

FIRST USE 6-0-1999; IN COMMERCE 6-0-1999.

3,314,990. NATIONAL ARTICULATION AND TRANSFER NETWORK, SAN FRANCISCO, CA. SN 78-821,995. FILED P.R. 2-23-2006; AM. S.R. 9-6-2007.

NATIONAL ARTICULATION AND TRANSFER NETWORK

THE MARK CONSISTS OF STANDARD CHARACTERS WITHOUT CLAIM TO ANY PARTICULAR FONT, STYLE, SIZE, OR COLOR.

FOR PROVIDING EDUCATIONAL INFORMATION TO STUDENTS, FACULTY, PARENTS, HIGH SCHOOLS, COLLEGES AND UNIVERSITIES VIA ONLINE DATABASES CONCERNING FACILITATION OF TRANSFERS FROM ONE EDUCATIONAL INSTITUTION TO ANOTHER, ACCESS TO COLLEGE, EDUCATIONAL ADVANCEMENT IN COLLEGE, HIGH SCHOOL AND COLLEGE ACADEMICS, AND CAREER COUNSELING (U.S. CLS. 100, 101 AND 107).

FIRST USE 7-1-2002; IN COMMERCE 7-1-2002.

3,314,995. TOBY COREY, LOS GATOS, CA. SN 78-835,150. FILED P.R. 3-12-2006; AM. S.R. 9-5-2007.

World Sports Betting Championship

THE MARK CONSISTS OF STANDARD CHARACTERS WITHOUT CLAIM TO ANY PARTICULAR FONT, STYLE, SIZE, OR COLOR.

CLASS 41—(Continued).

NO CLAIM IS MADE TO THE EXCLUSIVE RIGHT TO USE "CHAMPIONSHIP", APART FROM THE MARK AS SHOWN. FOR ENTERTAINMENT SERVICES, NAMELY, COMPETITIVE GAMBLING EVENTS RENDERED LIVE AND THROUGH THE MEDIA OF TELEVISION AND THE INTERNET (U.S. CLS. 100, 101 AND 107).

FIRST USE 3-1-2006; IN COMMERCE 3-1-2006.

3,315,001. USAGENCY, INC., LEWISBURG, PA. SN 78-872,989. FILED P.R. 4-30-2006; AM. S.R. 9-7-2007.

Original American Country

THE MARK CONSISTS OF STANDARD CHARACTERS WITHOUT CLAIM TO ANY PARTICULAR FONT, STYLE, SIZE, OR COLOR.

NO CLAIM IS MADE TO THE EXCLUSIVE RIGHT TO USE "COUNTRY", APART FROM THE MARK AS SHOWN. FOR ENTERTAINMENT, NAMELY, LIVE PERFORMANCES BY MUSICAL BANDS, AND LIVE MUSIC CONCERTS (U.S. CLS. 100, 101 AND 107).

FIRST USE 0-0-2002; IN COMMERCE 0-0-2002.

3,315,008. AOL LLC, DULLES, VA. SN 78-892,694. FILED P.R. 5-25-2006; AM. S.R. 9-6-2007.

BLOGGINGSTOCKS

THE MARK CONSISTS OF STANDARD CHARACTERS WITHOUT CLAIM TO ANY PARTICULAR FONT, STYLE, SIZE, OR COLOR.

FOR ONLINE JOURNALS, NAMELY, BLOGS IN THE FIELD OF FINANCE, FINANCIAL FORECASTING AND ANALYSIS, INVESTMENTS, SECURITIES, CORPORATE FINANCE, BUSINESS, ECONOMICS, AND COMMERCE (U.S. CLS. 100, 101 AND 107).

FIRST USE 4-27-2006; IN COMMERCE 4-27-2006.

CLASS 42—SCIENTIFIC AND COMPUTER SERVICES

CLASS 42—(Continued).

3,314,929. MAZZANTI, INC., HOBOKEN, NJ. SN 77-007,563. FILED P.R. 9-26-2006; AM. S.R. 7-6-2007.

TECHNOLOGY STRATEGIES FOR
BUSINESS GROWTH

THE MARK CONSISTS OF STANDARD CHARACTERS WITHOUT CLAIM TO ANY PARTICULAR FONT, STYLE, SIZE, OR COLOR.

OWNER OF U.S. REG. NO. 3,150,242.

FOR CONSULTING SERVICES IN THE FIELD OF DESIGN, SELECTION, IMPLEMENTATION AND USE OF COMPUTER HARDWARE AND SOFTWARE SYSTEMS FOR OTHERS (U.S. CLS. 100 AND 101).

FIRST USE 7-0-2006; IN COMMERCE 7-0-2006.

3,314,934. ENZON PHARMACEUTICALS, INC., BRIDGEWATER, NJ. SN 77-028,430. FILED P.R. 10-24-2006; AM. S.R. 8-9-2007.

CUSTOMIZED LINKER
TECHNOLOGY

THE MARK CONSISTS OF STANDARD CHARACTERS WITHOUT CLAIM TO ANY PARTICULAR FONT, STYLE, SIZE, OR COLOR.

FOR PHARMACEUTICAL RESEARCH AND DEVELOPMENT INCLUDING TREATMENT OF BIOLOGICALLY ACTIVE MATERIALS SUCH AS PROTEINS, PEPTIDES, POLYPEPTIDES AND OTHER NATURAL OR RECOMBINANTLY PREPARED THERAPEUTIC MATERIALS USING POLYMERS (U.S. CLS. 100 AND 101).

FIRST USE 8-9-2007; IN COMMERCE 8-9-2007.

3,314,940. WATCH SYSTEMS, LLC, COVINGTON, LA. SN 77-059,150. FILED P.R. 12-7-2006; AM. S.R. 7-30-2007.

OFFENDER WATCH

THE MARK CONSISTS OF STANDARD CHARACTERS WITHOUT CLAIM TO ANY PARTICULAR FONT, STYLE, SIZE, OR COLOR.

FOR COMPUTER SERVICE, NAMELY, ACTING AS AN APPLICATION SERVICE PROVIDER TO HOST COMPUTER APPLICATION SOFTWARE FOR THE REGISTRATION, MONITORING, LOCATING, NOTIFICATION AND SHARING OF DATA AND INFORMATION REGARDING INDIVIDUALS CONVICTED OF SEX CRIMES (U.S. CLS. 100 AND 101).

FIRST USE 6-1-2003; IN COMMERCE 6-1-2003.

CLASS 42—(Continued).

3,315,000. GEM CERTIFICATION & ASSURANCE LAB, INC., NEW YORK, NY. SN 78-872,436. FILED P.R. 4-28-2006; AM. S.R. 9-11-2007.

GEMFACTS

THE MARK CONSISTS OF STANDARD CHARACTERS WITHOUT CLAIM TO ANY PARTICULAR FONT, STYLE, SIZE, OR COLOR.

FOR AUTHENTICATION AND GRADING OF PRECIOUS STONES (U.S. CLS. 100 AND 101).

FIRST USE 7-0-2006; IN COMMERCE 10-0-2006.

3,315,013. CENTRA-LARM MONITORING, INC., MANCHESTER, NH. SN 78-961,710. FILED P.R. 8-28-2006; AM. S.R. 7-20-2007.

SELFTRAC

THE MARK CONSISTS OF STANDARD CHARACTERS WITHOUT CLAIM TO ANY PARTICULAR FONT, STYLE, SIZE, OR COLOR.

FOR PROVIDING ONLINE NON-DOWNLOADABLE SOFTWARE FOR ASSET TRACKING OF STATIONARY OR IN MOTION PERSONAL PROPERTY VIA GLOBAL POSITIONING SATELLITES; AND PERSONAL TRACKING OF HUMANS WITH TRACKING DEVICES VIA GLOBAL POSITIONING SATELLITES; AND FOR SECURITY, NAMELY PERSONAL, HOME OR BUSINESS SECURITY SURVEILLANCE (U.S. CLS. 100 AND 101).

FIRST USE 12-1-2006; IN COMMERCE 12-1-2006.

CLASS 44—MEDICAL, BEAUTY AND AGRICULTURAL SERVICES

CLASS 44—(Continued).

3,314,963. TRIAD HOSPITALS, INC., PLANO, TX. SN 77-152,805. FILED P.R. 4-10-2007; AM. S.R. 7-30-2007.

Community Radiology Center

THE MARK CONSISTS OF STANDARD CHARACTERS WITHOUT CLAIM TO ANY PARTICULAR FONT, STYLE, SIZE, OR COLOR.
NO CLAIM IS MADE TO THE EXCLUSIVE RIGHT TO USE "RADIOLOGY CENTER", APART FROM THE MARK AS SHOWN.
FOR HOSPITALS (U.S. CLS. 100 AND 101).
FIRST USE 10-31-2002; IN COMMERCE 10-31-2002.

3,314,966. FROHLICH, SARA, BROOKLYN, NY. SN 77-160,529. FILED P.R. 4-19-2007; AM. S.R. 8-3-2007.

Acupuncture at Work

THE MARK CONSISTS OF STANDARD CHARACTERS WITHOUT CLAIM TO ANY PARTICULAR FONT, STYLE, SIZE, OR COLOR.
FOR ACUPUNCTURE SERVICES; AND TRADITIONAL CHINESE MEDICAL SERVICES, NAMELY, AURICULAR ACUPUNCTURE SERVICES PERFORMED IN THE WORKPLACE AND IN OFFICE SETTINGS (U.S. CLS. 100 AND 101).
FIRST USE 10-1-2006; IN COMMERCE 10-1-2006.

CLASS 44—(Continued).

3,315,011. SGTR, INC., PALM BEACH GARDENS, FL. SN 78-947,126. FILED P.R. 8-8-2006; AM. S.R. 8-30-2007.

ANESTHETIX

THE MARK CONSISTS OF STANDARD CHARACTERS WITHOUT CLAIM TO ANY PARTICULAR FONT, STYLE, SIZE, OR COLOR.
FOR ANESTHESIA AND PAIN MANAGEMENT SERVICES (U.S. CLS. 100 AND 101).
FIRST USE 2-27-2007; IN COMMERCE 2-27-2007.

3,315,020. KWOF SALONS, INC., GLENDALE, WI. SN 78-968,144. FILED P.R. 9-6-2006; AM. S.R. 7-30-2007.

KWOF SALONS

THE MARK CONSISTS OF STANDARD CHARACTERS WITHOUT CLAIM TO ANY PARTICULAR FONT, STYLE, SIZE, OR COLOR.
NO CLAIM IS MADE TO THE EXCLUSIVE RIGHT TO USE "SALONS", APART FROM THE MARK AS SHOWN.
FOR BEAUTY SALON SERVICES (U.S. CLS. 100 AND 101).
FIRST USE 1-1-2005; IN COMMERCE 1-1-2005.

* * * * *

TRADEMARK REGISTRATIONS RENEWED

The designation "U.S. Cl." appearing in this section refers to the U.S. class in effect prior to Sep. 1, 1973 rather than the international class which applies to applications filed on or after that date. For adoption of international classification see notice in the OFFICIAL GAZETTE of Jun. 26, 1973 (911 O.G. TM 210).

64,816.	MISCELLANEOUS DESIGN. U.S. CL. 46. (INT. CL. 30). REG. 8-20-1907.	826,906.	M MOTHERCARE AND DESIGN. U.S. CL. 39. (INT. CLS. 10, 25 AND 26). REG. 4-4-1967.
66,420.	ERICO (STYLIZED). U.S. CL. 21. (INT. CL. 9). REG. 11-26-1907.	827,105.	TEFLON. U.S. CL. 16. (INT. CL. 2). REG. 4-11-1967.
118,391.	DARLING. U.S. CL. 46. (INT. CL. 31). REG. 9-4-1917.	827,959.	SEQUESTRENE. U.S. CL. 46. (INT. CL. 1). REG. 4-25-1967.
232,223.	FASTUSOL. U.S. CL. 6. (INT. CL. 2). REG. 9-6-1927.	829,881.	TAKE5. U.S. CL. 46. (INT. CL. 30). REG. 6-6-1967.
233,799.	BRIDAL VEIL (STYLIZED). U.S. CL. 46. (INT. CL. 31). REG. 10-11-1927.	833,120.	VENT DOWEL. U.S. CL. 13. (INT. CL. 6). REG. 8-1-1967.
347,276.	INTERNATIONAL UNION OF OPERATING ENGINEERS-ORGANIZED DEC. 7, 1896- LABOR OMNIA VINCIT AND DESIGN. U.S. CL. 38. (INT. CLS. 9, 16 AND 28). REG. 6-22-1937.	833,919.	CEMENTONE. U.S. CL. 16. (INT. CL. 2). REG. 8-22-1967.
348,879.	MISCELLANEOUS DESIGN. U.S. CL. 6. (INT. CLS. 1, 2, 3, 4 AND 5). REG. 8-17-1937.	834,148.	PDQ. U.S. CL. 101. (INT. CL. 42). REG. 8-22-1967.
349,228.	G AND DESIGN. U.S. CL. 21. (INT. CL. 9). REG. 8-24-1937.	834,597.	E PLURIBUS UNUM PAX ET JUSTITIA AND DESIGN. U.S. CL. 17. (INT. CL. 34). REG. 9-5-1967.
350,881.	LORD DAYTON AND DESIGN. U.S. CL. 39. (INT. CL. 25). REG. 10-12-1937.	834,776.	PUNTO BLANCO AND DESIGN. U.S. CL. 39. (INT. CL. 25). REG. 9-5-1967.
432,235.	ROSY DAWN (STYLIZED). U.S. CL. 46. (INT. CL. 31). REG. 8-26-1947.	835,115.	TERRA-RIB (STYLIZED). U.S. CL. 35. (INT. CL. 12). REG. 9-12-1967.
432,974.	INTERLUX (STYLIZED). U.S. CL. 16. (INT. CL. 2). REG. 9-23-1947.	835,284.	MADISON SQUARE GARDEN. U.S. CL. 107. (INT. CL. 41). REG. 9-12-1967.
437,701.	E AND DESIGN. U.S. CL. 14. (INT. CL. 6). REG. 3-30-1948.	835,576.	DUPLO. U.S. CL. 46. (INT. CL. 30). REG. 9-19-1967.
439,981.	SOLTROL. U.S. CL. 52. (INT. CL. 3). REG. 8-3-1948.	836,059.	BINACA. U.S. CL. 51. (INT. CLS. 3 AND 5). REG. 9-26-1967.
639,618.	GRADALL. U.S. CL. 23. (INT. CL. 7). REG. 1-8-1957.	836,400.	CARE*FREE AND DESIGN. U.S. CL. 46. (INT. CL. 30). REG. 10-3-1967.
643,128.	KAOLITE (STYLIZED). U.S. CL. 12. (INT. CL. 19). REG. 3-26-1957.	842,813.	TEK. U.S. CL. 23. (INT. CLS. 6, 7, 8, 9, 11, 12, 16, 21 AND 28). REG. 1-23-1968.
643,366.	CHEESWEET. U.S. CL. 46. (INT. CL. 30). REG. 3-26-1957.	843,138.	TOYOTA (STYLIZED). U.S. CL. 19. (INT. CL. 12). REG. 1-30-1968.
644,546.	BEAUTY DROPS (STYLIZED). U.S. CL. 51. (INT. CL. 3). REG. 4-23-1957.	848,089.	CHURCH. U.S. CL. 13. (INT. CL. 11). REG. 4-30-1968.
649,935.	KATADYN (STYLIZED). U.S. CL. 6. (INT. CL. 1). REG. 8-13-1957.	849,001.	CERTIPAK (STYLIZED). U.S. CL. 23. (INT. CL. 7). REG. 5-14-1968.
650,380.	MOLDTEM. U.S. CL. 14. (INT. CL. 6). REG. 8-20-1957.	849,914.	NIFTY FIFTY. U.S. CL. 46. (INT. CL. 31). REG. 5-28-1968.
650,469.	B AND DESIGN. U.S. CL. 23. (INT. CL. 7). REG. 8-20-1957.	851,606.	ISOPREP. U.S. CL. 52. (INT. CL. 1). REG. 6-25-1968.
650,866.	BALL BUSHING. U.S. CL. 23. (INT. CL. 7). REG. 8-27-1957.	853,001.	AZ. U.S. CL. 6. (INT. CLS. 1 AND 2). REG. 7-23-1968.
650,942.	TV GUIDE AND DESIGN. U.S. CL. 38. (INT. CL. 16). REG. 8-27-1957.	1,039,038.	SUMIFIX. INT. CL. 2. (U.S. CL. 6). REG. 5-11-1976.
651,000.	COLOR TOUCH. U.S. CL. 51. (INT. CL. 3). REG. 8-27-1957.	1,047,590.	HICOREX. INT. CL. 9. (U.S. CL. 21). REG. 9-7-1976.
655,900.	TRIMCLIP. U.S. CL. 44. (INT. CL. 8). REG. 12-17-1957.	1,054,058.	E & J (STYLIZED). INT. CL. 33. (U.S. CL. 49). REG. 12-7-1976.
658,890.	BACHMAN AND DESIGN. U.S. CL. 46. (INT. CL. 30). REG. 2-25-1958.	1,054,243.	BEV-L-EDGE. INT. CL. 9. (U.S. CL. 26). REG. 12-14-1976.
660,325.	BYRON JACKSON. U.S. CL. 23. (INT. CL. 7). REG. 4-8-1958.	1,057,948.	TREK ADVENTURES. INT. CL. 39. (U.S. CL. 105). REG. 2-1-1977.
661,932.	BABY TALK (STYLIZED). U.S. CL. 38. (INT. CL. 16). REG. 5-20-1958.	1,060,544.	PLURAFLO. INT. CL. 1. (U.S. CL. 6). REG. 3-8-1977.
662,774.	LAMINOL. U.S. CL. 14. (INT. CL. 6). REG. 6-10-1958.	1,060,617.	MISCELLANEOUS DESIGN. INT. CL. 6. (U.S. CL. 14). REG. 3-8-1977.
662,981.	PACO. U.S. CL. 12. (INT. CLS. 6, 17 AND 19). REG. 6-17-1958.	1,061,085.	LEXIN. INT. CL. 5. (U.S. CL. 18). REG. 3-15-1977.
808,484.	CHAMP. U.S. CL. 31. (INT. CLS. 7, 11 AND 12). REG. 5-17-1966.	1,062,573.	PUREX (STYLIZED). INT. CL. 3. (U.S. CL. 52). REG. 4-5-1977.
822,267.	CERNELLE. U.S. CL. 18. (INT. CL. 5). REG. 1-17-1967.	1,063,099.	ARRIVO. INT. CL. 5. (U.S. CL. 6). REG. 4-12-1977.
822,593.	MISCELLANEOUS DESIGN. U.S. CL. 200. REG. 1-17-1967.	1,063,628.	SUPERMITE. INT. CL. 1. (U.S. CL. 6). REG. 4-19-1977.
823,963.	MISCELLANEOUS DESIGN. U.S. CL. 23 ONLY. (INT. CLS. 6, 7, 8, 9, 11, 12, 16, 21 AND 28). REG. 2-14-1967.	1,065,566.	THE PRO. INT. CL. 1. (U.S. CL. 5). REG. 5-17-1977.
824,501.	TIP TROL. U.S. CL. 44. (INT. CL. 10). REG. 2-21-1967.	1,069,569.	BLINK'S. INT. CL. 42. (U.S. CL. 100). REG. 7-12-1977.
		1,069,756.	WM WAX MAGIC AND DESIGN. INT. CL. 8. (U.S. CL. 23). REG. 7-19-1977.
		1,069,824.	WHAT'S NEW. INT. CL. 16. (U.S. CL. 38). REG. 7-19-1977.
		1,070,709.	CORNSWEET (STYLIZED). INT. CL. 30. (U.S. CL. 46). REG. 8-2-1977.
		1,070,910.	INERTIATECH. INT. CL. 7. (U.S. CL. 34). REG. 8-9-1977.

- 1,070,924. OLFLEX (STYLIZED). INT. CL. 9. (U.S. CL. 21). REG. 8-9-1977.
- 1,071,233. SUPER TURF BUILDER PLUS HALTS. INT. CL. 1. (U.S. CL. 10). REG. 8-16-1977.
- 1,071,269. POUNCE. INT. CL. 5. (U.S. CL. 6). REG. 8-16-1977.
- 1,071,450. ISODAMP. INT. CL. 17. (U.S. CL. 1). REG. 8-16-1977.
- 1,071,626. MELONITE. INT. CL. 40. (U.S. CL. 106). REG. 8-16-1977.
- 1,071,777. AL-TORQUE. INT. CL. 7. (U.S. CL. 23). REG. 8-23-1977.
- 1,071,832. ORTHO. INT. CL. 16. (U.S. CL. 38). REG. 8-23-1977.
- 1,071,869. MINIMIZER. INT. CL. 25. (U.S. CL. 39). REG. 8-23-1977.
- 1,071,956. TRUCKPRO HEAVY DUTY PROFESSIONALS. INT. CLS. 37 AND 42. (U.S. CLS. 101 AND 103). REG. 8-23-1977.
- 1,071,969. D AND DESIGN. INT. CLS. 41 AND 42. (U.S. CLS. 101 AND 107). REG. 8-23-1977.
- 1,072,020. AMERICAN BUSINESS AND DESIGN. INT. CL. 16. (U.S. CL. 38). REG. 8-23-1977.
- 1,072,231. "SUNSHINE LINE" AND DESIGN. INT. CL. 16. (U.S. CL. 38). REG. 8-30-1977.
- 1,072,331. MR. HERO. INT. CLS. 30, 35 AND 42. (U.S. CLS. 46, 100 AND 101). REG. 8-30-1977.
- 1,072,395. C AND DESIGN. INT. CL. 41. (U.S. CL. 107). REG. 8-30-1977.
- 1,072,532. CEDARAPIDS. INT. CL. 7. (U.S. CL. 23). REG. 9-6-1977.
- 1,072,888. MOVEMENT OF SPIRITUAL INNER AWARENESS MSIA AND DESIGN. INT. CL. 41. (U.S. CL. 107). REG. 9-6-1977.
- 1,072,963. ARLASOLVE. INT. CL. 1. (U.S. CL. 6). REG. 9-13-1977.
- 1,073,683. GALAXY. INT. CL. 27. (U.S. CL. 42). REG. 9-20-1977.
- 1,073,709. PIZZA PAL. INT. CL. 29. (U.S. CL. 46). REG. 9-20-1977.
- 1,074,013. SUN-LITE. INT. CL. 17. (U.S. CL. 12). REG. 9-27-1977.
- 1,074,745. ABLE. INT. CL. 40. (U.S. CL. 106). REG. 10-4-1977.
- 1,075,210. MISCELLANEOUS DESIGN. INT. CL. 37. (U.S. CL. 103). REG. 10-11-1977.
- 1,075,438. THERMO-KOOL TK MID-SOUND INDUSTRIES, INC. (STYLIZED). INT. CL. 11. (U.S. CL. 31). REG. 10-18-1977.
- 1,075,440. ULTROX. INT. CL. 11. (U.S. CL. 31). REG. 10-18-1977.
- 1,076,407. PLASTIC MAN (STYLIZED). INT. CL. 16. (U.S. CL. 38). REG. 11-1-1977.
- 1,077,191. GENEROL. INT. CL. 1. (U.S. CL. 6). REG. 11-15-1977.
- 1,077,745. GLASSTECH. INT. CL. 7. (U.S. CL. 23). REG. 11-22-1977.
- 1,078,062. DM AND DESIGN. INT. CL. 35. (U.S. CL. 101). REG. 11-22-1977.
- 1,078,504. POCAHONTAS AMERICA'S FIRST LADY OF FOOD SERVICE AND DESIGN. INT. CL. 29 ONLY. (U.S. CL. 46). REG. 11-29-1977.
- 1,079,306. ELBEX (STYLIZED). INT. CL. 9. (U.S. CLS. 21 AND 36). REG. 12-13-1977.
- 1,079,534. MISCELLANEOUS DESIGN. INT. CL. 39. (U.S. CL. 105). REG. 12-13-1977.
- 1,080,202. AMT-675. INT. CL. 7. (U.S. CL. 23). REG. 12-27-1977.
- 1,080,557. HEILEMAN'S OLD STYLE PURE GENUINE AND DESIGN. INT. CL. 32. (U.S. CL. 48). REG. 12-27-1977.
- 1,082,923. TRANSCENDENTAL MEDITATION. INT. CL. 41. (U.S. CL. 107). REG. 1-17-1978.
- 1,086,546. MOORE'S (STYLIZED). INT. CLS. 29 AND 30. (U.S. CL. 46). REG. 2-28-1978.
- 1,089,496. AC-2. INT. CL. 1. (U.S. CL. 6). REG. 4-18-1978.
- 1,089,523. BLACK ORCHID. INT. CL. 3. (U.S. CLS. 1, 4, 6, 50, 51 AND 52). REG. 4-18-1978.
- 1,090,538. TRUE VALUE. U.S. CL. 200. REG. 5-2-1978.
- 1,098,555. MISCELLANEOUS DESIGN. INT. CL. 7. (U.S. CL. 23). REG. 8-8-1978.
- 1,099,546. BIGHORN (STYLIZED). INT. CL. 18. (U.S. CL. 3). REG. 8-15-1978.
- 1,403,438. HARDIN AND DESIGN. INT. CL. 37. (U.S. CL. 103). REG. 7-29-1986.
- 1,410,801. CHEVRION. INT. CL. 29. (U.S. CL. 46). REG. 9-23-1986.
- 1,413,260. WHEELED COACH AND DESIGN. INT. CL. 12. (U.S. CL. 19). REG. 10-14-1986.
- 1,427,853. AMERICA'S COVER MISS AND COVER BOY U.S.A. AND DESIGN. INT. CL. 41. (U.S. CL. 107). REG. 2-3-1987.
- 1,428,720. MISCELLANEOUS DESIGN. INT. CL. 36. (U.S. CL. 102). REG. 2-10-1987.
- 1,429,640. HOME OF THE FISH TACO (STYLIZED). INT. CL. 42. (U.S. CL. 100). REG. 2-17-1987.
- 1,430,639. FACADES UNLIMITED. INT. CL. 42. (U.S. CLS. 100 AND 101). REG. 2-24-1987.
- 1,430,697. FIGHT FAT (STYLIZED). INT. CL. 42. (U.S. CL. 100). REG. 2-24-1987.
- 1,430,871. BEDA. INT. CL. 7. (U.S. CLS. 13 AND 23). REG. 3-3-1987.
- 1,431,634. PHEROMUSK. INT. CL. 1. (U.S. CL. 6). REG. 3-10-1987.
- 1,436,974. ACLYN. INT. CL. 1. (U.S. CLS. 6 AND 16). REG. 4-21-1987.
- 1,437,441. BANANIMAL. INT. CL. 28. (U.S. CL. 22). REG. 4-21-1987.
- 1,441,708. STATE GREASE-B-GONE. INT. CL. 3. (U.S. CL. 52). REG. 6-9-1987.
- 1,444,044. BULLSEYE AND DESIGN. INT. CL. 12. (U.S. CL. 35). REG. 6-23-1987.
- 1,444,058. SPLENDID AND DESIGN. INT. CL. 15. (U.S. CL. 36). REG. 6-23-1987.
- 1,444,060. CONTINENTAL. INT. CL. 15. (U.S. CL. 36). REG. 6-23-1987.
- 1,444,817. APACHE. INT. CL. 5. (U.S. CL. 6). REG. 6-30-1987.
- 1,444,907. INOTEK AND DESIGN. INT. CLS. 9 AND 42. (U.S. CLS. 21, 26 AND 101). REG. 6-30-1987.
- 1,445,204. B AND DESIGN. INT. CL. 20. (U.S. CLS. 12 AND 13). REG. 6-30-1987.
- 1,445,871. MISS. INT. CL. 3. (U.S. CL. 51). REG. 7-7-1987.
- 1,446,048. AXON. INT. CL. 9 ONLY. (U.S. CLS. 21 AND 26). REG. 7-7-1987.
- 1,446,344. S.E.S.P. - III. INT. CL. 16. (U.S. CL. 38). REG. 7-7-1987.
- 1,446,812. TRANSPAC. INT. CL. 37. (U.S. CL. 103). REG. 7-7-1987.
- 1,446,879. JOHN CRANE AND DESIGN. INT. CL. 42. (U.S. CL. 100). REG. 7-7-1987.
- 1,447,406. SAILING WORLD. INT. CL. 16. (U.S. CL. 38). REG. 7-14-1987.
- 1,447,520. DIAL-A-DRILL. INT. CL. 20. (U.S. CLS. 2 AND 23). REG. 7-14-1987.
- 1,447,529. IBOCO (STYLIZED). INT. CL. 20. (U.S. CLS. 12 AND 13). REG. 7-14-1987.
- 1,448,307. G AND DESIGN. INT. CL. 9. (U.S. CL. 21). REG. 7-21-1987.
- 1,449,938. MORNFLAKE SUPER FAST OATS NATURES NATURAL FOOD MORNFLAKE AND DESIGN. INT. CL. 30. (U.S. CL. 46). REG. 7-28-1987.
- 1,450,296. MISCELLANEOUS DESIGN. INT. CL. 4. (U.S. CLS. 6 AND 15). REG. 8-4-1987.
- 1,450,321. GAMIT. INT. CL. 5. (U.S. CL. 6). REG. 8-4-1987.
- 1,450,367. SWEEPSTER. INT. CL. 7. (U.S. CL. 23). REG. 8-4-1987.
- 1,450,446. INAS. INT. CL. 9. (U.S. CL. 38). REG. 8-4-1987.
- 1,450,521. LIGHT-WELDER. INT. CL. 9. (U.S. CLS. 21 AND 34). REG. 8-4-1987.
- 1,450,593. OMNISTIM (STYLIZED). INT. CL. 10. (U.S. CL. 44). REG. 8-4-1987.
- 1,450,594. OMNISOUND (STYLIZED). INT. CL. 10. (U.S. CL. 44). REG. 8-4-1987.
- 1,450,747. ZAP. INT. CL. 16. (U.S. CLS. 2, 5, 22, 23, 29, 37, 38 AND 50). REG. 8-4-1987.
- 1,450,948. GUNDAM. INT. CL. 28. (U.S. CLS. 22 AND 50). REG. 8-4-1987.
- 1,451,522. CABLE CAR EXPRESS. INT. CL. 42. (U.S. CL. 100). REG. 8-4-1987.
- 1,451,556. MFP. INT. CL. 9. (U.S. CL. 26). REG. 8-4-1987.
- 1,451,761. DE DIETRICH AND DESIGN. INT. CLS. 6, 7 AND 11. (U.S. CLS. 2, 23, 31 AND 34). REG. 8-11-1987.
- 1,451,786. CHNC. INT. CL. 7. (U.S. CL. 23). REG. 8-11-1987.
- 1,451,878. ELECTRO SPEED. INT. CL. 9. (U.S. CLS. 21 AND 26). REG. 8-11-1987.
- 1,451,957. COGNEX. INT. CL. 9. (U.S. CLS. 21, 23, 26, 36 AND 38). REG. 8-11-1987.
- 1,452,120. NOREX. INT. CL. 17. (U.S. CLS. 1 AND 12). REG. 8-11-1987.
- 1,452,335. RADICAL. INT. CL. 28. (U.S. CL. 22). REG. 8-11-1987.

- 1,452,504. EXECUTRON MORTGAGE NETWORK. INT. CL. 36. (U.S. CL. 102). REG. 8-11-1987.
- 1,452,532. COMPRENEW. INT. CLS. 37 AND 39. (U.S. CLS. 103 AND 105). REG. 8-11-1987.
- 1,452,692. INKOL. INT. CL. 1. (U.S. CL. 6). REG. 8-18-1987.
- 1,452,804. TAXI 2. INT. CL. 3. (U.S. CLS. 51 AND 52). REG. 8-18-1987.
- 1,452,834. B33. INT. CL. 4. (U.S. CL. 15). REG. 8-18-1987.
- 1,452,879. THERAFLU. INT. CL. 5. (U.S. CL. 18). REG. 8-18-1987.
- 1,452,981. DIGITAL REALITY. INT. CL. 9. (U.S. CL. 38). REG. 8-18-1987.
- 1,453,006. SUPER SNOOP AND DESIGN. INT. CL. 9. (U.S. CL. 21). REG. 8-18-1987.
- 1,453,011. FLEX-MODE. INT. CL. 9. (U.S. CL. 21). REG. 8-18-1987.
- 1,453,087. SCARECROW. INT. CL. 9. (U.S. CL. 21). REG. 8-18-1987.
- 1,453,155. AVANTI. INT. CL. 14. (U.S. CL. 27). REG. 8-18-1987.
- 1,453,325. BALLOON RACE. INT. CL. 28. (U.S. CL. 22). REG. 8-18-1987.
- 1,453,448. CORK DRY GIN. INT. CL. 33. (U.S. CL. 49). REG. 8-18-1987.
- 1,453,449. THE CLUB (STYLIZED). INT. CL. 33. (U.S. CL. 49). REG. 8-18-1987.
- 1,453,539. TOLL BROTHERS. INT. CL. 37. (U.S. CL. 103). REG. 8-18-1987.
- 1,453,579. STUDENT REFERRAL SERVICE. INT. CL. 41. (U.S. CL. 107). REG. 8-18-1987.
- 1,453,588. THE BEST OF YESTERDAY'S MUSIC...AND TODAY'S. INT. CL. 41. (U.S. CL. 107). REG. 8-18-1987.
- 1,453,600. AAFP HOME STUDY SELF-ASSESSMENT. INT. CL. 41. (U.S. CL. 107). REG. 8-18-1987.
- 1,453,651. GUAYMAS. INT. CL. 42. (U.S. CL. 100). REG. 8-18-1987.
- 1,453,656. PEIRONE. INT. CL. 42. (U.S. CL. 101). REG. 8-18-1987.
- 1,453,745. DAYTIME POPULATION. INT. CL. 42. (U.S. CLS. 100 AND 101). REG. 8-18-1987.
- 1,453,767. TMXDI. INT. CL. 1. (U.S. CL. 6). REG. 8-25-1987.
- 1,453,768. TMI. INT. CL. 1. (U.S. CL. 6). REG. 8-25-1987.
- 1,453,783. TANKSAFE. INT. CL. 1. (U.S. CL. 6). REG. 8-25-1987.
- 1,453,829. NATURE-SOL. INT. CL. 3. (U.S. CL. 52). REG. 8-25-1987.
- 1,453,949. VEKTOR FLO V AND DESIGN. INT. CL. 7. (U.S. CL. 23). REG. 8-25-1987.
- 1,453,989. HELPING HAND. INT. CL. 9. (U.S. CL. 23). REG. 8-25-1987.
- 1,453,991. COBA AND DESIGN. INT. CL. 9. (U.S. CLS. 21 AND 26). REG. 8-25-1987.
- 1,454,002. FLOW POKE. INT. CL. 9. (U.S. CL. 26). REG. 8-25-1987.
- 1,454,082. HEARTSTART. INT. CL. 10. (U.S. CL. 44). REG. 8-25-1987.
- 1,454,173. CHECKOUT COUPON. INT. CL. 16. (U.S. CL. 38). REG. 8-25-1987.
- 1,454,256. V. AND DESIGN. INT. CLS. 18 AND 25. (U.S. CLS. 1, 2, 3, 22, 39 AND 41). REG. 8-25-1987.
- 1,454,322. COLORADO. INT. CL. 25. (U.S. CL. 39). REG. 8-25-1987.
- 1,454,323. DR. MARTENS. INT. CL. 25. (U.S. CL. 39). REG. 8-25-1987.
- 1,454,350. PRGR (STYLIZED). INT. CL. 25. (U.S. CL. 39). REG. 8-25-1987.
- 1,454,408. ALKINCO. INT. CL. 26. (U.S. CLS. 1 AND 40). REG. 8-25-1987.
- 1,454,418. GEM. INT. CL. 27. (U.S. CL. 42). REG. 8-25-1987.
- 1,454,504. SCHWAN'S. INT. CLS. 29, 30 AND 32. (U.S. CL. 46). REG. 8-25-1987.
- 1,454,568. JOLT AND DESIGN. INT. CL. 32. (U.S. CL. 45). REG. 8-25-1987.
- 1,454,689. SALVATORE FERRAGAMO (STYLIZED). INT. CL. 42. (U.S. CLS. 100 AND 101). REG. 8-25-1987.
- 1,454,903. STRETCH 20. INT. CL. 7. (U.S. CL. 23). REG. 9-1-1987.
- 1,454,952. EARTHSPACE. INT. CL. 9. (U.S. CL. 38). REG. 9-1-1987.
- 1,454,954. ORECK. INT. CL. 9. (U.S. CLS. 21 AND 23). REG. 9-1-1987.
- 1,454,955. COBA. INT. CL. 9. (U.S. CLS. 21 AND 26). REG. 9-1-1987.
- 1,454,972. THE SOLUTION SERIES. INT. CL. 9. (U.S. CL. 38). REG. 9-1-1987.
- 1,455,039. SYSTAR. INT. CL. 9. (U.S. CL. 38). REG. 9-1-1987.
- 1,455,215. MV (STYLIZED). INT. CLS. 18 AND 25 ONLY. (U.S. CLS. 1, 2, 3, 22, 39 AND 41). REG. 9-1-1987.
- 1,455,493. SLINKY. INT. CL. 28. (U.S. CL. 22). REG. 9-1-1987.
- 1,455,586. OUTBURST. INT. CL. 28. (U.S. CL. 22). REG. 9-1-1987.
- 1,456,349. DIGICORA. INT. CL. 9. (U.S. CL. 26). REG. 9-8-1987.
- 1,456,415. AIRQUEST. INT. CL. 11. (U.S. CL. 34). REG. 9-8-1987.
- 1,456,560. MICRO-CLAIR. INT. CL. 21. (U.S. CL. 29). REG. 9-8-1987.
- 1,456,631. RMC. INT. CL. 25. (U.S. CL. 39). REG. 9-8-1987.
- 1,456,701. OYSTER. INT. CL. 30. (U.S. CL. 46). REG. 9-8-1987.
- 1,456,732. TEXACANTE. INT. CL. 30. (U.S. CL. 46). REG. 9-8-1987.
- 1,456,746. OFF AND RUNNING. INT. CL. 31. (U.S. CL. 46). REG. 9-8-1987.
- 1,457,087. FLONAC. INT. CL. 2. (U.S. CL. 6). REG. 9-15-1987.
- 1,457,237. SENSI-TOUCH. INT. CL. 9. (U.S. CLS. 23 AND 26). REG. 9-15-1987.
- 1,457,282. MASTERVISION. INT. CL. 9. (U.S. CLS. 21 AND 26). REG. 9-15-1987.
- 1,457,345. ROLEEZ. INT. CL. 12. (U.S. CLS. 19 AND 35). REG. 9-15-1987.
- 1,457,881. THERMO-SHIELD. INT. CL. 17 ONLY. (U.S. CLS. 6 AND 16). REG. 9-22-1987.
- 1,458,352. KENNETH COLE. INT. CL. 18. (U.S. CLS. 3 AND 41). REG. 9-22-1987.
- 1,458,528. GREAT LAKES. INT. CL. 28. (U.S. CL. 22). REG. 9-22-1987.
- 1,458,985. FLITETOP. INT. CL. 7. (U.S. CL. 23). REG. 9-29-1987.
- 1,459,182. STAPLES. INT. CLS. 16 AND 42. (U.S. CLS. 37 AND 101). REG. 9-29-1987.
- 1,459,287. MALLORY & CHURCH LTD.. INT. CL. 25. (U.S. CL. 39). REG. 9-29-1987.
- 1,459,414. TROIKA. INT. CL. 30. (U.S. CL. 46). REG. 9-29-1987.
- 1,459,658. MISCELLANEOUS DESIGN. INT. CL. 42. (U.S. CLS. 100 AND 101). REG. 9-29-1987.
- 1,459,701. POL.K. OF A. POLKA LOVERS KLUB OF AMERICA AND DESIGN. INT. CL. 42. (U.S. CL. 100). REG. 9-29-1987.
- 1,459,763. GROWTH PRODUCTS. INT. CL. 1. (U.S. CL. 10). REG. 10-6-1987.
- 1,459,771. BEVA. INT. CL. 1. (U.S. CL. 5). REG. 10-6-1987.
- 1,460,274. GREENLINE. INT. CL. 31. (U.S. CL. 46). REG. 10-6-1987.
- 1,460,333. GOLD. INT. CL. 37. (U.S. CL. 103). REG. 10-6-1987.
- 1,460,976. NO-GAP. INT. CL. 25. (U.S. CL. 39). REG. 10-13-1987.
- 1,461,136. COURTNEY. INT. CL. 28. (U.S. CL. 22). REG. 10-13-1987.
- 1,461,259. JOHN T'S. INT. CL. 34. (U.S. CL. 17). REG. 10-13-1987.
- 1,461,411. RADIO WATCH AND DESIGN. INT. CL. 42. (U.S. CL. 104). REG. 10-13-1987.
- 1,461,460. MISCELLANEOUS DESIGN. INT. CL. 42. (U.S. CL. 101). REG. 10-13-1987.
- 1,461,664. ACROWOOD. INT. CL. 7 ONLY. (U.S. CL. 23). REG. 10-20-1987.
- 1,461,736. GEPE AND DESIGN. INT. CL. 9. (U.S. CL. 26). REG. 10-20-1987.
- 1,462,974. PRIMA. INT. CL. 28. (U.S. CLS. 3 AND 22). REG. 10-27-1987.
- 1,463,049. BIRRA PERONI 1846 AND DESIGN. INT. CL. 32. (U.S. CL. 48). REG. 10-27-1987.
- 1,463,410. HOLIDAY RAMBLER. INT. CL. 12. (U.S. CL. 19). REG. 11-3-1987.
- 1,464,402. PUR SWAB AND DESIGN. INT. CL. 9. (U.S. CLS. 21 AND 29). REG. 11-10-1987.
- 1,464,791. SPRINGLITE. INT. CL. 32. (U.S. CL. 45). REG. 11-10-1987.
- 1,464,793. COLORADO CRYSTAL. INT. CL. 32. (U.S. CL. 45). REG. 11-10-1987.
- 1,465,334. TEMPSTAR. INT. CL. 11. (U.S. CL. 34). REG. 11-17-1987.
- 1,465,342. AES AND DESIGN. INT. CL. 11. (U.S. CL. 31). REG. 11-17-1987.
- 1,465,497. GOLD BOND. INT. CL. 20. (U.S. CLS. 13 AND 50). REG. 11-17-1987.

- 1,466,028. SELECTIVE CYCLE. INT. CL. 9. (U.S. CL. 26). REG. 11-17-1987.
- 1,466,029. SMART SERIES. INT. CL. 9. (U.S. CL. 26). REG. 11-17-1987.
- 1,467,047. SPINDLER & HOYER AND DESIGN. INT. CL. 9. (U.S. CL. 26). REG. 12-1-1987.
- 1,467,057. PE. INT. CL. 9. (U.S. CL. 26). REG. 12-1-1987.
- 1,467,327. BOTTOM OF THE BARREL. INT. CL. 16. (U.S. CL. 38). REG. 12-1-1987.
- 1,467,344. THE AUSTRALIAN STOCK SADDLE CO. AND DESIGN. INT. CL. 18. (U.S. CL. 3). REG. 12-1-1987.
- 1,467,753. RYAN'S FAMILY STEAK HOUSE AND DESIGN. INT. CL. 42. (U.S. CL. 100). REG. 12-1-1987.
- 1,468,151. MONSOON. INT. CL. 9. (U.S. CL. 23). REG. 12-8-1987.
- 1,468,192. LIBERTY. INT. CL. 11. (U.S. CL. 34). REG. 12-8-1987.
- 1,468,279. BNAI ZION AND DESIGN. INT. CL. 16. (U.S. CLS. 37 AND 38). REG. 12-8-1987.
- 1,468,294. MISCELLANEOUS DESIGN. INT. CL. 16. (U.S. CL. 38). REG. 12-8-1987.
- 1,468,379. TEK-WALL. INT. CL. 24. (U.S. CL. 42). REG. 12-8-1987.
- 1,469,180. FUZZIE. INT. CL. 28. (U.S. CL. 22). REG. 12-15-1987.
- 1,469,266. BIJOL. INT. CL. 30. (U.S. CL. 46). REG. 12-15-1987.
- 1,469,603. BLACK ACE. INT. CL. 7. (U.S. CL. 23). REG. 12-22-1987.
- 1,470,386. SYNERGISTICS. INT. CL. 5. (U.S. CL. 18). REG. 12-29-1987.
- 1,470,953. FIRST AMERICAN. INT. CL. 36. (U.S. CL. 102). REG. 12-29-1987.
- 1,471,162. TIN-CO-BEN. INT. CL. 5. (U.S. CL. 18). REG. 1-5-1988.
- 1,471,530. UNCLE JESSE'S AND DESIGN. INT. CL. 29. (U.S. CL. 46). REG. 1-5-1988.
- 1,472,835. FLUORINOL. INT. CL. 6. (U.S. CL. 14). REG. 1-19-1988.
- 1,473,752. BELMONT SPRINGS. INT. CL. 1. (U.S. CL. 6). REG. 1-26-1988.
- 1,473,840. HARTMANN H AND DESIGN. INT. CLS. 5 AND 16. (U.S. CLS. 6, 18, 37, 39 AND 44). REG. 1-26-1988.
- 1,474,070. BULL'S EYE FLAPPER. INT. CL. 11. (U.S. CL. 13). REG. 1-26-1988.
- 1,474,503. WETCARE. INT. CL. 37. (U.S. CL. 103). REG. 1-26-1988.
- 1,474,726. TIN-BEN. INT. CL. 5. (U.S. CL. 18). REG. 2-2-1988.
- 1,475,045. SHEER SHEER BERKSHIRE. INT. CL. 25. (U.S. CL. 39). REG. 2-2-1988.
- 1,475,977. HIGH SIERRA. INT. CL. 25. (U.S. CL. 39). REG. 2-9-1988.
- 1,476,501. ANALPRAM HC. INT. CL. 5. (U.S. CL. 18). REG. 2-16-1988.
- 1,477,665. INSTA-LEARN. INT. CL. 16. (U.S. CL. 38). REG. 2-23-1988.
- 1,478,230. CANAL +. INT. CL. 5. (U.S. CL. 44). REG. 3-1-1988.
- 1,479,015. HYDRAULIC WORLD AND DESIGN. INT. CL. 37. (U.S. CL. 103). REG. 3-1-1988.
- 1,479,168. CLINITRON. INT. CL. 42. (U.S. CL. 100). REG. 3-1-1988.
- 1,480,838. REMINGTON. INT. CL. 21. (U.S. CLS. 21, 23 AND 29). REG. 3-15-1988.
- 1,482,099. WATTYL. INT. CL. 2. (U.S. CL. 16). REG. 3-29-1988.
- 1,482,100. ESTAPOL. INT. CL. 2. (U.S. CL. 16). REG. 3-29-1988.
- 1,483,045. BEZINAL. INT. CL. 6. (U.S. CLS. 12 AND 13). REG. 4-5-1988.
- 1,485,196. MECHATRONICS AND DESIGN. INT. CL. 11. (U.S. CL. 34). REG. 4-19-1988.
- 1,486,489. AIRPORT FAST PARK. INT. CL. 39. (U.S. CL. 105). REG. 4-26-1988.
- 1,486,671. SLO-NIACIN. INT. CL. 5. (U.S. CL. 18). REG. 5-3-1988.
- 1,489,558. DEVAULT FOODS. INT. CL. 30 ONLY. (U.S. CL. 46). REG. 5-24-1988.
- 1,490,629. ACTIONQUEST. INT. CL. 42. (U.S. CL. 100). REG. 5-31-1988.
- 1,490,680. ZETA BETA TAU FRATERNITY. U.S. CL. 200. REG. 5-31-1988.
- 1,492,478. COW TALES. INT. CL. 30. (U.S. CL. 46). REG. 6-14-1988.
- 1,497,683. MODEL RETAILER. INT. CL. 16. (U.S. CL. 38). REG. 7-26-1988.
- 1,500,440. PURA-TECH. INT. CL. 11. (U.S. CL. 31). REG. 8-16-1988.
- 1,500,510. SPARKLE. INT. CL. 16. (U.S. CL. 37). REG. 8-16-1988.
- 1,837,460. AMERICAN ALARM. INT. CLS. 37 AND 42. (U.S. CLS. 100, 101 AND 103). REG. 5-24-1996.
- 1,848,055. VISOR. INT. CL. 5. (U.S. CL. 6). REG. 8-2-1994.
- 1,950,848. AVADYNE. INT. CL. 1. (U.S. CLS. 1, 5, 6, 10, 26 AND 46). REG. 1-23-1996.
- 2,014,792. BUFFALO BUTT. INT. CL. 32. (U.S. CLS. 45, 46 AND 48). REG. 11-12-1996.
- 2,015,687. CROWN POINT GRAPHICS. INT. CL. 16. (U.S. CLS. 2, 5, 22, 23, 29, 37, 38 AND 50). REG. 11-12-1996.
- 2,022,848. WATER STORE WATER STORE NETWORK AND DESIGN. INT. CL. 32 ONLY. (U.S. CLS. 45, 46 AND 48). REG. 12-17-1996.
- 2,023,810. PIPESORT. INT. CL. 9. (U.S. CLS. 21, 23, 26, 36 AND 38). REG. 12-17-1996.
- 2,030,018. IF THE SHOE FITS, IT'S MASON. INT. CL. 42. (U.S. CLS. 100 AND 101). REG. 1-14-1997.
- 2,034,442. ULTRA PRO. INT. CL. 3. (U.S. CLS. 1, 4, 6, 50, 51 AND 52). REG. 1-28-1997.
- 2,035,254. DUTCH CUPBOARD. INT. CL. 29. (U.S. CL. 46). REG. 2-4-1997.
- 2,036,473. ALTERNATIVE RETIREMENT SOLUTIONS. INT. CL. 36. (U.S. CLS. 100, 101 AND 102). REG. 2-11-1997.
- 2,036,967. PRIMA SERIES. INT. CL. 10. (U.S. CLS. 26, 39 AND 44). REG. 2-11-1997.
- 2,037,278. ZZOOM AND DESIGN. INT. CL. 36. (U.S. CLS. 100, 101 AND 102). REG. 2-11-1997.
- 2,037,380. WIMBOCK AND DESIGN. INT. CL. 11. (U.S. CLS. 13, 21, 23, 31 AND 34). REG. 2-11-1997.
- 2,038,177. LABOR TRAKER. INT. CL. 9. (U.S. CLS. 21, 23, 26, 36 AND 38). REG. 2-18-1997.
- 2,038,345. SARAH'S PANTRY. INT. CL. 42. (U.S. CLS. 100 AND 101). REG. 2-18-1997.
- 2,038,554. FSE. INT. CL. 11. (U.S. CLS. 13, 21, 23, 31 AND 34). REG. 2-18-1997.
- 2,038,577. BURST!. INT. CL. 35. (U.S. CLS. 100, 101 AND 102). REG. 2-18-1997.
- 2,039,858. ALPHA-BIOPLEX. INT. CL. 3. (U.S. CLS. 1, 4, 6, 50, 51 AND 52). REG. 2-25-1997.
- 2,039,956. SARAH'S PANTRY AND DESIGN. INT. CL. 42. (U.S. CLS. 100 AND 101). REG. 2-25-1997.
- 2,040,242. ISLE OF JURA. INT. CL. 33. (U.S. CLS. 47 AND 49). REG. 2-25-1997.
- 2,040,338. GOOD PENNYWORTH PRESS. INT. CL. 16. (U.S. CLS. 2, 5, 22, 23, 29, 37, 38 AND 50). REG. 2-25-1997.
- 2,041,419. HOME ENTHUSIAST PANEL. INT. CL. 16. (U.S. CLS. 2, 5, 22, 23, 29, 37, 38 AND 50). REG. 2-25-1997.
- 2,041,466. FIELD & STREAM. INT. CL. 3. (U.S. CLS. 1, 4, 6, 50, 51 AND 52). REG. 2-25-1997.
- 2,041,690. WESTERN NATIONAL. INT. CL. 36. (U.S. CLS. 100, 101 AND 102). REG. 3-4-1997.
- 2,042,234. YOU EXPECT TRUCKS. YOU GET SOLUTIONS.. INT. CLS. 37 AND 39. (U.S. CLS. 100, 103, 105 AND 106). REG. 3-4-1997.
- 2,043,278. MOTIONSTAR. INT. CL. 9. (U.S. CLS. 21, 23, 26, 36 AND 38). REG. 3-11-1997.
- 2,044,183. SRS. INT. CL. 9. (U.S. CLS. 21, 23, 26, 36 AND 38). REG. 3-11-1997.
- 2,045,817. MISCELLANEOUS DESIGN. INT. CL. 16. (U.S. CLS. 2, 5, 22, 23, 29, 37, 38 AND 50). REG. 3-18-1997.
- 2,046,177. PRIMA. INT. CL. 25. (U.S. CLS. 22 AND 39). REG. 3-18-1997.
- 2,046,272. GRAND SOFT. INT. CL. 30. (U.S. CL. 46). REG. 3-18-1997.
- 2,047,946. JENNIFER LIVING ROOMS AND DESIGN. INT. CL. 42. (U.S. CLS. 100 AND 101). REG. 3-25-1997.
- 2,048,101. MISCELLANEOUS DESIGN. INT. CL. 9. (U.S. CLS. 21, 23, 26, 36 AND 38). REG. 3-25-1997.
- 2,048,699. FFL. INT. CL. 42. (U.S. CLS. 100 AND 101). REG. 4-1-1997.
- 2,048,911. CANCUN. INT. CL. 33. (U.S. CLS. 47 AND 49). REG. 4-1-1997.
- 2,048,991. A STEP IN THE RIGHT DIRECTION. INT. CL. 42. (U.S. CLS. 100 AND 101). REG. 4-1-1997.

- 2,049,058. SENTECH MEDICAL SYSTEMS. INT. CL. 10. (U.S. CLS. 26, 39 AND 44). REG. 4-1-1997.
- 2,053,652. ACOU-STIK. INT. CL. 9. (U.S. CLS. 21, 23, 26, 36 AND 38). REG. 4-15-1997.
- 2,054,967. WISE CHOICE. INT. CLS. 29 AND 30. (U.S. CL. 46). REG. 4-22-1997.
- 2,055,340. EVEREST RE. INT. CL. 36. (U.S. CLS. 100, 101 AND 102). REG. 4-22-1997.
- 2,059,134. FLORIDA ROLLER SINCE 1983 AND DESIGN. INT. CL. 16. (U.S. CLS. 2, 5, 22, 23, 29, 37, 38 AND 50). REG. 5-6-1997.
- 2,063,043. CHARGE UP TO RECYCLE. INT. CL. 40. (U.S. CLS. 100, 103 AND 106). REG. 5-20-1997.
- 2,064,793. PROTO 2000 SERIES AND DESIGN. INT. CL. 28. (U.S. CLS. 22, 23, 38 AND 50). REG. 5-27-1997.
- 2,065,176. DARC CURE. INT. CL. 2. (U.S. CLS. 6, 11 AND 16). REG. 5-27-1997.
- 2,065,211. ULTRA LIGHT-WELD. INT. CL. 1. (U.S. CLS. 1, 5, 6, 10, 26 AND 46). REG. 5-27-1997.
- 2,066,196. MILESTONES. INT. CL. 9. (U.S. CLS. 21, 23, 26, 36 AND 38). REG. 6-3-1997.
- 2,068,088. FIRE FACILITIES, INC.. INT. CL. 37. (U.S. CLS. 100, 103 AND 106). REG. 6-3-1997.
- 2,068,679. WHISKEY PETE'S HOTEL CASINO AND DESIGN. INT. CLS. 6, 9, 16 AND 25. (U.S. CLS. 2, 5, 12, 13, 14, 21, 22, 23, 25, 26, 29, 36, 37, 38, 39 AND 50). REG. 6-10-1997.
- 2,070,801. ALTERNATIVE SURF. INT. CL. 42. (U.S. CLS. 100 AND 101). REG. 6-10-1997.
- 2,071,030. THE WORLD'S MOST LEGENDARY RACE-TRACK. INT. CL. 41. (U.S. CLS. 100, 101 AND 107). REG. 6-17-1997.
- 2,071,469. BAYOXIDE. INT. CL. 1. (U.S. CLS. 1, 5, 6, 10, 26 AND 46). REG. 6-17-1997.
- 2,072,941. SONATA. INT. CL. 21. (U.S. CLS. 2, 13, 23, 29, 30, 33, 40 AND 50). REG. 6-24-1997.
- 2,072,961. DBS BANK AND DESIGN. INT. CL. 36. (U.S. CLS. 100, 101 AND 102). REG. 6-24-1997.
- 2,073,050. TOMORROW'S LEADERS OF MPI. INT. CL. 41. (U.S. CLS. 100, 101 AND 107). REG. 6-24-1997.
- 2,073,457. STATE SCRUB. INT. CL. 3. (U.S. CLS. 1, 4, 6, 50, 51 AND 52). REG. 6-24-1997.
- 2,073,752. NUFACOR. INT. CL. 42. (U.S. CLS. 100 AND 101). REG. 6-24-1997.
- 2,073,786. SNOWSHOES. INT. CL. 29. (U.S. CL. 46). REG. 6-24-1997.
- 2,073,787. USUALS. INT. CL. 29. (U.S. CL. 46). REG. 6-24-1997.
- 2,073,788. LACES. INT. CL. 29. (U.S. CL. 46). REG. 6-24-1997.
- 2,074,276. CENTRAL RESERVATIONS OF PARK CITY AND DESIGN. INT. CLS. 39, 41 AND 42. (U.S. CLS. 100, 101, 105 AND 107). REG. 6-24-1997.
- 2,075,589. ARTHROGEN-CIA. INT. CL. 1. (U.S. CLS. 1, 5, 6, 10, 26 AND 46). REG. 7-1-1997.
- 2,077,128. MINI MOTT'S. INT. CL. 32. (U.S. CLS. 45, 46 AND 48). REG. 7-8-1997.
- 2,077,193. GIVE WILDLIFE A BRAKE. INT. CL. 42. (U.S. CLS. 100 AND 101). REG. 7-8-1997.
- 2,078,717. BLP. INT. CL. 9. (U.S. CLS. 21, 23, 26, 36 AND 38). REG. 7-15-1997.
- 2,079,050. EZ-1 (STYLIZED). INT. CL. 7. (U.S. CLS. 13, 19, 21, 23, 31, 34 AND 35). REG. 7-15-1997.
- 2,080,550. DSS. INT. CL. 9. (U.S. CLS. 21, 23, 26, 36 AND 38). REG. 7-22-1997.
- 2,081,066. HUDSON'S GRILL AND DESIGN. INT. CL. 42. (U.S. CLS. 100 AND 101). REG. 7-22-1997.
- 2,082,169. POWER OF THE PURSE HYUNDAI AND DESIGN. INT. CL. 41. (U.S. CLS. 100, 101 AND 107). REG. 7-22-1997.
- 2,083,184. GAC AND DESIGN. INT. CLS. 36 AND 42. (U.S. CLS. 100, 101 AND 102). REG. 7-29-1997.
- 2,083,185. GEORGIA AGRIBUSINESS COUNCIL. INT. CLS. 36 AND 42. (U.S. CLS. 100, 101 AND 102). REG. 7-29-1997.
- 2,083,757. RAIN FOREST AQUACULTURE PRODUCTS. INT. CL. 29. (U.S. CL. 46). REG. 7-29-1997.
- 2,083,761. BIG TRAIN. INT. CL. 30. (U.S. CL. 46). REG. 7-29-1997.
- 2,084,078. NLJC. INT. CL. 41. (U.S. CLS. 100, 101 AND 107). REG. 7-29-1997.
- 2,084,767. CIATEQ AND DESIGN. INT. CL. 42. (U.S. CLS. 100 AND 101). REG. 7-29-1997.
- 2,085,037. FOX ANIMATION STUDIOS AND DESIGN. INT. CL. 41. (U.S. CLS. 100, 101 AND 107). REG. 7-29-1997.
- 2,085,276. DIGITAL EXPRESS. INT. CL. 42. (U.S. CLS. 100 AND 101). REG. 8-5-1997.
- 2,085,286. ZOUNDS!. INT. CL. 16. (U.S. CLS. 2, 5, 22, 23, 29, 37, 38 AND 50). REG. 8-5-1997.
- 2,085,349. THE BAG LADY AND DESIGN. INT. CL. 22. (U.S. CLS. 1, 2, 7, 19, 22, 42 AND 50). REG. 8-5-1997.
- 2,085,406. TORNADO MIXER. INT. CL. 7. (U.S. CLS. 13, 19, 21, 23, 31, 34 AND 35). REG. 8-5-1997.
- 2,085,835. TELEMAC. INT. CL. 9. (U.S. CLS. 21, 23, 26, 36 AND 38). REG. 8-5-1997.
- 2,085,861. GLOBALTRAN. INT. CL. 9. (U.S. CLS. 21, 23, 26, 36 AND 38). REG. 8-5-1997.
- 2,085,929. MONIC. INT. CL. 28. (U.S. CLS. 22, 23, 38 AND 50). REG. 8-5-1997.
- 2,086,000. GROVE. INT. CL. 36. (U.S. CLS. 100, 101 AND 102). REG. 8-5-1997.
- 2,086,063. HARRIS INSIGHT. INT. CL. 36. (U.S. CLS. 100, 101 AND 102). REG. 8-5-1997.
- 2,086,125. MISCELLANEOUS DESIGN. INT. CL. 21. (U.S. CLS. 2, 13, 23, 29, 30, 33, 40 AND 50). REG. 8-5-1997.
- 2,086,145. ANTIOXIDANT-PLUS. INT. CL. 3. (U.S. CLS. 1, 4, 6, 50, 51 AND 52). REG. 8-5-1997.
- 2,086,222. ARREZZIO. INT. CLS. 25, 29 AND 30 ONLY. (U.S. CLS. 22, 39 AND 46). REG. 8-5-1997.
- 2,086,250. PANITALY AND DESIGN. INT. CL. 30. (U.S. CL. 46). REG. 8-5-1997.
- 2,086,339. EPIPHANY SOFTWARE AND DESIGN. INT. CL. 9. (U.S. CLS. 21, 23, 26, 36 AND 38). REG. 8-5-1997.
- 2,086,416. WILD SEED. INT. CL. 16. (U.S. CLS. 2, 5, 22, 23, 29, 37, 38 AND 50). REG. 8-5-1997.
- 2,086,566. MARKET WISE PRODUCTS. INT. CL. 42. (U.S. CLS. 100 AND 101). REG. 8-5-1997.
- 2,086,746. TELENOR. INT. CL. 38. (U.S. CLS. 100, 101 AND 104). REG. 8-12-1997.
- 2,086,765. MINNESOTA'S BEST QUALITY BREWED LAGER AND DESIGN. INT. CL. 32. (U.S. CLS. 45, 46 AND 48). REG. 8-12-1997.
- 2,086,869. THE FRIDAY GROUP. INT. CLS. 35 AND 41. (U.S. CLS. 100, 101, 102 AND 107). REG. 8-12-1997.
- 2,086,902. MISCELLANEOUS DESIGN. INT. CLS. 18 AND 25. (U.S. CLS. 1, 2, 3, 22, 39 AND 41). REG. 8-12-1997.
- 2,086,905. SOGECASH. INT. CLS. 36 AND 38. (U.S. CLS. 100, 101, 102 AND 104). REG. 8-12-1997.
- 2,086,908. BOOK PASSAGE AND DESIGN. INT. CLS. 16 AND 41. (U.S. CLS. 2, 5, 22, 23, 29, 37, 38, 50, 100, 101 AND 107). REG. 8-12-1997.
- 2,086,968. EVENFLO (STYLIZED). INT. CL. 12. (U.S. CLS. 19, 21, 23, 31, 35 AND 44). REG. 8-12-1997.
- 2,087,030. PKF (STYLIZED). INT. CLS. 35 AND 36. (U.S. CLS. 100, 101 AND 102). REG. 8-12-1997.
- 2,087,031. PANNELL KERR FORSTER. INT. CLS. 35 AND 36. (U.S. CLS. 100, 101 AND 102). REG. 8-12-1997.
- 2,087,032. PANNELL KERR FORSTER (STYLIZED). INT. CLS. 35 AND 36. (U.S. CLS. 100, 101 AND 102). REG. 8-12-1997.
- 2,087,054. THEMES OF THE TIMES. INT. CL. 16. (U.S. CLS. 2, 5, 22, 23, 29, 37, 38 AND 50). REG. 8-12-1997.
- 2,087,142. VIBRASTOP. INT. CL. 17. (U.S. CLS. 1, 5, 12, 13, 35 AND 50). REG. 8-12-1997.
- 2,087,398. SINGULUS. INT. CL. 7. (U.S. CLS. 13, 19, 21, 23, 31, 34 AND 35). REG. 8-12-1997.
- 2,087,423. DEGAUSSATRON. INT. CL. 9. (U.S. CLS. 21, 23, 26, 36 AND 38). REG. 8-12-1997.
- 2,087,478. BARR-NUNN. INT. CL. 39. (U.S. CLS. 100 AND 105). REG. 8-12-1997.
- 2,087,556. SEAWATCH AND DESIGN. INT. CL. 29. (U.S. CL. 46). REG. 8-12-1997.
- 2,087,557. OLD SALT AND DESIGN. INT. CL. 29. (U.S. CL. 46). REG. 8-12-1997.
- 2,087,566. VIBRANT C. INT. CL. 32. (U.S. CLS. 45, 46 AND 48). REG. 8-12-1997.
- 2,087,801. FMC F. MCLINTOCKS TASTE THE GREAT AMERICAN WEST! AND DESIGN. INT. CL. 42. (U.S. CLS. 100 AND 101). REG. 8-12-1997.
- 2,087,859. W AND DESIGN. INT. CL. 25. (U.S. CLS. 22 AND 39). REG. 8-12-1997.
- 2,088,048. PROTEUS. INT. CL. 17. (U.S. CLS. 1, 5, 12, 13, 35 AND 50). REG. 8-12-1997.
- 2,088,053. ENCORE. INT. CL. 9. (U.S. CLS. 21, 23, 26, 36 AND 38). REG. 8-12-1997.

- 2,088,172. RAINBOW AND DESIGN. INT. CL. 41. (U.S. CLS. 100, 101 AND 107). REG. 8-12-1997.
- 2,088,406. C AND DESIGN. INT. CL. 25. (U.S. CLS. 22 AND 39). REG. 8-12-1997.
- 2,088,473. FORD AND DESIGN. INT. CL. 25. (U.S. CLS. 22 AND 39). REG. 8-19-1997.
- 2,088,483. JOHN GALLIANO AND DESIGN. INT. CL. 25. (U.S. CL. 39). REG. 8-19-1997.
- 2,088,609. ISLAND PACIFIC AND DESIGN. INT. CL. 29. (U.S. CL. 46). REG. 8-19-1997.
- 2,088,648. NORTHSTAR. INT. CL. 11. (U.S. CLS. 13, 21, 23, 31 AND 34). REG. 8-19-1997.
- 2,088,654. FORD AND DESIGN. INT. CL. 25. (U.S. CLS. 22 AND 39). REG. 8-19-1997.
- 2,088,678. PRAIRIE BREAD KITCHEN AND DESIGN. INT. CLS. 30 AND 42. (U.S. CLS. 46, 100 AND 101). REG. 8-19-1997.
- 2,088,686. TURNING LEAF AND DESIGN. INT. CL. 33. (U.S. CLS. 47 AND 49). REG. 8-19-1997.
- 2,088,705. NEWCOMB OIL CO. AND DESIGN. INT. CL. 42. (U.S. CLS. 100 AND 101). REG. 8-19-1997.
- 2,088,811. AVOCADO. INT. CL. 1. (U.S. CLS. 1, 5, 6, 10, 26 AND 46). REG. 8-19-1997.
- 2,088,823. EXCLUDER SEALS AND DESIGN. INT. CL. 17. (U.S. CLS. 1, 5, 12, 13, 35 AND 50). REG. 8-19-1997.
- 2,088,896. Y AND DESIGN. INT. CLS. 35 AND 42 ONLY. (U.S. CLS. 100, 101 AND 102). REG. 8-19-1997.
- 2,088,996. LIPTON AND DESIGN. INT. CL. 30. (U.S. CL. 46). REG. 8-19-1997.
- 2,089,126. FLAMAL. INT. CL. 1. (U.S. CLS. 1, 5, 6, 10, 26 AND 46). REG. 8-19-1997.
- 2,089,193. PEGASUS AIR EXPRESS INC. AND DESIGN. INT. CL. 39. (U.S. CLS. 100 AND 105). REG. 8-19-1997.
- 2,089,203. BLUE DELL. INT. CL. 29. (U.S. CL. 46). REG. 8-19-1997.
- 2,089,244. DUTCH COLONY. INT. CL. 29. (U.S. CL. 46). REG. 8-19-1997.
- 2,089,298. A ALTITUDE AND DESIGN. INT. CL. 25. (U.S. CLS. 22 AND 39). REG. 8-19-1997.
- 2,089,420. MUTLUKS. INT. CL. 18. (U.S. CLS. 1, 2, 3, 22 AND 41). REG. 8-19-1997.
- 2,089,422. RICH AND LEVY. INT. CL. 25. (U.S. CLS. 22 AND 39). REG. 8-19-1997.
- 2,089,528. A AND DESIGN. INT. CLS. 36, 39 AND 42 ONLY. (U.S. CLS. 100, 101, 102 AND 105). REG. 8-19-1997.
- 2,089,557. NEPTUNE. INT. CL. 13. (U.S. CLS. 2 AND 9). REG. 8-19-1997.
- 2,089,604. TECTRON. INT. CL. 6. (U.S. CLS. 2, 12, 13, 14, 23, 25 AND 50). REG. 8-19-1997.
- 2,089,824. LEARNINGEXPRESS AND DESIGN. INT. CL. 42. (U.S. CLS. 100 AND 101). REG. 8-19-1997.
- 2,089,904. SIGMA CAGE. INT. CL. 6. (U.S. CLS. 2, 12, 13, 14, 23, 25 AND 50). REG. 8-19-1997.
- 2,089,907. QUICK COOK. INT. CL. 29. (U.S. CL. 46). REG. 8-19-1997.
- 2,089,987. PARA-FLO. INT. CL. 11. (U.S. CLS. 13, 21, 23, 31 AND 34). REG. 8-19-1997.
- 2,090,170. CHIQUITA AND DESIGN. INT. CL. 32. (U.S. CLS. 45, 46 AND 48). REG. 8-19-1997.
- 2,090,171. FAMILY MANAGER. INT. CL. 16. (U.S. CLS. 2, 5, 22, 23, 29, 37, 38 AND 50). REG. 8-19-1997.
- 2,090,173. JADE MOUNTAIN. INT. CLS. 29 AND 30. (U.S. CL. 46). REG. 8-19-1997.
- 2,090,323. MISCELLANEOUS DESIGN. INT. CLS. 6 AND 20. (U.S. CLS. 2, 12, 13, 14, 22, 23, 25, 32 AND 50). REG. 8-26-1997.
- 2,090,377. MISCELLANEOUS DESIGN. INT. CLS. 9 AND 16. (U.S. CLS. 2, 5, 21, 22, 23, 26, 29, 36, 37, 38 AND 50). REG. 8-26-1997.
- 2,090,414. REBA. INT. CL. 16. (U.S. CLS. 2, 5, 22, 23, 29, 37, 38 AND 50). REG. 8-26-1997.
- 2,090,516. EL. INT. CL. 35. (U.S. CLS. 100, 101 AND 102). REG. 8-26-1997.
- 2,090,527. IN MEMORY OF SA MARTH GURU RAM CHANDRA JI MAHARAJ OF FATE GARH U.P. SHRI RAM CHANDRA MISSION SHAJAHANPUR U.P. AND DESIGN. INT. CL. 41. (U.S. CLS. 100, 101 AND 107). REG. 8-26-1997.
- 2,090,569. NEIGHBORHOOD WEATHER NET. INT. CL. 9. (U.S. CLS. 21, 23, 26, 36 AND 38). REG. 8-26-1997.
- 2,090,599. RAPP COLLINS WORLDWIDE. INT. CL. 35. (U.S. CLS. 100, 101 AND 102). REG. 8-26-1997.
- 2,090,629. RAPP COLLINS AND DESIGN. INT. CL. 35. (U.S. CLS. 100, 101 AND 102). REG. 8-26-1997.
- 2,090,698. THE COVE AT YARMOUTH AND DESIGN. INT. CL. 36. (U.S. CLS. 100, 101 AND 102). REG. 8-26-1997.
- 2,090,699. THIN & SLIM NATURALLY. INT. CL. 5. (U.S. CLS. 6, 18, 44, 46, 51 AND 52). REG. 8-26-1997.
- 2,090,702. CNB AND DESIGN. INT. CL. 36. (U.S. CLS. 100, 101 AND 102). REG. 8-26-1997.
- 2,090,706. YOU CAN STAND ON OUR REPUTATION. INT. CL. 19. (U.S. CLS. 1, 12, 33 AND 50). REG. 8-26-1997.
- 2,090,820. INTELLIKIDS. INT. CL. 5. (U.S. CLS. 6, 18, 44, 46, 51 AND 52). REG. 8-26-1997.
- 2,090,823. BIZMATCH (STYLIZED). INT. CL. 35. (U.S. CLS. 100, 101 AND 102). REG. 8-26-1997.
- 2,090,835. WYNNEWOOD. INT. CL. 21. (U.S. CLS. 2, 13, 23, 29, 30, 33, 40 AND 50). REG. 8-26-1997.
- 2,090,837. LUCERNE. INT. CL. 21. (U.S. CLS. 2, 13, 23, 29, 30, 33, 40 AND 50). REG. 8-26-1997.
- 2,090,839. BALLYLEE. INT. CL. 21. (U.S. CLS. 2, 13, 23, 29, 30, 33, 40 AND 50). REG. 8-26-1997.
- 2,090,928. SOURCE OCEAN (STYLIZED). INT. CL. 3. (U.S. CLS. 1, 4, 6, 50, 51 AND 52). REG. 8-26-1997.
- 2,090,933. GCPS MADE EASY. INT. CL. 16. (U.S. CLS. 2, 5, 22, 23, 29, 37, 38 AND 50). REG. 8-26-1997.
- 2,090,997. CODEXPRESS. INT. CL. 9. (U.S. CLS. 21, 23, 26, 36 AND 38). REG. 8-26-1997.
- 2,091,017. NATIONAL AUDUBON SOCIETY. INT. CL. 9. (U.S. CLS. 21, 23, 26, 36 AND 38). REG. 8-26-1997.
- 2,091,019. TIMBERFORM PALOMAR. INT. CL. 20. (U.S. CLS. 2, 13, 22, 25, 32 AND 50). REG. 8-26-1997.
- 2,091,025. SERIES IV (STYLIZED). INT. CL. 10. (U.S. CLS. 26, 39 AND 44). REG. 8-26-1997.
- 2,091,034. BARR-NUNN AND DESIGN. INT. CL. 39. (U.S. CLS. 100 AND 105). REG. 8-26-1997.
- 2,091,046. ULTRA FITS. INT. CL. 16. (U.S. CLS. 2, 5, 22, 23, 29, 37, 38 AND 50). REG. 8-26-1997.
- 2,091,056. LACTIL. INT. CL. 1. (U.S. CLS. 1, 5, 6, 10, 26 AND 46). REG. 8-26-1997.
- 2,091,090. FIRST ARRIVAL. INT. CL. 39. (U.S. CLS. 100 AND 105). REG. 8-26-1997.
- 2,091,092. TU (STYLIZED). INT. CLS. 14, 16, 25 AND 41. (U.S. CLS. 2, 5, 22, 23, 27, 28, 29, 37, 38, 39, 50, 100, 101 AND 107). REG. 8-26-1997.
- 2,091,143. NATIONAL FINALS RODEO. INT. CL. 25. (U.S. CLS. 22 AND 39). REG. 8-26-1997.
- 2,091,159. CARRABBA'S ITALIAN GRILL AND DESIGN. INT. CL. 25. (U.S. CLS. 22 AND 39). REG. 8-26-1997.
- 2,091,230. MISCELLANEOUS DESIGN. INT. CL. 42. (U.S. CLS. 100 AND 101). REG. 8-26-1997.
- 2,091,234. MISCELLANEOUS DESIGN. INT. CL. 36. (U.S. CLS. 100, 101 AND 102). REG. 8-26-1997.
- 2,091,282. SEROTEC. INT. CL. 1. (U.S. CLS. 1, 5, 6, 10, 26 AND 46). REG. 8-26-1997.
- 2,091,289. GRACELAND. INT. CL. 26. (U.S. CLS. 37, 39, 40, 42 AND 50). REG. 8-26-1997.
- 2,091,292. THINKCOLLEGE. INT. CL. 42. (U.S. CLS. 100 AND 101). REG. 8-26-1997.
- 2,091,299. PIKE PALE PALE ALE MALT HOPS AND DESIGN. INT. CL. 32. (U.S. CLS. 45, 46 AND 48). REG. 8-26-1997.
- 2,091,414. ETHOX. INT. CL. 10. (U.S. CLS. 26, 39 AND 44). REG. 8-26-1997.
- 2,091,444. TARGET HOUSE. INT. CL. 42. (U.S. CLS. 100 AND 101). REG. 8-26-1997.
- 2,091,506. SHOPPBS. INT. CL. 35. (U.S. CLS. 100, 101 AND 102). REG. 8-26-1997.
- 2,091,514. MISCELLANEOUS DESIGN. INT. CL. 1. (U.S. CLS. 1, 5, 6, 10, 26 AND 46). REG. 8-26-1997.
- 2,091,530. COORS FIELD. INT. CL. 16. (U.S. CLS. 2, 5, 22, 23, 29, 37, 38 AND 50). REG. 8-26-1997.
- 2,091,620. FOOTSMART. INT. CL. 25. (U.S. CLS. 22 AND 39). REG. 8-26-1997.
- 2,091,696. XTEND. INT. CL. 16. (U.S. CLS. 2, 5, 22, 23, 29, 37, 38 AND 50). REG. 8-26-1997.
- 2,091,728. QUEEN OF CLUBS TOURNAMENT. INT. CL. 41. (U.S. CLS. 100, 101 AND 107). REG. 8-26-1997.
- 2,091,729. QUEEN OF DIAMONDS TOURNAMENT. INT. CL. 41. (U.S. CLS. 100, 101 AND 107). REG. 8-26-1997.
- 2,091,731. AQUA MATTE. INT. CL. 2. (U.S. CLS. 6, 11 AND 16). REG. 8-26-1997.

- 2,091,760. IMPERIAL ISLE. INT. CL. 29. (U.S. CL. 46). REG. 8-26-1997.
- 2,091,878. INCENT (STYLIZED). INT. CL. 3. (U.S. CLS. 1, 4, 6, 50, 51 AND 52). REG. 8-26-1997.
- 2,091,895. COLUMBUS CREW. INT. CLS. 16, 25 AND 41. (U.S. CLS. 2, 5, 22, 23, 29, 37, 38, 39, 50, 100, 101 AND 107). REG. 8-26-1997.
- 2,091,908. FRANCHISOR OF CHOICE. INT. CL. 35. (U.S. CLS. 100, 101 AND 102). REG. 8-26-1997.
- 2,091,940. STARBUCKS. INT. CL. 30. (U.S. CL. 46). REG. 8-26-1997.
- 2,091,941. STARBUCKS COFFEE AND DESIGN. INT. CL. 30. (U.S. CL. 46). REG. 8-26-1997.
- 2,091,943. STEFANI. INT. CL. 33. (U.S. CLS. 47 AND 49). REG. 8-26-1997.
- 2,092,007. IT'S NOT DELIVERY IT'S DI GIORNO. INT. CL. 30. (U.S. CL. 46). REG. 8-26-1997.
- 2,092,048. GENETICA. INT. CL. 42. (U.S. CLS. 100 AND 101). REG. 8-26-1997.
- 2,092,055. COMPVENIENCE. INT. CL. 9. (U.S. CLS. 21, 23, 26, 36 AND 38). REG. 8-26-1997.
- 2,092,070. NOVA-VEYOR. INT. CL. 7. (U.S. CLS. 13, 19, 21, 23, 31, 34 AND 35). REG. 8-26-1997.
- 2,092,082. POWER HEADER. INT. CL. 19. (U.S. CLS. 1, 12, 33 AND 50). REG. 8-26-1997.
- 2,092,088. TOKEN-PIN. INT. CL. 28. (U.S. CLS. 22, 23, 38 AND 50). REG. 8-26-1997.
- 2,092,231. ELVIS THREADS. INT. CL. 42. (U.S. CLS. 100 AND 101). REG. 8-26-1997.
- 2,092,255. SAFEVIEW. INT. CL. 9. (U.S. CLS. 21, 23, 26, 36 AND 38). REG. 8-26-1997.
- 2,092,320. MISCELLANEOUS DESIGN. INT. CL. 1. (U.S. CLS. 1, 5, 6, 10, 26 AND 46). REG. 8-26-1997.
- 2,092,483. DECKEL. INT. CL. 7. (U.S. CLS. 13, 19, 21, 23, 31, 34 AND 35). REG. 9-2-1997.
- 2,092,554. EAGLE EYE. INT. CL. 42. (U.S. CLS. 100 AND 101). REG. 9-2-1997.
- 2,092,644. CPS. INT. CL. 41. (U.S. CLS. 100, 101 AND 107). REG. 9-2-1997.
- 2,092,907. THE PRIME SPOT. INT. CL. 35. (U.S. CLS. 100, 101 AND 102). REG. 9-2-1997.
- 2,092,923. THE COMPANY THE WHOLE WORLD WATCHES. INT. CL. 9. (U.S. CLS. 21, 23, 26, 36 AND 38). REG. 9-2-1997.
- 2,093,037. STATE STREET 1893 CHICAGO. INT. CL. 30. (U.S. CL. 46). REG. 9-2-1997.
- 2,093,113. THINK & DO. (STYLIZED). INT. CLS. 9 AND 41. (U.S. CLS. 21, 23, 26, 36, 38, 100, 101 AND 107). REG. 9-2-1997.
- 2,093,126. CATEPUT. INT. CL. 36. (U.S. CLS. 100, 101 AND 102). REG. 9-2-1997.
- 2,093,182. CRI INDOOR AIR QUALITY CARPET CUSHION TESTING PROGRAM AND DESIGN. U.S. CL. A. REG. 9-2-1997.
- 2,093,183. CRI INDOOR AIR QUALITY ADHESIVE TESTING PROGRAM AND DESIGN. U.S. CL. A. REG. 9-2-1997.
- 2,093,272. TEEN VOICES. INT. CL. 16. (U.S. CLS. 2, 5, 22, 23, 29, 37, 38 AND 50). REG. 9-2-1997.
- 2,093,386. PNM AND DESIGN. INT. CL. 35. (U.S. CLS. 100, 101 AND 102). REG. 9-2-1997.
- 2,093,424. IVORY MEX-TEX CLASSIC. INT. CL. 29. (U.S. CL. 46). REG. 9-2-1997.
- 2,093,425. JALAPENO MEX-TEX CLASSIC. INT. CL. 29. (U.S. CL. 46). REG. 9-2-1997.
- 2,093,442. MEX-TEX CLASSIC. INT. CL. 29. (U.S. CL. 46). REG. 9-2-1997.
- 2,093,455. KLEARWAY. INT. CL. 10. (U.S. CLS. 26, 39 AND 44). REG. 9-2-1997.
- 2,093,694. OUR DOG BLUE. INT. CL. 33. (U.S. CLS. 47 AND 49). REG. 9-2-1997.
- 2,093,722. ISOLUTIONS. INT. CL. 16. (U.S. CLS. 2, 5, 22, 23, 29, 37, 38 AND 50). REG. 9-2-1997.
- 2,093,831. MIDWEST MANUFACTURING. INT. CLS. 6, 40 AND 42. (U.S. CLS. 2, 12, 13, 14, 23, 25, 50, 100, 101, 103 AND 106). REG. 9-2-1997.
- 2,093,860. GREAT SOLITAIRE. INT. CL. 28. (U.S. CLS. 22, 23, 38 AND 50). REG. 9-2-1997.
- 2,093,892. LATIN AMERICA ENERGY. INT. CL. 35. (U.S. CLS. 100, 101 AND 102). REG. 9-2-1997.
- 2,093,932. PERSONAL TRAINER. INT. CL. 42. (U.S. CL. 100). REG. 9-9-1997.
- 2,093,964. MLP. INT. CL. 9. (U.S. CLS. 21, 23, 26, 36 AND 38). REG. 9-9-1997.
- 2,094,035. NFR PROFESSIONAL RODEO COWBOYS ASSOCIATION AND DESIGN. INT. CL. 25. (U.S. CLS. 22 AND 39). REG. 9-9-1997.
- 2,094,131. WENGER. INT. CLS. 14 AND 18. (U.S. CLS. 1, 2, 3, 22, 27, 28, 41 AND 50). REG. 9-9-1997.
- 2,094,175. MITSUBOSHI AND DESIGN. INT. CL. 8. (U.S. CLS. 23, 28 AND 44). REG. 9-9-1997.
- 2,094,273. D D AND DESIGN. INT. CLS. 16, 25 AND 41. (U.S. CLS. 2, 5, 22, 23, 29, 37, 38, 39, 50, 100, 101 AND 107). REG. 9-9-1997.
- 2,094,329. HOLLYWOOD STOCK EXCHANGE. INT. CL. 41. (U.S. CLS. 100, 101 AND 107). REG. 9-9-1997.
- 2,094,414. MISCELLANEOUS DESIGN. U.S. CL. A. REG. 9-9-1997.
- 2,094,477. INFO RAD AND DESIGN. INT. CL. 9. (U.S. CLS. 21, 23, 26, 36 AND 38). REG. 9-9-1997.
- 2,094,502. MEGA-CON-X. INT. CL. 9. (U.S. CLS. 21, 23, 26, 36 AND 38). REG. 9-9-1997.
- 2,094,510. DOCAS IN EIRE PEACE IN IRELAND AND DESIGN. INT. CL. 26. (U.S. CLS. 37, 39, 40, 42 AND 50). REG. 9-9-1997.
- 2,094,597. RUNNING P SADDLERY AND DESIGN. INT. CL. 18. (U.S. CLS. 1, 2, 3, 22 AND 41). REG. 9-9-1997.
- 2,094,664. THE FUTURE OF MUSIC. INT. CLS. 35 AND 41. (U.S. CLS. 100, 101, 102 AND 107). REG. 9-9-1997.
- 2,094,744. MUSIKWEB. INT. CL. 42. (U.S. CLS. 100 AND 101). REG. 9-9-1997.
- 2,094,755. BENDHEIM. INT. CL. 35. (U.S. CLS. 100, 101 AND 102). REG. 9-9-1997.
- 2,094,764. FIESTA BOWL. INT. CL. 41. (U.S. CLS. 100, 101 AND 107). REG. 9-9-1997.
- 2,094,781. AMBER. INT. CL. 42. (U.S. CLS. 100 AND 101). REG. 9-9-1997.
- 2,094,796. VALUTASK. INT. CL. 20. (U.S. CLS. 2, 13, 22, 25, 32 AND 50). REG. 9-9-1997.
- 2,094,911. ETHERFAST. INT. CL. 9. (U.S. CLS. 21, 23, 26, 36 AND 38). REG. 9-9-1997.
- 2,094,928. DIAMOND. INT. CL. 9. (U.S. CLS. 21, 23, 26, 36 AND 38). REG. 9-9-1997.
- 2,095,005. WHO OWNS WHAT (STYLIZED). INT. CL. 16. (U.S. CLS. 2, 5, 22, 23, 29, 37, 38 AND 50). REG. 9-9-1997.
- 2,095,029. MODERNICA. INT. CL. 20. (U.S. CLS. 2, 13, 22, 25, 32 AND 50). REG. 9-9-1997.
- 2,095,033. STONE SOLUTIONS. INT. CL. 19. (U.S. CLS. 1, 12, 33 AND 50). REG. 9-9-1997.
- 2,095,048. REAL STYLE FOR REAL LIFE. INT. CL. 35. (U.S. CLS. 100, 101 AND 102). REG. 9-9-1997.
- 2,095,080. NATURAL ALTERNATIVES. INT. CL. 5. (U.S. CLS. 6, 18, 44, 46, 51 AND 52). REG. 9-9-1997.
- 2,095,138. B.G.C MATRIX AND DESIGN. INT. CL. 5. (U.S. CLS. 6, 18, 44, 46, 51 AND 52). REG. 9-9-1997.
- 2,095,262. DATAQUICK. INT. CL. 42. (U.S. CLS. 100 AND 101). REG. 9-9-1997.
- 2,095,299. TELBOOK. INT. CL. 16. (U.S. CLS. 2, 5, 22, 23, 29, 37, 38 AND 50). REG. 9-9-1997.
- 2,095,307. AMERICAN TRADITION RESERVE FESS PARKER (STYLIZED). INT. CL. 33. (U.S. CLS. 47 AND 49). REG. 9-9-1997.
- 2,095,325. SAM THE HORSE. INT. CL. 16. (U.S. CLS. 2, 5, 22, 23, 29, 37, 38 AND 50). REG. 9-9-1997.
- 2,095,423. MISCELLANEOUS DESIGN. INT. CL. 25. (U.S. CLS. 22 AND 39). REG. 9-9-1997.
- 2,095,516. JAVA SONATA. INT. CL. 30. (U.S. CL. 46). REG. 9-9-1997.
- 2,095,681. THE RIGHT STUFF. INT. CL. 17. (U.S. CLS. 1, 5, 12, 13, 35 AND 50). REG. 9-9-1997.
- 2,095,749. SOL-U-WEB. INT. CL. 24. (U.S. CLS. 42 AND 50). REG. 9-9-1997.
- 2,095,766. YIELDGARD AND DESIGN. INT. CL. 31. (U.S. CLS. 1 AND 46). REG. 9-9-1997.
- 2,095,809. ULTRA PILE. INT. CL. 17. (U.S. CLS. 1, 5, 12, 13, 35 AND 50). REG. 9-9-1997.
- 2,095,979. CORRECTIONAL CLASSICS. INT. CL. 25. (U.S. CLS. 22 AND 39). REG. 9-9-1997.
- 2,095,980. QUIETZONE. INT. CL. 17. (U.S. CLS. 1, 5, 12, 13, 35 AND 50). REG. 9-9-1997.
- 2,096,089. LENGTH-TRAC. INT. CL. 9. (U.S. CLS. 21, 23, 26, 36 AND 38). REG. 9-9-1997.
- 2,096,155. GREAT ROOMS GUARANTEED. INT. CL. 42. (U.S. CLS. 100 AND 101). REG. 9-9-1997.
- 2,096,255. GRAND SOFT. INT. CL. 11. (U.S. CLS. 13, 21, 23, 31 AND 34). REG. 9-16-1997.

- 2,096,274. BEAMISH (STYLIZED). INT. CL. 32. (U.S. CL. 48). REG. 9-16-1997.
- 2,096,276. POWERFLEX. INT. CL. 28. (U.S. CL. 22). REG. 9-16-1997.
- 2,096,392. DAIKIN. INT. CL. 12. (U.S. CLS. 19, 21, 23, 31, 35 AND 44). REG. 9-16-1997.
- 2,096,440. CANTERBURY. INT. CLS. 6, 11, 21 AND 42. (U.S. CLS. 2, 12, 13, 14, 21, 23, 25, 29, 30, 31, 33, 34, 40, 50, 100 AND 101). REG. 9-16-1997.
- 2,096,546. 1-800-SOLDIER. INT. CL. 42. (U.S. CLS. 100 AND 101). REG. 9-16-1997.
- 2,096,579. MISCELLANEOUS DESIGN. INT. CL. 25. (U.S. CLS. 22 AND 39). REG. 9-16-1997.
- 2,096,645. CARROT TOP RECORDS. INT. CL. 9. (U.S. CLS. 21, 23, 26, 36 AND 38). REG. 9-16-1997.
- 2,096,705. FARCHIONI AND DESIGN. INT. CL. 29. (U.S. CL. 46). REG. 9-16-1997.
- 2,096,708. PARTY MIX AND DESIGN. INT. CL. 30. (U.S. CL. 46). REG. 9-16-1997.
- 2,096,814. STRAPACK. INT. CL. 7. (U.S. CLS. 13, 19, 21, 23, 31, 34 AND 35). REG. 9-16-1997.
- 2,096,839. WEB MEISTER AND DESIGN. INT. CL. 37. (U.S. CLS. 100, 103 AND 106). REG. 9-16-1997.
- 2,096,914. MULTI-CON-X. INT. CL. 9. (U.S. CLS. 21, 23, 26, 36 AND 38). REG. 9-16-1997.
- 2,097,302. KUBLER AND DESIGN. INT. CL. 9. (U.S. CLS. 21, 23, 26, 36 AND 38). REG. 9-16-1997.
- 2,097,303. APPLICAN. INT. CL. 21. (U.S. CLS. 2, 13, 23, 29, 30, 33, 40 AND 50). REG. 9-16-1997.
- 2,097,435. JOEY'S AND DESIGN. INT. CL. 42. (U.S. CLS. 100 AND 101). REG. 9-16-1997.
- 2,097,605. GOLDRICH FARMS. INT. CL. 29. (U.S. CL. 46). REG. 9-16-1997.
- 2,097,693. FISCH AND DESIGN. INT. CL. 8. (U.S. CLS. 23, 28 AND 44). REG. 9-16-1997.
- 2,097,703. SPECIAL RECIPE. INT. CL. 29. (U.S. CL. 46). REG. 9-16-1997.
- 2,097,845. WORRY FREE. INT. CL. 5. (U.S. CLS. 6, 18, 44, 46, 51 AND 52). REG. 9-16-1997.
- 2,097,982. TARNISH GUARD. INT. CL. 16. (U.S. CLS. 2, 5, 22, 23, 29, 37, 38 AND 50). REG. 9-16-1997.
- 2,098,109. TRACPHONE. INT. CL. 9. (U.S. CLS. 21, 23, 26, 36 AND 38). REG. 9-16-1997.
- 2,098,178. CHASTITY. INT. CL. 16. (U.S. CLS. 2, 5, 22, 23, 29, 37, 38 AND 50). REG. 9-16-1997.
- 2,098,326. LIGHTNING. INT. CL. 5. (U.S. CLS. 6, 18, 44, 46, 51 AND 52). REG. 9-16-1997.
- 2,098,690. MARGARITA MONDAYS. INT. CL. 42. (U.S. CLS. 100 AND 101). REG. 9-23-1997.
- 2,098,696. MISCELLANEOUS DESIGN. INT. CL. 9. (U.S. CLS. 21, 23, 26, 36 AND 38). REG. 9-23-1997.
- 2,098,746. ATTICUS. INT. CL. 36. (U.S. CLS. 100, 101 AND 102). REG. 9-23-1997.
- 2,098,811. CXA. INT. CL. 9. (U.S. CLS. 21, 23, 26, 36 AND 38). REG. 9-23-1997.
- 2,098,890. NAVARRO. INT. CL. 35. (U.S. CLS. 100, 101 AND 102). REG. 9-23-1997.
- 2,098,934. RUNNIN' RED WINGS. INT. CL. 41. (U.S. CLS. 100, 101 AND 107). REG. 9-23-1997.
- 2,098,944. DIET FREE SOLUTION. INT. CL. 41. (U.S. CLS. 100, 101 AND 107). REG. 9-23-1997.
- 2,099,097. DOUBLE QUICK (STYLIZED). INT. CLS. 37 AND 42. (U.S. CLS. 100, 101, 103 AND 106). REG. 9-23-1997.
- 2,099,171. THE BRANCH OFFICE (STYLIZED). INT. CLS. 9 AND 16. (U.S. CLS. 2, 5, 21, 22, 23, 26, 29, 36, 37, 38 AND 50). REG. 9-23-1997.
- 2,099,200. SECURITY. INT. CL. 16. (U.S. CLS. 2, 5, 22, 23, 29, 37, 38 AND 50). REG. 9-23-1997.
- 2,099,299. MELAMPO. INT. CLS. 30 AND 42 ONLY. (U.S. CLS. 46, 100 AND 101). REG. 9-23-1997.
- 2,099,355. MISCELLANEOUS DESIGN. INT. CL. 33. (U.S. CLS. 47 AND 49). REG. 9-23-1997.
- 2,099,464. EMERALD CLUB AND DESIGN. INT. CL. 29. (U.S. CL. 46). REG. 9-23-1997.
- 2,099,752. YANKEE TRADER. INT. CL. 35. (U.S. CLS. 100, 101 AND 102). REG. 9-23-1997.
- 2,099,833. TUFF TAB. INT. CL. 6. (U.S. CLS. 2, 12, 13, 14, 23, 25 AND 50). REG. 9-23-1997.
- 2,099,939. WORLD MOTOR. INT. CL. 7. (U.S. CLS. 13, 19, 21, 23, 31, 34 AND 35). REG. 9-23-1997.
- 2,099,952. OCEAN FOREST. INT. CL. 1. (U.S. CLS. 1, 5, 6, 10, 26 AND 46). REG. 9-23-1997.
- 2,100,103. HEALTH WISE. INT. CLS. 29 AND 30. (U.S. CL. 46). REG. 9-23-1997.
- 2,100,216. CELL REACH. INT. CL. 9. (U.S. CLS. 21, 23, 26, 36 AND 38). REG. 9-23-1997.
- 2,100,483. BUILT TO LAST A LIFETIME. INT. CL. 19. (U.S. CLS. 1, 12, 33 AND 50). REG. 9-23-1997.
- 2,100,579. MISCELLANEOUS DESIGN. INT. CL. 17. (U.S. CL. 12). REG. 9-30-1997.
- 2,100,692. BOSCH. INT. CL. 42. (U.S. CLS. 100 AND 101). REG. 9-30-1997.
- 2,100,809. ACCOUNTABLES (STYLIZED). INT. CLS. 35 AND 36. (U.S. CLS. 100, 101 AND 102). REG. 9-30-1997.
- 2,100,880. THE SPOTTED HERD. INT. CL. 25. (U.S. CLS. 22 AND 39). REG. 9-30-1997.
- 2,100,939. STANDARD INSURANCE COMPANY. INT. CL. 36. (U.S. CLS. 100, 101 AND 102). REG. 9-30-1997.
- 2,101,119. WEATHERLOCK. INT. CL. 19. (U.S. CLS. 1, 12, 33 AND 50). REG. 9-30-1997.
- 2,101,153. CYPRESS PHARMACEUTICAL, INC. AND DESIGN. INT. CL. 5. (U.S. CLS. 6, 18, 44, 46, 51 AND 52). REG. 9-30-1997.
- 2,101,257. ARCTIC SHIELD. INT. CL. 19. (U.S. CLS. 1, 12, 33 AND 50). REG. 9-30-1997.
- 2,101,351. BOULDER. INT. CL. 32. (U.S. CLS. 45, 46 AND 48). REG. 9-30-1997.
- 2,101,484. POWERBONE. INT. CL. 31. (U.S. CLS. 1 AND 46). REG. 9-30-1997.
- 2,101,580. STUDY POWER. INT. CL. 5. (U.S. CLS. 6, 18, 44, 46, 51 AND 52). REG. 9-30-1997.
- 2,101,581. FATIGUE FREE. INT. CL. 5. (U.S. CLS. 6, 18, 44, 46, 51 AND 52). REG. 9-30-1997.
- 2,101,582. FLU SEASON DEFENSE. INT. CL. 5. (U.S. CLS. 6, 18, 44, 46, 51 AND 52). REG. 9-30-1997.
- 2,101,583. RAJA'S CUP. INT. CL. 30. (U.S. CL. 46). REG. 9-30-1997.
- 2,101,696. IRRESISTIBLES. INT. CL. 25. (U.S. CLS. 22 AND 39). REG. 9-30-1997.
- 2,101,869. COOL MINT DROPS. INT. CL. 30. (U.S. CL. 46). REG. 9-30-1997.
- 2,101,872. ROUNDUP READY. INT. CL. 31. (U.S. CLS. 1 AND 46). REG. 9-30-1997.
- 2,101,964. OPT!. INT. CL. 9. (U.S. CLS. 21, 23, 26, 36 AND 38). REG. 9-30-1997.
- 2,102,026. ALLERNET. INT. CL. 42. (U.S. CLS. 100 AND 101). REG. 9-30-1997.
- 2,102,214. DURAVENT. INT. CL. 24. (U.S. CLS. 42 AND 50). REG. 9-30-1997.
- 2,102,279. BERGSTRIIP. INT. CL. 9. (U.S. CLS. 21, 23, 26, 36 AND 38). REG. 9-30-1997.
- 2,102,680. FINITA'S FANCIES SPOTTED BULL BBQ SAUCE BBQ SAUCE A GENTLE GIANT AND DESIGN. INT. CL. 30. (U.S. CL. 46). REG. 10-7-1997.
- 2,102,681. FINITA'S FANCIES BLAZING BULL BBQ SAUCE A GENTLE GIANT AND DESIGN. INT. CL. 30. (U.S. CL. 46). REG. 10-7-1997.
- 2,102,710. I.D.E.A.S. INVENTIVE DESIGNS FOR EDUCATION & THE ARTS AND DESIGN. INT. CL. 42. (U.S. CLS. 100 AND 101). REG. 10-7-1997.
- 2,102,864. NAVARRO. INT. CL. 3. (U.S. CLS. 1, 4, 6, 50, 51 AND 52). REG. 10-7-1997.
- 2,103,130. RUFLEX. INT. CL. 7. (U.S. CLS. 13, 19, 21, 23, 31, 34 AND 35). REG. 10-7-1997.
- 2,103,377. ORIENTAL FLOWER AND DESIGN. INT. CL. 30. (U.S. CL. 46). REG. 10-7-1997.
- 2,103,472. MXI. INT. CL. 10. (U.S. CLS. 26, 39 AND 44). REG. 10-7-1997.
- 2,103,526. MULTICOVER. INT. CL. 36. (U.S. CLS. 100, 101 AND 102). REG. 10-7-1997.
- 2,103,540. GEM. INT. CL. 31. (U.S. CLS. 1 AND 46). REG. 10-7-1997.
- 2,103,562. SAM THE HORSE AND DESIGN. INT. CL. 16. (U.S. CLS. 2, 5, 22, 23, 29, 37, 38 AND 50). REG. 10-7-1997.
- 2,103,631. DODGE & COX. INT. CL. 36. (U.S. CLS. 100, 101 AND 102). REG. 10-7-1997.
- 2,103,722. BASS. INT. CL. 10. (U.S. CLS. 26, 39 AND 44). REG. 10-7-1997.
- 2,104,228. TIRE JACK. INT. CL. 1. (U.S. CLS. 1, 5, 6, 10, 26 AND 46). REG. 10-7-1997.
- 2,104,575. MISCELLANEOUS DESIGN. INT. CL. 3. (U.S. CLS. 1, 4, 6, 50, 51 AND 52). REG. 10-14-1997.
- 2,105,371. MISCELLANEOUS DESIGN. INT. CLS. 29 AND 30. (U.S. CL. 46). REG. 10-14-1997.
- 2,105,496. GATES AND DESIGN. INT. CL. 30. (U.S. CL. 46). REG. 10-14-1997.

- 2,105,546. BEST WESTERN AND DESIGN. INT. CL. 42. (U.S. CLS. 100 AND 101). REG. 10-14-1997.
- 2,106,186. SAFETY-VAC. INT. CL. 7. (U.S. CLS. 13, 19, 21, 23, 31, 34 AND 35). REG. 10-21-1997.
- 2,106,303. SANDWORKS. INT. CL. 42. (U.S. CLS. 100 AND 101). REG. 10-21-1997.
- 2,106,324. HDC. INT. CL. 12. (U.S. CLS. 19, 21, 23, 31, 35 AND 44). REG. 10-21-1997.
- 2,107,104. WEBLON REGATTA AND DESIGN. INT. CL. 24. (U.S. CLS. 42 AND 50). REG. 10-21-1997.
- 2,107,467. PROPAGON. INT. CL. 42. (U.S. CLS. 100 AND 101). REG. 10-21-1997.
- 2,107,901. OGAMI. INT. CL. 9. (U.S. CLS. 21, 23, 26, 36 AND 38). REG. 10-21-1997.
- 2,107,911. TCM (STYLIZED). INT. CLS. 7 AND 12. (U.S. CLS. 13, 19, 21, 23, 31, 34, 35 AND 44). REG. 10-21-1997.
- 2,108,250. THE SAUCY COW'S GARDEN RELISH AND DESIGN. INT. CL. 30. (U.S. CL. 46). REG. 10-28-1997.
- 2,108,303. CAREER CONCEPTS FOR YOUTH AND DESIGN. INT. CL. 42. (U.S. CLS. 100 AND 101). REG. 10-28-1997.
- 2,108,592. STARFEST. INT. CL. 41. (U.S. CLS. 100, 101 AND 107). REG. 10-28-1997.
- 2,108,659. MISCELLANEOUS DESIGN. INT. CLS. 16 AND 41 ONLY. (U.S. CLS. 2, 5, 22, 23, 29, 37, 38, 50, 100, 101 AND 107). REG. 10-28-1997.
- 2,108,973. FISH FLASH. INT. CL. 28. (U.S. CLS. 22, 23, 38 AND 50). REG. 10-28-1997.
- 2,109,089. NATURAL NUTRITION CENTER AND DESIGN. INT. CL. 5. (U.S. CLS. 6, 18, 44, 46, 51 AND 52). REG. 10-28-1997.
- 2,109,158. SHORE-ALL. INT. CL. 6. (U.S. CLS. 2, 12, 13, 14, 23, 25 AND 50). REG. 10-28-1997.
- 2,110,190. ISCO. INT. CL. 9. (U.S. CLS. 21, 23, 26, 36 AND 38). REG. 11-4-1997.
- 2,110,311. MISCELLANEOUS DESIGN. INT. CL. 21. (U.S. CLS. 2, 13, 23, 29, 30, 33, 40 AND 50). REG. 11-4-1997.
- 2,110,576. UNIVERSITY OF KENTUCKY. INT. CLS. 16 AND 25. (U.S. CLS. 2, 5, 22, 23, 29, 37, 38, 39 AND 50). REG. 11-4-1997.
- 2,110,582. LIZARD. INT. CL. 8. (U.S. CLS. 23, 28 AND 44). REG. 11-4-1997.
- 2,110,868. FUZZY MOUSE. INT. CL. 28. (U.S. CLS. 22, 23, 38 AND 50). REG. 11-4-1997.
- 2,111,352. CHEMTAPE. INT. CL. 17. (U.S. CLS. 1, 5, 12, 13, 35 AND 50). REG. 11-4-1997.
- 2,111,485. PM ENGINEER. INT. CL. 16. (U.S. CLS. 2, 5, 22, 23, 29, 37, 38 AND 50). REG. 11-4-1997.
- 2,111,486. PROCESS HEATING. INT. CL. 16. (U.S. CLS. 2, 5, 22, 23, 29, 37, 38 AND 50). REG. 11-4-1997.
- 2,112,144. A ASPIRE AUTOMATED SYSTEM PROMOTING INCENTIVES THAT REWARD EXCELLENCE (STYLIZED). INT. CL. 9. (U.S. CLS. 21, 23, 26, 36 AND 38). REG. 11-11-1997.
- 2,112,407. WESTAR AND DESIGN. INT. CL. 31. (U.S. CLS. 1 AND 46). REG. 11-11-1997.
- 2,113,026. WHITECH. INT. CL. 17. (U.S. CLS. 1, 5, 12, 13, 35 AND 50). REG. 11-11-1997.
- 2,113,211. CONTEMPORARY STONE DESIGN. INT. CL. 16. (U.S. CLS. 2, 5, 22, 23, 29, 37, 38 AND 50). REG. 11-11-1997.
- 2,113,636. FERRARI. INT. CL. 7. (U.S. CLS. 13, 19, 21, 23, 31, 34 AND 35). REG. 11-18-1997.
- 2,113,646. DOLOMITE. INT. CL. 10. (U.S. CLS. 26, 39 AND 44). REG. 11-18-1997.
- 2,114,440. FLEXABALL. INT. CL. 28. (U.S. CLS. 22, 23, 38 AND 50). REG. 11-18-1997.
- 2,115,075. BON CHEF. INT. CL. 21. (U.S. CLS. 2, 13, 23, 29, 30, 33, 40 AND 50). REG. 11-25-1997.
- 2,115,148. PONY ESPRESSO AND DESIGN. INT. CL. 11. (U.S. CLS. 13, 21, 23, 31 AND 34). REG. 11-25-1997.
- 2,115,239. ISLAGUARD. INT. CL. 9. (U.S. CLS. 21, 23, 26, 36 AND 38). REG. 11-25-1997.
- 2,115,785. QUICKPORT. INT. CL. 9. (U.S. CLS. 21, 23, 26, 36 AND 38). REG. 11-25-1997.
- 2,115,998. KNOWLEDGE THROUGH VISION. INT. CL. 41. (U.S. CLS. 100, 101 AND 107). REG. 11-25-1997.
- 2,116,233. DIAMOND VOGEL. INT. CL. 2. (U.S. CLS. 6, 11 AND 16). REG. 11-25-1997.
- 2,116,301. SERVICETRACKER. INT. CL. 36. (U.S. CLS. 100, 101 AND 102). REG. 11-25-1997.
- 2,117,564. DOUBLEUP. INT. CL. 28. (U.S. CLS. 22, 23, 38 AND 50). REG. 12-2-1997.
- 2,117,829. FESS PARKER AND DESIGN. INT. CLS. 25, 33, 35 AND 42. (U.S. CLS. 22, 39, 47, 49, 100, 101 AND 102). REG. 12-2-1997.
- 2,118,406. AVENUE. INT. CLS. 20 AND 21. (U.S. CLS. 2, 13, 22, 23, 25, 29, 30, 32, 33, 40 AND 50). REG. 12-2-1997.
- 2,119,014. MM MIDWEST MANUFACTURING AND DESIGN. INT. CLS. 6, 40 AND 42. (U.S. CLS. 2, 12, 13, 14, 23, 25, 50, 100, 101, 103 AND 106). REG. 12-9-1997.
- 2,119,249. LAMINATIONS UNLIMITED AND DESIGN. INT. CL. 40. (U.S. CLS. 100, 103 AND 106). REG. 12-9-1997.
- 2,119,443. HYCURE. INT. CL. 5. (U.S. CLS. 6, 18, 44, 46, 51 AND 52). REG. 12-9-1997.
- 2,119,525. ALLIGATOR ADVENTURE. INT. CL. 41. (U.S. CLS. 100, 101 AND 107). REG. 12-9-1997.
- 2,119,860. AMARETTO. INT. CL. 41. (U.S. CLS. 100, 101 AND 107). REG. 12-9-1997.
- 2,119,923. IPC. INT. CL. 42. (U.S. CLS. 100 AND 101). REG. 12-9-1997.
- 2,120,755. DEL. INT. CL. 9. (U.S. CLS. 21, 23, 26, 36 AND 38). REG. 12-16-1997.
- 2,120,760. GENE CHECK. INT. CL. 1 ONLY. (U.S. CLS. 1, 5, 6, 10, 26 AND 46). REG. 12-16-1997.
- 2,120,910. ONE WORLD MUSIC. INT. CL. 41. (U.S. CLS. 100, 101 AND 107). REG. 12-16-1997.
- 2,121,116. THE GOOD FEET STORE AND DESIGN. INT. CL. 42. (U.S. CLS. 100 AND 101). REG. 12-16-1997.
- 2,121,976. INSEARCH. INT. CL. 35. (U.S. CLS. 100, 101 AND 102). REG. 12-16-1997.
- 2,122,168. DEVA AND DESIGN. INT. CL. 9. (U.S. CLS. 21, 23, 26, 36 AND 38). REG. 12-16-1997.
- 2,122,618. SPEEDO COUNT. INT. CL. 14. (U.S. CLS. 2, 27, 28 AND 50). REG. 12-23-1997.
- 2,122,721. BULL DOG POWER PRODUCTS. INT. CL. 11 ONLY. (U.S. CLS. 13, 21, 23, 31 AND 34). REG. 12-23-1997.
- 2,122,978. COLUMBIA FUNDS. INT. CL. 36. (U.S. CLS. 100, 101 AND 102). REG. 12-23-1997.
- 2,123,077. LUMENARC. INT. CL. 11. (U.S. CLS. 13, 21, 23, 31 AND 34). REG. 12-23-1997.
- 2,123,078. MISCELLANEOUS DESIGN. INT. CL. 11. (U.S. CLS. 13, 21, 23, 31 AND 34). REG. 12-23-1997.
- 2,123,114. COMPUTRAINER. INT. CL. 28. (U.S. CLS. 22, 23, 38 AND 50). REG. 12-23-1997.
- 2,123,167. SECUR-PULL. INT. CL. 17. (U.S. CLS. 1, 5, 12, 13, 35 AND 50). REG. 12-23-1997.
- 2,124,171. NATIONAL INSTITUTE ON MEDIA AND THE FAMILY. INT. CL. 16. (U.S. CLS. 2, 5, 22, 23, 29, 37, 38 AND 50). REG. 12-23-1997.
- 2,124,775. AIP. INT. CL. 7. (U.S. CLS. 13, 19, 21, 23, 31, 34 AND 35). REG. 12-30-1997.
- 2,124,863. ONE WORLD MUSIC AND DESIGN. INT. CL. 41. (U.S. CLS. 100, 101 AND 107). REG. 12-30-1997.
- 2,125,404. ALPS. INT. CL. 36. (U.S. CLS. 100, 101 AND 102). REG. 12-30-1997.
- 2,126,978. RAINIER. INT. CL. 32. (U.S. CLS. 45, 46 AND 48). REG. 1-6-1998.
- 2,127,317. CTX MORTGAGE COMPANY. INT. CL. 36. (U.S. CLS. 100, 101 AND 102). REG. 1-6-1998.
- 2,127,484. AAM AND DESIGN. INT. CL. 12. (U.S. CLS. 19, 21, 23, 31, 35 AND 44). REG. 1-6-1998.
- 2,128,172. HOSS. INT. CL. 37. (U.S. CLS. 100, 103 AND 106). REG. 1-13-1998.
- 2,128,188. DATASCOPE (STYLIZED). INT. CL. 9. (U.S. CLS. 21, 23, 26, 36 AND 38). REG. 1-13-1998.
- 2,128,529. THE ROM DANCE AND DESIGN. INT. CL. 9 ONLY. (U.S. CLS. 21, 23, 26, 36 AND 38). REG. 1-13-1998.
- 2,128,651. ROLY POLY ROLLED SANDWICHES. INT. CL. 42. (U.S. CLS. 100 AND 101). REG. 1-13-1998.
- 2,129,763. LIFE AT ITS BEST. INT. CL. 36. (U.S. CLS. 100, 101 AND 102). REG. 1-20-1998.
- 2,130,111. 3 LB AND DESIGN. INT. CL. 30. (U.S. CL. 46). REG. 1-20-1998.
- 2,131,160. KEY=SYS. INT. CL. 9. (U.S. CLS. 21, 23, 26, 36 AND 38). REG. 1-20-1998.
- 2,131,281. MAKE A FRIEND FOR LIFE. INT. CLS. 28 AND 35. (U.S. CLS. 22, 23, 38, 50, 100, 101 AND 102). REG. 1-20-1998.

- 2,131,919. D-BOX. INT. CL. 9. (U.S. CLS. 21, 23, 26, 36 AND 38). REG. 1-27-1998.
- 2,132,050. U.S. RUBBER RECYCLING. INT. CL. 27. (U.S. CLS. 19, 20, 37, 42 AND 50). REG. 1-27-1998.
- 2,132,624. MARBLOT. INT. CLS. 1 AND 5. (U.S. CLS. 1, 5, 6, 10, 18, 26, 44, 46, 51 AND 52). REG. 1-27-1998.
- 2,133,074. PERENNIALS. INT. CL. 4. (U.S. CLS. 1, 6 AND 15). REG. 1-27-1998.
- 2,133,458. BUILT-TO-ORDER. INT. CL. 42. (U.S. CLS. 100 AND 101). REG. 1-27-1998.
- 2,134,224. SOFT-WRAP. INT. CL. 10. (U.S. CLS. 26, 39 AND 44). REG. 2-3-1998.
- 2,134,267. PRO PREMIER. INT. CL. 28. (U.S. CLS. 22, 23, 38 AND 50). REG. 2-3-1998.
- 2,134,331. MPACT. INT. CL. 1. (U.S. CLS. 1, 5, 6, 10, 26 AND 46). REG. 2-3-1998.
- 2,134,677. TUF-TEX. INT. CL. 28. (U.S. CLS. 22, 23, 38 AND 50). REG. 2-3-1998.
- 2,134,679. SKATEBOARDING IS NOT A CRIME. INT. CL. 25. (U.S. CLS. 22 AND 39). REG. 2-3-1998.
- 2,134,855. KLEARPLAST. INT. CL. 2. (U.S. CLS. 6, 11 AND 16). REG. 2-3-1998.
- 2,134,983. MIMIC. INT. CL. 9. (U.S. CLS. 21, 23, 26, 36 AND 38). REG. 2-3-1998.
- 2,135,281. GRAND RAPIDS INDUSTRIAL PRODUCTS. INT. CLS. 7 AND 8. (U.S. CLS. 13, 19, 21, 23, 28, 31, 34, 35 AND 44). REG. 2-10-1998.
- 2,135,741. E-Z-GRAPH. INT. CL. 10. (U.S. CLS. 26, 39 AND 44). REG. 2-10-1998.
- 2,135,776. VEGI-DOPHILUS. INT. CL. 5. (U.S. CLS. 6, 18, 44, 46, 51 AND 52). REG. 2-10-1998.
- 2,136,034. T-PAK. INT. CL. 10. (U.S. CLS. 26, 39 AND 44). REG. 2-10-1998.
- 2,136,035. PERI-K. INT. CL. 10. (U.S. CLS. 26, 39 AND 44). REG. 2-10-1998.
- 2,136,036. T-PAK. INT. CL. 10. (U.S. CLS. 26, 39 AND 44). REG. 2-10-1998.
- 2,136,038. CHAIN LEADER. INT. CL. 16. (U.S. CLS. 2, 5, 22, 23, 29, 37, 38 AND 50). REG. 2-10-1998.
- 2,136,568. SCS. INT. CL. 39. (U.S. CLS. 100 AND 105). REG. 2-17-1998.
- 2,136,628. JUMPSTART TODDLERS. INT. CL. 9. (U.S. CLS. 21, 23, 26, 36 AND 38). REG. 2-17-1998.
- 2,136,682. JENISYS AND DESIGN. INT. CL. 9. (U.S. CLS. 21, 23, 26, 36 AND 38). REG. 2-17-1998.
- 2,136,841. PIZZA READY, TORTILLA TESTED. INT. CL. 29. (U.S. CL. 46). REG. 2-17-1998.
- 2,137,314. SAFE PLACE. INT. CL. 9. (U.S. CLS. 21, 23, 26, 36 AND 38). REG. 2-17-1998.
- 2,137,503. BUSTY BEAUTIES. INT. CL. 16. (U.S. CLS. 2, 5, 22, 23, 29, 37, 38 AND 50). REG. 2-17-1998.
- 2,137,534. SKATEBOARDING IS NOT A CRIME. INT. CL. 16. (U.S. CLS. 2, 5, 22, 23, 29, 37, 38 AND 50). REG. 2-17-1998.
- 2,137,728. E-MORTGAGE. INT. CL. 36. (U.S. CLS. 100, 101 AND 102). REG. 2-17-1998.
- 2,138,444. RALPHIE'S. INT. CL. 42. (U.S. CLS. 100 AND 101). REG. 2-24-1998.
- 2,138,611. SWIFT-WRAP. INT. CL. 10. (U.S. CLS. 26, 39 AND 44). REG. 2-24-1998.
- 2,138,854. QUIK-CALC. INT. CL. 9. (U.S. CLS. 21, 23, 26, 36 AND 38). REG. 2-24-1998.
- 2,139,597. MOUTH FRIENDLY. INT. CL. 10. (U.S. CLS. 26, 39 AND 44). REG. 2-24-1998.
- 2,141,043. ORCA BAY. INT. CL. 29. (U.S. CL. 46). REG. 3-3-1998.
- 2,141,247. UNIFLEX. INT. CL. 9. (U.S. CLS. 21, 23, 26, 36 AND 38). REG. 3-3-1998.
- 2,141,628. AQUA LIFE. INT. CL. 5. (U.S. CLS. 6, 18, 44, 46, 51 AND 52). REG. 3-3-1998.
- 2,142,612. DUKAL. INT. CL. 5. (U.S. CLS. 6, 18, 44, 46, 51 AND 52). REG. 3-10-1998.
- 2,142,662. RED HAT. INT. CLS. 9 AND 42. (U.S. CLS. 21, 23, 26, 36, 38, 100 AND 101). REG. 3-10-1998.
- 2,142,869. DYNAMIC STYLE ROTATION. INT. CL. 36. (U.S. CLS. 100, 101 AND 102). REG. 3-10-1998.
- 2,143,614. MARWI. INT. CLS. 11 AND 12 ONLY. (U.S. CLS. 13, 19, 21, 23, 31, 34, 35 AND 44). REG. 3-10-1998.
- 2,143,743. LITE DETANGLER. INT. CL. 3. (U.S. CLS. 1, 4, 6, 50, 51 AND 52). REG. 3-10-1998.
- 2,144,200. MORE THAN A METAL - IT'S A METHOD. INT. CL. 6. (U.S. CLS. 2, 12, 13, 14, 23, 25 AND 50). REG. 3-17-1998.
- 2,144,660. A MIND IS A TERRIBLE THING TO WASTE. INT. CL. 36. (U.S. CLS. 100, 101 AND 102). REG. 3-17-1998.
- 2,145,477. JADE TIARA. INT. CL. 31. (U.S. CLS. 1 AND 46). REG. 3-17-1998.
- 2,147,107. BARRIER ISLAND SPORTSWEAR AND DESIGN. INT. CL. 25. (U.S. CLS. 22 AND 39). REG. 3-31-1998.
- 2,147,163. AAAAI. INT. CLS. 16, 36, 41 AND 42. (U.S. CLS. 2, 5, 22, 23, 29, 37, 38, 50, 100, 101, 102 AND 107). REG. 3-31-1998.
- 2,148,523. CMC. INT. CLS. 6, 9, 22, 28 AND 35. (U.S. CLS. 1, 2, 7, 12, 13, 14, 19, 21, 22, 23, 25, 26, 36, 38, 42, 50, 100, 101 AND 102). REG. 4-7-1998.
- 2,148,696. BILL QUICK AND DESIGN. INT. CL. 9. (U.S. CLS. 21, 23, 26, 36 AND 38). REG. 4-7-1998.
- 2,148,755. AMERICAN ACADEMY OF ALLERGY, ASTHMA & IMMUNOLOGY. INT. CLS. 16, 36, 41 AND 42. (U.S. CLS. 2, 5, 22, 23, 29, 37, 38, 50, 100, 101, 102 AND 107). REG. 4-7-1998.
- 2,148,969. PERFECT VISION. INT. CL. 9. (U.S. CLS. 21, 23, 26, 36 AND 38). REG. 4-7-1998.
- 2,150,374. ALL KITCHENS (STYLIZED). INT. CL. 30. (U.S. CL. 46). REG. 4-14-1998.
- 2,150,836. NCS AND DESIGN. INT. CL. 3. (U.S. CLS. 1, 4, 6, 50, 51 AND 52). REG. 4-14-1998.
- 2,151,630. BOOMERANG GRILLE AND DESIGN. INT. CL. 42 ONLY. (U.S. CLS. 100 AND 101). REG. 4-21-1998.
- 2,152,435. AFE FACILITIES ENGINEERING JOURNAL. INT. CL. 16. (U.S. CLS. 2, 5, 22, 23, 29, 37, 38 AND 50). REG. 4-21-1998.
- 2,152,599. PMI. INT. CLS. 16 AND 42. (U.S. CLS. 2, 5, 22, 23, 29, 37, 38, 50, 100 AND 101). REG. 4-21-1998.
- 2,153,294. ADVANCES IN DENTAL RESEARCH. INT. CL. 16. (U.S. CLS. 2, 5, 22, 23, 29, 37, 38 AND 50). REG. 4-28-1998.
- 2,154,674. PRIME FOOD CORP. AND DESIGN. INT. CL. 30. (U.S. CL. 46). REG. 5-5-1998.
- 2,154,753. PNEUTORQUE. INT. CL. 7. (U.S. CLS. 13, 19, 21, 23, 31, 34 AND 35). REG. 5-5-1998.
- 2,157,292. MR. FREEZE. INT. CL. 28. (U.S. CLS. 22, 23, 38 AND 50). REG. 5-12-1998.
- 2,158,873. SHIFT-CLAUS. INT. CL. 1. (U.S. CLS. 1, 5, 6, 10, 26 AND 46). REG. 5-19-1998.
- 2,158,918. ULTRASPERSE THE COMPOUNDER'S CHOICE... (STYLIZED). INT. CL. 1. (U.S. CLS. 1, 5, 6, 10, 26 AND 46). REG. 5-19-1998.
- 2,159,038. IKA AND DESIGN. INT. CL. 14. (U.S. CLS. 2, 27, 28 AND 50). REG. 5-19-1998.
- 2,159,716. PRO TRENDS. INT. CL. 25. (U.S. CLS. 22 AND 39). REG. 5-19-1998.
- 2,160,020. SONG CHUAN. INT. CL. 9. (U.S. CLS. 21, 23, 26, 36 AND 38). REG. 5-26-1998.
- 2,160,515. ULTRASPERSE. INT. CL. 1. (U.S. CLS. 1, 5, 6, 10, 26 AND 46). REG. 5-26-1998.
- 2,160,972. MAYWOOD STUDIO. INT. CL. 24. (U.S. CLS. 42 AND 50). REG. 5-26-1998.
- 2,161,159. AAM AMERICAN AXLE & MANUFACTURING AND DESIGN. INT. CLS. 7 AND 12. (U.S. CLS. 13, 19, 21, 23, 31, 34, 35 AND 44). REG. 6-2-1998.
- 2,161,761. MISCELLANEOUS DESIGN. INT. CL. 42. (U.S. CLS. 100 AND 101). REG. 6-2-1998.
- 2,162,774. DEEPDOWN. INT. CL. 3. (U.S. CLS. 1, 4, 6, 50, 51 AND 52). REG. 6-2-1998.
- 2,162,819. THE ONLY ONE WHO PROFITS IS YOU. INT. CL. 42. (U.S. CLS. 100 AND 101). REG. 6-2-1998.
- 2,163,689. DISNEY DOLLARS. INT. CL. 16. (U.S. CLS. 2, 5, 22, 23, 29, 37, 38 AND 50). REG. 6-9-1998.
- 2,163,742. BLACK MARLIN AND DESIGN. INT. CLS. 35 AND 41. (U.S. CLS. 100, 101, 102 AND 107). REG. 6-9-1998.
- 2,163,904. R (STYLIZED). INT. CL. 7. (U.S. CLS. 13, 19, 21, 23, 31, 34 AND 35). REG. 6-9-1998.
- 2,164,222. E-LAW. INT. CL. 42. (U.S. CLS. 100 AND 101). REG. 6-9-1998.
- 2,164,555. POWERAISLE. INT. CL. 9. (U.S. CLS. 21, 23, 26, 36 AND 38). REG. 6-9-1998.
- 2,164,679. EMMA'S GARDEN. INT. CL. 25. (U.S. CLS. 22 AND 39). REG. 6-9-1998.
- 2,164,738. FIT SCIENCE AND DESIGN. INT. CL. 25. (U.S. CLS. 22 AND 39). REG. 6-9-1998.
- 2,165,065. 1-800-ITS-LEAN. INT. CL. 29. (U.S. CL. 46). REG. 6-16-1998.

- 2,165,842. MARTIN'S. INT. CL. 35. (U.S. CLS. 100, 101 AND 102). REG. 6-16-1998.
- 2,166,423. FLPATENT. INT. CL. 42. (U.S. CLS. 100 AND 101). REG. 6-16-1998.
- 2,166,496. ELYSE (STYLIZED). INT. CL. 9. (U.S. CLS. 21, 23, 26, 36 AND 38). REG. 6-16-1998.
- 2,166,535. AMLACTIN. INT. CL. 5. (U.S. CLS. 6, 18, 44, 46, 51 AND 52). REG. 6-16-1998.
- 2,166,538. READYBATH. INT. CL. 5. (U.S. CLS. 6, 18, 44, 46, 51 AND 52). REG. 6-16-1998.
- 2,166,935. 101 AND DESIGN. INT. CL. 30. (U.S. CL. 46). REG. 6-23-1998.
- 2,167,391. REFRESH TEARS. INT. CL. 5. (U.S. CLS. 6, 18, 44, 46, 51 AND 52). REG. 6-23-1998.
- 2,167,515. METEX. INT. CL. 1. (U.S. CLS. 1, 5, 6, 10, 26 AND 46). REG. 6-23-1998.
- 2,167,569. IL BUCO. INT. CLS. 35 AND 42. (U.S. CLS. 100, 101 AND 102). REG. 6-23-1998.
- 2,167,811. WALKING PARTNERS. INT. CL. 41. (U.S. CLS. 100, 101 AND 107). REG. 6-23-1998.
- 2,167,988. GL 350. INT. CL. 6. (U.S. CLS. 2, 12, 13, 14, 23, 25 AND 50). REG. 6-23-1998.
- 2,168,005. ART MANIA. INT. CL. 9. (U.S. CLS. 21, 23, 26, 36 AND 38). REG. 6-23-1998.
- 2,168,567. MARSHALL. INT. CL. 8. (U.S. CLS. 23, 28 AND 44). REG. 6-23-1998.
- 2,168,875. PRO-PAK. INT. CL. 13. (U.S. CLS. 2 AND 9). REG. 6-30-1998.
- 2,169,139. AAPER ALCOHOL. INT. CL. 1. (U.S. CLS. 1, 5, 6, 10, 26 AND 46). REG. 6-30-1998.
- 2,169,161. THE CLEAR LEADER. INT. CL. 1. (U.S. CLS. 1, 5, 6, 10, 26 AND 46). REG. 6-30-1998.
- 2,169,375. PARTY PLUS WAREHOUSE AND DESIGN. INT. CL. 35. (U.S. CLS. 100, 101 AND 102). REG. 6-30-1998.
- 2,169,698. RANCHERO. INT. CL. 29. (U.S. CL. 46). REG. 6-30-1998.
- 2,169,782. KENTWOOD SPRINGS. INT. CL. 32. (U.S. CLS. 45, 46 AND 48). REG. 6-30-1998.
- 2,169,946. RAILRECORDER. INT. CL. 9. (U.S. CLS. 21, 23, 26, 36 AND 38). REG. 6-30-1998.
- 2,170,458. PERFECTLY SUITED. INT. CL. 25. (U.S. CLS. 22 AND 39). REG. 6-30-1998.
- 2,170,820. J.A.S.F. JUST ANOTHER STINKIN' FOUNTAIN. INT. CL. 13. (U.S. CLS. 2 AND 9). REG. 7-7-1998.
- 2,170,889. ARTISTIC STONE AND DESIGN. INT. CL. 19. (U.S. CLS. 1, 12, 33 AND 50). REG. 7-7-1998.
- 2,170,992. SIGMAKER. INT. CL. 9. (U.S. CLS. 21, 23, 26, 36 AND 38). REG. 7-7-1998.
- 2,171,264. LADY GODIVA'S. INT. CL. 42 ONLY. (U.S. CLS. 100 AND 101). REG. 7-7-1998.
- 2,172,318. SONG CHUAN AND DESIGN. INT. CL. 9. (U.S. CLS. 21, 23, 26, 36 AND 38). REG. 7-14-1998.
- 2,172,423. WASHINGTON'S BEST MUSICIANS. INT. CL. 41. (U.S. CLS. 100, 101 AND 107). REG. 7-14-1998.
- 2,172,652. ION SPORT AND DESIGN. INT. CL. 9. (U.S. CLS. 21, 23, 26, 36 AND 38). REG. 7-14-1998.
- 2,172,840. BLENDZ. INT. CL. 42. (U.S. CLS. 100 AND 101). REG. 7-14-1998.
- 2,172,897. ATEB. INT. CL. 42. (U.S. CLS. 100 AND 101). REG. 7-14-1998.
- 2,173,537. WESTERN HEALTH ADVANTAGE. INT. CL. 42. (U.S. CLS. 100 AND 101). REG. 7-14-1998.
- 2,173,994. TRANSPORT (STYLIZED). INT. CL. 32. (U.S. CLS. 45, 46 AND 48). REG. 7-14-1998.
- 2,174,367. SPORTS OHIO. INT. CL. 41. (U.S. CLS. 100, 101 AND 107). REG. 7-21-1998.
- 2,174,942. OMNIGOLD. INT. CL. 2. (U.S. CLS. 6, 11 AND 16). REG. 7-21-1998.
- 2,175,121. THE BOOK VINE FOR CHILDREN AND DESIGN. INT. CL. 35. (U.S. CLS. 100, 101 AND 102). REG. 7-21-1998.
- 2,176,476. MOTHER'S MILK. INT. CL. 5. (U.S. CLS. 6, 18, 44, 46, 51 AND 52). REG. 7-28-1998.
- 2,176,477. PREGNANCY. INT. CL. 5. (U.S. CLS. 6, 18, 44, 46, 51 AND 52). REG. 7-28-1998.
- 2,176,703. PARTNERS IN PROGRESS. INT. CLS. 16 AND 38. (U.S. CLS. 2, 5, 22, 23, 29, 37, 38, 50, 100, 101 AND 104). REG. 7-28-1998.
- 2,176,722. SPLIT SECOND 2. INT. CL. 7. (U.S. CLS. 13, 19, 21, 23, 31, 34 AND 35). REG. 7-28-1998.
- 2,176,857. AVVENTURA. INT. CL. 33. (U.S. CLS. 47 AND 49). REG. 7-28-1998.
- 2,176,859. SUNCLOUD. INT. CL. 9. (U.S. CLS. 21, 23, 26, 36 AND 38). REG. 7-28-1998.
- 2,176,998. FRACTION ISLANDS. INT. CL. 28. (U.S. CLS. 22, 23, 38 AND 50). REG. 7-28-1998.
- 2,177,009. EMPRESS. INT. CL. 25. (U.S. CLS. 22 AND 39). REG. 7-28-1998.
- 2,177,037. SMARTMONEY. INT. CL. 42. (U.S. CLS. 100 AND 101). REG. 7-28-1998.
- 2,177,242. TRAVELSENSE. INT. CL. 9. (U.S. CLS. 21, 23, 26, 36 AND 38). REG. 7-28-1998.
- 2,177,647. JOURNAL OF INTERACTIVE MARKETING. INT. CL. 16. (U.S. CLS. 2, 5, 22, 23, 29, 37, 38 AND 50). REG. 7-28-1998.
- 2,177,708. MISCELLANEOUS DESIGN. INT. CL. 6. (U.S. CLS. 2, 12, 13, 14, 23, 25 AND 50). REG. 8-4-1998.
- 2,178,124. GEODES. INT. CL. 9. (U.S. CLS. 21, 23, 26, 36 AND 38). REG. 8-4-1998.
- 2,178,562. MISCELLANEOUS DESIGN. INT. CL. 28. (U.S. CLS. 22, 23, 38 AND 50). REG. 8-4-1998.
- 2,178,925. MIAMI JR. INT. CL. 10. (U.S. CLS. 26, 39 AND 44). REG. 8-4-1998.
- 2,180,139. CARNETT'S, INC.. INT. CL. 37. (U.S. CLS. 100, 103 AND 106). REG. 8-11-1998.
- 2,180,439. CHRISTIANET. INT. CL. 35. (U.S. CLS. 100, 101 AND 102). REG. 8-11-1998.
- 2,180,736. NORTHWEST NATURAL. INT. CL. 29. (U.S. CL. 46). REG. 8-11-1998.
- 2,181,243. FOX AND DESIGN. INT. CL. 25. (U.S. CLS. 22 AND 39). REG. 8-11-1998.
- 2,181,469. AQUAZOID AND DESIGN. INT. CL. 41. (U.S. CLS. 100, 101 AND 107). REG. 8-11-1998.
- 2,181,603. MISCELLANEOUS DESIGN. INT. CL. 6. (U.S. CLS. 2, 12, 13, 14, 23, 25 AND 50). REG. 8-11-1998.
- 2,183,132. MISCELLANEOUS DESIGN. INT. CL. 30. (U.S. CL. 46). REG. 8-18-1998.
- 2,183,152. SUPPLY CHAIN MANAGEMENT REVIEW. INT. CL. 16. (U.S. CLS. 2, 5, 22, 23, 29, 37, 38 AND 50). REG. 8-18-1998.
- 2,184,075. KIDALIN. INT. CL. 5. (U.S. CLS. 6, 18, 44, 46, 51 AND 52). REG. 8-25-1998.
- 2,184,533. MAGIC IN THE MIRROR. INT. CL. 9. (U.S. CLS. 21, 23, 26, 36 AND 38). REG. 8-25-1998.

* * * * *

TRADEMARK REGISTRATIONS CANCELED

The designation "U.S. Cl." appearing in this section refers to the U.S. class in effect prior to Sep. 1, 1973 rather than the international class which applies to applications filed on or after that date. For adoption of international classification see notice in the OFFICIAL GAZETTE of Jun. 26, 1973 (911 O.G. TM 210).

SECTION 7(D)

- 1,012,598. THE COMPASS. U.S. CL. 38. REG. 6-3-1975.
2,256,720. WHY GUY. INT. CL. 41. REG. 6-29-1999.
2,642,899. BUY OR SELL ALMOST ANYTHING ON EARTH. INT. CL. 35. REG. 10-29-2002.
2,902,361. ARTHUR'S FRESH MARKET. INT. CL. 35. REG. 11-9-2004.
2,916,899. Z ZWIESEL GLAS AND DESIGN. INT. CL. 21. REG. 1-11-2005.
2,921,067. EMERSON STORAGE SOLUTIONS. INT. CLS. 6, 9, 12, 20 AND 21. REG. 1-25-2005.
3,006,851. ZWIESEL AND DESIGN. INT. CL. 21. REG. 10-18-2005.
3,058,072. M GOOD ON YA AND DESIGN. INT. CL. 25. REG. 2-7-2006.
3,127,863. T TACIT NETWORKS AND DESIGN. INT. CL. 9. REG. 8-8-2006.
3,156,557. CHERRIES GONE WILDSTANDARD CHARACTER MARK INT. CL. 9. REG. 10-17-2006.
3,174,850. ON THE GO ESSENTIALSSTANDARD CHARACTER MARK INT. CLS. 3 AND 5. REG. 11-21-2006.
3,197,301. ON THE GO ESSENTIALS AND DESIGN. INT. CLS. 3 AND 5. REG. 1-9-2007.
3,274,304. FLIP THE SCRIPTSTANDARD CHARACTER MARK INT. CL. 41. REG. 8-7-2007.

SECTION 8

- 341,211. GOLD LABEL (STYLIZED). U.S. CL. 46. REG. 12-1-1936.
1,078,504. POCAHONTAS AMERICA'S FIRST LADY OF FOOD SERVICE AND DESIGN. INT. CLS. 30 AND 32 ONLY. REG. 11-29-1977.
1,388,721. MICHELLE. INT. CL. 3. REG. 4-8-1986.
1,418,806. ATF. INT. CLS. 1 AND 4. REG. 12-2-1986.
1,418,809. EUROFLUOR S. INT. CL. 1. REG. 12-2-1986.
1,418,813. KRC. INT. CLS. 1 AND 3. REG. 12-2-1986.
1,418,818. NUTRALIME. INT. CL. 1. REG. 12-2-1986.
1,418,821. PROOF PLUS. INT. CL. 1. REG. 12-2-1986.
1,418,822. PROOF FLASH. INT. CL. 1. REG. 12-2-1986.
1,418,826. CRS. INT. CL. 1. REG. 12-2-1986.
1,418,827. REPROSCAN. INT. CL. 1. REG. 12-2-1986.
1,418,831. POLYBILT. INT. CL. 1. REG. 12-2-1986.
1,418,832. UCARMAG. INT. CL. 1. REG. 12-2-1986.
1,418,834. MEQEM. INT. CL. 1. REG. 12-2-1986.
1,418,838. CHEKIT. INT. CL. 2. REG. 12-2-1986.
1,418,844. RIGHT-STEP. INT. CL. 2. REG. 12-2-1986.
1,418,852. JUST DESSERTS. INT. CL. 3. REG. 12-2-1986.
1,418,863. SAY NAY TO GREY. INT. CL. 3. REG. 12-2-1986.
1,418,875. VITA-TREAT. INT. CL. 3. REG. 12-2-1986.
1,418,883. DOWNY TC. INT. CL. 3. REG. 12-2-1986.
1,418,888. B-FREE OF FLIES. INT. CL. 5. REG. 12-2-1986.
1,418,899. LASTOBAND. INT. CL. 5. REG. 12-2-1986.
1,418,900. TOXIMMUNE. INT. CL. 5. REG. 12-2-1986.
1,418,902. FREEFORM AND DESIGN. INT. CL. 5. REG. 12-2-1986.
1,418,904. RAZOR NIK + AID. INT. CL. 5. REG. 12-2-1986.
1,418,905. COMMAND ULTRAFINE. INT. CL. 5. REG. 12-2-1986.
1,418,916. PILLAROUND (STYLIZED). INT. CL. 5. REG. 12-2-1986.
1,418,917. OXYDENT. INT. CL. 5. REG. 12-2-1986.
1,418,920. VARITON. INT. CL. 5. REG. 12-2-1986.
1,418,926. TEFCO. INT. CL. 6. REG. 12-2-1986.
1,418,928. SENCOTE AND DESIGN. INT. CL. 6. REG. 12-2-1986.
1,418,931. MOW-PUMP. INT. CL. 7. REG. 12-2-1986.
1,418,933. MAGNUM. INT. CL. 7. REG. 12-2-1986.
1,418,935. STEMCO AND DESIGN. INT. CLS. 7 AND 9. REG. 12-2-1986.
1,418,936. TFB. INT. CL. 7. REG. 12-2-1986.
1,418,937. MISCELLANEOUS DESIGN. INT. CL. 7. REG. 12-2-1986.
1,418,939. MAXI-FLEX AND DESIGN. INT. CL. 7. REG. 12-2-1986.
1,418,940. HIBON AND DESIGN. INT. CL. 7. REG. 12-2-1986.
1,418,946. MTI. INT. CL. 7. REG. 12-2-1986.
1,418,948. EASY-EMPTY. INT. CL. 7. REG. 12-2-1986.
1,418,958. BENDMASTER. INT. CL. 7. REG. 12-2-1986.
1,418,961. LEVITATOR. INT. CL. 7. REG. 12-2-1986.
1,418,963. PAR-MATE. INT. CL. 7. REG. 12-2-1986.
1,418,964. EAGLE-EYE. INT. CL. 8. REG. 12-2-1986.
1,418,972. MICROHOST. INT. CL. 9. REG. 12-2-1986.
1,418,977. HD AMERICA, INC. AND DESIGN. INT. CL. 9. REG. 12-2-1986.
1,418,979. ESTIMATOR'S WORKBENCH. INT. CL. 9. REG. 12-2-1986.
1,418,987. LAWTOMATION. INT. CL. 9. REG. 12-2-1986.
1,418,990. POLYCHROM. INT. CL. 9. REG. 12-2-1986.
1,418,994. VITAFIBER. INT. CL. 9. REG. 12-2-1986.
1,419,003. BEYMA AND DESIGN. INT. CL. 9. REG. 12-2-1986.
1,419,006. AVANTEK AND DESIGN. INT. CL. 9. REG. 12-2-1986.
1,419,009. CAF. INT. CL. 9. REG. 12-2-1986.
1,419,011. TDI AND DESIGN. INT. CL. 9. REG. 12-2-1986.
1,419,013. PROFIT IQ. INT. CL. 9. REG. 12-2-1986.
1,419,015. K*PAK. INT. CL. 9. REG. 12-2-1986.
1,419,019. STORM AND DESIGN. INT. CL. 9. REG. 12-2-1986.
1,419,027. DIAMOND. INT. CL. 9. REG. 12-2-1986.
1,419,028. DYNAVIS. INT. CL. 9. REG. 12-2-1986.
1,419,040. RAIN DATE. INT. CL. 9. REG. 12-2-1986.
1,419,041. CT6. INT. CL. 9. REG. 12-2-1986.
1,419,045. SOFTSHELL AND DESIGN. INT. CL. 9. REG. 12-2-1986.
1,419,047. SMARTCHART. INT. CL. 9. REG. 12-2-1986.
1,419,055. ENVIROTRAK. INT. CL. 9. REG. 12-2-1986.
1,419,058. N2020 (STYLIZED). INT. CL. 9. REG. 12-2-1986.
1,419,061. DICTAMATIC. INT. CL. 9. REG. 12-2-1986.
1,419,062. MVP. INT. CL. 9. REG. 12-2-1986.
1,419,065. FIN LOCK. INT. CL. 10. REG. 12-2-1986.
1,419,071. MISCELLANEOUS DESIGN. INT. CL. 10. REG. 12-2-1986.
1,419,075. AUTO-TRAC. INT. CL. 10. REG. 12-2-1986.
1,419,076. NEUROAID 3.5 (STYLIZED). INT. CL. 10. REG. 12-2-1986.
1,419,077. SQUIBB. INT. CL. 10. REG. 12-2-1986.

- 1,419,083. FOAMFIT. INT. CL. 10. REG. 12-2-1986.
 1,419,086. K AND DESIGN. INT. CL. 11. REG. 12-2-1986.
 1,419,091. S AND DESIGN. INT. CL. 11. REG. 12-2-1986.
 1,419,095. BROADLUME. INT. CL. 11. REG. 12-2-1986.
 1,419,096. STRONG ARM (STYLIZED). INT. CL. 12. REG. 12-2-1986.
 1,419,097. HD AMERICA, INC. AND DESIGN. INT. CL. 12. REG. 12-2-1986.
 1,419,098. PRESTO. INT. CL. 12. REG. 12-2-1986.
 1,419,104. CORDOVAN. INT. CLS. 12 AND 17. REG. 12-2-1986.
 1,419,105. PUT-R-TAK (STYLIZED). INT. CL. 12. REG. 12-2-1986.
 1,419,107. FIORI. INT. CL. 12. REG. 12-2-1986.
 1,419,110. FXT (STYLIZED). INT. CL. 12. REG. 12-2-1986.
 1,419,113. AUTO KING. INT. CL. 12. REG. 12-2-1986.
 1,419,114. GRANT AND DESIGN. INT. CL. 12. REG. 12-2-1986.
 1,419,115. CROSS COUNTRY. INT. CL. 12. REG. 12-2-1986.
 1,419,117. FRAM FLEET-CARE F AND DESIGN. INT. CL. 12. REG. 12-2-1986.
 1,419,135. PROSPEC. INT. CL. 14. REG. 12-2-1986.
 1,419,136. XL (STYLIZED). INT. CL. 15. REG. 12-2-1986.
 1,419,143. CERTIFIED PROFESSIONAL LANDMAN LEASE AND DESIGN. INT. CL. 16. REG. 12-2-1986.
 1,419,151. MY L.I.F.E. MY LIFE'S INFORMATION FOR EMERGENCY AND DESIGN. INT. CL. 16. REG. 12-2-1986.
 1,419,154. FACES THE MAGAZINE ABOUT PEOPLE (STYLIZED). INT. CL. 16. REG. 12-2-1986.
 1,419,159. CPC AND DESIGN. INT. CL. 16. REG. 12-2-1986.
 1,419,170. HOME & ROAD. INT. CL. 16. REG. 12-2-1986.
 1,419,173. MISCELLANEOUS DESIGN. INT. CL. 16. REG. 12-2-1986.
 1,419,175. EPRI THESAURUS. INT. CL. 16. REG. 12-2-1986.
 1,419,179. D AND DESIGN. INT. CL. 17. REG. 12-2-1986.
 1,419,183. RAUMILK. INT. CL. 17. REG. 12-2-1986.
 1,419,189. MISCELLANEOUS DESIGN. INT. CLS. 18 AND 24. REG. 12-2-1986.
 1,419,194. THE INTELLIGENT WINDOW SUNGATE COATED GLASS AND DESIGN. INT. CL. 19. REG. 12-2-1986.
 1,419,197. ELASTOPRENE (STYLIZED). INT. CL. 19. REG. 12-2-1986.
 1,419,199. MAX. INT. CL. 19. REG. 12-2-1986.
 1,419,201. "D"-CRETE. INT. CL. 19. REG. 12-2-1986.
 1,419,204. INSUL-BRICK. INT. CL. 19. REG. 12-2-1986.
 1,419,205. ARTRAN. INT. CL. 19. REG. 12-2-1986.
 1,419,210. NHP NATIONAL HOME PRODUCTS AND DESIGN. INT. CL. 20. REG. 12-2-1986.
 1,419,216. METROPOLITAN. INT. CL. 20. REG. 12-2-1986.
 1,419,218. OCTOPUS. INT. CL. 21. REG. 12-2-1986.
 1,419,239. TDF. INT. CL. 24. REG. 12-2-1986.
 1,419,241. MISCELLANEOUS DESIGN. INT. CL. 25. REG. 12-2-1986.
 1,419,245. ESPRIT DE CORP.. INT. CL. 25. REG. 12-2-1986.
 1,419,247. GROVE (STYLIZED). INT. CL. 25. REG. 12-2-1986.
 1,419,251. G.A.L.S. GREAT AMERICAN LEG STYLES AND DESIGN. INT. CL. 25. REG. 12-2-1986.
 1,419,256. MC ROYAL (STYLIZED). INT. CL. 25. REG. 12-2-1986.
 1,419,262. WHAT A ZOO!. INT. CL. 25. REG. 12-2-1986.
 1,419,266. LILLILAND (STYLIZED). INT. CL. 25. REG. 12-2-1986.
 1,419,273. STACEY MICHAELS. INT. CL. 25. REG. 12-2-1986.
 1,419,280. SHE'S SASSY AND DESIGN. INT. CL. 25. REG. 12-2-1986.
 1,419,284. GILBERTO UOMO AND DESIGN. INT. CL. 25. REG. 12-2-1986.
 1,419,285. BED & BREAKFAST. INT. CL. 25. REG. 12-2-1986.
 1,419,290. WAIST WARRIOR. INT. CL. 25. REG. 12-2-1986.
 1,419,293. CATTLE KATE. INT. CL. 25. REG. 12-2-1986.
 1,419,301. MELANIE MCQUADE. INT. CL. 25. REG. 12-2-1986.
 1,419,302. ULTRA-THERM. INT. CL. 25. REG. 12-2-1986.
 1,419,305. FUZZBUSTERS. INT. CL. 25. REG. 12-2-1986.
 1,419,308. IT'S REALLY ME. INT. CL. 25. REG. 12-2-1986.
 1,419,310. CARPE DIEM CUEILLE LE JOUR AND DESIGN. INT. CL. 26. REG. 12-2-1986.
 1,419,312. STAR-TRON. INT. CL. 27. REG. 12-2-1986.
 1,419,313. WOOLCRAFT. INT. CL. 27. REG. 12-2-1986.
 1,419,316. WILDWOOD INTERNATIONAL. INT. CL. 28. REG. 12-2-1986.
 1,419,318. DOUBLE CIRCLE. INT. CL. 28. REG. 12-2-1986.
 1,419,321. FUZZY WUZZY. INT. CL. 28. REG. 12-2-1986.
 1,419,328. PUPPETOON (STYLIZED). INT. CL. 28. REG. 12-2-1986.
 1,419,330. A QUESTION OF SCRUPLES AND DESIGN. INT. CL. 28. REG. 12-2-1986.
 1,419,338. WALZO. INT. CL. 28. REG. 12-2-1986.
 1,419,348. PRESERVES BY/PAR EMELIA AND DESIGN. INT. CL. 29. REG. 12-2-1986.
 1,419,354. LA BIGORNE AND DESIGN. INT. CL. 29. REG. 12-2-1986.
 1,419,356. PILGRIM FARMS, INC.. INT. CLS. 29 AND 30. REG. 12-2-1986.
 1,419,358. KING COTTON AND DESIGN. INT. CL. 29. REG. 12-2-1986.
 1,419,360. VALLEY ORCHARD. INT. CL. 29. REG. 12-2-1986.
 1,419,361. VEAL VEAL CONNECTION CORP. AND DESIGN. INT. CL. 29. REG. 12-2-1986.
 1,419,370. AMERICAN EAGLE AND DESIGN. INT. CL. 30. REG. 12-2-1986.
 1,419,378. COUNTRYSIDE. INT. CL. 30. REG. 12-2-1986.
 1,419,380. CRAZY BOB'S. INT. CL. 30. REG. 12-2-1986.
 1,419,381. BLASTING POWDER (STYLIZED). INT. CL. 30. REG. 12-2-1986.
 1,419,387. SUGAR BABY. INT. CL. 31. REG. 12-2-1986.
 1,419,391. TWIN PALMS RANCH. INT. CL. 31. REG. 12-2-1986.
 1,419,408. I'M DRIVING CLUB. U.S. CLS. 200, 100 AND 101. REG. 12-2-1986.
 1,419,413. MEDEXTRA. INT. CL. 35. REG. 12-2-1986.
 1,419,415. WSI WESTON SERVICES, INC. AND DESIGN. INT. CL. 35. REG. 12-2-1986.
 1,419,417. THE COOLIDGE COMPANY, INC. (STYLIZED). INT. CLS. 35 AND 36. REG. 12-2-1986.
 1,419,418. MESSAGE ALERT. INT. CLS. 35 AND 38. REG. 12-2-1986.
 1,419,421. IPS AND DESIGN. INT. CL. 35. REG. 12-2-1986.
 1,419,426. COUPON ACCURATE. INT. CL. 35. REG. 12-2-1986.
 1,419,432. HAGEMEYER GROUP AND DESIGN. INT. CL. 36. REG. 12-2-1986.
 1,419,443. NEW LIFE SERIES I. INT. CL. 36. REG. 12-2-1986.
 1,419,445. LIBRARY OF HOMES. INT. CL. 36. REG. 12-2-1986.
 1,419,452. DOVER WATCH. INT. CL. 36. REG. 12-2-1986.
 1,419,463. MCI MAIL SCRIPTS. INT. CL. 38. REG. 12-2-1986.
 1,419,464. ICONTACT. INT. CLS. 38 AND 42. REG. 12-2-1986.
 1,419,465. KGO. INT. CL. 38. REG. 12-2-1986.
 1,419,473. MISCELLANEOUS DESIGN. INT. CL. 39. REG. 12-2-1986.
 1,419,480. BULKMODAL. INT. CL. 39. REG. 12-2-1986.
 1,419,484. PAKPRINT. INT. CL. 40. REG. 12-2-1986.
 1,419,485. CVS TODAY'S NEIGHBORHOOD DRUG STORE. INT. CLS. 40 AND 42. REG. 12-2-1986.
 1,419,487. CLI COMMUNICATION AND LEARNING INNOVATORS, LTD. AND DESIGN. INT. CL. 41. REG. 12-2-1986.
 1,419,488. CINE-MED INC. AND DESIGN. INT. CL. 41. REG. 12-2-1986.
 1,419,499. NATION'S BUSINESS TODAY. INT. CL. 41. REG. 12-2-1986.
 1,419,501. K AND DESIGN. INT. CL. 41. REG. 12-2-1986.
 1,419,507. WORD OF FAITH SATELLITE SEMINARS. INT. CL. 41. REG. 12-2-1986.
 1,419,515. DRAGON SYSTEMS. INT. CL. 42. REG. 12-2-1986.
 1,419,517. CIRCLE R AND DESIGN. INT. CL. 42. REG. 12-2-1986.
 1,419,522. VELOCE 500 AND DESIGN. INT. CL. 42. REG. 12-2-1986.
 1,419,523. WAREHOUSE CLUB. INT. CL. 42. REG. 12-2-1986.
 1,419,525. IME IMPARTIALITY CREDIBILITY AND DESIGN. INT. CL. 42. REG. 12-2-1986.

- 1,419,532. ELHILL. INT. CL. 42. REG. 12-2-1986.
 1,419,533. LLS (STYLIZED). INT. CL. 42. REG. 12-2-1986.
 1,419,534. A AN ABBEY GROUP HOTEL AND DESIGN. INT. CL. 42. REG. 12-2-1986.
 1,419,535. GROUP PLAN AND DESIGN. INT. CL. 42. REG. 12-2-1986.
 1,419,537. BMH AND DESIGN. INT. CL. 42. REG. 12-2-1986.
 1,419,538. M AND DESIGN. INT. CL. 42. REG. 12-2-1986.
 1,419,545. NEW SPIRIT. INT. CL. 42. REG. 12-2-1986.
 1,419,546. POSTSCRIPT AND DESIGN. INT. CL. 42. REG. 12-2-1986.
 1,419,552. EVERYTHING BUT W-A-T-E-R AND DESIGN. INT. CL. 42. REG. 12-2-1986.
 1,419,563. C COLOR CONTROL AND DESIGN. INT. CL. 42. REG. 12-2-1986.
 1,419,567. IMMUNE MAINTENANCE FORMULA. INT. CL. 5. REG. 12-2-1986.
 1,419,568. MONTHLY MAINTENANCE AND DESIGN. INT. CL. 5. REG. 12-2-1986.
 1,419,574. PC-PEDAL. INT. CL. 9. REG. 12-2-1986.
 1,419,575. MICRO POWER SYSTEMS. INT. CL. 9. REG. 12-2-1986.
 1,419,578. ONE TOUCH AND DESIGN. INT. CL. 9. REG. 12-2-1986.
 1,419,580. MW SPICE. INT. CL. 9. REG. 12-2-1986.
 1,419,581. MICROWAVE SPICE. INT. CL. 9. REG. 12-2-1986.
 1,419,586. ROBERTS BALUN. INT. CL. 9. REG. 12-2-1986.
 1,419,589. E-Z SAMPLER. INT. CL. 9. REG. 12-2-1986.
 1,419,590. KECK. INT. CL. 9. REG. 12-2-1986.
 1,419,594. SATIN ART. INT. CL. 16. REG. 12-2-1986.
 1,419,603. FRUIT SWEET. INT. CL. 32. REG. 12-2-1986.
 1,419,615. TURNKEY PRO. INT. CL. 42. REG. 12-2-1986.
 1,455,215. MV (STYLIZED). INT. CL. 16 ONLY. REG. 9-1-1987.
 1,461,664. ACROWOOD. INT. CL. 9 ONLY. REG. 10-20-1987.
 1,489,558. DEVAULT FOODS. INT. CL. 29 ONLY. REG. 5-24-1988.
 1,962,480. MINDMATTERS AND DESIGN. INT. CL. 16. REG. 3-12-1996.
 1,976,304. LIFEQUEST. INT. CL. 16. REG. 5-28-1996.
 2,020,082. PINNACLE PEAK PATIO. INT. CL. 42. REG. 12-3-1996.
 2,020,088. WININSTANT AND DESIGN. INT. CL. 9. REG. 12-3-1996.
 2,020,092. TELE-FRIEND. INT. CL. 38. REG. 12-3-1996.
 2,020,093. AIWA (STYLIZED). INT. CL. 37. REG. 12-3-1996.
 2,020,101. LYCAL. INT. CL. 1. REG. 12-3-1996.
 2,020,104. MBNA MARKETING SYSTEMS AND DESIGN. INT. CL. 36. REG. 12-3-1996.
 2,020,105. THE HOUGH GROUP OF FUNDS. INT. CL. 36. REG. 12-3-1996.
 2,020,109. MISCELLANEOUS DESIGN. INT. CL. 11. REG. 12-3-1996.
 2,020,113. POWER MACINTOSH. INT. CL. 16. REG. 12-3-1996.
 2,020,120. MARVIN K.. INT. CL. 25. REG. 12-3-1996.
 2,020,125. DOGGIE BAG AND DESIGN. INT. CL. 18. REG. 12-3-1996.
 2,020,133. WE FIX TRANSMISSIONS ONE THANK YOU AT A TIME. INT. CL. 37. REG. 12-3-1996.
 2,020,144. CDS. INT. CL. 42. REG. 12-3-1996.
 2,020,145. HEARTY PORTIONS. INT. CLS. 29 AND 30. REG. 12-3-1996.
 2,020,159. 3CR12 CROMWELD AND DESIGN. INT. CL. 6. REG. 12-3-1996.
 2,020,162. HICELL (STYLIZED). INT. CL. 7. REG. 12-3-1996.
 2,020,164. ————— -MOVIE AND DESIGN. INT. CL. 41. REG. 12-3-1996.
 2,020,166. THE SPAGHETTI SHOP AND DESIGN. INT. CL. 42. REG. 12-3-1996.
 2,020,171. KILLER BEEF AND DESIGN. INT. CL. 42. REG. 12-3-1996.
 2,020,176. ENDOTAK DSP. INT. CL. 10. REG. 12-3-1996.
 2,020,177. LAW ENGINEERING AND ENVIRONMENTAL SERVICES AND DESIGN. INT. CL. 42. REG. 12-3-1996.
 2,020,178. COUNTRY MUSIC SERIES. INT. CL. 36. REG. 12-3-1996.
 2,020,181. IARCH AND DESIGN. INT. CL. 16. REG. 12-3-1996.
 2,020,182. STARDEM COUNTDOWN CALENDAR AND DESIGN. INT. CL. 9. REG. 12-3-1996.
 2,020,183. COPYSHOP. INT. CL. 9. REG. 12-3-1996.
 2,020,195. BETHLEHEM. INT. CL. 6. REG. 12-3-1996.
 2,020,205. INFOZAP. INT. CL. 9. REG. 12-3-1996.
 2,020,208. MCCOY INC.. INT. CLS. 36, 37, 39 AND 42. REG. 12-3-1996.
 2,020,212. PURPOM. INT. CL. 33. REG. 12-3-1996.
 2,020,213. MAX RACKS AND DESIGN. INT. CL. 35. REG. 12-3-1996.
 2,020,214. CAFE ESPRESSO AND DESIGN. INT. CL. 42. REG. 12-3-1996.
 2,020,223. CM&J CURTIS, MURPHY & JEFFREYS, LLP AND DESIGN. INT. CL. 35. REG. 12-3-1996.
 2,020,247. DARE TO CARE AOK ACTS OF KINDNESS AND DESIGN. INT. CL. 42. REG. 12-3-1996.
 2,020,248. COLORADO'S FAVORITE SKI RESORT (STYLIZED). INT. CLS. 25 AND 41. REG. 12-3-1996.
 2,020,249. HERMOSA. INT. CL. 11. REG. 12-3-1996.
 2,020,282. WIN AGAINST BREAST CANCER. INT. CL. 42. REG. 12-3-1996.
 2,020,296. MIROVIDEO. INT. CL. 9. REG. 12-3-1996.
 2,020,308. MISCELLANEOUS DESIGN. INT. CL. 42. REG. 12-3-1996.
 2,020,331. LINE GUARD. INT. CL. 37. REG. 12-3-1996.
 2,020,332. MISCELLANEOUS DESIGN. INT. CL. 42. REG. 12-3-1996.
 2,020,349. TENDER READY AND DESIGN. INT. CL. 29. REG. 12-3-1996.
 2,020,368. DPCS. INT. CL. 9. REG. 12-3-1996.
 2,020,409. SSTV FILTERS. INT. CL. 11. REG. 12-3-1996.
 2,020,419. TLC. INT. CL. 9. REG. 12-3-1996.
 2,020,428. MISCELLANEOUS DESIGN. INT. CL. 37. REG. 12-3-1996.
 2,020,431. MARK BIRLEY (STYLIZED). INT. CL. 3. REG. 12-3-1996.
 2,020,435. YOU'LL LOVE SAM'S BAGELS SAM'S BAGELS AND DESIGN. INT. CL. 42. REG. 12-3-1996.
 2,020,437. SHIMANO SILENT CLUTCH. INT. CL. 12. REG. 12-3-1996.
 2,020,441. TRICKMASTER. INT. CL. 9. REG. 12-3-1996.
 2,020,450. LEGENDS OF COMEDY. INT. CL. 41. REG. 12-3-1996.
 2,020,452. R RAYMOND AND DESIGN. INT. CLS. 37 AND 42. REG. 12-3-1996.
 2,020,482. NORTHERN GOOSE AND DESIGN. INT. CL. 29. REG. 12-3-1996.
 2,020,483. SAGE INTERACTIVE. INT. CL. 41. REG. 12-3-1996.
 2,020,489. MORGAN SPUR. INT. CL. 31. REG. 12-3-1996.
 2,020,500. IPAC INTEGRATED PACKAGING ASSEMBLY CORPORATION PACKAGING FOUNDRY AND DESIGN. INT. CL. 40. REG. 12-3-1996.
 2,020,513. NURSERY PRO. INT. CL. 19. REG. 12-3-1996.
 2,020,518. VILLAGE TAVERN AND DESIGN. INT. CL. 42. REG. 12-3-1996.
 2,020,519. GAMBONI RANCH. INT. CL. 33. REG. 12-3-1996.
 2,020,531. PRO VET. INT. CL. 31. REG. 12-3-1996.
 2,020,533. SIDEMA. INT. CLS. 24 AND 25. REG. 12-3-1996.
 2,020,535. TLC. INT. CL. 16. REG. 12-3-1996.
 2,020,536. MISCELLANEOUS DESIGN. INT. CL. 35. REG. 12-3-1996.
 2,020,561. CRACKER BARREL BREAKFAST IN THE COUNTRY AND DESIGN. INT. CL. 42. REG. 12-3-1996.
 2,020,562. CRACKER BARREL GOOD COUNTRY COOKIN' AND DESIGN. INT. CL. 42. REG. 12-3-1996.
 2,020,563. AFAA FITNESS PRACTITIONER AND DESIGN. INT. CL. 41. REG. 12-3-1996.
 2,020,567. MR. HERO AND DESIGN. INT. CL. 42. REG. 12-3-1996.
 2,020,573. WINGMASTER. INT. CL. 12. REG. 12-3-1996.
 2,020,586. SUPERKEROIL. INT. CL. 31. REG. 12-3-1996.
 2,020,607. THE WAFFLE SPOT AND DESIGN. INT. CL. 42. REG. 12-3-1996.

- 2,020,609. ELLIPSY AND DESIGN. INT. CL. 9. REG. 12-3-1996.
- 2,020,613. ACCUSCORE XL. INT. CL. 9. REG. 12-3-1996.
- 2,020,620. SECURESOFTE. INT. CL. 9. REG. 12-3-1996.
- 2,020,629. AMELIA'S FIELD (STYLIZED). INT. CL. 42. REG. 12-3-1996.
- 2,020,642. KNOWLEDGE INDUSTRIES. INT. CL. 9. REG. 12-3-1996.
- 2,020,643. TASTEFULLY YOURS...FROM PERDUE. INT. CL. 16. REG. 12-3-1996.
- 2,020,658. PAT. INT. CL. 9. REG. 12-3-1996.
- 2,020,659. MONEYSHIELD 2. INT. CL. 36. REG. 12-3-1996.
- 2,020,668. SCRATCH SAFE. INT. CL. 35. REG. 12-3-1996.
- 2,020,670. WOODSCAPE. INT. CLS. 16 AND 28. REG. 12-3-1996.
- 2,020,692. DESTINATION CONSERVATION. INT. CL. 41. REG. 12-3-1996.
- 2,020,703. SFI. INT. CL. 42. REG. 12-3-1996.
- 2,020,704. MISCELLANEOUS DESIGN. INT. CL. 42. REG. 12-3-1996.
- 2,020,705. LANI. INT. CL. 37. REG. 12-3-1996.
- 2,020,708. NAILBOMB. INT. CL. 9. REG. 12-3-1996.
- 2,020,720. IVIS. INT. CL. 9. REG. 12-3-1996.
- 2,020,726. P730C. INT. CL. 6. REG. 12-3-1996.
- 2,020,731. TUTOR. INT. CL. 20. REG. 12-3-1996.
- 2,020,732. MECA. INT. CL. 9. REG. 12-3-1996.
- 2,020,734. EB. INT. CL. 20. REG. 12-3-1996.
- 2,020,735. THERE IS NO ALTERNATIVE. INT. CL. 38. REG. 12-3-1996.
- 2,020,736. MYM. INT. CL. 9. REG. 12-3-1996.
- 2,020,738. THE ONLY ALTERNATIVE. INT. CL. 38. REG. 12-3-1996.
- 2,020,745. A COMPUTET AND DESIGN. INT. CL. 16. REG. 12-3-1996.
- 2,020,750. DIRECTLY FROM THE HEART. INT. CL. 16. REG. 12-3-1996.
- 2,020,759. SAFETY CHAIN. INT. CL. 35. REG. 12-3-1996.
- 2,020,777. PLUS USA AND DESIGN. INT. CL. 20. REG. 12-3-1996.
- 2,020,780. PARENTSOURCE. INT. CL. 16. REG. 12-3-1996.
- 2,020,781. ORDERS PLUS. INT. CL. 9. REG. 12-3-1996.
- 2,020,788. GALIC MILLENNIA SERIES. INT. CL. 36. REG. 12-3-1996.
- 2,020,799. KARATS AND DESIGN. INT. CL. 42. REG. 12-3-1996.
- 2,020,800. SPRINGTIME IN ATLANTA. INT. CL. 41. REG. 12-3-1996.
- 2,020,804. HOSPITALITY FEDERAL CREDIT UNION AND DESIGN. INT. CL. 36. REG. 12-3-1996.
- 2,020,815. TED PROHASKA AND DESIGN. INT. CL. 37. REG. 12-3-1996.
- 2,020,819. VRZ (STYLIZED). INT. CL. 9. REG. 12-3-1996.
- 2,020,821. HR/PC. INT. CL. 16. REG. 12-3-1996.
- 2,020,832. THE MISSION. INT. CL. 20. REG. 12-3-1996.
- 2,020,839. CREATIVE BUILDING CENTRE. INT. CL. 42. REG. 12-3-1996.
- 2,020,848. BUNS & THIGHS OF STEEL. INT. CL. 9. REG. 12-3-1996.
- 2,020,864. HOME RUN HAIRCUTS. INT. CL. 42. REG. 12-3-1996.
- 2,020,873. PERFECT SUN. INT. CL. 3. REG. 12-3-1996.
- 2,020,883. TRAIN EXPRESS. INT. CL. 42. REG. 12-3-1996.
- 2,020,918. RACE-TRAX. INT. CL. 9. REG. 12-3-1996.
- 2,020,929. BLACK GOLD. INT. CL. 16. REG. 12-3-1996.
- 2,020,938. THE CONSUMER CONNECTION. INT. CL. 35. REG. 12-3-1996.
- 2,020,941. ISES. INT. CL. 35. REG. 12-3-1996.
- 2,020,949. COLDWELL BANKER CB ONLINE AND DESIGN. INT. CL. 36. REG. 12-3-1996.
- 2,020,954. MISCELLANEOUS DESIGN. INT. CL. 20. REG. 12-3-1996.
- 2,020,958. USA GROUP TUITION PAYMENT PLANS. INT. CL. 36. REG. 12-3-1996.
- 2,020,961. KILGOUR, FRENCH & STANBURY (STYLIZED). INT. CL. 25. REG. 12-3-1996.
- 2,020,964. USA GROUP LOAN SERVICES. INT. CL. 36. REG. 12-3-1996.
- 2,020,965. AUDITFORCE. INT. CL. 35. REG. 12-3-1996.
- 2,020,980. DEPOT SUDS. INT. CL. 3. REG. 12-3-1996.
- 2,020,993. MISCELLANEOUS DESIGN. INT. CL. 16. REG. 12-3-1996.
- 2,020,996. MISCELLANEOUS DESIGN. INT. CL. 21. REG. 12-3-1996.
- 2,020,997. MISCELLANEOUS DESIGN. INT. CL. 16. REG. 12-3-1996.
- 2,020,998. DESIGNFLEX. INT. CL. 27. REG. 12-3-1996.
- 2,021,013. ANGEL BLESSINGS. INT. CL. 16. REG. 12-3-1996.
- 2,021,043. ULTRA CLUB COLLECTION. INT. CL. 25. REG. 12-3-1996.
- 2,021,045. UNASOL. INT. CL. 3. REG. 12-3-1996.
- 2,021,048. TRADE SECRET. INT. CL. 3. REG. 12-3-1996.
- 2,021,049. HEALTH SOLUTIONS. INT. CL. 42. REG. 12-3-1996.
- 2,021,058. POP'N PUNCH. INT. CL. 32. REG. 12-3-1996.
- 2,021,061. LACTZYME. INT. CL. 5. REG. 12-3-1996.
- 2,021,071. BEE INTERNATIONAL. INT. CL. 41. REG. 12-3-1996.
- 2,021,078. YOUR HOME. BUILT EXACTLY THE WAY YOU WANT IT.. INT. CL. 37. REG. 12-3-1996.
- 2,021,086. PUTTING YOU ON THE ROAD TO GOOD CREDIT. INT. CL. 42. REG. 12-3-1996.
- 2,021,091. HRS. INT. CL. 25. REG. 12-3-1996.
- 2,021,093. 111 STATE. INT. CL. 25. REG. 12-3-1996.
- 2,021,098. MISCELLANEOUS DESIGN. INT. CL. 42. REG. 12-3-1996.
- 2,021,101. FRESNO PACIFIC COLLEGE. INT. CL. 41. REG. 12-3-1996.
- 2,021,103. SUNBIRDS. INT. CL. 41. REG. 12-3-1996.
- 2,021,109. MEDISAC. INT. CL. 10. REG. 12-3-1996.
- 2,021,112. JADECOR AND DESIGN. INT. CLS. 19 AND 27. REG. 12-3-1996.
- 2,021,133. LIL' DUTCH MAID AND DESIGN. INT. CL. 30. REG. 12-3-1996.
- 2,021,135. "RHINO-TUFF" AND DESIGN. INT. CL. 17. REG. 12-3-1996.
- 2,021,144. SEDONA BRAND. INT. CL. 30. REG. 12-3-1996.
- 2,021,146. PUT A LID ON IT. INT. CLS. 12, 16, 20 AND 21. REG. 12-3-1996.
- 2,021,150. SONIQUE SURGICAL SYSTEMS, INC.. INT. CL. 10. REG. 12-3-1996.
- 2,021,156. MISCELLANEOUS DESIGN. INT. CL. 9. REG. 12-3-1996.
- 2,021,160. RX FOR HEALTH AND DESIGN. INT. CL. 5. REG. 12-3-1996.
- 2,021,176. BRACH'S TWISTERS. INT. CL. 30. REG. 12-3-1996.
- 2,021,179. RAVE REVIEWS! AND DESIGN. INT. CLS. 29 AND 30. REG. 12-3-1996.
- 2,021,183. PUDDLE JUMPERS AND DESIGN. INT. CL. 25. REG. 12-3-1996.
- 2,021,185. RELAX AND GLOW. INT. CL. 3. REG. 12-3-1996.
- 2,021,190. DYNA-TOT. INT. CLS. 9 AND 16. REG. 12-3-1996.
- 2,021,210. FIT FINANCIAL INITIATIVES TRAINING AND DESIGN. INT. CL. 41. REG. 12-3-1996.
- 2,021,226. NEFERTARI (STYLIZED). INT. CL. 3. REG. 12-3-1996.
- 2,021,227. ALPHAMAX. INT. CL. 3. REG. 12-3-1996.
- 2,021,230. BELSON. INT. CL. 8. REG. 12-3-1996.
- 2,021,245. HOMEFRONT. INT. CL. 42. REG. 12-3-1996.
- 2,021,251. TECHMATES. INT. CL. 11. REG. 12-3-1996.
- 2,021,257. ORCHESTRATOR. INT. CL. 9. REG. 12-3-1996.
- 2,021,259. WASH WAX ALL AND DESIGN. INT. CL. 3. REG. 12-3-1996.
- 2,021,263. THE MAGIC OF MAINSTREET. INT. CL. 28. REG. 12-3-1996.
- 2,021,264. FORTY NINER. INT. CL. 30. REG. 12-3-1996.
- 2,021,272. CYBERAGENZ. INT. CLS. 9 AND 42. REG. 12-3-1996.
- 2,021,276. WOLF-PAK. INT. CL. 20. REG. 12-3-1996.
- 2,021,277. BEE FAST DELIVERY INC. AND DESIGN. INT. CL. 39. REG. 12-3-1996.
- 2,021,289. GARDEN SQUARE. INT. CL. 42. REG. 12-3-1996.
- 2,021,290. DUNHAM CASTLE. INT. CL. 32. REG. 12-3-1996.
- 2,021,291. GUSTAV WERNER. INT. CL. 32. REG. 12-3-1996.
- 2,021,292. OTTO BRUCKMAN. INT. CL. 32. REG. 12-3-1996.
- 2,021,296. WHERE BEAUTIFUL GARDENS BEGIN. INT. CL. 42. REG. 12-3-1996.

- 2,021,300. ECO-CHALLENGE. INT. CL. 41. REG. 12-3-1996.
2,021,310. CHRONO TRIGGER. INT. CL. 16. REG. 12-3-1996.
2,021,312. JOSTA. INT. CL. 32. REG. 12-3-1996.
2,021,323. MYCASEPTIC (STYLIZED). INT. CL. 5. REG. 12-3-1996.
2,021,327. COTT AND DESIGN. INT. CL. 32. REG. 12-3-1996.
2,021,356. FOOD FOR THE TAKING. INT. CL. 42. REG. 12-3-1996.
2,021,378. FLEXSTEEL SNEAK PREVIEW. INT. CL. 9. REG. 12-3-1996.
2,021,379. ALTA DENA NATURAL SELECT. INT. CL. 29. REG. 12-3-1996.
2,021,391. SUPER-RIPE. INT. CL. 11. REG. 12-3-1996.
2,021,395. RMA BRIEFCASES AND DESIGN. INT. CL. 16. REG. 12-3-1996.
2,021,397. T-MAIL. INT. CL. 38. REG. 12-3-1996.
2,021,404. NATURAL ESPECIAL. INT. CL. 3. REG. 12-3-1996.
2,021,405. GUSHER. INT. CL. 32. REG. 12-3-1996.
2,021,406. SENIOR LIFECHOICE. INT. CL. 42. REG. 12-3-1996.
2,021,407. COMFORT LINK. INT. CL. 39. REG. 12-3-1996.
2,021,423. EYE MATES BY NURSE MATES. INT. CL. 9. REG. 12-3-1996.
2,021,442. JOBSCAPE. INT. CL. 9. REG. 12-3-1996.
2,021,443. HOSTSCAPE. INT. CL. 9. REG. 12-3-1996.
2,021,454. PATIENT ED. INT. CL. 9. REG. 12-3-1996.
2,021,455. SURPRIZZLES. INT. CL. 28. REG. 12-3-1996.
2,021,458. SHARP SHOOTER. INT. CL. 3. REG. 12-3-1996.
2,021,468. AUTOSECURE. INT. CL. 9. REG. 12-3-1996.
2,021,478. TEMPGUARD. INT. CL. 11. REG. 12-3-1996.
2,021,479. USCADEN. INT. CL. 35. REG. 12-3-1996.
2,021,508. US ENGINES. INT. CLS. 7 AND 12. REG. 12-3-1996.
2,021,512. INTERNATIONAL PUBLISHING MANAGEMENT ASSOCIATION. INT. CL. 42. REG. 12-3-1996.
2,021,521. BEACH MART. INT. CL. 42. REG. 12-3-1996.
2,021,528. HERRON. INT. CLS. 37, 39 AND 42. REG. 12-3-1996.
2,021,534. SNORKEL DUCK. INT. CL. 28. REG. 12-3-1996.
2,022,848. WATER STORE WATER STORE NETWORK AND DESIGN. INT. CL. 30 ONLY. REG. 12-17-1996.
2,031,112. APPEAR'S. INT. CL. 3. REG. 1-14-1997.
2,089,528. A AND DESIGN. INT. CLS. 16 AND 35 ONLY. REG. 8-19-1997.
2,099,299. MELAMPO. INT. CL. 29 ONLY. REG. 9-23-1997.
2,108,659. MISCELLANEOUS DESIGN. INT. CL. 25 ONLY. REG. 10-28-1997.
2,120,760. GENE CHECK. INT. CL. 42 ONLY. REG. 12-16-1997.
2,122,721. BULL DOG POWER PRODUCTS. INT. CL. 9 ONLY. REG. 12-23-1997.
2,128,529. THE ROM DANCE AND DESIGN. INT. CL. 41 ONLY. REG. 1-13-1998.
2,151,630. BOOMERANG GRILLE AND DESIGN. INT. CL. 25 ONLY. REG. 4-21-1998.
2,171,264. LADY GODIVA'S. INT. CL. 41 ONLY. REG. 7-7-1998.
2,322,883. THE RELIANT GROUP. INT. CL. 36. REG. 2-29-2000.
2,328,006. LAKE 'N TRAIL. INT. CLS. 1, 9 AND 25 ONLY. REG. 3-14-2000.
2,343,492. CARADOL. INT. CL. 1. REG. 4-18-2000.
2,348,954. FAST.WEB. INT. CL. 36. REG. 5-9-2000.
2,355,395. VIVAYOU AND DESIGN. INT. CL. 25. REG. 6-6-2000.
2,409,666. GROUP 4 SECURITAS AND DESIGN. INT. CLS. 39 AND 42. REG. 12-5-2000.
2,409,667. SILK LEGEND. INT. CL. 25. REG. 12-5-2000.
2,409,668. MELAMINE CHEMICALS, INC. AND DESIGN. INT. CL. 42. REG. 12-5-2000.
2,409,669. TEAMSERVER. INT. CL. 9. REG. 12-5-2000.
2,409,671. YOUR FOOD-TECH PARTNER (STYLIZED). INT. CL. 42. REG. 12-5-2000.
2,409,678. AURASCENT. INT. CLS. 1 AND 3. REG. 12-5-2000.
2,409,680. THERMA-TEC. INT. CL. 25. REG. 12-5-2000.
2,409,681. E MEDIA AND DESIGN. INT. CLS. 9 AND 42. REG. 12-5-2000.
2,409,682. NETREPORTER. INT. CL. 9. REG. 12-5-2000.
2,409,683. ANIMAL PAKS BY B.H. SMITH AND DESIGN. INT. CL. 18. REG. 12-5-2000.
2,409,686. ULTRA-SYNTHET. INT. CLS. 1 AND 4. REG. 12-5-2000.
2,409,688. MISCELLANEOUS DESIGN. INT. CL. 9. REG. 12-5-2000.
2,409,690. SURE STRENGTH. INT. CL. 20. REG. 12-5-2000.
2,409,691. THE IDEA FACTORY. INT. CLS. 9 AND 20. REG. 12-5-2000.
2,409,692. KIS X (STYLIZED). INT. CL. 3. REG. 12-5-2000.
2,409,693. MISCELLANEOUS DESIGN. INT. CLS. 9 AND 41. REG. 12-5-2000.
2,409,694. MCI ECXPRESSWAY. INT. CL. 38. REG. 12-5-2000.
2,409,700. RETFORD. INT. CL. 25. REG. 12-5-2000.
2,409,701. JOYCE MARIE. INT. CLS. 18 AND 25. REG. 12-5-2000.
2,409,702. CENTELLINE. INT. CL. 3. REG. 12-5-2000.
2,409,703. CENTELINE. INT. CL. 3. REG. 12-5-2000.
2,409,706. THE ROCK. INT. CL. 41. REG. 12-5-2000.
2,409,708. DANNON YOGURT CRAVINGS AND DESIGN. INT. CL. 35. REG. 12-5-2000.
2,409,711. MORROK. INT. CLS. 18 AND 25. REG. 12-5-2000.
2,409,712. STAT-ATTACK. INT. CL. 9. REG. 12-5-2000.
2,409,714. ICKY STICKY BUGS. INT. CL. 16. REG. 12-5-2000.
2,409,716. 1.800 PRO TEAM THE STUFF THAT FANS ARE MADE FROM. AND DESIGN. INT. CL. 35. REG. 12-5-2000.
2,409,718. MARQUIS. INT. CL. 24. REG. 12-5-2000.
2,409,721. BANANA BOUNTY. INT. CL. 30. REG. 12-5-2000.
2,409,724. V-RALLY. INT. CL. 9. REG. 12-5-2000.
2,409,727. CALLISTO. INT. CL. 9. REG. 12-5-2000.
2,409,728. CLUB VOICE-MALE. INT. CL. 42. REG. 12-5-2000.
2,409,731. HENRY CLAY AND DESIGN. INT. CL. 21. REG. 12-5-2000.
2,409,732. MISCELLANEOUS DESIGN. INT. CL. 28. REG. 12-5-2000.
2,409,734. ORTHO-FLEX AND DESIGN. INT. CLS. 18 AND 25. REG. 12-5-2000.
2,409,736. LUBELL (STYLIZED). INT. CL. 23. REG. 12-5-2000.
2,409,741. QUALITE CTB FTF CERTIFIEE NO FUT DE TRADITION FRANCAISE AND DESIGN. INT. CL. 20. REG. 12-5-2000.
2,409,743. B BENETTON SPORT CAFE AND DESIGN. INT. CLS. 9, 14, 16, 18, 21, 24, 25, 28, 34, 35 AND 42. REG. 12-5-2000.
2,409,744. CENTURY 21 SALES EDGE. INT. CL. 9. REG. 12-5-2000.
2,409,745. WEBBIE THE WIZ. INT. CLS. 36 AND 42. REG. 12-5-2000.
2,409,753. GEM-MEX. INT. CLS. 9, 16, 41 AND 42. REG. 12-5-2000.
2,409,754. DATA WAREHOUSING: WHAT WORKS?. INT. CL. 16. REG. 12-5-2000.
2,409,755. EXPERIENCE THE REAL DIFFERENCE. AND DESIGN. INT. CL. 35. REG. 12-5-2000.
2,409,756. MPACS (STYLIZED). INT. CL. 9. REG. 12-5-2000.
2,409,757. SANI-CAT PLUS. INT. CLS. 1 AND 31. REG. 12-5-2000.
2,409,761. NEW YORK NEW YORK LAS VEGAS AND DESIGN. INT. CL. 25. REG. 12-5-2000.
2,409,764. GTX RAM AIR AND DESIGN. INT. CL. 12. REG. 12-5-2000.
2,409,769. KIDS' + AND DESIGN. INT. CLS. 9 AND 41. REG. 12-5-2000.
2,409,774. AFFORDABLE WINDOW COVERINGS AND DESIGN. INT. CL. 37. REG. 12-5-2000.
2,409,775. MAXGAS. INT. CLS. 9 AND 42. REG. 12-5-2000.
2,409,776. SIGMATEX. INT. CL. 12. REG. 12-5-2000.
2,409,778. MISCELLANEOUS DESIGN. INT. CL. 35. REG. 12-5-2000.
2,409,780. HPC HSIN PAI CHIANG HONG AND DESIGN. INT. CLS. 7 AND 11. REG. 12-5-2000.
2,409,782. SURETRAC. INT. CL. 20. REG. 12-5-2000.

- 2,409,783. DOUBLE DECKER STUDIOS. INT. CLS. 35 AND 42. REG. 12-5-2000.
- 2,409,785. SEXWARE. INT. CLS. 9 AND 41. REG. 12-5-2000.
- 2,409,786. RADIOSTORM. INT. CL. 9. REG. 12-5-2000.
- 2,409,787. SEC+ SAFETY EQUIPMENT COMPANY AND DESIGN. INT. CLS. 5 AND 35. REG. 12-5-2000.
- 2,409,788. CB (STYLIZED). INT. CL. 6. REG. 12-5-2000.
- 2,409,792. TRAINING TECHNOLOGIES. INT. CLS. 35, 41 AND 42. REG. 12-5-2000.
- 2,409,793. USI. INT. CLS. 35 AND 37. REG. 12-5-2000.
- 2,409,795. RISDON AMS AND DESIGN. INT. CL. 6. REG. 12-5-2000.
- 2,409,798. RISDON AMS AND DESIGN. INT. CL. 21. REG. 12-5-2000.
- 2,409,799. BEAULIEU VINEYARD BV COASTAL AND DESIGN. INT. CL. 33. REG. 12-5-2000.
- 2,409,800. EZWHEELS. INT. CL. 35. REG. 12-5-2000.
- 2,409,804. YARDVARK. INT. CL. 7. REG. 12-5-2000.
- 2,409,806. RISDON AMS AND DESIGN. INT. CL. 42. REG. 12-5-2000.
- 2,409,807. RISDON AMS AND DESIGN. INT. CL. 8. REG. 12-5-2000.
- 2,409,809. MISCELLANEOUS DESIGN. INT. CL. 32. REG. 12-5-2000.
- 2,409,810. MISCELLANEOUS DESIGN. INT. CL. 24. REG. 12-5-2000.
- 2,409,811. BRANDSHAPE. INT. CLS. 9, 35 AND 41. REG. 12-5-2000.
- 2,409,817. SNAPWARE. INT. CL. 9. REG. 12-5-2000.
- 2,409,822. PULSE. INT. CL. 41. REG. 12-5-2000.
- 2,409,823. NOVADA. INT. CLS. 1 AND 17. REG. 12-5-2000.
- 2,409,827. XTREMEMONITOR. INT. CL. 9. REG. 12-5-2000.
- 2,409,828. KATHY GENDEL. INT. CL. 41. REG. 12-5-2000.
- 2,409,829. SKOUT. INT. CL. 9. REG. 12-5-2000.
- 2,409,830. MACARONI KIDS AND DESIGN. INT. CL. 25. REG. 12-5-2000.
- 2,409,831. CORE COMPETENCIES. INT. CL. 42. REG. 12-5-2000.
- 2,409,832. CONGO GORILLA FOREST. INT. CL. 28. REG. 12-5-2000.
- 2,409,834. CD DEPOT. INT. CL. 9. REG. 12-5-2000.
- 2,409,835. FLINT AND DESIGN. INT. CLS. 37 AND 42. REG. 12-5-2000.
- 2,409,836. ERNESTINA CERINI. INT. CL. 25. REG. 12-5-2000.
- 2,409,840. AW AND DESIGN. INT. CL. 25. REG. 12-5-2000.
- 2,409,841. NEUTRON'S TACKLER. INT. CL. 21. REG. 12-5-2000.
- 2,409,843. NP 512. INT. CL. 25. REG. 12-5-2000.
- 2,409,844. SUNDSVALL VODKA TO BE SAVOURED (STYLIZED). INT. CL. 33. REG. 12-5-2000.
- 2,409,845. W NEW HOMEBUYER'S INSURANCE NEW HOMEBUYER'S TITLE HOMEBUYER'S MORTGAGE DESIGN SHOWCASE YOUR FULL SERVICE HOMEBUILDER AND DESIGN. INT. CLS. 36 AND 37. REG. 12-5-2000.
- 2,409,848. QIK JOE QIK PATCH. INT. CL. 19. REG. 12-5-2000.
- 2,409,849. AMTRYKE THE THERAPEUTIC TRICYCLE FOR CHILDREN WITH DISABILITIES AND DESIGN. INT. CL. 12. REG. 12-5-2000.
- 2,409,850. ROUTE EXPERT. INT. CL. 9. REG. 12-5-2000.
- 2,409,851. PAPERBACK. INT. CLS. 16, 37, 39, 40 AND 42. REG. 12-5-2000.
- 2,409,852. MISCELLANEOUS DESIGN. INT. CL. 41. REG. 12-5-2000.
- 2,409,853. F&M AND DESIGN. INT. CL. 9. REG. 12-5-2000.
- 2,409,854. NATIONAL BOARD REGISTRARS QUALITY SYSTEMS CERTIFICATIONS AND DESIGN. U.S. CL. B. REG. 12-5-2000.
- 2,409,855. MONDRAGON TELECOMMUNICATIONS. INT. CL. 9. REG. 12-5-2000.
- 2,409,856. COLCYS. INT. CLS. 1, 5 AND 10. REG. 12-5-2000.
- 2,409,862. PDFZONE (STYLIZED). INT. CL. 42. REG. 12-5-2000.
- 2,409,864. SPEECHACCESS. INT. CL. 9. REG. 12-5-2000.
- 2,409,867. QSA. INT. CL. 9. REG. 12-5-2000.
- 2,409,869. VERSABELT. INT. CL. 18. REG. 12-5-2000.
- 2,409,873. SUNDSVALL (STYLIZED). INT. CL. 33. REG. 12-5-2000.
- 2,409,874. CONFERENCE DIRECT. INT. CL. 35. REG. 12-5-2000.
- 2,409,878. COMMUNICATION & DOCUMENTATION SOLUTIONS, END TO END. INT. CLS. 35, 38, 40 AND 41. REG. 12-5-2000.
- 2,409,880. LAMVER AND DESIGN. INT. CLS. 6 AND 19. REG. 12-5-2000.
- 2,409,881. HANGAR-18 WORLDWIDE. INT. CL. 42. REG. 12-5-2000.
- 2,409,887. STAT-AWAY. INT. CL. 9. REG. 12-5-2000.
- 2,409,889. ENRICH YOUR LIFE EVERYDAY!. INT. CL. 16. REG. 12-5-2000.
- 2,409,890. AVIATION METHODS. INT. CLS. 35, 39 AND 42. REG. 12-5-2000.
- 2,409,891. TECHNOLOGY BRIDGE. INT. CL. 42. REG. 12-5-2000.
- 2,409,892. YOU ARE THE STAR OF EACH NEW DAY AND DESIGN. INT. CL. 25. REG. 12-5-2000.
- 2,409,896. NETSET. INT. CL. 42. REG. 12-5-2000.
- 2,409,897. INCREDIBLES AND DESIGN. INT. CLS. 29 AND 30. REG. 12-5-2000.
- 2,409,900. AGGS AND DESIGN. INT. CL. 38. REG. 12-5-2000.
- 2,409,903. CUSTOMER TRAK. INT. CL. 9. REG. 12-5-2000.
- 2,409,904. METROPETS AND DESIGN. INT. CL. 16. REG. 12-5-2000.
- 2,409,905. HEALTHY DOSE. INT. CL. 35. REG. 12-5-2000.
- 2,409,906. FLO'S DELICIOUS FOOD. INT. CLS. 29 AND 30. REG. 12-5-2000.
- 2,409,907. GREP. INT. CL. 25. REG. 12-5-2000.
- 2,409,909. EUROCONVERTER AND DESIGN. INT. CLS. 9, 16, 35, 38, 39, 40, 41 AND 42. REG. 12-5-2000.
- 2,409,911. MOTION PICTURE & EVENTS, INC.. INT. CL. 40. REG. 12-5-2000.
- 2,409,912. FUN FOAM. INT. CL. 3. REG. 12-5-2000.
- 2,409,913. COASTAL BRAND DELICIOUS HOT SNACKS THE WHOLE FAMILY WILL LOVE! AND DESIGN. INT. CL. 29. REG. 12-5-2000.
- 2,409,914. FRIEND OF FRENCH CREEK. INT. CLS. 41 AND 42. REG. 12-5-2000.
- 2,409,916. CALYPSO. INT. CLS. 35 AND 42. REG. 12-5-2000.
- 2,409,917. BERTLINK. INT. CL. 9. REG. 12-5-2000.
- 2,409,918. BSIMPRO. INT. CL. 9. REG. 12-5-2000.
- 2,409,919. RELPRO+. INT. CL. 9. REG. 12-5-2000.
- 2,409,920. NOISEPRO. INT. CL. 9. REG. 12-5-2000.
- 2,409,921. SIGMAPRO. INT. CL. 9. REG. 12-5-2000.
- 2,409,922. MOUNTAIN GROWN SOFTWARE. INT. CL. 42. REG. 12-5-2000.
- 2,409,923. PRIME EQUIPMENT SALES/RENTALS AND DESIGN. INT. CLS. 35 AND 37. REG. 12-5-2000.
- 2,409,929. GULF LIVE AND DESIGN. INT. CL. 42. REG. 12-5-2000.
- 2,409,930. DYNAMIC PROTECTED GLOBAL PARTNERS FUND. INT. CL. 36. REG. 12-5-2000.
- 2,409,931. HEARING SCIENCE A SOUND APPROACH TO HEARING HEALTHCARE. INT. CL. 35. REG. 12-5-2000.
- 2,409,932. FETI. INT. CL. 16. REG. 12-5-2000.
- 2,409,933. FASA. INT. CL. 3. REG. 12-5-2000.
- 2,409,938. JOINT UTILIZATION AND MANAGEMENT PROGRAM (JUMP) (STYLIZED). INT. CL. 42. REG. 12-5-2000.
- 2,409,940. MAXABILITIES KIDS AT THEIR BEST (STYLIZED). INT. CL. 16. REG. 12-5-2000.
- 2,409,941. XI AND DESIGN. INT. CLS. 29, 30, 32 AND 33. REG. 12-5-2000.
- 2,409,943. FLEXPAC. INT. CL. 27. REG. 12-5-2000.
- 2,409,945. WHATACHILL. INT. CL. 32. REG. 12-5-2000.
- 2,409,946. GULISTAN SIGNATURE DEALER (STYLIZED). INT. CL. 35. REG. 12-5-2000.
- 2,409,948. ENVIRONMENTAL STONE. INT. CL. 19. REG. 12-5-2000.
- 2,409,949. BINUSCAN IPM. INT. CL. 9. REG. 12-5-2000.
- 2,409,950. BRINGING CHURCH HOME. INT. CL. 16. REG. 12-5-2000.
- 2,409,951. THE DATAWEST GROUP. INT. CLS. 35 AND 41. REG. 12-5-2000.

- 2,409,954. MICROTUBE. INT. CL. 9. REG. 12-5-2000.
2,409,956. NATURAL BEAUTY COLOR AND DESIGN. INT. CL. 26. REG. 12-5-2000.
2,409,957. DEAFWORKS. INT. CL. 9. REG. 12-5-2000.
2,409,960. XINETIX (STYLIZED). INT. CL. 35. REG. 12-5-2000.
2,409,961. PHYSICIANS CARE AND DESIGN. INT. CL. 36. REG. 12-5-2000.
2,409,962. SAFE RUNNIN'. INT. CLS. 25 AND 35. REG. 12-5-2000.
2,409,965. GENUINE NUTRITION YOU SUPPLY THE BODY WE SUPPLY THE FUEL. INT. CL. 35. REG. 12-5-2000.
2,409,971. TRICKLES. INT. CL. 3. REG. 12-5-2000.
2,409,972. JALEO. INT. CL. 3. REG. 12-5-2000.
2,409,974. ARIA AND DESIGN. INT. CL. 42. REG. 12-5-2000.
2,409,975. PURE BUBBA AMERICAN ATTITUDE AND DESIGN. INT. CL. 25. REG. 12-5-2000.
2,409,977. ISHY FISHY SOAP DOPE AND DESIGN. INT. CL. 3. REG. 12-5-2000.
2,409,978. SOAP DOPE. INT. CL. 3. REG. 12-5-2000.
2,409,980. CLUB ELIXIR. INT. CL. 42. REG. 12-5-2000.
2,409,981. 1-877-NO-SPECS. INT. CL. 42. REG. 12-5-2000.
2,409,982. MITO COLLEZIONE. INT. CLS. 3, 8, 11, 21 AND 28. REG. 12-5-2000.
2,409,989. THE DANGEROUS CREW. INT. CL. 9. REG. 12-5-2000.
2,409,990. ATTACK ASTHMA (STYLIZED). INT. CL. 41. REG. 12-5-2000.
2,409,991. SALSARENGUE. INT. CL. 32. REG. 12-5-2000.
2,409,992. MISCELLANEOUS DESIGN. INT. CL. 42. REG. 12-5-2000.
2,409,993. TFR PREMIER. INT. CL. 36. REG. 12-5-2000.
2,409,994. Z-FIRMS. INT. CL. 36. REG. 12-5-2000.
2,409,996. BA,GGOTTA. INT. CL. 25. REG. 12-5-2000.
2,409,997. KIA AND DESIGN. INT. CL. 28. REG. 12-5-2000.
2,409,998. CARTBOX. INT. CL. 9. REG. 12-5-2000.
2,409,999. BAD DOG MUSIC. INT. CL. 41. REG. 12-5-2000.
2,410,000. BEL AMI. INT. CL. 29. REG. 12-5-2000.
2,410,002. KIZMIT (STYLIZED). INT. CL. 3. REG. 12-5-2000.
2,410,003. MISCELLANEOUS DESIGN. INT. CL. 36. REG. 12-5-2000.
2,410,004. PICCOLO DI TRE FRATELLI. INT. CL. 42. REG. 12-5-2000.
2,410,005. FARES. INT. CLS. 36 AND 39. REG. 12-5-2000.
2,410,007. MISCELLANEOUS DESIGN. INT. CL. 41. REG. 12-5-2000.
2,410,008. INFODOMAIN. INT. CL. 9. REG. 12-5-2000.
2,410,009. LIFE GRIP BY LEE'S WAY. INT. CL. 11. REG. 12-5-2000.
2,410,012. RILEY SKYROCKET. INT. CL. 40. REG. 12-5-2000.
2,410,014. ROWSURF. INT. CLS. 25 AND 28. REG. 12-5-2000.
2,410,015. TEMPER STICK. INT. CL. 17. REG. 12-5-2000.
2,410,016. MEDICAL EXCELLENCE. COMMUNITY LOYALTY.. INT. CLS. 35, 41 AND 42. REG. 12-5-2000.
2,410,018. AMERICAN EAGLES SOCCER CLUB AND DESIGN. INT. CL. 41. REG. 12-5-2000.
2,410,019. WHATTA DISH!. INT. CLS. 21, 35, 40 AND 41. REG. 12-5-2000.
2,410,020. QUICKSILVER. INT. CL. 38. REG. 12-5-2000.
2,410,022. PLANET BILLBOARD BETTER SIGNS FOR YOUR BUSINESS! AND DESIGN. INT. CL. 42. REG. 12-5-2000.
2,410,024. MISCELLANEOUS DESIGN. INT. CLS. 3, 5 AND 16. REG. 12-5-2000.
2,410,026. NIGHTSTAR. INT. CL. 9. REG. 12-5-2000.
2,410,029. CANNON AND DESIGN. INT. CLS. 20 AND 24. REG. 12-5-2000.
2,410,031. AMERICAN SHOWER DOOR. INT. CL. 11. REG. 12-5-2000.
2,410,032. MISCELLANEOUS DESIGN. INT. CLS. 9, 35 AND 42. REG. 12-5-2000.
2,410,034. POCKET LOVE. INT. CL. 20. REG. 12-5-2000.
2,410,035. POCKET STARS. INT. CL. 20. REG. 12-5-2000.
2,410,036. TOOL MAN AND DESIGN. INT. CL. 8. REG. 12-5-2000.
2,410,038. JSI (STYLIZED). INT. CL. 9. REG. 12-5-2000.
2,410,039. PROMOTIF. INT. CL. 35. REG. 12-5-2000.
2,410,040. STUCK AT THE AIRPORT. INT. CLS. 16 AND 42. REG. 12-5-2000.
2,410,041. ALAIN PROST (STYLIZED). INT. CLS. 5, 9 AND 25. REG. 12-5-2000.
2,410,043. HELLO NETWORK. INT. CL. 42. REG. 12-5-2000.
2,410,045. LET'S BUILD A SMARTER WORLD. INT. CLS. 9, 35, 38, 41 AND 42. REG. 12-5-2000.
2,410,046. WHERE DO YOU NEED TO B?. INT. CLS. 35, 39 AND 42. REG. 12-5-2000.
2,410,047. PROFORCE. INT. CL. 35. REG. 12-5-2000.
2,410,048. NEW YORK CARGO. INT. CL. 35. REG. 12-5-2000.
2,410,049. BELLE CURVE RECORDS. INT. CL. 9. REG. 12-5-2000.
2,410,050. GLOBAL INTERACTION. INT. CL. 42. REG. 12-5-2000.
2,410,051. DC-METASWITCH. INT. CL. 9. REG. 12-5-2000.
2,410,053. ROX (STYLIZED). INT. CL. 9. REG. 12-5-2000.
2,410,055. GET REWARDED (STYLIZED). INT. CL. 35. REG. 12-5-2000.
2,410,056. DEFINITUDE. INT. CL. 3. REG. 12-5-2000.
2,410,057. MISCELLANEOUS DESIGN. INT. CL. 42. REG. 12-5-2000.
2,410,058. MISCELLANEOUS DESIGN. INT. CL. 42. REG. 12-5-2000.
2,410,060. JOE SMOKER. INT. CL. 11. REG. 12-5-2000.
2,410,062. FINE ART AND DESIGN. INT. CL. 28. REG. 12-5-2000.
2,410,064. DAEMON NEWS. INT. CLS. 9 AND 42. REG. 12-5-2000.
2,410,066. AMUSEMATTE. INT. CLS. 9, 40 AND 42. REG. 12-5-2000.
2,410,067. POUDDRE LIBERTE. INT. CL. 3. REG. 12-5-2000.
2,410,069. THE SHAPE THAT SELLS. INT. CL. 20. REG. 12-5-2000.
2,410,071. ITC IN THE CREASE AND DESIGN. INT. CL. 9. REG. 12-5-2000.
2,410,073. FAST TRACK. INT. CL. 42. REG. 12-5-2000.
2,410,074. VECTOR BARBECUE. INT. CL. 11. REG. 12-5-2000.
2,410,075. GM (STYLIZED). INT. CLS. 38 AND 42. REG. 12-5-2000.
2,410,080. MISCELLANEOUS DESIGN. INT. CL. 36. REG. 12-5-2000.
2,410,088. DEUTSCHE BANK PRIVATE BANKING AND DESIGN. INT. CLS. 9, 35, 36 AND 42. REG. 12-5-2000.
2,410,089. RED ALERT. INT. CL. 16. REG. 12-5-2000.
2,410,091. THE THOMAS WHEELER WIRE SPOOL AND DESIGN. INT. CL. 6. REG. 12-5-2000.
2,410,092. THE UNIFORM SOX AND DESIGN. INT. CL. 25. REG. 12-5-2000.
2,410,095. MISCELLANEOUS DESIGN. INT. CL. 9. REG. 12-5-2000.
2,410,096. A (STYLIZED). INT. CL. 9. REG. 12-5-2000.
2,410,102. 360 DEGREE MARKETING. INT. CL. 35. REG. 12-5-2000.
2,410,104. ORBICELL. INT. CL. 1. REG. 12-5-2000.
2,410,105. JULES VERNE. INT. CL. 14. REG. 12-5-2000.
2,410,109. ISTPLACE!. INT. CL. 9. REG. 12-5-2000.
2,410,111. DAY FIVE A FIVE DAY SITE-SPECIFIC HOURLY FORECAST MERIDIAN ENVIRONMENTAL TECHNOLOGY INC. AND DESIGN. INT. CL. 42. REG. 12-5-2000.
2,410,113. MISCELLANEOUS DESIGN. INT. CL. 3. REG. 12-5-2000.
2,410,116. BRIO (STYLIZED). INT. CL. 9. REG. 12-5-2000.
2,410,117. MARKETING DEPOT. INT. CLS. 35 AND 42. REG. 12-5-2000.
2,410,118. MISCELLANEOUS DESIGN. INT. CL. 35. REG. 12-5-2000.
2,410,119. ROCK AND ROLL MAN. INT. CL. 41. REG. 12-5-2000.
2,410,121. RADIANS PICO. INT. CL. 9. REG. 12-5-2000.
2,410,122. SMARTCALL (STYLIZED). INT. CL. 35. REG. 12-5-2000.
2,410,123. MISCELLANEOUS DESIGN. INT. CLS. 1 AND 4. REG. 12-5-2000.

- 2,410,124. THUOLO. INT. CL. 25. REG. 12-5-2000.
 2,410,128. 911FIND.NET. INT. CL. 42. REG. 12-5-2000.
 2,410,132. T. M. SIS AND DESIGN. INT. CL. 3. REG. 12-5-2000.
 2,410,133. MISCELLANEOUS DESIGN. INT. CL. 41. REG. 12-5-2000.
 2,410,135. CHEETAH CONSERVATION FUND. INT. CLS. 16 AND 42. REG. 12-5-2000.
 2,410,136. PLAN4EVER.COM. INT. CLS. 35 AND 42. REG. 12-5-2000.
 2,410,138. REACH USA AND DESIGN. INT. CL. 35. REG. 12-5-2000.
 2,410,139. INETBILLER. INT. CL. 35. REG. 12-5-2000.
 2,410,141. MICRO-CLEAN SYSTEM. INT. CL. 3. REG. 12-5-2000.
 2,410,144. SPEAK FREELY WITH HUSHMAIL. INT. CL. 38. REG. 12-5-2000.
 2,410,147. PERFECTMIX. INT. CL. 3. REG. 12-5-2000.
 2,410,148. MW AND DESIGN. INT. CLS. 35 AND 42. REG. 12-5-2000.
 2,410,149. HONEY TEASERS. INT. CL. 30. REG. 12-5-2000.
 2,410,151. WALK-ON CENTRAL. INT. CL. 41. REG. 12-5-2000.
 2,410,152. GOLF BUDDIES. INT. CL. 41. REG. 12-5-2000.
 2,410,153. WASATCH CREST AND DESIGN. INT. CL. 36. REG. 12-5-2000.
 2,410,154. GIA GEM TRADE LABORATORY AND DESIGN. INT. CL. 42. REG. 12-5-2000.
 2,410,155. ANNA MALLE. INT. CLS. 9 AND 41. REG. 12-5-2000.
 2,410,158. DIRECTV SPORTS. INT. CLS. 38 AND 41. REG. 12-5-2000.
 2,410,160. CLICKPHARMACY.COM. INT. CL. 35. REG. 12-5-2000.
 2,410,161. SPA TO GO. INT. CLS. 35 AND 42. REG. 12-5-2000.
 2,410,163. MISCELLANEOUS DESIGN. INT. CL. 36. REG. 12-5-2000.
 2,410,164. PELICAN GRAPHICS. INT. CL. 42. REG. 12-5-2000.
 2,410,169. MISCELLANEOUS DESIGN. INT. CL. 7. REG. 12-5-2000.
 2,410,171. PREHISTORIC TIMES REGIONAL JOURNAL AND DESIGN. INT. CL. 16. REG. 12-5-2000.
 2,410,174. DIGITALDIM (STYLIZED). INT. CL. 9. REG. 12-5-2000.
 2,410,175. SMARTDIM (STYLIZED). INT. CL. 9. REG. 12-5-2000.
 2,410,176. EVAPOX. INT. CLS. 11 AND 40. REG. 12-5-2000.
 2,410,177. PROLINK AND DESIGN. INT. CL. 39. REG. 12-5-2000.
 2,410,179. ENGINEERED FOR LIFE. INT. CL. 42. REG. 12-5-2000.
 2,410,180. MISCELLANEOUS DESIGN. INT. CL. 42. REG. 12-5-2000.
 2,410,181. JUST 4 ME. INT. CL. 42. REG. 12-5-2000.
 2,410,182. ETG. INT. CL. 36. REG. 12-5-2000.
 2,410,183. FINAL CALL. INT. CL. 35. REG. 12-5-2000.
 2,410,187. GALT. INT. CLS. 6 AND 42. REG. 12-5-2000.
 2,410,188. BASICS FIRST. INT. CL. 16. REG. 12-5-2000.
 2,410,189. LUVABLE FRIENDS AND DESIGN. INT. CL. 28. REG. 12-5-2000.
 2,410,192. MURANO DUE AND DESIGN. INT. CL. 11. REG. 12-5-2000.
 2,410,194. GALT AND DESIGN. INT. CLS. 6 AND 42. REG. 12-5-2000.
 2,410,197. THE RENT BOYS. INT. CL. 41. REG. 12-5-2000.
 2,410,198. SOS OPEN AND DESIGN. INT. CL. 6. REG. 12-5-2000.
 2,410,199. WCQ AND DESIGN. INT. CLS. 7 AND 40. REG. 12-5-2000.
 2,410,201. SUPER RAT. INT. CL. 12. REG. 12-5-2000.
 2,410,202. CHOW DOWN FOR CHARITY AND DESIGN. INT. CL. 36. REG. 12-5-2000.
 2,410,203. NETVAL. INT. CLS. 9, 35, 38 AND 42. REG. 12-5-2000.
 2,410,204. EE DIRECT. INT. CL. 42. REG. 12-5-2000.
 2,410,205. OWL'S NEST PRODUCTIONS. INT. CL. 9. REG. 12-5-2000.
 2,410,208. THE ART OF THE ORDINARY . . . ORDINARY LOOKS, EXTRAORDINARY PERFORMANCE. INT. CL. 28. REG. 12-5-2000.
 2,410,209. AMERICAN FAN TRAMS. INT. CL. 39. REG. 12-5-2000.
 2,410,211. VISIONIX. INT. CL. 9. REG. 12-5-2000.
 2,410,215. JENNIFER LAUREN (STYLIZED). INT. CL. 25. REG. 12-5-2000.
 2,410,218. VANTAGELINK. INT. CL. 36. REG. 12-5-2000.
 2,410,220. DENA LAUREN (STYLIZED). INT. CL. 25. REG. 12-5-2000.
 2,410,222. ASAC. INT. CL. 12. REG. 12-5-2000.
 2,410,223. PROPRINT AND DESIGN. INT. CL. 9. REG. 12-5-2000.
 2,410,224. DATABASENOW!. INT. CL. 42. REG. 12-5-2000.
 2,410,228. E AND DESIGN. INT. CLS. 35, 38 AND 42. REG. 12-5-2000.
 2,410,229. TURNPOST DESIGN. INT. CLS. 35 AND 42. REG. 12-5-2000.
 2,410,234. NEST LITERARY CLASSICS AND DESIGN. INT. CL. 16. REG. 12-5-2000.
 2,410,236. NORESCO AND DESIGN. INT. CL. 35. REG. 12-5-2000.
 2,410,237. BUSH TRANSPORTATION SYSTEMS AN EMPLOYEE OWNED COMPANY AND DESIGN. INT. CL. 39. REG. 12-5-2000.
 2,410,238. VINTAGE PIANO WORKS. INT. CL. 37. REG. 12-5-2000.
 2,410,239. "WE SPEAK COLOR!". INT. CL. 3. REG. 12-5-2000.
 2,410,243. BLUEGRASS BREAKDOWN. INT. CL. 16. REG. 12-5-2000.
 2,410,244. ARC CONNECTED. INT. CL. 38. REG. 12-5-2000.
 2,410,245. THERE'S A NEW TOOLKIT. INT. CL. 38. REG. 12-5-2000.
 2,410,248. SAVE THE STUBS. INT. CL. 35. REG. 12-5-2000.
 2,410,250. BMA LITE. INT. CLS. 16 AND 35. REG. 12-5-2000.
 2,410,251. BODY WISE. INT. CL. 16. REG. 12-5-2000.
 2,410,255. FENN'S FORMALWEAR AND DESIGN. INT. CL. 42. REG. 12-5-2000.
 2,410,256. WXIMAGE (STYLIZED). INT. CL. 9. REG. 12-5-2000.
 2,410,259. TRAVELSEARCH NETWORK. INT. CL. 35. REG. 12-5-2000.
 2,410,260. MODEM AND DESIGN. INT. CLS. 35, 41 AND 42. REG. 12-5-2000.
 2,410,261. Z-FETE-Z. INT. CL. 25. REG. 12-5-2000.
 2,410,262. MAGIC GLAZE. INT. CL. 3. REG. 12-5-2000.
 2,410,263. TECH MEDICAL. INT. CL. 40. REG. 12-5-2000.
 2,410,266. BEL AIRS. INT. CL. 9. REG. 12-5-2000.
 2,410,267. MOBILITY FOR MOBILE SOLUTIONS, GO UNIVERSAL. AND DESIGN. INT. CL. 9. REG. 12-5-2000.
 2,410,268. MOBILITY AND DESIGN. INT. CL. 42. REG. 12-5-2000.
 2,410,269. MOBILITY FOR MOBILE SOLUTIONS, GO UNIVERSAL. AND DESIGN. INT. CL. 42. REG. 12-5-2000.
 2,410,270. PHOTODAKE. INT. CL. 16. REG. 12-5-2000.
 2,410,273. SF BAY NATURALS AND DESIGN. INT. CLS. 3 AND 21. REG. 12-5-2000.
 2,410,274. TRIPOD TEENSPEAK. INT. CL. 38. REG. 12-5-2000.
 2,410,276. MISCELLANEOUS DESIGN. INT. CL. 25. REG. 12-5-2000.
 2,410,282. SOFTWARE AG AMERICAS. INT. CL. 42. REG. 12-5-2000.
 2,410,283. 2XL. INT. CLS. 35 AND 42. REG. 12-5-2000.
 2,410,284. LIPPINCOTT WILLIAMS & WILKINS' PRIMARY CARE ONLINE. INT. CL. 42. REG. 12-5-2000.
 2,410,285. ROSE MONROE SOCIETY AND DESIGN. INT. CL. 14. REG. 12-5-2000.
 2,410,287. UUSECURE. INT. CL. 38. REG. 12-5-2000.
 2,410,289. SLIPJOINT. INT. CLS. 9 AND 41. REG. 12-5-2000.
 2,410,290. GAMMA PHI EPSILON GREEK LETTERS AND DESIGN. INT. CL. 42. REG. 12-5-2000.
 2,410,293. ROBIN MARIETON. INT. CL. 24. REG. 12-5-2000.
 2,410,294. MISCELLANEOUS DESIGN. U.S. CL. B. REG. 12-5-2000.

- 2,410,298. TOHUBOHU. INT. CL. 16. REG. 12-5-2000.
 2,410,299. TRAVEL PRIVILEGES INTERNATIONAL. INT. CL. 42. REG. 12-5-2000.
 2,410,300. ASCRIBE. INT. CLS. 35 AND 42. REG. 12-5-2000.
 2,410,303. EVERY DAY'S THE WEEKEND. INT. CL. 35. REG. 12-5-2000.
 2,410,304. SKIPMAIL. INT. CLS. 38 AND 39. REG. 12-5-2000.
 2,410,311. THE INSTITUTION. INT. CL. 42. REG. 12-5-2000.
 2,410,313. ZEITZEISEN. INT. CL. 14. REG. 12-5-2000.
 2,410,317. CHIP. INT. CL. 35. REG. 12-5-2000.
 2,410,320. ULTRA PRODUCTIONS AND DESIGN. INT. CL. 35. REG. 12-5-2000.
 2,410,324. ZWIRL.COM. INT. CL. 42. REG. 12-5-2000.
 2,410,325. CNA TURNING CREATIVE IDEAS INTO RETAIL PROFITS (STYLIZED). INT. CL. 16. REG. 12-5-2000.
 2,410,330. ARTS & CRAFTS (STYLIZED). INT. CL. 16. REG. 12-5-2000.
 2,410,332. MIND BODY GOLF AND DESIGN. INT. CL. 42. REG. 12-5-2000.
 2,410,333. KP STAMP COLLECTOR AND DESIGN. INT. CL. 16. REG. 12-5-2000.
 2,410,335. WARMAN'S TODAY'S COLLECTOR THE NATION'S ANTIQUES & COLLECTIBLES MARKETPLACE AND DESIGN. INT. CL. 16. REG. 12-5-2000.
 2,410,337. RETAILSTORES DESIGNED BY A WOMAN FOR A WOMAN. INT. CL. 42. REG. 12-5-2000.
 2,410,338. TPH. INT. CLS. 37, 41 AND 42. REG. 12-5-2000.
 2,410,339. MARIACHI WOMAN. INT. CL. 3. REG. 12-5-2000.
 2,410,340. P R O L I F A R O N AND DESIGN. INT. CL. 42. REG. 12-5-2000.
 2,410,342. RECOVERY TOGETHER. INT. CL. 16. REG. 12-5-2000.
 2,410,346. MJS AND DESIGN. U.S. CL. 200. REG. 12-5-2000.
 2,410,347. AMERICAN FIDELITY DUAL STRATEGY FUND. INT. CL. 36. REG. 12-5-2000.
 2,410,348. MALACHI GROUP. INT. CL. 36. REG. 12-5-2000.
 2,410,349. SMALL FACES. INT. CL. 25. REG. 12-5-2000.
 2,410,354. G-STRINGS. INT. CL. 25. REG. 12-5-2000.
 2,410,356. TRIPLE-C-FARMS. INT. CL. 39. REG. 12-5-2000.
 2,410,357. STARPOINT. INT. CL. 16. REG. 12-5-2000.
 2,410,358. CAFE ROMANIA. INT. CL. 42. REG. 12-5-2000.
 2,410,359. POWER BOOST 2000QI. INT. CL. 5. REG. 12-5-2000.
 2,410,360. GO HWY. INT. CL. 35. REG. 12-5-2000.
 2,410,361. MUTUAL FUND SELECT LIST. INT. CL. 16. REG. 12-5-2000.
 2,410,363. LED PANTS. INT. CL. 42. REG. 12-5-2000.
 2,410,364. BREATHE AND DESIGN. INT. CL. 41. REG. 12-5-2000.
 2,410,371. EUROPEAN DISPLAYS & BOXES AND DESIGN. INT. CLS. 18 AND 20. REG. 12-5-2000.
 2,410,373. WELLSPACE (STYLIZED). INT. CL. 35. REG. 12-5-2000.
 2,410,375. DISC REPLAY. INT. CL. 35. REG. 12-5-2000.
 2,410,376. HALLMARK PRINCIPLE. INT. CL. 35. REG. 12-5-2000.
 2,410,378. DSL PLUS. INT. CL. 38. REG. 12-5-2000.
 2,410,379. TEK (STYLIZED). INT. CL. 40. REG. 12-5-2000.
 2,410,380. MACGAMING.COM. INT. CL. 42. REG. 12-5-2000.
 2,410,382. TRANSCRIPT AND DESIGN. INT. CL. 16. REG. 12-5-2000.
 2,410,385. YMARKETING.COM. INT. CL. 35. REG. 12-5-2000.
 2,410,386. GROMMETTE AND DESIGN. INT. CL. 25. REG. 12-5-2000.
 2,410,387. OZMOZIZ AND DESIGN. INT. CL. 3. REG. 12-5-2000.
 2,410,389. YO CUENTO AND DESIGN. INT. CLS. 18 AND 25. REG. 12-5-2000.
 2,410,390. NOODLES PIZZA PASTA PIZZAZZ AND DESIGN. INT. CL. 42. REG. 12-5-2000.
 2,410,391. FAVORITEGIFT.COM. INT. CL. 35. REG. 12-5-2000.
 2,410,392. GRAND SLAM HAT RACK. INT. CL. 20. REG. 12-5-2000.
 2,410,393. YO CUENTO. INT. CLS. 18 AND 25. REG. 12-5-2000.
 2,410,394. YO CUENTO AND DESIGN. INT. CLS. 18 AND 25. REG. 12-5-2000.
 2,410,395. STRESSSAVERS. INT. CL. 9. REG. 12-5-2000.
 2,410,396. SURE DRIVER. INT. CL. 7. REG. 12-5-2000.
 2,410,397. IGAIN.COM AND DESIGN. INT. CL. 35. REG. 12-5-2000.
 2,410,402. SUNTEX SILVER. INT. CL. 35. REG. 12-5-2000.
 2,410,403. *LINK AND DESIGN. INT. CL. 9. REG. 12-5-2000.
 2,410,411. SOFTWARE SECURED WITH SECURE AGENT AND DESIGN. INT. CL. 9. REG. 12-5-2000.
 2,410,413. THE CAPITAL PRESERVE INDEPENDENT FINANCIAL ADVISORS AND DESIGN. INT. CL. 36. REG. 12-5-2000.
 2,410,414. CROSSWORKS. INT. CL. 42. REG. 12-5-2000.
 2,410,418. SEEK MODEL & TALENT SEARCH AND DESIGN. INT. CL. 35. REG. 12-5-2000.
 2,410,419. MISCELLANEOUS DESIGN. INT. CLS. 9 AND 41. REG. 12-5-2000.
 2,410,422. EMISSET. INT. CL. 5. REG. 12-5-2000.
 2,410,424. D DAVIDSON INC AND DESIGN. INT. CL. 35. REG. 12-5-2000.
 2,410,425. K NETTING AND DESIGN. INT. CLS. 35 AND 42. REG. 12-5-2000.
 2,410,426. K NECTING AND DESIGN. INT. CLS. 35 AND 42. REG. 12-5-2000.
 2,410,427. K NEQUITY AND DESIGN. INT. CLS. 35 AND 42. REG. 12-5-2000.
 2,410,431. STOCK DETECTIVE. INT. CL. 36. REG. 12-5-2000.
 2,410,433. COUPONBARGAINS. INT. CL. 35. REG. 12-5-2000.
 2,410,435. GOLD MEDAL REHAB & FITNESS. INT. CL. 42. REG. 12-5-2000.
 2,410,436. SENSUA. INT. CL. 5. REG. 12-5-2000.
 2,410,438. COOLER REVOLUTION. INT. CL. 16. REG. 12-5-2000.
 2,410,440. MYDESKTOP. INT. CL. 42. REG. 12-5-2000.
 2,410,441. FILEFARM. INT. CL. 42. REG. 12-5-2000.
 2,410,446. EM + SERV AND DESIGN. INT. CL. 35. REG. 12-5-2000.
 2,410,447. FLY AWAY AND DESIGN. INT. CLS. 18 AND 19. REG. 12-5-2000.
 2,410,449. MEGA-1 NETWORK, INC. AND DESIGN. INT. CL. 35. REG. 12-5-2000.
 2,410,450. RADIODIM (STYLIZED). INT. CL. 9. REG. 12-5-2000.
 2,410,451. TRADEYARD.COM. INT. CL. 42. REG. 12-5-2000.
 2,410,456. AUREKA. INT. CL. 35. REG. 12-5-2000.
 2,410,458. TASTEITALY.COM. INT. CL. 35. REG. 12-5-2000.
 2,410,459. HOUSING 101 AND DESIGN. INT. CL. 36. REG. 12-5-2000.
 2,410,461. AMENGLISH. INT. CL. 9. REG. 12-5-2000.
 2,410,464. USMS. INT. CL. 36. REG. 12-5-2000.
 2,410,466. THE ORCHIDWORKS. INT. CL. 42. REG. 12-5-2000.
 2,410,467. SUCCESSTRAIL. INT. CL. 42. REG. 12-5-2000.
 2,410,470. SIRPAUL. INT. CL. 41. REG. 12-5-2000.
 2,410,471. VELOCITY AND DESIGN. INT. CLS. 7 AND 9. REG. 12-5-2000.
 2,410,472. NRG. INT. CL. 35. REG. 12-5-2000.
 2,410,473. TENDENCY. INT. CL. 25. REG. 12-5-2000.
 2,410,477. "THE WEALTH PRESERVATION COMPANY" AND DESIGN. INT. CL. 36. REG. 12-5-2000.
 2,410,479. THE PERFUME DETECTIVE. INT. CL. 3. REG. 12-5-2000.
 2,410,481. MONKEYNUT. INT. CL. 41. REG. 12-5-2000.
 2,410,484. FIRST THINGS. INT. CL. 16. REG. 12-5-2000.
 2,410,487. ESCAPE FROM HOLLYWOOD. INT. CL. 41. REG. 12-5-2000.
 2,410,488. THINK-STRATEGY. INT. CL. 9. REG. 12-5-2000.
 2,410,489. WORLDS TOGETHER. INT. CL. 9. REG. 12-5-2000.
 2,410,490. VIRTUAL-BUZZ. INT. CL. 35. REG. 12-5-2000.
 2,410,491. VBAZ. INT. CLS. 9 AND 42. REG. 12-5-2000.
 2,410,492. DANIMALS AND DESIGN. INT. CL. 29. REG. 12-5-2000.
 2,410,493. DANIMALS AND DESIGN. INT. CL. 29. REG. 12-5-2000.

- 2,410,494. DANIMALS AND DESIGN. INT. CL. 29. REG. 12-5-2000.
- 2,410,499. INNERLIGHT. INT. CL. 9. REG. 12-5-2000.
- 2,410,502. MISCELLANEOUS DESIGN. INT. CL. 9. REG. 12-5-2000.
- 2,410,503. BANJARA INDIAN CUISINE SERVING YOU LIKE HOME AND DESIGN. INT. CL. 42. REG. 12-5-2000.
- 2,410,504. CROSS-CULTURAL TRANSFORMATIONS. INT. CL. 41. REG. 12-5-2000.
- 2,410,505. ASCEND RESIDENTIAL PROPERTIES, INC.. INT. CLS. 36 AND 37. REG. 12-5-2000.
- 2,410,508. BIBLESCOPE. INT. CL. 16. REG. 12-5-2000.
- 2,410,509. DEWAYNE HARVEY & UNRESTRAINED PRAISE. INT. CL. 41. REG. 12-5-2000.
- 2,410,512. MAILBAG.COM. INT. CLS. 38 AND 42. REG. 12-5-2000.
- 2,410,514. CAVLOGIX. INT. CL. 9. REG. 12-5-2000.
- 2,410,515. SURFSTIK. INT. CL. 9. REG. 12-5-2000.
- 2,410,516. PERSISTENCE. INTEGRITY. GUTS.. INT. CL. 41. REG. 12-5-2000.
- 2,410,517. QUEST—IT AND DESIGN. INT. CL. 35. REG. 12-5-2000.
- 2,410,522. UX RX UNXERCISE PRESCRIPTION AND DESIGN. INT. CLS. 25 AND 28. REG. 12-5-2000.
- 2,410,524. OLIVER PERRY. INT. CL. 25. REG. 12-5-2000.
- 2,410,525. BRINGING FAMILIES AND SCHOOLS TOGETHER ONLINE. INT. CL. 41. REG. 12-5-2000.
- 2,410,527. THE CELESTIAL UNICORN AND DESIGN. INT. CL. 16. REG. 12-5-2000.
- 2,410,529. MAJIC. INT. CL. 16. REG. 12-5-2000.
- 2,410,532. THE CENTER FOR TOTAL BACK CARE AND DESIGN. INT. CL. 42. REG. 12-5-2000.
- 2,410,537. PROBLEMLAB. INT. CL. 35. REG. 12-5-2000.
- 2,410,538. KEMMA. INT. CL. 9. REG. 12-5-2000.
- 2,410,539. DLJDIRECT WIRELESS. INT. CL. 36. REG. 12-5-2000.
- 2,410,543. TWIN MODAL GUARDIAN AND DESIGN. INT. CL. 39. REG. 12-5-2000.
- 2,410,546. ANTIQUORUM ONLINE (STYLIZED). INT. CLS. 35 AND 42. REG. 12-5-2000.
- 2,410,547. SYNTHETIC LUBRICANTS INC. AND DESIGN. INT. CL. 40. REG. 12-5-2000.
- 2,410,548. AUTO REPAIR \$ \$ \$ \$ \$ \$ PROFIT EYE AND DESIGN. INT. CL. 35. REG. 12-5-2000.
- 2,410,550. AOL FOUNDATION AND DESIGN. INT. CL. 36. REG. 12-5-2000.
- 2,410,551. AOL FOUNDATION AND DESIGN. INT. CLS. 36, 41 AND 42. REG. 12-5-2000.
- 2,410,552. MISCELLANEOUS DESIGN. INT. CL. 41. REG. 12-5-2000.
- 2,410,553. MISCELLANEOUS DESIGN. INT. CLS. 36, 41 AND 42. REG. 12-5-2000.
- 2,410,554. AOL FOUNDATION. INT. CL. 41. REG. 12-5-2000.
- 2,410,555. AOL FOUNDATION AND DESIGN. INT. CL. 41. REG. 12-5-2000.
- 2,410,561. CNA HAS A SMARTER WAY. INT. CL. 36. REG. 12-5-2000.
- 2,410,563. HUGGABLE HUNKS. INT. CL. 28. REG. 12-5-2000.
- 2,410,565. BANANA WIND. INT. CL. 35. REG. 12-5-2000.
- 2,410,566. FUTURE FOCUS. INT. CL. 35. REG. 12-5-2000.
- 2,410,567. CONTINUOUS WEB TECHNOLOGIES. INT. CL. 42. REG. 12-5-2000.
- 2,410,569. CATHERINE'S SOMETHING FOR THE PALATE TO SAVOR AND DESIGN. INT. CL. 29. REG. 12-5-2000.
- 2,410,570. S.W. EARLEY DOWNEASTER DUCK CALLS WATERFOWL SUPPLY CO. AND DESIGN. INT. CL. 28. REG. 12-5-2000.
- 2,410,571. THE PARTY STORE FOR THE PLANET. INT. CL. 35. REG. 12-5-2000.
- 2,410,572. UNIQUE MAPS. INT. CL. 16. REG. 12-5-2000.
- 2,410,577. HANDYPRO HANDYMAN SERVICE AND DESIGN. INT. CL. 37. REG. 12-5-2000.
- 2,410,578. LET YOUR MOUSE DO THE SHOPPING. INT. CL. 35. REG. 12-5-2000.
- 2,410,581. HEALTH CARE RECRUITMENT ONLINE AND DESIGN. INT. CL. 35. REG. 12-5-2000.
- 2,410,583. POWERBLOCK. INT. CL. 38. REG. 12-5-2000.
- 2,410,585. VOYEURDORM.COM. INT. CL. 41. REG. 12-5-2000.
- 2,410,586. WE'RE ON IT. INT. CLS. 35 AND 40. REG. 12-5-2000.
- 2,410,587. CLIPSOURCE. INT. CL. 9. REG. 12-5-2000.
- 2,410,588. REALIANCE. INT. CL. 9. REG. 12-5-2000.
- 2,410,589. SOFTHOME AND DESIGN. INT. CL. 38. REG. 12-5-2000.
- 2,410,590. GLUCONEX. INT. CL. 5. REG. 12-5-2000.
- 2,410,591. NICODEX. INT. CL. 5. REG. 12-5-2000.
- 2,410,593. VIDEOFORUM. INT. CLS. 16 AND 41. REG. 12-5-2000.
- 2,410,594. MISCELLANEOUS DESIGN. INT. CL. 16. REG. 12-5-2000.
- 2,410,595. PARALEGALS PLUS. INT. CL. 35. REG. 12-5-2000.
- 2,410,598. DEALERS FIRST CHOICE AND DESIGN. INT. CL. 36. REG. 12-5-2000.
- 2,410,603. LUSAFRICA. INT. CL. 9. REG. 12-5-2000.
- 2,410,607. MAGELLAN T. BEAR. INT. CL. 28. REG. 12-5-2000.
- 2,410,610. PRIVATE ISLE. INT. CL. 28. REG. 12-5-2000.
- 2,410,616. NICKELS PERFORMANCE WAREHOUSE. INT. CL. 35. REG. 12-5-2000.
- 2,410,618. SUPER GREEN. INT. CL. 1. REG. 12-5-2000.
- 2,410,619. WARP. INT. CL. 42. REG. 12-5-2000.
- 2,410,620. AQUATRAINER. INT. CL. 28. REG. 12-5-2000.
- 2,410,621. STRAWBERRY ROCK!. INT. CL. 25. REG. 12-5-2000.
- 2,410,623. JOEY CARNAL AND DESIGN. INT. CL. 25. REG. 12-5-2000.
- 2,410,625. CREW VAN. INT. CL. 12. REG. 12-5-2000.
- 2,410,626. WHERE ATTRIBUTES COME TO ORDER. INT. CL. 42. REG. 12-5-2000.
- 2,410,629. AESTHETIC PLASTIC SURGERY (STYLIZED). INT. CL. 42. REG. 12-5-2000.
- 2,410,630. THE TECHNOLOGY TEAM BEHIND GREAT INTERNET STARTUPS. INT. CL. 42. REG. 12-5-2000.
- 2,410,631. EMC TRANSPORTATION AND DESIGN. INT. CL. 35. REG. 12-5-2000.
- 2,410,633. AUREUS MEDICAL. INT. CL. 35. REG. 12-5-2000.
- 2,410,635. AUREUS TECHNICAL. INT. CL. 35. REG. 12-5-2000.
- 2,410,638. 48 HOURS AND DESIGN. INT. CL. 41. REG. 12-5-2000.
- 2,410,639. NY-TAXI.COM. INT. CLS. 18, 20, 25 AND 35. REG. 12-5-2000.
- 2,410,640. HAVE YOU GONE LOCO TODAY?. INT. CL. 38. REG. 12-5-2000.
- 2,410,644. KIDS KROP SHOP. INT. CL. 42. REG. 12-5-2000.
- 2,410,645. PEN PALS. INT. CL. 28. REG. 12-5-2000.
- 2,410,646. ANNIEMATION. INT. CL. 42. REG. 12-5-2000.
- 2,410,648. AMBLE. INT. CL. 28. REG. 12-5-2000.
- 2,410,649. UNIQUE GIFTS AT YOUR FINGERTIPS. INT. CL. 35. REG. 12-5-2000.
- 2,410,650. IPOP AND DESIGN. INT. CLS. 16 AND 41. REG. 12-5-2000.
- 2,410,651. LOSE WEIGHT DROP-BY-DROP. INT. CL. 5. REG. 12-5-2000.
- 2,410,653. IUSI. INT. CL. 6. REG. 12-5-2000.
- 2,410,654. THE BIG E BOX. INT. CL. 28. REG. 12-5-2000.
- 2,410,655. SISTERFRIENDS. INT. CL. 38. REG. 12-5-2000.
- 2,410,656. MEDIAPLANT AND DESIGN. INT. CLS. 41 AND 42. REG. 12-5-2000.
- 2,410,660. MISCELLANEOUS DESIGN. INT. CL. 38. REG. 12-5-2000.
- 2,410,661. FRESHNEX. INT. CLS. 35 AND 42. REG. 12-5-2000.
- 2,410,662. FRESHNEX.COM. INT. CLS. 35 AND 42. REG. 12-5-2000.
- 2,410,663. BACTIGON. INT. CL. 28. REG. 12-5-2000.
- 2,410,664. THE BUTLER. INT. CL. 20. REG. 12-5-2000.
- 2,410,668. PERIMETER. INT. CL. 27. REG. 12-5-2000.
- 2,410,670. INTEGRATED TELECOM SOLUTIONS AND DESIGN. INT. CL. 38. REG. 12-5-2000.

- 2,410,673. BE A POWER BROKER. INT. CL. 36. REG. 12-5-2000.
- 2,410,676. CAN'T BUST 'EM AND DESIGN. INT. CL. 25. REG. 12-5-2000.
- 2,410,681. MAPEX. INT. CL. 21. REG. 12-5-2000.
- 2,410,685. THE SEVENTH DAY. INT. CL. 35. REG. 12-5-2000.
- 2,410,686. NOPOSTCARD.COM (STYLIZED). INT. CL. 35. REG. 12-5-2000.
- 2,410,687. THE NAME FRAME (STYLIZED). INT. CL. 20. REG. 12-5-2000.
- 2,410,689. EXECUTIVE SPORTS MEMORABILIA. INT. CL. 35. REG. 12-5-2000.
- 2,410,690. RESTORING THE PAST... BUILDING THE FUTURE... (STYLIZED). INT. CL. 37. REG. 12-5-2000.
- 2,410,693. SILVER&GOLD. INT. CL. 16. REG. 12-5-2000.
- 2,410,695. EXPLERE. INT. CL. 42. REG. 12-5-2000.
- 2,410,700. TRAX'IM. INT. CL. 9. REG. 12-5-2000.
- 2,410,702. ULC HOMEFINDER AND DESIGN. INT. CL. 36. REG. 12-5-2000.
- 2,410,703. MISCELLANEOUS DESIGN. INT. CL. 35. REG. 12-5-2000.
- 2,410,704. AG AND DESIGN. INT. CLS. 9, 16, 35, 41 AND 42. REG. 12-5-2000.
- 2,410,705. THE MESSY ARTIST. INT. CL. 41. REG. 12-5-2000.
- 2,410,706. MISCELLANEOUS DESIGN. INT. CL. 35. REG. 12-5-2000.
- 2,410,709. PRONEVIEW. INT. CL. 10. REG. 12-5-2000.
- 2,410,710. RED LANTERN. INT. CL. 42. REG. 12-5-2000.
- 2,410,711. FREEFALL. INT. CL. 41. REG. 12-5-2000.
- 2,410,717. CREATIVE BY NATURE. INT. CL. 42. REG. 12-5-2000.
- 2,410,719. U PLUSLINK AND DESIGN. INT. CL. 36. REG. 12-5-2000.
- 2,410,720. PORTA FRESH. INT. CL. 10. REG. 12-5-2000.
- 2,410,721. THE LOVE CUBE. INT. CL. 28. REG. 12-5-2000.
- 2,410,722. ALPINE RIDGE. INT. CL. 14. REG. 12-5-2000.
- 2,410,723. TRANSPROP. INT. CL. 16. REG. 12-5-2000.
- 2,410,724. POGA. INT. CL. 41. REG. 12-5-2000.
- 2,410,727. WILDLIFE WEAR. INT. CL. 14. REG. 12-5-2000.
- 2,410,728. FOREST TRAVEL AGENCY "PEOPLE WITH THE RIGHT CONNECTIONS". INT. CL. 39. REG. 12-5-2000.
- 2,410,733. N AND DESIGN. INT. CL. 25. REG. 12-5-2000.
- 2,410,734. @ AND DESIGN. INT. CL. 25. REG. 12-5-2000.
- 2,410,735. GANZ-PAK. INT. CL. 7. REG. 12-5-2000.
- 2,410,738. R-HAB. INT. CL. 10. REG. 12-5-2000.
- 2,410,739. YORKSHIRE. INT. CL. 21. REG. 12-5-2000.
- 2,410,740. ENTERTAINING ALL POSSIBILITIES. INT. CL. 41. REG. 12-5-2000.
- 2,410,741. TRANS-CORE. INT. CL. 17. REG. 12-5-2000.
- 2,410,746. THE RE-INVENTION OF THE ICE CREAM CONE. INT. CL. 30. REG. 12-5-2000.
- 2,410,751. MISCELLANEOUS DESIGN. INT. CL. 5. REG. 12-5-2000.
- 2,410,752. AD-CAST. INT. CL. 35. REG. 12-5-2000.
- 2,410,754. HARDWEAR. INT. CL. 16. REG. 12-5-2000.
- 2,410,759. NGIN AND DESIGN. INT. CL. 42. REG. 12-5-2000.
- 2,410,760. UUHOST. INT. CL. 37. REG. 12-5-2000.
- 2,410,761. UUHOST. INT. CL. 38. REG. 12-5-2000.
- 2,410,762. FOSTER PARROTS. INT. CL. 42. REG. 12-5-2000.
- 2,410,763. MEDSTAT DISEASE STAGING SOFTWARE. INT. CL. 9. REG. 12-5-2000.
- 2,410,765. A FUTURE OF OPPORTUNITY. INT. CL. 41. REG. 12-5-2000.
- 2,410,769. WORK. SMART. AND DESIGN. INT. CL. 7. REG. 12-5-2000.
- 2,410,773. EXPOL. INT. CL. 11. REG. 12-5-2000.
- 2,410,774. MELAGAME. INT. CL. 28. REG. 12-5-2000.
- 2,410,775. W3UNIVERSE.COM. INT. CL. 35. REG. 12-5-2000.
- 2,410,778. DNS (STYLIZED). INT. CL. 25. REG. 12-5-2000.
- 2,410,784. CHESTMASTER. INT. CL. 28. REG. 12-5-2000.
- 2,410,785. SET IT FORGET IT. INT. CL. 11. REG. 12-5-2000.
- 2,410,787. DEPARTMENT Y. INT. CL. 25. REG. 12-5-2000.
- 2,410,788. OPEL. INT. CL. 36. REG. 12-5-2000.
- 2,410,792. TOPICDOC EXPRESS. INT. CL. 42. REG. 12-5-2000.
- 2,410,794. THE KING'S DAUGHTER. INT. CL. 16. REG. 12-5-2000.
- 2,410,795. POPSICLE. INT. CL. 9. REG. 12-5-2000.
- 2,410,797. RACEPAD.COM. INT. CL. 42. REG. 12-5-2000.
- 2,410,799. CAREWAVES. INT. CL. 42. REG. 12-5-2000.
- 2,410,800. QUALITY FARM & COUNTRY. INT. CL. 35. REG. 12-5-2000.
- 2,410,802. BALMEX MEDICATED PLUS. INT. CL. 5. REG. 12-5-2000.
- 2,410,803. BALMEX. INT. CL. 5. REG. 12-5-2000.
- 2,410,804. COMMVERGE. INT. CLS. 16 AND 42. REG. 12-5-2000.
- 2,410,806. KANE KLASSICS. INT. CL. 28. REG. 12-5-2000.
- 2,410,807. L LONGER DIAMOND TOOLS AND DESIGN. INT. CL. 7. REG. 12-5-2000.
- 2,410,808. MROI. INT. CL. 35. REG. 12-5-2000.
- 2,410,809. JOHNNY SUEDE. INT. CL. 25. REG. 12-5-2000.
- 2,410,810. ONEEDGE. INT. CL. 42. REG. 12-5-2000.
- 2,410,811. ONEEDGE. INT. CL. 35. REG. 12-5-2000.
- 2,410,812. TRITON AND DESIGN. INT. CL. 13. REG. 12-5-2000.
- 2,410,814. MROI (STYLIZED). INT. CL. 35. REG. 12-5-2000.
- 2,410,816. GET THE 411 ON YOUR CREDIT. INT. CL. 36. REG. 12-5-2000.
- 2,410,819. ISA AND DESIGN. INT. CL. 42. REG. 12-5-2000.
- 2,410,821. B BECKETT AND DESIGN. INT. CL. 16. REG. 12-5-2000.
- 2,410,823. HOBBIES & IDEAS (STYLIZED). INT. CL. 16. REG. 12-5-2000.
- 2,410,824. OTTOMAN. INT. CL. 34. REG. 12-5-2000.
- 2,410,825. RIDINGMANIA. INT. CL. 25. REG. 12-5-2000.
- 2,410,826. BELVEDERE COURT. INT. CL. 24. REG. 12-5-2000.
- 2,410,828. MINITRACK. INT. CL. 7. REG. 12-5-2000.
- 2,410,829. #2 SPECIAL. INT. CL. 28. REG. 12-5-2000.
- 2,410,830. TRADITIONAL. INT. CL. 28. REG. 12-5-2000.
- 2,410,831. GAVEAU. INT. CL. 15. REG. 12-5-2000.
- 2,410,832. QUANDEL AND DESIGN. INT. CL. 37. REG. 12-5-2000.
- 2,410,833. BOOMSTICK. INT. CL. 28. REG. 12-5-2000.
- 2,410,834. DATABETES AND DESIGN. INT. CL. 9. REG. 12-5-2000.
- 2,410,835. DATABOLIC AND DESIGN. INT. CL. 9. REG. 12-5-2000.
- 2,410,847. PULSAR. INT. CL. 9. REG. 12-5-2000.
- 2,410,848. BEYOND CONNECTED. INT. CL. 9. REG. 12-5-2000.
- 2,410,850. VISIONTRACKER. INT. CL. 16. REG. 12-5-2000.
- 2,410,851. "TEACH ME, PLEASE". INT. CL. 41. REG. 12-5-2000.
- 2,410,854. LABEL-ETS. INT. CL. 16. REG. 12-5-2000.
- 2,410,857. ALARON.COM. INT. CL. 36. REG. 12-5-2000.
- 2,410,858. ALARONLINE. INT. CL. 36. REG. 12-5-2000.
- 2,410,859. LORAN. INT. CL. 28. REG. 12-5-2000.
- 2,410,860. BACK ALLEY. INT. CL. 28. REG. 12-5-2000.
- 2,410,861. BACK ALLEY AND DESIGN. INT. CL. 28. REG. 12-5-2000.
- 2,410,863. THE DASH IN E-BUSINESS. INT. CL. 38. REG. 12-5-2000.
- 2,410,864. MYDSL THE DASH IN E-BUSINESS. INT. CL. 38. REG. 12-5-2000.
- 2,410,865. MYDSL. INT. CL. 38. REG. 12-5-2000.
- 2,410,866. COMVISION. INT. CL. 9. REG. 12-5-2000.
- 2,410,868. SOLUTIONS AT WORK.. INT. CL. 35. REG. 12-5-2000.
- 2,410,869. THE POWER OF A SINGLE THOUGHT.. INT. CL. 35. REG. 12-5-2000.
- 2,410,870. LET YOUR IMAGINATION TAKE FLIGHT.. INT. CL. 35. REG. 12-5-2000.
- 2,410,871. BRIGHT PEOPLE. BOLD THINKING.. INT. CL. 35. REG. 12-5-2000.
- 2,410,872. MISCELLANEOUS DESIGN. INT. CL. 39. REG. 12-5-2000.
- 2,410,877. WHEEL 'N WASH. INT. CL. 20. REG. 12-5-2000.
- 2,410,879. JANUS INTERMEDIATE GOVERNMENT SECURITIES FUND. INT. CL. 36. REG. 12-5-2000.
- 2,410,881. NERDS WANTED. INT. CL. 42. REG. 12-5-2000.

- 2,410,888. MISCELLANEOUS DESIGN. INT. CL. 42. REG. 12-5-2000.
- 2,410,889. ARMITRON LITE. INT. CL. 14. REG. 12-5-2000.
- 2,410,890. AMERICA'S GIFT WRAP. INT. CLS. 35 AND 39. REG. 12-5-2000.
- 2,410,891. MISCELLANEOUS DESIGN. INT. CL. 42. REG. 12-5-2000.
- 2,410,892. SEEALL. INT. CL. 9. REG. 12-5-2000.
- 2,410,894. BLUM EXPANDO. INT. CLS. 6 AND 20. REG. 12-5-2000.
- 2,410,897. UH OH. INT. CLS. 21 AND 26. REG. 12-5-2000.
- 2,410,898. CT CREATIVE TECHNOLOGY AND DESIGN. INT. CLS. 16, 35 AND 38. REG. 12-5-2000.
- 2,410,901. BLACK TAIL PRESENTS THE 25 SEXIEST DANCERS. INT. CL. 16. REG. 12-5-2000.
- 2,410,903. PREVENTION'S GUIDE CATS & DOGS. INT. CL. 16. REG. 12-5-2000.
- 2,410,904. OPHTHALIN. INT. CL. 5. REG. 12-5-2000.
- 2,410,905. BODY ZONE. INT. CL. 3. REG. 12-5-2000.
- 2,410,907. AIRBAG. INT. CL. 9. REG. 12-5-2000.
- 2,410,910. AQUA NO2VA AND DESIGN. INT. CL. 5. REG. 12-5-2000.
- 2,410,911. KLICK. INT. CL. 9. REG. 12-5-2000.
- 2,410,912. DISPATCH BY CELLULARONE AND DESIGN. INT. CL. 38. REG. 12-5-2000.
- 2,410,915. MISCELLANEOUS DESIGN. INT. CLS. 37 AND 42. REG. 12-5-2000.
- 2,410,916. SKISTIK. INT. CL. 3. REG. 12-5-2000.
- 2,410,917. CEPACOL. INT. CL. 5. REG. 12-5-2000.
- 2,410,919. WEE TV TEACHING VALUES AND DESIGN. INT. CLS. 41 AND 42. REG. 12-5-2000.
- 2,410,920. BOWBUDDIES. INT. CL. 16. REG. 12-5-2000.
- 2,410,921. DIGIPLAYER. INT. CL. 15. REG. 12-5-2000.
- 2,410,922. SOUND PILLOW. INT. CL. 17. REG. 12-5-2000.
- 2,410,923. WATCH TOWN. INT. CL. 35. REG. 12-5-2000.
- 2,410,925. ORAL SENSATIONS. INT. CL. 30. REG. 12-5-2000.
- 2,410,927. FETABLES. INT. CL. 29. REG. 12-5-2000.
- 2,410,928. THE NINE PRODUCTS AND DESIGN. INT. CL. 28. REG. 12-5-2000.
- 2,410,929. TRUST US FOR LIFE. INT. CL. 9. REG. 12-5-2000.
- 2,410,930. PRINT AND DESIGN. INT. CL. 16. REG. 12-5-2000.
- 2,410,932. IDYLLE. INT. CL. 4. REG. 12-5-2000.
- 2,410,933. LITTLE CHARACTERS. INT. CL. 24. REG. 12-5-2000.
- 2,410,934. UFO INVESTIGATOR. INT. CL. 16. REG. 12-5-2000.
- 2,410,936. ON NOW. INT. CL. 35. REG. 12-5-2000.
- 2,410,940. ECOSAFE. INT. CL. 22. REG. 12-5-2000.
- 2,410,941. LIVE BROADWAY AND DESIGN. INT. CL. 21. REG. 12-5-2000.
- 2,410,944. SIMON. INT. CL. 9. REG. 12-5-2000.
- 2,410,947. TRUSTNODE. INT. CL. 9. REG. 12-5-2000.
- 2,410,948. WEB ELITE. INT. CL. 9. REG. 12-5-2000.
- 2,410,949. MAKE-A-ZINE. INT. CLS. 16 AND 28. REG. 12-5-2000.
- 2,410,951. 1020 BLUES CLASSY THREADS AND DESIGN. INT. CL. 25. REG. 12-5-2000.
- 2,410,953. MISCELLANEOUS DESIGN. INT. CL. 25. REG. 12-5-2000.
- 2,410,957. MISCELLANEOUS DESIGN. INT. CL. 6. REG. 12-5-2000.
- 2,410,958. HERITAGE. INT. CL. 19. REG. 12-5-2000.
- 2,410,959. EAU DU JOUR. INT. CL. 3. REG. 12-5-2000.
- 2,410,961. PERMAC. INT. CLS. 1 AND 3. REG. 12-5-2000.
- 2,410,962. IT'S A WHOLE NEW LIGHT. INT. CL. 11. REG. 12-5-2000.
- 2,410,963. CARDIODYNE AND DESIGN. INT. CL. 10. REG. 12-5-2000.
- 2,410,964. GLAAZART. INT. CL. 19. REG. 12-5-2000.
- 2,410,966. EMMANAGER. INT. CL. 9. REG. 12-5-2000.
- 2,410,970. AE ASIAN ENTERPRISE AND DESIGN. INT. CL. 16. REG. 12-5-2000.
- 2,410,971. IF PRO (STYLIZED). INT. CL. 9. REG. 12-5-2000.
- 2,410,972. CARGILL AGHORIZONS. INT. CL. 35. REG. 12-5-2000.
- 2,410,973. MISCELLANEOUS DESIGN. INT. CLS. 5 AND 42. REG. 12-5-2000.
- 2,410,974. GO FARTHER. INT. CL. 42. REG. 12-5-2000.
- 2,410,976. UNIBODY. INT. CL. 28. REG. 12-5-2000.
- 2,410,979. EMULAVERA. INT. CL. 3. REG. 12-5-2000.
- 2,410,982. INTEGRAPRO. INT. CL. 9. REG. 12-5-2000.
- 2,410,983. BIRDIES RULE!. INT. CL. 25. REG. 12-5-2000.
- 2,410,984. FAST LANE. INT. CL. 9. REG. 12-5-2000.
- 2,410,986. ANCHOR GROUP AND DESIGN. INT. CLS. 40 AND 42. REG. 12-5-2000.
- 2,410,989. LR LIGHTWAVE RESEARCH AND DESIGN. INT. CLS. 9 AND 11. REG. 12-5-2000.
- 2,410,990. JAGUAR AND DESIGN. INT. CL. 20. REG. 12-5-2000.
- 2,410,991. QAREL. INT. CL. 3. REG. 12-5-2000.
- 2,410,992. GUN CABLE LOCK AND DESIGN. INT. CL. 6. REG. 12-5-2000.
- 2,410,994. ROAD CANNIBAL. INT. CL. 28. REG. 12-5-2000.
- 2,410,996. PRACTICE STUDIO. INT. CL. 9. REG. 12-5-2000.
- 2,410,997. SECRET DESIRE. INT. CL. 25. REG. 12-5-2000.
- 2,411,001. R RIPTIDE TECHNOLOGIES AND DESIGN. INT. CLS. 9 AND 42. REG. 12-5-2000.
- 2,411,003. LEASESITE. INT. CL. 9. REG. 12-5-2000.
- 2,411,005. AMERITRADE AND DESIGN. INT. CLS. 36 AND 41. REG. 12-5-2000.
- 2,411,007. STUDIO ONE. INT. CL. 42. REG. 12-5-2000.
- 2,411,008. HEALTH TEC AND DESIGN. INT. CLS. 10 AND 11. REG. 12-5-2000.
- 2,411,009. STREET CRUISER. INT. CL. 14. REG. 12-5-2000.
- 2,411,013. SMARTSOLUTIONS. INT. CL. 38. REG. 12-5-2000.
- 2,411,014. THE MARKET GRILL AND DESIGN. INT. CL. 29. REG. 12-5-2000.
- 2,411,015. SENSO-PEDIC. INT. CL. 20. REG. 12-5-2000.
- 2,411,016. 30-MINUTE MAKEOVER. INT. CL. 16. REG. 12-5-2000.
- 2,411,018. ANIMATED RESOLUTIONS. INT. CL. 42. REG. 12-5-2000.
- 2,411,019. PET PARADE. INT. CL. 18. REG. 12-5-2000.
- 2,411,020. SAVINGS ON THE NET. INT. CL. 35. REG. 12-5-2000.
- 2,411,021. YOUR KEY TO FINANCIAL SUCCESS.. INT. CL. 36. REG. 12-5-2000.
- 2,411,023. STEP BY STEP. INT. CL. 19. REG. 12-5-2000.
- 2,411,024. ROCHE SALON (STYLIZED). INT. CLS. 3 AND 42. REG. 12-5-2000.
- 2,411,026. SPA. INT. CL. 20. REG. 12-5-2000.
- 2,411,027. FAN MAIL AND DESIGN. INT. CL. 6. REG. 12-5-2000.
- 2,411,029. PSPT AND DESIGN. INT. CL. 28. REG. 12-5-2000.
- 2,411,030. ANTRIM DESIGN SYSTEMS, INC. AND DESIGN. INT. CL. 42. REG. 12-5-2000.
- 2,411,033. BEL ENGINEERING. INT. CL. 9. REG. 12-5-2000.
- 2,411,035. ZI PANI. INT. CLS. 29, 30 AND 42. REG. 12-5-2000.
- 2,411,036. SHAHRE NOOR LIGHT CENTER AND DESIGN. INT. CL. 42. REG. 12-5-2000.
- 2,411,039. GORILLA SKINZ. INT. CL. 25. REG. 12-5-2000.
- 2,411,045. PARFUMS DE JOAILLIERS. INT. CL. 3. REG. 12-5-2000.
- 2,411,046. DOCU-LOCK. INT. CL. 6. REG. 12-5-2000.
- 2,411,047. WE'RE WITH YOU. INT. CL. 35. REG. 12-5-2000.
- 2,411,052. 760 PLUS. INT. CL. 9. REG. 12-5-2000.
- 2,411,054. TOMORROW'S TREASURES. INT. CL. 16. REG. 12-5-2000.
- 2,411,055. THE BIG ISSUE. INT. CL. 16. REG. 12-5-2000.
- 2,411,057. PROTO 23. INT. CL. 25. REG. 12-5-2000.
- 2,411,058. LOCAL 81 BERDOO EST. 1948 (STYLIZED). INT. CL. 25. REG. 12-5-2000.
- 2,411,060. TRADER'S ADVANTAGE. INT. CL. 36. REG. 12-5-2000.
- 2,411,063. MISCELLANEOUS DESIGN. INT. CL. 9. REG. 12-5-2000.
- 2,411,068. SPINAL DYNAMICS. INT. CL. 10. REG. 12-5-2000.
- 2,411,071. ELD!N. INT. CL. 16. REG. 12-5-2000.
- 2,411,072. THE SECRET FILES OF THE SPY DOGS. INT. CL. 41. REG. 12-5-2000.
- 2,411,074. FASTLAYNE. INT. CL. 41. REG. 12-5-2000.
- 2,411,075. ENERGY BAND. INT. CL. 10. REG. 12-5-2000.
- 2,411,077. PIX MOVIE SERVICE. INT. CL. 35. REG. 12-5-2000.
- 2,411,082. MOBILE RETAILER. INT. CL. 36. REG. 12-5-2000.

- 2,411,089. ADDIT. INT. CL. 9. REG. 12-5-2000.
 2,411,094. MISCELLANEOUS DESIGN. INT. CL. 29. REG. 12-5-2000.
 2,411,096. MASTER LACE. INT. CL. 24. REG. 12-5-2000.
 2,411,097. ACYTEX (STYLIZED). INT. CL. 24. REG. 12-5-2000.
 2,411,100. HOLLYWOOD SHORTS. INT. CL. 25. REG. 12-5-2000.
 2,411,101. CATCH-IT. INT. CL. 9. REG. 12-5-2000.
 2,411,103. IT'S A CHEMICAL CHAMELEON. INT. CL. 1. REG. 12-5-2000.
 2,411,104. MISCELLANEOUS DESIGN. INT. CL. 1. REG. 12-5-2000.
 2,411,106. SCHOOLS OF PROMISE. INT. CLS. 36 AND 42. REG. 12-5-2000.
 2,411,110. T-BAR. INT. CL. 16. REG. 12-5-2000.
 2,411,111. CUSTOM GRAPHICS DESIGN AND DESIGN. INT. CL. 42. REG. 12-5-2000.
 2,411,112. COOKIE CADABRA. INT. CLS. 30 AND 35. REG. 12-5-2000.
 2,411,113. GARDENS EDGE. INT. CL. 9. REG. 12-5-2000.
 2,411,116. SPORTS AT HOME. INT. CL. 9. REG. 12-5-2000.
 2,411,119. CAROLINA SILVER. INT. CL. 17. REG. 12-5-2000.
 2,411,120. ALBASHIELD. INT. CL. 17. REG. 12-5-2000.
 2,411,121. BUSTER NUCKLES. INT. CLS. 1 AND 17. REG. 12-5-2000.
 2,411,122. CENTERMASTER. INT. CL. 9. REG. 12-5-2000.
 2,411,123. CERTINET. INT. CL. 9. REG. 12-5-2000.
 2,411,124. PSST!. INT. CLS. 35 AND 40. REG. 12-5-2000.
 2,411,125. LINK PAK. INT. CL. 20. REG. 12-5-2000.
 2,411,126. BROOKLYN BRIDGE DINNERS. INT. CLS. 29 AND 30. REG. 12-5-2000.
 2,411,127. HIDE-AWAY. INT. CL. 20. REG. 12-5-2000.
 2,411,130. SMARTAGE. INT. CLS. 9, 16, 35, 36, 38 AND 42. REG. 12-5-2000.
 2,411,131. AQUAT 40 COMPLEX. INT. CL. 3. REG. 12-5-2000.
 2,411,132. LEVEL SUPERSTORE. INT. CL. 9. REG. 12-5-2000.
 2,411,135. GIVE YOUR TV THE N IT NEEDS (STYLIZED). INT. CLS. 38 AND 41. REG. 12-5-2000.
 2,411,137. ALLIANCE RADIOLOGY. INT. CL. 42. REG. 12-5-2000.
 2,411,138. TOTAL SERVICE DESK. INT. CLS. 41 AND 42. REG. 12-5-2000.
 2,411,144. FIRST IQ. INT. CL. 35. REG. 12-5-2000.
 2,411,145. EZ TONER. INT. CL. 2. REG. 12-5-2000.
 2,411,147. SUNMAX. INT. CL. 16. REG. 12-5-2000.
 2,411,148. ASHWOOD LANE COLLECTION. INT. CLS. 20 AND 27. REG. 12-5-2000.
 2,411,151. HI Q. INT. CL. 31. REG. 12-5-2000.
 2,411,152. ONE HUNDRED DEEDS OF EDDIE MCDOWD. INT. CL. 41. REG. 12-5-2000.
 2,411,154. COMFORT CLEAT. INT. CL. 25. REG. 12-5-2000.
 2,411,155. HEARST MAGAZINES. WE READ AMERICA.. INT. CL. 35. REG. 12-5-2000.
 2,411,157. U S WEST CHOICE TV. INT. CL. 38. REG. 12-5-2000.
 2,411,158. SUPR. INT. CL. 35. REG. 12-5-2000.
 2,411,159. FVC.COM. INT. CL. 9. REG. 12-5-2000.
 2,411,160. DREAMLIGHT. INT. CL. 11. REG. 12-5-2000.
 2,411,162. PREMIERPRICER. INT. CL. 9. REG. 12-5-2000.
 2,411,164. AUTONOMOUS. INT. CL. 35. REG. 12-5-2000.
 2,411,166. SFC. INT. CL. 6. REG. 12-5-2000.
 2,411,168. SEALOUETTE. INT. CL. 10. REG. 12-5-2000.
 2,411,169. ICEIN. INT. CL. 1. REG. 12-5-2000.
 2,411,170. OUTTA SIGHT STUFFED SHELLS AND DESIGN. INT. CL. 30. REG. 12-5-2000.
 2,411,171. RAPID AIRE. INT. CL. 11. REG. 12-5-2000.
 2,411,172. INVESTOR INSIGHT. INT. CL. 42. REG. 12-5-2000.
 2,411,173. NET PET. INT. CL. 28. REG. 12-5-2000.
 2,411,174. TURBINATOR AND DESIGN. INT. CL. 7. REG. 12-5-2000.
 2,411,180. THE ONLY SHOVEL WITH A BACKBONE. INT. CL. 8. REG. 12-5-2000.
 2,411,181. PRODUCING PARTNERSHIPS...FROM THE GROUND UP. INT. CL. 31. REG. 12-5-2000.
 2,411,183. HANDSEL. INT. CL. 40. REG. 12-5-2000.
 2,411,185. LOGIC KIDZ. INT. CL. 28. REG. 12-5-2000.
 2,411,187. LIMONE D'ORO. INT. CL. 33. REG. 12-5-2000.
 2,411,188. HILLSIDE PAPER-LESS SYSTEM. INT. CL. 36. REG. 12-5-2000.
 2,411,190. P AND DESIGN. INT. CL. 42. REG. 12-5-2000.
 2,411,191. HAUTE-ZINE. INT. CL. 42. REG. 12-5-2000.
 2,411,192. MINIMUMM'S AND DESIGN. INT. CL. 24. REG. 12-5-2000.
 2,411,194. ATLANTIC CUSTOM PROCESSORS, LLC AND DESIGN. INT. CL. 29. REG. 12-5-2000.
 2,411,195. GO KITE. INT. CL. 28. REG. 12-5-2000.
 2,411,196. RII REEF ONE AND DESIGN. INT. CL. 25. REG. 12-5-2000.
 2,411,197. AQUA SHIELD. INT. CL. 1. REG. 12-5-2000.
 2,411,198. GENERATION X. INT. CL. 21. REG. 12-5-2000.
 2,411,200. XACT. INT. CL. 19. REG. 12-5-2000.
 2,411,201. XACT. INT. CL. 19. REG. 12-5-2000.
 2,411,202. ISOSEED. INT. CL. 10. REG. 12-5-2000.
 2,411,203. WALK BY THE BRIDGE. INT. CLS. 3 AND 4. REG. 12-5-2000.
 2,411,204. SPACEGUIDE AND DESIGN. INT. CL. 9. REG. 12-5-2000.
 2,411,208. LA VOLPE. INT. CL. 42. REG. 12-5-2000.
 2,411,210. SSSVA. INT. CL. 35. REG. 12-5-2000.
 2,411,213. SUPRAZINA. INT. CL. 5. REG. 12-5-2000.
 2,411,214. MUSHROOM TIP AND DESIGN. U.S. CL. 200. REG. 12-5-2000.
 2,411,215. COOLCALL. INT. CL. 38. REG. 12-5-2000.
 2,411,216. ECUADOR DIRECT AND DESIGN. INT. CL. 35. REG. 12-5-2000.
 2,411,219. GROWING RETURNS. INT. CL. 16. REG. 12-5-2000.
 2,411,220. MISS THETIS. INT. CL. 28. REG. 12-5-2000.
 2,411,221. MISS CARNA. INT. CL. 28. REG. 12-5-2000.
 2,411,222. BOUND ONLY BY YOUR IMAGINATION. INT. CLS. 35 AND 36. REG. 12-5-2000.
 2,411,223. CAMPAL. INT. CL. 9. REG. 12-5-2000.
 2,411,226. RUSTIE. INT. CL. 28. REG. 12-5-2000.
 2,411,228. MISCELLANEOUS DESIGN. INT. CL. 5. REG. 12-5-2000.
 2,411,229. MACHO MACARONI AND DESIGN. INT. CL. 30. REG. 12-5-2000.
 2,411,231. SMELL THE COFFEE. INT. CL. 42. REG. 12-5-2000.
 2,411,233. FISHGATE AND DESIGN. INT. CL. 9. REG. 12-5-2000.
 2,411,234. SPORTILE. INT. CL. 19. REG. 12-5-2000.
 2,411,236. CLEAR PLAN EASY AND DESIGN. INT. CL. 10. REG. 12-5-2000.
 2,411,239. PICK-N-POP. INT. CL. 9. REG. 12-5-2000.
 2,411,242. AGRILYX. INT. CL. 5. REG. 12-5-2000.
 2,411,243. HELEN ARDELLE. INT. CL. 30. REG. 12-5-2000.
 2,411,244. DESIGNERS' SALUTE TO HOLLYWOOD COLLECTION. INT. CL. 28. REG. 12-5-2000.
 2,411,250. CRAZY COVERS. INT. CL. 16. REG. 12-5-2000.
 2,411,251. PARIAN. INT. CL. 42. REG. 12-5-2000.
 2,411,252. CLIP ART CANNIBALS AND DESIGN. INT. CL. 9. REG. 12-5-2000.
 2,411,253. COPTRANS. INT. CL. 9. REG. 12-5-2000.
 2,411,254. ADDRESSIFIRE. INT. CL. 9. REG. 12-5-2000.
 2,411,256. WELCH'S. INT. CL. 30. REG. 12-5-2000.
 2,411,258. BULA BEAR (STYLIZED). INT. CL. 28. REG. 12-5-2000.
 2,411,259. PRESSURE PERFECT. INT. CL. 5. REG. 12-5-2000.
 2,411,260. CHEF BRAND AND DESIGN. INT. CL. 25. REG. 12-5-2000.
 2,411,261. NEXT WAVE AND DESIGN. INT. CL. 3. REG. 12-5-2000.
 2,411,263. CALABAS. INT. CL. 11. REG. 12-5-2000.
 2,411,264. OCALA. INT. CL. 11. REG. 12-5-2000.
 2,411,267. SKYBOX ON WAVELAND. INT. CL. 36. REG. 12-5-2000.
 2,411,270. BABA (STYLIZED). INT. CL. 20. REG. 12-5-2000.
 2,411,273. HUGGEE MISS YOU. INT. CL. 28. REG. 12-5-2000.
 2,411,274. DS9. INT. CL. 28. REG. 12-5-2000.
 2,411,276. ITALIANIZE. INT. CL. 9. REG. 12-5-2000.
 2,411,280. SONIC RAINBOW. INT. CL. 14. REG. 12-5-2000.
 2,411,281. PTI AND DESIGN. INT. CL. 42. REG. 12-5-2000.
 2,411,282. HOME IMPROVEMENT SHOW AND DESIGN. INT. CL. 35. REG. 12-5-2000.

- 2,411,286. THUNDER BIRD SISTERS AND DESIGN. INT. CL. 9. REG. 12-5-2000.
- 2,411,290. CONFESSION. INT. CL. 3. REG. 12-5-2000.
- 2,411,291. A SIGN OF OUR HOUSEPITALITY AND DESIGN. INT. CL. 36. REG. 12-5-2000.
- 2,411,294. SPEED OF LIGHT. INT. CL. 39. REG. 12-5-2000.
- 2,411,295. SOCCER RACKET. INT. CL. 28. REG. 12-5-2000.
- 2,411,297. NIC. INT. CL. 9. REG. 12-5-2000.
- 2,411,299. BOOKPILOT. INT. CL. 9. REG. 12-5-2000.
- 2,411,300. RETIREMENT INSIGHT. INT. CL. 9. REG. 12-5-2000.
- 2,411,301. LITTLE WILLIE'S CHOCOLATE FACTORY. INT. CL. 35. REG. 12-5-2000.
- 2,411,302. BIG, SMALL, SHORT, TALL. INT. CL. 28. REG. 12-5-2000.
- 2,411,303. X ENVIRONMENT VOTERS (STYLIZED). INT. CL. 42. REG. 12-5-2000.
- 2,411,304. LOANGIANT. INT. CL. 36. REG. 12-5-2000.
- 2,411,305. LOANGIANT.COM. INT. CL. 36. REG. 12-5-2000.
- 2,411,309. WIRELESS CORNER (STYLIZED). INT. CL. 35. REG. 12-5-2000.
- 2,411,310. INSTANT BIKERS. INT. CL. 25. REG. 12-5-2000.
- 2,411,312. VECON. INT. CL. 37. REG. 12-5-2000.
- 2,411,315. TURBOVERTER. INT. CL. 9. REG. 12-5-2000.
- 2,411,316. MARKET SMART. INT. CL. 35. REG. 12-5-2000.
- 2,411,319. DOUBLESTUFF. INT. CL. 24. REG. 12-5-2000.
- 2,411,320. PRO-V COLOR. INT. CL. 3. REG. 12-5-2000.
- 2,411,322. THE OTHER MOUSE. INT. CL. 20. REG. 12-5-2000.
- 2,411,324. HHHFRRRGGH INN AND DESIGN. INT. CL. 42. REG. 12-5-2000.
- 2,411,328. HOMEOWNER'S CHOICE. INT. CL. 36. REG. 12-5-2000.
- 2,411,330. HYBRI-FLEX. INT. CL. 7. REG. 12-5-2000.
- 2,411,332. CRUNCH CHIEF. INT. CL. 28. REG. 12-5-2000.
- 2,411,333. COVER YOUR NAKEDNESS C.Y.N. AND DESIGN. INT. CL. 25. REG. 12-5-2000.
- 2,411,334. WILD GEESE IMPORTS. INT. CL. 35. REG. 12-5-2000.
- 2,411,336. PEPPERED-UP. INT. CL. 29. REG. 12-5-2000.
- 2,411,338. FIT4. INT. CL. 16. REG. 12-5-2000.
- 2,411,339. THE JOY OF COLA. INT. CL. 32. REG. 12-5-2000.
- 2,411,347. CLASSIC ELEGANCE. INT. CL. 25. REG. 12-5-2000.
- 2,411,348. EP&P. INT. CL. 16. REG. 12-5-2000.
- 2,411,349. FORTUNE FINANCIAL RETURN. INT. CL. 16. REG. 12-5-2000.
- 2,411,350. STARGLOW. INT. CL. 19. REG. 12-5-2000.
- 2,411,351. VIPER. INT. CL. 5. REG. 12-5-2000.
- 2,411,352. AMAZE GOLD (STYLIZED). INT. CL. 1. REG. 12-5-2000.
- 2,411,353. AIRCYCLER. INT. CL. 9. REG. 12-5-2000.
- 2,411,355. COTTON ESSENTIALS. INT. CL. 25. REG. 12-5-2000.
- 2,411,356. CAPP COOLA. INT. CL. 30. REG. 12-5-2000.
- 2,411,358. TALKSOFT. INT. CL. 9. REG. 12-5-2000.
- 2,411,361. GM DRIVERSITE AND DESIGN. INT. CL. 35. REG. 12-5-2000.
- 2,411,363. MEIFOOD AND DESIGN. INT. CL. 30. REG. 12-5-2000.
- 2,411,365. BIO3. INT. CL. 40. REG. 12-5-2000.
- 2,411,366. VIGOROUSMEDIA. INT. CL. 28. REG. 12-5-2000.
- 2,411,367. GATEWAY HEALTH FOUNDATION. INT. CL. 36. REG. 12-5-2000.
- 2,411,368. BIOPAINT. INT. CL. 19. REG. 12-5-2000.
- 2,411,372. M TECH. INT. CL. 16. REG. 12-5-2000.
- 2,411,373. SEA EAR AND DESIGN. INT. CL. 5. REG. 12-5-2000.
- 2,411,374. TRISENSE AND DESIGN. INT. CL. 36. REG. 12-5-2000.
- 2,411,375. LIPSCAPE.COM. INT. CL. 3. REG. 12-5-2000.
- 2,411,376. PACESET. INT. CL. 42. REG. 12-5-2000.
- 2,411,377. INFINILUX. INT. CL. 19. REG. 12-5-2000.
- 2,411,378. POTTY WIPES AND DESIGN. INT. CL. 5. REG. 12-5-2000.
- 2,411,379. EVERYDAY IS A JOURNEY. INT. CL. 35. REG. 12-5-2000.
- 2,411,380. BLACK DOG STUDIOS AND DESIGN. INT. CL. 40. REG. 12-5-2000.
- 2,411,381. MOODPLEX. INT. CL. 5. REG. 12-5-2000.
- 2,411,382. CAREGIVER'S HELPER. INT. CLS. 36 AND 42. REG. 12-5-2000.
- 2,411,384. S 123 ABC 123 ABC AND DESIGN. INT. CL. 24. REG. 12-5-2000.
- 2,411,385. C-KURE. INT. CL. 3. REG. 12-5-2000.
- 2,411,388. LEAKGUARD. INT. CL. 37. REG. 12-5-2000.
- 2,411,390. PLATO'S CLOSET BRAND NAME TEEN WEAR AND DESIGN. INT. CL. 35. REG. 12-5-2000.
- 2,411,391. INTEGRATIA. INT. CL. 42. REG. 12-5-2000.
- 2,411,393. TWO STRONG BRANDS. ONE STRONG TEAM. INT. CL. 4. REG. 12-5-2000.
- 2,411,395. TOTE STOOL. INT. CL. 20. REG. 12-5-2000.
- 2,411,396. PROBEMAX. INT. CL. 9. REG. 12-5-2000.
- 2,411,397. WAVEDIRECT. INT. CL. 35. REG. 12-5-2000.
- 2,411,398. EAGLE VIEW VINEYARD. INT. CL. 33. REG. 12-5-2000.
- 2,411,399. CAHTO PEAK VINEYARD. INT. CL. 33. REG. 12-5-2000.
- 2,411,400. EMERALD POOL VINEYARD. INT. CL. 33. REG. 12-5-2000.
- 2,411,402. NETFOLIO. INT. CL. 36. REG. 12-5-2000.
- 2,411,403. FINGERBEATZ. INT. CL. 28. REG. 12-5-2000.
- 2,411,406. THE SEARCH ENGINE FOR EVERYDAY LIFE. INT. CL. 16. REG. 12-5-2000.
- 2,411,407. FLOATER. INT. CL. 9. REG. 12-5-2000.
- 2,411,408. HIGH SEAS. INT. CL. 9. REG. 12-5-2000.
- 2,411,410. VISX THE POWER TO SEE AND DESIGN. INT. CL. 10. REG. 12-5-2000.
- 2,411,411. E-MEMORIAM. INT. CL. 42. REG. 12-5-2000.
- 2,411,412. J CONSORTIUM. INT. CL. 42. REG. 12-5-2000.
- 2,411,414. PROTECTIVEVALUE. INT. CL. 36. REG. 12-5-2000.
- 2,411,416. INTERONE MARKETING GROUP. INT. CLS. 35 AND 41. REG. 12-5-2000.
- 2,411,417. RELOC. INT. CL. 10. REG. 12-5-2000.
- 2,411,418. GX. INT. CL. 20. REG. 12-5-2000.
- 2,411,419. WINNER MANIA. INT. CL. 28. REG. 12-5-2000.
- 2,411,420. SCRIBE. INT. CL. 20. REG. 12-5-2000.
- 2,411,424. ESURG.COM. INT. CL. 42. REG. 12-5-2000.
- 2,411,425. CYCLONE FORCE 3. INT. CL. 28. REG. 12-5-2000.
- 2,411,426. WINKING AT LIFE. INT. CL. 41. REG. 12-5-2000.
- 2,411,427. WINKING AT LIFE. INT. CL. 9. REG. 12-5-2000.
- 2,411,428. THE MONEY STATEMENT. INT. CL. 36. REG. 12-5-2000.
- 2,411,430. WE KNOW HOMES. INT. CL. 36. REG. 12-5-2000.
- 2,411,435. THE RIGHT SYSTEMS. INT. CLS. 16 AND 42. REG. 12-5-2000.
- 2,411,436. TUFF-STEP. INT. CL. 25. REG. 12-5-2000.
- 2,411,438. FLEXAIRE. INT. CL. 17. REG. 12-5-2000.
- 2,411,440. RIX DIRECTORY AND GUIDE. INT. CL. 16. REG. 12-5-2000.
- 2,411,441. YOURCOUNTRYSTORE. INT. CL. 35. REG. 12-5-2000.
- 2,411,442. DISCOVER INTERACTIVE. INT. CL. 36. REG. 12-5-2000.
- 2,411,444. WOODSMAN. INT. CL. 15. REG. 12-5-2000.
- 2,411,445. PREAMFROODERS.COM. INT. CL. 42. REG. 12-5-2000.
- 2,411,446. EXPEDITION. INT. CL. 12. REG. 12-5-2000.
- 2,411,447. ZT. INT. CL. 25. REG. 12-5-2000.
- 2,411,449. ODYSSEY. INT. CL. 9. REG. 12-5-2000.
- 2,411,452. EMW (STYLIZED). INT. CL. 25. REG. 12-5-2000.
- 2,411,453. ANTICS GRILL AND GAMES. INT. CLS. 41 AND 42. REG. 12-5-2000.
- 2,411,457. KIDS HELPING KIDS. INT. CL. 25. REG. 12-5-2000.
- 2,411,458. ARAMARK EDUCATIONAL RESOURCES. INT. CLS. 35, 41 AND 42. REG. 12-5-2000.
- 2,411,460. OLGA FEATHERS. INT. CL. 25. REG. 12-5-2000.
- 2,411,461. BRAVO BY CARQUEST AND DESIGN. INT. CL. 7. REG. 12-5-2000.
- 2,411,462. LIFE MAX. INT. CLS. 11 AND 25. REG. 12-5-2000.
- 2,411,463. PAPER KNOWLEDGE. INT. CL. 16. REG. 12-5-2000.

- 2,411,465. THE MILLENNIUM HEART 2000 (STYLIZED). INT. CL. 14. REG. 12-5-2000.
- 2,411,466. 1-800-DATABASE. INT. CL. 35. REG. 12-5-2000.
- 2,411,467. MISCELLANEOUS DESIGN. INT. CL. 3. REG. 12-5-2000.
- 2,411,468. WOMEN'S INSURANCE NETWORK. INT. CL. 36. REG. 12-5-2000.
- 2,411,469. ULTRA-THIN. INT. CL. 6. REG. 12-5-2000.
- 2,411,472. MISCELLANEOUS DESIGN. INT. CLS. 21 AND 32. REG. 12-5-2000.
- 2,411,473. COLORADO PERFORMING ARTS HALL OF FAME. INT. CL. 41. REG. 12-5-2000.
- 2,411,474. CYBERMERCHANT. INT. CL. 36. REG. 12-5-2000.
- 2,411,476. LAKE COUNTY. INT. CL. 16. REG. 12-5-2000.
- 2,411,477. JDEVELOPER SUITE. INT. CL. 9. REG. 12-5-2000.
- 2,411,478. CONDENSING WESP. INT. CL. 11. REG. 12-5-2000.
- 2,411,479. NUMBER ONE IN MOTORS FOR OVER 100 YEARS. INT. CL. 7. REG. 12-5-2000.
- 2,411,480. 2INI PC. INT. CL. 9. REG. 12-5-2000.
- 2,411,481. LITTLE MISS CHOCOLATE CHIP COOKIE. INT. CL. 25. REG. 12-5-2000.
- 2,411,483. U.S. WELLNESS, LIMITED. INT. CL. 42. REG. 12-5-2000.
- 2,411,486. AUTOMATIONSOLUTIONS INTERNATIONAL. INT. CLS. 35 AND 42. REG. 12-5-2000.
- 2,411,488. LEASESOURCE. INT. CL. 36. REG. 12-5-2000.
- 2,411,492. CANCERTRIALS. INT. CL. 42. REG. 12-5-2000.
- 2,411,493. THE VALUE GROWTH INDEX. INT. CL. 16. REG. 12-5-2000.
- 2,411,495. GLITTER WRAP. INT. CL. 16. REG. 12-5-2000.
- 2,411,496. MISCELLANEOUS DESIGN. INT. CL. 9. REG. 12-5-2000.
- 2,411,497. SUPPRESS. INT. CL. 5. REG. 12-5-2000.
- 2,411,499. THERMAL ROLLERS. INT. CL. 9. REG. 12-5-2000.
- 2,411,502. AUTOLOGOUS LEUKAPHERESIS, PROCESSING, AND STORAGE. INT. CL. 42. REG. 12-5-2000.
- 2,411,503. CHICAGO PROSTATE CANCER CENTER. INT. CL. 42. REG. 12-5-2000.
- 2,411,504. WATERWAYS. INT. CL. 41. REG. 12-5-2000.
- 2,411,505. SUPERIOR BILLING SOLUTIONS. INT. CLS. 9, 35 AND 41. REG. 12-5-2000.
- 2,411,508. PAGETRACK. INT. CL. 9. REG. 12-5-2000.
- 2,411,510. EFORWARD (STYLIZED). INT. CL. 38. REG. 12-5-2000.
- 2,411,514. BEST CARAMEL EVER!. INT. CL. 30. REG. 12-5-2000.
- 2,411,515. CAROLINA PATIO WAREHOUSE. INT. CL. 35. REG. 12-5-2000.
- 2,411,517. SAFETY BATON IT REFLECTS ... IT PROTECTS. INT. CL. 28. REG. 12-5-2000.
- 2,411,518. PRESBYTERIAN HEALTH. INT. CL. 42. REG. 12-5-2000.
- 2,411,521. GAMEXECUTIVE. INT. CL. 35. REG. 12-5-2000.
- 2,411,522. THE ART INSTITUTE OF CHARLOTTE. INT. CL. 41. REG. 12-5-2000.
- 2,411,524. JUMBO ROLLER TIP. INT. CL. 10. REG. 12-5-2000.
- 2,411,526. MARLENA DE LACROIX AND DESIGN. INT. CL. 16. REG. 12-5-2000.
- 2,411,529. PECONIC PAPER. INT. CL. 35. REG. 12-5-2000.
- 2,411,530. PERSONAL DEFENSE. INT. CL. 13. REG. 12-5-2000.
- 2,411,531. TENANT LINK. INT. CL. 38. REG. 12-5-2000.
- 2,411,533. BONBONS.COM. INT. CL. 35. REG. 12-5-2000.
- 2,411,536. INTERLOCK. INT. CL. 14. REG. 12-5-2000.
- 2,411,537. THE GLOBAL LEADER IN ELECTRONIC TRANSACTION SOLUTIONS. INT. CL. 9. REG. 12-5-2000.
- 2,411,538. NATIONAL TAXPAYERS ALLIANCE. INT. CL. 42. REG. 12-5-2000.
- 2,411,540. THE CME ALLIANCE. INT. CLS. 16 AND 41. REG. 12-5-2000.
- 2,411,542. NETGIFT REGISTRY. INT. CL. 35. REG. 12-5-2000.
- 2,411,545. SILICON VALLEY DISPATCHES. INT. CL. 16. REG. 12-5-2000.
- 2,411,548. JOBMONTHLY. INT. CL. 42. REG. 12-5-2000.
- 2,411,549. LUXURY HOME BUILDER. INT. CL. 16. REG. 12-5-2000.
- 2,411,550. MILLER CALIBRATION. INT. CL. 42. REG. 12-5-2000.
- 2,411,551. CUSTOMBULK. INT. CL. 35. REG. 12-5-2000.
- 2,411,553. STONE FALLS FOUNTAINS. INT. CL. 11. REG. 12-5-2000.
- 2,411,554. CHICAGO FREE PRESS. INT. CL. 16. REG. 12-5-2000.
- 2,411,555. INDUSTRY GREEN. INT. CL. 16. REG. 12-5-2000.
- 2,411,559. JUMBO JET 2.0. INT. CL. 9. REG. 12-5-2000.
- 2,411,562. HR HOTLINE. INT. CLS. 41 AND 42. REG. 12-5-2000.
- 2,411,568. PRE GREEN-UP. INT. CL. 5. REG. 12-5-2000.
- 2,411,570. YOUR PERSONAL COMMUNICATIONS CENTER. INT. CL. 38. REG. 12-5-2000.
- 2,411,571. INFOVIEW. INT. CL. 9. REG. 12-5-2000.
- 2,411,572. BALE-EJECT. INT. CL. 7. REG. 12-5-2000.
- 2,411,575. SELECT CAST. INT. CL. 1. REG. 12-5-2000.
- 2,411,576. AUTOMOTIVE TEST REPORT. INT. CL. 16. REG. 12-5-2000.
- 2,411,577. GROOVED INSERT TECHNOLOGY. INT. CL. 28. REG. 12-5-2000.
- 2,411,582. TEETER TWIRL. INT. CL. 28. REG. 12-5-2000.
- 2,411,584. "THE MOVIE COLLECTOR'S WEBSITE". INT. CL. 35. REG. 12-5-2000.
- 2,411,585. WHITE MALLOW. INT. CL. 3. REG. 12-5-2000.
- 2,411,586. NEW YORK EMPLOYMENT LAW & PRACTICE. INT. CL. 16. REG. 12-5-2000.
- 2,411,587. AUTOMOTIVE TEST REPORT. INT. CL. 42. REG. 12-5-2000.
- 2,411,588. MOUNTAIN SPORTS PRESS. INT. CL. 41. REG. 12-5-2000.
- 2,411,590. KASTNER. INT. CL. 25. REG. 12-5-2000.
- 2,411,591. NAMES OF NEW YORK. INT. CL. 16. REG. 12-5-2000.
- 2,411,594. PREDICTIVE RESPONSE. INT. CL. 9. REG. 12-5-2000.
- 2,411,595. OPENKERNEL. INT. CL. 9. REG. 12-5-2000.
- 2,411,598. AIRSPIN. INT. CL. 6. REG. 12-5-2000.
- 2,411,599. CLUB JUST FOR TEENS. INT. CL. 36. REG. 12-5-2000.
- 2,411,600. BRAIN HEALTH CENTER. INT. CL. 41. REG. 12-5-2000.
- 2,411,601. BRAIN SCIENCE INSTITUTE. INT. CL. 41. REG. 12-5-2000.
- 2,411,602. BRAIN SCIENCE CENTER. INT. CL. 41. REG. 12-5-2000.
- 2,411,606. LOGICSUITE. INT. CL. 35. REG. 12-5-2000.
- 2,411,607. CHARM TREE. INT. CL. 14. REG. 12-5-2000.
- 2,411,610. KENSCOFF SPORTSWEAR. INT. CL. 25. REG. 12-5-2000.
- 2,411,611. LIFE WHEELS. INT. CL. 14. REG. 12-5-2000.
- 2,411,612. CRYOBANKS INTERNATIONAL. INT. CL. 42. REG. 12-5-2000.
- 2,411,613. CATHOLIC RUBBER STAMPS. INT. CL. 35. REG. 12-5-2000.
- 2,411,614. THE TOOLS EXCHANGE. INT. CL. 35. REG. 12-5-2000.
- 2,429,162. AA AND DESIGN. INT. CLS. 6, 9, 14, 16, 18 AND 20 ONLY. REG. 2-20-2001.
- 2,431,967. SEPHORA. INT. CL. 38 ONLY. REG. 2-27-2001.
- 2,447,530. G GOLFLINK AND DESIGN. INT. CL. 42 ONLY. REG. 5-1-2001.
- 2,474,771. PREMIERE MOISSON. INT. CLS. 31, 35 AND 42 ONLY. REG. 8-7-2001.
- 2,476,001. BIACORE AND DESIGN. INT. CLS. 9, 16 AND 42 ONLY. REG. 8-7-2001.
- 2,476,964. ANTONELLE AND DESIGN. INT. CLS. 3 AND 18 ONLY. REG. 8-14-2001.
- 2,477,110. EUROCLAUS. INT. CLS. 1 AND 9 ONLY. REG. 8-14-2001.
- 2,477,133. REFINITY AND DESIGN. INT. CL. 10 ONLY. REG. 8-14-2001.
- 2,477,181. HERCUNITE. INT. CL. 6 ONLY. REG. 8-14-2001.
- 2,477,430. SPATV. INT. CL. 16 ONLY. REG. 8-14-2001.

- 2,478,311. COSERV. INT. CLS. 9, 32 AND 38 ONLY. REG. 8-14-2001.
- 2,478,312. COSERV AND DESIGN. INT. CLS. 9, 32 AND 38 ONLY. REG. 8-14-2001.
- 2,478,654. CROFT & BARROW. INT. CLS. 3, 8, 20, 21 AND 28 ONLY. REG. 8-14-2001.
- 2,478,750. GRIEF RECOVERY INSTITUTE. INT. CLS. 9 AND 16 ONLY. REG. 8-21-2001.
- 2,478,849. TTS. INT. CLS. 6, 9, 11, 12, 16, 20 AND 40 ONLY. REG. 8-21-2001.
- 2,480,706. SHOP-KING. INT. CLS. 6, 9, 18 AND 22 ONLY. REG. 8-21-2001.
- 2,481,136. ROMA AND DESIGN. INT. CLS. 8 AND 18 ONLY. REG. 8-28-2001.
- 2,481,437. SERVAIR. INT. CLS. 29, 30, 31, 32 AND 33 ONLY. REG. 8-28-2001.
- 2,481,912. NORTH AMERICAN HUNTING CLUB. INT. CL. 35 ONLY. REG. 8-28-2001.
- 2,482,655. SOLUTIA. INT. CL. 4 ONLY. REG. 8-28-2001.
- 2,483,153. VITAL SIGNS. INT. CL. 25 ONLY. REG. 8-28-2001.
- 2,483,529. COMFOPORE. INT. CL. 10 ONLY. REG. 8-28-2001.
- 2,484,032. NATIONAL HEALTH AND WELLNESS CLUB. INT. CL. 35 ONLY. REG. 8-28-2001.
- 2,484,682. THE SPORTING TRADITION. INT. CL. 40 ONLY. REG. 9-4-2001.
- 2,486,428. MAX CONTROL SYSTEMS PROCESS SOLUTIONS AND DESIGN. INT. CL. 42 ONLY. REG. 9-11-2001.
- 2,499,307. HERBTHYME FARMS AND DESIGN. INT. CLS. 5, 29 AND 30 ONLY. REG. 10-23-2001.
- 2,515,373. LETTERWORKS. INT. CL. 16 ONLY. REG. 12-4-2001.
- 2,559,503. LEVELQUIK. INT. CL. 1 ONLY. REG. 4-9-2002.
- 2,599,239. MISCELLANEOUS DESIGN. INT. CL. 9 ONLY. REG. 7-23-2002.
- 2,603,744. JOYCE. INT. CL. 6 ONLY. REG. 8-6-2002.

SECTION 18

- 2,428,475. FOUNTAINHEAD. INT. CL. 41. REG. 2-13-2001.

- 2,475,276. HALOMAX. INT. CL. 11. REG. 8-7-2001.
- 2,485,926. DURACANE. INT. CL. 19. REG. 9-4-2001.
- 2,527,718. ASK AND DESIGN. INT. CL. 35. REG. 1-8-2002.
- 2,593,508. NOKIAN TYRES GET THERE AND DESIGN. INT. CL. 12. REG. 7-16-2002.
- 2,755,935. TRUVANTAGE. INT. CLS. 9 AND 42. REG. 8-26-2003.
- 2,834,149. CATCH THE NEXT WAVE!. INT. CL. 38. REG. 4-20-2004.
- 2,962,261. LITTLE PAPER COMPANY (STYLIZED). INT. CL. 16. REG. 6-14-2005.
- 3,028,542. CHERRY B (STYLIZED). INT. CL. 25. REG. 12-13-2005.

INADVERTENTLY ISSUED REGISTRATION NUMBERS

- 3,170,219. DENNY HECKER (STYLIZED). INT. CLS. 35, 36, 37 AND 39. REG. 11-7-2006. RESTORED TO SN 76-642,805.
- 3,205,369. SPAMSTOPSTANDARD CHARACTER MARK INT. CL. 42. REG. 2-6-2007. RESTORED TO SN 78-731,516.
- 3,241,348. RESON8STANDARD CHARACTER MARK INT. CL. 9. REG. 5-15-2007. RESTORED TO SN 78-629,917.
- 3,260,050. DIVIS AND DESIGN. INT. CL. 9. REG. 7-10-2007. RESTORED TO SN 78-613,755.
- 3,271,627. ROOTER EXPRESS PLUMBING & DRAIN CLEANING SERVICE AND DESIGN. INT. CL. 37. REG. 7-31-2007. RESTORED TO SN 78-670,458.
- 3,280,057. FLAMINGO AND DESIGN. INT. CL. 35. REG. 8-14-2007. RESTORED TO SN 79-016,145.
- 3,281,989. IMAINGOSTANDARD CHARACTER MARK INT. CL. 9. REG. 8-21-2007. RESTORED TO SN 77-037,966.

* * * * *

TRADEMARK REGISTRATIONS AMENDED, CORRECTED, ETC.

The designation "U.S. Cl." appearing in this section refers to the U.S. class in effect prior to Sep. 1, 1973 rather than the international class which applies to applications filed on or after that date. For adoption of international classification see notice in the OFFICIAL GAZETTE of Jun. 26, 1973 (911 O.G. TM 210).

Any change to the registration will be indicated at the bottom of each entry under ELEMENTS AMENDED, CORRECTED OR RESTRICTED. With the exception of changes to the goods and services, additions to the registration will appear in asterisks and deletions of the registration will appear in brackets. Elements which are only changed will be listed with no punctuation. As to the goods/services statement, amendments to the goods/services will appear in asterisks and deletions will appear in brackets. In addition if any change to the goods/services occurs, the element "Goods/Services" will be listed under ELEMENTS AMENDED, CORRECTED OR RESTRICTED.

824,045. REG. 2-14-1967. SANYO ELECTRIC CO., LTD. (JAPAN CORPORATION) 5-5 KEIHAN-HONDORI 2-CHOME, MORIGUCHIO CITY, OSAKA, JAPAN., SN 72-206,495. FILED 11-19-1964. PRINCIPAL REGISTER.

The logo for SANYO, featuring the word "SANYO" in a bold, sans-serif font. The letter "A" is stylized with several vertical lines passing through it.

OWNER OF JAPAN REG. NO. 594,184, DATED 7-24-1962.
INT. CLS. 7, 11 AND 12/U.S. CL. 31
FOR ELECTRIC REFRIGERATORS, ELECTRIC HOME FREEZERS, ELECTRIC BEER COOLERS, REFRIGERATING SHOW CASES, ELECTRIC ICE CREAM FREEZERS, [ELECTRIC AIR PURIFIERS], ICE MAKING MACHINES, [REFRIGERATOR COMPRESSOR AND CONDENSING UNITS,] ELECTRIC WATER COOLERS, AND THERMO-ELECTRIC REFRIGERATORS.

FIRST USE ; IN COMMERCE .
INT. CLS. 9 AND 15/U.S. CL. 36
FOR MAGNETIC TAPE RECORDERS AND REPRODUCERS, [ELECTRIC ORGANS,] AND PHONOGRAPHS.
FIRST USE ; IN COMMERCE .

ELEMENTS CORRECTED
MARK

824,591. REG. 2-21-1967. GREYER AG (SWITZERLAND CORPORATION) PARKSTRASSE 5, 4102 BINNINGEN, SWITZERLAND., SN 72-241,568. FILED 3-22-1966. PRINCIPAL REGISTER.

FENJAL

OWNER OF SWITZERLAND REG. NO. 193518, DATED 8-14-1962.
INT. CL. 3/U.S. CLS. 1, 4, 6, 50, 51 AND 52
FOR BATH OIL AND [COLOGNE] *TOILET SOAP*.
FIRST USE ; IN COMMERCE .

ELEMENTS AMENDED
OWNER NAME
OWNER ADDRESS
CITIZENSHIP
ENTITY
GOODS/SERVICES
U.S. CLASS(ES)

1,206,936. REG. 9-7-1982. RAYNOR MFG. CO. (ILLINOIS CORPORATION) 1101 E. RIVER ROAD, P.O. BOX 448, DIXON, IL, 61021, SN 73-304,550. FILED 4-6-1981. PRINCIPAL REGISTER.

DECADE

INT. CL. 6/U.S. CL. 12
FOR STEEL-FACED OVERHEAD DOORS WITH RAISED PANELS.
FIRST USE 3-2-1981; IN COMMERCE 3-2-1981.

ELEMENTS CORRECTED
OWNER NAME
OWNER ADDRESS

1,875,605. REG. 1-24-1995. TED NUGENT'S BOWHUNTERS WORLD, INC. (MICHIGAN CORPORATION) 4008 WEST MICHIGAN AVENUE, JACKSON, MI, 49202, SN 74-359,649. FILED 2-16-1993. PRINCIPAL REGISTER.

SPIRIT OF THE WILD

INT. CL. 41/U.S. CL. 107
FOR TELEVISION PROGRAM PERTAINING TO OUTDOOR AND SPORTSMAN THEMES.
FIRST USE 12-10-1992; IN COMMERCE 12-10-1992.

ELEMENTS CORRECTED
OWNER NAME

2,036,749. REG. 2-11-1997. RAYNOR MFG. CO. (ILLINOIS CORPORATION) 1011 EAST RIVER ROAD, P.O. BOX 448, DIXON, IL, 610210448, SN 75-016,333. FILED 11-6-1995. PRINCIPAL REGISTER.

RAYNOR

OWNER OF U.S. REG. NOS. 610,228, 1,839,886 AND 1,897,401.
SEC. 2(F).
INT. CL. 6/U.S. CLS. 2, 12, 13, 14, 23, 25 AND 50

FOR METAL GARAGE DOORS.
FIRST USE 9-3-1946; IN COMMERCE 10-3-1946.

ELEMENTS CORRECTED
OWNER NAME

2,060,257. REG. 5-13-1997. FC BAYERN MUNCHEN AG (FED REP GERMANY A JOINT STOCK COMPANY) SABENER STRASSE 51, 81547 MUNCHEN, FED REP GERMANY., SN 74-556,250. FILED 8-2-1994. PRINCIPAL REGISTER.



OWNER OF FED REP GERMANY REG. NO. 2,073,755, DATED 8-2-1994.

NO CLAIM IS MADE TO THE EXCLUSIVE RIGHT TO USE "BAYERN" OR "MUNCHEN", APART FROM THE MARK AS SHOWN.

THE ENGLISH TRANSLATION OF "BAYERN" IS "BAVARIA" AND THE ENGLISH TRANSLATION OF "MUNCHEN" IS "MUNICH".

INT. CL. 6/U.S. CLS. 2, 12, 13, 14, 23, 25 AND 50

FOR [CAR BADGES, NAMELY, METAL EMBLEMS USED ON AUTOMOBILES;] METAL CAR KEY PENDANTS (NOT MADE OF PRECIOUS METAL OR PLATED); [WALL PLATES MADE OF TIN]; [AND NON-MONETARY COINS NOT OF PRECIOUS METAL].

FIRST USE ; IN COMMERCE .

INT. CL. 8/U.S. CLS. 23, 28 AND 44

FOR [POCKET KNIVES].

FIRST USE ; IN COMMERCE .

INT. CL. 9/U.S. CLS. 21, 23, 26, 36 AND 38

FOR [MAGNETICALLY CODED TELEPHONE CALLING CARDS; SETS FOR RECORDING, TRANSMISSION AND RECONSTRUCTION OF SOUND AND IMAGE, NAMELY, AUDIO AND VIDEO CASSETTE RECORDERS AND AUDIO, VIDEO AND COMPACT DISC PLAYERS;] RECORDED VIDEO TAPES, COMPACT DISCS, [AND CASSETTES] FEATURING MUSIC, TRAINING AND/OR EDUCATIONAL INSTRUCTION; AND SPECTACLE CASES.

FIRST USE ; IN COMMERCE .

INT. CL. 12/U.S. CLS. 19, 21, 23, 31, 35 AND 44

FOR [STEERING WHEELS].

FIRST USE ; IN COMMERCE .

INT. CL. 14/U.S. CLS. 2, 27, 28 AND 50

FOR CHRONOMETERS, CLOCKS AND WATCHES; STRAPS FOR WRIST WATCHES; [JEWELRY; JEWELS, NAMELY,] [PRECIOUS GEMSTONES;] [MEDALLIONS AND NON-MONETARY COINS OF PRECIOUS METAL] LAPEL PINS; [CUFFLINKS;] [TIE PINS]; [TIE CLIPS].

FIRST USE ; IN COMMERCE .

INT. CL. 16/U.S. CLS. 2, 5, 22, 23, 29, 37, 38 AND 50

FOR PRINTED MATTER, NAMELY, SPORT MAGAZINES, CATALOGUES, CALENDARS, POSTERS, [COLLECTORS' ALBUMS FOR PHOTOGRAPHS AND AUTOGRAPHS; NOTEBOOKS;] STICKERS; TRANSFERS; FOUNTAIN PENS; BALLPOINT PENS; [POSTCARDS;] WRAPPING PAPER; [BOOKMARKERS; PAPER KNIVES; PAPERWEIGHTS; PAPER COASTERS;] PLAYING CARDS; [CARRIER BAGS MADE OF PAPER; PLASTIC BAGS; SUNBLINDS MADE OF PAPER;] FLAGS MADE OF PAPER.

FIRST USE ; IN COMMERCE .

INT. CL. 18/U.S. CLS. 1, 2, 3, 22 AND 41

FOR SPORTS AND TRAINING BAGS, ALL-PURPOSE ATHLETIC BAGS; TRAVEL BAGS, SCHOOL BAGS, AND SATCHELS; COSMETIC BAGS, [BEACH BAGS], RUCKSACKS; [VANITY CASES; WALLETS;] UMBRELLAS; [SUNSHADES, NAMELY, PARASOLS; AND, WALKING STICKS].

FIRST USE ; IN COMMERCE .

INT. CL. 20/U.S. CLS. 2, 13, 22, 25, 32 AND 50

FOR SEAT CUSHIONS, [WALL PLAQUES, AND FLAGS MADE OF PLASTIC].

FIRST USE ; IN COMMERCE .

INT. CL. 21/U.S. CLS. 2, 13, 23, 29, 30, 33, 40 AND 50

FOR GOODS MADE OF GLASS, CHINA AND POTTERY FOR HOUSEHOLD AND KITCHEN UTENSILS, NAMELY, GLASSES, [BOWLS, PLATES,] CUPS; MUGS MADE OF CHINA, [PLASTIC, POLYSTYRENE OR ENAMELED METAL;] BEER GLASSES AND BEER MUGS; [COASTERS NOT OF PAPER OR TABLE LINEN; BOTTLE OPENERS; PAPER PLATES; PAPER CUPS AND PAPER MUGS].

FIRST USE ; IN COMMERCE .

INT. CL. 24/U.S. CLS. 42 AND 50

FOR BED [AND TABLE LINEN;] [BEDSPREADS; DUVET COVERS;] QUILTS; TOWELS; BATH TOWELS; CLOTH PENNANTS; CLOTH FLAGS.

FIRST USE ; IN COMMERCE .

INT. CL. 25/U.S. CLS. 22 AND 39

FOR SPORTS WEAR AND OUTER WEAR, NAMELY, SHIRTS, SWEATERS, JERSEYS, [SKIRTS,] SHORTS, TROUSERS, [AND SLACKS]; CLOTHING; UNDERWEAR; SCARVES; NECKERCHIEFS, CAPS, STOCKINGS, SOCKS, [WRISTBANDS,] HEADBANDS, NECKTIES, SUN HATS, GLOVES, FOOTBALL BOOTS, FOOTWEAR, [SHOES AND SLIPPERS].

FIRST USE ; IN COMMERCE .

INT. CL. 26/U.S. CLS. 37, 39, 40, 42 AND 50

FOR CLOTH CLUB BADGES; WOVEN AND EMBROIDED SPORTS BADGES.

INT. CL. 27/U.S. CLS. 19, 20, 37, 42 AND 50

FOR CAR FLOOR MATS.

INT. CL. 28/U.S. CLS. 22, 23, 38 AND 50

FOR GYMNASTIC AND SPORTING GOODS, NAMELY, FOOTBALLS, BALLS, [KNEEPADS AND] FOOTBALL GLOVES; GAMES AND TOYS, NAMELY, MINI TEAM BUS, PARLOR GAMES, [ACTION-TYPE TARGET GAMES], BOARD GAMES STUFFED TOYS, PLUSH TOYS AND CHILDREN'S MULTIPLE ACTIVITY TOYS.

FIRST USE ; IN COMMERCE .

INT. CL. 33/U.S. CLS. 47 AND 49

FOR [ALCOHOLIC DRINKS, NAMELY, WINE, SPARKLING WINE, AND CHAMPAGNE, EXCEPT FOR BEER].

FIRST USE ; IN COMMERCE .

INT. CL. 34/U.S. CLS. 2, 8, 9 AND 17

FOR ASHTRAYS MADE OF CHINA, [PLASTIC OR TIN; MATCHES] AND POCKET CIGARETTE LIGHTERS.

FIRST USE ; IN COMMERCE .

INT. CL. 41/U.S. CLS. 100, 101 AND 107

FOR [ORGANIZATION OF SPORTS EVENTS AND COMPETITIONS; ORGANIZATION OF PHYSICAL EDUCATION AND TRAINING LESSONS FOR GYMNASTICS].

FIRST USE ; IN COMMERCE .

ELEMENTS AMENDED
MARK

2,211,431. REG. 12-15-1998. USA.NET, INC. (DELAWARE CORPORATION) 1155 KELLY JOHNSON BLVD., COLORADO SPRINGS, CO, 80920, SN 75-091,299. FILED 4-19-1996. PRINCIPAL REGISTER.

2,407,182. REG. 11-21-2000. ADG, INC. (MICHIGAN CORPORATION) 300 EAST LONG LAKE ROAD, SUITE 311, BLOOMFIELD HILLS, MI, 48304, SN 75-639,907. FILED 2-12-1999. PRINCIPAL REGISTER.

AMERICA'S EMAIL ADDRESS

NO CLAIM IS MADE TO THE EXCLUSIVE RIGHT TO USE "AMERICA'S E-MAIL", APART FROM THE MARK AS SHOWN.

INT. CL. 38/U.S. CLS. 100, 101 AND 104
FOR TELECOMMUNICATIONS SERVICES, NAMELY, RECEIPT, STORAGE, AND FORWARDING OF ELECTRONIC MESSAGES FOR OTHERS BY ELECTRONIC TRANSMISSION.
FIRST USE 1-0-1998; IN COMMERCE 1-0-1998.

ELEMENTS AMENDED
MARK

2,272,982. REG. 8-24-1999. B.E.C., INC. (NEVADA CORPORATION) 7655 EAST EVANS, STE. 7, SCOTTSDALE, AZ, 85260, SN 75-380,497. FILED 10-28-1997. PRINCIPAL REGISTER.

LEVOLOR

INT. CL. 9/U.S. CLS. 21, 23, 26, 36 AND 38
FOR ELECTRONIC WATER LEVEL CONTROLLER FOR SWIMMING POOLS, COOLING TOWERS AND PONDS.
FIRST USE 3-1-1998; IN COMMERCE 3-1-1998.

ELEMENTS CORRECTED
OWNER NAME

2,393,658. REG. 10-10-2000. RAYTRON ENTERPRISES, INC. OF FLORIDA (FLORIDA CORPORATION), DBA FANTASTIC SAMS, 1000 112TH CIRCLE NORTH, SUITE 1400, ST. PETERSBURG, FL, 33716, SN 75-862,417. FILED 12-2-1999. PRINCIPAL REGISTER.



INT. CL. 42/U.S. CLS. 100 AND 101
FOR HAIR CUTTING, HAIR STYLING, HAIRDRESSING SALONS, AND HAIRDRESSING SERVICES.
FIRST USE 9-18-1999; IN COMMERCE 9-18-1999.

ELEMENTS CORRECTED
OWNER NAME



NO CLAIM IS MADE TO THE EXCLUSIVE RIGHT TO USE "DENTAL CENTER", APART FROM THE MARK AS SHOWN.

INT. CL. 42/U.S. CLS. 100 AND 101
FOR DENTISTRY SERVICES.
FIRST USE 1-0-2000; IN COMMERCE 1-0-2000.

ELEMENTS AMENDED
MARK

2,469,904. REG. 7-17-2001. CONAGRA FOODS RDM, INC. (DELAWARE CORPORATION) ONE CONAGRA DRIVE, OMAHA, NE, 68102, SN 75-102,449. FILED 5-10-1996. PRINCIPAL REGISTER.



OWNER OF U.S. REG. NOS. 680,882, 850,687 AND OTHERS.

INT. CL. 29/U.S. CL. 46
FOR FROZEN PREPARED CHICKEN BREASTS, CHICKEN PATTIES, CHICKEN NUGGETS, CHICKEN STRIPS, CHICKEN PARTS, FRIED CHICKEN, AND FRIED CHICKEN PIECES; FROZEN PREPARED DINNERS, ENTREES AND MAIN DISHES CONSISTING PRIMARILY OF BEEF OR POULTRY AND/OR VEGETABLES.
FIRST USE 12-15-2000; IN COMMERCE 12-15-2000.

INT. CL. 30/U.S. CL. 46
FOR FROZEN PREPARED DINNERS, ENTREES AND MAIN DISHES CONSISTING PRIMARILY OF PASTA; POT PIES [: CORNBREAD MIXES, PANCAKE MIXES, MUFFIN MIXES, BISCUIT MIXES; SEASONED COATING FOR BEEF, POULTRY, PORK OR FISH; FROZEN FRUIT PIES, AND FROZEN FRUIT PIES, AND FROZEN CREAM PIES].
FIRST USE 12-15-2000; IN COMMERCE 12-15-2000.

ELEMENTS AMENDED
MARK

2,491,577. REG. 9-18-2001. ADVANCED KEYBOARD TECHNOLOGIES, INC. (CALIFORNIA CORPORATION) 1563 RIALTO LANE, DAVIS, CA, 95616, SN 75-771,757. FILED P.R. 8-9-1999; AM. S.R. 2-13-2001. SUPPLEMENTAL REGISTER.

KEYBOARD INSTRUCTOR

INT. CL. 9/U.S. CLS. 21, 23, 26, 36 AND 38

FOR COMPUTER HARDWARE AND SOFTWARE FOR TEACHING STUDENTS THE ART OF TYPEWRITING. FIRST USE 9-30-1999; IN COMMERCE 9-30-1999.

ELEMENTS AMENDED
MARK

2,560,632. REG. 4-9-2002. ACCESSDATA CORP. (UTAH CORPORATION) 2500 NORTH UNIVERSITY AVENUE, PROVO, UT, 846043864, SN 76-101,442. FILED P.R. 8-2-2000; AM. S.R. 8-13-2001. SUPPLEMENTAL REGISTER.

DISTRIBUTED NETWORK ATTACK

INT. CL. 9/U.S. CLS. 21, 23, 26, 36 AND 38
FOR SOFTWARE FOR PASSWORD DECRYPTION.
FIRST USE 9-30-1999; IN COMMERCE 9-30-1999.

ELEMENTS CORRECTED
OWNER NAME

2,583,973. REG. 6-18-2002. HAINES AND COMPANY, INC (OHIO CORPORATION) 8050 FREEDOM AVE. NW, P.O. BOX 2117, N. CANTON, OH, 44720, SN 76-033,290. FILED P.R. 4-24-2000; AM. S.R. 12-21-2001. SUPPLEMENTAL REGISTER.

BUYER PROFILER

INT. CL. 35/U.S. CLS. 100, 101 AND 102
FOR BUYER BEHAVIOR MODELING AND BUYER DEMOGRAPHIC ANALYSIS FOR OTHERS.
FIRST USE 3-1-2000; IN COMMERCE 3-1-2000.

ELEMENTS CORRECTED
OWNER NAME

2,633,616. REG. 10-8-2002. ACCESSDATA CORP. (UTAH CORPORATION) 2500 NORTH UNIVERSITY AVENUE, PROVO, UT, 846043864, SN 76-276,809. FILED P.R. 6-26-2001; AM. S.R. 4-29-2002. SUPPLEMENTAL REGISTER.

FORENSIC TOOLKIT

INT. CL. 9/U.S. CLS. 21, 23, 26, 36 AND 38
FOR COMPUTER SOFTWARE, NAMELY, SOFTWARE USED TO EXAMINE COMPUTER DATA FOR GATHERING EVIDENCE.
FIRST USE 12-29-2000; IN COMMERCE 12-29-2000.

ELEMENTS CORRECTED
OWNER NAME

2,635,635. REG. 10-15-2002. RAYNOR MFG. CO. (ILLINOIS CORPORATION) 1101 EAST RIVER ROAD, P.O. BOX 448, DIXON, IL, 610210448, SN 75-467,207. FILED 4-13-1998. PRINCIPAL REGISTER.

RAYNOR FINGER PROTECTION SYSTEM

OWNER OF U.S. REG. NOS. 610,228, 2,036,749 AND OTHERS.

NO CLAIM IS MADE TO THE EXCLUSIVE RIGHT TO USE "FINGER PROTECTION SYSTEM", APART FROM THE MARK AS SHOWN.

AS TO "RAYNOR".
INT. CL. 6/U.S. CLS. 2, 12, 13, 14, 23, 25 AND 50
FOR RESIDENTIAL METAL GARAGE DOORS.
FIRST USE 0-0-1999; IN COMMERCE 0-0-1999.

ELEMENTS CORRECTED
OWNER NAME

2,709,873. REG. 4-22-2003. COMMONWEALTH BUSINESS MEDIA, INC. (DELAWARE CORPORATION) 10 LAKE DRIVE, HIGHTSTOWN, NJ, 08520, SN 76-185,692. FILED 12-22-2000. PRINCIPAL REGISTER.

COMMONWEALTH BUSINESS MEDIA

NO CLAIM IS MADE TO THE EXCLUSIVE RIGHT TO USE "BUSINESS MEDIA", APART FROM THE MARK AS SHOWN.

INT. CL. 16/U.S. CLS. 2, 5, 22, 23, 29, 37, 38 AND 50
FOR HOUSE MARK FOR MAGAZINES, NEWSLETTERS, PRINTED GUIDES AND DIRECTORIES PROVIDING INFORMATION ON [TOPICS OF GENERAL INTEREST] * TARIFFS, TRADE REGULATIONS AND TRANSPORTATION, * ON VARIOUS TRADES, BUSINESS, EDUCATION, VOCATION AND PROFESSIONAL TRAINING AND CONSUMER RESOURCES.
FIRST USE 11-10-2000; IN COMMERCE 11-10-2000.

ELEMENTS AMENDED
GOODS/SERVICES

2,724,499. REG. 6-10-2003. SUZUKI MOTOR CORPORATION (SUZUKI KABUSHIKI KAISHA) (JAPAN CORPORATION) 300 TAKATSUKA-CHO, HAMAMATSU-SHI, SHIZUOKA-KEN, JAPAN,, SN 75-531,637. FILED 8-5-1998. PRINCIPAL REGISTER.



NO CLAIM IS MADE TO THE EXCLUSIVE RIGHT TO USE "TEAM", APART FROM THE MARK AS SHOWN.

THE STIPPLING IS FOR SHADING PURPOSES AND DOES NOT INDICATE COLOR.

INT. CL. 6/U.S. CLS. 2, 12, 13, 14, 23, 25 AND 50

FOR METAL KEY HOLDERS.
 FIRST USE 1-0-1998; IN COMMERCE 8-0-1999.
 INT. CL. 16/U.S. CLS. 2, 5, 22, 23, 29, 37, 38 AND 50
 FOR [CALENDARS, POSTERS, POSTCARDS, ENVELOPES, PAMPHLETS AND BOOKS FEATURING INFORMATION ABOUT MOTOR LAND VEHICLES,] STICKERS, [AND STATIONERY].
 FIRST USE 1-0-1998; IN COMMERCE 8-0-1999.
 INT. CL. 18/U.S. CLS. 1, 2, 3, 22 AND 41
 FOR BAGS, NAMELY, TRAVELING BAGS, ATHLETIC BAGS, GYM BAGS, [LUGGAGE TRUNKS, SUITCASES, BRIEFCASES, KNAPSACKS, WALLET, KEY CASES, POUCHES, NAMELY, FELT POUCHES, DRAWSTRING POUCHES,] AND UMBRELLAS.
 FIRST USE 1-0-1998; IN COMMERCE 8-0-1999.
 INT. CL. 24/U.S. CLS. 42 AND 50
 FOR [TOWELS AND HANDKERCHIEFS].
 FIRST USE 1-0-1998; IN COMMERCE 8-0-1999.
 INT. CL. 25/U.S. CLS. 22 AND 39
 FOR CLOTHING, NAMELY, T-SHIRTS, JACKETS, [PANTS, SHOES,] AND HATS.
 FIRST USE 1-0-1998; IN COMMERCE 8-0-1999.

ELEMENTS CORRECTED
 GOODS/SERVICES

2,758,549. REG. 9-2-2003. POPULUS GROUP, LLC (MICHIGAN LTD LIAB CO) 24800 DENSO DRIVE, SUITE 350, SOUTHFIELD, MI, 48076, SN 76-450,761. FILED 9-11-2002. PRINCIPAL REGISTER.

POPULUS GROUP

NO CLAIM IS MADE TO THE EXCLUSIVE RIGHT TO USE "GROUP", APART FROM THE MARK AS SHOWN.
 INT. CL. 35/U.S. CLS. 100, 101 AND 102
 FOR TEMPORARY AND PERMANENT PERSONNEL RECRUITMENT AND PLACEMENT, AND BUSINESS CONSULTATION * IN THE FIELD OF TEMPORARY AND PERMANENT PERSONNEL RECRUITMENT AND PLACEMENT *.
 FIRST USE 11-1-2002; IN COMMERCE 11-1-2002.

ELEMENTS AMENDED
 GOODS/SERVICES

2,820,183. REG. 3-2-2004. RAYNOR MFG. CO. (ILLINOIS CORPORATION) 1101 EAST RIVER ROAD, P.O. BOX 448, DIXON, IL, 61021, SN 76-214,169. FILED 2-22-2001. PRINCIPAL REGISTER.

AFFINA

INT. CL. 6/U.S. CLS. 2, 12, 13, 14, 23, 25 AND 50
 FOR RESIDENTIAL STEEL GARAGE DOORS.
 FIRST USE 2-7-2002; IN COMMERCE 2-7-2002.

ELEMENTS CORRECTED
 OWNER NAME
 OWNER ADDRESS

2,822,384. REG. 3-16-2004. MINDLIN COMPANIES (NEVADA LTD LIAB CO) 1640 SOUTH SEPULVEDA BLVD., SUITE 218, LOS ANGELES, CA, 90025, SN 76-452,380. FILED 9-23-2002. PRINCIPAL REGISTER.



NO CLAIM IS MADE TO THE EXCLUSIVE RIGHT TO USE "COMPANIES", APART FROM THE MARK AS SHOWN.
 INT. CL. 35/U.S. CLS. 100, 101 AND 102
 FOR CONSULTATION IN THE FIELD OF BUSINESS ASSET ACQUISITIONS.
 FIRST USE 5-0-2002; IN COMMERCE 5-0-2002.
 INT. CL. 36/U.S. CLS. 100, 101 AND 102
 FOR INVESTMENT SERVICES, NAMELY REAL ESTATE ASSET ACQUISITION SERVICES.
 FIRST USE 5-0-2002; IN COMMERCE 5-0-2002.
 INT. CL. 37/U.S. CLS. 100, 103 AND 106
 FOR REAL ESTATE DEVELOPMENT.
 FIRST USE 5-0-2002; IN COMMERCE 5-0-2002.

ELEMENTS AMENDED
 OWNER NAME
 OWNER ADDRESS
 ENTITY
 MARK

2,850,230. REG. 6-8-2004. MINDLIN COMPANIES, LLC (NEVADA LTD LIAB CO) 1640 SOUTH SEPULVEDA BLVD., SUITE 218, LOS ANGELES, CA, 90025, SN 76-452,379. FILED 9-23-2002. PRINCIPAL REGISTER.

MINDLIN

SEC. 2(F).
 INT. CL. 36/U.S. CLS. 100, 101 AND 102
 FOR INVESTMENT SERVICES, NAMELY ASSET ACQUISITION, CONSULTATION, DEVELOPMENT AND MANAGEMENT SERVICES.
 FIRST USE 0-0-1995; IN COMMERCE 0-0-1995.

ELEMENTS AMENDED
 OWNER NAME
 OWNER ADDRESS
 ENTITY
 MARK

2,854,261. REG. 6-15-2004. RAYNOR MFG. CO. (ILLINOIS CORPORATION) P.O. BOX 448, 1101 EAST RIVER ROAD, DIXON, IL, 61021, SN 76-214,729. FILED 2-22-2001. PRINCIPAL REGISTER.

RELANTE

INT. CL. 6/U.S. CLS. 2, 12, 13, 14, 23, 25 AND 50

FOR RESIDENTIAL STEEL GARAGE DOORS.
FIRST USE 8-27-2001; IN COMMERCE 8-27-2001.

ELEMENTS CORRECTED
OWNER NAME
OWNER ADDRESS

2,875,552. REG. 8-17-2004. XORAN TECHNOLOGIES, LLC (MICHIGAN LTD LIAB CO) 309 N. FIRST STREET, ANN ARBOR, MI, 48103, SN 78-121,996. FILED 4-16-2002. PRINCIPAL REGISTER.



NO CLAIM IS MADE TO THE EXCLUSIVE RIGHT TO USE "TECHNOLOGIES", APART FROM THE MARK AS SHOWN.

INT. CL. 10/U.S. CLS. 26, 39 AND 44
FOR MEDICAL IMAGING DEVICES, NAMELY, COMPUTED TOPOGRAPHY (CT) DEVICES FOR USE IN THE MEDICAL AND DENTAL FIELDS.
FIRST USE 2-5-2004; IN COMMERCE 3-9-2004.

ELEMENTS CORRECTED
OWNER NAME

2,882,937. REG. 9-7-2004. RAYNOR MFG. CO. (ILLINOIS CORPORATION) 1101 EAST RIVER ROAD, P.O. BOX 448, DIXON, IL, 610210448, SN 78-138,589. FILED 6-25-2002. PRINCIPAL REGISTER.



OWNER OF U.S. REG. NOS. 610,228, 2,520,691 AND OTHERS.

INT. CL. 6/U.S. CLS. 2, 12, 13, 14, 23, 25 AND 50
FOR RESIDENTIAL METAL GARAGE DOORS; METAL GARAGE DOORS; GARAGE DOORS THAT ROLL OVERHEAD; METAL ROLL SHUTTERS; METAL ROLLING WINDOW SHUTTERS; METAL WINDOW SHUFFERS.

FIRST USE 5-0-2002; IN COMMERCE 6-0-2002.
INT. CL. 9/U.S. CLS. 21, 23, 26, 36 AND 38
FOR AUTOMATIC RESIDENTIAL GARAGE DOOR SENSOR AND CONTROLLER; ELECTRONIC DOOR OPENERS; REMOTE CONTROLS FOR GARAGE DOORS.

FIRST USE 5-0-2002; IN COMMERCE 6-0-2002.
INT. CL. 16/U.S. CLS. 2, 5, 22, 23, 29, 37, 38 AND 50
FOR TRAINING MANUALS AND PRINTED MATERIALS RELATING TO SALES, INSTALLATION AND REPAIR OF COMMERCIAL AND RESIDENTIAL GARAGE DOORS.

FIRST USE 5-0-2002; IN COMMERCE 6-0-2002.
INT. CL. 41/U.S. CLS. 100, 101 AND 107

FOR EDUCATION SERVICES; NAMELY, CONDUCTING TRAINING PROGRAMS AND SEMINARS IN THE FIELD OF SALES, INSTALLATION AND REPAIR OF COMMERCIAL AND RESIDENTIAL GARAGE DOORS.
FIRST USE 5-0-2002; IN COMMERCE 6-0-2002.

ELEMENTS CORRECTED
OWNER NAME
OWNER ADDRESS

2,974,053. REG. 7-19-2005. NERNBERG, ARNOLD (UNITED STATES INDIVIDUAL) 7238 SOUTH PAINTER AVENUE, WHITTIER, CA, 90602, SN 78-320,188. FILED 10-29-2003. PRINCIPAL REGISTER.

COUCH POTATO POWER

INT. CL. 10/U.S. CLS. 26, 39 AND 44
FOR EXERCISE MACHINES FOR THERAPEUTIC PURPOSES.
FIRST USE 2-3-2005; IN COMMERCE 2-3-2005.

ELEMENTS CORRECTED
OWNER NAME

2,975,169. REG. 7-26-2005. ACTS RETIREMENT-LIFE COMMUNITIES, INC. (PENNSYLVANIA NON-PROFIT CORPORATION) 375 MORRIS ROAD, WEST POINT, PA, 19486, SN 76-514,693. FILED 5-15-2003. PRINCIPAL REGISTER.



OWNER OF U.S. REG. NO. 2,115,647.
NO CLAIM IS MADE TO THE EXCLUSIVE RIGHT TO USE "RETIREMENT LIFE COMMUNITIES", APART FROM THE MARK AS SHOWN.

INT. CL. 36/U.S. CLS. 100, 101 AND 102
FOR RENTAL OF APARTMENTS, APARTMENT HOMES, VILLAS AND CARRIAGE HOMES TO SENIOR ADULTS .

FIRST USE 4-0-1998; IN COMMERCE 4-0-1998.
INT. CL. 43/U.S. CLS. 100 AND 101
FOR PROVIDING ASSISTED LIVING FACILITIES FOR SENIOR ADULTS.

FIRST USE 4-0-1998; IN COMMERCE 4-0-1998.
INT. CL. 44/U.S. CLS. 100 AND 101
FOR NURSING SERVICES, NAMELY OPERATING SKILLED NURSING FACILITIES AND PROVIDING SKILLED NURSING CARE.

FIRST USE 4-0-1998; IN COMMERCE 4-0-1998.

ELEMENTS AMENDED
MARK

3,001,687. REG. 9-27-2005. SIGNSTOREY, INC. (DELAWARE CORPORATION) 183 SHERMAN STREET, FAIRFIELD, CT, 06824, SN 78-464,791. FILED 8-10-2004. PRINCIPAL REGISTER.

3,063,922. REG. 2-28-2006. JOHN DEWAR & SONS LTD (UNITED KINGDOM LTD LIAB CO) 1700 LONDON ROAD, GLASGOW SCOTLAND G32 8XR, UNITED KINGDOM., SN 79-008,206. FILED 1-17-2005. PRINCIPAL REGISTER.

SIGNSTOREY

WILLIAM LAWSON'S

THE MARK CONSISTS OF STANDARD CHARACTERS WITHOUT CLAIM TO ANY PARTICULAR FONT, STYLE, SIZE, OR COLOR.

INT. CL. 9/U.S. CLS. 21, 23, 26, 36 AND 38

FOR COMPUTER HARDWARE AND SOFTWARE FOR THE DEVELOPMENT, DELIVERY AND MANAGEMENT OF ADVERTISEMENT, PROMOTIONAL CONTENT AND PROGRAMMING DELIVERED VIA POINT-OF-PURCHASE MEDIA.

FIRST USE 9-30-2000; IN COMMERCE 9-30-2000.

INT. CL. 35/U.S. CLS. 100, 101 AND 102

FOR ADVERTISING, MARKETING AND PROMOTIONAL SERVICES AND CONSULTATION, NAMELY, PREPARATION, PLACEMENT AND DISSEMINATION OF ADVERTISEMENTS, PROMOTIONAL CONTENT AND PROGRAMMING FOR OTHERS VIA POINT-OF-PURCHASE COMMUNICATIONS SYSTEMS.

FIRST USE 9-30-2000; IN COMMERCE 9-30-2000.

ELEMENTS CORRECTED
OWNER NAME



3,006,908. REG. 10-18-2005. HYDRO INTERNATIONAL PLC (UNITED KINGDOM PUBLIC LIMITED COMPANY) SHEARWATER HOUSE, CLEVEDON HALL ESTATE, VICTORIA ROAD, CLEVEDON, AVON BS217RD, UNITED KINGDOM., SN 76-523,200. FILED 6-6-2003. PRINCIPAL REGISTER.

HYDRO-JET

OWNER OF UNITED KINGDOM REG. NO. 2263928, DATED 1-17-2003, EXPIRES 3-12-2011.

INT. CL. 11/U.S. CLS. 13, 21, 23, 31 AND 34

FOR COMMERCIAL SCREENING SYSTEMS AND INSTALLATIONS FOR TREATMENT OF STORM WATER AND WASTE WATER, COMPRISING FILTERS AND SCREENS; COMMERCIAL SCREENING SYSTEMS FOR USE IN SEPARATING SOLID MATTER FROM STORM WATER AND WASTE WATER, CONSISTING OF FILTERS AND SCREENS; COMMERCIAL STORM WATER CONTROL, OVERFLOW AND MANAGEMENT SYSTEMS AND INSTALLATIONS COMPRISING FILTERS AND SCREENS; COMMERCIAL DRAINAGE AND SOAK AWAY SYSTEMS AND INSTALLATIONS AND PARTS AND FITTINGS FOR THE AFORESAID.

FIRST USE 1-1-2002; IN COMMERCE 3-1-2002.

ELEMENTS CORRECTED
GOODS/SERVICES

THE MARK CONSISTS OF STANDARD CHARACTERS WITHOUT CLAIM TO ANY PARTICULAR FONT, STYLE, SIZE, OR COLOR.

OWNER OF INTERNATIONAL REGISTRATION 0664087 DATED 10-11-1996, EXPIRES 10-11-2016.

OWNER OF U.S. REG. NOS. 786,911 AND 1,061,915.

THE NAME WILLIAM LAWSON DOES NOT IDENTIFY A PARTICULAR LIVING INDIVIDUAL.

INT. CL. 33/U.S. CLS. 47 AND 49

FOR SCOTCH WHISKY.

ELEMENTS CORRECTED
NAME/PORTRAIT DESCRIPTION OR CONSENT



3,086,467. REG. 4-25-2006. STAPLES THE OFFICE SUPERSTORE, LLC (DELAWARE LIMITED LIABILITY COMPANY) 500 STAPLES DRIVE, FRAMINGHAM, MA, 01702, SN 78-436,416. FILED 6-16-2004. PRINCIPAL REGISTER.

SUPPLYING YOUR WORLD

THE MARK CONSISTS OF STANDARD CHARACTERS WITHOUT CLAIM TO ANY PARTICULAR FONT, STYLE, SIZE, OR COLOR.

INT. CL. 35/U.S. CLS. 100, 101 AND 102

FOR MAIL ORDER CATALOG SERVICES FEATURING OFFICE SUPPLIES; COMPUTERIZED ONLINE CATALOG SERVICES FEATURING OFFICE SUPPLIES.

FIRST USE 9-0-2003; IN COMMERCE 9-0-2003.

ELEMENTS CORRECTED
OWNER NAME

3,123,806. REG. 8-1-2006. HAMA FOODSERVICE GESMBH (AUSTRIA GESMBH) GITZEN 172, A-5322 HOF BEI SALZBURG, AUSTRIA., SN 79-008,875. FILED 8-17-2004. PRINCIPAL REGISTER.

3,141,462. REG. 9-12-2006. BAKER HUGHES INCORPORATED (DELAWARE CORPORATION) 3900 ESSEX LANE, SUITE 1200, HOUSTON, TX, 77027, SN 78-620,201. FILED 4-29-2005. PRINCIPAL REGISTER.

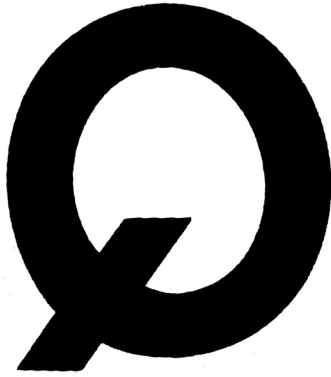

ARQUEST

THE MARK CONSISTS OF STANDARD CHARACTERS WITHOUT CLAIM TO ANY PARTICULAR FONT, STYLE, SIZE, OR COLOR.

INT. CL. 1/U.S. CLS. 1

FOR CHEMICALS THAT PREVENT DEPOSITION OF MINERAL SCALES IN THE OIL AND GAS INDUSTRY. FIRST USE 5-5-1982; IN COMMERCE 5-5-1982.

ELEMENTS CORRECTED
ENTITY

PRIORITY DATE OF 2-19-2004 IS CLAIMED.
OWNER OF INTERNATIONAL REGISTRATION 0843268
DATED 8-17-2004, EXPIRES 8-17-2014.
INT. CL. 29/U.S. CL. 46

FOR MILK AND MILK PRODUCTS, EXCLUDING ICE CREAM, ICE MILK AND FROZEN YOGURT; EDIBLE OILS AND FAT, FAT-BASED MIXTURES OF BREAD SLICES, CREAM, JAMS, MARMALADE, SOUPS.

FIRST USE ; IN COMMERCE .

INT. CL. 30/U.S. CL. 46

FOR PASTRY; CONFECTIONERY, NAMELY, CANDY; MAYONNAISE, MEAT PIES, PUDDINGS, CUSTARD.

FIRST USE ; IN COMMERCE .

INT. CL. 41/U.S. CLS. 100, 101 AND 107

FOR ARRANGING AND CONDUCTING COOKING CLASSES, SEMINARS, CONFERENCES, WORKSHOPS AND COURSES.

FIRST USE ; IN COMMERCE .

ELEMENTS CORRECTED
GOODS/SERVICES

3,166,104. REG. 10-31-2006. MASEEH, FARIBORZ (UNITED STATES INDIVIDUAL) C/O PICOCO LLC, 660 NEWPORT CENTER DRIVE, SUITE 650, NEWPORT BEACH, CA, 92660, SN 78-441,312. FILED 6-25-2004. PRINCIPAL REGISTER.



THE MARK CONSISTS OF A CIRCLE. TWELVE LINES ARE DRAWN FROM THE PERIMETER OF THE CIRCLE TOWARD ITS CENTER, SIX FROM THE UPPER RIGHT HAND QUADRANT AND SIX FROM THE UPPER LEFT. THE WORD "MASSIAH" IS WRITTEN INSIDE THE CIRCLE.

INT. CL. 36/U.S. CLS. 100, 101 AND 102

FOR ELEEMOSYNARY SERVICES IN THE FIELD OF MONETARY DONATIONS; PHILANTHROPIC SERVICES CONCERNING MONETARY DONATIONS; CHARITABLE FUND RAISING.

FIRST USE 4-24-2001; IN COMMERCE 4-24-2001.

INT. CL. 41/U.S. CLS. 100, 101 AND 107

FOR EDUCATIONAL SERVICES, NAMELY PROVIDING INCENTIVES TO PEOPLE TO DEMONSTRATE EXCELLENCE IN THE FIELD OF LIBERAL ARTS AND/OR THE SCIENCES THROUGH THE ISSUANCE OF AWARDS; PROVIDING RECOGNITION AND INCENTIVES BY THE WAY OF AWARDS TO DEMONSTRATE EXCELLENCE IN THE FIELD OF LIBERAL ARTS AND/OR THE SCIENCES.

FIRST USE 4-24-2001; IN COMMERCE 4-24-2001.

ELEMENTS CORRECTED
DATE OF FIRST USE IN COMMERCE

3,139,478. REG. 9-5-2006. ENDSLEY, ROY III (UNITED STATES INDIVIDUAL) 137 SOUTH CALUMET AVENUE, CHESTERTON, IN, 46304, SN 76-536,249. FILED 7-31-2003. PRINCIPAL REGISTER.

SIMPLICITY

INT. CL. 35/U.S. CLS. 100, 101 AND 102

FOR RETAIL STORE SERVICES FEATURING HOME FURNISHINGS, CLOTHING, JEWELRY, ARTWORKS AND GIFTS*EXCLUDING INFANT AND JUVENILE FURNITURE AND RELATED INFANT AND JUVENILE ITEMS*.

FIRST USE 5-13-2003; IN COMMERCE 5-13-2003.

ELEMENTS AMENDED
GOODS/SERVICES

3,167,825. REG. 11-7-2006. STRATUM GLOBAL, INC. (WYOMING CORPORATION) SUITE 300, 2329 W MAIN ST., LITTLETON, CO, 80120, SN 78-661,116. FILED 6-29-2005. PRINCIPAL REGISTER.

FOR MEDICAL SERVICES.
FIRST USE ; IN COMMERCE .

ELEMENTS CORRECTED
GOODS/SERVICES

TAGNET

THE MARK CONSISTS OF STANDARD CHARACTERS WITHOUT CLAIM TO ANY PARTICULAR FONT, STYLE, SIZE, OR COLOR.

INT. CL. 9/U.S. CLS. 21, 23, 26, 36 AND 38

FOR COMPUTER SOFTWARE FOR ITEM TRACKING, ITEM IDENTIFICATION, ACCESS CONTROL, DOCUMENT TRACKING, INVENTORY MANAGEMENT, THE EXCHANGE OF INFORMATION TO AND FROM A DATABASE; COMPUTER SOFTWARE FOR USE IN THE FIELD OF WIRELESS DATA COMMUNICATION, NAMELY, COMPUTER SOFTWARE FOR CONTROLLING RECEIVERS, TRANSMITTERS, INTERROGATORS, READERS, TRANSPONDERS, AND TAGS.

FIRST USE 2-1-2005; IN COMMERCE 2-1-2005.

ELEMENTS CORRECTED
OWNER NAME

3,211,594. REG. 2-20-2007. TOMTEC IMAGING SYSTEMS GMBH (FED REP GERMANY GMBH) EDISONSTRASSE 6, 85716 UNTERSCHLEIBHEIM, FED REP GERMANY., SN 79-018,636. FILED 8-9-2004. PRINCIPAL REGISTER.

TOMTEC

THE MARK CONSISTS OF STANDARD CHARACTERS WITHOUT CLAIM TO ANY PARTICULAR FONT, STYLE, SIZE, OR COLOR.

PRIORITY DATE OF 2-18-2004 IS CLAIMED.

OWNER OF INTERNATIONAL REGISTRATION 0871072 DATED 8-9-2004, EXPIRES 8-9-2014.

OWNER OF U.S. REG. NO. 1,805,194.

INT. CL. 9/U.S. CLS. 21, 23, 26, 36 AND 38

FOR COMPUTER HARDWARE AND COMPUTER SOFTWARE FOR THE COLLECTION, EDITING, ORGANIZING, MODIFYING, BOOK MARKING, TRANSMISSION, STORAGE AND SHARING OF DATA AND INFORMATION FOR USE IN RELATION TO DIGITAL ANIMATION AND SPECIAL EFFECTS OF IMAGES; COMPUTER SOFTWARE FOR ORGANIZING AND VIEWING DIGITAL IMAGES AND PHOTOGRAPHS; COMPUTER SOFTWARE FOR ULTRASOUND IMAGING DATA PROCESSING; COMPUTER MONITORS; APPARATUS FOR RECORDING, TRANSMISSION OR REPRODUCTION OF SOUND AND IMAGES .

FIRST USE ; IN COMMERCE .

INT. CL. 10/U.S. CLS. 26, 39 AND 44

FOR MEDICAL DIAGNOSTIC APPARATUS, NAMELY, TWO, THREE, AND FOUR DIMENSIONAL ULTRASOUND SYSTEMS COMPRISED OF ULTRASOUND DIAGNOSTIC APPARATUS, COMPUTER HARDWARE, AND COMPUTER SOFTWARE FOR MAKING TWO, THREE, AND FOUR DIMENSIONAL RECONSTRUCTIONS.

FIRST USE ; IN COMMERCE .

INT. CL. 42/U.S. CLS. 100 AND 101

FOR COMPUTER PROGRAMMING FOR OTHERS AND IN THE MEDICAL FIELD; RENTAL OF APPLICATION SOFTWARE; RENTAL OF COMPUTERS; RENTAL OF LABORATORY APPARATUS AND INSTRUMENTS; TECHNICAL CONSULTANCY REGARDING THE FIELD OF ULTRASOUND TECHNOLOGY.

FIRST USE ; IN COMMERCE .

INT. CL. 44/U.S. CLS. 100 AND 101

3,213,128. REG. 2-27-2007. GIGAVAC LLC (CALIFORNIA LTD LIAB CO) 555 MAPLE AVENUE, CARPINTERIA, CA, 93013, SN 78-872,718. FILED 4-28-2006. PRINCIPAL REGISTER.

EPIC

THE MARK CONSISTS OF STANDARD CHARACTERS WITHOUT CLAIM TO ANY PARTICULAR FONT, STYLE, SIZE, OR COLOR.

INT. CL. 9/U.S. CLS. 21, 23, 26, 36 AND 38

FOR BATTERY RELAYS AND CONTACTORS.

FIRST USE 10-3-2005; IN COMMERCE 10-3-2005.

ELEMENTS CORRECTED
CITIZENSHIP
ENTITY

3,216,691. REG. 3-13-2007. KABUSHIKI KAISHA NTT DOCOMO (JAPAN CORPORATION), DBA NTT DOCOMO, INC., 11-1, NAGATACHO 2-CHOME, CHIYODA-KU, TOKYO, JAPAN., SN 76-176,559. FILED 12-6-2000. PRINCIPAL REGISTER.

FOMA

PRIORITY CLAIMED UNDER SEC. 44(D) ON JAPAN APPLICATION NO. 2000-91690, FILED 8-21-2000, REG. NO. 4534335, DATED 1-11-2002, EXPIRES 1-11-2012.

INT. CL. 9/U.S. CLS. 21, 23, 26, 36 AND 38

FOR (BASED ON 44(E) FOREIGN JAPANESE REGISTRATION NUMBER 4684108) CELLULAR TELEPHONES, PDA (PERSONAL DIGITAL ASSISTANTS), COMPUTERS, VEHICLE NAVIGATION SYSTEM CONSISTING OF COMPUTER SOFTWARE FEATURING A DATABASE OF MAP COORDINATE AND LOCATIONS, A GLOBAL POSITIONING SATELLITE RECEIVER, ELECTRICAL CABLE AND DOCUMENTATION ALL SOLD AS A UNIT, COMPUTER SEARCH ENGINE SOFTWARE, COMPUTER APPLICATION SOFTWARE, DOWNLOADABLE FROM A GLOBAL COMPUTER COMMUNICATION NETWORK, FOR USE IN MANAGEMENT OF A DATABASE, FOR USE AS A SPREADSHEET AND COMPUTER SEARCH ENGINE, FOR WORD PROCESSING, COMPUTER AIDED DESIGN (CAD), INFORMATION RETRIEVAL, GAME AND UTILITY AND MAGNETICALLY ENCODED CREDIT CARDS.

FIRST USE ; IN COMMERCE .

INT. CL. 38/U.S. CLS. 100, 101 AND 104

FOR (BASED ON 44(E) FOREIGN JAPANESE REGISTRATION NUMBER 4684108) COMMUNICATION BY CELLULAR TELEPHONES, RADIO AND TELEPHONE PAGING SERVICES; PROVIDING TELECOMMUNICATIONS CONNECTIONS TO A GLOBAL COMPUTER NETWORK BY COMPUTERS; PROVIDING TELECOMMUNICATIONS CONNECTION TO A GLOBAL COMPUTER NETWORK BY CELLULAR TELEPHONES; ELECTRONIC MAIL; PROVIDING COMMUNICATIONS VALUE-ADDED NETWORK (VAN) SERVICES; ELECTRONIC TRANSMISSION OF DATA AND DOCUMENTS BY COMPUTER TERMINALS; RENTAL OF TELEPHONE APPARATUS, FACSIMILE MACHINES AND OTHER TELECOMMUNICATION APPARATUS AND INSTRUMENTS; PROVIDING MULTIPLE-USER ACCESS TO THE COMPUTER DATABASES, WEB SITES, HOME PAGES AND BULLETIN BOARDS OF OTHERS.
FIRST USE ; IN COMMERCE .

INT. CL. 42/U.S. CLS. 100 AND 101

FOR (BASED ON 44(E) FOREIGN JAPANESE REGISTRATION NUMBER 4534335) COMPUTER RENTAL; RENTAL OF COMPUTER SOFTWARE; UPDATING OF COMPUTER SOFTWARE; PROVIDING DATABASES FEATURING RESEARCH AND REFERENCE MATERIALS IN THE FIELDS OF NEWS, WEATHER, COMPUTING, COMPUTER SOFTWARE, LIFE-STYLES AND GENERAL INTEREST; COMPUTER CONSULTANCY SERVICES; COMPUTER PROGRAMMING FOR OTHERS; DESIGN OF NETWORKS AND TELECOMMUNICATION INSTALLATIONS; PROVIDING TEMPORARY USE OF ON-LINE NON-DOWNLOADABLE COMPUTER SOFTWARE FOR USE IN MANAGEMENT OF A DATABASE, FOR USE AS A SPREADSHEET AND COMPUTER SEARCH ENGINE, FOR WORD PROCESSING, COMPUTER AIDED DESIGN (CAD), INFORMATION RETRIEVAL GAME AND UTILITY; TEST AND RESEARCH RELATING TO TELECOMMUNICATION APPARATUS AND INSTRUMENTS, ELECTRONIC APPARATUS AND INSTRUMENTS, THEIR PARTS AND FITTINGS THEREOF, CELLULAR TELEPHONES, COMPUTERS AND RADIO PAGERS.
FIRST USE ; IN COMMERCE .

ELEMENTS CORRECTED
GOODS/SERVICES

3,218,293. REG. 3-13-2007. SHIMANO INC. (JAPAN CORPORATION) 3-77, OIMATSU-CHO, SAKAI-SHI; OSAKA 590-8577, JAPAN., SN 79-022,961. FILED 1-18-2006. PRINCIPAL REGISTER.

ALFINE

PRIORITY DATE OF 12-21-2005 IS CLAIMED.

OWNER OF INTERNATIONAL REGISTRATION 0882686 DATED 1-18-2006, EXPIRES 1-18-2016.

INT. CL. 9/U.S. CLS. 21, 23, 26, 36 AND 38

FOR COMPUTERS FOR BICYCLES, SPEED INDICATORS, DISTANCE MEASURING APPARATUS, NAMELY, TRIP METERS, DISTANCE RECORDING APPARATUS, KILOMETER RECORDERS FOR VEHICLES, MILEAGE RECORDERS FOR VEHICLES, APPARATUS FOR RECORDING DISTANCE, NAMELY, ODOMETERS, AUTOMATIC INDICATORS FOR PRESURE IN BICYCLE TIRES, [PROTECTIVE HELMETS FOR SPORTS, EYEGLASSES,] SUNGLASSES, GOGGLES, NAMELY, BICYCLE GOGGLES AND CASES THEREFOR, SIGNALS, NAMELY, EMERGENCY SIGNAL TRANSMITTERS, SIGNAL BELLS, EYEGLASSES FRAMES.
FIRST USE ; IN COMMERCE .

ELEMENTS CORRECTED
GOODS/SERVICES

3,219,286. REG. 3-20-2007. DREADNOUGHT, INC. (DELAWARE CORPORATION) 103 FOULK ROAD, SUITE 202, WILMINGTON, DE, 19803, SN 76-651,651. FILED 12-8-2005. PRINCIPAL REGISTER.

1833 SHOP

THE MARK CONSISTS OF STANDARD CHARACTERS WITHOUT CLAIM TO ANY PARTICULAR FONT, STYLE, SIZE, OR COLOR.

NO CLAIM IS MADE TO THE EXCLUSIVE RIGHT TO USE "SHOP", APART FROM THE MARK AS SHOWN.

INT. CL. 35/U.S. CLS. 100, 101 AND 102

FOR ON-LINE RETAIL STORE SERVICES FEATURING KITS, PARTS AND SUPPLIES FOR MUSICAL INSTRUMENTS, CLOTHING, NOVELTIES, COLLECTIBLES THAT DEPICT MUSICAL INSTRUMENT DESIGNS, AND PRINT, AUDIO AND VISUAL MEDIA IN THE FIELD OF MUSICAL INSTRUMENTS CARE, THE HISTORY OF MUSICAL INSTRUMENTS, AND HOW TO PLAY MUSICAL INSTRUMENTS.
FIRST USE 12-31-2000; IN COMMERCE 12-31-2000.

ELEMENTS CORRECTED
DATE OF FIRST USE

3,223,195. REG. 3-27-2007. PRALIBEL N.V. (BELGIUM NAAMLOZE VENNOOTSCHAP) JAGERSHOEK 21, B-8570 VICHTE, BELGIUM., SN 79-013,221. FILED 7-5-2005. PRINCIPAL REGISTER.



OWNER OF INTERNATIONAL REGISTRATION 0856401 DATED 7-5-2005, EXPIRES 7-5-2015.

NO CLAIM IS MADE TO THE EXCLUSIVE RIGHT TO USE "TOP QUALITY BELGIAN CHOCOLATES", APART FROM THE MARK AS SHOWN.

THE COLOR(S) BROWN, GOLD, WHITE IS/ARE CLAIMED AS A FEATURE OF THE MARK.

THE COLOR BROWN AND GOLD APPEARS IN THE DESIGN BACKGROUND, OUTLINES AND THE WORDS, WHITE APPEARS IN THE BUILDING AND OUTLINES.

THE ENGLISH TRANSLATION OF "CHATEAU BLANC" IS "WHITE CASTLE".

INT. CL. 30/U.S. CL. 46

FOR CHOCOLATES AND CHOCOLATE GOODS, NAMELY CHOCOLATE FIGURES, CREAMS, PRALINES, BONBONS AND CANDIES.
FIRST USE ; IN COMMERCE .

ELEMENTS CORRECTED
MARK

3,230,251. REG. 4-17-2007. SLL, INC. (CALIFORNIA CORPORATION) 2416 EAST 27TH STREET, VERNON, CA, 90058, SN 76-612,788. FILED 9-24-2004. PRINCIPAL REGISTER.

3,238,822. REG. 5-8-2007. TOYOTA BOSHOKU KABUSHIKI KAISHA (JAPAN CORPORATION) 1, 1-CHOME, TOYODA-CHO, KARIYA-SHI, AICHI-KEN, JAPAN, 448-8651, SN 78-464,065. FILED 8-9-2004. PRINCIPAL REGISTER.

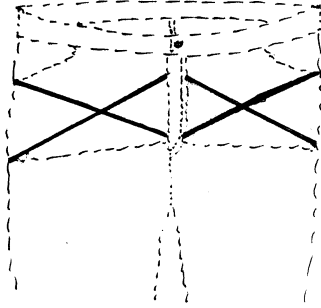

DRAWING SHOWS PAIR OF JEANS TURNED INSIDE OUT WITH DISTINCTIVE CRISSCROSS STITCHING PATTERN ON INSIDE POCKET.

SEC. 2(F).
INT. CL. 25/U.S. CLS. 22 AND 39
FOR CLOTHING, NAMELY, JEANS.
FIRST USE 12-10-2004; IN COMMERCE 12-10-2004.

ELEMENTS CORRECTED
[GOODS/SERVICES]

3,234,006. REG. 4-24-2007. SARTORIUS AG (FED REP GERMANY CORPORATION) WEENDER LANDSTRABE 94-108, D-37075 GÖTTINGEN, FED REP GERMANY., SN 76-628,348. FILED 1-19-2005. PRINCIPAL REGISTER.

DOCUCLIP

THE MARK CONSISTS OF STANDARD CHARACTERS WITHOUT CLAIM TO ANY PARTICULAR FONT, STYLE, SIZE, OR COLOR.

INT. CL. 9/U.S. CLS. 21, 23, 26, 36 AND 38
FOR SCIENTIFIC INSTRUMENTS, APPARATUS AND EQUIPMENT, NAMELY LABORATORY EQUIPMENT, NAMELY, COMBINATION DEVICES COMPRISED OF PH METERS, CONDUCTOMETERS, ION METERS, COMPUTER PRINTERS FOR DOCUMENTING CALIBRATION DATA, AND REPLACEMENT PARTS THEREFORE, ALL FOR USE IN PHYSICAL, CHEMICAL AND ELECTROCHEMICAL ANALYSIS.
FIRST USE 11-1-2005; IN COMMERCE 11-1-2005.

ELEMENTS CORRECTED
OWNER ADDRESS



OWNER OF JAPAN REG. NO. 4843165, DATED 3-4-2005, EXPIRES 3-4-2015.

THE MARK CONSISTS OF A STYLIZED DEPICTION OF THE LETTERS "TB".

INT. CL. 7/U.S. CLS. 13, 19, 21, 23, 31, 34 AND 35
FOR PARTS FOR INTERNAL COMBUSTION ENGINES FOR LAND VEHICLES; NAMELY, INTAKE MANIFOLDS, AIR CLEANERS, VALVE COVERS, CYLINDER HEAD COVERS, INTAKE DUCTS, OIL PANS, SUMP COVERS, TIMING BELT COVERS, RADIATOR PIPES AND HOSES, RADIATOR FAN SURROUNDS, STARTERS, MUFFLERS, BELTING, FANS AND CYLINDERS FOR LAND VEHICLE ENGINES; IGNITIONS FOR LAND VEHICLE ENGINES; AIR DUCTS FOR CARRYING AIR TO ENGINES; PROTECTION COVERS FOR ENGINES; ENGINES OTHER THAN FOR LAND VEHICLES; OIL FILTER FOR ENGINES; OIL STRAINERS; INTAKE RESONATORS; EXHAUST GAS RECIRCULATORS; EXHAUST EMISSION CONTROL DEVICES, NAMELY, DIESEL PARTICULATE FILTERS, CATALYTIC CONVERTERS, EXHAUST HEAT EXCHANGERS; SILENCERS FOR MOTORS AND ENGINES, FUEL VAPOR ABSORBERS ASSEMBLED WITH AIR CLEANERS FOR INTERNAL COMBUSTION ENGINES.
FIRST USE ; IN COMMERCE .

INT. CL. 12/U.S. CLS. 19, 21, 23, 31, 35 AND 44
FOR AUTOMOBILES AND STRUCTURAL PARTS; LAND VEHICLE PARTS, NAMELY, DASH PANEL INSULATION, SEATBELTS, SEATBELT WEBBING, CARGO AREA LUGGAGE AND CARGO STRAPS, CARGO AREA LUGGAGE AND CARGO NETS, CARGO AREA LUGGAGE AND CARGO TRAYS, BUMPERS, FAN SURROUNDS, FENDER LINERS, DOOR TRIM, HEADLINERS, CEILING INSULATION; AIRBAGS AND REPLACEMENT PARTS THEREOF; SEATS FOR AUTOMOBILES; SEAT COVERS; ENGINES FOR LAND VEHICLES; FITTED BODY COVERS FOR AUTOMOBILES AND SEMI-FITTED BODY COVERS FOR AUTOMOBILES; WINDOW CURTAINS OF AUTOMOBILES; STEERING WHEEL COVERS OF AUTOMOBILES; INTERIOR COMPONENTS FOR PASSENGER COMPARTMENTS OR OTHER NON-DRIVE TRAIN PARTS, NAMELY, INTERIOR PLASTIC EXTRUDED DECORATIVE AND PROTECTIVE TRIM, DRINK HOLDERS, FLOOR PANEL INSULATION.
FIRST USE ; IN COMMERCE .

INT. CL. 27/U.S. CLS. 19, 20, 37, 42 AND 50
FOR FLOOR CARPETS FOR AUTOMOBILES.

ELEMENTS CORRECTED
OWNER NAME

3,241,627. REG. 5-15-2007. SCHÄFER, CHRISTOPH (SWITZERLAND INDIVIDUAL) IM BRÜGGLI 12, ARISDORF, SWITZERLAND, 4422, SN 78-797,017. FILED 1-23-2006. PRINCIPAL REGISTER.

3,280,109. REG. 8-14-2007. HARVEY BALL SMILE LIMITED (JAPAN LTD LIAB CO) #832 MINAMIMEGURO-EN BUILDING, 4-6-16 KAMIOSAKI SHINAGAWA-KU; TOKYO 141-0021, JAPAN., SN 79-022,841. FILED 2-10-2005. PRINCIPAL REGISTER.



PRIORITY CLAIMED UNDER SEC. 44(D) ON SWITZERLAND APPLICATION NO. 50087/2006, FILED 1-6-2006, REG. NO. 542147, DATED 1-23-2006, EXPIRES 1-6-2016.

THE NAME(S), PORTRAIT(S), AND/OR SIGNATURE(S) SHOWN IN THE MARK IDENTIFIES MONICA SCHUTT AKA MONICA MOSS, WHOSE CONSENT(S) TO REGISTER IS SUBMITTED.

INT. CL. 14/U.S. CLS. 2, 27, 28 AND 50

FOR PRECIOUS METALS AND THEIR ALLOYS; JEWELRY; PRECIOUS STONES; WATCHES; ALARM CLOCK AND WALL CLOCKS.

INT. CL. 18/U.S. CLS. 1, 2, 3, 22 AND 41

FOR BAGS, NAMELY, TOTE BAGS, TRAVEL BAGS, SUIT BAGS, CARRY-ALL BAGS, CARRY-ON BAGS; HANDBAGS, ATHLETIC BAGS; LUGGAGE; STRAPS FOR LUGGAGE; LEATHER AND IMITATION LEATHER; LEATHER AND IMITATION LEATHER GOODS, NAMELY, DUFFLE BAGS, SUITCASES, SHOPPING BAGS AND COSMETIC BAGS SOLD EMPTY; WALLETS, BRIEFCASES; UMBRELLAS AND SUN UMBRELLAS.

INT. CL. 25/U.S. CLS. 22 AND 39

FOR GARMENTS, NAMELY, BELTS, CAPS, TIES, TOPS, UNDER GARMENTS, SLEEPING GARMENTS, PANTS, SKIRTS, DRESSES, SUITS, SWEATERS, SOCKS, STOCKINGS, SHIRTS, BLOUSES, SHOES, COATS, JACKETS, HATS, GLOVES, UNDERWEAR, T-SHIRTS AND SHORTS.

ELEMENTS CORRECTED
OWNER NAME

3,250,458. REG. 6-12-2007. CHALLENGER PARTNERS, LLC (OHIO LTD LIAB CO) 5970 HEISLEY ROAD, MENTOR, OH, 44060, SN 78-589,177. FILED 3-17-2005. PRINCIPAL REGISTER.



OWNER OF U.S. REG. NO. 1,176,040.
INT. CL. 12/U.S. CLS. 19, 21, 23, 31, 35 AND 44
FOR BOATS.
FIRST USE 10-4-1978; IN COMMERCE 10-4-1978.

ELEMENTS CORRECTED
OWNER NAME
ENTITY

OWNER OF INTERNATIONAL REGISTRATION 0882390 DATED 2-10-2005, EXPIRES 2-10-2015.

OWNER OF U.S. REG. NO. 3,066,172.

INT. CL. 12/U.S. CLS. 19, 21, 23, 31, 35 AND 44

FOR VESSELS AND THEIR STRUCTURAL PARTS AND FITTINGS, NAMELY, SAILING VESSELS AND THEIR STRUCTURAL PARTS AND FITTINGS; AIRCRAFT AND THEIR STRUCTURAL PARTS AND FITTINGS; RAILWAY ROLLING STOCK AND THEIR STRUCTURAL PARTS AND FITTINGS; AUTOMOBILES AND THEIR STRUCTURAL PARTS AND FITTINGS; TWO-WHEELED MOTOR VEHICLES AND THEIR STRUCTURAL PARTS AND FITTINGS; BICYCLES AND THEIR STRUCTURAL PARTS AND FITTINGS; BABY CARRIAGES PRAMS; WHEELCHAIRS; RICKSHAW; SLEIGHS AND SLEDS; WHEELBARROWS; CARTS; HORSE DRAWN CARRIAGES; BICYCLE TRAILERS, NAMELY, RIYAKAH; ROPEWAYS FOR CARGO OR FREIGHT HANDLING; UNLOADING TIPPLERS FOR TILTING RAILWAY FREIGHT CARS; MINE CAR PUSHERS; MINE CAR PULLERS; TRACTORS; NON-ELECTRIC PRIME MOVERS FOR LAND VEHICLES NOT INCLUDING THEIR PARTS, NAMELY, INTERNAL COMBUSTION ENGINES; MACHINE ELEMENTS FOR LAND VEHICLES, NAMELY, BEARINGS; AC MOTORS OR DC MOTORS FOR LAND VEHICLES NOT INCLUDING THEIR PARTS; ANTI-THEFT ALARMS FOR VEHICLES; PARACHUTES.

FIRST USE ; IN COMMERCE .

INT. CL. 30/U.S. CL. 46

FOR [COFFEE AND COCOA; UNPROCESSED COFFEE; TEA; SEASONINGS; SPICES; AROMATIC PREPARATIONS FOR FOOD NOT FROM ESSENTIAL OILS; HUSKED RICE; HUSKED OATS; HUSKED BARLEY; FLOUR FOR FOOD; GLUTEN FOR FOOD; CEREAL PREPARATIONS; STUFFED CHINESE DUMPLINGS, NAMELY, GYOZA, COOKED; SANDWICHES; STEAMED CHINESE DUMPLINGS, NAMELY, SHUMAI, COOKED; SUSHI; FRIED BALLS OF BATTER MIXED WITH SMALL PIECES OF OCTOPUS, NAMELY, TAKOYAKI; STEAMED BUNS STUFFED WITH MINCED MEAT, NAMELY, NIKU-MANJU; PREPARED HAMBURGERS; PREPARED PIZZAS; PREPARED HOT DOG SANDWICHES; PREPARED MEAT PIES; PREPARED RAVIOLI;] CONFECTIONERY, NAMELY, CANDIES, CONFECTIONERY CHIPS FOR BAKING, PASTILLES, FROZEN CONFECTIONS AND FRUIT JELLIES; [BREAD AND BUNS; INSTANT CONFECTIONERY MIXES, NAMELY, FROSTING MIXES; ICE CREAM MIXES; SHERBET MIXES; ALMOND PASTE; YEAST POWDER; FERMENTING MALTED RICE, NAMELY, KOJI; YEAST; BAKING POWDER; ICE; BINDING AGENTS FOR ICE CREAM; MEAT TENDERIZERS FOR HOUSEHOLD PURPOSES; PREPARATIONS FOR STIFFENING WHIPPED CREAM]

FIRST USE ; IN COMMERCE .

INT. CL. 34/U.S. CLS. 2, 8, 9 AND 17

OCTOBER 16, 2007

U.S. PATENT AND TRADEMARK OFFICE

TM 1441

FOR TOBACCO; CIGARETTE PAPER; SMOKERS'
ARTICLES NOT OF PRECIOUS METAL, NAMELY,
ASHTRAYS FOR SMOKERS AND LIGHTERS FOR
SMOKERS; MATCHES.
FIRST USE ; IN COMMERCE .

ELEMENTS CORRECTED
GOODS/SERVICES

* * * * *

TRADEMARK REGISTRATIONS—NEW CERTIFICATES

New Certificates issued under section 7(d) of the Trademark Act of 1946 for the unexpired term of the original registrations.

2,526,475. TRYLON TSF. INT. CLS. 9, 37 AND 42. TRYLON
MANUFACTURING COMPANY LIMITED, NORTH
YORK, ONTARIO. REG. 1-8-2002. NEW CERT. SEC. 7(D)
TO REGISTRANT.

3,211,758. ROLL YOUR OWN. INT. CL. 43. LANDRY,
HOUSTON, TX. REG. 2-20-2007. NEW CERT. SEC. 7(D)
TO REGISTRANT.

* * * * *

INDEX OF REGISTRANTS

OCTOBER 16, 2007

(Registered; Renewed; Canceled; Amended, Corrected, etc.; New Certificates; 12c Publications.)

The designation "U.S. Cl." appearing in this section refers to the U.S. class in effect prior to Sep. 1, 1973 rather than the international class which applies to applications filed on or after that date. For adoption of international classification see notice in the OFFICIAL GAZETTE of Jun. 26, 1973 (911 O.G. TM 210).

(LENDER AND LENDER'S AGENT) BANK LEUMI USA,
NEW YORK 10017, NY AND (LENDER) BANK HAPOA-
LIM, B.M., NEW YORK, NY:
2,410,997, CANC. INT. CL. 25.
"BIS" BUSZ, PSZCZOLA, STARKO SPOLKA JAWNA, BIELS-
KO-BIALA, POLAND:
3,310,219, PUB. 7-31-2007. INT. CL. 28.
"LUXOFT"; LIMITED LIABILITY COMPANY, RUSSIAN
FED.:
3,312,948, PUB. 7-31-2007. MULTIPLE CLASS, INT. CLS.
9, 35, 37 AND 42.
ÖSSUR HF, 110 REYKJAVIK, ICELAND:
3,314,015, INT. CL. 10.
A & E STORES INC., RIGDFIELD, NJ:
1,419,522, CANC. INT. CL. 42.
A AND E FOUNDATION LLC, ISSAQUAH, WA:
3,312,407, PUB. 7-31-2007. INT. CL. 36.
A FRESH TACK, LLC, SEVERNA PARK, MD:
3,312,309, PUB. 7-31-2007. INT. CL. 28.
A HAND OF HOPE, INC., PHOENIX, AZ:
3,314,486, INT. CL. 45.
A J BARBATO, OAKLAND PARK, FL:
3,313,240, INT. CL. 32.
A MAJOR DIFFERENCE, INC., AURORA, CO:
3,312,373, PUB. 2-13-2007. INT. CL. 10.
A REFRESHING DISCOVERY INC., RALEIGH, NC:
3,314,200, MULTIPLE CLASS, INT. CLS. 3 AND 5.
A. RIFKIN CO., WILKES-BARRE, PA:
2,411,046, CANC. INT. CL. 6.
A.C.E. INTERNATIONAL COMPANY, INC., TAUNTON,
MA:
3,314,973, INT. CL. 9.
A.E.B. S.R.L., ITALY:
3,312,942, PUB. 7-31-2007. MULTIPLE CLASS, INT. CLS.
7, 9 AND 37.
A.J. FISHER DESIGN, EUGENE, OR:
3,310,912, PUB. 7-31-2007. INT. CL. 6.
3,310,914, PUB. 7-31-2007. INT. CL. 6.
A.M. CASTLE & CO., FRANKLIN PARK, IL:
3,314,426, INT. CL. 35.
A.V.M. SOFTWARE, INC., NEW YORK, NY:
3,310,732, PUB. 7-31-2007. MULTIPLE CLASS, INT. CLS.
35, 38 AND 42.
A-M LLC, LOVELAND, CO:
3,313,215, INT. CL. 12.
A-SKIN HOLDING B.V., NL-1078 LW AMSTERDAM, NETH-
ERLANDS:
3,312,859, PUB. 7-31-2007. MULTIPLE CLASS, INT. CLS.
5, 10, 42 AND 44.
A-TEK SERVICES INC, SPOKANE, WA:
2,410,379, CANC. INT. CL. 40.
A-1 BEST FOOD, INC., SOUTH EL MONTE, CA:
3,310,277, PUB. 7-31-2007. INT. CL. 30.
AAA CONSTRUCTION & DEVELOPMENT CORP., MIAMI,
FL:
3,312,269, PUB. 7-31-2007. INT. CL. 1.
AAIPHARMA, INC., WILMINGTON, NC:
3,314,132, MULTIPLE CLASS, INT. CLS. 40 AND 42.
AAPER ALCOHOL AND CHEMICAL COMPANY, SHELBY-
VILLE, KY:
2,169,139, REN. 9-13-07. INT. CL. 1.
2,169,161, REN. 9-13-07. INT. CL. 1.
AARD INDUSTRIES, INC., TEMECULA, CA, AARD IN-
DUSTRIES, TUSTIN, CA:
1,060,617, REN. 9-10-07. INT. CL. 6.
AARON INVESTMENT COMPANY, GREENVILLE, DE:
3,311,571, PUB. 7-31-2007. INT. CL. 35.
3,311,572, PUB. 7-31-2007. INT. CL. 35.
3,311,573, PUB. 7-31-2007. INT. CL. 35.
AARON SVENBY, SWANTON, OH:
3,312,468, PUB. 7-31-2007. MULTIPLE CLASS, INT. CLS.
16 AND 35.
ABACUS CONTROLS, INC., SOMERVILLE, NJ:
2,411,315, CANC. INT. CL. 9.
ABBA TECHNOLOGIES CORPORATION, MIAMI, FL:
3,313,631, MULTIPLE CLASS, INT. CLS. 29 AND 30.
ABBATE, ANTHONY, SANTA FE, NM:
3,311,363, PUB. 7-31-2007. INT. CL. 40.
ABBAY GROUP LTD., THE, LOMBARD, IL:
1,419,534, CANC. INT. CL. 42.
ABBIE DURKEE, INVERNESS, CA:
3,310,562, PUB. 7-31-2007. INT. CL. 25.
ABBOTT CARDIOVASCULAR SYSTEMS, INC., SANTA
CLARA, CA:
3,313,551, INT. CL. 10.
ABDEL HAMID KITTANEH, ORLAND PARK, IL:
3,312,095, PUB. 7-31-2007. INT. CL. 35.
ABERCROMBIE & FITCH TRADING CO., NEW ALBANY,
OH:
3,310,650, PUB. 7-31-2007. INT. CL. 25.
ABERDEEN PLASTICS, INC., MATAWAN, NJ:
3,313,036, MULTIPLE CLASS, INT. CLS. 9 AND 20.
ABERDEEN ROAD COMPANY, EMIGSVILLE, PA, DBA
HERCULITE PRODUCTS, INC:
2,107,104, REN. 9-7-07. INT. CL. 24.
ABNA LIMITED, LONDON, UNITED KINGDOM:
3,311,854, PUB. 7-31-2007. INT. CL. 31.
ABOUT SPORTSWEAR INC., NEW YORK, NY:
1,419,273, CANC. INT. CL. 25.
ABOUTFACE CONSULTING CORPORATION, GAINES-
VILLE, GA:
3,314,964, INT. CL. 35.
ABUNGA.COM, KNOXVILLE, TN:
3,314,879, INT. CL. 35.
ACADEMIC FUNDING FOUNDATION, WILMINGTON,
DE:
3,311,220, PUB. 7-31-2007. INT. CL. 36.
3,311,221, PUB. 7-31-2007. INT. CL. 36.
ACADEMIC SOFTWARE, INC., AUSTIN, TX:
2,410,109, CANC. INT. CL. 9.
ACADIA BOARD COMPANY, LTD., SEMINOLE, FL:
2,485,926, CANC. INT. CL. 19.
ACADIA WINDOWS & DOORS, INC., BALTIMORE, MD:
3,310,213, PUB. 7-31-2007. INT. CL. 19.
ACAPULCO RESTAURANTS, INC., CYPRESS, CA, ACA-
PULCO RESTAURANTS, INC., LONG BEACH, CA:
2,098,690, REN. 9-13-07. INT. CL. 42.
ACBEL TECHNOLOGIES, INC., SAN JOSE, CA:
2,409,834, CANC. INT. CL. 9.
ACCEDO BROADBAND AB, SWEDEN:
3,312,900, PUB. 7-31-2007. MULTIPLE CLASS, INT. CLS.
38 AND 41.

- ACCELERATED CARE PLUS CORP., RENO, NV:
1,450,593. REN. 9-13-07. INT. CL. 10.
1,450,594. REN. 9-13-07. INT. CL. 10.
- ACCELERATED CHRISTIAN EDUCATION, INC., LARGO, FL:
3,310,517, PUB. 7-31-2007. INT. CL. 41.
- ACCENT METAL SERVICES, INC., BALTIMORE, MD, R.A. HUBBARD & ASSOCIATES, INC., SEVERNA PARK, MD:
1,430,639. REN. 9-7-07. INT. CL. 42.
- ACCESS CASH INTERNATIONAL, LLC, SCOTTSDALE, AZ:
3,311,433, PUB. 7-31-2007. INT. CL. 35.
3,311,439, PUB. 7-31-2007. INT. CL. 37.
- ACCESS DATA, INC., PROVO, UT:
2,560,632, COR. INT. CL. 9.
2,633,616, COR. INT. CL. 9.
- ACCESS NURSES, INC., SAN DIEGO, CA:
3,311,157, PUB. 7-31-2007. INT. CL. 41.
- ACCESS REVERSE MORTGAGE CORPORATION, ST. PETERSBURG, FL:
3,312,357, PUB. 7-31-2007. INT. CL. 36.
- ACCOR, FRANCE:
3,312,817, PUB. 7-31-2007. INT. CL. 43.
- ACCOUNTABLE SOFTWARE, INC., WEST CHESTER, PA:
2,410,096, CANC. INT. CL. 9.
- ACCOUNTABLES FRANCHISING CORP., WOODBRIDGE, VA:
2,100,809. REN. 9-12-07. MULTIPLE CLASS, INT. CLS. 35 AND 36.
- ACCREDO HEALTH GROUP, INC., MEMPHIS, TN:
3,311,650, PUB. 7-31-2007. MULTIPLE CLASS, INT. CLS. 41 AND 44.
- ACCU-ASSEMBLY INCORPORATED, ANDOVER, MA:
3,313,390, INT. CL. 9.
- ACCU-TIME SYSTEMS, INC., ELLINGTON, CT:
2,038,177. REN. 9-10-07. INT. CL. 9.
- ACCURATE POLYMERS, LTD., HIGHLAND PARK, IL:
2,410,104, CANC. INT. CL. 1.
- ACHIEVE COMMUNICATIONS, INC., BOULDER, CO:
2,410,525, CANC. INT. CL. 41.
- ACHIM'S FRANCHISING, LLC, ATHENS, GA:
3,313,273, INT. CL. 43.
3,313,274, INT. CL. 43.
3,313,275, INT. CL. 35.
3,313,276, INT. CL. 35.
- ACORN ENGINEERING COMPANY, CITY OF INDUSTRY, CA:
3,311,421, PUB. 7-31-2007. INT. CL. 11.
- ACROWOOD CORPORATION, EVERETT, WA, ACROWOOD CORPORATION, EVERETT, WA:
1,461,664. REN. 9-7-07. INT. CL. 7.
- ACROWOOD CORPORATION, EVERETT, WA TO ACROWOOD CORPORATION, EVERETT, WA:
1,461,664, CANC. INT. CL. 9.
- ACROYOGA, INC., SAN FRANCISCO, CA:
3,310,847, PUB. 7-31-2007. INT. CL. 41.
- ACT OF COMMUNICATION, CULVER CITY, CA:
3,311,333, PUB. 7-31-2007. INT. CL. 9.
- ACTION ALARM SYSTEMS, INC., BALTIMORE, MD:
3,312,517, PUB. 7-31-2007. MULTIPLE CLASS, INT. CLS. 37 AND 42.
- ACTION MEDIA, INC., LAS VEGAS, NV:
3,311,238, PUB. 7-31-2007. INT. CL. 35.
3,311,239, PUB. 7-31-2007. INT. CL. 35.
- ACTIONQUEST, INC., SARASOTA, FL:
1,490,629. REN. 9-7-07. INT. CL. 42.
- ACTIVAERO GMBH, 35285 GEMÜNDEN, FED REP GERMANY:
3,312,788, PUB. 7-31-2007. MULTIPLE CLASS, INT. CLS. 9, 10, 42 AND 44.
- ACTIVE POWER, INC., AUSTIN, TX:
3,313,839, INT. CL. 9.
- ACTS RETIREMENT-LIFE COMMUNITIES, INC., WEST POINT, PA:
2,975,169, AM. MULTIPLE CLASS, INT. CLS. 36, 43 AND 44.
- ACU-HON CORP, LAS VEGAS, NV:
3,314,295, INT. CL. 37.
- ACUITY BRANDS, INC., ATLANTA, GA:
3,313,120, INT. CL. 11.
- ACULINK MORTGAGE SOLUTIONS, LLC, TAMPA, FL:
3,313,084, MULTIPLE CLASS, INT. CLS. 36 AND 42.
- ACUMEN MEDICAL, INC., SUNNYVALE, CA:
3,312,202, PUB. 7-31-2007. INT. CL. 10.
- ACUSHNET COMPANY, FAIRHAVEN, MA:
3,314,364, INT. CL. 25.
- ACUSTICA BEYMA, S.A., CHIRIVELLA, VALENCIA, SPAIN:
1,419,003, CANC. INT. CL. 9.
- ACUTE RESPIRATORY ILLNESS ASSOCIATION FOR INFANTS AND CHILDREN, INC., ENGLEWOOD CLIFFS, NJ:
2,409,974, CANC. INT. CL. 42.
- ADAMANT TECHNOLOGIES SA, SWITZERLAND:
3,312,821, PUB. 7-31-2007. MULTIPLE CLASS, INT. CLS. 11 AND 37.
- ADAMS MANUFACTURING CORPORATION, PORTERSVILLE, PA, DBA ADAMS MFG.:
1,419,218, CANC. INT. CL. 21.
- ADAMS-HARRIS, LORRAINE, NEW HAVEN, CT AND HARRIS, SHAUN L., NEW HAVEN, CT:
3,314,169, INT. CL. 37.
- ADCON TELEMETRY, INC., BOCA RATON, FL:
2,411,089, CANC. INT. CL. 9.
- ADENUS GROUP, LLC, NASHVILLE, TN:
3,311,989, PUB. 7-31-2007. MULTIPLE CLASS, INT. CLS. 9, 11, 40 AND 42.
3,311,990, PUB. 7-31-2007. MULTIPLE CLASS, INT. CLS. 37 AND 42.
- ADESSO SYSTEMS, INC., BOSTON, MA:
3,312,482, PUB. 7-31-2007. INT. CL. 42.
- ADEVA S.A., 1700 FRIBOURG 6, SWITZERLAND:
2,410,198, CANC. INT. CL. 6.
- ADG, INC., BLOOMFIELD HILLS, MI:
2,407,182, AM. INT. CL. 42.
- ADIN GOLF INTERNATIONAL, LLC, GREEN BAY, WI:
3,312,638, PUB. 7-31-2007. INT. CL. 25.
- ADKNOWLEDGE, INC., KANSAS CITY, MO:
3,313,254, INT. CL. 35.
- ADLER FELS WINERY, LLC, SANTA ROSA, CA:
3,314,802, INT. CL. 33.
- ADMBA IMPORTS INTERNATIONAL, INC., BROOKLYN, NY:
3,310,464, PUB. 7-31-2007. INT. CL. 33.
- ADMINISTRATION SYSTEMS RESEARCH CORPORATION, GRAND RAPIDS, MI AND PHYSICIANS' ORGANIZATION OF WESTERN MICHIGAN, GRAND RAPIDS, MI:
2,409,961, CANC. INT. CL. 36.
- ADRIAN NOBRE SIMÕES, SAN MATEO, CA:
3,310,582, PUB. 7-31-2007. INT. CL. 41.
- ADRIENNE CRAGNOTTI AND LORI MANN, LOS ANGELES, CA:
3,311,014, PUB. 7-31-2007. INT. CL. 41.
- ADTECH-GESI, LLC, ALPHARETTA, GA:
3,312,142, PUB. 7-31-2007. MULTIPLE CLASS, INT. CLS. 35 AND 42.
- ADTRON CORPORATION, PHOENIX, AZ:
3,311,694, PUB. 6-6-2006. INT. CL. 9.
- ADVANCE MAGAZINE PUBLISHERS INC., NEW YORK, NY:
3,310,352, PUB. 7-31-2007. INT. CL. 16.
- ADVANCE MERCHANDISING COMPANY, INC., ROANOKE, VA:
3,312,983, INT. CL. 35.
- ADVANCE WATCH CO., LTD., LONG ISLAND CITY, NY:
1,453,155. REN. 9-9-07. INT. CL. 14.
- ADVANCED DATA PROCESSING, INC., FORT LAUDERDALE, FL:
3,311,339, PUB. 7-31-2007. INT. CL. 35.
- ADVANCED ENVIRONMENTAL DIMENSIONS, LLC, DALLAS, TX:
3,311,252, PUB. 7-31-2007. INT. CL. 42.
- ADVANCED FITNESS TECHNOLOGIES LLC, WELLESLEY, MA:
3,313,320, INT. CL. 41.

- ADVANCED KEYBOARD TECHNOLOGIES, INC., DAVIS, CA:
2,491,577, AM. INT. CL. 9.
- ADVANCED LIGHTING TECHNOLOGIES, INC., TWINSBURG, OH:
2,410,962, CANC. INT. CL. 11.
- ADVANCED RECOVERY REHABILITATION CENTER, SHERMAN OAKS, CA:
3,311,266, PUB. 7-31-2007. INT. CL. 44.
- ADVANCED SEMICONDUCTOR MANUFACTURING CORPORATION LIMITED, SHANGHAI, CHINA:
3,313,771, MULTIPLE CLASS, INT. CLS. 9 AND 40.
- ADVANCED TECHNOLOGY MATERIALS, INC., DANBURY, CT:
3,310,234, PUB. 7-31-2007. MULTIPLE CLASS, INT. CLS. 1, 6, 7, 9, 11, 22, 35, 37, 40 AND 42.
3,311,534, PUB. 7-31-2007. MULTIPLE CLASS, INT. CLS. 1 AND 6.
- ADVANSTAR COMMUNICATIONS INC., DULUTH, MN:
3,311,158, PUB. 7-31-2007. INT. CL. 16.
- ADVANTAGE ENTERTAINMENT CENTERS, INC., POMONA, NY:
3,314,460, INT. CL. 41.
- ADVANTAGE GEAR, INC., ROCKLIN, CA:
3,310,922, PUB. 7-31-2007. INT. CL. 10.
3,310,924, PUB. 7-31-2007. INT. CL. 10.
- ADVANTAGE NATIONAL BANK, ELK GROVE VILLAGE, IL:
3,314,159, INT. CL. 36.
- ADVERTACARD, LLC, BRADENTON, FL:
3,312,673, PUB. 7-31-2007. INT. CL. 20.
- ADVISOR INSIGHTS, ROCHESTER, MN:
3,311,366, PUB. 7-31-2007. INT. CL. 35.
- AEA TECHNOLOGY PLC, DIDCOT OXFORDSHIRE OX11 0RA, UNITED KINGDOM:
2,409,712, CANC. INT. CL. 9.
- AEGIS RESEARCH CORPORATION, FALLS CHURCH, VA:
2,410,008, CANC. INT. CL. 9.
- AEROBICS AND FITNESS ASSOCIATION OF AMERICA, SHERMAN OAKS, CA:
2,020,563, CANC. INT. CL. 41.
3,311,515, PUB. 7-31-2007. INT. CL. 16.
- AEROGROW INTERNATIONAL, INC., BOULDER, CO:
3,311,054, PUB. 7-31-2007. INT. CL. 16.
3,311,062, PUB. 7-31-2007. INT. CL. 9.
- AEROSPACE LUBRICANTS, INC., COLUMBUS, OH:
3,314,442, INT. CL. 4.
3,314,445, INT. CL. 4.
- AESTHETICALLY WRIGHT I LTD. PARTNERSHIP, PLANO, TX:
3,314,686, INT. CL. 3.
- AETREX WORLDWIDE INC., TEANECK, NJ:
3,313,144, MULTIPLE CLASS, INT. CLS. 10 AND 25.
- AFA PRODUCTS GROUP INC., NORTHVALE, NJ:
2,410,700, CANC. INT. CL. 9.
- AFAZE OPERATING, INC., TOTOWA, NJ:
3,310,481, PUB. 7-31-2007. INT. CL. 35.
- AFC ENTERPRISES, INC., ATLANTA, GA, AFC ENTERPRISES, INC., ATLANTA, GA:
2,091,908, REN. 9-13-07. INT. CL. 35.
- AFFILIATED WEALTH RESOURCES, INC., CARLSBAD, CA:
3,314,017, INT. CL. 36.
- AFFINION LOYALTY GROUP, INC., RICHMOND, VA:
3,314,201, INT. CL. 35.
- AFFINITY DIRECT, LLC, ENGLEWOOD CLIFFS, NJ:
3,310,445, PUB. 7-31-2007. INT. CL. 36.
- AFFINITY GROUP, INC., VENTURA, CA:
3,311,577, PUB. 7-31-2007. INT. CL. 9.
- AGAMATRIX, INC., SALEM, NH:
3,312,083, PUB. 7-31-2007. INT. CL. 44.
- AGC, INC., CLEVELAND, OH:
3,314,367, INT. CL. 16.
3,314,368, INT. CL. 16.
- AGE GROUP, LTD., NEW YORK, NY:
3,313,139, INT. CL. 18.
3,313,140, MULTIPLE CLASS, INT. CLS. 18, 20 AND 28.
- AGELESS RESEARCH LABS, FORT LAUDERDALE, FL:
3,310,457, PUB. 5-8-2007. INT. CL. 5.
- AGENCY FOR INSTRUCTIONAL TECHNOLOGY, BLOOMINGTON, IN:
3,312,171, PUB. 7-31-2007. INT. CL. 41.
- AGILE TICKETING SOLUTIONS, HERMITAGE, TN:
3,310,256, PUB. 7-31-2007. MULTIPLE CLASS, INT. CLS. 35, 39, 41 AND 42.
- AGING BACKWARDS, LLC, MIAMI, FL:
3,312,439, PUB. 7-31-2007. INT. CL. 44.
- AGM AIRFIELD GUIDANCESIGN MANUFACTURERS, INC., MANLIUS, NY:
3,313,818, INT. CL. 9.
- AGORA, INC., BALTIMORE, MD:
3,313,330, INT. CL. 36.
- AGRI-GROWTH, INC., HOLLANDALE, MN:
2,410,704, CANC. MULTIPLE CLASS, INT. CLS. 9, 16, 35, 41 AND 42.
- AGRICOLA EL ROSAL, S.A. DE C.V., NUMARAN, MEXICO:
3,314,793, INT. CL. 31.
- AGRICOLA SAN JOSE DE PERALILLO S.A., PROVIDENCIA SANTIAGO, CHILE:
3,312,194, PUB. 7-31-2007. INT. CL. 33.
- AGROINDUSTRIAS LAEPE S.A., TEGUCIGALPA, HONDURAS:
834,597, REN. 9-7-07. U.S. CL. 17 (INT. CL. 34).
- AHOLD LICENSING SA, GENEVA, SWITZERLAND:
3,313,336, INT. CL. 3.
- AIA HOUSTON, HOUSTON, TX:
3,314,965, INT. CL. 41.
- AICON SPA, ITALY:
3,312,834, PUB. 7-31-2007. MULTIPLE CLASS, INT. CLS. 12, 25, 28 AND 37.
3,312,844, PUB. 7-31-2007. MULTIPLE CLASS, INT. CLS. 12, 25, 28 AND 37.
- AIF CORPORATION, DALLAS, TX:
3,310,394, PUB. 7-10-2007. INT. CL. 14.
- AIKENS, MAI-LAN, CHAMBLEE, GA:
3,311,891, PUB. 7-31-2007. INT. CL. 35.
- AIM HI INDUSTRIES CORP., WALNUT, CA:
2,410,807, CANC. INT. CL. 7.
- AIR COMPASSION AMERICA, VIRGINIA BEACH, VA:
3,310,755, PUB. 6-26-2007. INT. CL. 39.
- AIR PRODUCTS AND CHEMICALS, INC., ALLENTOWN, PA:
3,311,619, PUB. 7-31-2007. INT. CL. 9.
- AIR SYSTEM COMPONENTS LP, DAYTON, OH:
3,312,416, PUB. 7-31-2007. INT. CL. 11.
- AIRBOSS AIR TOOL CO., LTD., TAIPING CITY, TAI-CHUNG COUNTY 411, TAIWAN:
3,311,022, PUB. 7-31-2007. INT. CL. 7.
- AJINOMOTO CO., INC., CHUO-KU, TOKYO, JAPAN:
3,313,386, INT. CL. 1.
- AKSHAY WELLNESS GROUP, INC., THE, PRINCETON, NJ:
3,310,383, PUB. 7-31-2007. INT. CL. 5.
- AKTIEBOLAGET CERNELLE, ANGELHOLM, SWEDEN, AKA A.B. CERNELLE:
822,267, REN. 9-11-07. U.S. CL. 18 (INT. CL. 5).
- AL VALENTINO, INC., EAST SETAUKET, NY:
3,311,708, PUB. 7-31-2007. INT. CL. 30.
- AL'S GARDEN ART, INC., COLTON, CA:
3,313,974, INT. CL. 19.
- AL'S PIZZA, INC., ATLANTIC BEACH, FL:
3,311,459, PUB. 7-31-2007. INT. CL. 43.
- ALABAMA LIVE, HUNTSVILLE, AL:
2,409,929, CANC. INT. CL. 42.
- ALABAMA STAFF, INC., BIRMINGHAM, AL:
3,313,158, INT. CL. 35.
- ALACER CORPORATION, FOOTHILL RANCH, CA:
3,315,005, INT. CL. 5.
3,315,006, INT. CL. 5.
3,315,007, INT. CL. 5.
- ALAIN ROYER CONSULTANT INC., BOUCHERVILLE, QUEBEC, CANADA:
3,312,211, PUB. 7-31-2007. INT. CL. 29.
- ALAMELU'S CULINARY ENTERPRISE LLC, WHITEFISH BAY, WI:
3,314,783, INT. CL. 41.

- ALAMO CHILDREN'S ADVOCACY CENTER, INC., SAN ANTONIO, TX:
3,312,667, PUB. 7-31-2007. MULTIPLE CLASS, INT. CLS. 44 AND 45.
- ALAMO GROUP INC., SEGUIN, TX, WARNER & SWASEY COMPANY, THE, CLEVELAND, OH:
639,618. REN. 9-11-07. U.S. CL. 23 (INT. CL. 7).
- ALAMO GROUP INC., SEGUIN, TX:
3,310,410, PUB. 7-31-2007. INT. CL. 7.
- ALANBY, CHARLOTTE, NC:
2,409,680, CANC. INT. CL. 25.
- ALARON TRADING CORPORATION, CHICAGO, IL:
2,410,857, CANC. INT. CL. 36.
2,410,858, CANC. INT. CL. 36.
- ALASKA STRUCTURES, INC., ANCHORAGE, AK:
3,313,841, MULTIPLE CLASS, INT. CLS. 35, 37 AND 42.
- ALBAUGH, INC., ANKENY, IA:
3,313,338, INT. CL. 5.
3,313,339, INT. CL. 5.
- ALBER CORP., POMPANO BEACH, FL:
3,310,931, PUB. 7-31-2007. INT. CL. 9.
- ALBERT JANE UBEDA, SPAIN:
3,312,895, PUB. 7-31-2007. INT. CL. 33.
- ALBERT S. HAGOOD, PORTLAND, OR:
3,313,430, INT. CL. 42.
- ALCATEL, 75008 PARIS, FRANCE:
2,409,954, CANC. INT. CL. 9.
- ALCOA, INC., PITTSBURGH, PA:
2,099,833. REN. 9-12-07. INT. CL. 6.
- ALCON, INC., HUNENBERG, SWITZERLAND:
3,312,246, PUB. 7-31-2007. INT. CL. 5.
- ALEXANDER, ADAM, LAHAINA, HI:
3,310,553, PUB. 7-31-2007. INT. CL. 9.
- ALEXANDER, H., LOS ANGELES, CA:
3,311,772, PUB. 7-31-2007. INT. CL. 3.
- ALEXION PHARMACEUTICALS, INC., CHESHIRE, CT:
3,310,448, PUB. 7-31-2007. INT. CL. 44.
- ALFORD, ARTHUR RICHARD III, BURLINGTON, MA:
3,310,667, PUB. 7-31-2007. INT. CL. 41.
- ALFRED ANGELO, INC., FORT WASHINGTON, PA:
3,313,825, INT. CL. 25.
- ALGORITHMICS TRADEMARKS LLC, WILMINGTON, DE:
3,311,666, PUB. 7-31-2007. MULTIPLE CLASS, INT. CLS. 9, 35, 36, 41 AND 42.
- ALI, CHI, HALLANDALE, FL:
3,313,159, INT. CL. 36.
- ALI, WAIEL, CARLSBAD, CA:
3,313,083, INT. CL. 21.
- ALICE CONNELLY ENTERPRISES INC., WHEATON, IL:
3,310,813, PUB. 7-31-2007. INT. CL. 35.
- ALIGNMED, INC., SANTA ANA, CA:
3,311,967, PUB. 7-31-2007. INT. CL. 10.
- ALIPIO, BYRON P., DICKINSON, TX:
3,314,292, INT. CL. 28.
- ALKINCO, ALFRED KLUGMANN INTERNATIONAL CORPORATION, NEW YORK, NY:
1,454,408. REN. 9-10-07. INT. CL. 26.
- ALL ABOUT VISION, LLC, FORT WASHINGTON, PA:
2,410,850, CANC. INT. CL. 16.
- ALL HOUSE BUYERS, LLC, PHOENIX, AZ:
3,314,532, INT. CL. 35.
- ALL IN A TOUCH, IPSWICH, MA:
3,311,037, PUB. 7-31-2007. INT. CL. 37.
- ALL KITCHENS, INC., RICHMOND, VA:
2,099,464. REN. 9-13-07. INT. CL. 29.
2,150,374. REN. 9-13-07. INT. CL. 30.
- ALL SEASON TOYS, INC., MALIBU, CA:
2,021,263, CANC. INT. CL. 28.
- ALL STAR ESSAYS, LLC, VIENNA, VA:
3,314,182, INT. CL. 41.
- ALLAYER TECHNOLOGIES CORP., SAN JOSE, CA:
2,410,053, CANC. INT. CL. 9.
- ALLEGHENY VALLEY SCHOOL, CORAOPOLIS, PA:
3,313,901, INT. CL. 25.
- ALLEGIANCE CORPORATION, MCGAW PARK, IL:
2,136,034. REN. 9-10-07. INT. CL. 10.
2,136,035. REN. 9-10-07. INT. CL. 10.
2,136,036. REN. 9-13-07. INT. CL. 10.
3,314,611, INT. CL. 10.
- ALLENSON, CHARLES, NEW YORK, NY:
3,311,588, PUB. 7-31-2007. INT. CL. 41.
- ALLERA HEALTH PRODUCTS, INC., ST. PETERSBURG, FL:
3,314,346, INT. CL. 5.
- ALLERGAN, INC., IRVINE, CA, ALLERGAN ELITE, INC., IRVINE, CA:
2,167,391. REN. 9-10-07. INT. CL. 5.
- ALLERGAN, INC., IRVINE, CA:
3,314,052, INT. CL. 1.
- ALLERTON SUPPLY COMPANY, ALLERTON, IL:
1,418,818, CANC. INT. CL. 1.
- ALLIANCE BANK, BROOMALL, PA:
3,313,156, INT. CL. 36.
- ALLIANCE FLOORING, INC., CHATTANOOGA, TN:
3,314,885, MULTIPLE CLASS, INT. CLS. 19 AND 27.
- ALLIANCE FOR CONTINUING MEDICAL EDUCATION, BIRMINGHAM, AL AND ASSOCIATION FOR HOSPITAL MEDICAL EDUCATION, BIRMINGHAM, AL AND SOCIETY FOR ACADEMIC CONTINUING MEDICAL EDUCATION, BIRMINGHAM, AL:
3,310,287, PUB. 7-31-2007. INT. CL. 16.
- ALLIANCE FOR THE ARTS, INC., NEW YORK, NY:
3,312,448, PUB. 7-31-2007. INT. CL. 41.
- ALLIANCE OF SAVINGS KLUB, INC., SAN FRANCISCO, CA:
2,527,718, CANC. INT. CL. 35.
- ALLIANCE RADIOLOGY, P.C., OVERLAND PARK, KS:
2,411,137, CANC. INT. CL. 42.
- ALLIANCE TRADING, INC., COVINGTON, LA:
3,312,214, PUB. 7-31-2007. INT. CL. 1.
3,312,376, PUB. 7-31-2007. MULTIPLE CLASS, INT. CLS. 19 AND 35.
3,312,460, PUB. 7-31-2007. INT. CL. 1.
3,312,483, PUB. 7-31-2007. INT. CL. 35.
3,313,253, INT. CL. 36.
- ALLIANT TECHSYSTEMS INC., EDINA, MN:
3,314,676, INT. CL. 13.
- ALLIED RISER OPERATIONS CORPORATION, DALLAS, TX:
2,410,244, CANC. INT. CL. 38.
2,410,245, CANC. INT. CL. 38.
- ALLIED TUBE & CONDUIT CORPORATION, HARVEY, IL:
2,089,604. REN. 9-13-07. INT. CL. 6.
- ALLIED-SIGNAL INC.:
1,419,117, CANC. INT. CL. 12.
- ALLINA HEALTH SYSTEM, MINNEAPOLIS, MN:
2,089,528. REN. 9-7-07. MULTIPLE CLASS, INT. CLS. 36, 39 AND 42.
2,089,528, CANC. MULTIPLE CLASS, INT. CLS. 16 AND 35.
- ALLION TEST LABS, INC., TAIPEI CITY, TAIWAN:
3,313,934, INT. CL. 42.
- ALLPAX PRODUCTS, INC., COVINGTON, LA:
3,313,639, MULTIPLE CLASS, INT. CLS. 7 AND 11.
- ALLRECIPES.COM, INC., SEATTLE, WA:
3,312,421, PUB. 7-31-2007. INT. CL. 41.
- ALLSTATE INSURANCE COMPANY, NORTHBROOK, IL:
3,311,621, PUB. 7-31-2007. INT. CL. 35.
3,311,622, PUB. 7-31-2007. INT. CL. 35.
- ALL3SPORTS, INC., ATLANTA, GA:
3,311,999, PUB. 4-17-2007. INT. CL. 35.
- ALPHA TECH PET INC., LEXINGTON, MA:
3,313,228, INT. CL. 3.
- ALPHATEC MANUFACTURING, INC., CARLSBAD, CA:
3,313,466, INT. CL. 10.
- ALRIC SUBA LLC, NEW YORK, NY:
3,313,728, INT. CL. 18.
- ALTA-DENA CERTIFIED DAIRY, INC., CITY OF INDUSTRY, CA TO DTMC INC, FRANKLIN PARK, IL:
2,021,379, CANC. INT. CL. 29.

ALTANA AG, BAD HOMBURG V.D. HOHE, DE 61352, FED REP GERMANY:
3,310,226, PUB. 7-31-2007. MULTIPLE CLASS, INT. CLS. 1, 2, 9, 17 AND 30.

ALTANA PHARMA AG, KONSTANZ, FED REP GERMANY:
3,313,439, INT. CL. 16.
3,313,440, INT. CL. 16.

ALTERNA HOLDINGS CORPORATION, CENTURY CITY, CA:
3,314,468, INT. CL. 3.

ALTICOR INC., ADA, MI:
3,314,114, INT. CL. 44.

ALTINBAS HOLDING ANONIM SIRKETI, TURKEY:
3,312,868, PUB. 7-31-2007. INT. CL. 36.

ALTMAN, ROSS E., BRENTWOOD, MD:
2,410,854, CANC. INT. CL. 16.

ALTO DAIRY COOPERATIVE, WAUPUN, WI:
3,311,124, PUB. 7-31-2007. INT. CL. 29.

ALTOUR INCENTIVE MANAGEMENT, INC., MESA, AZ, INCENTIVE SOLUTIONS, INC., SCOTTSDALE, AZ, DBA INNER DYNAMICS:
2,112,144, REN. 9-7-07. INT. CL. 9.

ALUMACLEAR CORPORATION, KALEVA, MI:
3,310,463, PUB. 7-31-2007. INT. CL. 2.

AMARU ENTERTAINMENT, INC., WEST HOLLYWOOD, CA:
3,314,392, INT. CL. 25.

AMASH BROTHERS L.L.C., WAYLAND, MI:
2,135,281, REN. 9-10-07. MULTIPLE CLASS, INT. CLS. 7 AND 8.

AMAZING MAGNETS, LLC, IRVINE, CA:
3,312,166, PUB. 7-31-2007. INT. CL. 9.

AMAZON TECHNOLOGIES, INC., RENO, NV:
3,312,549, PUB. 7-31-2007. INT. CL. 7.

AMCOL INTERNATIONAL CORPORATION, ARLINGTON HEIGHTS, IL:
2,411,197, CANC. INT. CL. 1.
3,313,860, INT. CL. 1.

AMEI TECHNOLOGIES, INC., WILMINGTON, DE:
3,314,454, MULTIPLE CLASS, INT. CLS. 35 AND 41.

AMEMIYA, SHOICHI, NEW YORK, NY:
3,314,113, INT. CL. 25.

AMERI-NATIONAL CORPORATION, OVERLAND PARK, KS:
3,314,813, INT. CL. 36.

AMERICA ONLINE, INC., DULLES, VA:
2,410,550, CANC. INT. CL. 36.
2,410,551, CANC. MULTIPLE CLASS, INT. CLS. 36, 41 AND 42.
2,410,552, CANC. INT. CL. 41.
2,410,553, CANC. MULTIPLE CLASS, INT. CLS. 36, 41 AND 42.
2,410,554, CANC. INT. CL. 41.
2,410,555, CANC. INT. CL. 41.

AMERICA'S FAMILY COACHES, INC., DES MOINES, IA:
3,311,190, PUB. 7-31-2007. INT. CL. 41.

AMERICA'S PROMISE - THE ALLIANCE FOR YOUTH, ALEXANDRIA, VA:
2,411,106, CANC. MULTIPLE CLASS, INT. CLS. 36 AND 42.

AMERICA'S REAL ESTATE CONNECTION, INC., WOODSTOCK, GA:
3,314,204, INT. CL. 36.

AMERICAN & EFIRD ENTERPRISES, INC., MT. HOLLY, NC:
3,311,698, PUB. 7-31-2007. INT. CL. 23.

AMERICAN ACADEMY OF ALLERGY, ASTHMA & IMMUNOLOGY, INC., MILWAUKEE, WI:
2,147,163, REN. 9-7-07. MULTIPLE CLASS, INT. CLS. 16, 36, 41 AND 42.
2,148,755, REN. 9-7-07. MULTIPLE CLASS, INT. CLS. 16, 36, 41 AND 42.

AMERICAN ACADEMY OF FAMILY PHYSICIANS, LEAWOOD, KS:
1,453,600, REN. 9-10-07. INT. CL. 41.

AMERICAN AIRLINES, FORT WORTH, TX:
2,429,162, CANC. MULTIPLE CLASS, INT. CLS. 6, 9, 14, 16, 18 AND 20.

AMERICAN AIRLINES, INC., DFW AIRPORT, TX:
2,410,868, CANC. INT. CL. 35.
2,410,869, CANC. INT. CL. 35.
2,410,870, CANC. INT. CL. 35.

AMERICAN AIRLINES, INC., DPW AIRPORT, TX:
2,410,871, CANC. INT. CL. 35.

AMERICAN ALARM & COMMUNICATIONS, INC., ARLINGTON, MA:
1,837,460, REN. 9-12-07. MULTIPLE CLASS, INT. CLS. 37 AND 42.

AMERICAN AMUSEMENTS, INC, OMAHA, NE:
3,313,409, INT. CL. 9.

AMERICAN ASSOCIATED DRUGGISTS, INC., PHOENIX, AZ, DBA UNITED DRUGS:
3,310,930, PUB. 7-31-2007. INT. CL. 35.

AMERICAN ASSOCIATION FOR MARRIAGE AND FAMILY THERAPY, ALEXANDRIA, VA:
3,312,453, PUB. 7-31-2007. MULTIPLE CLASS, INT. CLS. 16 AND 35.
3,312,455, PUB. 7-31-2007. INT. CL. 16.

AMERICAN ASSOCIATION OF PETROLEUM LANDMEN, FORT WORTH, TX:
1,419,143, CANC. INT. CL. 16.

AMERICAN AXLE & MANUFACTURING, INC., DETROIT, MI:
2,127,484, REN. 9-13-07. INT. CL. 12.
2,161,159, REN. 9-10-07. MULTIPLE CLASS, INT. CLS. 7 AND 12.

AMERICAN BANKERS INSURANCE GROUP, INC., MIAMI, FL:
2,411,382, CANC. MULTIPLE CLASS, INT. CLS. 36 AND 42.

AMERICAN BATTLE MONUMENTS COMMISSION, THE, ARLINGTON, VA:
2,410,285, CANC. INT. CL. 14.

AMERICAN BIBLE SOCIETY, NEW YORK, NY:
3,313,007, INT. CL. 16.

AMERICAN CASE COMPANY, ANN ARBOR, MI:
1,444,060, REN. 9-10-07. INT. CL. 15.

AMERICAN CHEMICAL SOCIETY, WASHINGTON, DC:
1,419,173, CANC. INT. CL. 16.

AMERICAN CLOTHING ASSOCIATES, 9940 EVERGEM, BELGIUM:
3,310,211, PUB. 7-31-2007. INT. CL. 25.

AMERICAN CONSULTING TECHNOLOGY & RESEARCH, INC., PROVO, UT:
3,311,937, PUB. 7-31-2007. INT. CL. 42.

AMERICAN DIABETES ASSOCIATION, INC., ALEXANDRIA, VA:
3,310,976, PUB. 7-31-2007. INT. CL. 36.

AMERICAN EAGLE SUPERSTORE, INC., LANSING, MI:
3,311,304, PUB. 7-31-2007. INT. CL. 13.

AMERICAN EXPRESS MARKETING & DEVELOPMENT CORP., NEW YORK, NY:
3,313,291, INT. CL. 36.
3,313,978, INT. CL. 36.

AMERICAN FAN TRAMS, INC., DALLAS, TX:
2,410,209, CANC. INT. CL. 39.

AMERICAN FIDELITY ASSURANCE COMPANY, OKLAHOMA CITY, OK:
2,410,347, CANC. INT. CL. 36.

AMERICAN GENIUS & CO., INC., NEW YORK, NY:
2,410,933, CANC. INT. CL. 24.

AMERICAN GIRL, LLC, EL SEGUNDO, CA:
3,313,563, INT. CL. 35.
3,313,564, INT. CL. 35.

AMERICAN HEALTH ASSISTANCE FOUNDATION, CLARKSBURG, MD:
3,311,559, PUB. 7-31-2007. MULTIPLE CLASS, INT. CLS. 16, 35, 36 AND 44.
3,311,560, PUB. 7-31-2007. MULTIPLE CLASS, INT. CLS. 35, 36 AND 44.

AMERICAN HOSPITAL ASSOCIATION, CHICAGO, IL:
3,312,158, PUB. 7-31-2007. INT. CL. 35.

AMERICAN HOSPITAL ASSOCIATION SOLUTIONS, INC., CHICAGO, IL:
3,310,704, PUB. 7-31-2007. INT. CL. 35.

- AMERICAN INK JET CORPORATION, BILLERICA, MA:
2,020,745, CANC. INT. CL. 16.
- AMERICAN INTERNATIONAL GROUP, INC., NEW YORK, NY:
3,311,605, PUB. 7-31-2007. INT. CL. 36.
3,314,171, INT. CL. 36.
3,314,402, INT. CL. 36.
3,314,799, INT. CL. 36.
- AMERICAN ISUZU MOTORS INC., WHITTIER, CA:
2,410,974, CANC. INT. CL. 42.
- AMERICAN JAZZ VENUES CORP., FORT LEE, NJ:
3,311,786, PUB. 7-31-2007. INT. CL. 41.
- AMERICAN LIBRARY ASSOCIATION, CHICAGO, IL:
3,312,218, PUB. 7-31-2007. MULTIPLE CLASS, INT. CLS. 35 AND 36.
- AMERICAN LUMBER STANDARD COMMITTEE, INCORPORATED, GERMANTOWN, MD:
3,312,622, PUB. 7-31-2007. MULTIPLE CLASS, INT. CLS. 35 AND 42.
- AMERICAN LUNG ASSOCIATION OF PENNSYLVANIA, HARRISBURGE, PA:
2,409,990, CANC. INT. CL. 41.
- AMERICAN LUNG ASSOCIATION OF THE UPPER MIDWEST, SPRINGFIELD, IL:
3,310,787, PUB. 7-31-2007. MULTIPLE CLASS, INT. CLS. 16 AND 41.
- AMERICAN MASTER PRODUCTS, INC., NEW HUDSON, MI:
3,311,510, PUB. 7-31-2007. INT. CL. 16.
- AMERICAN MODULAR TOOLING, L.L.C., WARREN, MI:
3,313,092, INT. CL. 9.
- AMERICAN NICKELOID COMPANY, PERU, IL:
662,774. REN. 9-10-07. U.S. CL. 14 (INT. CL. 6).
1,472,835. REN. 9-10-07. INT. CL. 6.
2,144,200. REN. 9-10-07. INT. CL. 6.
- AMERICAN NONWOVENS CORPORATION, COLUMBUS, MS:
2,409,810, CANC. INT. CL. 24.
- AMERICAN OPTOMETRIC ASSOCIATION, ST LOUIS, MO:
3,311,457, PUB. 7-31-2007. MULTIPLE CLASS, INT. CLS. 35 AND 36.
- AMERICAN PROMOTIONAL EVENTS, FLORENCE, AL:
2,089,557. REN. 9-9-07. INT. CL. 13.
- AMERICAN RESPIRATORY ALLIANCE OF WESTERN PENNSYLVANIA, CRANBERRY, PA:
3,312,402, PUB. 7-31-2007. INT. CL. 16.
- AMERICAN SEAFOODS GROUP LLC, SEATTLE, WA:
3,313,526, INT. CL. 29.
- AMERICAN SHOE WORKS LLC, BEVERLY HILLS, CA:
2,409,840, CANC. INT. CL. 25.
- AMERICAN SHOWER DOOR, LOS ANGELES, CA:
2,410,031, CANC. INT. CL. 11.
- AMERICAN SOCIETY OF CONSULTANT PHARMACISTS RESEARCH AND EDUCATION FOUNDATION, INC., ALEXANDRIA, VA:
3,313,060, INT. CL. 16.
- AMERICAN SOCIETY OF SAFETY ENGINEERS, DES PLAINES, IL:
3,311,660, PUB. 7-31-2007. INT. CL. 35.
- AMERICAN SPECIALTY HEALTH, INC., SAN DIEGO, CA:
2,410,751, CANC. INT. CL. 5.
- AMERICAN STERILIZER COMPANY, ERIE, PA:
1,418,821, CANC. INT. CL. 1.
1,418,822, CANC. INT. CL. 1.
- AMERICAN TECHNICAL CERAMICS CORPORATION, HUNTINGTON STATION, NY:
2,138,854. REN. 9-13-07. INT. CL. 9.
- AMERICAN TELECOMMUNICATION DEVICES, INC., MCLEAN, VA:
3,311,472, PUB. 7-31-2007. INT. CL. 9.
- AMERICATEL CORPORATION, MIAMI, FL:
3,313,647, INT. CL. 38.
- AMERIFIT, INC., BLOOMFIELD, CT:
2,410,436, CANC. INT. CL. 5.
- AMERILAB TECHNOLOGIES, INC., PLYMOUTH, MN:
3,314,469, INT. CL. 5.
- AMERIMED CONSULTING, COPPELL, TX:
3,311,934, PUB. 7-31-2007. INT. CL. 35.
- AMERIPRISE FINANCIAL, INC., MINNEAPOLIS, MN:
3,314,225, INT. CL. 36.
3,314,226, INT. CL. 35.
3,314,227, INT. CL. 36.
- AMERITRADE IP COMPANY, INC., OMAHA, NE:
2,411,005, CANC. MULTIPLE CLASS, INT. CLS. 36 AND 41.
- AMES MERCHANDISING CORPORATION, ROCKY HILL, CT:
2,410,722, CANC. INT. CL. 14.
- AMES TRUE TEMPER PROPERTIES, INC., WILMINGTON, DE:
3,314,903, INT. CL. 8.
3,314,905, INT. CL. 8.
- AMF BOWLING, INC., MECHANICSVILLE, VA TO QUBICAAMF WORLDWIDE, S.A.R.L., LUXEMBOURG, LUXEMBOURG:
2,020,613, CANC. INT. CL. 9.
- AMFAG - S.P.A., ITALY:
3,312,911, PUB. 7-31-2007. MULTIPLE CLASS, INT. CLS. 11 AND 17.
- AMINI, ALBERT, FOREST HILLS, NY:
2,410,991, CANC. INT. CL. 3.
- AMOCO OIL COMPANY, CHICAGO, IL:
2,411,123, CANC. INT. CL. 9.
- AMOREPACIFIC CORPORATION, SEOUL, REPUBLIC OF KOREA:
3,311,723, PUB. 5-29-2007. INT. CL. 3.
- AMP'D MOBILE, INC., LOS ANGELES, CA:
3,313,414, MULTIPLE CLASS, INT. CLS. 9 AND 38.
- AMPHENOL CORPORATION, WALLINGFORD, CT:
3,314,553, INT. CL. 9.
- AMRION, INC., BOULDER, CO:
2,411,259, CANC. INT. CL. 5.
- AMS RESEARCH CORPORATION, MINNETONKA, MN:
3,314,564, INT. CL. 10.
- AMTEC, LLC, BOCA RATON, FL:
3,311,948, PUB. 7-31-2007. INT. CL. 37.
- AMTRYKE, INC., HIGH POINT, NC:
2,409,849, CANC. INT. CL. 12.
- AMUNDSON, DEAN, SEATTLE, WA:
2,410,128, CANC. INT. CL. 42.
- AMWAY CORPORATION, ADA, MI:
2,409,721, CANC. INT. CL. 30.
- ANÍBAL JOSÉ SIMÕES COUTINHO, PORTUGAL:
3,312,972, PUB. 7-31-2007. INT. CL. 33.
- ANAWALT LUMBER CO., INC., LOS ANGELES, CA:
3,312,053, PUB. 7-31-2007. INT. CL. 35.
- ANCHOR COIN, LAS VEGAS, NV:
2,411,239, CANC. INT. CL. 9.
- ANCHOR GROUP, SACRAMENTO, CA:
2,410,986, CANC. MULTIPLE CLASS, INT. CLS. 40 AND 42.
- ANCIENT HERBS RESEARCH & DEVELOPMENT FOUNDATION, LAS VEGAS, NV:
3,313,801, INT. CL. 5.
- ANDERSEN STERILIZERS, INC., HAW RIVER, NC:
3,313,579, MULTIPLE CLASS, INT. CLS. 5 AND 10.
- ANDERSON, JOHN E., COLORADO SPRINGS, CO:
2,410,007, CANC. INT. CL. 41.
- ANDERSON, KAREN RAE, COLORADO SPRINGS, CO:
2,410,508, CANC. INT. CL. 16.
- ANDERSON, KEVIN, VALLEY VILLAGE, CA:
3,311,978, PUB. 7-31-2007. INT. CL. 3.
- ANDERSON, STEVEN J., SOUTHLAKE, TX:
3,312,004, PUB. 7-31-2007. INT. CL. 41.
- ANDIN INTERNATIONAL INC., NEW YORK, NY:
2,411,465, CANC. INT. CL. 14.
- ANDREAS KUFFERATH GMBH & CO. KG, DÜREN, FED REP GERMANY:
3,312,897, PUB. 7-31-2007. MULTIPLE CLASS, INT. CLS. 6, 7 AND 11.
- ANDREW PAPAGEORGE, CARDIFF, CA:
3,310,840, PUB. 7-31-2007. INT. CL. 16.
- ANEX ELECTRICAL COMPANY LIMITED, KWAI CHUNG, N.T., HONG KONG:
2,411,008, CANC. MULTIPLE CLASS, INT. CLS. 10 AND 11.

- ANGELAKIS, ANNA MARIA, ROCKVILLE, MD, DBA ANGELI GOURMET GREEK FOODS:
3,313,227, INT. CL. 30.
- ANGELOTTI INC., SCARBOROUGH, ONTARIO MIX 1E7, CANADA:
3,313,006, INT. CL. 13.
- ANGIODYNAMICS, INC., QUEENBURY, NY:
3,311,618, PUB. 7-31-2007. INT. CL. 10.
- ANGIOLAZ, INC., WESTMINSTER, VT:
3,310,283, PUB. 7-31-2007. INT. CL. 9.
- ANHEUSER-BUSCH, INCORPORATED, ST. LOUIS, MO:
3,312,598, PUB. 7-31-2007. INT. CL. 11.
- ANH3.COMPANY, QUINCY, IL:
3,310,458, PUB. 7-31-2007. INT. CL. 7.
- ANIMATED RESOLUTIONS LLC, CINCINNATI, OH:
2,411,018, CANC. INT. CL. 42.
- ANJ DESIGNS, LLC, ROSEVILLE, CA:
2,411,440, CANC. INT. CL. 16.
- ANNA MALLE INC., LAS VEGAS, NV:
2,410,155, CANC. MULTIPLE CLASS, INT. CLS. 9 AND 41.
- ANNAMS SYSTEMS CORPORATION, SAN RAMON, CA:
3,312,336, PUB. 7-31-2007. INT. CL. 9.
- ANSELL HEALTHCARE PRODUCTS LLC, RED BANK, NJ:
3,313,910, INT. CL. 10.
3,314,385, INT. CL. 10.
- ANSWERS IN GENESIS OF KENTUCKY, INC., HEBRON, KY:
3,312,484, PUB. 7-31-2007. INT. CL. 41.
- ANTHONY FOREST PRODUCTS COMPANY, EL DORADO, AR:
2,092,082, REN. 9-12-07. INT. CL. 19.
3,313,667, INT. CL. 19.
- ANTICA PASTERIA S.P.A., LAINATE, MILAN, ITALY:
3,310,196, PUB. 3-6-2007. MULTIPLE CLASS, INT. CLS. 29 AND 30.
- ANTIQUORUM, INC., NEW YORK, NY:
2,410,546, CANC. MULTIPLE CLASS, INT. CLS. 35 AND 42.
- ANTON MAGNET, HUNTINGTON BEACH, CA, DBA WAX MAGIC SKI PRODUCTS, THERMOS-MOSS ENGINEERING, LONG BEACH, CA:
1,069,756, REN. 9-10-07. INT. CL. 8.
- ANTON RIEMERSCHMID WEINBRENNEREI; UND LI-KÖRFABRIK GMBH & CO. KG, 85435 ERDING, FED REP GERMANY:
3,312,928, PUB. 7-31-2007. INT. CL. 33.
- ANTONIA'S FLOWERS, INC., OSTERVILLE, MA:
3,314,828, INT. CL. 3.
- ANTONIO PUIG, S.A., 08021 BARCELONA, SPAIN:
3,310,753, PUB. 7-31-2007. INT. CL. 3.
- ANTRIM DESIGN SYSTEMS, INC., SCOTTS VALLEY, CA:
2,411,030, CANC. INT. CL. 42.
- AOKI, STEVE, HOLLYWOOD, CA:
3,312,474, PUB. 2-27-2007. INT. CL. 25.
- AOL LLC, DULLES, VA:
3,310,190, PUB. 12-26-2006. MULTIPLE CLASS, INT. CLS. 38 AND 39.
3,310,191, PUB. 12-26-2006. INT. CL. 42.
3,310,193, PUB. 12-26-2006. INT. CL. 42.
3,310,194, PUB. 12-26-2006. MULTIPLE CLASS, INT. CLS. 38 AND 39.
3,311,230, PUB. 7-31-2007. INT. CL. 41.
3,311,231, PUB. 7-31-2007. INT. CL. 38.
3,311,234, PUB. 7-31-2007. INT. CL. 41.
3,311,235, PUB. 7-31-2007. INT. CL. 38.
3,315,008, INT. CL. 41.
3,315,009, INT. CL. 38.
- AON SECURITIES CORPORATION, CHICAGO, IL:
2,093,126, REN. 9-13-07. INT. CL. 36.
- APARTMENT REALTY ADVISORS, INC., ATLANTA, GA:
3,311,025, PUB. 7-31-2007. INT. CL. 36.
- APEX PEST CONTROL, INC., MERRITT ISLAND, FL:
3,314,653, MULTIPLE CLASS, INT. CLS. 19 AND 37.
- APPLAUSE MARKETING GROUP, LLC, LAWRENCEVILLE, GA:
3,312,210, PUB. 7-31-2007. MULTIPLE CLASS, INT. CLS. 36 AND 41.
- APPLE INC., CUPERTINO, CA:
2,020,113, CANC. INT. CL. 16.
- APPLETON BASEBALL CLUB, INC., APPLETON, WI:
2,087,859, REN. 9-11-07. INT. CL. 25.
- APPLIAN TECHNOLOGIES INC, SAN ANSELMO, CA:
3,312,298, PUB. 4-17-2007. INT. CL. 9.
- APPLICATION NETWORKS, INC., PALO ALTO, CA:
3,312,999, INT. CL. 36.
- APPLIED FORMAL METHODS INSTITUTE INC., 8003 ZURICH, SWITZERLAND:
2,409,753, CANC. MULTIPLE CLASS, INT. CLS. 9, 16, 41 AND 42.
- APPLIED GRAPHICS TECHNOLOGIES, INC., NEW YORK, NY:
2,410,066, CANC. MULTIPLE CLASS, INT. CLS. 9, 40 AND 42.
- APPLIED LOGIC SYSTEMS, INC., CAMBRIDGE, MA:
3,314,559, INT. CL. 42.
- APPLIED TACTICS, INC., PURCELLVILLE, VA:
3,310,531, PUB. 7-31-2007. INT. CL. 42.
- APPRISS INC., LOUISVILLE, KY:
3,311,182, PUB. 7-31-2007. INT. CL. 38.
- APTANA, INC., SAN FRANCISCO, CA:
3,313,646, MULTIPLE CLASS, INT. CLS. 9 AND 42.
- AQUA GLASS CORPORATION, ADAMSVILLE, TN:
2,411,263, CANC. INT. CL. 11.
2,411,264, CANC. INT. CL. 11.
- AQUA-CHEM, INC., KNOXVILLE, TN:
1,089,496, REN. 9-10-07. INT. CL. 1.
- AQUAMEDIA CORP, SAN DIEGO, CA:
3,312,650, PUB. 7-31-2007. MULTIPLE CLASS, INT. CLS. 9 AND 35.
- AQUANOVA GERMAN SOLUBILISATE TECHNOLOGIES (AGT) GMBH, DARMSTADT, FED REP GERMANY:
2,410,910, CANC. INT. CL. 5.
- AQUARIUS FUND DISTRIBUTORS, LLC, OMAHA, NE:
3,310,636, PUB. 7-31-2007. INT. CL. 36.
- AQUATECH INTERNATIONAL CORPORATION, CANONSBURG, PA:
2,410,773, CANC. INT. CL. 11.
- AQUILA, INC., KANSAS CITY, MO:
3,313,534, INT. CL. 39.
- ARAFEH, SOUSAN, WASHINGTON, DC:
3,310,574, PUB. 7-31-2007. INT. CL. 9.
- ARAMAKI, ASAKO, TOKYO, JAPAN:
3,310,524, PUB. 7-31-2007. MULTIPLE CLASS, INT. CLS. 41 AND 44.
- ARAMARK CORPORATION, PHILADELPHIA, PA:
3,314,778, INT. CL. 30.
- ARAMARK EDUCATIONAL RESOURCES, INC., GOLDEN, CO:
2,411,458, CANC. MULTIPLE CLASS, INT. CLS. 35, 41 AND 42.
- ARAMIS INC., NEW YORK, NY:
2,021,458, CANC. INT. CL. 3.
3,313,459, INT. CL. 3.
- ARANA, KARI L., BRENTWOOD, CA:
3,314,604, INT. CL. 25.
- ARANAR GLASS TECH, LLC, WEST PALM BEACH, FL:
3,314,961, INT. CL. 17.
- ARCATI, ANTHONY, GLEN COVE, NY:
3,313,650, INT. CL. 41.
- ARCHANGEL BRANDS INC., BREWSTER, NY:
3,310,873, PUB. 7-31-2007. INT. CL. 3.
- ARCHER DANIELS MIDLAND COMPANY, DECATUR, IL:
1,070,709, REN. 9-7-07. INT. CL. 30.
- ARCHIBALD, JOHN, JOSEPH, ANACORTES, WA:
3,311,844, PUB. 7-31-2007. INT. CL. 35.
- ARCHIMEDES SYSTEMS, INC., WALTHAM, MA:
2,411,300, CANC. INT. CL. 9.
- ARCO CHOCOLATE COMPANY, LLC, ELK RIVER, MN:
3,313,795, INT. CL. 35.
- ARCOR S.A.I.C., (1006) BUENOS AIRES, ARGENTINA:
3,312,994, INT. CL. 30.
- ARCTIC NATURAL WATERS LIMITED, LONDON, ENGLAND:
3,314,051, INT. CL. 32.

- ARDOUR CAPITAL PARTNERS, LLC, NEW YORK, NY:
3,312,472, PUB. 7-31-2007. INT. CL. 36.
3,312,473, PUB. 7-31-2007. INT. CL. 36.
- AREAS, S.A., BARCELONA, SPAIN:
3,312,507, PUB. 7-31-2007. INT. CL. 43.
- ARETOS, YIORGO, LAS VEGAS, NV:
3,311,817, PUB. 7-31-2007. INT. CL. 43.
- ARGELA TECHNOLOGIES, MASLAK, ISTANBUL, 34398, TURKEY:
3,313,103, INT. CL. 9.
- ARGON TECHNOLOGY CORPORATION, MISSISSAUGA, ONTARIO:
3,311,632, PUB. 7-31-2007. INT. CL. 9.
- ARGONICS, INC., MARQUETTE, MI:
3,310,239, PUB. 7-31-2007. INT. CL. 22.
- ARGOSY GAMING COMPANY, ALTON, IL:
2,177,009. REN. 9-13-07. INT. CL. 25.
- ARIAGNO, KERNS, MANK, WHITE L.L.C., WICHITA, KS:
3,310,491, PUB. 7-31-2007. INT. CL. 42.
- ARIBEX, INC., OREM, UT:
3,313,892, INT. CL. 10.
- ARIENS COMPANY, BRILLION, WI:
3,314,380, INT. CL. 7.
- ARIMA CAPITAL, LLC, WASHINGTON, DC:
3,312,147, PUB. 7-31-2007. INT. CL. 36.
- ARIS HEDIYELIK ESYA; SANAYI VE TICARET ANONIM SIRKETI, EMINONU - ISTANBUL, TURKEY:
3,312,807, PUB. 7-31-2007. INT. CL. 14.
- ARISTOCRAT TECHNOLOGIES AUSTRALIA PTY LTD, LANE COVE, AUSTRALIA:
3,313,481, INT. CL. 9.
- ARISTOCRAT TECHNOLOGIES AUSTRALIA PTY LTD, LANE COVE, NEW SOUTH WALES, AUSTRALIA:
3,313,684, INT. CL. 9.
- ARIZONA SPORTS FOUNDATION, THE, SCOTTSDALE, AZ:
2,094,764. REN. 9-11-07. INT. CL. 41.
- ARK THERAPEUTIC SERVICES, INC., LUGOFF, SC:
3,313,468, INT. CL. 9.
- ARKANSAS BLUE CROSS AND BLUE SHIELD, LITTLE ROCK, AR:
3,313,905, INT. CL. 36.
- ARM LIMITED, CAMBRIDGE, ENGLAND:
3,311,697, PUB. 7-31-2007. MULTIPLE CLASS, INT. CLS. 9, 16 AND 42.
- ARM'S REACH CONCEPTS, INC., MALIBU, CA:
3,313,824, INT. CL. 20.
- ARMATURENFABRIK - APPARATEBAU-METALL-GIEBEREI GMBH + CO. KG, FED REP GERMANY:
3,312,886, PUB. 7-31-2007. MULTIPLE CLASS, INT. CLS. 6, 9 AND 20.
- ARMSTRONG WORLD INDUSTRIES, INC., LANCASTER, PA:
1,419,199, CANC. INT. CL. 19.
1,419,205, CANC. INT. CL. 19.
- ARNOLD, JEAN L., SEBASTOPOL, CA AND VALENTINE, ERICA, SEBASTOPOL, CA:
2,410,376, CANC. INT. CL. 35.
- ARNOLDO MONDADORI EDITORE S.P.A., ITALY:
3,312,707, PUB. 7-31-2007. INT. CL. 16.
- ARROWHEAD LODGE, INC., BLACK RIVER FALLS, WI:
3,312,590, PUB. 4-10-2007. INT. CL. 43.
- ART + DESIGN GMBH, SWITZERLAND:
3,312,934, PUB. 7-31-2007. INT. CL. 14.
- ART SMART ADVENTURES INC., NEW YORK, NY:
3,310,862, PUB. 7-31-2007. INT. CL. 41.
- ARTIST'S ADVANTAGE, INC., SOUTHLAKE, TX:
3,314,706, INT. CL. 16.
- ARTISTIC STONE PRODUCTS, INC., BALLGROUND, GA:
2,170,889. REN. 9-13-07. INT. CL. 19.
- ARVEDA, LLC, HAYS, KS, DBA STROMGREN SUPPORTS:
3,313,074, MULTIPLE CLASS, INT. CLS. 25 AND 28.
- ARY, INC., KANSAS CITY, MO:
3,312,697, PUB. 1-23-2007. INT. CL. 8.
- ASCEND RESIDENTIAL PROPERTIES, INC., NEW YORK, NY:
2,410,505, CANC. MULTIPLE CLASS, INT. CLS. 36 AND 37.
- ASCENSION TECHNOLOGY CORPORATION, BURLINGTON, VT:
2,043,278. REN. 9-9-07. INT. CL. 9.
- ASCENT HOLDINGS, INC., LAS VEGAS, NV:
3,311,063, PUB. 7-31-2007. INT. CL. 35.
- ASCRIBE INC., OAKLAND, CA:
2,410,300, CANC. MULTIPLE CLASS, INT. CLS. 35 AND 42.
- ASEPT INTERNATIONAL AB, LUND, SWEDEN:
3,310,210, PUB. 7-31-2007. MULTIPLE CLASS, INT. CLS. 7 AND 21.
- ASH MEDICAL SYSTEMS, INC., WEST LAFAYETTE, IN:
1,419,047, CANC. INT. CL. 9.
- ASHES TO ASHES, TUALATIN, OR:
3,312,058, PUB. 7-31-2007. INT. CL. 16.
- ASHEVILLE RESTAURANT GROUP, LLC, ASHEVILLE, NC:
3,312,322, PUB. 7-31-2007. INT. CL. 43.
- ASHJIAN, NAZAR, H., ENCINO, CA:
3,313,778, INT. CL. 25.
- ASHLAND LICENSING AND INTELLECTUAL PROPERTY LLC, DUBLIN, OH:
3,314,139, INT. CL. 1.
- ASHWORTH BROS, INC., WINCHESTER, VA:
2,411,330, CANC. INT. CL. 7.
- ASIAN BUSINESS VENTURES, INC., DIAMOND BAR, CA:
2,410,970, CANC. INT. CL. 16.
- ASICS CORPORATION, CHUO-KU, KOBE, JAPAN:
3,310,851, PUB. 7-31-2007. INT. CL. 25.
3,310,852, PUB. 7-31-2007. INT. CL. 25.
3,310,855, PUB. 7-31-2007. INT. CL. 25.
3,310,856, PUB. 7-31-2007. INT. CL. 25.
- ASPEITIA, SIXTO, SAN DIEGO, CA:
2,020,607, CANC. INT. CL. 42.
- ASSANTI, BRANDON, LOS ANGELES, CA AND TOIT, KEVIN DU, LOS ANGELES, CA:
3,311,293, PUB. 7-31-2007. INT. CL. 41.
- ASSISTING HANDS HOME CARE, LLC, MESA, AZ:
3,310,929, PUB. 7-31-2007. INT. CL. 44.
- ASSOCIATED ELECTRICS, INC., COSTA MESA, CA:
3,313,664, INT. CL. 28.
- ASSOCIATED PROFESSIONAL SLEEP SOCIETIES, LLC, WESTCHESTER, IL:
3,312,661, PUB. 7-31-2007. INT. CL. 16.
- ASSOCIATES IN WOMEN'S HEALTHCARE & FAMILY PRACTICE, SOUTHPORT, CT, DBA ASSOCIATES IN FAMILY HEALTH:
2,020,308, CANC. INT. CL. 42.
- ASSOCIATION FOR FACILITIES ENGINEERING, RESTON, VA:
2,152,435. REN. 9-7-07. INT. CL. 16.
- ASSURANCE INDUSTRIES CO., INC., FREMONT, CA:
2,021,534, CANC. INT. CL. 28.
- ASTOR DEVELOPMENT GROUP, LLC, MIAMI, FL:
3,312,519, PUB. 7-31-2007. INT. CL. 36.
- ASURION CORPORATION, SAN MATEO, CA:
3,312,225, PUB. 7-31-2007. INT. CL. 35.
- AT&T KNOWLEDGE VENTURES, L.P., AUSTIN, TX:
2,409,900, CANC. INT. CL. 38.
- ATALA S.P.A., ITALY:
3,312,855, PUB. 7-31-2007. MULTIPLE CLASS, INT. CLS. 12 AND 28.
- ATARI EUROPE SAS, 69252 LYON CEDEX 9, FRANCE:
2,409,724, CANC. INT. CL. 9.
- ATEB, INC., RALEIGH, NC:
2,172,897. REN. 9-11-07. INT. CL. 42.
- ATI PROPERTIES, INC., ALBANY, OR:
3,313,873, INT. CL. 6.
- ATLANTA CHAPTER OF THE COCA COLA COLLECTORS CLUB, THE, ATLANTA, GA:
2,020,800, CANC. INT. CL. 41.
- ATLANTIC CUSTOM PROCESSORS, LLC, FORT FAIRFIELD, ME:
2,411,194, CANC. INT. CL. 29.
- ATLANTIC NATIONWIDE TRANSPORTATION SERVICES, INC., PERRY HALL, MD:
3,311,315, PUB. 7-17-2007. INT. CL. 39.

ATLANTIGO LLC, ASHBURN, VA:
3,311,918, PUB. 7-31-2007. INT. CL. 35.

ATLUS U.S.A., INC., IRVINE, CA:
3,311,295, PUB. 7-31-2007. INT. CL. 9.

ATSTAFF, INC., DURHAM, NC:
3,314,048, MULTIPLE CLASS, INT. CLS. 9, 38, 41 AND 42.

ATTACHMENT TECHNOLOGIES, INC., CEDAR RAPIDS, IA:
3,313,575, INT. CL. 7.
3,313,576, INT. CL. 7.
3,313,577, INT. CL. 7.
3,313,578, INT. CL. 7.

ATTEA, THOMAS CHARLES, GOSHEN, CT:
3,310,697, PUB. 7-31-2007. INT. CL. 41.

ATTICUS MANAGEMENT LLC, NEW YORK, NY:
2,098,746, REN. 9-13-07. INT. CL. 36.

ATTEBORO MUSEUM, INC., ATTEBORO, MA:
3,313,629, INT. CL. 41.

ATTORNEYS LIABILITY PROTECTION SOCIETY, INC. A RISK RETENTION GROUP, MISSOULA, MT, ATTORNEYS LIABILITY PROTECTION SOCIETY, A MUTUAL RISK RETENTION GROUP, MISSOULA, MT:
2,125,404, REN. 9-7-07. INT. CL. 36.

ATURA PROPERTIES LLC, MILWAUKEE, WI:
3,311,432, PUB. 7-31-2007. INT. CL. 36.

AU OPTRONICS CORP., HSINCHU, TAIWAN:
3,311,727, PUB. 7-31-2007. INT. CL. 9.

AUCOIN HART JEWELERS, INC., METAIRIE, LA:
3,314,728, INT. CL. 14.

AUDITFORCE, L.L.C., MILWAUKEE, WI TO JEFFERSON WELLS INTERNATIONAL, INC., MILWAUKEE, WI:
2,020,965, CANC. INT. CL. 35.

AUGHEY PLANT INTERNATIONAL LIMITED, COUNTY MONAGHAN, IRELAND:
3,311,879, PUB. 7-31-2007. INT. CL. 7.

AUL, L.L.C., NAPA, CA:
3,314,633, INT. CL. 9.

AURIGIN SYSTEMS, INC., MOUNTAIN VIEW, CA:
2,410,456, CANC. INT. CL. 35.

AURORA DUE S.R.L., 10156 TORINO, ITALY:
3,310,187, PUB. 7-31-2007. INT. CL. 16.

AURORA LABORATORIES, INC., PALM CITY, FL:
2,410,141, CANC. INT. CL. 3.

AUSPOS, CHARLES M., ANOKA, MN, DBA ASPENRIDGE INTERNATIONAL:
2,410,664, CANC. INT. CL. 20.

AUSSIE VINEYARDS LTD ACN 113 562 637, GOLD COAST QUEENSLAND, AUSTRALIA:
3,312,584, PUB. 4-10-2007. INT. CL. 33.

AUTEC POWER SYSTEMS, INC., SIMI VALLEY, CA:
3,311,281, PUB. 7-31-2007. INT. CL. 9.

AUTHENTICCLICK, INC, LOS ANGELES, CA:
3,311,168, PUB. 7-31-2007. MULTIPLE CLASS, INT. CLS. 35 AND 42.

AUTHENTIX, INC., ADDISON, TX:
3,313,477, INT. CL. 9.

AUTO JAVA, BOISE, ID:
2,020,704, CANC. INT. CL. 42.

AUTO-REF INC., TORONTO, ONTARIO, CANADA:
3,310,208, PUB. 7-31-2007. INT. CL. 9.

AUTOMATED SIGNATURE TECHNOLOGY, INC., STERLING, VA:
3,312,358, PUB. 4-24-2007. INT. CL. 9.

AUTOMATIONSOLUTIONS INTERNATIONAL, LLC, POTALUMA, CA:
2,411,486, CANC. MULTIPLE CLASS, INT. CLS. 35 AND 42.

AUTOMOBILI LAMBORGHINI HOLDING S.P.A., BOLOGNA, ITALY:
3,312,082, PUB. 7-31-2007. INT. CL. 9.

AUTOMOTIVE RENTALS, INC., MT. LAUREL, NJ:
3,311,526, PUB. 7-31-2007. INT. CL. 41.
3,311,527, PUB. 7-31-2007. INT. CL. 42.

AUTOMOTIVE RENTALS, INC., MOUNT LAUREL, NJ:
3,311,528, PUB. 7-31-2007. INT. CL. 35.

AUTONOMOUS TECHNOLOGIES CORPORATION, INC., ORLANDO, FL:
2,411,164, CANC. INT. CL. 35.

AUTOPILOT FRANCHISE SYSTEMS, ATLANTA, GA:
3,312,602, PUB. 7-31-2007. INT. CL. 35.

AUTRY NATIONAL CENTER, LOS ANGELES, CA:
3,312,117, PUB. 7-31-2007. MULTIPLE CLASS, INT. CLS. 35 AND 41.

AUTUMN ENTERPRISES, INC., DENVER, CO:
3,312,649, PUB. 4-17-2007. INT. CL. 35.

AVA BANERJI AND PARIMAL BANERJI, CALCUTTA 26, INDIA:
1,061,085, REN. 9-7-07. INT. CL. 5.

AVACUS CORPORATION, SANTA MONICA, CA:
3,313,026, INT. CL. 39.

AVALON BEVERAGE COMPANY, GLEN ALLEN, VA:
2,409,809, CANC. INT. CL. 32.

AVANTEK, INC., SANTA CLARA, CA:
1,419,006, CANC. INT. CL. 9.

AVEDA CORPORATION, MINNEAPOLIS, MN:
3,312,113, PUB. 7-31-2007. INT. CL. 3.
3,314,861, INT. CL. 3.

AVENCIA INCORPORATED, PHILADELPHIA, PA:
3,311,513, PUB. 7-31-2007. INT. CL. 9.

AVESCO GROUP PLC, CRAWLEY, WEST SUSSEX, UNITED KINGDOM:
2,410,898, CANC. MULTIPLE CLASS, INT. CLS. 16, 35 AND 38.

AVIATION METHODS, INC., SAN FRANCISCO, CA:
2,409,890, CANC. MULTIPLE CLASS, INT. CLS. 35, 39 AND 42.

AVIATION TECHNOLOGY, INC., MANCHESTER, NH:
3,311,335, PUB. 7-31-2007. INT. CL. 9.

AVM INDUSTRIES, LLC, SOLON, OH:
1,419,096, CANC. INT. CL. 12.

AVNET, INC., PHOENIX, AZ:
3,311,822, PUB. 4-10-2007. INT. CL. 35.

AVOCADO RESEARCH CHEMICALS LTD., HEYSHAM LANCASHIRE, ENGLAND:
2,088,811, REN. 9-7-07. INT. CL. 1.

AVON PRODUCTS, INC., NEW YORK, NY:
2,411,585, CANC. INT. CL. 3.

AVON PRODUCTS, INC., NEW YORK, NY:
3,314,524, INT. CL. 3.
3,314,563, INT. CL. 3.

AVX CORPORATION, MYRTLE BEACH, SC:
3,313,703, INT. CL. 9.

AV7 LIMITED, CARDIFF, UNITED KINGDOM:
3,310,763, PUB. 7-17-2007. MULTIPLE CLASS, INT. CLS. 1, 5 AND 10.

AWADA, YEHIA, MR., LAS VEGAS, NV:
3,313,665, INT. CL. 41.

AWAREPOINT CORPORATION, SAN DIEGO, CA:
3,310,599, PUB. 7-31-2007. MULTIPLE CLASS, INT. CLS. 42 AND 45.

AWESOME RUGS INTERNATIONAL, LLC, NEWPORT BEACH, CA:
3,310,926, PUB. 7-31-2007. INT. CL. 27.

AWI LICENSING COMPANY, WILMINGTON, DE:
3,313,223, INT. CL. 19.

AWR GROUP, INC., LONG ISLAND CITY, NY:
3,314,030, INT. CL. 37.

AWREY BAKERIES, LLC, LIVONIA, MI:
3,312,333, PUB. 7-31-2007. INT. CL. 30.

AXN NETWORK, INC., CULVER CITY, CA:
3,313,990, INT. CL. 41.

AXON' CABLE SA, MONTMIRAIL, FRANCE:
1,446,048, REN. 9-13-07. INT. CL. 9.

AZ ELECTRONIC MATERIALS USA CORP., SOMERVILLE, NJ, AZOPLATE CORPORATION, MURRAY HILL, NJ:
853,001, REN. 9-13-07. U.S. CL. 6 (INT. CLS. 1 AND 2).

AZDEL, INC., FOREST, VA:
3,313,513, INT. CL. 17.

AZOT, INC., BOULDER, CO:
3,313,429, INT. CL. 6.

AZOTIC COATING TECHNOLOGY, INC., ROCHESTER, MN:
3,313,403, INT. CL. 14.

AZTECA MOBILE, L.L.C., OVERLAND PARK, KS:
3,314,662, INT. CL. 38.
3,314,663, INT. CL. 38.

- AZUMA FOODS INTERNATIONAL INC., U.S.A., HAYWARD, CA:
3,310,945, PUB. 7-31-2007. INT. CL. 29.
- AZURE MEDIA CORP., PARAMUS, NJ:
2,137,503, REN. 9-7-07. INT. CL. 16.
- B & D, INC., NASHVILLE, TN:
3,312,398, PUB. 7-31-2007. MULTIPLE CLASS, INT. CLS. 14 AND 26.
- B & J MANUFACTURING COMPANY, GLENWOOD, IL:
3,314,071, INT. CL. 7.
- B. JEFFREY JOLLEY, MESA, AZ:
2,410,532, CANC. INT. CL. 42.
- B.A.S.S. (IP), LLC, BRISTOL, CT:
3,313,444, MULTIPLE CLASS, INT. CLS. 25 AND 26.
- B.L.P. INTERNATIONAL, INC., PHILADELPHIA, PA:
3,313,085, INT. CL. 41.
- B-THERE.COM CORP., WESTPORT, CT:
2,410,046, CANC. MULTIPLE CLASS, INT. CLS. 35, 39 AND 42.
- BABY TREND, INC., ONTARIO, CA:
2,411,446, CANC. INT. CL. 12.
- BABYVISION, INC., POUGHKEEPSIE, NY:
2,410,189, CANC. INT. CL. 28.
- BACH, JAN BJERRUM, 2840 HOLTE, DENMARK:
3,312,386, PUB. 7-31-2007. MULTIPLE CLASS, INT. CLS. 35, 41 AND 45.
- BACON'S INFORMATION INC., CHICAGO, IL:
2,410,587, CANC. INT. CL. 9.
- BADGER METAL TECH, INC., MENOMONEE FALLS, WI:
3,310,709, PUB. 7-10-2007. INT. CL. 40.
- BAECK GMBH & CO. KG, NORDERSTEDT, FED REP GERMANY:
1,453,991, REN. 9-13-07. INT. CL. 9.
- BAECK GMBH & CO. KG., NORDERSTEDT, FED REP GERMANY:
1,454,955, REN. 9-13-07. INT. CL. 9.
- BAG LADY, INC., THE, LUGOFF, SC:
2,085,349, REN. 9-12-07. INT. CL. 22.
- BAGELS, INC., BALTIMORE, MD, TA SAM'S BAGELS:
2,020,435, CANC. INT. CL. 42.
- BAILEY & WAGS INC., JUPITER, FL:
3,313,704, INT. CL. 35.
- BAILEY GROUP, INC., THE, PLYMOUTH MEETING, PA:
3,313,780, MULTIPLE CLASS, INT. CLS. 16 AND 41.
- BAILEY, VINCENT P., LAGUNA NIGUEL, CA:
3,314,321, INT. CL. 42.
- BAJA BROILER, INC., SIMI VALLEY, CA:
2,020,171, CANC. INT. CL. 42.
- BAKER HUGHES INCORPORATED, HOUSTON, TX, HUGHES TOOL COMPANY, HOUSTON, TX, DBA CENTRILIFT-HUGHES:
1,451,878, REN. 9-11-07. INT. CL. 9.
- BAKER HUGHES INCORPORATED, HOUSTON, TX:
3,141,462, COR. INT. CL. 1.
- BALANCED BODY, INC., SACRAMENTO, CA:
3,311,689, PUB. 7-31-2007. INT. CL. 28.
- BALD GUY PRODUCTIONS, INC., NORTH HOLLYWOOD, CA:
2,020,450, CANC. INT. CL. 41.
- BALDASSARI, JACQUES V., MEXICO, D.F., MEXICO:
3,311,956, PUB. 7-31-2007. INT. CL. 43.
- BALDO & GROSSMAN ENTERPRISES, INC., FORT COLLINS, CO:
2,410,589, CANC. INT. CL. 38.
- BALENCIAGA S.A., PARIS, FRANCE:
1,388,721, CANC. INT. CL. 3.
- BALL DYNAMICS INTERNATIONAL, LLC, LONGMONT, CO:
3,311,322, PUB. 7-31-2007. INT. CL. 20.
- BALL HORTICULTURAL COMPANY, WEST CHICAGO, IL:
3,310,639, PUB. 7-31-2007. INT. CL. 31.
3,310,640, PUB. 7-31-2007. INT. CL. 31.
3,313,685, INT. CL. 31.
- BALL STATE UNIVERSITY, MUNCIE, IN:
2,020,993, CANC. INT. CL. 16.
2,020,996, CANC. INT. CL. 21.
2,020,997, CANC. INT. CL. 16.
- BALON, BRADLEY E., GOFFSTOWN, NH:
3,314,196, INT. CL. 9.
3,314,197, INT. CL. 9.
- BALTIC LINEN COMPANY, INC., VALLEY STREAM, NY:
2,410,826, CANC. INT. CL. 24.
- BALTIMORE GAS AND ELECTRIC COMPANY, BALTIMORE, MD:
2,021,407, CANC. INT. CL. 39.
- BAM VENTURES, LLC, ST. AUGUSTINE, FL:
3,313,928, INT. CL. 43.
- BANCVUE, LTD., AUSTIN, TX:
3,311,126, PUB. 7-31-2007. MULTIPLE CLASS, INT. CLS. 9, 35 AND 36.
- BANDI, SANKAR, ROCHESTER, MN:
3,311,006, PUB. 7-31-2007. INT. CL. 35.
- BANG & OLUFSEN MEDICOM A/S, DENMARK:
3,312,947, PUB. 7-31-2007. INT. CL. 10.
- BANG ON THE DOOR LIMITED, LONDONDERRY, NORTHERN IRELAND:
3,311,745, PUB. 7-31-2007. MULTIPLE CLASS, INT. CLS. 25, 28 AND 30.
- BANJARA INDIAN CUISINE, INC., SUNNYVALE, CA:
2,410,503, CANC. INT. CL. 42.
- BANK OF AMERICA CORPORATION, CHARLOTTE, NC, COLUMBIA FUNDS MANAGEMENT COMPANY, PORTLAND, OR:
2,122,978, REN. 9-8-07. INT. CL. 36.
- BANK OF AMERICA CORPORATION, CHARLOTTE, NC:
3,314,491, INT. CL. 36.
- BANK OF BLUE VALLEY, OVERLAND PARK, KS:
3,312,162, PUB. 7-31-2007. INT. CL. 36.
- BAPTIST HEALTHCARE SYSTEM, INC., LOUISVILLE, KY:
3,310,901, PUB. 7-31-2007. MULTIPLE CLASS, INT. CLS. 41 AND 44.
3,311,332, PUB. 7-31-2007. INT. CL. 41.
- BAPTIST MEMORIAL HOSPITAL, MEMPHIS, TN:
1,419,537, CANC. INT. CL. 42.
- BARAN, CHRISTOPHER J., MELVILLE, NY AND RIES, DEREK, MELVILLE, NY AND DE TURRIS, NICHOLAS, MELVILLE, NY AND SCAROLA, STEVEN, MELVILLE, NY:
3,311,300, PUB. 7-31-2007. INT. CL. 41.
- BARASCH, MARC, BOULDER, CO:
2,410,934, CANC. INT. CL. 16.
- BARDAV INC., AGOURA HILLS, CA:
3,312,684, PUB. 7-31-2007. INT. CL. 41.
- BAREFOOT ZOOLOGICAL GARDENS, L.L.C., NORTH MYRTLE BEACH, SC:
2,119,525, REN. 9-13-07. INT. CL. 41.
- BARNES, MARY RYAN, NEW YORK, NY:
3,311,676, PUB. 7-31-2007. INT. CL. 41.
- BARON DE LEY, S.A., MENDAVIA, NAVARRA, SPAIN:
3,312,192, PUB. 7-31-2007. INT. CL. 33.
- BARON SERVICES, INC., HUNTSVILLE, AL:
2,090,569, REN. 9-13-07. INT. CL. 9.
- BARONE RICASOLI S.P.A., FLORENCE, ITALY:
2,099,355, REN. 9-8-07. INT. CL. 33.
- BARR-NUNN TRANSPORTATION, INC., GRANGER, IA:
2,087,478, REN. 9-11-07. INT. CL. 39.
2,091,034, REN. 9-11-07. INT. CL. 39.
- BARRA FABRIZIO, I-10073 CIRIE' (TORINO), ITALY:
3,312,780, PUB. 7-31-2007. INT. CL. 28.
- BARRON, CHARLES R., CANTONMENT, FL AND BARRON, RUTH C., PENSACOLA, FL:
1,427,853, REN. 9-12-07. INT. CL. 41.
- BARRY CALLEBAUT AG, SWITZERLAND:
3,312,906, PUB. 7-31-2007. MULTIPLE CLASS, INT. CLS. 1 AND 32.
- BARRY FRUITMAN, TORONTO, ONTARIO, CANADA:
3,312,380, PUB. 7-31-2007. INT. CL. 35.
- BARTER AMERICAS, FAYETTEVILLE, AR:
3,312,052, PUB. 7-31-2007. INT. CL. 35.
- BASELINE ENGINEERING, GOLDEN, CO:
3,310,932, PUB. 7-31-2007. INT. CL. 42.
- BASF AGRO B.V., ARNHEM (NL), ZWEIGNIEDERLASSUNG WADENSWIL, AU, SWITZERLAND, AMERICAN CYANAMID COMPANY, MADISON, NJ:
2,098,326, REN. 9-13-07. INT. CL. 5.

- BASF CORPORATION, FLORHAM PARK, NJ, GENERAL DYESTUFF CORPORATION, NEW YORK, NY:
232,223. REN. 9-7-07. U.S. CL. 6 (INT. CL. 2).
- BASF CORPORATION, FLORHAM PARK, NJ, GEIGY CHEMICAL CORPORATION, ARDSLEY, NY:
827,959. REN. 9-13-07. U.S. CL. 46 (INT. CL. 1).
- BASF CORPORATION, FLORHAM PARK, NJ, BASF WYANDOTTE CORPORATION, WYANDOTTE, MI:
1,060,544. REN. 9-13-07. INT. CL. 1.
- BASF CORPORATION, MOUNT OLIVE, NJ:
2,411,103, CANC. INT. CL. 1.
2,411,104, CANC. INT. CL. 1.
- BASIC TRADEMARK S.A., LUXEMBOURG, LUXEMBOURG:
3,313,051, MULTIPLE CLASS, INT. CLS. 9, 18, 24, 25 AND 28.
- BASKAS, HARRIET, SEATTLE, WA:
2,410,040, CANC. MULTIPLE CLASS, INT. CLS. 16 AND 42.
- BASS, NEVILLE M., LONDON, ENGLAND:
2,103,722. REN. 9-9-07. INT. CL. 10.
- BATH & BODY WORKS, INC., REYNOLDSBURG, OH:
3,313,706, INT. CL. 3.
- BAUDVILLE INC., GRAND RAPIDS, MI:
3,311,740, PUB. 7-31-2007. INT. CL. 9.
- BAUER PUBLISHING COMPANY, L.P., ENGLEWOOD, NJ:
3,311,785, PUB. 7-31-2007. INT. CL. 16.
- BAUM, HAROLD DANIEL, BROOKLYN, NY:
3,310,430, PUB. 7-31-2007. INT. CL. 3.
- BAUMBECK, WILLIAM C., YUMA, AZ:
3,311,290, PUB. 7-31-2007. INT. CL. 35.
- BAXTER INTERNATIONAL, INC., DEERFIELD, IL:
2,411,168, CANC. INT. CL. 10.
- BAYER AKTIENGESELLSCHAFT, LEVERKUSEN, FED REP GERMANY:
2,071,469. REN. 9-7-07. INT. CL. 1.
- BAYERISCHE MOTOREN WERKE AKTIENGESELLSCHAFT, FED REP GERMANY:
3,312,969, PUB. 7-31-2007. MULTIPLE CLASS, INT. CLS. 12, 16 AND 28.
- BAYS BROWN LABORATORIES, INC., LOUISVILLE, KY:
3,311,890, PUB. 7-31-2007. INT. CL. 3.
- BB TECHNOLOGIES, INC., WILMINGTON, DE:
3,312,562, PUB. 7-31-2007. MULTIPLE CLASS, INT. CLS. 37 AND 42.
- BBC BRANDS, LLC, BOSTON, MA:
3,312,368, PUB. 7-31-2007. INT. CL. 32.
- BBVA BANCOMER, S.A. INSTITUCION DE BANCA MULTIPLE, GRUPO FINANCIERO BBVA BANCOMER, 03339 MEXICO D.F., MEXICO:
3,312,243, PUB. 7-31-2007. MULTIPLE CLASS, INT. CLS. 35 AND 36.
- BCI FINANZ AG, CH-6302 ZUG, SWITZERLAND:
2,110,190. REN. 9-10-07. INT. CL. 9.
- BDMETRICS, INC., BALTIMORE, MD:
3,313,072, MULTIPLE CLASS, INT. CLS. 35 AND 38.
- BEACH MART, INC., KITTY HAWK, NC:
2,021,521, CANC. INT. CL. 42.
- BEACHCOMBER HOT TUBS INC., SURREY, CANADA:
3,310,827, PUB. 7-31-2007. INT. CL. 11.
- BEACON ROOFING SUPPLY, INC., PEABODY, MA:
3,310,627, PUB. 7-31-2007. INT. CL. 35.
3,310,814, PUB. 7-31-2007. INT. CL. 35.
- BEAM'S INDUSTRIES, INC., OKLAHOMA CITY, OK:
3,314,937, INT. CL. 18.
- BEAMISH & CRAWFORD PLC, CORK, IRELAND:
2,096,274. REN. 9-12-07. INT. CL. 32.
- BEANSPOUTS INC. OF BROOKLYN, BROOKLYN, NY:
3,311,094, PUB. 7-31-2007. INT. CL. 41.
- BEAULIEU GROUP, LLC, DALTON, GA:
3,314,399, INT. CL. 27.
- BEAUMONT PRODUCTS, INC., KENNESAW, GA:
3,314,801, INT. CL. 3.
- BEAUPRE, DANIEL, ELMVALE, ONTARIO, CANADA:
3,314,080, INT. CL. 22.
- BEAUTYMASTER, INC., COMPTON, CA:
3,313,602, MULTIPLE CLASS, INT. CLS. 3 AND 26.
- BEBOSOFT, INC., PLANTATION, FL:
3,314,186, INT. CL. 9.
- BECK'S SUPERIOR HYBRIDS, INC., ATLANTA, IN:
3,312,247, PUB. 7-31-2007. INT. CL. 31.
- BECKETT MEDIA LP, DALLAS, TX:
2,410,821, CANC. INT. CL. 16.
- BECKLES, WILLIAM, ORANGE, CA:
3,312,177, PUB. 7-31-2007. INT. CL. 25.
3,312,182, PUB. 7-31-2007. INT. CL. 25.
- BEDA-OXYGENTECHNIK ARMATUREN GMBH & CO. KG, LINTORF, FED REP GERMANY:
1,430,871. REN. 9-13-07. INT. CL. 7.
- BEE FAST DELIVERY, INC., PEVELY, MO:
2,021,277, CANC. INT. CL. 39.
- BEE INTERNATIONAL, COLORADO SPRINGS, CO:
2,021,071, CANC. INT. CL. 41.
- BEEPLUSH COUTURE, LLC, FLOWER MOUND, TX:
3,312,678, PUB. 7-31-2007. INT. CL. 25.
- BEGLEY'S BEST, INC., STUDIO CITY, CA:
3,312,283, PUB. 7-31-2007. INT. CL. 3.
- BEHAVIOR FRONTIERS, LLC, GARDENA, CA:
3,314,276, INT. CL. 41.
- BEIERSDORF AG, FED REP GERMANY:
3,312,852, PUB. 7-31-2007. INT. CL. 3.
3,312,877, PUB. 7-31-2007. MULTIPLE CLASS, INT. CLS. 3 AND 5.
- BEIJING SURSEN INTERNATIONAL INFORMATION TECHNOLOGY CO., LTD., BEIJING 100083, CHINA:
3,314,070, INT. CL. 9.
- BEKO CONDENSATE SYSTEMS CORPORATION, MOORESVILLE, NC, DBA BEKO TECHNOLOGIES CORP:
3,310,576, PUB. 7-31-2007. INT. CL. 1.
- BEL AIRS, THE, COLUMBIA, MO:
2,410,266, CANC. INT. CL. 9.
- BEL PRECISION BALANCES USA CORP., NEW BRUNSWICK, NJ:
2,411,033, CANC. INT. CL. 9.
- BELANGER, INC., NORTHVILLE, MI:
3,310,630, PUB. 7-31-2007. INT. CL. 7.
- BELIEVE, ART FROM THE HEART, WAPAKONETA, OH:
3,312,285, PUB. 7-31-2007. INT. CL. 14.
- BELISI FASHIONS, INC., JUPITER, FL:
3,311,148, PUB. 7-31-2007. INT. CL. 35.
3,313,670, INT. CL. 18.
- BELL ATLANTIC NETWORK SERVICES, INC., ARLINGTON, VA TO VERIZON SERVICES CORP., ARLINGTON, VA:
2,021,397, CANC. INT. CL. 38.
- BELL GROUP, THE, ALBUQUERQUE, NM:
2,411,575, CANC. INT. CL. 1.
- BELL SPORTS, INC., IRVING, TX:
3,314,307, MULTIPLE CLASS, INT. CLS. 9 AND 25.
- BELLA VIGNA FARMS, INC., LODI, CA:
3,310,242, PUB. 7-31-2007. INT. CL. 33.
- BELLAMY, MICHELLE, SANTA FE, NM:
2,411,611, CANC. INT. CL. 14.
- BELLAN, LISA B., SOUTH BEND, IN:
3,310,611, PUB. 7-31-2007. INT. CL. 43.
- BELLE CURVE RECORDS, INC., BOULDER, CO:
2,410,049, CANC. INT. CL. 9.
- BELLE TIRE DISTRIBUTORS, INC., ALLEN PARK, MI:
3,314,475, MULTIPLE CLASS, INT. CLS. 35 AND 37.
- BELLEZZA PRODUCTS, LLC, HOBOKEN, NJ:
3,312,417, PUB. 7-31-2007. INT. CL. 3.
- BELLEZZA PRODUCTS, LLC, MANAKIN SABOT, VA:
3,314,494, INT. CL. 3.
- BELLSOUTH INTELLECTUAL PROPERTY CORPORATION, WILMINGTON, DE:
2,409,745, CANC. MULTIPLE CLASS, INT. CLS. 36 AND 42.
3,314,443, MULTIPLE CLASS, INT. CLS. 41 AND 44.
3,314,444, MULTIPLE CLASS, INT. CLS. 41 AND 44.
- BELTER, MARIANNE WILLIAMS, KESWICK, VA:
3,310,353, PUB. 7-31-2007. INT. CL. 18.
- BELUMED X LLC, LITTLE ROCK, AR:
3,312,199, PUB. 7-31-2007. MULTIPLE CLASS, INT. CLS. 3

- AND 5.
3,312,203, PUB. 7-31-2007. INT. CL. 5.
3,312,204, PUB. 7-31-2007. INT. CL. 5.
- BELVEDERE INTERNATIONAL INC., MISSISSAUGA, CANADA:
3,312,314, PUB. 7-31-2007. INT. CL. 3.
- BEMIS MANUFACTURING COMPANY, SHEBOYGAN FALLS, WI, AMERICAN STANDARD INC., NEW YORK, NY:
848,089. REN. 9-11-07. U.S. CL. 13 (INT. CL. 11).
- BEN-HAR FUYO CO., LTD., GIFU 501-6121, JAPAN:
3,312,899, PUB. 7-31-2007. INT. CL. 11.
- BENCHMADE KNIFE CO., INC., OREGON CITY, OR:
3,313,312, INT. CL. 8.
- BENCHMARK BRANDS, INC., MEMPHIS, TN:
2,091,620. REN. 9-11-07. INT. CL. 25.
3,314,151, INT. CL. 35.
3,314,152, INT. CL. 35.
3,314,154, INT. CL. 25.
- BEND-PAK, INC., SANTA PAULA, CA:
2,163,904. REN. 9-7-07. INT. CL. 7.
- BENEFIT SYSTEMS OF AMERICA INC., CHARLOTTE, NC:
2,020,781, CANC. INT. CL. 9.
- BENETERRA, LLC, PRATT, KS:
3,311,511, PUB. 7-31-2007. MULTIPLE CLASS, INT. CLS. 35, 39, 40 AND 44.
3,311,525, PUB. 7-31-2007. MULTIPLE CLASS, INT. CLS. 35, 39, 40 AND 44.
- BENETTON GROUP S.P.A., 31050 PONZANO VENETO (TREVISO), ITALY:
2,409,743, CANC. MULTIPLE CLASS, INT. CLS. 9, 14, 16, 18, 21, 24, 25, 28, 34, 35 AND 42.
- BENEV COMPANY INC., MISSION VIEJO, CA:
3,312,500, PUB. 7-31-2007. INT. CL. 9.
- BENNETT ENTERPRISES, PERRYSBURG, OH:
2,138,444. REN. 9-11-07. INT. CL. 42.
- BENOUSAAD JAAFAR, FRANCE:
3,312,757, PUB. 4-10-2007. MULTIPLE CLASS, INT. CLS. 18, 25 AND 28.
- BERARDELLI, JEFFREY R., NEW YORK, NY:
3,314,010, INT. CL. 41.
- BERBEE INFORMATION NETWORKS CORPORATION, MADISON, WI:
2,410,512, CANC. MULTIPLE CLASS, INT. CLS. 38 AND 42.
- BERENSTEIN, ARLETTE JAVNOZON, MEXICO, D.F., MEXICO:
2,411,096, CANC. INT. CL. 24.
2,411,097, CANC. INT. CL. 24.
- BERGEN RECORD CORPORATION, HACKENSACK, NJ:
2,409,904, CANC. INT. CL. 16.
- BERGEN, GRADY K., DALLAS, TX:
3,311,051, PUB. 7-31-2007. INT. CL. 42.
- BERGER-SEIDLE AMERICA, LP, DULUTH, GA:
2,174,942. REN. 9-13-07. INT. CL. 2.
- BERGER, MIRA, NEW YORK, NY:
1,459,771. REN. 9-12-07. INT. CL. 1.
- BERKELEY PROCESS CONTROL, INC., RICHMOND, CA:
3,310,988, PUB. 7-31-2007. INT. CL. 9.
- BERKEY, STEVEN, PLANO, TX AND BERKEY, JULIE, PLANO, TX:
3,314,654, INT. CL. 44.
- BERKLEY ACCIDENT AND HEALTH, LLC, HAMILTON SQUARE, NJ:
3,312,178, PUB. 7-31-2007. INT. CL. 36.
- BERNARD MAGREZ, F-33600 PESSAC, FRANCE:
3,312,734, PUB. 7-31-2007. INT. CL. 33.
- BERNSTEIN, ANDREW, NEW YORK, NY:
3,314,208, INT. CL. 41.
- BERNSTEIN, DONNA, MILLBURN, NJ:
2,410,705, CANC. INT. CL. 41.
- BEROL CORPORATION, ATLANTA, GA:
3,313,636, INT. CL. 9.
- BERRY-HINCKLEY INDUSTRIES, RENO, NV:
3,311,896, PUB. 4-10-2007. INT. CL. 35.
- BESCHEN, MICHELE D, VAN METER, IA:
3,313,412, INT. CL. 41.
- BESOS INC., INDIALANTIC, FL:
3,314,547, INT. CL. 30.
- BESSELLIEU, LINDA, FREEPORT, NY:
3,313,453, INT. CL. 41.
- BEST BUY REAL ESTATE, FENTON, MI:
3,311,979, PUB. 4-10-2007. INT. CL. 36.
- BEST COMM, LLC, NORCROSS, GA:
2,410,640, CANC. INT. CL. 38.
- BEST WESTERN INTERNATIONAL, INC., PHOENIX, AZ:
2,105,546. REN. 9-7-07. INT. CL. 42.
- BEST, STEPHEN, SHELBURNE, ONTARIO, CANADA:
2,411,303, CANC. INT. CL. 42.
- BETCO CORPORATION, LTD., TOLEDO, OH:
3,311,452, PUB. 7-31-2007. INT. CL. 2.
- BETHLEHEM STEEL CORPORATION, BETHLEHEM, PA:
2,020,195, CANC. INT. CL. 6.
- BETTER BASKETBALL, INC., ATLANTA, GA:
3,312,016, PUB. 7-31-2007. INT. CL. 9.
- BETTMAN, JAY, CINCINNATI, OH:
3,313,716, INT. CL. 29.
- BEVERAGE PARTNERS WORLDWIDE (NORTH AMERICA), ATLANTA, GA:
3,313,241, MULTIPLE CLASS, INT. CLS. 30 AND 32.
- BEWLEY-MOTLUK FAMILY LIMITED PARTNERSHIP, BELVEDERE, CA:
2,411,398, CANC. INT. CL. 33.
2,411,399, CANC. INT. CL. 33.
2,411,400, CANC. INT. CL. 33.
- BFC ACQUISITION CORPORATION, SYLACAUGA, AL:
2,410,618, CANC. INT. CL. 1.
- BFTV, LLC, LOS ANGELES, CA:
3,314,403, INT. CL. 9.
- BFTV, LLC, LOS ANGELES, CA:
3,314,549, INT. CL. 9.
- BI-PRO MARKETING LIMITED, GUELPH, ONTARIO, CANADA:
3,311,735, PUB. 7-31-2007. MULTIPLE CLASS, INT. CLS. 35 AND 39.
- BIACORE AB, UPPSALA, SWEDEN:
2,476,001, CANC. MULTIPLE CLASS, INT. CLS. 9, 16 AND 42.
- BIAFORM CORPORATION, ZEELAND, MI:
3,311,431, PUB. 7-31-2007. MULTIPLE CLASS, INT. CLS. 5 AND 10.
- BIAGIO CRU & ESTATE WINES, LLC., ROSLYN HEIGHTS, NY:
3,314,704, INT. CL. 33.
- BIBLEQUEST L.P., ARLINGTON, TX:
3,314,625, INT. CL. 28.
- BICYCLE CASINO, L.P., THE BELL GARDENS, CA:
2,091,728. REN. 9-12-07. INT. CL. 41.
2,091,729. REN. 9-12-07. INT. CL. 41.
- BIER BROS., INC., SHREWBURY, NJ:
2,410,298, CANC. INT. CL. 16.
- BIERMANN PRODUCTIONS LLC, WICHITA, KS:
3,314,981, INT. CL. 9.
- BIG BRASS, LAKE FOREST, CA:
3,314,561, MULTIPLE CLASS, INT. CLS. 25 AND 35.
- BIG COMMUNICATIONS, INC., FERNDALE, MI:
3,313,091, INT. CL. 42.
- BIG HORN, INC., CHATTANOOGA, TN, WOODS, JAMES E., SIGNAL MOUNTAIN, TN, DBA BIGHORN:
1,099,546. REN. 9-13-07. INT. CL. 18.
- BIG ISSUE COMPANY LIMITED, THE, LONDON, UNITED KINGDOM:
2,411,055, CANC. INT. CL. 16.
- BIG RED FUN, INC., DEERFIELD, IL:
3,311,170, PUB. 7-31-2007. INT. CL. 41.
- BIG TRAIN, INC., RANCHO SANTA MARGARITA, CA, JE MARI'S, INC., RANCHO SANTA MARGARITA, CA:
2,083,761. REN. 9-12-07. INT. CL. 30.
- BIGBEE, PERRY D., MUSCLE SHOALS, AL:
2,094,597. REN. 9-13-07. INT. CL. 18.
- BIGFATWOW, INC., IRVING, TX:
2,410,891, CANC. INT. CL. 42.
- BIGOTT, FRANK, SANTA MONICA, CA:
3,312,327, PUB. 7-31-2007. INT. CL. 41.

BIJOL AND SPICES, INC., MIAMI, FL:
1,469,266. REN. 9-13-07. INT. CL. 30.

BIJUR LUBRICATING CORPORATION, BENNINGTON,
VT, BIJUR LUBRICATING CORPORATION, ROCHELLE
PARK, NJ:
650,469. REN. 9-8-07. U.S. CL. 23 (INT. CL. 7).

BIKE BRITE, INC., MENTOR, OH:
3,313,200. INT. CL. 2.

BILL'S GHOST & SPIRITS LLC, GUADALUPE, AZ:
3,314,398. INT. CL. 35.

BILLOT, CATALINA, LOS ANGELES, CA:
3,311,036. PUB. 7-31-2007. INT. CL. 25.

BINGGRAE INC., KYUNGGI-DO, 472-711, REPUBLIC OF
KOREA:
3,310,270. PUB. 7-31-2007. INT. CL. 29.

BINGHAM, LISA, MALIBU, CA:
3,310,947. PUB. 7-31-2007. INT. CL. 3.

BINUCCI, JEAN-MARIE, MONACO, MONACO:
2,409,949. CANC. INT. CL. 9.

BIO-DEX LABORATORIES, PHOENIX, AZ:
3,310,478. PUB. 7-31-2007. INT. CL. 5.
3,310,479. PUB. 7-31-2007. INT. CL. 1.

BIO-REFERENCE LABORATORIES, INC., ELMWOOD
PARK, NJ:
3,314,580. INT. CL. 42.

BIOCARE LABS, INC., BEDFORD PARK, IL:
2,039,858. REN. 9-10-07. INT. CL. 3.
2,150,836. REN. 9-10-07. INT. CL. 3.

BIOELEMENTS, INC., COLORADO SPRINGS, CO:
3,313,476. INT. CL. 3.

BIOFARMA, NEUILLY-SUR-SEINE, FRANCE:
3,312,837. PUB. 7-31-2007. INT. CL. 5.

BIOFOREST TECHNOLOGIES (USA), INC., SAULT SAINTE
MARIE, MI:
3,314,531. INT. CL. 8.

BIOSAFE SYSTEMS LLC, GLASTONBURY, CT:
3,312,165. PUB. 7-31-2007. INT. CL. 1.

BIOSCALE, INC., CAMBRIDGE, MA:
3,313,355. MULTIPLE CLASS, INT. CLS. 1, 9, 10 AND 42.

BIOSONIX, LLC, GRAYTON BEACH, FL:
3,313,073. INT. CL. 9.

BIOSPHERE MEDICAL, INC., ROCKLAND, MA:
3,311,583. PUB. 7-31-2007. INT. CL. 10.

BIOSTORAGE LLC, BALTIMORE, MD:
3,312,332. PUB. 7-31-2007. INT. CL. 39.

BIOTAGE AB, UPPSALA, SWEDEN:
3,313,467. MULTIPLE CLASS, INT. CLS. 1 AND 9.

BIOTECH INTERNATIONAL CORPORATION, GLASTON-
BURY, CT:
3,314,181. INT. CL. 5.

BIOTICS RESEARCH CORPORATION, ROSENBERG, TX:
3,310,888. PUB. 7-31-2007. INT. CL. 5.

BIRD TECHNOLOGIES GROUP INC., SOLON, OH:
3,314,478. INT. CL. 9.

BIRDS HILL PHARMACY, INC., NEEDHAM, MA:
3,313,930. INT. CL. 5.

BIRKS & MAYORS INC., MONTREAL, QUEBEC, CANADA:
3,312,301. PUB. 7-31-2007. INT. CL. 14.

BISORDI, ROBERT, AUBURN, WA:
3,311,208. PUB. 7-31-2007. INT. CL. 32.

BIVIGAL S.R.L., ITALY:
3,312,880. PUB. 7-31-2007. MULTIPLE CLASS, INT. CLS.
9, 18, 24 AND 25.

BIXBY & ASSOCIATES, BOULDER, CO, DBA BIXBY
SCHOOL:
3,311,523. PUB. 7-31-2007. INT. CL. 41.

BIZCOM HEALTHCARE SOLUTIONS, INC., RALEIGH, NC:
3,312,647. PUB. 7-31-2007. MULTIPLE CLASS, INT. CLS.
35 AND 45.

BIZMATCH, INC., CORPUS CHRISTI, TX:
2,090,823. REN. 9-9-07. INT. CL. 35.

BIZY, INC., PALM SPRINGS, CA:
3,313,271. INT. CL. 9.

BLACK & DECKER CORPORATION, THE, TOWSON, MD:
3,313,983. INT. CL. 21.
3,313,985. INT. CL. 21.
3,313,986. INT. CL. 21.

BLACK MARLIN DENTAL PRODUCTS, L.L.C., BOGART,
GA:
2,163,742. REN. 9-13-07. MULTIPLE CLASS, INT. CLS. 35
AND 41.

BLACK SHADOW DEER STANDS, INC., BAMBERG, SC:
3,311,341. PUB. 7-31-2007. INT. CL. 6.

BLACK, ROBERT OLIVER, FAIR OAKS, CA:
2,411,214. CANC. U.S. CL. 200.

BLACKBURN CAPITAL LLC, CONIFER, CO:
3,310,433. PUB. 7-31-2007. INT. CL. 36.

BLACKDOGBIKES.COM, LLC, FORT MILL, SC:
3,310,746. PUB. 7-31-2007. INT. CL. 35.

BLAIR HOLDINGS, INC., NEWARK, DE:
3,311,249. PUB. 7-31-2007. INT. CL. 35.

BLASZKIEWICZ RAFAL G., WARREN, MI:
3,311,517. PUB. 7-31-2007. INT. CL. 41.

BLATT, STEPHEN, WAYNESVILLE, NC:
3,314,845. INT. CL. 35.

BLAZENT, INC., SAN MATEO, CA:
3,311,480. PUB. 7-31-2007. INT. CL. 9.

BLEDINA, 69400 VILLEFRANCHE SUR SAONE, FRANCE:
3,311,647. PUB. 7-31-2007. MULTIPLE CLASS, INT. CLS.
5, 29 AND 30.

BLENDZ ENTERPRISES, INC., CAMPBELL, CA:
2,172,840. REN. 9-13-07. INT. CL. 42.

BLISTEX INC., OAK BROOK, IL:
3,313,724. MULTIPLE CLASS, INT. CLS. 3 AND 5.

BLK ENTERPRISES, LLC, GREEN POND, NJ:
3,314,812. INT. CL. 9.

BLOUIN, JOHN, JUPITER, FL:
3,313,454. INT. CL. 21.

BLUE CROSS AND BLUE SHIELD ASSOCIATION, CHICA-
GO, IL:
3,313,851. MULTIPLE CLASS, INT. CLS. 35, 36 AND 44.

BLUE CROSS AND BLUE SHIELD OF KANSAS CITY,
KANSAS CITY, MO:
3,311,600. PUB. 7-31-2007. INT. CL. 41.

BLUE KANGAROO LIMITED, LONDON, UNITED KING-
DOM:
3,314,082. INT. CL. 16.
3,314,083. INT. CL. 16.

BLUE OCEAN TRADEMARKS NV, CURACAO, NETHERLD
ANTILLES:
3,312,180. PUB. 4-24-2007. MULTIPLE CLASS, INT. CLS.
9, 16, 25, 28, 33, 42 AND 44.

BLUE Q CORPORATION, PITTSFIELD, MA:
3,314,191. INT. CL. 3.
3,314,193. INT. CL. 18.
3,314,688. INT. CL. 16.

BLUE STAR LUBRICATION TECHNOLOGY, LLC, ITASCA,
IL:
3,310,766. PUB. 7-31-2007. INT. CL. 4.

BLUE WREN ONLINE, INC., SAN FRANCISCO, CA:
2,410,419. CANC. MULTIPLE CLASS, INT. CLS. 9 AND
41.

BLUEBIRD SOFT, REPUBLIC OF KOREA:
3,312,727. PUB. 7-31-2007. INT. CL. 9.

BLUMENTHAL LANSING COMPANY, CARLSTADT, NJ:
3,311,484. PUB. 7-31-2007. MULTIPLE CLASS, INT. CLS. 8
AND 26.
3,311,485. PUB. 7-31-2007. MULTIPLE CLASS, INT. CLS. 8
AND 26.

BLUNT WRAP U.S.A., INC, MANDEVILLE, LA:
3,314,289. INT. CL. 34.

BLURTON, DAVID, WHITEVILLE, TN, DBA VIRTUAL-
BUZZ:
2,410,490. CANC. INT. CL. 35.

BMC SOFTWARE, INC., HOUSTON, TX:
2,411,138. CANC. MULTIPLE CLASS, INT. CLS. 41 AND
42.

BNAI ZION FOUNDATION, INC., NEW YORK, NY:
1,468,279. REN. 9-12-07. INT. CL. 16.

BNP MEDIA II, LLC, TROY, MI, REED ELSEVIER PROPER-
TIES INC., WILMINGTON, DE:
2,099,200. REN. 9-12-07. INT. CL. 16.

- BNP MEDIA, INC., TROY, MI:
2,111,485. REN. 9-13-07. INT. CL. 16.
2,111,486. REN. 9-12-07. INT. CL. 16.
2,113,211. REN. 9-12-07. INT. CL. 16.
- BO.M.I.S.A. BOTTONI MINUTERIE S.P.A., I-20094 ASSAGO (MI), ITALY:
3,312,724. PUB. 7-31-2007. MULTIPLE CLASS, INT. CLS. 6, 26 AND 40.
3,312,725. PUB. 7-31-2007. MULTIPLE CLASS, INT. CLS. 6, 26 AND 40.
- BOA ENERGY DRINK, LLC, DENVER, CO:
3,314,617. INT. CL. 32.
- BOARD ROOM, INC., THE, ROMEOVILLE, IL:
2,020,658. CANC. INT. CL. 9.
- BOARDROOM, INC., STAMFORD, CT, AVANT-GARDE MEDIA, INC., NEW YORK, NY:
1,072,020. REN. 9-13-07. INT. CL. 16.
- BOARDROOM, INC., STAMFORD, CT:
3,314,821. INT. CL. 5.
- BOB BARKER COMPANY, INC., FUQUAY-VARINA, NC:
2,095,979. REN. 9-9-07. INT. CL. 25.
- BOB KNIGHT PHOTOMARKETING, INC., TALLAHASSEE, FL:
3,311,002. PUB. 7-31-2007. INT. CL. 41.
- BOBBI PANTER, LLC, CHICAGO, IL:
3,312,406. PUB. 7-31-2007. INT. CL. 3.
- BOCCHIOTTI S.P.A. SOCIETA PER L'INDUSTRIA ELET-TROTECNICA, MIAN, ITALY:
1,445,204. REN. 9-12-07. INT. CL. 20.
- BOCCHIOTTI S.P.A. SOCIETA PER L'INDUSTRIA ELET-TROTECNICA, MILAN, ITALY:
1,447,529. REN. 9-12-07. INT. CL. 20.
- BODE CORPORATION, SPARTANBURG, SC:
3,311,276. PUB. 7-31-2007. INT. CL. 12.
- BODE, LARA E., HAMILTON, VA AND BODE, LISA J., HAMILTON, VA:
2,410,794. CANC. INT. CL. 16.
- BODE, TODD, AUSTIN, TX, DBA SUNTEX SILVER:
2,410,402. CANC. INT. CL. 35.
- BODEK & RHODES, PHILADELPHIA, PA:
2,021,043. CANC. INT. CL. 25.
- BODY CONCEPTS FITNESS STUDIO, INC., OLD BRIDGE, NJ:
3,310,620. PUB. 7-31-2007. INT. CL. 41.
- BODY WISE INTERNATIONAL, INC., TUSTIN, CA:
2,410,251. CANC. INT. CL. 16.
- BODY WISE INTERNATIONAL, LLC, TUSTIN, CA:
3,314,029. INT. CL. 5.
- BOEHRINGER INGELHEIM INTERNATIONAL GMBH, D-55216 INGELHEIM AM RHEIN, FED REP GERMANY:
2,410,422. CANC. INT. CL. 5.
- BOEHRINGER INGELHEIM INTERNATIONAL GMBH, 55218 INGELHEIM, FED REP GERMANY:
3,312,951. PUB. 7-31-2007. INT. CL. 5.
- BOEING WICHITA CREDIT UNION, WICHITA, KS:
2,411,599. CANC. INT. CL. 36.
- BOHEMIA INTERACTIVE STUDIO S.R.O., PRAGUE 5, CZECH REPUBLIC:
3,311,998. PUB. 4-24-2007. INT. CL. 9.
- BOK FINANCIAL CORPORATION, TULSA, OK:
3,310,735. PUB. 7-31-2007. MULTIPLE CLASS, INT. CLS. 35 AND 36.
- BOLIVER, THEO MICHAEL, COLUMBIA, SC:
3,312,524. PUB. 7-31-2007. INT. CL. 30.
- BON CHEF, INC., LAFAYETTE, NJ:
2,115,075. REN. 9-13-07. INT. CL. 21.
- BON SECOUR VILLAGE, LLC, CULLMAN, AL:
3,313,773. INT. CL. 36.
3,313,774. INT. CL. 37.
3,313,775. INT. CL. 41.
- BONBONS, INC., DETROIT, MI:
2,411,533. CANC. INT. CL. 35.
- BOND & CO. JEWELERS, INC., ST. PETERSBURG, FL:
3,312,135. PUB. 7-31-2007. INT. CL. 35.
- BOND, CHRISTOPHER S, MEXICO, MO:
3,310,521. PUB. 7-31-2007. INT. CL. 31.
- BONDI LIFESAVER HOLDINGS PTY LTD, CLAREMONT, AUSTRALIA:
3,312,492. PUB. 7-31-2007. INT. CL. 43.
- BONDI, VICTOR, SEATTLE, WA:
2,410,686. CANC. INT. CL. 35.
- BONFIGLIOLI RIDUTTORI S.P.A., ITALY:
3,312,731. PUB. 7-31-2007. MULTIPLE CLASS, INT. CLS. 7, 9 AND 12.
- BONGRAIN S.A., VIROFLAY, FRANCE:
3,312,452. PUB. 7-31-2007. INT. CL. 29.
- BONNIE K, INC., GREENVALE, NY:
3,311,775. PUB. 7-31-2007. INT. CL. 25.
- BOOK PASSAGE, INC., CORTE MADERA, CA:
2,086,908. REN. 9-12-07. MULTIPLE CLASS, INT. CLS. 16 AND 41.
- BOOK VINE FOR CHILDREN, INC., THE, MCHENRY, IL:
2,175,121. REN. 9-11-07. INT. CL. 35.
- BOOKSPAN, GARDEN CITY, NY:
3,314,326. INT. CL. 16.
- BOOTS RETAIL HOLDINGS (USA) INC., STAMFORD, CT:
3,313,451. INT. CL. 3.
- BOR JYE ENTERPRISE CO., LTD., TAINAN CITY, TAI-WAN:
3,311,106. PUB. 7-31-2007. INT. CL. 9.
- BORDERS PROPERTIES, INC., ANN ARBOR, MI TO BORDERS PROPERTIES, INC., ANN ARBOR, MI:
2,020,214. CANC. INT. CL. 42.
- BORINQUEN BISCUIT CORPORATION, YAUCO, PUERTO RICO:
3,310,969. PUB. 7-31-2007. INT. CL. 30.
- BOSCH SECURITY SYSTEMS, INC., FAIRPORT, NY:
2,411,254. CANC. INT. CL. 9.
- BOSELMAN, VALERIE, OMAHA, NE:
2,020,750. CANC. INT. CL. 16.
- BOSSMAN, MARGARET ANN, WOODVILLE, WI:
3,311,949. PUB. 7-31-2007. INT. CL. 16.
- BOSTON SCIENTIFIC CORPORATION, LOS GATOS, CA:
3,313,014. MULTIPLE CLASS, INT. CLS. 10 AND 44.
- BOSTON SCIENTIFIC SCIMED, INC., MAPLE GROVE, MN:
3,313,718. INT. CL. 10.
- BOULDER IMPORTS LLC, SAN ANTONIO, TX:
3,311,354. PUB. 7-31-2007. INT. CL. 33.
- BOULEVARD DES CAPUCINES, LLC., CHICAGO, IL, DBA, "CAPUCINES BOULEVARD":
3,310,536. PUB. 7-31-2007. INT. CL. 35.
- BOURGALT INDUSTRIES LTD., ST.BRIEUX, CANADA:
3,310,483. PUB. 7-31-2007. INT. CL. 7.
- BOWEN, JOHN, SCOTT, MUKILTEO, WA:
3,311,796. PUB. 7-31-2007. INT. CL. 15.
- BOWNE DISTINCT, LTD., MINEOLA, NY:
3,311,659. PUB. 7-31-2007. INT. CL. 9.
- BOXERCRAFT, INC., ATLANTA, GA:
3,310,652. PUB. 7-31-2007. INT. CL. 25.
- BOZARTS, INC., WARWICK, NY:
3,310,944. PUB. 7-31-2007. INT. CL. 42.
- BPAI, INC., SHELTON, CT AND EXHIBIT SURVEYS, INC., RED BANK, NJ:
3,314,529. INT. CL. 35.
- BPG PROPERTIES, LTD., YARDLEY, PA:
3,313,658. INT. CL. 36.
- BQE SOFTWARE, INC., TORRENCE, CA:
2,148,696. REN. 9-10-07. INT. CL. 9.
- BR CONSULTING, INC, MESA, AZ:
2,411,600. CANC. INT. CL. 41.
2,411,601. CANC. INT. CL. 41.
- BR CONSULTING, INC., MESA, AZ:
2,411,602. CANC. INT. CL. 41.
- BR CONSULTING, INC., SEDONA, AZ:
3,310,440. PUB. 7-31-2007. INT. CL. 41.
- BRACCO IMAGING S.P.A., MILAN, ITALY:
3,312,926. PUB. 7-31-2007. MULTIPLE CLASS, INT. CLS. 5, 9, 10, 41 AND 42.
- BRACH VAN HOUTEN HOLDING INC., CHICAGO, IL TO BARRY CALLEBAUT AG, ZURICH, SWITZERLAND:
2,021,176. CANC. INT. CL. 30.
- BRADNER CENTRAL COMPANY, CHICAGO, IL:
2,410,357. CANC. INT. CL. 16.

BRAEBURN SYSTEMS LLC, MONTGOMERY, IL:
3,313,174, INT. CL. 9.

BRAINKEEPER, INCORPORATED, CENTREVILLE, VA:
3,310,754, PUB. 7-31-2007. INT. CL. 42.

BRAMHILL, THOMAS WILFRED, ORLEANS ONTARIO,
CANADA:
2,020,670, CANC. MULTIPLE CLASS, INT. CLS. 16 AND
28.

BRANCH OFFICE, INC, THE, ALEXANDRIA, IN:
2,099,171. REN. 9-10-07. MULTIPLE CLASS, INT. CLS. 9
AND 16.

BRAND, IDELLE, S., NEW YORK, NY:
3,310,760, PUB. 7-31-2007. INT. CL. 44.

BRANDOLINI D'ADDA, BRANDINO, 30124 VENEZIA,
ITALY:
3,310,198, PUB. 7-31-2007. MULTIPLE CLASS, INT. CLS.
30, 31 AND 32.

BRANDON, JAMES W., III D/B/A HELM ENTERPRISES,
COLORADO SPRINGS, CO AND BRANDON, SHELLY A.,
D/B/A HELM ENTERPRISES, COLORADO SPRINGS, CO:
3,312,652, PUB. 7-31-2007. INT. CL. 22.

BRANDT CONSOLIDATED, INC., PLEASANT PLAINS, IL:
3,314,838, INT. CL. 5.
3,314,839, INT. CL. 5.
3,314,840, INT. CL. 5.

BRANLY, ROLANDO MANUEL, MIAMI, FL:
3,313,270, INT. CL. 9.

BRANOPAC GMBH, FED REP GERMANY:
3,312,699, PUB. 7-31-2007. INT. CL. 2.

BRANTLEY SEAN, WILDOMAR, CA:
3,312,429, PUB. 7-31-2007. INT. CL. 19.

BRASILIA GRILL INC, NEWARK, NJ:
3,310,387, PUB. 7-31-2007. INT. CL. 43.

BRASSERIE FISCHER, FRANCE:
3,312,743, PUB. 7-31-2007. MULTIPLE CLASS, INT. CLS.
32 AND 33.
3,312,744, PUB. 7-31-2007. MULTIPLE CLASS, INT. CLS.
32 AND 33.

BRASSERIE ST. BERNARD, NAAMLOZE VEN-
NOOTSCHAP, POPERINGE-WATOU, BELGIUM:
3,312,267, PUB. 7-31-2007. INT. CL. 32.

BRAVO COMPANY, BETHPAGE, NY:
2,410,487, CANC. INT. CL. 41.

BRAZEK'S RV PERFORMANCE, CENTRALIA, WA:
3,310,816, PUB. 7-31-2007. INT. CL. 9.

BREAKAWAY FOODS, LLC, COLUMBUS, OH:
2,409,897, CANC. MULTIPLE CLASS, INT. CLS. 29 AND
30.

BREISINGER, UDO, WAUNAKEE, WI:
2,096,839. REN. 9-7-07. INT. CL. 37.

BRENHAM AUTO LTD, BRENHAM, TX:
3,311,612, PUB. 7-31-2007. INT. CL. 35.

BRENNEN MEDICAL, LLC, ST. PAUL, MN:
2,095,138. REN. 9-7-07. INT. CL. 5.

BRESSLER, KATHRYN J., WILSON, WY, DBA CATTLE
KATE SILK SCARVES:
1,419,293, CANC. INT. CL. 25.

BRIAN D SCHIEBER, BATTLE GROUND, WA:
3,312,401, PUB. 7-31-2007. INT. CL. 35.

BRIAN MADDEN COMPANY, LLC, THE, SILVER
SPRINGS, MD:
3,313,499, INT. CL. 42.

BRIDGE BANK, N.A., SANTA CLARA, CA:
2,410,199, CANC. MULTIPLE CLASS, INT. CLS. 7 AND
40.

BRIDGES, SHEILA, NEW YORK, NY:
3,313,297, INT. CL. 42.

BRIDGEWATER CANDLE COMPANY, LLC, THE, BUFFA-
LO, SC:
2,411,203, CANC. MULTIPLE CLASS, INT. CLS. 3 AND 4.

BRIDGING THE GAP MUSIC, LLC, CAMBRIDGE, MA:
2,410,711, CANC. INT. CL. 41.

BRIERLEY & PARTNERS, INC., DALLAS, TX:
3,311,783, PUB. 7-31-2007. MULTIPLE CLASS, INT. CLS.
35 AND 42.
3,311,812, PUB. 7-31-2007. MULTIPLE CLASS, INT. CLS.
35 AND 42.

BRIGHTDOOR SYSTEMS, INC., CARY, NC:
3,311,059, PUB. 7-10-2007. INT. CL. 42.

BRIGHTON PRODUCTIONS, LLC, WASHINGTON, DC:
3,314,786, INT. CL. 41.

BRIGHTSTAR PARTNERS, INC., PARK RIDGE, IL:
3,312,627, PUB. 7-31-2007. INT. CL. 9.

BRIMMS INC., TONAWANDA, NY:
2,410,663, CANC. INT. CL. 28.

BRIMONT, MADELEINE, 75009 PARIS, FRANCE:
3,311,677, PUB. 7-31-2007. INT. CL. 14.

BRIOSCHI, INC., FAIR LAWN, NJ:
3,314,002, INT. CL. 5.

BRK BRANDS, INC., AURORA, IL:
3,314,748, INT. CL. 1.

BROAD ENTERPRISES NETWORKED, LLC, MIAMI, FL:
3,313,283, INT. CL. 25.
3,313,284, INT. CL. 25.

BRODY, EVAN, OLNEY, MD:
2,410,332, CANC. INT. CL. 42.

BRONKHORST HIGH - TECH B.V., RUURLO, NETHER-
LANDS:
3,311,243, PUB. 7-31-2007. INT. CL. 9.

BROOKS SPORTS, INC., BOTHELL, WA:
1,419,241, CANC. INT. CL. 25.

BROOKS, FRAN S., CORONADO, CA:
3,310,233, PUB. 7-31-2007. INT. CL. 41.

BROUGHTON, GREGORY, NEW YORK, NY:
3,310,359, PUB. 7-31-2007. INT. CL. 25.

BROWN & CO., INC., SOUTH HAMILTON, MA:
1,419,574, CANC. INT. CL. 9.

BROWN & HALEY, TACOMA, WA:
2,411,243, CANC. INT. CL. 30.

BROWN-FORMAN CORPORATION, LOUISVILLE, KY:
3,312,532, PUB. 2-20-2007. INT. CL. 33.

BROWN, J. ANTHONY, BEVERLY HILLS, CA:
3,311,121, PUB. 7-31-2007. INT. CL. 30.

BROWN, JAMES ROBERT, WAUKESHA, WI:
3,311,131, PUB. 7-31-2007. INT. CL. 41.

BROWN, VINCENT, WEST ORANGE, NJ:
3,310,376, PUB. 7-31-2007. INT. CL. 41.

BROWNELL & COMPANY, INCORPORATED, MOODUS,
CT:
2,410,829, CANC. INT. CL. 28.
2,410,830, CANC. INT. CL. 28.

BROWNELLS, MONTEZUMA, IA:
3,313,759, MULTIPLE CLASS, INT. CLS. 3, 4 AND 13.

BROYHILL FURNITURE INDUSTRIES, INC., LENOIR, NC:
2,411,418, CANC. INT. CL. 20.

BRP FINLAND OY, ROVANIEMI, FINLAND:
3,310,701, PUB. 7-31-2007. INT. CL. 12.

BRULIN & COMPANY, INC., INDIANAPOLIS, IN:
1,453,829. REN. 9-13-07. INT. CL. 3.
3,314,868, INT. CL. 3.

BRUNSWICK BOWLING & BILLIARDS CORPORATION,
MUSKEGON, MI:
2,411,122, CANC. INT. CL. 9.

BSG CLEARING SOLUTIONS NORTH AMERICA, LLC,
GLENVIEW, IL:
3,310,281, PUB. 7-10-2007. MULTIPLE CLASS, INT. CLS.
35 AND 36.

BSH BOSCH UND SIEMENS HAUSGERAETE GMBH,
MUNICH, FED REP GERMANY:
3,310,665, PUB. 7-31-2007. INT. CL. 9.
3,310,772, PUB. 7-31-2007. INT. CL. 9.
3,310,773, PUB. 7-31-2007. INT. CL. 11.
3,311,548, PUB. 7-31-2007. INT. CL. 7.

BSN MEDICAL, INC., CHARLOTTE, NC:
3,314,243, INT. CL. 10.

BTA TECHNOLOGY, INC., SAN JOSE, CA:
2,409,917, CANC. INT. CL. 9.
2,409,918, CANC. INT. CL. 9.
2,409,919, CANC. INT. CL. 9.
2,409,920, CANC. INT. CL. 9.
2,409,921, CANC. INT. CL. 9.

BUCHER, TODD J, CLEVELS, OH:
3,314,773, INT. CL. 35.

BUCK SWINDLE ASSOCIATES, INC., CARROLLTON, GA:
3,311,057, PUB. 7-31-2007. INT. CL. 19.

- BUCKEYE CABLEVISION, INC., TOLEDO, OH:
3,311,486, PUB. 7-31-2007. INT. CL. 38.
- BUCKEYE INTERNATIONAL, INC., MARYLAND HEIGHTS, MO:
3,314,989, INT. CL. 3.
- BUCKLEY, GARY W., CORONA DEL MAR, CA:
3,313,741, INT. CL. 25.
- BUFFALO BROADCASTING CO., INC., BUFFALO, NY:
2,256,720, CANC. INT. CL. 41.
- BUFFETS, INC., EAGAN, MN:
3,311,656, PUB. 7-31-2007. INT. CL. 43.
- BUILD-A-BEAR RETAIL MANAGEMENT, INC., ST. LOUIS, MO:
3,312,997, INT. CL. 16.
3,314,140, INT. CL. 35.
- BUILDING E DESIGN, INC., EAGAN, MN:
3,312,370, PUB. 7-31-2007. INT. CL. 9.
- BUILDING ENVELOPE INNOVATIONS LLC, SEATTLE, WA:
3,310,749, PUB. 7-31-2007. MULTIPLE CLASS, INT. CLS. 17 AND 19.
- BUILDING INDUSTRY ASSOCIATION OF SOUTHEASTERN MICHIGAN, FARMINGTON HILLS, MI:
2,411,282, CANC. INT. CL. 35.
- BUILDINGREPORTS.COM, INC., DULUTH, GA:
3,313,642, INT. CL. 9.
- BULBRITE INDUSTRIES, INC., MOONACHIE, NJ:
3,314,150, INT. CL. 11.
- BULL RUN BOOTS, LTD., HUNTINGTON BAY, NY:
3,313,096, INT. CL. 25.
- BURKE MARKETING CORPORATION, NEVADA, IA:
2,136,841, REN. 9-12-07. INT. CL. 29.
- BURKE READ GROUP, SAUSALITO, CA:
3,313,583, INT. CL. 35.
- BURLINGTON COAT FACTORY WAREHOUSE CORP., NORTH BURLINGTON, NJ:
3,314,976, INT. CL. 35.
- BURLINGTON NETWORKS INC., IRVINE, CA:
2,091,090, REN. 9-13-07. INT. CL. 39.
- BURNELL FOUNDATION, ARCADIA, CA:
3,312,119, PUB. 7-31-2007. INT. CL. 16.
3,312,120, PUB. 7-31-2007. INT. CL. 16.
- BURNES HOME ACCENTS, LLC, AUSTIN, TX:
3,313,281, INT. CL. 20.
- BURNETT, J. MARK, SANTA MONICA, CA:
2,021,300, CANC. INT. CL. 41.
- BURNS, JOHN R., SOUTH MILWAUKEE, WI:
3,314,745, INT. CL. 10.
- BURNS, TAMMI S., STAYTON, OR:
3,314,791, MULTIPLE CLASS, INT. CLS. 16 AND 25.
- BURSAW, MICHAEL, CARMEL, IN:
2,015,687, REN. 9-12-07. INT. CL. 16.
- BURST MEDIA CORPORATION, BURLINGTON, MA, COFFIN, G. JARVIS, III, KATOHAN, NY:
2,038,577, REN. 9-7-07. INT. CL. 35.
- BURTON, DAVID L., THOROLD ON., CANADA:
2,411,100, CANC. INT. CL. 25.
- BUSCH ENTERTAINMENT CORPORATION, ST. LOUIS, MO:
2,181,469, REN. 9-13-07. INT. CL. 41.
- BUSH LEASING, INC., WILMINGTON, OH:
2,410,237, CANC. INT. CL. 39.
- BUSSON, MARC, H. MARSEILLE, FRANCE:
3,314,455, INT. CL. 3.
- BUTLER TECHNOLOGY AND CAREER DEVELOPMENT SCHOOLS, FAIRFIELD TOWNSHIP, OH:
3,313,108, MULTIPLE CLASS, INT. CLS. 16 AND 41.
- BUTTERFLY WORLDWIDE, LLC, ANN ARBOR, MI:
3,313,912, INT. CL. 14.
- BUTTERS, MARYJANE, MOSCOW, ID:
3,311,143, PUB. 7-17-2007. INT. CL. 35.
- BUTTERWORTH TECHNOLOGY, INC., HOUSTON, TX:
3,312,255, PUB. 7-31-2007. MULTIPLE CLASS, INT. CLS. 7, 17, 37 AND 42.
3,312,256, PUB. 7-31-2007. MULTIPLE CLASS, INT. CLS. 7, 17, 37 AND 42.
- BUZZLOGIC, LC, SAN FRANCISCO, CA:
3,313,535, INT. CL. 9.
- BVC SPORTS AND ENTERTAINMENT, LLC, ORLANDO, FL:
3,314,848, INT. CL. 41.
- BYRIDER FRANCHISING, INC., CARMEL, IN:
3,312,312, PUB. 7-31-2007. MULTIPLE CLASS, INT. CLS. 35 AND 36.
- BYTRONICS, INC., HACKETTSTOWN, NJ:
3,314,655, INT. CL. 24.
- C & A INDUSTRIES, INC., OMAHA, NE:
2,410,633, CANC. INT. CL. 35.
2,410,635, CANC. INT. CL. 35.
- C & C CATERING SERVICE, LTD., BROOKLYN, NY:
2,411,126, CANC. MULTIPLE CLASS, INT. CLS. 29 AND 30.
- C & G SAVINGS BANK, ALTOONA, PA:
3,314,502, INT. CL. 36.
3,314,503, INT. CL. 36.
- C AND C WINE SERVICES, SANTA ROSA, CA:
2,020,519, CANC. INT. CL. 33.
- C. J. TWO BROTHERS, INC., NEW YORK, NY:
2,409,843, CANC. INT. CL. 25.
- C.B. FLEET INVESTMENT CORPORATION, WILMINGTON, DE:
3,314,837, INT. CL. 3.
- C.J. EXPRESS TRADING CORP., NAPLES, FL:
2,411,009, CANC. INT. CL. 14.
- C.K.F. FOODS, INC., MOUNT PROSPECT, IL:
3,313,806, INT. CL. 29.
- C/HCA, INC., NASHVILLE, TN:
3,312,575, PUB. 7-31-2007. INT. CL. 35.
- CABLE CAR COFFEE COMPANY, INC., SAN RAFAEL, CA:
1,451,522, REN. 9-10-07. INT. CL. 42.
- CABLETENNA CORP., MONROE TOWNSHIP, NJ:
3,312,253, PUB. 7-31-2007. INT. CL. 9.
- CABOODLE! TOYS LLC, NEW YORK, NY:
3,314,365, INT. CL. 28.
- CABOT HOSIERY MILLS, INC., NORTHFIELD, VT:
2,159,716, REN. 9-8-07. INT. CL. 25.
- CABOT SAFETY INTERMEDIATE CORPORATION, NEWARK, DE, E-A-R CORPORATION, WESTWOOD, MA:
1,071,450, REN. 9-13-07. INT. CL. 17.
- CABOT SAFETY INTERMEDIATE CORPORATION, NEWARK, DE:
3,314,795, INT. CL. 9.
3,314,859, INT. CL. 9.
- CACIQUE, INC., CITY OF INDUSTRY, CA:
2,093,424, REN. 9-13-07. INT. CL. 29.
2,093,425, REN. 9-13-07. INT. CL. 29.
2,093,442, REN. 9-13-07. INT. CL. 29.
- CACIQUE, INC., INDUSTRY, CA:
2,169,698, REN. 9-13-07. INT. CL. 29.
- CADBURY ADAMS CANADA INC., TORONTO, CANADA:
3,314,527, INT. CL. 30.
- CADBURY ADAMS USA LLC, PARSIPPANY, NJ:
2,101,869, REN. 9-7-07. INT. CL. 30.
- CADBURY BEVERAGES INC., STAMFORD, CT TO COTT BEVERAGES INC., TORONTO ONTARIO, CANADA:
2,021,327, CANC. INT. CL. 32.
- CADILLAC JACK, INC., DULUTH, GA:
3,313,319, INT. CL. 9.
- CAESARS WORLD, INC., LAS VEGAS, NV:
3,312,633, PUB. 7-31-2007. MULTIPLE CLASS, INT. CLS. 25, 41 AND 43.
- CAFFE PAZZESCO, LLC, SPOKANE, WA:
3,314,160, INT. CL. 43.
- CAFFEINE DREAMS, INC., CAPE CORAL, FL:
3,311,410, PUB. 7-31-2007. INT. CL. 43.
- CAKE, LLC, SANTA MONICA, CA:
3,310,657, PUB. 7-17-2007. MULTIPLE CLASS, INT. CLS. 41 AND 42.
- CAL TAN, LLC, LOS ANGELES, CA:
3,314,413, INT. CL. 3.
- CALIFORNIA BLUEGRASS ASSOCIATION, WILSEYVILLE, CA:
2,410,243, CANC. INT. CL. 16.
- CALIFORNIA WESTERN SCHOOL OF LAW, SAN DIEGO, CA:
3,313,652, INT. CL. 41.

- CALIGEN EUROPE B.V., 4825 BC BREDA, NETHERLANDS:
2,409,823, CANC. MULTIPLE CLASS, INT. CLS. 1 AND 17.
- CALLAWAY GOLF COMPANY, CARLSBAD, CA:
3,314,710, INT. CL. 28.
3,314,711, INT. CL. 28.
- CALLISTO SOFTWARE, INC., WHEATON, IL:
2,409,727, CANC. INT. CL. 9.
- CALSOTA SUPPLY, LLC, ST. PAUL, MN:
3,314,463, MULTIPLE CLASS, INT. CLS. 6 AND 22.
- CALYPSO SYSTEMS, INC., CHICAGO, IL:
2,409,916, CANC. MULTIPLE CLASS, INT. CLS. 35 AND 42.
- CAMBIASO HERMANOS SAC, VALPARAISO, CHILE:
3,314,819, INT. CL. 30.
- CAMBRIDGE ENERGY RESEARCH ASSOCIATES, INC., CAMBRIDGE, MA:
2,093,892, REN. 9-10-07, INT. CL. 35.
- CAMBRIDGE NUTRITIONAL SCIENCES LTD., LITTLEPORT, CAMBRIDGES, UNITED KINGDOM:
3,311,512, PUB. 7-31-2007, INT. CL. 5.
- CAMERON SCOTT COSMETICS, INC., MENLO PARK, CA:
1,418,875, CANC. INT. CL. 3.
- CAMILLE RIO, S.A., SPAIN:
3,312,956, PUB. 7-31-2007, INT. CL. 25.
- CAMILLO CORVI S.P.A., MILAN, ITALY:
2,409,702, CANC. INT. CL. 3.
2,409,703, CANC. INT. CL. 3.
- CAMPBELL, MARILYN, KITCHENER, ONTARIO, CANADA:
2,411,384, CANC. INT. CL. 24.
- CAMPBELL, ROBERT B., FOLSOM, CA:
3,313,587, INT. CL. 44.
- CAMPER, S.L., SPAIN:
3,312,872, PUB. 7-31-2007, INT. CL. 25.
3,312,888, PUB. 7-31-2007, INT. CL. 25.
- CANAL + DISTRIBUTION, 92000 BOULOGNE BILLANCOURT, FRANCE:
2,409,769, CANC. MULTIPLE CLASS, INT. CLS. 9 AND 41.
- CANAM ASSOCIATES, INC., ST. CHARLES, IL:
3,312,159, PUB. 7-31-2007, INT. CL. 25.
- CANARYS AUTOMATIONS LTD., BANGALORE, KARNATAKA, INDIA:
3,313,262, INT. CL. 9.
- CANCELMO, BYRON, WATERFORD, MI:
3,314,949, INT. CL. 9.
- CANDACE L. BLOM, JOHNSON CITY, TN:
3,311,463, PUB. 7-31-2007, INT. CL. 14.
- CANINE EXPERIENCE, LLC, JERSEY CITY, NJ:
3,313,678, INT. CL. 35.
- CANNONDALE BICYCLE CORPORATION, BETHEL, CT:
3,313,166, INT. CL. 12.
- CANNUFLOW, INC., SAN JOSE, CA:
3,313,840, INT. CL. 10.
- CANON KABUSHIKI KAISHA, SHIMOMARUKO, OHTAKU, TOKYO, JAPAN:
2,410,971, CANC. INT. CL. 9.
- CANTERBURY DESIGNS, INC., LOS ANGELES, CA:
2,096,440, REN. 9-13-07, MULTIPLE CLASS, INT. CLS. 6, 11, 21 AND 42.
- CANTINE SETTESOLI SOCIETA COOPERATIVA AGRICOLA, MENFI (AG), ITALY AND ENOTRIA WINECELLARS LTD., LONDON, UNITED KINGDOM:
3,314,291, INT. CL. 33.
- CANTWELL, TOM, ALISO VIEJO, CA:
3,313,877, INT. CL. 18.
- CAPCO ENTERPRISES INC., EAST HANOVER, NJ:
3,314,897, INT. CL. 30.
- CAPE COD BAY SEAFOOD, INC., WEST BARNSTABLE, MA:
3,310,577, PUB. 7-31-2007, INT. CL. 29.
- CAPEL, INC., TROY, NC:
1,419,313, CANC. INT. CL. 27.
- CAPINTELLECT COMMUNICATIONS, INC., LAS VEGAS, NV:
3,314,412, INT. CL. 35.
- CAPITAL BREWERY COMPANY, INC., MIDDLETON, WI:
3,312,160, PUB. 7-31-2007, INT. CL. 32.
- CAPITAL PACIFIC BANK, PORTLAND, OR:
3,311,373, PUB. 7-31-2007, INT. CL. 36.
- CAPITAL PRESERVE, THE, TARRYTOWN, NY:
2,410,413, CANC. INT. CL. 36.
- CAPRIOLA CORP., SARASOTA, FL:
3,313,543, INT. CL. 35.
- CAPSAW, INC., UKIAH, CA:
3,311,397, PUB. 7-31-2007, INT. CL. 36.
- CAPTAIN HOPE'S KIDS, DALLAS, TX:
3,313,939, MULTIPLE CLASS, INT. CLS. 35 AND 36.
- CAR MATE MFG. CO., LTD., TOSHIMA-KU, JAPAN:
3,312,566, PUB. 7-31-2007, MULTIPLE CLASS, INT. CLS. 9, 12, 14, 25 AND 34.
- CARACATERRA, SUSAN, ATTLEBORO, MD:
3,314,107, INT. CL. 25.
- CARBUNUP PTY. LTD., CARBUNUP, WESTERN AUSTRALIA, AUSTRALIA:
3,311,955, PUB. 7-31-2007, INT. CL. 33.
- CARDIAC PACEMAKERS, INC., ST. PAUL, MN:
2,020,176, CANC. INT. CL. 10.
- CARDIODYNE, INC., IRVINE, CA:
2,410,963, CANC. INT. CL. 10.
- CARE LEVEL MANAGEMENT GROUP, LLC, WOODLAND HILLS, CA:
3,314,763, INT. CL. 35.
- CAREFREE BUILDING COMPANY, INC., COLCHESTER, CT:
2,100,483, REN. 9-12-07, INT. CL. 19.
- CARFO TRADING S.R.L., ITALY:
3,312,751, PUB. 7-17-2007, INT. CL. 9.
- CARFORA, MASSIMO, 94140 ALFORTVILLE, FRANCE:
2,410,260, CANC. MULTIPLE CLASS, INT. CLS. 35, 41 AND 42.
- CARGILL, INCORPORATED, WAYZATA, MN:
2,410,972, CANC. INT. CL. 35.
3,314,257, INT. CL. 36.
3,314,382, INT. CL. 5.
- CARGURUS LLC, CAMBRIDGE, MA:
3,312,242, PUB. 7-31-2007, MULTIPLE CLASS, INT. CLS. 35 AND 38.
- CARIBOU LAKE SOFTWARE, INC., BLOOMINGTON, MN:
2,410,038, CANC. INT. CL. 9.
- CARITAS RANCH BAR-B-Q, CO., BOERNE, TX:
3,313,776, INT. CL. 29.
- CARL FREUDENBERG KG, WEINHEIM, FED REP GERMANY:
3,311,819, PUB. 7-31-2007, INT. CL. 21.
- CARL J. ABRAHAM, GREAT NECK, NY:
3,312,208, PUB. 7-31-2007, INT. CL. 28.
- CARL ZEISS AG, 73447 OBERKOCHEN, FED REP GERMANY:
3,311,130, PUB. 7-31-2007, INT. CL. 10.
- CARLA FRACCI PARFUMS S.R.L., ITALY:
3,312,795, PUB. 7-31-2007, INT. CL. 3.
3,312,796, PUB. 7-31-2007, INT. CL. 3.
- CARLING TECHNOLOGIES, INC., PLAINVILLE, CT:
3,313,508, INT. CL. 9.
- CARLISLE PLASTICS, INC., PHOENIX, AZ:
2,409,690, CANC. INT. CL. 20.
- CARLOS SANCHEZ DE LA PENA, SAN YSIDRO, CA:
3,310,999, PUB. 7-31-2007, INT. CL. 39.
3,311,000, PUB. 7-31-2007, INT. CL. 39.
- CARNABY.COM, INC., CASSELBERRY, FL:
2,642,899, CANC. INT. CL. 35.
- CARNETT'S, INC., LILBURN, GA:
2,180,139, REN. 9-13-07, INT. CL. 37.
- CAROL'S DAUGHTER HOLDINGS, LLC, NEW YORK, NY:
3,314,668, INT. CL. 3.
- CAROLINA THEATRE PRESERVATION ASSOCIATION, INC., SPRUCE PINE, NC:
3,314,914, INT. CL. 35.
3,314,915, INT. CL. 41.
- CAROLINE C. NEWSOM, LITCHFIELD PARK, AZ:
3,312,604, PUB. 7-31-2007, INT. CL. 36.
- CARPE DIEM, PARIS, FRANCE:
1,419,310, CANC. INT. CL. 26.

- CARPE DIEM LLC, JERSEY CITY, NJ:
3,311,539, PUB. 7-31-2007. INT. CL. 25.
- CARPET AND RUG INSTITUTE, THE, DALTON, GA:
2,093,182. REN. 9-11-07. U.S. CL. A.
2,093,183. REN. 9-11-07. U.S. CL. A.
- CARQUEST CORPORATION, THE, LAKEWOOD, CO:
2,411,461, CANC. INT. CL. 7.
- CARR SCOTT SOFTWARE INCORPORATED, DUXBURY, MA:
3,314,983, INT. CL. 9.
- CARRABBA'S ITALIAN GRILL, INC., TAMPA, FL:
2,091,159. REN. 9-11-07. INT. CL. 25.
- CARROLL COMPANY, GARLAND, TX, SHERWIN-WILLIAMS DIVERSIFIED BRANDS, INC., CLEVELAND, OH:
2,162,774. REN. 9-10-07. INT. CL. 3.
- CARROLL, JOHN, SAMUEL, AUSTIN, TX:
3,310,513, PUB. 7-31-2007. INT. CL. 36.
- CARROT TOP RECORDS, INC., CHICAGO, IL:
2,096,645. REN. 9-9-07. INT. CL. 9.
- CARRUBBA, INC., MILFORD, CT:
3,314,784, INT. CL. 1.
- CARRY THE DAY, INC., FOSTER CITY, CA:
3,313,739, INT. CL. 9.
- CARSON PRODUCTS COMPANY, SAVANNAH, GA:
2,410,147, CANC. INT. CL. 3.
- CARSPOT.COM, LLC, MILWAUKEE, WI:
3,311,850, PUB. 7-31-2007. MULTIPLE CLASS, INT. CLS. 9 AND 35.
- CART-AWAY CONCRETE SYSTEMS, INC., MCMINNVILLE, OR:
3,311,023, PUB. 7-31-2007. MULTIPLE CLASS, INT. CLS. 7 AND 12.
3,311,149, PUB. 7-31-2007. MULTIPLE CLASS, INT. CLS. 7 AND 12.
- CARTER JANE, SOUTH ORANGE, NJ:
3,310,291, PUB. 7-31-2007. INT. CL. 3.
- CARTUS CORPORATION, DANBURY, CT:
3,314,369, INT. CL. 35.
3,314,370, INT. CL. 35.
3,314,371, INT. CL. 35.
3,314,372, INT. CL. 36.
3,314,373, INT. CL. 36.
3,314,374, INT. CL. 36.
- CARWIZARD, INC., ENGLEWOOD, CO:
2,411,488, CANC. INT. CL. 36.
- CAS DESIGNS, INC., NOVATO, CA:
3,313,789, INT. CL. 6.
- CAS MEDICAL SYSTEMS, INC., BRANFORD, CT:
3,313,195, INT. CL. 10.
- CASABLANCA FAN COMPANY, CITY OF INDUSTRY, CA TO HUNTER FAN COMPANY, MEMPHIS, TN:
2,020,249, CANC. INT. CL. 11.
- CASCADE WOOD PRODUCTS, INC., WHITE CITY, OR:
3,312,629, PUB. 7-31-2007. INT. CL. 19.
- CASINO DATA SYSTEMS, LAS VEGAS, NV:
2,020,144, CANC. INT. CL. 42.
- CASIO KEISANKI KABUSHIKI KAISHA, TOKYO, JAPAN, DBA CASIO COMPUTER CO., LTD.:
3,314,996, INT. CL. 9.
- CASSA LOMBARDA S.P.A., ITALY:
3,312,781, PUB. 7-31-2007. INT. CL. 36.
- CASTILLO, MAXIMILLIAN, WEST HILLS, CA:
2,410,320, CANC. INT. CL. 35.
- CASTROL LIMITED, SWINDO, SILTSHIRE SN3 1RE, ENGLAND:
1,418,834, CANC. INT. CL. 1.
- CATALINA MARKETING CORPORATION, ST. PETERSBURG, FL, CATALINA MARKETING CORPORATION, LOS ANGELES, CA:
1,454,173. REN. 9-13-07. INT. CL. 16.
- CATALOG.COM, INC., OKLAHOMA CITY, OK:
3,314,063, INT. CL. 9.
3,314,065, INT. CL. 9.
- CATALYTIC GENERATORS, INC., NORFOLK, VA:
2,021,391, CANC. INT. CL. 11.
- CATERPILLAR INC., PEORIA, IL:
3,313,375, MULTIPLE CLASS, INT. CLS. 25, 28 AND 41.
- CATHERINE'S FINE GOURMET PRODUCTIONS, INC., PORTLAND, OR:
2,410,569, CANC. INT. CL. 29.
- CATHOLIC HEALTHCARE WEST, SAN FRANCISCO, CA:
3,313,735, INT. CL. 44.
- CAVANAUGH, ASA ANN, LEESBURG, VA, STEBBINGS, STUART M., DE PERE, WI:
643,366. REN. 9-13-07. U.S. CL. 46 (INT. CL. 30).
- CAVLOGIX CORPORATION, SEATTLE, WA:
2,410,514, CANC. INT. CL. 9.
- CB TM CORP., MISSION VIEJO, CA:
2,020,949, CANC. INT. CL. 36.
- CBS BROADCASTING INC., NEW YORK, NY:
2,410,638, CANC. INT. CL. 41.
- CBS RADIO EAST INC., NEW YORK, NY:
3,310,860, PUB. 7-31-2007. INT. CL. 41.
- CCB CREDIT SERVICES, INC., SPRINGFIELD, IL:
3,312,512, PUB. 7-31-2007. INT. CL. 36.
- CE CE CHIN, INC., NEW YORK, NY:
3,312,229, PUB. 7-31-2007. INT. CL. 25.
- CE EUROPE LIMITED, UNITED KINGDOM:
3,312,782, PUB. 7-31-2007. MULTIPLE CLASS, INT. CLS. 9, 16, 28 AND 41.
- CEDAR RIDGE FINANCIAL SERVICES, INC., ELIZABETH, IL:
3,314,701, INT. CL. 29.
- CEDARAPIDS, INC., CEDAR RAPIDS, IA, IOWA MANUFACTURING COMPANY OF CEDAR RAPIDS, IOWA, CEDAR RAPIDS, IA:
1,072,532. REN. 9-9-07. INT. CL. 7.
- CEDARAPIDS, INC., CEDAR RAPIDS, IA:
1,454,903. REN. 9-10-07. INT. CL. 7.
- CELESTIAL SEASONINGS, INC., BOULDER, CO:
3,310,799, PUB. 7-31-2007. INT. CL. 30.
3,310,807, PUB. 7-31-2007. INT. CL. 32.
- CELL TREASURES INC., PENSACOLA, FL:
3,314,414, INT. CL. 9.
- CELLOTAPE LTD., FREMONT, CA:
2,410,586, CANC. MULTIPLE CLASS, INT. CLS. 35 AND 40.
- CELLULAR ONE PROPERTIES, LLC, OKLAHOMA CITY, OK:
2,410,912, CANC. INT. CL. 38.
- CELULA, INC., SAN DIEGO, CA:
3,314,972, MULTIPLE CLASS, INT. CLS. 9 AND 10.
- CENTER FOR NEIGHBORHOOD TECHNOLOGY, CHICAGO, IL:
3,312,491, PUB. 7-31-2007. INT. CL. 39.
- CENTER MASS, INC., CANTON, MI:
3,311,164, PUB. 7-31-2007. MULTIPLE CLASS, INT. CLS. 35 AND 41.
3,311,167, PUB. 7-31-2007. MULTIPLE CLASS, INT. CLS. 35 AND 41.
- CENTERSTONE INSURANCE AND FINANCIAL SERVICES, INC., DALLAS, TX, DBA BENEFITMALL.COM:
2,410,673, CANC. INT. CL. 36.
- CENTEX CORPORATION, DALLAS, TX:
2,127,317. REN. 9-7-07. INT. CL. 36.
- CENTIMARK INTERNATIONAL CORPORATION, WILMINGTON, DE:
3,312,501, PUB. 7-31-2007. INT. CL. 37.
- CENTRA-LARM MONITORING, INC., MANCHESTER, NH:
3,315,013, INT. CL. 42.
- CENTRAL ELECTRIC COMPANY, FULTON, MO:
2,164,555. REN. 9-13-07. INT. CL. 9.
- CENTRAL GARDEN & PET COMPANY, WALNUT CREEK, CA:
3,314,234, MULTIPLE CLASS, INT. CLS. 11 AND 16.
- CENTRAL HOLIDAYS, INC., MOONACHIE, NJ:
3,311,424, PUB. 7-31-2007. INT. CL. 39.
- CENTRAL PENN IT SERVICES, LLC, MOUNT WOLF, PA:
3,311,028, PUB. 7-31-2007. INT. CL. 42.
- CENTRAL TANSHI SECURITIES, CO., LTD., JAPAN:
3,312,878, PUB. 7-31-2007. MULTIPLE CLASS, INT. CLS. 36, 38 AND 42.

- CENTRE TECHNIQUE DU BOIS ET DE L'AMEUBLEMENT (CENTRE TECHNIQUE INDUSTRIEL INTERPROFES-SIONNEL REGI PAR LA LOI DU 22 JUILLET 1948, 75012 PARIS, FRANCE:
2,409,741, CANC. INT. CL. 20.
- CENTRO DE INVESTIGACION Y ASISTENCIA TECNICA DEL ESTADO DE QUERETARO, A.C., QUERETARO, QRO, MEXICO:
2,084,767, REN. 9-12-07. INT. CL. 42.
- CEO SHIRT CORPORATION, THE, NEW YORK, NY:
3,314,572, INT. CL. 25.
- CEOL PRODUCTIONS, MANCHESTER CENTER, VT:
3,311,232, PUB. 7-31-2007. INT. CL. 36.
- CEP HOLDINGS, INC., NEWARK, DE:
2,410,917, CANC. INT. CL. 5.
- CERAPER S.L., 45007 TOLEDO, SPAIN:
2,409,880, CANC. MULTIPLE CLASS, INT. CLS. 6 AND 19.
- CERINI, MARIA ERNESTINA, SUNO (NOVARA), ITALY:
2,409,836, CANC. INT. CL. 25.
- CERTIFIED ASSET EXCHANGE, INC., NEWPORT BEACH, CA:
3,312,450, PUB. 7-31-2007. MULTIPLE CLASS, INT. CLS. 35 AND 36.
- CERTIFIED COLOR CORPORATION, ORANGE, CA:
3,311,200, PUB. 7-31-2007. INT. CL. 2.
- CESKO SALES COMPANY, BRIGHTON, MI, DBA VERSA-TEX INDUSTRIES:
1,419,015, CANC. INT. CL. 9.
- CGI TECHNOLOGIES AND SOLUTIONS INC., FAIRFAX, VA:
2,410,810, CANC. INT. CL. 42.
2,410,811, CANC. INT. CL. 35.
- CHALLENGER PARTNERS, LLC, MENTOR, OH:
3,250,458, COR. INT. CL. 12.
- CHAMBER OF COMMERCE OF THE UNITED STATES, WASHINGTON, DC:
1,419,499, CANC. INT. CL. 41.
- CHAMBERLAND, RICHARD, NEWFIELDS, NH AND STAPLES, JOHN B., NEWFIELDS, NH:
3,310,401, PUB. 7-31-2007. INT. CL. 41.
- CHAMBERS, GLENN B., ST. AUGUSTINE, FL:
3,314,247, INT. CL. 35.
- CHAMONG TEA EXPORTS PVT. LTD., WEST BENGAL, INDIA:
3,312,520, PUB. 7-31-2007. INT. CL. 30.
- CHAMPAGNE TENNIS ETCETERA LTD., NORTH VENICE, FL:
3,313,538, INT. CL. 35.
- CHAMPION LABORATORIES, INC., ALBION, IL, CHAM-PION LABORATORIES, INC., WEST SALEM, IL:
808,484, REN. 9-12-07. U.S. CL. 31 (INT. CLS. 7, 11 AND 12).
- CHAMPIONS ACADEMY, INC., CARMEL, IN:
3,310,829, PUB. 7-31-2007. INT. CL. 41.
- CHAN LUU INC., LOS ANGELES, CA:
3,314,816, INT. CL. 35.
- CHANCE-I USA CORP., IRVINE, CA:
3,260,050, CANC. IIRN. RESTORED TO S.N. 78-613,755.
- CHANGE ROUND-UP, INC., COXSACKIE, NY:
3,311,411, PUB. 7-31-2007. INT. CL. 36.
- CHANGETOOLS INC, HUNTSVILLE, AL:
3,314,988, INT. CL. 9.
- CHANNEL INDUSTRIES, INC., CANAL POINT, FL:
1,418,931, CANC. INT. CL. 7.
- CHAO, PEI-CHING, TAICHUNG, TAIWAN:
3,314,315, INT. CL. 25.
- CHAPMAN, JAMES A., HARTSELLE, AL:
3,313,875, INT. CL. 43.
- CHAPTER IV INVESTORS, LLC, CHARLOTTE, NC:
3,314,437, INT. CL. 36.
- CHARLES BESELER COMPANY, FLORHAM PARK, NJ:
1,419,027, CANC. INT. CL. 9.
- CHARLES KOMAR & SONS, INC., NEW YORK, NY:
3,313,899, INT. CL. 25.
- CHARLES SCHWAB & CO., INC., SAN FRANCISCO, CA:
2,410,361, CANC. INT. CL. 16.
- CHARLES STARK DRAPER LABORATORY, INC. THE, CAMBRIDGE, MA:
1,071,969, REN. 9-12-07. MULTIPLE CLASS, INT. CLS. 41 AND 42.
- CHARLESBERND AG, MÜNCHEN, FED REP GERMANY:
3,313,256, INT. CL. 35.
- CHARNI COSMETICS, INC., FORT LEE, NJ:
2,410,239, CANC. INT. CL. 3.
- CHARTWAY FINANCIAL SERVICES, LLC, VIRGINIA BEACH, VA:
3,311,997, PUB. 7-31-2007. INT. CL. 36.
- CHASE, CHAD, AUSTIN, TX:
2,411,252, CANC. INT. CL. 9.
- CHATEAU GRAND TRAVERSE, LTD., TRAVERSE CITY, MI:
3,311,179, PUB. 7-31-2007. INT. CL. 33.
- CHATEAU MORRISSETTE, INC., MEADOWS OF DAN, VA:
2,093,694, REN. 9-7-07. INT. CL. 33.
- CHATTANOOGA CORPORATION, HIXSON, TN:
1,419,075, CANC. INT. CL. 10.
- CHEETAH CONSERVATION FUND, INC., CINCINNATI, OH:
2,410,135, CANC. MULTIPLE CLASS, INT. CLS. 16 AND 42.
- CHEF HANS' GOURMET FOODS, INC., MONROE, LA:
3,312,127, PUB. 7-31-2007. MULTIPLE CLASS, INT. CLS. 29 AND 30.
- CHEF TOOLS NETWORK, INC., SEATTLE, WA:
3,311,679, PUB. 7-31-2007. INT. CL. 35.
- CHEM-SERV, WEST COVIAN, CA:
3,311,336, PUB. 7-31-2007. MULTIPLE CLASS, INT. CLS. 37 AND 40.
- CHEMDAQ, INC., PITTSBURGH, PA:
3,312,076, PUB. 7-31-2007. INT. CL. 9.
- CHEMENCE MEDICAL PRODUCTS, INC., ALPHARETTA, GA:
3,313,313, INT. CL. 5.
3,313,314, INT. CL. 5.
3,313,315, INT. CL. 5.
- CHEMICAL BANK, NEW YORK, NY:
1,418,905, CANC. INT. CL. 5.
- CHEMICAL LEAMAN TANK LINES, INC., LIONVILLE, PA:
1,419,480, CANC. INT. CL. 39.
- CHEMISCHES LABORATORIUM; DR. KURT RICHTER GMBH, FED REP GERMANY:
3,312,885, PUB. 7-31-2007. INT. CL. 1.
- CHENNY TROUPE, INC., CHICAGO, IL:
3,312,540, PUB. 4-24-2007. INT. CL. 44.
- CHESAPEAKE MEDICAL PRODUCTS, INC., BALTIMORE, MD:
3,311,112, PUB. 7-31-2007. INT. CL. 10.
3,311,294, PUB. 7-31-2007. INT. CL. 10.
- CHESHIRE, THOMAS, MARIETTA, GA AND SHINA, MI-CHAEL, MARIETTA, GA AND BRUCE, MIKE, MARIET-TA, GA:
2,410,197, CANC. INT. CL. 41.
- CHESNUT JR., STEVE, NORTH RICHLAND HILLS, TX:
3,311,280, PUB. 7-31-2007. INT. CL. 35.
- CHESNY, JOHN D., NAPERVILLE, IL:
2,410,375, CANC. INT. CL. 35.
- CHEVALIER INTERNATIONAL (USA) INC., SOUTH SAN FRANCISCO, CA:
3,310,634, PUB. 7-10-2007. INT. CL. 29.
- CHEVRON PHILLIPS CHEMICAL COMPANY LP, THE WOODLANDS, TX:
439,981, REN. 9-13-07. U.S. CL. 52 (INT. CL. 3).
1,452,834, REN. 9-13-07. INT. CL. 4.
2,100,579, REN. 9-13-07. INT. CL. 17.
- CHICAGO BEARS FOOTBALL CLUB, INC., LAKE FOREST, IL:
1,072,395, REN. 9-9-07. INT. CL. 41.
- CHICAGO METALLIC CORPORATION, CHICAGO, IL:
3,313,292, INT. CL. 6.
- CHICAGO PRESS, KNOXVILLE, TN:
2,410,740, CANC. INT. CL. 41.
- CHICAGO PROSTATE CANCER CENTER, L.L.C., WEST-MONT, IL:
2,411,503, CANC. INT. CL. 42.

- CHICAGOWEAR, LLC, CHICAGO, IL:
3,310,723, PUB. 7-31-2007. MULTIPLE CLASS, INT. CLS. 25 AND 35.
- CHIEF AUTOMOTIVE SYSTEMS, INC., GRAND ISLAND, NE:
2,410,471, CANC. MULTIPLE CLASS, INT. CLS. 7 AND 9.
- CHIEN COATURE LLC, RACINE, WI:
3,312,195, PUB. 4-24-2007. MULTIPLE CLASS, INT. CLS. 18 AND 35.
- CHILD SHIELD U.S.A., INC., TUCSON, AZ:
3,310,892, PUB. 7-31-2007. INT. CL. 45.
3,310,935, PUB. 7-31-2007. INT. CL. 45.
- CHILDREN'S LEGAL SERVICES, PLLC, NOVI, MI:
3,311,320, PUB. 7-31-2007. INT. CL. 36.
- CHILLICOTHE PAPER INC., CHILLICOTHE, OH:
3,313,479, INT. CL. 1.
- CHINA MANUFACTURERS ALLIANCE, LLC, MONROVIA, CA:
3,313,188, INT. CL. 12.
- CHINA MANUFACTURING & BROKERAGE, INC., PHOENIX, AZ:
3,311,107, PUB. 7-31-2007. INT. CL. 20.
3,311,108, PUB. 7-31-2007. INT. CL. 7.
3,311,109, PUB. 7-31-2007. INT. CL. 7.
- CHINA TRADE & RESEARCH, INC., GOLETA, CA:
2,409,667, CANC. INT. CL. 25.
- CHIOCCA MYERS GROUP INC., LAS VEGAS, NV:
3,310,224, PUB. 7-31-2007. INT. CL. 25.
- CHIP GANASSI RACING WITH FELIX SABATES, INC., PITTSBURGH, PA:
3,312,536, PUB. 7-31-2007. MULTIPLE CLASS, INT. CLS. 6, 12, 14, 16, 18, 20, 21, 24, 25, 26, 28 AND 41.
- CHIQUE EVENT PRODUCTIONS, INC., ORLANDO, FL:
3,314,144, INT. CL. 41.
- CHIUQUITA BRANDS L.L.C., CINCINNATI, OH:
2,090,170, REN. 9-10-07. INT. CL. 32.
- CHIUSOLO, JASON, MARSHFIELD, MA AND HUBER, TIM, BRECKENRIDGE, CO AND STAHL, JOHN, MONUMENT, CO:
3,310,917, PUB. 7-31-2007. INT. CL. 35.
- CHOCOFRESH, INC., BUFFALO, NY:
3,314,583, INT. CL. 30.
- CHOCOLADEFABRIKEN LINDT & SPRÜNGLI AG, KILCHBERG, SWITZERLAND:
3,314,473, INT. CL. 30.
- CHOCOLATERIE DE L'OPERA, FRANCE:
3,312,747, PUB. 7-31-2007. MULTIPLE CLASS, INT. CLS. 29 AND 30.
- CHOICE HOTELS INTERNATIONAL, INC., SILVER SPRING, MD:
2,096,155, REN. 9-13-07. INT. CL. 42.
- CHONDREX, INC., REDMOND, WA:
2,075,589, REN. 9-11-07. INT. CL. 1.
- CHOOSECO LLC, CHARLOTTE, VT:
3,313,431, INT. CL. 25.
- CHOPRA ENTERPRISES, LLC, CARLSBAD, CA:
3,310,685, PUB. 7-31-2007. INT. CL. 3.
- CHRIS MADDEN INC., PORT CHESTER, NY:
3,311,443, PUB. 7-31-2007. MULTIPLE CLASS, INT. CLS. 6, 16, 20, 21 AND 24.
- CHRISTENSEN, BART, SANDY, UT:
3,314,822, INT. CL. 36.
- CHRISTENSEN, CAROLYN S., MURRAY, UT AND CHRISTENSEN, D. G. JOHN, MURRAY, UT:
3,311,865, PUB. 7-31-2007. MULTIPLE CLASS, INT. CLS. 19, 37 AND 40.
- CHRISTIAN WORKSHOP MINISTRIES, INC., FARMINGDALE, NY:
3,312,328, PUB. 7-31-2007. INT. CL. 16.
- CHRISTIANE NORTHRUP, INC., YARMOUTH, ME:
3,311,001, PUB. 7-31-2007. INT. CL. 9.
- CHRISTIANET, INC., THE WOODLANDS, TX:
2,180,439, REN. 9-10-07. INT. CL. 35.
- CHRISTIANSOON SYSTEMS, INC., BLOMKEST, MN:
3,310,832, PUB. 7-31-2007. INT. CL. 7.
- CHRISTOPHER COMMUNICATIONS, INC., SAN DIEGO, CA:
3,310,713, PUB. 7-31-2007. MULTIPLE CLASS, INT. CLS. 35 AND 40.
- CHROMATIC CONCEPTS, MINNEAPOLIS, MN:
3,313,689, INT. CL. 24.
- CHUBONYC, LLC, NEW YORK, NY:
3,311,910, PUB. 7-31-2007. INT. CL. 25.
- CHUGACH ADVENTURE GUIDES, LLC, GIRDWOOD, AK:
3,311,806, PUB. 7-31-2007. INT. CL. 39.
- CHURCH & DWIGHT COMPANY, GREEN RIVER, WY:
3,314,199, INT. CL. 5.
3,314,262, INT. CL. 5.
- CHURCH & DWIGHT VIRGINIA CO., INC., COLONIAL HEIGHTS, VA:
3,311,089, PUB. 7-31-2007. INT. CL. 10.
- CHURCH GREEN PROFESSIONAL SERVICES, TAUNTON, MA:
3,311,118, PUB. 7-31-2007. INT. CL. 35.
- CHURCH GROWTH ANALYSIS AND LEARNING CENTER, CORUNNA, IN:
3,312,205, PUB. 7-31-2007. MULTIPLE CLASS, INT. CLS. 9, 35 AND 41.
- CHURCH OF THE MOVEMENT OF SPRITUAL INNER AWARENESS, THE, LOS ANGELES, CA:
1,072,888, REN. 9-11-07. INT. CL. 41.
- CHURCHILL BRAND HOLDINGS LLC, BOSTON, MA:
3,311,885, PUB. 7-31-2007. INT. CL. 36.
- CHURCHILL DOWNS INCORPORATED, LOUISVILLE, KY:
2,071,030, REN. 9-7-07. INT. CL. 41.
- CHYRON CORPORATION, MELVILLE, NY:
2,092,923, REN. 9-13-07. INT. CL. 9.
- CIDRERIES DU CALVADOS-LA FERMIERE, 75116 PARIS, FRANCE:
2,020,212, CANC. INT. CL. 33.
- CILANTRO TRADING INTERNATIONAL, LTD., KETTERING, OH:
3,310,780, PUB. 7-31-2007. INT. CL. 30.
- CIMARRON FIREARMS COMPANY, INC., FREDERICKSBURG, TX:
3,312,583, PUB. 7-31-2007. INT. CL. 13.
- CINCOM SYSTEMS, INC., CINCINNATI, OH:
3,311,262, PUB. 7-31-2007. INT. CL. 9.
- CINDY MILLIGAN, ATLANTA, GA:
3,310,849, PUB. 7-31-2007. INT. CL. 41.
- CINE-MED, INCORPORATED, WOODBURY, CT:
1,419,488, CANC. INT. CL. 41.
- CINTAS HOLDINGS LLC, MASON, OH:
3,313,598, INT. CL. 37.
- CISCO TECHNOLOGY, INC., SAN JOSE, CA:
2,094,911, REN. 9-7-07. INT. CL. 9.
- CITADEL BROADCASTING COMPANY, LAS VEGAS, NV:
2,410,433, CANC. INT. CL. 35.
- CITI TRENDS, INC., SAVANNAH, GA:
3,310,831, PUB. 7-31-2007. INT. CL. 35.
- CITICASTERS CO., SAN ANTONIO, TX:
3,311,445, PUB. 7-31-2007. INT. CL. 36.
- CITIQUEST.COM, LLC, INDIANAPOLIS, IN:
3,314,883, INT. CL. 35.
- CITIZEN HOLDINGS CO., LTD., TOKYO 188-8511, JAPAN:
3,310,857, PUB. 7-31-2007. INT. CL. 14.
- CITRUS WORLD, INC., LAKE WALES, FL:
3,314,846, INT. CL. 32.
- CITUS CO., LTD., REPUBLIC OF KOREA:
3,312,853, PUB. 7-31-2007. INT. CL. 9.
- CITY BRIGHT INTERNATIONAL LIMITED, WANCHAI, HONG KONG:
3,310,374, PUB. 7-31-2007. INT. CL. 11.
- CITY CENTER RETAIL, LLC, SAN FRANCISCO, CA:
3,311,905, PUB. 7-31-2007. MULTIPLE CLASS, INT. CLS. 36 AND 37.
- CITY OF ATHENS UTILITIES GAS DEPARTMENT, ATHENS, AL:
3,310,395, PUB. 7-31-2007. INT. CL. 41.
- CITY OF AUBURN, NEW YORK, INC., AUBURN, NY:
2,094,273, REN. 9-13-07. MULTIPLE CLASS, INT. CLS. 16, 25 AND 41.
- CITY OF EDINA, EDINA, MN:
3,312,257, PUB. 7-31-2007. INT. CL. 9.
3,312,258, PUB. 7-31-2007. INT. CL. 16.

CITY OF HOBBS, NEW MEXICO, HOBBS, NM:
3,312,614, PUB. 7-31-2007. INT. CL. 35.

CITY OF KISSIMMEE, KISSIMMEE, FL:
3,311,782, PUB. 7-31-2007. INT. CL. 35.

CJ CORP., SEOUL, REPUBLIC OF KOREA:
3,310,663, PUB. 7-31-2007. INT. CL. 38.

CKC COMMUNICATIONS, INCORPORATED, NEW YORK, NY:
3,312,477, PUB. 7-31-2007. MULTIPLE CLASS, INT. CLS. 35 AND 42.

CLABBER GIRL CORPORATION, TERRE HAUTE, IN:
3,311,181, PUB. 7-31-2007. INT. CL. 30.

CLAIR, JAMES W., WHEELING, IL, DBA LAMINATIONS UNLIMITED:
2,119,249. REN. 9-13-07. INT. CL. 40.

CLARITA INC., SAN DIEGO, CA, NDS, ENCINITAS, CA, AKA NATIONAL DECISION SYSTEMS:
1,453,745. REN. 9-13-07. INT. CL. 42.

CLARK & REID COMPANY, INC., BILLERICA, MA:
1,079,534. REN. 9-13-07. INT. CL. 39.

CLARK PEST CONTROL OF STOCKTON, INC., LODI, CA:
3,311,722, PUB. 7-31-2007. MULTIPLE CLASS, INT. CLS. 37 AND 45.

CLARK SEALS, LTD., TULSA, OK:
2,088,823. REN. 9-8-07. INT. CL. 17.

CLARK-O'NEILL, INC., FAIRVIEW, NJ:
1,419,413, CANC. INT. CL. 35.

CLARK, LISA L, TEMECULA, CA:
3,310,662, PUB. 7-31-2007. INT. CL. 28.

CLARKE SECURITY, INC., MIAMI, FL:
3,312,184, PUB. 7-31-2007. INT. CL. 45.

CLASS M CORPORATION, SANTO, TX:
3,312,038, PUB. 6-26-2007. INT. CL. 12.

CLASS ONE ORTHODONTICS, INC., LUBBOCK, TX:
3,311,010, PUB. 7-31-2007. INT. CL. 10.

CLASSIC FISHING PRODUCTS, INC., CLERMONT, FL:
3,310,398, PUB. 7-31-2007. INT. CL. 28.

CLASSY DELITES, INC., SPICEWOOD, TX:
3,312,522, PUB. 7-31-2007. MULTIPLE CLASS, INT. CLS. 29 AND 30.

CLEANING SYSTEMS, INC., DE PERE, WI:
3,311,379, PUB. 7-31-2007. INT. CL. 3.
3,311,383, PUB. 7-31-2007. INT. CL. 3.
3,311,385, PUB. 7-31-2007. INT. CL. 3.

CLEAR CHOICE GREENHOUSES, LLC., THONOTOSASSA, FL:
3,314,076, INT. CL. 31.

CLEVELAND CHAIR COMPANY, CLEVELAND, TN:
3,310,390, PUB. 7-31-2007. INT. CL. 20.

CLEVELAND VOCATIONAL INDUSTRIES, INC., SHELBY, NC:
3,310,865, PUB. 7-31-2007. INT. CL. 41.

CLICKMOTIVE, LP, MURPHY, TX:
3,313,168, INT. CL. 35.

CLICKPHARMACY.COM, INC., MIAMI, FL:
2,410,160, CANC. INT. CL. 35.

CLIFF WEIL, INC., MECHANICSVILLE, VA:
2,148,969. REN. 9-10-07. INT. CL. 9.

CLIFFS DRILLING COMPANY, HOUSTON, TX:
1,419,615, CANC. INT. CL. 42.

CLINICAL REFERENCE LABORATORY, LENEXA, KS:
2,411,376, CANC. INT. CL. 42.

CLINICAL-BASIC SKIN CARE, INC., O'FALLON, MO:
3,313,460, INT. CL. 3.

CLINIQUE LABORATORIES, LLC, NEW YORK, NY:
2,104,575. REN. 9-13-07. INT. CL. 3.

CLINSYS CLINICAL RESEARCH, INC., BERKELEY HEIGHTS, NJ:
3,311,329, PUB. 7-31-2007. MULTIPLE CLASS, INT. CLS. 16, 35 AND 42.

CLINT, BOWYER, BIRMINGHAM, MI:
3,312,560, PUB. 7-31-2007. INT. CL. 41.

CLIP-RITE INC., HAYWARD, CA:
3,314,095, INT. CL. 16.

CLIPSAL AUSTRALIA PTY LTD, AUSTRALIA:
3,312,902, PUB. 7-31-2007. INT. CL. 9.

CLOCK TOWER LAW GROUP LLC, MAYNARD, MA:
3,311,135, PUB. 7-31-2007. INT. CL. 45.

CLUBRUNNER, INC., JUPITER, FL:
3,310,351, PUB. 7-31-2007. INT. CL. 9.

CMC RESCUE, INC., SANTA BARBARA, CA:
2,148,523. REN. 9-13-07. MULTIPLE CLASS, INT. CLS. 6, 9, 22, 28 AND 35.

CMP ENTERTAINMENT MEDIA, INC., NEW YORK, NY:
3,311,810, PUB. 7-31-2007. INT. CL. 35.

CMS HOLDING COMPANY, AUSTELL, GA:
2,410,424, CANC. INT. CL. 35.

CNA FINANCIAL CORPORATION, CHICAGO, IL:
2,410,561, CANC. INT. CL. 36.

CNA NATIONAL WARRANTY CORPORATION, SCOTTS-DALE, AZ:
2,041,690. REN. 9-7-07. INT. CL. 36.

CNET NETWORKS, INC., SAN FRANCISCO, CA:
3,311,450, PUB. 7-31-2007. MULTIPLE CLASS, INT. CLS. 42 AND 45.

CNH GLOBAL N.V., RACINE, WI:
2,411,571, CANC. INT. CL. 9.
2,411,572, CANC. INT. CL. 7.

CNI COLLOIDES NATURELS INTERNATIONAL, ROUEN, FRANCE:
3,311,730, PUB. 7-31-2007. INT. CL. 1.

COALESCE CONSULTING, INC., LITTLETON, CO:
3,313,019, INT. CL. 42.

COAST REPRODUCTIVE, INC., SAN DIEGO, CA:
3,314,125, INT. CL. 5.

COAST TO COAST WATER DAMAGE & RESTORATION, INC., NORTH HOLLYWOOD, CA:
3,311,160, PUB. 7-31-2007. MULTIPLE CLASS, INT. CLS. 37 AND 40.

COASTAL CORPORATION, THE, HOUSTON, TX TO EL PASO CGP COMPANY, HOUSTON, TX:
2,021,405, CANC. INT. CL. 32.

COASTAL RESEARCH GROUP, GRANITE BAY, CA:
3,311,756, PUB. 7-31-2007. MULTIPLE CLASS, INT. CLS. 38 AND 41.

COBBLESTONE PUBLISHING, INC., PETERBOROUGH, NH:
1,419,154, CANC. INT. CL. 16.

COBLENTZ, ALICE A., ASHEVILLE, NC:
3,310,971, PUB. 7-31-2007. INT. CL. 5.

COBRA ENGINEERING CORPORATION, ANAHEIM, CA:
3,310,183, PUB. 9-29-1998. INT. CL. 12.
3,310,184, PUB. 9-29-1998. INT. CL. 12.
3,310,185, PUB. 9-29-1998. INT. CL. 12.
3,310,186, PUB. 9-29-1998. INT. CL. 12.

COCHRAN, R. KEITH, IRVING, TX:
3,314,649, INT. CL. 35.

COCOS INTERNATIONAL TRADING INC., LOS ANGELES, CA:
3,313,233, INT. CL. 18.

COCOS INTERNATIONAL TRADING, INC., LOS ANGELES, CA:
3,313,213, INT. CL. 18.

CODA MUSIC TECHNOLOGY, INC., EDEN PRAIRIE, MN:
2,410,996, CANC. INT. CL. 9.

CODING SOLUTIONS, INC., ST. CHARLES, IL:
3,312,588, PUB. 4-10-2007. MULTIPLE CLASS, INT. CLS. 35 AND 40.

COEUR A COEUR FASHION BEAUTY PRODUCTS, EDEN PRAIRIE, MN:
3,313,691, INT. CL. 3.

COFAIR PRODUCTS, INC., SKOKIE, IL:
3,314,089, INT. CL. 19.

COFFEE BY DESIGN, INC., PORTLAND, ME:
3,312,481, PUB. 7-31-2007. INT. CL. 30.

COFINLUXE, PARIS, FRANCE:
1,452,804. REN. 9-13-07. INT. CL. 3.

COFINLUXE, F-75017 PARIS, FRANCE:
3,310,322, PUB. 7-31-2007. INT. CL. 3.

COGNEX CORPORATION, NEEDHAM, MA:
1,451,957. REN. 9-13-07. INT. CL. 9.

COGNIS IP MANAGEMENT GMBH, DUESSELDORF, FED REP GERMANY, GENERAL MILLS CHEMICALS, INC., MINNEAPOLIS, MN:
1,077,191. REN. 9-9-07. INT. CL. 1.

- COHEN, JEFFREY A., MARINA DEL REY, CA:
3,311,417, PUB. 7-31-2007. INT. CL. 25.
- COINSTAR, INC., BELLEVUE, WA:
3,313,378, INT. CL. 36.
- COLAVECCHIO-GOODINE, WENDY, BANGOR, ME AND
COMMEAU, CINDY, BANGOR, ME:
3,314,712, INT. CL. 25.
- COLBY, CHONG, PHOENIX, AZ:
2,410,651, CANC. INT. CL. 5.
- COLE-PARMER INSTRUMENT COMPANY, CHICAGO, IL:
1,419,590, CANC. INT. CL. 9.
- COLE-PARMER INSTRUMENT COMPANY, VERNON
HILLS, IL:
3,311,916, PUB. 7-31-2007. INT. CL. 9.
- COLE, DEBORAH, PORT ST LUCIE, FL:
3,310,492, PUB. 7-31-2007. INT. CL. 41.
- COLEMAN COMPANY, INC., THE, WICHITA, KS:
2,088,648, REN. 9-13-07. INT. CL. 11.
- COLEMAN, CHRIS, VERONA, MO:
2,410,064, CANC. MULTIPLE CLASS, INT. CLS. 9 AND
42.
- COLLAGEN AESTHETICS, INC., PALO ALTO, CA:
2,477,133, CANC. INT. CL. 10.
- COLLECTIVE WELLBEING LLC, IRWINDALE, CA:
3,314,279, INT. CL. 3.
- COLLEGE ENTRANCE EXAMINATION BOARD, NEW
YORK, NY:
1,450,446, REN. 9-12-07. INT. CL. 9.
- COLLEGE PLACEMENT COUNCIL, INC., THE, BETHLE-
HEM, PA:
1,419,159, CANC. INT. CL. 16.
- COLLEGEVIEW PARTNERSHIP, CINCINNATI, OH TO HOB-
SONS, INC., CINCINNATI, OH:
2,020,205, CANC. INT. CL. 9.
- COLLINS INTERNATIONAL CO., LTD., FAIR LAWN, NJ:
1,419,113, CANC. INT. CL. 12.
- COLLINS, TIMOTHY G., CUMMING, GA:
2,411,113, CANC. INT. CL. 9.
- COLMENERO, MARIA GUADALUPE, DALLAS, TX:
3,310,504, PUB. 7-31-2007. INT. CL. 16.
- COLONIAL DAMES CO. LTD., COMMERCE, CA, SKAN
LABORATORIES, INC., PASADENA, CA:
644,546, REN. 9-11-07. U.S. CL. 51 (INT. CL. 3).
- COLONIAL HOLDINGS, INC., NEW KENT, VA:
3,313,619, MULTIPLE CLASS, INT. CLS. 35 AND 41.
- COLOR CONTROL, INC., TOPEKA, KS:
1,419,563, CANC. INT. CL. 42.
- COLOR IMAGE APPAREL, INC., COMMERCE, CA:
3,310,551, PUB. 7-31-2007. INT. CL. 25.
- COLOR MY WORLD, INC., KINGSTON, PA:
3,313,849, INT. CL. 16.
- COLORADO PERFORMING ARTS HALL OF FAME, INC.,
THE, DENVER, CO:
2,411,473, CANC. INT. CL. 41.
- COLORKEYS INCORPORATED, TORONTO, ONTARIO,
CANADA:
3,313,238, INT. CL. 16.
- COLORTYME, INC., PLANO, TX:
3,314,479, MULTIPLE CLASS, INT. CLS. 35, 36, 37, 39, 41,
42 AND 43.
- COLTEX B.V., NETHERLANDS:
3,312,771, PUB. 7-31-2007. MULTIPLE CLASS, INT. CLS.
14, 18 AND 25.
3,312,772, PUB. 7-31-2007. MULTIPLE CLASS, INT. CLS.
14, 18, 25 AND 35.
- COLUMBIA CASCADE COMPANY, PORTLAND, OR:
2,091,019, REN. 9-7-07. INT. CL. 20.
- COLUMBIA HOUSE COMPANY, THE, NEW YORK, NY:
2,411,077, CANC. INT. CL. 35.
- COLUMBIA INSURANCE COMPANY, OMAHA, NE:
3,311,818, PUB. 7-31-2007. INT. CL. 27.
- COLUMBUS JOINT VENTURE, MIDDELBURG, TRANS-
VAAL PROVINCE, SOUTH AFRICA:
2,020,159, CANC. INT. CL. 6.
- COM-PAC INTERNATIONAL, INC., CARBONDALE, IL:
2,097,982, REN. 9-10-07. INT. CL. 16.
- COMACK ENTERPRISES, INC., OAK BROOK, IL:
1,446,344, REN. 9-11-07. INT. CL. 16.
- COMBI CORPORATION, TAITO-KU, TOKYO, JAPAN:
3,310,241, PUB. 12-19-2006. MULTIPLE CLASS, INT. CLS.
8, 9, 10, 11 AND 21.
- COMDOC, INC., AKRON, OH:
2,409,878, CANC. MULTIPLE CLASS, INT. CLS. 35, 38, 40
AND 41.
- COME TO WIN, FORT WASHINGTON, MD:
3,314,376, INT. CL. 26.
- COMEDICA INCORPORATED, DALLAS, TX:
3,314,255, INT. CL. 10.
- COMFORT ZONE CAMP, INC., RICHMOND, VA:
3,311,969, PUB. 7-31-2007. INT. CL. 45.
- COMMERCE TEMPORARY STAFFING SERVICES LLC,
CANYON COUNTRY, CA:
3,310,990, PUB. 7-31-2007. INT. CL. 35.
- COMMERCEBANK, N.A., CORAL GABLES, FL:
3,311,587, PUB. 7-31-2007. INT. CL. 36.
3,311,592, PUB. 7-31-2007. INT. CL. 36.
- COMMON GROUND COMMUNITY H.D.F.C., INC., NEW
YORK, NY:
3,312,276, PUB. 7-31-2007. MULTIPLE CLASS, INT. CLS.
36, 41, 43, 44 AND 45.
- COMMONWEALTH BUSINESS MEDIA, EAST WINDSOR,
NJ:
3,310,450, PUB. 7-31-2007. INT. CL. 16.
- COMMONWEALTH BUSINESS MEDIA, INC., HIGH-
TSTOWN, NJ:
2,709,873, AM. INT. CL. 16.
- COMMONWEALTH BUSINESS MEDIA, INC., EAST WIND-
SOR, NJ:
3,310,452, PUB. 7-31-2007. INT. CL. 41.
- COMMONWEALTH TOY & NOVELTY CO., INC., NEW
YORK, NY:
1,419,321, CANC. INT. CL. 28.
- COMMSCOPE, INC. OF NORTH CAROLINA, HICKORY,
NC, COMMSCOPE, INC., HICKORY, NC:
2,100,216, REN. 9-7-07. INT. CL. 9.
- COMMUNAL RECOVERY, L.L.C., TUCSON, AZ:
2,410,342, CANC. INT. CL. 16.
- COMMUNICATION AND LEARNING INNOVATORS,
LTD., NEW ORLEANS, LA:
1,419,487, CANC. INT. CL. 41.
- COMMUNITIES IN SCHOOLS OF CHARLOTTE-MECK-
LENBURG, INC., CHARLOTTE, NC:
2,091,292, REN. 9-10-07. INT. CL. 42.
- COMMUNITY PARTNERS, LOS ANGELES, CA:
2,020,282, CANC. INT. CL. 42.
- COMMUNITY REINVESTMENT FUND, INC., MINNEAPO-
LIS, MN:
3,314,194, MULTIPLE CLASS, INT. CLS. 35, 36 AND 41.
- COMMUNITY UPLIFT MINISTRIES, ARVADA, CO:
3,310,826, PUB. 7-31-2007. INT. CL. 39.
- COMPEX SYSTEMHAUS GMBH, HEIDELBERG, FED REP
GERMANY:
3,311,831, PUB. 7-31-2007. INT. CL. 9.
- COMPLIANCE DESIGN, INC., BOXBOROUGH, MA:
1,419,586, CANC. INT. CL. 9.
- COMPONENT ELECTRONICS CORPORATION, LEWIS-
VILLE, TX:
3,313,618, INT. CL. 35.
- COMPOSITE FORGINGS LIMITED PARTNERSHIP, DE-
TROIT, MI:
650,380, REN. 9-7-07. U.S. CL. 14 (INT. CL. 6).
- COMPOSITION CAPITAL PARTNERS B.V., WTC NL-1077
XV AMSTERDAM, NETHERLANDS:
3,312,778, PUB. 7-31-2007. MULTIPLE CLASS, INT. CLS.
35 AND 36.
- COMPOUND BOW RIFLE SIGHT INC., BREESE, IL:
3,315,012, INT. CL. 28.
- COMPOUND PROFIT CORP., MCKINNEY, TX:
3,314,576, MULTIPLE CLASS, INT. CLS. 35 AND 36.
- COMPOUND SOLUTIONS, INC., ESCONDIDO, CA:
3,311,328, PUB. 7-31-2007. INT. CL. 5.
- COMPREHENSIVE HEALTH EDUCATION FOUNDATION,
SEATTLE, WA:
3,313,191, INT. CL. 35.
- COMPTON POINT, INC., CINCINNATI, OH:
3,313,250, INT. CL. 34.

- COMPUNETIX, INC., MONROEVILLE, PA:
2,021,257, CANC. INT. CL. 9.
- COMPUTER CURRICULUM CORPORATION, SUNNY-VALE, CA:
1,418,972, CANC. INT. CL. 9.
- COMPUTERIZED SECURITY SYSTEMS, INC., TROY, MI:
3,313,645, INT. CL. 2.
3,313,811, INT. CL. 9.
- COMPUTERS & MULTIMEDIA TECHNOLOGY, INC., PISCATAWAY, NJ:
3,314,362, INT. CL. 7.
- COMPX INTERNATIONAL INC., MAULDIN, SC:
2,090,323, REN. 9-12-07. MULTIPLE CLASS, INT. CLS. 6 AND 20.
- CONAGRA BRANDS, INC., OMAHA, NE:
2,411,014, CANC. INT. CL. 29.
- CONAGRA FOODS PACKAGED FOODS, LLC, OMAHA, NE:
3,314,430, INT. CL. 29.
3,314,453, INT. CL. 29.
- CONAGRA FOODS RDM, INC., OMAHA, NE:
2,469,904, AM. MULTIPLE CLASS, INT. CLS. 29 AND 30.
- CONAIR CORPORATION, STAMFORD, CT:
2,411,171, CANC. INT. CL. 11.
3,314,012, INT. CL. 3.
3,314,077, INT. CL. 7.
- CONCEPT LABORATORIES, INC., CHICAGO, IL:
3,314,057, INT. CL. 3.
- CONCEPTS TRADEMARK INC., GLENVIEW, IL:
3,311,318, PUB. 7-31-2007. INT. CL. 43.
- CONCISE LIVING CO., LTD., TAICHUNG HSIEN, TAIWAN:
3,311,875, PUB. 7-31-2007. INT. CL. 21.
- CONCOR TOOL AND MACHINE, INC., HAYWARD, WI:
3,311,153, PUB. 7-31-2007. INT. CL. 6.
- CONDAT, F-92400 COURBEVOIE, FRANCE:
3,312,702, PUB. 7-31-2007. MULTIPLE CLASS, INT. CLS. 16 AND 40.
- CONDENET INC., NEW YORK, NY:
3,314,004, INT. CL. 42.
3,314,005, INT. CL. 42.
- CONNECTIV COMMUNICATIONS, INC., NEWARK, DE:
2,411,013, CANC. INT. CL. 38.
- CONFERENCEDIRECT, LOS ANGELES, CA:
2,409,874, CANC. INT. CL. 35.
- CONFIRMATION PLUS, L.L.C., PHOENIX, AZ:
2,410,706, CANC. INT. CL. 35.
- CONGOLEUM CORPORATION, MERCERVILLE, NJ:
3,311,256, PUB. 7-31-2007. INT. CL. 27.
3,314,098, INT. CL. 42.
- CONGREGATION OF OUR LORD, INC., GOLETA, CA:
3,312,382, PUB. 7-31-2007. INT. CL. 45.
- CONNECTICUT ASSOCIATION OF OPTOMETRISTS, ROCKY HILL, CT:
3,314,517, INT. CL. 35.
- CONNELLY, THOMAS E, NATICK, MA:
3,314,550, INT. CL. 42.
- CONNOLLY CONSULTING ASSOCIATES, INC., WILTON, CT:
3,314,787, MULTIPLE CLASS, INT. CLS. 9 AND 35.
3,314,788, MULTIPLE CLASS, INT. CLS. 9 AND 35.
- CONSERVATION TECHNOLOGY, INC., NORTHBROOK, IL:
2,411,294, CANC. INT. CL. 39.
- CONSERVENFABRIEK "GOUDSCHELP" B.V., YERSEKE, NETHERLANDS:
1,419,354, CANC. INT. CL. 29.
- CONSOLIDATED MOULDING & MILLWORK COMPANY, LLC, KANSAS CITY, MO:
3,311,406, PUB. 7-31-2007. INT. CL. 19.
- CONSOLIDATED PROPERTY HOLDINGS, INC., LAS VEGAS, NV:
2,411,495, CANC. INT. CL. 16.
- CONSTRUCT, INC., WILSON, NC:
3,310,449, PUB. 7-31-2007. MULTIPLE CLASS, INT. CLS. 37 AND 40.
- CONSTRUCTION DATA CONTROL, INC., NORCROSS, GA:
1,419,013, CANC. INT. CL. 9.
- CONSTRUCTION RESEARCH & TECHNOLOGY, GMBH, TROSTBERG, FED REP GERMANY:
3,311,260, PUB. 7-31-2007. INT. CL. 1.
- CONTICO INTERNATIONAL, L.L.C., ST. LOUIS, MO:
2,021,146, CANC. MULTIPLE CLASS, INT. CLS. 12, 16, 20 AND 21.
- CONTINENTAL COMMERCIAL PRODUCTS, LLC, BRIDGETON, MO:
3,314,301, INT. CL. 21.
3,314,308, INT. CL. 21.
- CONTROL DATA CORPORATION, BLOOMINGTON, MN
TO POWERHOUSE TECHNOLOGIES, INC., BOZEMAN, MT:
2,020,088, CANC. INT. CL. 9.
- CONXALL CORPORATION, VILLA PARK, IL:
2,094,502, REN. 9-11-07. INT. CL. 9.
2,096,914, REN. 9-10-07. INT. CL. 9.
2,098,811, REN. 9-13-07. INT. CL. 9.
- COOK COMMUNICATIONS MINISTRIES, COLORADO SPRINGS, CO:
2,409,950, CANC. INT. CL. 16.
- COOK INCORPORATED, BLOOMINGTON, IN:
3,313,340, INT. CL. 10.
- COOKIES IN BLOOM, INC., IRVING, TX:
2,411,112, CANC. MULTIPLE CLASS, INT. CLS. 30 AND 35.
- COOKING DEVELOPMENT LIMITED, EC4YO DX LONDON, UNITED KINGDOM:
3,312,069, PUB. 7-31-2007. INT. CL. 43.
- COOL-TEKWARE, INC., LOS ANGELES, CA:
3,313,976, INT. CL. 25.
- COOLCALL.COM CORPORATION, FAIRFIELD, IA:
2,411,215, CANC. INT. CL. 38.
- COOLIDGE COMPANY, INC., THE, NEW YORK, NY:
1,419,417, CANC. MULTIPLE CLASS, INT. CLS. 35 AND 36.
- COOPER TECHNOLOGIES COMPANY, HOUSTON, TX:
3,313,747, INT. CL. 6.
3,313,749, INT. CL. 6.
3,314,300, INT. CL. 6.
- COOPERLABS LIMITED, VENTURA, CA, CABOT LABORATORIES, INC., CENTRAL ISLIP, NY:
2,086,145, REN. 9-7-07. INT. CL. 3.
- COOPERSURGICAL, INC., TRUMBULL, CT:
2,036,967, REN. 9-10-07. INT. CL. 10.
- COORDINATED STRATEGIC ALLIANCES, INC., CHESTER, NY:
2,085,406, REN. 9-7-07. INT. CL. 7.
- COORS GLOBAL PROPERTIES, INC., GOLDEN, CO:
2,091,530, REN. 9-7-07. INT. CL. 16.
- COORS GLOBAL PROPERTIES, INC., LAKEWOOD, CO:
2,409,991, CANC. INT. CL. 32.
- COPAN SYSTEMS, INC., LONGMONT, CO:
3,314,309, INT. CL. 9.
- COPELAND, AL C., METAIRIE, LA:
3,310,835, PUB. 7-31-2007. INT. CL. 43.
- COPTERVISION, LLC, VAN NUYS, CA AND PATRIOT ANTENNA SYSTEMS, INC., ALBION, MI:
3,311,466, PUB. 7-31-2007. INT. CL. 41.
- COPYGUARD ELECTRONIC, GMBH, D-65366 GEISENHEIM 2, FED REP GERMANY:
2,020,183, CANC. INT. CL. 9.
- COPYRIGHT CLEARANCE CENTER, INC., DANVERS, MA:
3,314,545, INT. CL. 35.
- CORAL HEAD, INC., GARDENA, CA:
3,314,053, INT. CL. 3.
- CORD BLOOD REGISTRY, INC., SAN BRUNO, CA:
2,411,502, CANC. INT. CL. 42.
- CORE KNOWLEDGE FOUNDATION, CHARLOTTESVILLE, VA:
2,108,659, REN. 9-7-07. MULTIPLE CLASS, INT. CLS. 16 AND 41.
2,108,659, CANC. INT. CL. 25.
- CORE LABORATORIES GLOBAL N.V., WILLEMSTAD, CURACAO, NETHERLD ANTILLES:
2,410,073, CANC. INT. CL. 42.

- COREANA COSMETICS CO., LTD., CHUNGCHEONGNAM-DO, REPUBLIC OF KOREA:
2,410,132, CANC. INT. CL. 3.
- CORN FLOUR PRODUCERS, LLC, VINCENNES, IN:
3,311,505, PUB. 7-31-2007. INT. CL. 30.
- CORN, MARCY, SANTEE, CA:
3,314,671, MULTIPLE CLASS, INT. CLS. 25 AND 28.
- CORNBELLY'S, INC., SPANISH FORK, UT:
3,314,409, INT. CL. 41.
- CORNELL, F. MICHAEL, SARASOTA, FL:
2,409,981, CANC. INT. CL. 42.
- CORNER CAPITAL, L.L.C., PHOENIX, AZ, DBA STICK-
LERS:
3,313,965, INT. CL. 43.
- CORPORATE RESPONSIBILITY SYSTEM TECHNOLOGIES
LTD., TORONTO, ONTARIO M5H 1P9, CANADA:
3,310,227, PUB. 2-20-2007. MULTIPLE CLASS, INT. CLS. 9
AND 45.
- CORPORATEK INC., WESTMOUNT, CANADA:
3,310,480, PUB. 7-31-2007. INT. CL. 9.
- CORUS HOME REALTY, MCLEAN, VA:
3,310,397, PUB. 7-31-2007. INT. CL. 36.
- COSMETICS LIMITED, NASSAU, BAHAMAS:
3,313,379, MULTIPLE CLASS, INT. CLS. 3 AND 41.
- COSMETIQUE SANS SOUCIS GMBH, D-76532 BADEN-
BADEN, FED REP GERMANY:
2,020,873, CANC. INT. CL. 3.
- COSMOS CORPORATION, WENTZVILLE, MO:
3,312,087, PUB. 7-31-2007. INT. CL. 3.
3,312,088, PUB. 7-31-2007. INT. CL. 3.
- COSTA NURSERY FARMS LLC, GOULDS, FL:
3,314,750, INT. CL. 31.
- COTTMAN TRANSMISSION SYSTEMS, INC., FT. WA-
SHINGTON, PA:
2,020,133, CANC. INT. CL. 37.
- COUNCIL OF LOGISTICS MANAGEMENT D/B/A COUN-
CIL OF SUPPLY CHAIN MANAGEMENT PROFES-
SIONALS, OAK BROOK, IL:
3,312,217, PUB. 7-31-2007. MULTIPLE CLASS, INT. CLS.
16 AND 41.
- COUNTRY MAID, INC., WEST BEND, IA:
3,311,415, PUB. 7-31-2007. INT. CL. 30.
- COUNTRYSIDE FRAGRANCES, INC., SEATTLE, WA:
1,419,378, CANC. INT. CL. 30.
- COURISTAN, INC., NEW YORK, NY:
1,454,418, REN. 9-10-07. INT. CL. 27.
- COURTNEY COCHRAN, SAN FRANCISCO, CA:
3,311,813, PUB. 7-31-2007. MULTIPLE CLASS, INT. CLS.
35, 41 AND 43.
- COUTTS, LOUISE, ST. KILDA, VICTORIA, 3182, AUSTRA-
LIA:
2,409,692, CANC. INT. CL. 3.
- COVE AT YARMOUTH RESORT HOTEL OWNERS ASSO-
CIATION, INC., WEST YARMOUTH, MA:
2,090,698, REN. 9-10-07. INT. CL. 36.
- COVER-POOLS INCORPORATED, SALT LAKE CITY, UT:
2,090,706, REN. 9-13-07. INT. CL. 19.
- COX, MARVIN K., DUNCAN, OK:
3,312,459, PUB. 7-10-2007. INT. CL. 43.
- CP KELCO U.S., INC., ATLANTA, GA:
3,312,668, PUB. 7-31-2007. INT. CL. 1.
- CRABTREE & EVELYN, LTD., WALTHAM, MA:
2,411,379, CANC. INT. CL. 35.
- CRACKER BARREL OLD COUNTRY STORE, INC., LEBAN-
NON, TN TO CBOCS GENERAL PARTNERSHIP, BELLE-
VILLE, MI:
2,020,561, CANC. INT. CL. 42.
- CRACKER BARREL OLD COUNTRY STORE, INC., LEBAN-
NON, TN TO CBOCS GENRAL PARTNERSHIP, BELLE-
VILLE, MI:
2,020,562, CANC. INT. CL. 42.
- CRAIG W. PINNEY, SOLANA BEACH, CA:
3,311,071, PUB. 7-31-2007. INT. CL. 38.
3,311,536, PUB. 7-31-2007. INT. CL. 38.
- CRAIG, JOHN DAVID, INDIANAPOLIS, IN:
2,020,247, CANC. INT. CL. 42.
- CRANEVEYOR CORP., SOUTH EL MONTE, CA:
1,071,777, REN. 9-13-07. INT. CL. 7.
- CRANWELL, JAMES C, SARASOTA, FL:
3,311,670, PUB. 7-31-2007. INT. CL. 15.
- CRAZY ACE, INC., PHOENIX, AZ:
3,313,574, INT. CL. 10.
- CRAZY BOB'S, INC., WAYNE, NJ:
1,419,380, CANC. INT. CL. 30.
- CRE, L.L.C., CLIFTON, NJ:
3,311,543, PUB. 7-31-2007. INT. CL. 35.
- CREATIONS NELSON, FRANCE:
3,312,875, PUB. 7-31-2007. MULTIPLE CLASS, INT. CLS.
3, 18, 24 AND 25.
- CREATIVE CHARACTERS, INC., MIAMI, FL:
2,410,105, CANC. INT. CL. 14.
- CREATIVE COTERIE, INC., NEWPORT BEACH, CA:
3,314,856, INT. CL. 14.
- CREATIVE DINING SERVICES, INC., ZEELAND, MI:
3,311,305, PUB. 7-31-2007. INT. CL. 43.
- CREATIVE RESOURCES ONLINE, WOBURN, MA:
3,310,765, PUB. 7-31-2007. MULTIPLE CLASS, INT. CLS.
16 AND 18.
- CREATIVE VENTURES, INC., TIGARD, OR:
3,310,330, PUB. 7-31-2007. INT. CL. 9.
3,311,690, PUB. 7-31-2007. MULTIPLE CLASS, INT. CLS.
16 AND 41.
- CREME PROPERTIES, L.P., ATLANTA, GA:
2,410,919, CANC. MULTIPLE CLASS, INT. CLS. 41 AND
42.
- CRENSHAW WHITLEY & ASSOCIATES, L.L.C., GEORGE-
TOWN, TX:
3,314,483, INT. CL. 36.
- CRESCENT BAY SOFTWARE, CULVER CITY, CA:
3,310,933, PUB. 7-31-2007. INT. CL. 9.
- CRESCIT, L.P., NORTH RICHLAND HILLS, TX:
3,312,228, PUB. 7-31-2007. INT. CL. 6.
- CRIME SURVIVORS, INC., IRVINE, CA:
3,310,372, PUB. 7-31-2007. MULTIPLE CLASS, INT. CLS.
35 AND 41.
- CRITICAL PATH STRATEGIES, INC., BOERNE, TX:
2,092,644, REN. 9-9-07. INT. CL. 41.
- CRN INTERNATIONAL, INC., HAMDEN, CT:
3,313,057, INT. CL. 35.
- CROPMATE COMPANY, PEKIN, IL:
2,411,242, CANC. INT. CL. 5.
- CROSS COUNTRY HOME SERVICES, INC., FT. LAUDER-
DALE, FL:
3,313,205, INT. CL. 36.
3,313,206, INT. CL. 36.
3,313,207, INT. CL. 36.
- CROSS SOUND CHURCH, BAINBRIDGE IS, WA:
3,310,680, PUB. 7-31-2007. INT. CL. 30.
- CROSSWORKS, INC., HOPKINS, MN:
2,410,414, CANC. INT. CL. 42.
- CROWN CORK & SEAL TECHNOLOGIES CORPORATION,
ALSIP, IL:
2,409,795, CANC. INT. CL. 6.
2,409,798, CANC. INT. CL. 21.
2,409,806, CANC. INT. CL. 42.
2,409,807, CANC. INT. CL. 8.
- CROWN EQUIPMENT CORPORATION, NEW BREMEN,
OH:
3,313,462, INT. CL. 9.
- CROWN TRAVEL SERVICE, INC., BLOOMFIELD, NJ:
3,314,464, INT. CL. 39.
3,314,476, INT. CL. 43.
- CRU TRADING COMPANY, THE WOODLANDS, TX:
3,310,774, PUB. 7-31-2007. INT. CL. 36.
- CRUCIAN SAUCES, LLC, CHRISTIANSTED, US VIRGIN
ISLANDS:
3,310,431, PUB. 7-31-2007. INT. CL. 30.
- CRUISING WORLD PUBLICATIONS, INC., WINTER PARK,
FL, NORTH AMERICAN PUBLISHING COMPANY, PHI-
LADELPHIA, PA:
1,447,406, REN. 9-13-07. INT. CL. 16.
- CRYOCATH TECHNOLOGIES INC., CANADA:
3,313,111, INT. CL. 10.
- CRYSTAL GLASS CANADA LTD., EDMONTON, ALBERTA,
CANADA:
3,313,870, INT. CL. 7.

CSS GLOBAL INC., GRASS VALLEY, CA:
3,313,729, INT. CL. 17.

CTS, ELKHART, IN:
2,410,515, CANC. INT. CL. 9.

CTV INC., SCARBOROUGH, ONTARIO, CANADA:
3,312,183, PUB. 7-31-2007. INT. CL. 41.

CU SERVICE CENTERS NETWORK, INC., SAN DIMAS, CA:
2,091,234, REN. 9-10-07. INT. CL. 36.

CUBI VALENTINA, ITALY:
3,312,962, PUB. 7-31-2007. INT. CL. 33.

CUCINELLO, PAUL, NEW YORK, NY:
2,410,470, CANC. INT. CL. 41.

CULPEPPER SALES, LLC, ADDISON, TX:
3,312,326, PUB. 7-31-2007. INT. CL. 32.

CUMBERLAND FARMS, INC., CANTON, MA:
2,411,356, CANC. INT. CL. 30.

CUMMINGS, BARBARA ANNE, EUTAWVILLE, SC:
2,410,717, CANC. INT. CL. 42.

CUMMINGS, WILLIAM DENNIS, WHITE CITY, OR:
3,314,642, INT. CL. 9.

CUNNINGHAM, CATHERINE, NEWPORT COAST, CA:
3,314,389, INT. CL. 41.

CUPERTINO NATIONAL BANK, PALO ALTO, CA:
2,090,702, REN. 9-12-07. INT. CL. 36.

CURECHIEF FOUNDATION, INC., CHESHIRE, CT:
3,313,643, INT. CL. 24.

CURIOSITY DEVELOPMENT, INC., COCKEYSVILLE, MD:
2,410,949, CANC. MULTIPLE CLASS, INT. CLS. 16 AND 28.

CURRIE TECHNOLOGIES, INC., CHATSWORTH, CA:
3,313,225, INT. CL. 12.

CURRY, ALISON DAVIS, MILFORD, NJ:
3,313,919, INT. CL. 35.

CURTCO ROBB MEDIA, L.L.C., MALIBU, CA:
3,313,395, INT. CL. 16.

CURTIS PACKAGING CORPORATION, SANDY HOOK, CT:
3,313,861, MULTIPLE CLASS, INT. CLS. 40 AND 42.

CURTIS, MURPHY & JEFFREYS, LLP, QUEENSBURY, NY:
2,020,223, CANC. INT. CL. 35.

CUSTOM BUILDING PRODUCTS, INC., SEAL BEACH, CA:
2,559,503, CANC. INT. CL. 1.

CUSTOM GAME DESIGN, INC., PLANO, TX:
3,314,871, INT. CL. 9.

CUSTOM PERSPECTIVE DESIGNS, MONTROSE, CA:
3,311,563, PUB. 7-31-2007. INT. CL. 42.

CUTICEUTICALS, INC., ST. PAUL, MN:
3,313,763, INT. CL. 5.

CVS H. C., INC., RYE, NY:
1,419,485, CANC. MULTIPLE CLASS, INT. CLS. 40 AND 42.

CVS PHARMACY, INC., WOONSOCKET, RI:
3,313,617, MULTIPLE CLASS, INT. CLS. 35, 36, 41 AND 44.

CYBEAR, INC., FT. LAUDERDALE, FL:
3,310,203, PUB. 7-31-2007. INT. CL. 42.

CYBERAGENZ, INC., SAN FRANCISCO, CA:
2,021,272, CANC. MULTIPLE CLASS, INT. CLS. 9 AND 42.

CYBERWIZE.COM, INC., SARASOTA, FL:
3,311,524, PUB. 7-31-2007. INT. CL. 35.

CYCLES INTERNATIONAL, INC.:
1,419,115, CANC. INT. CL. 12.

CYPRESS PHARMACEUTICAL, INC., MADISON, MS:
2,101,153, REN. 9-7-07. INT. CL. 5.

CYRACOM INTERNATIONAL INC., TUCSON, AZ:
3,311,425, PUB. 7-31-2007. MULTIPLE CLASS, INT. CLS. 9 AND 41.

CYTEC TECHNOLOGY CORP., WILMINGTON, DE:
1,453,767, REN. 9-11-07. INT. CL. 1.
1,453,768, REN. 9-11-07. INT. CL. 1.

CYTODYNE LLC, FARMINGDALE, NY:
3,311,192, PUB. 7-3-2007. INT. CL. 5.

CYTOSPORT, INC., BENICIA, CA:
3,311,489, PUB. 7-31-2007. MULTIPLE CLASS, INT. CLS. 5 AND 30.
3,311,490, PUB. 7-31-2007. MULTIPLE CLASS, INT. CLS. 5 AND 30.

C2 GAMING, LLC, LAS VEGAS, NV:
3,156,557, CANC. INT. CL. 9.

C21 TM LLC, MISSION VIEJO, CA:
2,409,744, CANC. INT. CL. 9.

D & M HOLDINGS US, INC., PINE BROOK, NJ:
3,311,802, PUB. 7-31-2007. INT. CL. 9.

D.B. GROGAN ASSOCIATES, LLC, GLOUCESTER, MA:
3,310,916, PUB. 7-31-2007. INT. CL. 40.
3,310,918, PUB. 7-31-2007. INT. CL. 40.

D.B.M. IMPORT, EXPORT, INC., NORCROSS, GA:
3,310,631, PUB. 7-31-2007. INT. CL. 19.

D.D.M. CONSULTING & TRADING LTD., WINDSOR BERKSIRE, GREAT BRITAIN:
3,311,864, PUB. 7-31-2007. INT. CL. 6.

D-M-E COMPANY, MADISON HEIGHTS, MI:
1,451,556, REN. 9-10-07. INT. CL. 9.
1,466,028, REN. 9-10-07. INT. CL. 9.
1,466,029, REN. 9-10-07. INT. CL. 9.
2,080,550, REN. 9-10-07. INT. CL. 9.

D'ABREAU, JEAN-LUC, MIRA LOMA, CA:
3,310,601, PUB. 7-31-2007. INT. CL. 9.

D'ALESSIO, THOMAS D., GRAFTON, WI:
3,312,636, PUB. 7-31-2007. INT. CL. 41.

DA BOMB PRODUCTS, INC., GLENDALE, AZ:
3,313,078, INT. CL. 34.

DAHLINGER, ERIC F., HAWTHORN WOODS, IL:
3,312,240, PUB. 7-31-2007. INT. CL. 44.
3,312,241, PUB. 7-31-2007. INT. CL. 44.

DAIGNEAU, ROBERT, FRAMINGHAM, MA:
2,410,467, CANC. INT. CL. 42.

DAILEY, ANTRONE, MONTCLAIR, NJ:
3,310,977, PUB. 7-31-2007. INT. CL. 16.

DAILY DRYER CORPORATION, TELFORD, PA:
1,419,210, CANC. INT. CL. 20.

DAIMLERCHRYSLER AG, 70567 STUTTGART, FED REP GERMANY:
3,310,243, PUB. 7-31-2007. INT. CL. 12.

DAIMLERCHRYSLER AG, STUTTGART, FED REP GERMANY:
3,311,773, PUB. 10-24-2006. MULTIPLE CLASS, INT. CLS. 12 AND 40.

DAIMLERCHRYSLER AG, D-70567 STUTTGART, FED REP GERMANY:
3,312,399, PUB. 7-31-2007. MULTIPLE CLASS, INT. CLS. 12 AND 14.

DAIMLERCHRYSLER CORPORATION,, AUBURN HILLS, MI:
2,410,625, CANC. INT. CL. 12.

DAISHENG (M) SDN BHD, 50000 KUALA LUMPUR, MALAYSIA:
2,410,928, CANC. INT. CL. 28.

DAISHOWA SEIKI KABUSHIKI KAISHA, OSAKA, JAPAN, DBA BIG DAISHOWA SEIKI CO LTD:
3,314,998, INT. CL. 7.

DAIWA SEIKO, INC., HIGASHIKURUME-CITY, TOKYO, JAPAN:
1,458,528, REN. 9-10-07. INT. CL. 28.

DAIWA SEIKO, INC., TOKYO, JAPAN:
3,314,533, INT. CL. 28.

DAL PIAZ, CHRISTOPHER, NEW YORK, NY:
3,313,371, INT. CL. 25.

DAL PIAZ, CHRISTOPHER C., NEW YORK, NY:
3,313,351, INT. CL. 25.

DAL-CRAFT, INC., TUCKER, GA:
2,410,859, CANC. INT. CL. 28.

DAL-SOON, CHOI, CASTOR BAY, AUCKLAND, NEW ZEALAND:
3,310,356, PUB. 7-31-2007. INT. CL. 35.

DALIAN HUAFENG FURNITURE CO., LTD, DALIAN, CHINA:
3,313,730, INT. CL. 20.

DALLAB SDN BHD (619727-A), 11900 BAYAN LEPAS, PENANG, MALAYSIA:
3,313,080, INT. CL. 42.

DALY, DIXIE, LOVELAND, CO:
3,310,810, PUB. 7-31-2007. INT. CL. 35.

- DAN CO., LTD., OSAKA 547-0015, JAPAN:
3,312,779, PUB. 7-31-2007. INT. CL. 25.
3,312,802, PUB. 7-31-2007. INT. CL. 25.
- DAN DIBBLE, MD, VERADALE, WA:
3,310,614, PUB. 7-31-2007. INT. CL. 44.
- DANA CORPORATION, TOLEDO, OH:
3,311,635, PUB. 7-31-2007. INT. CL. 12.
- DANA INNOVATIONS, SAN CLEMENTE, CA:
3,314,771, INT. CL. 9.
3,314,841, INT. CL. 9.
- DANBY PRODUCTS LIMITED, GUELPH, CANADA:
3,312,412, PUB. 7-31-2007. MULTIPLE CLASS, INT. CLS. 7 AND 11.
- DANGAARD, COLIN, MALIBU, CA, DBA THE AUSTRALIAN STOCK SADDLE CO.:
1,467,344, REN. 9-7-07. INT. CL. 18.
- DANGLE PENS, INC., ESCONDIDO, CA:
3,311,407, PUB. 7-31-2007. INT. CL. 16.
- DANIELI & C. OFFICINE MECCANICHE SPA, ITALY:
3,312,839, PUB. 7-31-2007. MULTIPLE CLASS, INT. CLS. 7, 9 AND 11.
3,312,840, PUB. 7-31-2007. MULTIPLE CLASS, INT. CLS. 7, 9 AND 11.
- DANIELS PHARMACEUTICALS, INC., ST. PETERSBURG, FL:
1,418,917, CANC. INT. CL. 5.
- DANIWEB LLC, SEARINGTOWN, NY:
3,310,950, PUB. 7-31-2007. MULTIPLE CLASS, INT. CLS. 35, 38, 41, 42 AND 45.
- DANNMARIE, LLC, LARCHMONT, NY:
3,313,952, INT. CL. 5.
- DANNON COMPANY, INC., THE, TARRYTOWN, NY:
2,410,493, CANC. INT. CL. 29.
- DANNON COMPANY, INC., THE, TARRYTOWN, NY:
2,409,708, CANC. INT. CL. 35.
2,410,492, CANC. INT. CL. 29.
2,410,494, CANC. INT. CL. 29.
- DANNY & CLYDE'S FOOD STORE INC., GRETN, LA:
3,313,682, INT. CL. 43.
- DANZER FURNIERWERKE GMBH, 72760 REUTLINGEN, FED REP GERMANY:
3,312,737, PUB. 7-31-2007. INT. CL. 19.
- DAO SUL - SOCIEDADE VITIVINICOLA, S.A., PORTUGAL:
3,312,773, PUB. 7-31-2007. INT. CL. 33.
- DAOEN CORPORATION, BOISE, ID:
3,314,635, INT. CL. 16.
- DAP BRANDS COMPANY, MEDINA, OH:
3,314,166, INT. CL. 16.
- DARCOR LIMITED, TORONTO, ONTARIO, CANADA:
3,310,251, PUB. 7-24-2007. MULTIPLE CLASS, INT. CLS. 6 AND 20.
- DARDEN CONCEPTS, INC., ORLANDO, FL:
3,313,904, INT. CL. 31.
- DARLING INTERNATIONAL INC., IRVING, TX, DARLING & COMPANY, CHICAGO, IL:
118,391, REN. 9-7-07. U.S. CL. 46 (INT. CL. 31).
- DART CHART SYSTEMS, MILWAUKEE, WI:
3,313,876, INT. CL. 35.
- DATA BECKER CORPORATION, NEEDHAM, MA:
2,411,559, CANC. INT. CL. 9.
- DATA CONNECTION CORPORATION, RESTON, VA:
2,410,051, CANC. INT. CL. 9.
- DATA WEST CORPORATION, DURANGO, CO:
3,311,384, PUB. 7-31-2007. INT. CL. 9.
- DATACOLOR HOLDING AG., LUZERN, SWITZERLAND:
3,313,532, INT. CL. 9.
- DATAMARS SA, BEDANO-LUGANO, SWITZERLAND:
3,312,764, PUB. 7-31-2007. INT. CL. 9.
- DATAQUICK INFORMATION SYSTEMS, INC., SAN DIEGO, CA:
2,095,262, REN. 9-9-07. INT. CL. 42.
- DATATRACE DNA PTY LIMITED, AUSTRALIA:
3,312,714, PUB. 7-31-2007. INT. CL. 9.
- DATAWATCH CORPORATION, CHELMSFORD, MA:
3,310,903, PUB. 7-31-2007. INT. CL. 9.
- DATAWEST GROUP, THE, SANTA CRUZ, CA:
2,409,951, CANC. MULTIPLE CLASS, INT. CLS. 35 AND 41.
- DAUBENSPECK, LLOYD ALAN, BELLE, WV:
3,311,442, PUB. 7-31-2007. INT. CL. 41.
- DAUGHERTY, P. NORMAN, FRISCO, TX AND DAUGHERTY, TONYA, FRISCO, TX:
3,312,498, PUB. 7-31-2007. INT. CL. 40.
- DAVE'S SEPTIC SERVICE, INC., MANCHESTER, NH:
3,312,616, PUB. 7-31-2007. MULTIPLE CLASS, INT. CLS. 37 AND 44.
- DAVID HARSH, EDMONDS, WA:
3,314,798, MULTIPLE CLASS, INT. CLS. 9 AND 41.
- DAVID J. MARES, SPRING BRANCH, TX:
3,311,682, PUB. 7-31-2007. INT. CL. 25.
- DAVID LEAN FILMS LIMITED, STOKE ON TRENT, UNITED KINGDOM:
3,314,907, INT. CL. 41.
- DAVID N. DEUTSCH & COMPANY LLC, NEW YORK, NY:
3,310,469, PUB. 7-31-2007. INT. CL. 35.
- DAVIS INOTEK INSTRUMENTS, LLC, BALTIMORE, MD, INOTEK CORPORATION, DALLAS, TX:
1,444,907, REN. 9-13-07. MULTIPLE CLASS, INT. CLS. 9 AND 42.
- DAVIS, BRAD, GILBERT, AZ:
3,314,953, INT. CL. 37.
- DAVIS, BRANT STEWART, ACAMPO, CA:
3,313,148, INT. CL. 33.
- DAWN FISHER, PORTLAND, OR:
3,311,346, PUB. 7-31-2007. INT. CL. 3.
- DAY & ZIMMERMANN, INC., RADNOR, PA TO AIRMATE LLC, PHILADELPHIA, PA:
2,020,536, CANC. INT. CL. 35.
- DAY-BY-DAY GOURMET, LLC, EDMONDS, WA:
3,312,352, PUB. 7-31-2007. MULTIPLE CLASS, INT. CLS. 29, 35 AND 43.
- DAYSRING CARDS, INC., SILOAM SPRINGS, AR, WARNER PRESS, INC., ANDERSON, IN:
1,072,231, REN. 9-9-07. INT. CL. 16.
- DAYTON HUDSON CORPORATION, MINNEAPOLIS, MN TO THE MAY DEPARTMENT STORES COMPANY, ST. LOUIS, MO:
2,021,093, CANC. INT. CL. 25.
- DBC ASSOCIATES, LLC, ATLANTA, GA:
3,313,842, MULTIPLE CLASS, INT. CLS. 1 AND 3.
- DBD PRODUCTIONS, INC., CHAPPAQUA, NY:
2,410,787, CANC. INT. CL. 25.
- DBS BANK LTD., SINGAPORE, SINGAPORE:
2,072,961, REN. 9-13-07. INT. CL. 36.
- DBSI, INC., MERIDIAN, ID:
3,310,993, PUB. 7-31-2007. MULTIPLE CLASS, INT. CLS. 36 AND 37.
- DC BRANDS INTERNATIONAL, WHEAT RIDGE, CO:
3,314,860, INT. CL. 32.
- DC COMICS, NEW YORK, NY, DC COMICS INC., NEW YORK, NY:
1,076,407, REN. 9-10-07. INT. CL. 16.
- DC COMICS, NEW YORK, NY:
2,157,292, REN. 9-13-07. INT. CL. 28.
3,313,612, INT. CL. 28.
- DCI CHEESE COMPANY, INC., RICHFIELD, WI:
1,410,801, REN. 9-13-07. INT. CL. 29.
- DCM INDUSTRIES INC., DAYTON, OH:
3,312,305, PUB. 7-31-2007. INT. CL. 4.
- DE DIETRICH, LES BAINS, FRANCE:
1,451,761, REN. 9-13-07. MULTIPLE CLASS, INT. CLS. 6, 7 AND 11.
- DE GRISOGONO S.A., SWITZERLAND:
3,312,792, PUB. 7-31-2007. INT. CL. 14.
3,312,793, PUB. 7-31-2007. INT. CL. 14.
- DE JONGH, WALTER ANTHONY, CURACAO, NETHERLD ANTILLES:
2,410,014, CANC. MULTIPLE CLASS, INT. CLS. 25 AND 28.
- DE NOVO ENTERPRISES, L.L.C., HILLSBOROUGH, NJ:
3,313,294, MULTIPLE CLASS, INT. CLS. 38 AND 41.
- DE VEER, MARLIES, SAN JOSE, CA AND BEASLEY, AMY, SAN JOSE, CA:
3,311,255, PUB. 7-31-2007. INT. CL. 41.

DEBIOPHARM S.A., CH-1000 LAUSANNE 9, SWITZERLAND:
3,310,222, PUB. 7-31-2007. MULTIPLE CLASS, INT. CLS. 42 AND 45.

DECISION NEWS MEDIA SAS, FRANCE:
3,312,850, PUB. 7-31-2007. MULTIPLE CLASS, INT. CLS. 9, 35, 38, 41 AND 42.

DECKEL MAHO GMBH, 87459 PFRONTEN, FED REP GERMANY:
2,092,483. REN. 9-10-07. INT. CL. 7.

DEDHAM INSTITUTION FOR SAVINGS, DEDHAM, MA:
3,314,884, INT. CL. 36.

DEDICATED DEVICES, INC., BOISE, ID:
3,314,421, INT. CL. 9.

DEEGAN, BRIAN, TEMECULA, CA:
3,314,543, INT. CL. 28.

DEER KING COMPANY, LLC, CANTERBURY, NH:
3,313,734, INT. CL. 20.

DEETER, THOMAS J., LITTLE ROCK, AR:
3,311,296, PUB. 7-31-2007. INT. CL. 41.

DEFENSE HOLDINGS, INC., MANASSAS, VA:
3,313,679, INT. CL. 9.
3,313,680, INT. CL. 9.
3,313,681, INT. CL. 9.

DEFERIET PAPER COMPANY, DEFERIET, NY:
2,411,147, CANC. INT. CL. 16.

DEFINED FITNESS TRAINING, LLC, DENVER, CO:
3,311,240, PUB. 7-31-2007. INT. CL. 41.

DEFT INCORPORATED, IRVINE, CA:
2,097,303. REN. 9-13-07. INT. CL. 21.

DEHAVEN, DULCE BURGOS, SAN DIEGO, CA:
3,312,286, PUB. 7-31-2007. INT. CL. 18.

DEI HEADQUARTERS, INC., VISTA, CA:
2,120,755. REN. 9-10-07. INT. CL. 9.

DEISTER ELECTRONIC GMBH, BARSINGHAUSEN, FED REP GERMANY:
3,311,475, PUB. 7-31-2007. INT. CL. 9.

DEL PACIFICOS GROUP, INC., THE, SANTA BARBARA, CA:
2,411,373, CANC. INT. CL. 5.

DELAWARE CAPITAL FORMATION, INC., WILMINGTON, DE:
3,314,419, INT. CL. 35.

DELGALLO, FRANK, SCHENECTADY, NY:
3,310,956, PUB. 7-31-2007. INT. CL. 37.

DELKA LTD., WESTON, CT:
2,409,828, CANC. INT. CL. 41.

DELMARVA POWER & LIGHT COMPANY, WILMINGTON, DE:
1,461,411. REN. 9-9-07. INT. CL. 42.

DELMONICO, SANNA, NAPA, CA:
3,312,239, PUB. 7-31-2007. MULTIPLE CLASS, INT. CLS. 9 AND 16.

DELSENER/SLATER ENTERPRISES, LTD., HOUSTON, TX:
3,313,823, MULTIPLE CLASS, INT. CLS. 35 AND 41.

DELUXE HOLDING AG, SWITZERLAND:
3,312,978, PUB. 7-31-2007. INT. CL. 25.

DEMAND MEDIA, INC., SANTA MONICA, CA:
2,447,530, CANC. INT. CL. 42.

DEMAR, MATT, AMITYVILLE, NY:
3,314,734, INT. CL. 43.

DEMCO, INC., MADISON, WI:
3,314,165, INT. CL. 20.

DEMETRIOS MALITAS, PHILADELPHIA, PA, DBA DM CO.:
1,078,062. REN. 9-8-07. INT. CL. 35.

DEMORDAUNT, MELISSA MAE, DRAPER, UT:
3,310,699, PUB. 7-31-2007. INT. CL. 25.

DEN DI DE NORA PAOLO, I-40056 BOLOGNA, ITALY:
3,312,909, PUB. 7-31-2007. INT. CL. 5.

DEN-MAT CORPORATION, SANTA MARIA, CA:
3,311,147, PUB. 7-31-2007. INT. CL. 40.

DENALI BIOTECHNOLOGIES, LLC, SOLDOTNA, AK:
3,311,614, PUB. 7-31-2007. INT. CL. 5.

DENNY HECKER'S AUTOMOTIVE GROUP, INC., MINNEAPOLIS, MN:
3,170,219, CANC. IIRN. RESTORED TO S.N. 76-642,805.

DENTAL DIRECTIONS INC., TULSA, OK:
3,314,105, INT. CL. 41.

DENTAURUM J.P. WINKELSTROETER KG, FED REP GERMANY:
3,312,963, PUB. 7-31-2007. INT. CL. 10.
3,312,964, PUB. 7-31-2007. INT. CL. 10.

DENTON COUNTY ELECTRIC COOPERATIVE, INC., CORINTH, TX:
2,478,311, CANC. MULTIPLE CLASS, INT. CLS. 9, 32 AND 38.
2,478,312, CANC. MULTIPLE CLASS, INT. CLS. 9, 32 AND 38.

DEPARTMENT OF DEFENSE, WASHINGTON, DC:
3,314,090, INT. CL. 16.

DEPARTMENT OF DEFENSE, UNITED STATES NAVY, PROGRAM EXECUTIVE OFFICE INTEGRATED WARFARE SYSTEMS, WASHINGTON NAVY YARD, DC:
3,310,332, PUB. 7-31-2007. MULTIPLE CLASS, INT. CLS. 41 AND 42.

DERIVION CORPORATION, ALPHARETTA, GA:
2,410,139, CANC. INT. CL. 35.

DERMAVIVE INC., LAKE OSWEGO, OR:
3,313,413, INT. CL. 5.

DERMORGANIC LABORATORIES, INC., VALENCIA, CA:
3,311,449, PUB. 7-31-2007. INT. CL. 3.

DESIGN BEGINNINGS, INC., OMAHA, NE:
2,411,234, CANC. INT. CL. 19.

DESIGN CONCRETE INC., ROME, GA:
1,419,201, CANC. INT. CL. 19.

DESIGN MANUFACTURE DISTRIBUTION, LLC, ST. LOUIS, MO:
3,314,890, INT. CL. 9.

DESIGNBOMB SOLUTIONS INC., VANCOUVER, CANADA:
3,313,556, INT. CL. 42.

DESIGNTECHNICA, INC., LAKE OSWEGO, OR:
3,314,984, INT. CL. 35.

DESTINATION CONSERVATION, LTD., EDMONTON, ALBERTA, CN T6E 4S1, CANADA:
2,020,692, CANC. INT. CL. 41.

DETOA ALBRECHTICE S.R.O., CZECH REPUBLIC:
3,312,785, PUB. 4-10-2007. MULTIPLE CLASS, INT. CLS. 15, 20 AND 28.

DETROIT RED WINGS, INC., DETROIT, MI:
2,098,934. REN. 9-11-07. INT. CL. 41.

DETROIT TRADING COMPANY, INC., ROYAL OAK, MI:
3,310,745, PUB. 7-31-2007. INT. CL. 35.

DEUTCH, RONI LYNN, NORTH HIGHLANDS, DE:
3,314,749, INT. CL. 35.

DEUTECH BANK, AG, NEW YORK BRANCH, NEW YORK, NY:
2,409,787, CANC. MULTIPLE CLASS, INT. CLS. 5 AND 35.

DEUTSCHE BANK AKTIENGESELLSCHAFT, 60325 FRANKFURT AM MAIN, FED REP GERMANY:
2,410,088, CANC. MULTIPLE CLASS, INT. CLS. 9, 35, 36 AND 42.

DEUTSCHE TELEKOM AG, FED REP GERMANY:
3,312,794, PUB. 7-31-2007. MULTIPLE CLASS, INT. CLS. 9, 16, 25, 28, 35, 36, 37, 38, 41 AND 42.

DEVAULT PACKING CO., INC., DEVAULT, PA, DBA DEVAULT FOODS:
1,489,558. REN. 9-13-07. INT. CL. 30.
1,489,558, CANC. INT. CL. 29.

DEVLIN, DANIEL P., FRISCO, CO, DBA SHERPA JAVA AND TEA COOPERATIVE:
3,312,980, MULTIPLE CLASS, INT. CLS. 30 AND 42.

DEWALD MANUFACTURING, INC., MISHAWAKA, IN:
2,410,222, CANC. INT. CL. 12.

DEWOLFSON DOWN INTERNATIONAL, INC., BANNER ELK, NC:
3,314,573, INT. CL. 24.

DEXMA, INC., EDINA, MN:
3,312,059, PUB. 7-31-2007. INT. CL. 42.

DEXTER AXLE COMPANY, ELKHART, IN:
3,312,324, PUB. 7-31-2007. INT. CL. 12.

DEZER, MICHAEL, SUNNY ISLES BEACH, FL:
3,313,397, INT. CL. 36.

- DFS GROUP L.P., SAN FRANCISCO, CA:
2,410,273, CANC. MULTIPLE CLASS, INT. CLS. 3 AND 21.
- DIABETES AMERICA, INC., HOUSTON, TX:
3,311,219, PUB. 7-31-2007. INT. CL. 44.
- DIABETES RESEARCH INSTITUTE FOUNDATION, INC., HOLLYWOOD, FL:
3,311,050, PUB. 7-31-2007. INT. CL. 36.
3,311,052, PUB. 7-31-2007. INT. CL. 36.
3,311,056, PUB. 7-31-2007. INT. CL. 36.
3,311,058, PUB. 7-31-2007. INT. CL. 36.
- DIABETES TOOLS SWEDEN AB, SWEDEN:
3,312,967, PUB. 7-31-2007. INT. CL. 42.
- DIAGEO NORTH AMERICA, INC., NORWALK, CT:
1,453,449. REN. 9-9-07. INT. CL. 33.
3,314,727, INT. CL. 33.
- DIAGNOSTICA STAGO, FRANCE:
3,312,918, PUB. 7-31-2007. MULTIPLE CLASS, INT. CLS. 5 AND 10.
- DIAL BRANDS, INC., SCOTTSDALE, AZ, PUREX CORPORATION, LAKEWOOD, CA:
1,062,573. REN. 9-9-07. INT. CL. 3.
- DIALIGHT BLP LIMITED, SUFFOLK CB8 0AX, ENGLAND:
2,078,717. REN. 9-10-07. INT. CL. 9.
- DIAMLERCHRYSLER AG, STUTTGART, FED REP GERMANY:
2,409,853, CANC. INT. CL. 9.
- DIAMOND GAME ENTERPRISES, INC., CHATSWORTH, CA:
3,313,509, INT. CL. 16.
3,313,798, INT. CL. 9.
- DIAMOND ROSE SHEARS, LLC, CASTLE ROCK, CO:
3,314,293, INT. CL. 8.
- DIAMOND TRIPLE C RANCH, YARDLEY, PA:
3,313,585, INT. CL. 25.
- DIAMOND WALL CORPORATION, CANTON, GA:
3,310,675, PUB. 7-31-2007. INT. CL. 8.
- DIAN, WALTER, DOWNERS GROVE, IL:
1,419,338, CANC. INT. CL. 28.
- DIANA WIDMAN, LAKE FOREST, IL:
3,310,992, PUB. 7-31-2007. INT. CL. 14.
- DICKIE, DYLAN, B, SOUTH LAKE TAHOE, CA:
3,312,631, PUB. 7-31-2007. INT. CL. 25.
- DICTAPHONE CORPORATION, RYE, NY:
1,419,061, CANC. INT. CL. 9.
1,419,062, CANC. INT. CL. 9.
- DIEDRE MOIRE CORPORATION, ROBBINSVILLE, NJ:
2,410,517, CANC. INT. CL. 35.
- DIFCO PERFORMANCE FABRICS INC., WEST MONTREAL, QUEBEC, CANADA:
2,410,929, CANC. INT. CL. 9.
- DIFEO, ROBERT ALLEN, HAMPTON, NH:
1,069,569. REN. 9-9-07. INT. CL. 42.
- DIGEO, INC., KIRKLAND, WA:
3,313,353, INT. CL. 9.
- DIGITAL CURRENCY SYSTEMS HOLDINGS LLC, NORTHBROOK, IL:
3,310,541, PUB. 7-10-2007. INT. CL. 9.
- DIGITAL DIRECTIONS INTERNATIONAL, INC., CARBONDALE, CA:
3,310,269, PUB. 7-31-2007. INT. CL. 41.
- DIGITAL GLOBAL ACCOUNTING INC., WILMINGTON, DE:
3,310,560, PUB. 7-31-2007. INT. CL. 35.
- DIGITAL INTERACTIVE STREAMS, INC., JACKSONVILLE, FL:
3,312,155, PUB. 7-31-2007. MULTIPLE CLASS, INT. CLS. 9 AND 41.
- DIGITAL LIGHTWAVE, INC., CLEARWATER, FL:
2,411,297, CANC. INT. CL. 9.
- DIGITAL PLAYGROUND, INC., VAN NUYS, CA:
3,312,280, PUB. 7-31-2007. INT. CL. 9.
- DIGITAL REALITY CORPORATION, NEW YORK, NY, DIGITAL REALITY, NEW YORK, NY:
1,454,952. REN. 9-9-07. INT. CL. 9.
- DIGITAL REALITY CORPORATON, NEW YORK, NY, DIGITAL REALITY, NEW YORK, NY:
1,452,981. REN. 9-9-07. INT. CL. 9.
- DIGITAL RECORDS INC, BROOKLYN, NY:
3,310,380, PUB. 6-26-2007. INT. CL. 9.
- DIGITAL THEATER SYSTEMS, INC., AGOURA HILLS, CA:
3,311,695, PUB. 7-31-2007. MULTIPLE CLASS, INT. CLS. 9 AND 41.
- DIGITALBRIDGE COMMUNICATIONS CORP., ASHBURN, VA:
3,313,837, INT. CL. 38.
- DIGITALHATCH, INC., PEACHTREE CITY, GA:
3,314,344, INT. CL. 41.
- DIGLORIA, NATHANAEL, METHUEN, MA:
3,313,290, INT. CL. 25.
- DIMARZIO, INC., STATEN ISLAND, NY:
3,313,267, INT. CL. 9.
- DIMLER, ERNEST E., GLEN BURNIE, MD:
2,410,654, CANC. INT. CL. 28.
- DINERS CLUB INTERNATIONAL LTD., CHICAGO, IL:
2,411,222, CANC. MULTIPLE CLASS, INT. CLS. 35 AND 36.
- DINOUR, DAVID, MERRICK, NY:
3,314,713, MULTIPLE CLASS, INT. CLS. 39 AND 43.
- DIRECT BENEFITS, INC., ST. PAUL, MN:
3,311,382, PUB. 7-31-2007. INT. CL. 36.
- DIRECT MARKETING EDUCATIONAL FOUNDATION, INC., NEW YORK, NY:
2,177,647. REN. 9-13-07. INT. CL. 16.
- DIRECT PARTNERS, LTD., PLANO, TX:
3,314,106, INT. CL. 14.
- DIRECT RETAILING, INC., OZARK, MO:
2,411,441, CANC. INT. CL. 35.
- DIRECT SOURCE SPECIAL PRODUCTS INC., LASALLE, QUEBEC, CANADA:
3,313,949, INT. CL. 9.
3,313,950, INT. CL. 9.
- DIRECTA AB, SWEDEN:
3,312,815, PUB. 7-31-2007. INT. CL. 10.
- DIRECTV, INC., EL SEGUNDO, CA:
2,410,158, CANC. MULTIPLE CLASS, INT. CLS. 38 AND 41.
- DIRNBECK, EDUARD, A-1060 WIEN, AUSTRIA:
2,409,932, CANC. INT. CL. 16.
- DIS GROUP INC, INGLEWOOD, CA:
3,310,432, PUB. 7-31-2007. INT. CL. 11.
- DISCOUNT STEEL, INC., MINNEAPOLIS, MN:
3,310,550, PUB. 7-31-2007. INT. CL. 35.
- DISCOVER APPRAISERS.COM, SAN BERNARDINO, CA:
3,311,202, PUB. 7-31-2007. INT. CL. 36.
- DISCOVER FINANCIAL SERVICES, RIVERWOODS, IL:
2,411,442, CANC. INT. CL. 36.
- DISCOVERY COMMUNICATIONS, INC., SILVER SPRING, MD:
3,311,754, PUB. 7-31-2007. INT. CL. 41.
- DISCOVERY COMMUNICATIONS, INC., BETHESDA, MD, DBA THE DISCOVERY CHANNEL:
3,312,982, MULTIPLE CLASS, INT. CLS. 38, 41 AND 42.
- DISGUISE, INC., POWAY, CA:
3,314,162, INT. CL. 25.
- DISNEY ENTERPRISES, INC, BURBANK, CA:
3,314,908, INT. CL. 16.
- DISNEY ENTERPRISES, INC., BURBANK, CA:
2,163,689. REN. 9-12-07. INT. CL. 16.
3,311,476, PUB. 7-31-2007. INT. CL. 41.
3,311,477, PUB. 7-31-2007. INT. CL. 41.
3,312,426, PUB. 7-31-2007. INT. CL. 41.
3,313,624, INT. CL. 43.
3,314,909, INT. CL. 16.
3,314,911, INT. CL. 18.
3,314,912, INT. CL. 20.
- DIVA DIAMONDS, NEW YORK, NY:
3,314,104, INT. CL. 35.
- DIVERSIFIED INVESTMENT ADVISORS, INC., PURCHASE, NY:
3,313,129, INT. CL. 36.
- DIVINE PHYSICS HOLISTIC LIFESTYLES, INC., CENTENNIAL, CO:
3,313,049, MULTIPLE CLASS, INT. CLS. 35, 41 AND 44.
- DIXIE CONSUMER PRODUCTS LLC, ATLANTA, GA:
3,314,647, INT. CL. 8.

DIXIE RESTAURANTS, INC., LITTLE ROCK, AR:
3,314,440, INT. CL. 43.

DJK PUBLICATIONS, INC., NEW YORK, NY:
3,311,938, PUB. 7-31-2007. INT. CL. 16.

DLJ LONG TERM INVESTMENT CORPORATION, CHICAGO, IL:
2,410,539, CANC. INT. CL. 36.

DMBM LLC, VERNON, CA:
3,314,849, INT. CL. 25.

DMG WORLD MEDIA (USA) INC., TORONTO, CANADA:
3,315,003, MULTIPLE CLASS, INT. CLS. 35 AND 41.

DNA (HOUSEMARKS) LIMITED, LONDON, ENGLAND:
1,419,179, CANC. INT. CL. 17.

DNA PHARMACEUTICALS, INC., MIAMI, FL:
3,310,223, PUB. 7-31-2007. INT. CL. 5.

DNA 2.0, MENLO PARK, CA:
3,311,343, PUB. 7-31-2007. INT. CL. 42.

DO DENIM LLC, MIAMI, FL:
3,314,220, INT. CL. 25.

DOCTOR'S ASSOCIATES INC., FORT LAUDERDALE, FL:
3,310,928, PUB. 7-31-2007. INT. CL. 43.

DOCTORS RECALL SCHEDULING SERVICES, INC., PALM HARBOR, FL:
3,310,381, PUB. 7-31-2007. INT. CL. 35.

DODGE & COX, SAN FRANCISCO, CA:
2,103,631, REN. 9-12-07. INT. CL. 36.

DOGEARED, VENICE, CA:
2,410,034, CANC. INT. CL. 20.
2,410,035, CANC. INT. CL. 20.

DOGFRIENDLY.COM, INC., POLLOCK PINES, CA:
3,310,603, PUB. 7-31-2007. MULTIPLE CLASS, INT. CLS. 16, 35, 39 AND 41.

DOGS RULE-DOG DAYCARE & SCHOOL, MEMPHIS, TN:
3,312,343, PUB. 7-31-2007. MULTIPLE CLASS, INT. CLS. 41 AND 43.

DOLBY LABORATORIES LICENSING CORPORATION, SAN FRANCISCO, CA, ASTEC INTERNATIONAL LIMITED, WANCHAI, HONG KONG:
2,093,964, REN. 9-13-07. INT. CL. 9.

DOLE DRIED FRUIT AND NUT COMPANY, FRESNO, CA:
1,419,360, CANC. INT. CL. 29.

DOLE FOOD COMPANY, INC., WESTLAKE VILLAGE, CA:
1,437,441, REN. 9-11-07. INT. CL. 28.

DOLE FRESH VEGETABLES, INC.:
1,419,387, CANC. INT. CL. 31.

DOLLAR TRIP INC., ALPHARETTA, GA:
3,314,366, INT. CL. 35.

DOLomite AB, 334 21 ANDERSTORP, SWEDEN:
2,113,646, REN. 9-13-07. INT. CL. 10.

DOMECQ WINES ESPANA, S.A., SAN SEBASTIAN, SPAIN:
3,313,525, INT. CL. 33.

DOMETIC APPLIANCES AB, SOLNA, SE17154, SWEDEN:
1,465,342, REN. 9-7-07. INT. CL. 11.

DOMINGUEZ, KIM H., IRVINE, CA:
3,314,355, INT. CL. 25.

DOMINUS ESTATE CORPORATION, YOUNTVILLE, CA:
3,314,086, INT. CL. 33.

DON SEBASTIANI & SONS INTERNATIONAL WINE NEGOCIANTS, SONOMA, CA:
3,310,722, PUB. 7-31-2007. INT. CL. 33.

DONEGAL'S IRISH PUB. LLC, ALLENDALE, NJ:
3,311,191, PUB. 7-31-2007. INT. CL. 43.

DONGGUAN DABAO CHEMICAL PRODUCTS CO., LTD., DONGGUAN CITY, GUANGDONG, CHINA:
3,313,173, INT. CL. 2.

DONNA DOWNEY, LLC, HUNTERSVILLE, NC:
3,314,696, INT. CL. 28.

DONNA M COX, LOUITCIA FULLER PARTNERSHIP, THE, TEMECULA, CA:
2,411,481, CANC. INT. CL. 25.

DONNA WEISS, D/B/A SWEET ART, HUXLEY, IA:
3,311,434, PUB. 7-31-2007. INT. CL. 30.

DOODIE FREE, LLC, ORRSTOWN, PA:
3,311,710, PUB. 7-31-2007. INT. CL. 37.

DOOR-TO-DOOR DRY CLEANING FRANCHISE SYSTEMS, LLC, PARKER, CO:
3,310,948, PUB. 7-31-2007. MULTIPLE CLASS, INT. CLS. 37 AND 39.

DOPI KARAOKE, INC., OXNARD, CA:
3,311,344, PUB. 7-31-2007. INT. CL. 35.

DORMONT MANUFACTURING COMPANY, EXPORT, PA:
3,312,441, PUB. 7-31-2007. MULTIPLE CLASS, INT. CLS. 6 AND 11.

DOUBLE A BEVERAGE, LLC, BOCA RATON, FL:
3,313,107, INT. CL. 5.

DOUBLE DECKER STUDIOS, INC., BOSTON, MA:
2,409,783, CANC. MULTIPLE CLASS, INT. CLS. 35 AND 42.

DOUBLE QUICK, INC., INDIANOLA, MS:
2,099,097, REN. 9-9-07. MULTIPLE CLASS, INT. CLS. 37 AND 42.

DOUBLETAKE DESIGN, INC., CHICAGO, IL:
3,310,439, PUB. 7-31-2007. INT. CL. 35.

DOUGHTY, SHARON, BEXLEY, KENT, UNITED KINGDOM:
3,310,200, PUB. 7-31-2007. MULTIPLE CLASS, INT. CLS. 9, 16, 25 AND 41.

DOVER WATCH AT MOUNT SNOW, LTD., VALHALLA, NY:
1,419,452, CANC. INT. CL. 36.

DOW AGROSCIENCES LLC, INDIANAPOLIS, IN, MON-SANTO COMPANY, ST. LOUIS, MO:
1,848,055, REN. 9-10-07. INT. CL. 5.

DOW AGROSCIENCES LLC, INDIANAPOLIS, IN:
3,313,423, INT. CL. 5.

DOYLE, PETER, CHAPEL HILL, NC:
3,314,596, INT. CL. 35.
3,314,630, INT. CL. 35.

DR. BOTT KG, FED REP GERMANY:
3,312,891, PUB. 7-31-2007. MULTIPLE CLASS, INT. CLS. 9, 18 AND 42.

DR. ING. SEUFERT GMBH, KARLSRUHE, FED REP GERMANY:
1,419,028, CANC. INT. CL. 9.

DR. KNOLL PRODUCTS, INC., CANFIELD, OH:
3,312,592, PUB. 4-10-2007. INT. CL. 5.

DR. MARTENS INTERNATIONAL TRADING GMBH, D-82166 GRÄFELFING, FED REP GERMANY, DR. KLAUS MAERTENS AND DR. ING. HERBERT FUNCK, MUNICH, FED REP GERMANY:
1,454,323, REN. 9-10-07. INT. CL. 25.

DR. MAX VOGT, NEVADA CITY, NV:
3,312,538, PUB. 7-31-2007. INT. CL. 41.

DR. WONDER, LLC, NEW YORK, NY:
3,314,904, INT. CL. 3.

DR.'S OWN, INC., SOLANA BEACH, CA:
2,121,116, REN. 9-7-07. INT. CL. 42.

DR.'S OWN, INC., CARLSBAD, CA:
3,313,712, INT. CL. 25.

DRAGOCO GERBERDING & CO. AKTIENGESELLSCHAFT, D-37601 HOLZMINDEN, FED REP GERMANY:
2,409,678, CANC. MULTIPLE CLASS, INT. CLS. 1 AND 3.

DRAGON OPTICAL, INC., CARLSBAD, CA:
3,314,448, INT. CL. 9.
3,314,477, INT. CL. 9.

DRAGON SYSTEMS, INC., NEWTON, MA:
1,419,515, CANC. INT. CL. 42.

DRANE, RODERICK, BLOOMFIELD HILLS, MI:
3,314,388, INT. CL. 3.

DRAZGA, EDWARD A., CHERRY HILL, NJ:
1,418,813, CANC. MULTIPLE CLASS, INT. CLS. 1 AND 3.
1,418,838, CANC. INT. CL. 2.

DREADNOUGHT, INC., WILMINGTON, DE:
3,219,286, COR. INT. CL. 35.

DREAM STAGE ENTERTAINMENT, INC., TOKYO, JAPAN:
3,311,709, PUB. 7-31-2007. INT. CL. 25.

DREAMERZ FOODS, INC., SAN FRANCISCO, CA:
3,314,626, INT. CL. 5.
3,314,789, INT. CL. 5.

DREAMWORKS ANIMATION L.L.C., GLENDALE, CA:
3,314,499, MULTIPLE CLASS, INT. CLS. 9, 16, 25, 28 AND 41.

DREISSIG, ZERLINA, BERLIN, FED REP GERMANY:
3,312,234, PUB. 7-31-2007. MULTIPLE CLASS, INT. CLS. 3, 9 AND 24.

- DRI CORPORATION, DALLAS, TX:
2,166,496. REN. 9-10-07. INT. CL. 9.
- DRIV-LOK, INC., SYCAMORE, IL, DRIV-LOK MACHINE CORPORATION, SYCAMORE, IL:
833,120. REN. 9-13-07. U.S. CL. 13 (INT. CL. 6).
- DRIVER SOLUTIONS, INC., SUN CITY, AZ:
3,310,781. PUB. 7-31-2007. INT. CL. 39.
- DRIVETIME SALES AND FINANCE CORPORATION, PHOENIX, AZ:
3,314,133. INT. CL. 36.
- DRS TECHNOLOGIES, INC., PARSIPPANY, NJ:
2,410,026. CANC. INT. CL. 9.
- DRUG DETECTION DEVICES, LTD., ALPHARETTA, GA:
3,311,594. PUB. 7-31-2007. INT. CL. 10.
- DRUML GROUP, INC., FOSTER CITY, CA:
3,311,069. PUB. 7-31-2007. INT. CL. 36.
- DS WATERS OF AMERICA, INC., ATLANTA, GA, SPRING-LITE BOTTLED WATER CORP., MIAMI, FL:
1,464,791. REN. 9-7-07. INT. CL. 32.
- DS WATERS OF AMERICA, INC., ATLANTA, GA, ROCKY MOUNTAIN BEVERAGE COMPANY, DENVER, CO:
1,464,793. REN. 9-7-07. INT. CL. 32.
- DS WATERS OF AMERICA, INC., ATLANTA, GA, COCA-COLA COMPANY, THE, ATLANTA, GA:
1,473,752. REN. 9-7-07. INT. CL. 1.
- DS WATERS OF AMERICA, INC., ATLANTA, GA:
2,169,782. REN. 9-8-07. INT. CL. 32.
2,173,994. REN. 9-7-07. INT. CL. 32.
- DTS KARAOKE, INC., LOS ANGELES, CA:
3,310,364. PUB. 7-31-2007. INT. CL. 9.
- DUBLINX WATCHES AND ACCESSORIES, IRVINE, CA:
3,313,968. INT. CL. 14.
- DUCK VENTURES, INC., PHOENIX, AZ TO UGLY DUCK-LING CAR SALES AND FINANCE CORPORATION, PHOENIX, AZ:
2,021,086. CANC. INT. CL. 42.
- DUCKWALL-ALCO STORES, INC., ABILENE, KS:
3,313,138. MULTIPLE CLASS, INT. CLS. 20, 21, 25 AND 26.
- DUKAL CORPORATION, HAUPPAUGE, NY:
2,142,612. REN. 9-13-07. INT. CL. 5.
- DULL, HAROLD, MIDDLETON, CA:
3,310,898. PUB. 7-31-2007. INT. CL. 41.
- DUNCAN, TERRY M., MARYVILLE, TN:
2,410,724. CANC. INT. CL. 41.
- DUNDEE CORPORATION, TORONTO, ONTARIO, CANADA:
2,409,930. CANC. INT. CL. 36.
- DUNG HUYNH, ALHAMBRA, CA:
3,311,066. PUB. 7-31-2007. INT. CL. 5.
3,311,067. PUB. 7-31-2007. INT. CL. 5.
- DUNTON COMMERCIAL REAL ESTATE COMPANY, DENVER, CO:
3,314,954. INT. CL. 36.
- DUPACO, INC., OCEANSIDE, CA:
2,410,709. CANC. INT. CL. 10.
- DURFERRIT GMBH, MANNHEIM, FED REP GERMANY:
1,071,626. REN. 9-13-07. INT. CL. 40.
- DUTY FREE WORLD, INC., MIAMI, FL:
3,311,718. PUB. 7-31-2007. INT. CL. 18.
- DVUV, LLC, CLEVELAND, OH:
3,310,522. PUB. 7-31-2007. INT. CL. 40.
- DX TRADING CO., LTD., TOYONAKA-SHI, OSAKA 561, JAPAN:
2,410,948. CANC. INT. CL. 9.
- DYE PRODUCTS, INC., SAN DIEGO, CA, DBA DYE PRECISION, INC. AND DYE PRODUCTS, LTD:
2,410,833. CANC. INT. CL. 28.
- DYMAX CORPORATION, TORRINGTON, CT:
1,450,521. REN. 9-13-07. INT. CL. 9.
2,065,176. REN. 9-13-07. INT. CL. 2.
2,065,211. REN. 9-13-07. INT. CL. 1.
- DYMO CORPORATION, STAMFORD, CT:
3,313,137. INT. CL. 16.
- DYNA-TOT KARATE, INC., NEWARK, DE:
2,021,190. CANC. MULTIPLE CLASS, INT. CLS. 9 AND 16.
- DYNACRAFT BSC, INC., AMERICAN CANYON, CA:
3,313,490. INT. CL. 12.
3,314,699. INT. CL. 12.
3,314,797. INT. CL. 12.
- DYNAMIC FAMILY SERVICES, KENT, WA:
3,310,306. PUB. 7-31-2007. INT. CL. 10.
- DYNAMIC PENSION SERVICES, INC., KETTERING, OH:
3,311,372. PUB. 7-31-2007. INT. CL. 36.
- DYNAMICS CORPORATION OF AMERICA, GREENWICH, CT:
1,419,055. CANC. INT. CL. 9.
- DYNAVOX SYSTEMS LLC, PITTSBURGH, PA:
3,314,575. INT. CL. 9.
- DYNAYARN USA, LLC, GRAHAM, NC:
3,310,850. PUB. 7-31-2007. INT. CL. 23.
- DYSON LIMITED, WILTSHIRE, UNITED KINGDOM:
3,311,564. PUB. 7-31-2007. MULTIPLE CLASS, INT. CLS. 7 AND 11.
- DYTECH CORPORATION LIMITED, SOUTH YORKSHIRE S18 1LS, ENGLAND:
3,310,232. PUB. 7-31-2007. MULTIPLE CLASS, INT. CLS. 1, 40 AND 42.
- E. & J. GALLO WINERY, MODESTO, CA, DBA E. & J. DISTILLERS:
1,054,058. REN. 9-13-07. INT. CL. 33.
- E. & J. GALLO WINERY, MODESTO, CA:
2,088,686. REN. 9-11-07. INT. CL. 33.
2,091,943. REN. 9-10-07. INT. CL. 33.
- E. E. SCHENCK COMPANY, PORTLAND, OR:
2,160,972. REN. 9-13-07. INT. CL. 24.
- E. GLUCK CORPORATION, LONG ISLAND CITY, NY:
2,410,889. CANC. INT. CL. 14.
- E. I. DU PONT DE NEMOURS AND COMPANY, WILMINGTON, DE:
827,105. REN. 9-13-07. U.S. CL. 16 (INT. CL. 2).
3,314,672. INT. CL. 1.
- E. J. BROOKS COMPANY, LIVINGSTON, NJ:
2,123,167. REN. 9-13-07. INT. CL. 17.
- E. JACK EDINGTON, FARMERS BRANCH, TX AND CATHY E. EDINGTON, FARMERS BRANCH, TX:
2,020,668. CANC. INT. CL. 35.
- E. R. SQUIBB & SONS, INC., PRINCETON, NJ:
1,419,077. CANC. INT. CL. 10.
- E.A. MATTES GMBH, FED REP GERMANY:
3,312,833. PUB. 7-31-2007. MULTIPLE CLASS, INT. CLS. 8, 9 AND 18.
- E.C. WALKERS INC., TORONTO, ONTARIO, CANADA:
2,410,940. CANC. INT. CL. 22.
- E.G.P. SA, 75009 PARIS, FRANCE:
2,410,831. CANC. INT. CL. 15.
- E.MAGINATION NETWORK, LLC, BALTIMORE, MD:
3,314,776. INT. CL. 42.
- E.P. GRAPHICS, INC., BERNE, IN:
3,311,780. PUB. 7-31-2007. INT. CL. 40.
- E.T. BROWNE DRUG CO., INC., ENGLEWOOD CLIFFS, NJ:
3,314,979. INT. CL. 3.
- E-COM BUSINESS SOLUTIONS, L.L.C., CHAPIN, SC:
2,410,228. CANC. MULTIPLE CLASS, INT. CLS. 35, 38 AND 42.
- E-LAW, LLC, NEWARK, NJ:
2,164,222. REN. 9-13-07. INT. CL. 42.
- E-SURG CORPORATION, SEATTLE, WA:
2,411,424. CANC. INT. CL. 42.
- E-Z BURR TOOL COMPANY, PLYMOUTH, MI:
3,315,018. INT. CL. 7.
- E-Z GARD INDUSTRIES, INC., PLYMOUTH, MN, DBA SHOCK DOCTOR, INC.:
3,311,673. PUB. 10-25-2005. INT. CL. 25.
- E-Z GRAPH OF VICTORIA, INC., VICTORIA, TX:
2,135,741. REN. 9-10-07. INT. CL. 10.
- EADDY, SUSAN ADAMS, NASHVILLE, TN:
3,310,280. PUB. 7-31-2007. INT. CL. 16.
- EAGLE WORK CLOTHES, INC., UNION, NJ:
3,312,313. PUB. 7-31-2007. MULTIPLE CLASS, INT. CLS. 10 AND 25.
- EARIGATE INC., OAKVILLE, ONATRIO, CANADA:
3,313,068. INT. CL. 10.

- EARLE, ANITRA, CHICAGO, IL:
2,410,479, CANC. INT. CL. 3.
- EARLEY, STEVE W., AHOSSKIE, NC:
2,410,570, CANC. INT. CL. 28.
- EARTH CHEMICAL COMPANY LIMITED, TOKYO, JAPAN:
3,313,848, INT. CL. 21.
- EASTER SEAL SOCIETY OF SUPERIOR CALIFORNIA,
SACRAMENTO, CA:
3,312,594, PUB. 7-31-2007. INT. CL. 44.
- EASTERN COMPANY, THE, NAUGATUCK, CT, EASTERN
MALLEABLE IRON COMPANY, THE, CLEVELAND, OH:
437,701, REN. 9-10-07. U.S. CL. 14 (INT. CL. 6).
- EASTMAN, GARY L., SAN DIEGO, CA:
3,313,039, INT. CL. 28.
- EASTWEST INTERNATIONAL (TAIWAN) ENTERPRISES,
TAICHUNG, TAIWAN:
2,411,019, CANC. INT. CL. 18.
- EASY CALL INC, CHICAGO, IL:
3,311,436, PUB. 7-31-2007. MULTIPLE CLASS, INT. CLS.
16 AND 36.
- EAT'N PARK HOSPITALITY GROUP, INC., HOMESTEAD,
PA:
3,310,197, PUB. 7-31-2007. INT. CL. 30.
- EATING DISORDERS COALITION OF TENNESSEE, INC.,
NASHVILLE, TN:
3,311,214, PUB. 7-31-2007. MULTIPLE CLASS, INT. CLS.
36 AND 41.
- EATON CORPORATION, CLEVELAND, OH:
3,314,866, INT. CL. 28.
- EBG, LLC, DALLAS, TX:
2,021,356, CANC. INT. CL. 42.
- EBM-PAPST ST. GEORGEN; GMBH & CO. KG, 78112 ST.
GEORGEN, FED REP GERMANY:
3,312,789, PUB. 7-31-2007. MULTIPLE CLASS, INT. CLS. 7
AND 9.
- EBS HEALTHCARE, INC., CONCORDVILLE, PA:
3,312,446, PUB. 7-31-2007. MULTIPLE CLASS, INT. CLS.
35 AND 41.
- EBSCO INDUSTRIES, INC., BIRMINGHAM, AL:
3,311,633, PUB. 7-31-2007. INT. CL. 41.
3,314,893, INT. CL. 35.
- ECCENTRON, LLC, DENVER, CO:
3,314,121, MULTIPLE CLASS, INT. CLS. 10 AND 28.
- ECGLOBAL TECHNOLOGIES, INC., ROCKVILLE, MD:
2,411,510, CANC. INT. CL. 38.
- ECHOSTAR SATELLITE LLC, ENGLEWOOD, CO:
3,313,606, INT. CL. 9.
- ECKART PIGMENTS KY, 28840 PORI, FINLAND:
1,457,087, REN. 9-7-07. INT. CL. 2.
- ECKMAN & DANOVITZ, PITTSBURGH, PA:
3,312,626, PUB. 7-31-2007. MULTIPLE CLASS, INT. CLS.
35 AND 45.
- ECODECO S.R.L., I-20100 MILANO, ITALY:
3,312,829, PUB. 7-31-2007. MULTIPLE CLASS, INT. CLS.
9, 40 AND 42.
- ECOM PPO ADVISORS, INC., DALLAS, TX:
3,314,935, INT. CL. 35.
- ECONET, INC., LACEY, WA:
3,313,559, INT. CL. 1.
- ECOWATER SYSTEMS LLC, WOODBURY, MN:
3,314,238, INT. CL. 11.
- ECOWATER SYSTEMS, LLC, WOODBURY, MN:
3,314,054, INT. CL. 11.
- EDELSTEIN, MORRY, SYOSSET, NY:
3,313,364, INT. CL. 25.
- EDEPOSIT CORPORATION, SILVER SPRING, MD:
3,312,677, PUB. 7-31-2007. INT. CL. 36.
- EDGINGTON, JACK E., FARMERS BRANCH, TX AND
EDGINGTON, CATHY E., FARMERS BRANCH, TX:
2,020,759, CANC. INT. CL. 35.
- EDITH'S INC., RIEGELSVILLE, PA:
3,313,193, INT. CL. 25.
- EDMONDS, KEVIN, ROCHESTER, NY:
2,409,996, CANC. INT. CL. 25.
- EDMUND RUGGER BURKE III, DALLAS, TX:
3,312,064, PUB. 7-31-2007. INT. CL. 21.
- EDUCAP INC., MCLEAN, VA:
3,313,515, MULTIPLE CLASS, INT. CLS. 36 AND 41.
- EDUCATION MANAGEMENT LLC, PITTSBURGH, PA:
2,411,522, CANC. INT. CL. 41.
- EDUCATIONAL COMMUNICATIONS, INC., LAKE FOR-
EST, IL:
1,453,579, REN. 9-13-07. INT. CL. 41.
- EDUFARM, LLC, CARY, NC:
3,313,897, INT. CL. 16.
- EDWARD LOWE FOUNDATION, CASSOPOLIS, MI:
2,410,204, CANC. INT. CL. 42.
- EDWARD MICHAEL ENTERPRISES, LLC, BEAVER
SPRINGS, PA:
3,310,300, PUB. 7-31-2007. INT. CL. 19.
- EEMPACT SOFTWARE, INC., BLOOMINGTON, MN:
3,313,208, INT. CL. 9.
- EESOF INCORPORATED, WESTLAKE VILLAGE, CA:
1,419,580, CANC. INT. CL. 9.
1,419,581, CANC. INT. CL. 9.
- EFFEM EQUINE LIMITED, SLOUGH BERKSHIRE, UNI-
TED KINGDOM:
3,313,847, INT. CL. 31.
- EFI ELECTRONICS CORPORATION, SALT LAKE CITY,
UT:
2,116,301, REN. 9-9-07. INT. CL. 36.
- EFKON USA, INC., DALLAS, TX:
3,312,683, PUB. 7-31-2007. INT. CL. 9.
- EGGINK, GARETT, ANCASTER, ONTARIO, CANADA:
2,409,962, CANC. MULTIPLE CLASS, INT. CLS. 25 AND
35.
- EIGHT HOLDING INC., SAN FRANCISCO, CA:
3,312,527, PUB. 7-31-2007. INT. CL. 42.
- EKORNES ASA, NORWAY:
3,312,881, PUB. 7-31-2007. INT. CL. 20.
- EL BATAL CORPORATION, HILLSIDE, NJ, DBA GRIP
TIGHT TOOLS:
3,313,101, MULTIPLE CLASS, INT. CLS. 7, 8 AND 9.
- EL COTO DE RIOJA, S.A., OYON, SPAIN:
3,310,679, PUB. 7-31-2007. INT. CL. 33.
- ELBEX (JAPAN) LTD., SHINAGAWA-KU, TOKYO 141,
JAPAN:
1,079,306, REN. 9-13-07. INT. CL. 9.
- ELDORADO STONE OPERATIONS LLC, CARNATION, WA:
3,311,629, PUB. 10-18-2005. INT. CL. 19.
- ELECTRIC POWER RESEARCH INSTITUTE, INC., PALO
ALTO, CA:
1,419,175, CANC. INT. CL. 16.
- ELECTRO-MATIC PRODUCTS CO., CHICAGO, IL:
2,087,423, REN. 9-11-07. INT. CL. 9.
- ELECTRONIC CONTROLS COMPANY, BOISE, ID:
3,310,361, PUB. 7-31-2007. MULTIPLE CLASS, INT. CLS.
11 AND 12.
- ELECTRONIC DATA SYSTEMS CORPORATION, PLANO,
TX:
2,411,158, CANC. INT. CL. 35.
- ELECTRONIC LONG DISTANCE LEARNING NETWORK,
INC., THE, SCHAUMBURG, IL:
2,411,071, CANC. INT. CL. 16.
- ELECTRONIC MEDIA INTERNATIONAL, KENNEBUNK,
ME, DBA E. MEDIA:
2,409,681, CANC. MULTIPLE CLASS, INT. CLS. 9 AND
42.
- ELECTRONIC RECYCLERS INTERNATIONAL, INC.,
FRESNO, CA:
3,310,875, PUB. 7-31-2007. INT. CL. 40.
- ELEGANT PUBLISHING, INC., BARRINGTON, RI:
3,314,717, MULTIPLE CLASS, INT. CLS. 16 AND 35.
- ELEMENT LIMITED CORP., JULIAN, CA:
3,312,596, PUB. 7-31-2007. U.S. CL. 200.
- ELEMENTAL SECURITY, INC., SAN MATEO, CA:
3,311,674, PUB. 7-31-2007. INT. CL. 9.
- ELGIAMAE CONCEPTS, LLC, ROSWELL, GA:
3,312,019, PUB. 7-31-2007. INT. CL. 41.
3,312,021, PUB. 7-31-2007. INT. CL. 41.
- ELIAS FRAGRANCES, INC., BROOKLYN, NY:
1,431,634, REN. 9-11-07. INT. CL. 1.
- ELITE LOGISTICS SERVICES, INC, FREEPOR, TX:
2,411,508, CANC. INT. CL. 9.
- ELIZA JAMES, SALT LAKE CITY, UTAH, UT:
3,312,630, PUB. 7-31-2007. MULTIPLE CLASS, INT. CLS.

- 25 AND 41.
ELLENBOGEN, ROBERT, SLINGERLANDS, NY:
2,094,744. REN. 9-13-07. INT. CL. 42.
- ELLIOTT, LARRY C., ELLICOTT CITY, MD, DBA RETRO-SPECT:
1,453,588. REN. 9-7-07. INT. CL. 41.
- ELLIOTT, STEPHEN B., ALLEN, TX:
3,311,529. PUB. 7-31-2007. INT. CL. 16.
- ELLIPSY TECHNOLOGIES, INC., APTOS, CA TO CANOGA PERKINS CORP., CHATSWORTH, CA:
2,020,609. CANC. INT. CL. 9.
- ELLIS LADDER IMPROVEMENTS, INC., WILMINGTON, DE:
3,312,490. PUB. 7-31-2007. INT. CL. 6.
- ELLIS, MITCHELL, WILMER, AL:
3,314,708. INT. CL. 1.
- ELMAR S.R.L., RONCADE FRAZIONE BIANCADE (TREVISO), ITALY:
3,311,848. PUB. 7-31-2007. INT. CL. 20.
- ELMENDORF, CRAIG C., SAN ANTONIO, TX:
3,310,588. PUB. 7-31-2007. INT. CL. 25.
- ELMER'S PRODUCTS, INC., COLUMBUS, OH:
3,314,176. INT. CL. 28.
3,314,177. INT. CL. 28.
- ELVIS PRESLEY ENTERPRISE, INC., MEMPHIS, TN:
2,092,231. REN. 9-12-07. INT. CL. 42.
- ELVIS PRESLEY ENTERPRISES, INC., MEMPHIS, TN:
2,091,289. REN. 9-10-07. INT. CL. 26.
- ELYNX TECHNOLOGIES, L.L.C., TULSA, OK:
3,312,665. PUB. 7-31-2007. INT. CL. 9.
- ELYSEE SCIENTIFIC COSMETICS, INC., VERONA, WI:
3,313,483. INT. CL. 3.
- EMANUEL, ELIZABETH F., LONDON, UNITED KINGDOM:
3,312,295. PUB. 7-17-2007. MULTIPLE CLASS, INT. CLS. 3 AND 25.
- EMBROIDERY CENTRAL, INC., LOGAN, UT:
3,314,422. MULTIPLE CLASS, INT. CLS. 23 AND 26.
- EMBUTIDOS Y JAMONES FERMIN, S.L., LA ALBERCA (SALAMANCA), SPAIN:
3,314,042. INT. CL. 29.
- EMC CORPORATION, ST. PAUL, MN:
3,312,685. PUB. 2-20-2007. MULTIPLE CLASS, INT. CLS. 9 AND 16.
- EMC TRANSPORTATION, TUCSON, AZ:
2,410,631. CANC. INT. CL. 35.
- EMELIA FRANKS FOODS INC., TORONTO, ONTARIO, CANADA:
1,419,348. CANC. INT. CL. 29.
- EMERSON ELECTRIC CO., ST. LOUIS, MO:
2,099,939. REN. 9-9-07. INT. CL. 7.
2,411,479. CANC. INT. CL. 7.
2,921,067. CANC. MULTIPLE CLASS, INT. CLS. 6, 9, 12, 20 AND 21.
3,313,605. INT. CL. 7.
3,314,768. INT. CL. 7.
- EMERSON NETWORK POWER SURGE PROTECTION, INC., BINGHAMTON, NY:
2,115,239. REN. 9-10-07. INT. CL. 9.
- EMILY MYLES, SWANSEA, MA, DBA EMILY MYLES FIBRE ART & DESIGN:
3,314,269. INT. CL. 18.
- EMIN GIDA INSAAT OTOMOTIV ITHALAT IHRACAAT SAN. VE TIC. LTD. STI., TURKEY:
3,312,728. PUB. 7-31-2007. INT. CL. 29.
- EMISSIVE ENERGY CORPORATION, NORTH KINGSTOWN, RI:
2,599,239. CANC. INT. CL. 9.
- EMMIS RADIO, LLC, INDIANAPOLIS, IN:
3,314,931. INT. CL. 35.
- EMORY UNIVERSITY, ATLANTA, GA:
3,310,329. PUB. 7-31-2007. MULTIPLE CLASS, INT. CLS. 35 AND 41.
3,311,857. PUB. 7-31-2007. INT. CL. 44.
- EMPIRE BEAUTY SCHOOL, INC, POTTSVILLE, PA:
3,313,637. INT. CL. 16.
- EMPIRE CONTINENTAL MANAGEMENT INC., THORN-HILL, ONTARIO:
3,310,304. PUB. 1-9-2007. INT. CL. 37.
- EMPOWERGY, INC., BOUNTIFUL, UT:
3,312,254. PUB. 6-26-2007. INT. CL. 9.
- EMPRESA NUESTRA SEÑORA DE LA ASUNCIÓN C.I.S.A., ASUNCIÓN, PARAGUAY:
3,311,976. PUB. 7-31-2007. MULTIPLE CLASS, INT. CLS. 36 AND 39.
- EMS TECHNOLOGIES, INC., NORCROSS, GA:
3,313,648. INT. CL. 9.
- EMU COUNTRY, INC., MEGARGEL, TX:
2,410,979. CANC. INT. CL. 3.
- ENCORE INVESTMENTS, INC., BOISE, ID:
2,410,390. CANC. INT. CL. 42.
- END-OF-LIFE CHOICES, DENVER, CO:
3,313,396. MULTIPLE CLASS, INT. CLS. 35 AND 42.
- ENDO PHARMACEUTICALS INC., CHADDS FORD, PA:
3,314,920. MULTIPLE CLASS, INT. CLS. 41 AND 44.
- ENDONSENSE SA, 1217 MEYRIN, SWITZERLAND:
3,310,756. PUB. 7-17-2007. MULTIPLE CLASS, INT. CLS. 9, 10, 42 AND 44.
3,310,758. PUB. 7-17-2007. MULTIPLE CLASS, INT. CLS. 9 AND 10.
- ENDSLEY, ROY III, CHESTERTON, IN:
3,139,478. AM. INT. CL. 35.
- ENERGY KITCHEN, INC., NEW YORK, NY:
3,311,053. PUB. 7-31-2007. INT. CL. 43.
- ENERGYSOLUTIONS, LLC, SALT LAKE CITY, UT:
3,314,241. INT. CL. 40.
- ENERLON, VALENCIA, CA:
3,311,008. PUB. 7-31-2007. INT. CL. 35.
- ENFOREX ENGLISH FOR EXECUTIVES, S.L., MADRID, SPAIN:
3,311,604. PUB. 7-31-2007. INT. CL. 41.
- ENFUSION2, LLC, FAYETTEVILLE, AR:
3,314,536. INT. CL. 42.
- ENGAGE CORPORATION, SAN MATEO, CA:
3,313,722. INT. CL. 45.
- ENGENUITY TECHNOLOGIES, INC., MONTREAL, QUEBEC H4P 1T7, CANADA:
3,310,214. PUB. 7-31-2007. MULTIPLE CLASS, INT. CLS. 41 AND 42.
- ENGINEERING & RESEARCH ASSOCIATES, INC., TUCSON, AZ:
3,313,349. INT. CL. 9.
- ENLIGNMENT, INC., CAMBRIDGE, MA:
3,310,915. PUB. 7-31-2007. INT. CL. 41.
- ENSYSTEX, INC., FAYETTEVILLE, NC:
3,314,122. INT. CL. 5.
- ENTERPRISE MESSAGING SERVICES, INC., MALVERN, PA:
2,409,864. CANC. INT. CL. 9.
- ENVASES DEL VALLES, S.A., SPAIN:
3,312,808. PUB. 7-31-2007. MULTIPLE CLASS, INT. CLS. 17, 20 AND 40.
- ENVIRO PRODUCTS CORP., ROGERSVILLE, MO:
2,134,331. REN. 9-10-07. INT. CL. 1.
- ENVIRO-SAN CORPORATION, CYPRESS, TX:
3,310,853. PUB. 7-31-2007. INT. CL. 6.
3,310,883. PUB. 7-31-2007. INT. CL. 19.
- ENVIRONMENTAL DATA RESOURCES, INC., MILFORD, CT:
3,313,099. INT. CL. 42.
3,314,210. MULTIPLE CLASS, INT. CLS. 16 AND 42.
- ENVIRONMENTAL SAFETY SOLUTIONS, LLC, NEW YORK, NY:
3,312,161. PUB. 7-31-2007. INT. CL. 7.
- ENVIRONMENTAL STONE PRODUCTS GLOBAL DISTRIBUTION LLC, ALLENTON, WI:
2,409,948. CANC. INT. CL. 19.
- ENZON PHARMACEUTICALS, INC., BRIDGEWATER, NJ:
3,314,934. INT. CL. 42.
- ENZYMATIC THERAPY, INC., GREEN BAY, WI:
3,313,028. INT. CL. 5.
3,313,030. INT. CL. 5.
- EPAYABLES, LLC, RED BANK, NJ:
3,312,000. PUB. 7-31-2007. MULTIPLE CLASS, INT. CLS. 9

- AND 42.
EPIC RESORTS, LLC, KING OF PRUSSIA, PA:
2,410,299, CANC. INT. CL. 42.
EPIPHANY SOFTWARE, SAN JOSE, CA:
2,086,339, REN. 9-13-07. INT. CL. 9.
EPR INVESTMENTS, INC., WILMINGTON, DE:
3,310,195, PUB. 7-31-2007. INT. CL. 30.
EPS TECHNOLOGIES, INC., MANKATO, MN:
3,313,433, INT. CL. 1.
3,313,434, INT. CL. 1.
EQUILON ENTERPRISES LLC, HOUSTON, TX:
2,411,393, CANC. INT. CL. 4.
EQUINE CHEMICAL CO., INC., TULSA, OK:
1,418,888, CANC. INT. CL. 5.
EQUINE SOURCE BOOK, COSTA MESA, CA:
3,310,777, PUB. 6-26-2007. INT. CL. 35.
EQUITABLE LIFE & CASUALTY INSURANCE COMPANY,
SALT LAKE CITY, UT:
3,311,502, PUB. 7-31-2007. INT. CL. 36.
ER MARKS, INC., WILMINGTON, DE:
3,314,526, INT. CL. 35.
ERAWAN MARKETING COMPANY, LTD., BANGKOK
10700, THAILAND:
3,310,527, PUB. 7-31-2007. INT. CL. 30.
ERB INDUSTRIES, INC., WOODSTOCK, GA:
3,313,765, INT. CL. 9.
ERIKSSON ASSOCIATES, ATLANTA, GA:
3,313,527, INT. CL. 35.
ERICO INTERNATIONAL CORPORATION, SOLON, OH,
ELECTRIC RAILWAY IMPROVEMENT CO., THE, CLE-
VELAND, OH:
66,420, REN. 9-13-07. U.S. CL. 21 (INT. CL. 9).
ERMENEGILDO ZEGNA CORPORATION, ENGLEWOOD,
NJ:
3,313,305, INT. CL. 35.
ERN ENTERPRISES, INC., PALATINE, IL:
3,314,933, INT. CL. 28.
ESAOTE, S.P.A., 20100 MILANO, ITALY:
3,310,310, PUB. 7-31-2007. MULTIPLE CLASS, INT. CLS.
9, 10 AND 42.
3,310,311, PUB. 6-26-2007. INT. CL. 10.
ESCALATE, INC., SAN DIEGO, CA:
2,411,594, CANC. INT. CL. 9.
ESELL, LLC, SHEBOYGAN, WI:
3,311,201, PUB. 7-31-2007. INT. CL. 35.
ESI CASES & ACCESSORIES, INC., NEW YORK, NY:
3,314,333, INT. CL. 9.
ESPRESSAROMA S.P.A., 00155 ROMA, ITALY:
3,313,016, INT. CL. 30.
ESPRIT DE CORP., SAN FRANCISCO, CA:
1,419,245, CANC. INT. CL. 25.
ESSELTE CORPORATION, MELVILLE, NY:
2,411,250, CANC. INT. CL. 16.
ESSENBURG, RYAN J, HOLLAND, MI:
3,310,874, PUB. 7-31-2007. INT. CL. 3.
ESSENTIX, INC., PORTLAND, OR, BORNEMEIER, DOU-
GLAS J., PORTLAND, OR, DBA APPLIED RESEARCH
TECHNOLOGIES:
2,090,516, REN. 9-9-07. INT. CL. 35.
ESTABLISSEMENTS ROULLET FRANSAC, CHERMIGNAC
THENAC, FRANCE:
3,313,768, INT. CL. 33.
ESTEE LAUDER INC., NEW YORK, NY:
3,313,472, INT. CL. 3.
ESTRUCTURAS, MÓDULOS Y SISTEMAS S.A., E-43710
SANTA OLIVA (TARRAGONA), SPAIN:
3,312,748, PUB. 7-31-2007. MULTIPLE CLASS, INT. CLS.
20 AND 42.
ETABLISSEMENTS PEUGEOT FRERES SA, VALENTIGNEY
(DOUBS), FRANCE, SOCIETE PEUGEOT & CIE, LEVAL-
LOIS-PERRET (SEINE), FRANCE:
823,963, REN. 9-8-07. U.S. CL. 23 (INT. CLS. 6, 7, 8, 9, 11,
12, 16, 21 AND 28).
ETEL S.A., MÔTIERS, SWITZERLAND:
3,311,815, PUB. 7-31-2007. INT. CL. 7.
ETHAN ALLEN GLOBAL, INC., DANBURY, CT:
2,411,026, CANC. INT. CL. 20.
ETHOX CORP., BUFFALO, NY:
2,091,414, REN. 9-13-07. INT. CL. 10.
ETS, G. HIBON S.A., ROUBAIX (NORD), FRANCE:
1,418,940, CANC. INT. CL. 7.
ETYMOTIC RESEARCH, INC., ELK GROVE VILLAGE, IL:
3,312,347, PUB. 7-31-2007. MULTIPLE CLASS, INT. CLS. 9
AND 10.
EURASIA CONCEPTS, INC., LOS ANGELES, CA:
3,312,359, PUB. 7-31-2007. MULTIPLE CLASS, INT. CLS.
9, 11 AND 21.
EURIAL-POITOURAINE, F-86130 DISSAY, FRANCE:
3,312,824, PUB. 7-31-2007. INT. CL. 29.
EUROAMERICAN PROPAGATORS, LLC, BONSALL, CA:
3,313,693, INT. CL. 31.
EUROFUN TOURISTIK GMBH, AUSTRIA:
3,312,933, PUB. 7-31-2007. MULTIPLE CLASS, INT. CLS.
39, 41 AND 43.
EVENFLO COMPANY, INC., VANDALIA, OH, LISCO, INC.,
TAMPA, FL:
2,086,968, REN. 9-12-07. INT. CL. 12.
EVENT MALL, INC., ORLANDO, FL:
3,312,689, PUB. 4-24-2007. MULTIPLE CLASS, INT. CLS.
35, 37 AND 41.
EVENTINVENTORY.COM, INC., CRYSTAL LAKE, IL:
3,312,013, PUB. 7-31-2007. MULTIPLE CLASS, INT. CLS.
9, 35 AND 42.
EVERBANK, JACKSONVILLE, FL:
3,310,882, PUB. 7-31-2007. INT. CL. 36.
EVEREADY BATTERY COMPANY, INC., ST. LOUIS, MO:
3,313,401, INT. CL. 9.
EVEREST REINSURANCE COMPANY, LIBERTY CORNER,
NJ:
2,055,340, REN. 9-7-07. INT. CL. 36.
EVERNHAM MOTORSPORTS, LLC, STATESVILLE, NC:
3,311,330, PUB. 7-17-2007. MULTIPLE CLASS, INT. CLS.
6, 9, 16, 21, 25, 28 AND 41.
EVERYTHING BUT WATER, LLC, ORLANDO, FL:
1,419,552, CANC. INT. CL. 42.
EVETS CORPORATION, SAN CLEMENTE, CA:
2,411,444, CANC. INT. CL. 15.
EVEY, DAVID S., BEVERLY HILLS, CA:
3,314,109, INT. CL. 4.
EXCELERATE, INC., IRVINE, CA:
3,310,472, PUB. 7-31-2007. INT. CL. 35.
EXCELLENCE LUXURY CAR RENTAL, INC, MIAMI, FL:
3,311,929, PUB. 7-31-2007. INT. CL. 39.
EXCLUSIVE LIGHTING, INC., TORRANCE, CA:
3,313,251, INT. CL. 35.
EXECUTIVE SPORTS MEMORABILIA, INC., NEW YORK,
NY:
2,410,689, CANC. INT. CL. 35.
EXECUTORS OF THE ESTATE OF C.J. VIGNOLO,
SHAFTER, CA, VIGNOLO, C. J., SHAFTER, CA, DBA
VIGNOLO FARMS:
849,914, REN. 9-10-07. U.S. CL. 46 (INT. CL. 31).
EXECUTRON MORTGAGE NETWORK INTERNATIONAL,
INC., EXCELSIOR, MN, EXECUTRON MORTGAGE NET-
WORK, INC., MINNEAPOLIS, MN:
1,452,504, REN. 9-8-07. INT. CL. 36.
EXEDY AMERICA CORPOARTION, MASCOT, TN:
2,096,392, REN. 9-10-07. INT. CL. 12.
EXELIAN, MISSION VIEJO, CA:
2,410,358, CANC. INT. CL. 42.
EXERCISE PRESCRIPTIONS, INC., ASPEN, CO, DBA FAS-
TLAYNE FITNESS:
2,411,074, CANC. INT. CL. 41.
EXHIB-IT! TRADESHOW MARKETING EXPERTS, LLC,
ALBUQUERQUE, NM:
3,310,801, PUB. 7-31-2007. MULTIPLE CLASS, INT. CLS.
35, 37, 39 AND 42.
EXPERIENCE HENDRIX, L.L.C., SEATTLE, WA:
3,312,070, PUB. 7-31-2007. INT. CL. 4.
3,312,071, PUB. 7-31-2007. INT. CL. 5.
3,312,206, PUB. 7-31-2007. INT. CL. 9.
EXPERITEC, INC., CHESTERFIELD, MO, MUNGER COM-
PANY, INC., ST. LOUIS, MO:
2,134,983, REN. 9-13-07. INT. CL. 9.

- EXPLERE.COM, INC., MANHATTAN BEACH, CA:
2,410,695, CANC. INT. CL. 42.
- EXPLORE PLANET EARTH PTY LTD, AUSTRALIA:
3,312,805, PUB. 7-31-2007. MULTIPLE CLASS, INT. CLS.
18, 20, 22 AND 25.
- EXPONENTIAL EDGE, INC., PALO ALTO, CA:
3,310,734, PUB. 7-31-2007. INT. CL. 35.
- EXTENDED SYSTEMS, INC., BOISE, ID:
2,410,848, CANC. INT. CL. 9.
- EXTENSION FOUNDATION, LINCOLN, NE:
3,310,726, PUB. 7-31-2007. INT. CL. 41.
- EXTREME TECHNOLOGIES, INC., EUGENE, OR, DBA
BOWTECH:
3,314,865, INT. CL. 28.
- EXXON CORPORATION, FLEMINGTON, NJ:
1,418,831, CANC. INT. CL. 1.
- EXXONMOBIL OIL CORPORATION, IRVING, TX:
1,012,598, CANC. U.S. CL. 38.
- EYEFI DIGITAL TV, INC., LAS VEGAS, NV:
3,312,690, PUB. 7-31-2007. INT. CL. 9.
- EZE CASTLE SOFTWARE, INC., BOSTON, MA:
3,312,339, PUB. 7-31-2007. MULTIPLE CLASS, INT. CLS.
36 AND 42.
- E6688, INC., POTOMAC, MD:
3,314,341, INT. CL. 35.
- F. MCLINTOCKS SALOON & DINING HOUSE, INC., SHELL
BEACH, CA:
2,087,801, REN. 9-11-07. INT. CL. 42.
- F.F.F. ENTERPRISES, INC., TEMECULA, CA:
2,073,752, REN. 9-10-07. INT. CL. 42.
- F.LLI FERRARI CORPORATION S.P.A., BORETTO, ITALY:
2,113,636, REN. 9-7-07. INT. CL. 7.
- FA. GEBR. VERWER, LISSE, NETHERLANDS:
3,311,468, PUB. 7-31-2007. INT. CL. 31.
- FACEONBODY, INC., SANTA BARBARA, CA:
3,311,029, PUB. 7-31-2007. INT. CL. 9.
- FAIR ISAAC CORPORATION, MINNEAPOLIS, MN:
3,313,894, INT. CL. 10.
- FAIRYTALE BROWNIES, INC., PHOENIX, AZ:
3,312,260, PUB. 7-31-2007. INT. CL. 30.
- FAITH COMMUNICATIONS, INC., BEVERLY HILLS, CA:
3,315,024, MULTIPLE CLASS, INT. CLS. 9 AND 38.
- FAITH CONNEXION, FRANCE:
3,312,944, PUB. 7-31-2007. INT. CL. 9.
- FAMILY MANAGER, INC., DALLAS, TX, PEEL, KATHY,
NASHVILLE, TN:
2,090,171, REN. 9-9-07. INT. CL. 16.
- FAMILY NETWORK, INC., NEW YORK, NY:
3,314,616, INT. CL. 35.
- FAMILY READING PARTNERSHIP, INC., ITHACA, NY:
3,311,912, PUB. 6-12-2007. MULTIPLE CLASS, INT. CLS.
35 AND 41.
- FANDETTI, JOHN C., SHERIDAN, CA, DBA DETTI ORI-
GINALS:
2,411,607, CANC. INT. CL. 14.
- FANI, LISA, STATEN ISLAND, NY:
3,313,076, INT. CL. 25.
- FANNING CONSULTORES E SERVIÇOS LDA, PORTUGAL:
3,312,750, PUB. 7-31-2007. MULTIPLE CLASS, INT. CLS.
3, 9, 14, 18 AND 25.
- FANTASIA ACCESSORIES LTD., NEW YORK, NY:
2,411,198, CANC. INT. CL. 21.
- FANTASTIC SAMS FRANCHISE CORPORATION, GAR-
DEN GROVE, CA:
3,311,803, PUB. 7-31-2007. INT. CL. 25.
- FANTASY SPORTS INTERNATIONAL, LTD., BUFFALO
GROVE, IL:
2,409,822, CANC. INT. CL. 41.
- FANTE, INC., SAN FRANCISCO, CA, DBA CASA SANCHEZ
FOODS:
3,313,043, INT. CL. 30.
- FARBERWARE LICENSING COMPANY LLC, NEEDHAM,
MA:
3,314,390, INT. CL. 21.
- FARCHIONI OLII S.P.A., 06030 - GIANO DELL'UMBRIA
(PG), ITALY:
2,096,705, REN. 9-11-07. INT. CL. 29.
- FARESin S.P.A., ITALY:
3,312,809, PUB. 7-31-2007. MULTIPLE CLASS, INT. CLS.
6, 7 AND 12.
- FARLEY'S AND SATHERS CANDY COMPANY, INC.,
ROUND LAKE, MN:
3,310,868, PUB. 7-31-2007. INT. CL. 30.
3,310,869, PUB. 7-31-2007. INT. CL. 30.
3,310,870, PUB. 7-31-2007. INT. CL. 30.
- FARM & RANCH PUBLISHING, L.L.C., HOUSTON, TX:
3,310,516, PUB. 7-31-2007. MULTIPLE CLASS, INT. CLS.
16 AND 35.
- FARMACIAS DE SIMILARES, S.A. DE C.V., MEXICO CITY,
MEXICO:
3,311,678, PUB. 7-31-2007. INT. CL. 5.
- FARMER, ANDY, ENCINITAS, CA AND FARMER, PAIGE,
ENCINITAS, CA:
3,312,346, PUB. 7-31-2007. MULTIPLE CLASS, INT. CLS.
25 AND 41.
- FARMS INTERNATIONAL, INC., KNIFE RIVER, MN:
3,314,420, MULTIPLE CLASS, INT. CLS. 36 AND 45.
- FASHION ACCESSORIES SHIPPERS ASSOCIATION, INC.,
NEW YORK, NY:
3,312,308, PUB. 7-31-2007. INT. CL. 35.
- FASTEC INDUSTRIAL CORP., ELKHART, IN:
3,314,261, INT. CL. 6.
- FASTWEB.COM, NORTH CHICAGO, IL:
2,348,954, CANC. INT. CL. 36.
- FAUX EFFECTS INTERNATIONAL, INC., VERO BEACH,
FL:
3,313,827, INT. CL. 2.
- FAVORITEGIFT.COM, SOMERVILLE, MA:
2,410,391, CANC. INT. CL. 35.
- FAY'S INCORPORATED, LIVERPOOL, NY:
1,419,546, CANC. INT. CL. 42.
- FBL FINANCIAL GROUP, INC., WEST DES MOINES, IA:
3,313,185, INT. CL. 36.
- FC BAYERN MUNCHEN AG, 81547 MUNCHEN, FED REP
GERMANY:
2,060,257, AM. MULTIPLE CLASS, INT. CLS. 6, 9, 14, 16,
18, 20, 21, 24, 25, 26, 27, 28 AND 34.
- FCI AMERICAS TECNOLOGY, INC., RENO, NV, AKA
BERG TECHNOLOGY, INC., BERG TECHNOLOGY,
INC., RENO, NV:
2,102,279, REN. 9-11-07. INT. CL. 9.
- FDM, INC., LAFAYETTE HILLS, PA, TA SECURITY RE-
SOURCE GROUP:
3,310,809, PUB. 7-31-2007. INT. CL. 45.
- FEDERACION NACIONAL DE CAFETEROS DE COLOM-
BIA, BOGOTÁ, D.C., COLOMBIA, AKA NATIONAL
FEDERATION OF COFFEE GROWER OF COLOMBIA:
3,311,737, PUB. 7-31-2007. INT. CL. 43.
- FEDERAL ALLIANCE FOR SAFE HOMES, TALLAHASSEE,
FL:
3,312,099, PUB. 7-31-2007. INT. CL. 41.
- FEDERAL CARTRIDGE COMPANY, ANOKA, MN:
2,411,530, CANC. INT. CL. 13.
- FEDERAL EXPRESS CORPORATION, MEMPHIS, TN AND
KINKO'S VENTURES, INC., DALLAS, TX:
3,310,770, PUB. 7-31-2007. MULTIPLE CLASS, INT. CLS.
9, 35, 38, 39, 40, 41 AND 42.
- FEDERAL NATIONAL MORTGAGE ASSOCIATION, WA-
SHINGTON, DC, DBA FANNIE MAE:
3,313,480, INT. CL. 42.
- FEDERATED DEPARTMENT STORES, INC., CINCINNATI,
OH:
3,310,578, PUB. 7-10-2007. INT. CL. 41.
- FEDERATED MUTUAL INSURANCE COMPANY, OWA-
TONNA, MN:
3,314,842, INT. CL. 36.
- FEDERATION INTERNATIONALE DE FOOTBALL ASSO-
CIATION (FIFA), ZÜRICH, SWITZERLAND:
3,310,221, PUB. 12-2-2003. MULTIPLE CLASS, INT. CLS.
9, 16, 36 AND 38.
- FEHR FOODS, INC., ABILENE, TX:
2,021,133, CANC. INT. CL. 30.
- FEI REFRIGERATED SERVICES LLC, ALGONA, WA,
SCHNITZER INVESTMENT CORP., PORTLAND, OR:
2,136,568, REN. 9-11-07. INT. CL. 39.

- FEIGIN, MICHAEL, SPRING, TX:
3,313,512, INT. CL. 35.
- FEMALE, STUDIO CITY, CA:
3,314,957, INT. CL. 25.
- FEMINISTS FOR LIFE OF AMERICA, ALEXANDRIA, VA:
2,048,699, REN. 9-7-07. INT. CL. 42.
- FENN'S FORMALWEAR, INC., BATON ROUGE, LA:
2,410,255, CANC. INT. CL. 42.
- FENNER (INDIA) LIMITED, TAMIL NADU, INDIA:
3,310,841, PUB. 7-31-2007. MULTIPLE CLASS, INT. CLS. 7 AND 12.
- FENNER, PAUL, GUILDFORD SURREY GU2 5RN, UNITED KINGDOM:
3,310,228, PUB. 2-28-2006. INT. CL. 21.
- FERNANDEZ, JORGE, J. GUADALUPE, CA:
3,311,081, PUB. 7-31-2007. INT. CL. 5.
- FERNCO INC., DAVISON, MI:
3,313,725, INT. CL. 19.
- FERNDALE IP, INC., FERNDALE, MI:
1,471,162, REN. 9-10-07. INT. CL. 5.
1,474,726, REN. 9-10-07. INT. CL. 5.
1,476,501, REN. 9-10-07. INT. CL. 5.
- FERRERO S.P.A., ALBA (CUNEO), ITALY, P. FERRERO & C. S.P.A., ALBA (CUNEO), ITALY:
835,576, REN. 9-13-07. U.S. CL. 46 (INT. CL. 30).
- FERVOR, INC., KALAMAZOO, MI:
3,312,213, PUB. 7-31-2007. INT. CL. 35.
- FESQ, MONICA J, FREDERICKSBURG, VA:
3,311,039, PUB. 7-31-2007. INT. CL. 24.
- FEULING, JAMES J., VENTURA, CA:
2,410,201, CANC. INT. CL. 12.
- FF TRADEMARK, L.L.C., NEW YORK, NY:
2,410,959, CANC. INT. CL. 3.
- FIA CARD SERVICES, NATIONAL ASSOCIATION, WILMINGTON, DE:
2,020,178, CANC. INT. CL. 36.
3,310,181, PUB. 7-31-2007. INT. CL. 36.
3,313,865, INT. CL. 36.
3,314,757, INT. CL. 36.
3,314,824, INT. CL. 36.
3,314,851, MULTIPLE CLASS, INT. CLS. 35 AND 36.
- FIATALLIS NORTH AMERICA, INC., CAROL STREAM, IL:
1,419,110, CANC. INT. CL. 12.
- FIBERLINK COMMUNICATIONS CORPORATION, BLUE BELL, PA:
3,313,400, INT. CL. 9.
- FIDELITY AND DEPOSIT COMPANY OF MARYLAND, BALTIMORE, MD:
2,409,994, CANC. INT. CL. 36.
- FIEBING COMPANY, INC., MILWAUKEE, WI:
3,314,951, INT. CL. 2.
- FIELD & STREAM LICENSES COMPANY, LLC, WESTPORT, CT:
2,041,466, REN. 9-7-07. INT. CL. 3.
- FIELD LOGIC, INC., SUPERIOR, WI:
3,314,168, INT. CL. 28.
- FIELDS, ANDREW M, BOCA RATON, FL:
3,310,720, PUB. 7-31-2007. INT. CL. 35.
- FIESTA PALMS, LLC, LAS VEGAS, NV:
3,314,034, MULTIPLE CLASS, INT. CLS. 25 AND 43.
3,314,035, MULTIPLE CLASS, INT. CLS. 25 AND 43.
- FIFTH ALARM, INC., BYRON, IL:
3,311,648, PUB. 7-31-2007. INT. CL. 43.
- FIGHT FOREVER FOUNDATION, CHICAGO, IL:
3,312,686, PUB. 7-31-2007. INT. CL. 36.
- FINANCIAL CONSULTING & MANAGEMENT, INC., BALTIMORE, MD:
3,311,185, PUB. 7-31-2007. INT. CL. 36.
- FINANCIALWEB.COM, INC., ALTAMONTE SPRINGS, FL:
2,410,431, CANC. INT. CL. 36.
- FINE, TINA, CHAPPAQUA, NY:
3,310,600, PUB. 7-31-2007. INT. CL. 41.
- FINGERHUT CORPORATION, MINNETONKA, MN:
2,411,462, CANC. MULTIPLE CLASS, INT. CLS. 11 AND 25.
- FIRE FACILITIES, INC., SUN PRAIRIE, WI, FIRE FACILITIES, INC., ANTIOCH, IL:
2,068,088, REN. 9-11-07. INT. CL. 37.
- FIREBELLY TECHNOLOGIES, INC., ROCHESTER, IN:
2,410,581, CANC. INT. CL. 35.
- FIREBOX.COM HOLDINGS PLC, LONDON, UNITED KINGDOM:
3,311,640, PUB. 4-17-2007. MULTIPLE CLASS, INT. CLS. 25 AND 41.
- FIREFLY VALUE PARTNERS, LP, NEW YORK, NY:
3,310,369, PUB. 7-31-2007. INT. CL. 36.
- FIREMAN'S FUND INSURANCE COMPANY, NOVATO, CA:
2,103,526, REN. 9-7-07. INT. CL. 36.
- FIRSHEIN, RICHARD, NEW YORK, NY:
2,021,098, CANC. INT. CL. 42.
- FIRST AMERICAN CORELOGIC, INC., SANTA ANA, CA:
2,410,005, CANC. MULTIPLE CLASS, INT. CLS. 36 AND 39.
- FIRST AMERICAN FINANCIAL CORPORATION, THE, SANTA ANA, CA:
1,470,953, REN. 9-13-07. INT. CL. 36.
- FIRST CALL FLAGGING INC, CHEHALIS, WA:
3,312,503, PUB. 7-31-2007. INT. CL. 9.
- FIRST FLORIDA CREDIT UNION, JACKSONVILLE, FL:
3,310,276, PUB. 7-31-2007. INT. CL. 36.
- FIRST HEALTH GROUP CORP., DOWNERS GROVE, IL:
2,411,144, CANC. INT. CL. 35.
- FIRST PRESBYTERIAN CHURCH, JACKSON MISSISSIPPI, JACKSON, MS:
3,311,400, PUB. 7-31-2007. INT. CL. 45.
- FIRST THINGS: A MONTHLY JOURNAL OF RELIGION AND PUBLIC LIFE, NEW YORK, NY:
2,410,484, CANC. INT. CL. 16.
- FIRSTACRE REALTY, LLC, WETHERSFIELD, CT:
3,311,133, PUB. 7-31-2007. INT. CL. 36.
- FIRSTFED FINANCIAL CORPORATION, SANTA MONICA, CA:
3,311,703, PUB. 7-31-2007. INT. CL. 36.
- FIRTH, CHARLES B., BATAVIA, IL:
3,313,607, INT. CL. 21.
- FISERV, INC., BROOKFIELD, WI:
3,312,569, PUB. 7-31-2007. INT. CL. 35.
- FISH & RICHARDSON P.C., MINNEAPOLIS, MN:
3,312,635, PUB. 7-31-2007. INT. CL. 42.
- FISHER, JUANITA B., VALLEJO, CA:
3,313,116, INT. CL. 16.
- FISSLER GMBH, FED REP GERMANY:
3,312,715, PUB. 7-31-2007. MULTIPLE CLASS, INT. CLS. 8 AND 21.
- FITNESS QUEST INC., CANTON, OH:
2,114,440, REN. 9-7-07. INT. CL. 28.
- FITNESS RX, INC., NORTH CANTON, OH:
3,310,902, PUB. 7-31-2007. INT. CL. 41.
- FITNESS4DIABETICS.COM LLC, NEW YORK, NY:
3,314,956, INT. CL. 41.
- FITOP MACHINERY CO., LTD., TAICHUNG, TAIWAN:
2,410,169, CANC. INT. CL. 7.
- FITZ & FLOYD, INC., LEWISVILLE, TX, VINEYARD GROUP, INC., THE, DALLAS, TX:
2,133,074, REN. 9-10-07. INT. CL. 4.
- FITZPATRICK BROS., INC., CHICAGO, IL:
3,311,625, PUB. 7-31-2007. INT. CL. 3.
- FIVE STAR FINE PRODUCTS, INC., PLAINVIEW, NY:
2,411,187, CANC. INT. CL. 33.
- FL FOOD LION, INC., SALISBURY, NC:
3,314,480, MULTIPLE CLASS, INT. CLS. 35 AND 44.
- FLAMEL TECHNOLOGIES, 69693 VENISSIEUX CEDEX, FRANCE:
2,409,856, CANC. MULTIPLE CLASS, INT. CLS. 1, 5 AND 10.
- FLANDERS, T. WILSON, SHELBURNE FALLS, MA:
3,311,767, PUB. 7-31-2007. INT. CL. 35.
- FLAT RATE RECRUITMENT PTY LTD, AUSTRALIA:
3,312,908, PUB. 7-31-2007. INT. CL. 35.
- FLECHA, DAVID C., TEMECULA, CA:
3,310,386, PUB. 7-31-2007. INT. CL. 28.

- FLEET FEET, INCORPORATED, CARRBORO, NC:
3,310,963, PUB. 7-31-2007. INT. CL. 35.
- FLEETCOR TECHNOLOGIES OPERATING COMPANY, LLC, NORCROSS, GA:
3,314,007, MULTIPLE CLASS, INT. CLS. 35, 36 AND 37.
3,314,008, MULTIPLE CLASS, INT. CLS. 35, 36 AND 37.
3,314,009, MULTIPLE CLASS, INT. CLS. 35, 36 AND 37.
- FLEETCOR TECHNOLOGIES, INC., NORCROSS, GA:
3,314,939, INT. CL. 35.
3,314,943, INT. CL. 35.
- FLEETPRIDE, INC., THE WOODLANDS, TX:
3,311,988, PUB. 7-31-2007. INT. CL. 12.
- FLEETWOOD ENTERPRISES, INC., RIVERSIDE, CA:
3,310,698, PUB. 6-12-2007. INT. CL. 12.
- FLEISCHACKER, STEPHEN J., CREAM RIDGE, NJ:
3,311,657, PUB. 7-31-2007. INT. CL. 42.
- FLESHWOUND FILMS, LLC, LA QUINTA, CA:
3,313,422, INT. CL. 9.
- FLESSAS, JULIE J., MEQUON, WI:
3,313,698, INT. CL. 9.
- FLETCHER, DAVID A., WASHINGTON, DC:
2,119,860, REN. 9-7-07. INT. CL. 41.
2,172,423, REN. 9-7-07. INT. CL. 41.
- FLEX MEMBRANE INTERNATIONAL CORP., LEESPORT, PA:
3,314,613, INT. CL. 19.
- FLEXSTEEL INDUSTRIES, INC., DUBUQUE, IA:
2,021,378, CANC. INT. CL. 9.
- FLINT INDUSTRIES, INC., TULSA, OK:
2,409,835, CANC. MULTIPLE CLASS, INT. CLS. 37 AND 42.
- FLIR SYSTEMS, INC., WILSONVILLE, OR:
3,313,758, INT. CL. 9.
- FLO'S DELICIOUS FOOD, INC., ALBUQUERQUE, NM:
2,409,906, CANC. MULTIPLE CLASS, INT. CLS. 29 AND 30.
- FLORAL PRODUCTS LTD, INC., CARLSBAD, CA:
2,411,216, CANC. INT. CL. 35.
- FLORATINE PRODUCTS GROUP, COLLIERVILLE, TN:
3,310,690, PUB. 7-31-2007. INT. CL. 1.
- FLOREMA YOUNG PLANTS B.V., NETHERLANDS:
3,312,836, PUB. 7-31-2007. INT. CL. 31.
- FLORES BANQUETS CORPORATION, FRESNO, CA:
3,311,395, PUB. 7-31-2007. INT. CL. 43.
- FLOREZ, STAN R., BONNEY LAKE, WA:
3,313,608, INT. CL. 32.
- FLORIDA ENGINEERED CONSTRUCTION PRODUCTS CORPORATION, TAMPA, FL:
3,310,507, PUB. 7-31-2007. INT. CL. 19.
- FLORIDA ORANGE GROVES, INC., SOUTH PASADENA, FL:
3,313,243, INT. CL. 33.
- FLORIDA TITLE ADVISORS, INC., HIALEAH, FL:
3,315,021, INT. CL. 36.
- FLOW TEK, INC., BOULDER, CO:
2,085,929, REN. 9-10-07. INT. CL. 28.
- FLOWCARDIA, INC., SUNNYVALE, CA:
3,313,198, INT. CL. 10.
- FLOWERS BAKERIES BRANDS, INC., WILMINGTON, DE:
3,311,672, PUB. 7-31-2007. INT. CL. 30.
- FLOWLINE INC., LOS ALAMITOS, CA:
2,411,132, CANC. INT. CL. 9.
- FLOWSERVE MANAGEMENT COMPANY, IRVING, TX, BORG-WARNER CORPORATION, CHICAGO, IL:
660,325, REN. 9-13-07. U.S. CL. 23 (INT. CL. 7).
- FLUID IMAGING TECHNOLOGIES, INC., EDGEComb, ME:
3,314,551, INT. CL. 9.
- FLUIDMASTER, INC., SAN JUAN CAPISTRANO, CA:
1,474,070, REN. 9-13-07. INT. CL. 11.
- FLY AWAY AGRIPRODUCTS, INC., BLUE EARTH, MN:
2,410,447, CANC. MULTIPLE CLASS, INT. CLS. 18 AND 19.
- FLYING MONKEY LLC, PHILADELPHIA, PA:
3,311,805, PUB. 7-31-2007. INT. CL. 30.
- FLÖTOTTO BRAND GMBH, FED REP GERMANY:
3,312,791, PUB. 7-31-2007. MULTIPLE CLASS, INT. CLS. 6, 11, 20, 21, 24 AND 27.
- FM BRUSH CO., INC., GLENDALE, NY:
2,020,929, CANC. INT. CL. 16.
- FMC CORPORATION, PHILADELPHIA, PA:
1,063,099, REN. 9-10-07. INT. CL. 5.
1,071,269, REN. 9-9-07. INT. CL. 5.
1,444,817, REN. 9-10-07. INT. CL. 5.
1,450,321, REN. 9-9-07. INT. CL. 5.
- FMR CORP., BOSTON, MA:
3,311,610, PUB. 7-31-2007. MULTIPLE CLASS, INT. CLS. 38 AND 42.
3,313,938, INT. CL. 35.
3,314,410, MULTIPLE CLASS, INT. CLS. 35 AND 36.
- FNF INTELLECTUAL PROPERTY HOLDINGS, INC., JACKSONVILLE, FL:
3,313,751, MULTIPLE CLASS, INT. CLS. 35, 36 AND 42.
- FOALPROOF EQUINE, LITTLETON, CO:
3,310,710, PUB. 7-31-2007. INT. CL. 5.
- FOCUS ON THE FAMILY, COLORADO SPRINGS, CO:
3,314,667, INT. CL. 9.
- FOH, INC., MIAMI, FL:
3,314,782, INT. CL. 21.
- FONA INTERNATIONAL INC., GENEVA, IL:
3,313,787, INT. CL. 41.
- FONAR CORPORATION, MELVILLE, NY:
3,313,385, INT. CL. 44.
- FONTLAB, LTD., MILLERSVILLE, MD:
2,170,992, REN. 9-13-07. INT. CL. 9.
- FOOD EQUIPMENT TECHNOLOGIES COMPANY, INC., LAKE ZURICH, IL:
3,313,638, INT. CL. 21.
- FOODTECH INTERNATIONAL, INC., NEW HAVEN, CT:
3,314,068, INT. CL. 29.
- FOOT LEVELERS, INC., ROANOKE, VA:
3,314,707, INT. CL. 9.
- FOOT LOCKER RETAIL, INC., NEW YORK, NY:
1,454,322, REN. 9-10-07. INT. CL. 25.
- FOOTSTAR CORPORATION, MAHWAH, NJ:
3,311,823, PUB. 7-31-2007. INT. CL. 25.
- FOR SALE BY INVESTOR, LLC, SALT LAKE CITY, UT:
3,315,022, INT. CL. 35.
- FORD AUDIO-VIDEO SYSTEMS, INC., OKLAHOMA CITY, OK:
3,310,592, PUB. 7-31-2007. INT. CL. 37.
- FORD GUM & MACHINE CO., INC., AKRON, NY:
3,314,820, INT. CL. 30.
- FORD MOTOR COMPANY, DEARBORN, MI:
2,086,125, REN. 9-7-07. INT. CL. 21.
2,088,473, REN. 9-7-07. INT. CL. 25.
2,088,654, REN. 9-13-07. INT. CL. 25.
3,310,542, PUB. 7-31-2007. MULTIPLE CLASS, INT. CLS. 6, 8, 12, 14, 16, 18, 20, 21, 25, 27, 28 AND 34.
- FOREST TRAVEL AGENCY, INC., AVENTURA, FL:
2,410,728, CANC. INT. CL. 39.
- FOREVER FLAWLESS, LLC, WHITESTONE, NY:
3,311,441, PUB. 7-31-2007. INT. CL. 35.
- FORMAN MILLS, INC., PENNSAUKEN, NJ:
3,313,405, INT. CL. 35.
- FORREST COUNTY GENERAL HOSPITAL, HATTIESBURG, MS:
2,410,016, CANC. MULTIPLE CLASS, INT. CLS. 35, 41 AND 42.
- FORT STORAGE, LLC, VIRGINIA BEACH, VA:
3,311,301, PUB. 7-31-2007. INT. CL. 39.
- FORTRESS HILL INDUSTRY LTD., RICHMOND, BC, CANADA:
3,313,054, INT. CL. 11.
- FORTRTERSS SYSTEMS LTD., WASHINGTON, DC:
3,311,440, PUB. 7-31-2007. INT. CL. 9.
- FOSS NIRSYSTEMS, INC., LAUREL, MD:
2,119,923, REN. 9-10-07. INT. CL. 42.
- FOSTER PARROTS, LTD., ROCKLAND, MA:
2,410,762, CANC. INT. CL. 42.
- FOUNDATION FOR GRIEVING CHILDREN, INC., NEW YORK, NY:
3,314,126, INT. CL. 36.
- FOUNTAINHEAD, INC., ATLANTA, GA:
2,428,475, CANC. INT. CL. 41.

- FOUR STAR INTERNATIONAL TRADING COMPANY, TAIPEI, TAIWAN:
2,410,785, CANC. INT. CL. 11.
- FOX & HOUND RESTAURANT GROUP, WICHITA, KS:
3,314,852, INT. CL. 32.
- FOX BAY BREWING COMPANY, INC., ST. CHARLES, IL:
2,411,208, CANC. INT. CL. 42.
- FOX FACTORY INC., WATSONVILLE, CA:
3,314,552, INT. CL. 12.
- FOX RACING, INC., MORGAN HILL, CA:
2,181,243, REN. 9-7-07. INT. CL. 25.
- FOX SPORTS NET, INC., LOS ANGELES, CA:
3,313,288, INT. CL. 38.
- FOX, JESSICA L, AUGUSTA, GA AND FOX, TRAVIS W, AUGUSTA, GA:
3,311,043, PUB. 7-31-2007. INT. CL. 44.
- FRANCE TELECOM, SOCIETE ANONYME, 75015 PARIS, FRANCE:
2,410,045, CANC. MULTIPLE CLASS, INT. CLS. 9, 35, 38, 41 AND 42.
- FRANCE, JOHN, MR., WESTLAKE, OH:
3,314,320, MULTIPLE CLASS, INT. CLS. 9 AND 38.
3,314,729, INT. CL. 38.
- FRANCIS-MUSTOE & COMPANY, BREA, CA:
3,310,506, PUB. 7-31-2007. MULTIPLE CLASS, INT. CLS. 35 AND 36.
- FRANCZEK, ROBERT A, CHICAGO, IL:
3,314,629, INT. CL. 25.
- FRANK A. SERIO & SONS, INC., JESSUP, MD:
1,419,370, CANC. INT. CL. 30.
- FRANK'S NURSERY & CRAFTS INC, TROY, MI:
2,021,296, CANC. INT. CL. 42.
- FRANKLIN RESOURCES, INC., SAN MATEO, CA:
3,313,337, INT. CL. 36.
- FRED DENNIS RENICK, HERMOSA BEACH, CA:
3,314,404, INT. CL. 9.
- FREDERIC MALLE CONSULTANTS, 75001 PARIS, FRANCE:
2,020,431, CANC. INT. CL. 3.
- FREE SPIRIT CHAPTER SOUTHEAST MICHIGAN, WHITMORE LAKE, MI:
3,314,415, U.S. CL. 200.
- FREEBURY, RUSSELL E., RANCHO DOMINGUEZ, CA:
3,310,806, PUB. 7-31-2007. INT. CL. 6.
- FREED DESIGNS INC., KENMORE, WA:
3,311,408, PUB. 7-31-2007. INT. CL. 13.
- FREEDOM COMMUNICATIONS, INC. DBA THE ORANGE COUNTY REGISTER, SANTA ANA, CA:
3,312,348, PUB. 7-31-2007. MULTIPLE CLASS, INT. CLS. 16 AND 41.
- FREEDOM FIRST CAPITAL, LLC, BETHESDA, MD:
3,313,424, INT. CL. 36.
- FREEMAN, ANNESHIA D., WYOMING, MI:
3,274,304, CANC. INT. CL. 41.
- FREEMAN, RAYMOND F., LOUDON, TN:
3,313,844, INT. CL. 9.
- FRENCH CREEK PROJECT, MEADVILLE, PA:
2,409,914, CANC. MULTIPLE CLASS, INT. CLS. 41 AND 42.
- FRESH EXPRESS INCORPORATED, SALINAS, CA:
3,310,719, PUB. 7-31-2007. INT. CL. 29.
- FRESH INTELLECTUAL PROPERTIES, INC., WILMINGTON, DE:
3,312,323, PUB. 7-31-2007. INT. CL. 28.
- FRESHNEX, INC., NEW HAVEN, CT:
2,410,661, CANC. MULTIPLE CLASS, INT. CLS. 35 AND 42.
2,410,662, CANC. MULTIPLE CLASS, INT. CLS. 35 AND 42.
- FRESHWAY FOOD SYSTEMS, INC., SIOUX FALLS, SD:
3,310,985, PUB. 7-31-2007. INT. CL. 43.
- FRESNO PACIFIC COLLEGE, FRESNO, CA:
2,021,101, CANC. INT. CL. 41.
2,021,103, CANC. INT. CL. 41.
- FREUDENBERG NONWOVENS LIMITED PARTNERSHIP, DURHAM, NC:
2,095,749, REN. 9-10-07. INT. CL. 24.
- FRIDAY GROUP, INC., THE, ANNAPOLIS, MD:
2,086,869, REN. 9-13-07. MULTIPLE CLASS, INT. CLS. 35 AND 41.
- FRIEDLINE, JASON T, OLATHE, KS:
3,310,842, PUB. 7-31-2007. INT. CL. 9.
- FRIEDMANN, ALEXANDER, ANTIOCH, TN:
3,313,465, INT. CL. 30.
- FRIENDS OF THE NATIONAL ZOO, WASHINGTON, DC:
1,419,262, CANC. INT. CL. 25.
- FRITO-LAY NORTH AMERICA, INC., PLANO, TX:
3,314,038, INT. CL. 30.
- FROBOSE, MARK, DANVILLE, IL:
3,310,622, PUB. 7-31-2007. INT. CL. 9.
- FROHLICH, SARA, BROOKLYN, NY:
3,314,966, INT. CL. 44.
- FROM A TO B INVESTMENTS, ANCHORAGE, AK:
3,313,199, INT. CL. 36.
- FSB ACQUISITION COMPANY, LLC, NORTH LAS VEGAS, NV:
3,312,157, PUB. 7-31-2007. INT. CL. 16.
- FUEL OUTDOOR LLC, NEW YORK, NY:
3,311,852, PUB. 7-31-2007. INT. CL. 35.
- FUJIAN TEA CORPORATION, LOS ANGELES, CA:
2,411,363, CANC. INT. CL. 30.
- FUJIFILM DIMATIX, INC., LEBANON, NH:
3,313,056, INT. CL. 7.
- FUJITSU COMPUTERS LIMITED, BRACKNELL BERSHIRE, RG12 M8SN, ENGLAND:
2,409,669, CANC. INT. CL. 9.
- FUJITSU TRANSACTION SOLUTIONS INC., FRISCO, TX:
3,310,347, PUB. 7-31-2007. INT. CL. 9.
- FULCRUM INDUSTRIES, INC., SACRAMENTO, CA:
3,313,094, MULTIPLE CLASS, INT. CLS. 8, 20 AND 35.
- FULLY IMMersed, INC., CHARLESTON, WV:
3,311,222, PUB. 7-31-2007. INT. CL. 41.
- FULTON OUTFITTERS, INC., BROOKLYN, NY:
3,311,460, PUB. 7-31-2007. INT. CL. 35.
- FUSION BRANDS INTERNATIONAL SRL, BELLEVILLE, ST. MICHAEL, BARBADOS:
3,311,824, PUB. 7-31-2007. INT. CL. 3.
- FUSION BRANDS INTERNATIONAL SRL, BELLEVILLE, ST., MICHAEL, BARBADOS:
3,313,907, INT. CL. 3.
- FUSION GOURMET, INC., GARDENA, CA:
3,310,443, PUB. 7-31-2007. INT. CL. 30.
- FUSION HARDWARE GROUP, INC., NORCROSS, GA:
3,312,397, PUB. 7-31-2007. MULTIPLE CLASS, INT. CLS. 6, 11 AND 21.
3,312,400, PUB. 7-31-2007. MULTIPLE CLASS, INT. CLS. 6, 11 AND 21.
- FUSION OFFICE INTEGRATION SYSTEMS, L.L.C., EDMOND, OK:
3,310,691, PUB. 7-31-2007. INT. CL. 9.
- FUSIONE S.R.L., POSTAL CODE 20155, MILANO, ITALY:
3,310,231, PUB. 7-17-2007. INT. CL. 33.
- FVC.COM, INC., SANTA CLARA, CA:
2,411,159, CANC. INT. CL. 9.
- F3, LLC, LA CANADA FLINTRIDGE, CA:
3,313,906, MULTIPLE CLASS, INT. CLS. 9 AND 41.
- G AND J GROSS, INC., BEVERLY HILLS, CA:
3,312,375, PUB. 7-31-2007. INT. CL. 35.
- G. LEIB ENTERPRISES, INC., OXNARD, CA, DBA LEIB RESEARCH:
1,418,904, CANC. INT. CL. 5.
- G.W. MEDICAL PUBLISHING, INC., ST. LOUIS, MO:
3,311,752, PUB. 7-31-2007. INT. CL. 16.
- G-UP CORPORATION, SAN JOSE, CA:
3,311,636, PUB. 7-31-2007. INT. CL. 32.
- GABBANELLI ACCORDIONS & IMPORTS, LLC, HOUSTON, TX:
3,314,928, INT. CL. 15.
- GABET, RENEE A., LIGONIER, IN:
3,313,020, INT. CL. 3.
- GABOR R. FASKERTY, MUNCHEN, FED REP GERMANY:
3,312,262, PUB. 7-31-2007. INT. CL. 9.
- GALLAGHER'S STEAKHOUSE-GRAND CENTRAL OYSTER BAR FRANCHISING, INC, GHENT, NY:
1,456,701, REN. 9-8-07. INT. CL. 30.

- GALLART, RENEE, NORTHVILLE, MI:
3,314,046, INT. CL. 35.
3,314,047, INT. CL. 35.
- GALLEGOS, JESUS, GUADALAJARA, MEXICO:
3,314,691, INT. CL. 42.
- GALLIANO MARINE SERVICE, LLC, GALLIANO, LA:
3,313,917, MULTIPLE CLASS, INT. CLS. 35 AND 39.
- GALPERIN, MICHAEL, ESCONDIDO, CA:
3,310,201, PUB. 7-31-2007. INT. CL. 44.
- GALT ALLOYS, INC., CANTON, OH:
2,410,187, CANC. MULTIPLE CLASS, INT. CLS. 6 AND 42.
2,410,194, CANC. MULTIPLE CLASS, INT. CLS. 6 AND 42.
- GAMAY FOODS, INC., NEW BERLIN, WI:
3,310,253, PUB. 7-31-2007. MULTIPLE CLASS, INT. CLS. 29 AND 30.
- GAMELOFT S.A., 75009 PARIS, FRANCE:
3,313,219, INT. CL. 9.
3,313,229, INT. CL. 9.
3,313,234, INT. CL. 9.
3,313,235, INT. CL. 9.
- GAMELOGIC INC., WALTHAM, MA:
3,313,707, INT. CL. 9.
- GAMMA PHI EPSILON, INC., SAN DIEGO, CA:
2,410,290, CANC. INT. CL. 42.
- GANTTHEAD.COM, INC., FAIRFAX, VA:
3,312,641, PUB. 7-31-2007. INT. CL. 41.
3,312,642, PUB. 7-31-2007. INT. CL. 41.
- GANZ BROTHERS, INC., BERGENFIELD, NJ:
2,410,735, CANC. INT. CL. 7.
- GARAVELLI ALDO SRL, VALENZA (AL), ITALY:
3,311,173, PUB. 7-31-2007. INT. CL. 14.
- GARCILAZO, MAURICIO MENDOZA, COSTA MESA, CA:
3,310,496, PUB. 7-31-2007. INT. CL. 9.
- GARDNER, KATE, BROOKLYN, NY:
3,310,899, PUB. 7-31-2007. INT. CL. 41.
- GARIBALDI, VERA, A, BELLEVUE, WA:
3,310,648, PUB. 7-31-2007. MULTIPLE CLASS, INT. CLS. 9 AND 41.
- GARRAND, MARGO A ; GARRAND, MICHAEL L, STEPHENS CITY, VA:
3,311,342, PUB. 7-31-2007. INT. CL. 12.
- GARRITY COMMUNICATIONS, INC., ITHACA, NY:
3,311,856, PUB. 7-31-2007. INT. CL. 16.
- GARVEY III, LLC, ST. HELENA, CA:
3,313,050, INT. CL. 33.
- GARZA, RAYNALDO, MONARCH BEACH, CA:
3,311,287, PUB. 7-31-2007. INT. CL. 35.
- GASPARI NUTRITION INC., LAKEWOOD, NJ:
3,313,348, INT. CL. 5.
- GATE FLEXOR, INC., DENVER, CO:
3,313,176, INT. CL. 12.
- GATES MANAGEMENT, INC., KANSAS CITY, MO:
2,105,496, REN. 9-12-07. INT. CL. 30.
- GATES S.A.S., LOUVRES, F-95380, FRANCE:
3,311,265, PUB. 7-31-2007. INT. CL. 7.
- GATOR CASES INC., TAMPA, FL:
3,314,987, INT. CL. 9.
- GATOR DOCK & MARINE ACQUISITION LLC, SANFORD, FL:
2,109,158, REN. 9-7-07. INT. CL. 6.
- GAUTAM, RAJESH, CHALFONT, PA:
3,311,569, PUB. 7-31-2007. INT. CL. 35.
- GC ORGANICS LLC, CEDAR CREEK, TX:
3,314,891, INT. CL. 31.
- GCI TECHNOLOGIES CORP., EDISON, NJ:
2,020,441, CANC. INT. CL. 9.
- GDH INTERNATIONAL, INC., ARLINGTON, TX:
2,411,274, CANC. INT. CL. 28.
- GE HEALTHCARE BIO-SCIENCES AB, UPPSALA, SWEDEN:
3,314,074, INT. CL. 9.
- GE HEALTHCARE LIMITED, UNITED KINGDOM:
3,312,921, PUB. 7-31-2007. MULTIPLE CLASS, INT. CLS. 5, 10 AND 44.
- GEARBOX SOFTWARE LLC, PLANO, TX:
3,313,095, INT. CL. 9.
- GEBRÜDER OBERMAIER OHG, FED REP GERMANY:
3,312,861, PUB. 7-31-2007. INT. CL. 28.
- GECKODRIVE, INC., SANTA ANA, CA:
3,310,240, PUB. 1-11-2005. INT. CL. 9.
- GEFRAN S.P.A., ITALY:
3,312,723, PUB. 7-31-2007. MULTIPLE CLASS, INT. CLS. 7, 9 AND 42.
- GEIER, WILLIAM A., MIDDLETOWN, NJ:
3,310,485, PUB. 7-31-2007. INT. CL. 44.
- GELD S.R.L., I-47900 RIMINI (RN), ITALY:
3,312,927, PUB. 7-31-2007. MULTIPLE CLASS, INT. CLS. 18 AND 25.
- GEM CERTIFICATION & ASSURANCE LAB, INC., NEW YORK, NY:
3,315,000, INT. CL. 42.
- GEM EQUITY CORP., LYNDHURST, OH:
3,312,682, PUB. 7-31-2007. INT. CL. 7.
- GEM SHAVINGS, LLC, AUBURN, WA:
2,103,540, REN. 9-7-07. INT. CL. 31.
- GEMINI INDUSTRIES, INC., CLIFTON, NJ:
2,021,156, CANC. INT. CL. 9.
- GEMOLOGICAL INSTITUTE OF AMERICA, INC., CARLSBAD, CA:
2,410,154, CANC. INT. CL. 42.
- GEMSTONE TECHNOLOGIES, INC., SOUTHAMPTON, NJ:
3,313,441, INT. CL. 41.
- GEN PLUS LLC, ENCINO, CA:
3,313,590, MULTIPLE CLASS, INT. CLS. 9, 35, 41 AND 45.
- GENECHECK, INC., FORT COLLINS, CO:
2,120,760, REN. 9-13-07. INT. CL. 1.
2,120,760, CANC. INT. CL. 42.
- GENERAL BINDING CORPORATION, LINCOLNSHIRE, IL:
3,313,821, INT. CL. 16.
- GENERAL CODE PUBLISHERS CORP., ROCHESTER, NY:
3,311,064, PUB. 7-31-2007. INT. CL. 9.
- GENERAL ELECTRIC COMPANY, SCHNECTADY, NY:
3,313,815, MULTIPLE CLASS, INT. CLS. 1, 5, 9 AND 10.
- GENERAL MAGIC, INC., SUNNYVALE, CA:
2,410,075, CANC. MULTIPLE CLASS, INT. CLS. 38 AND 42.
- GENERAL MILLS, INC., MINNEAPOLIS, MN:
3,310,843, PUB. 7-31-2007. INT. CL. 30.
3,310,844, PUB. 7-31-2007. INT. CL. 30.
3,313,318, INT. CL. 29.
- GENERAL MOTORS CORPORATION, DETROIT, MI:
2,411,361, CANC. INT. CL. 35.
- GENERAL NUTRITION INVESTMENT COMPANY, PITTSBURGH, PA:
2,411,213, CANC. INT. CL. 5.
2,411,381, CANC. INT. CL. 5.
- GENERAL VIDEOTEX CORPORATION, CAMBRIDGE, MA:
1,419,464, CANC. MULTIPLE CLASS, INT. CLS. 38 AND 42.
- GENESIS DIRECT, INC., SECAUCUS, NJ:
2,409,716, CANC. INT. CL. 35.
- GENESYS INTERIORS, LLC, ATLANTA, GA:
3,313,662, INT. CL. 27.
3,313,852, INT. CL. 27.
- GENETIC TESTING INSTITUTE, INC., WAUKESHA, WI:
3,310,715, PUB. 7-31-2007. INT. CL. 5.
- GENETICA DNA LABORATORIES, INC., CINCINNATI, OH:
2,092,048, REN. 9-10-07. INT. CL. 42.
- GENEXUS INTERNATIONAL, INC., INGLEWOOD, CA:
3,313,177, INT. CL. 25.
- GENIA LLC, MILLSBORO, DE:
3,312,505, PUB. 7-31-2007. INT. CL. 18.
- GENMAB A/S, DENMARK:
3,312,952, PUB. 7-31-2007. MULTIPLE CLASS, INT. CLS. 1, 5 AND 42.
- GENNUM CORPORATION, BURLINGTON, ONTARIO, CANADA:
3,311,643, PUB. 3-27-2007. INT. CL. 9.
- GENO TECHNOLOGY, INC., MARYLAND HEIGHTS, MO:
3,311,781, PUB. 7-31-2007. MULTIPLE CLASS, INT. CLS. 1 AND 16.
- GENUINE NUTRITION, INC., MONTGOMERYVILLE, PA:
2,409,965, CANC. INT. CL. 35.

- GENWORTH FINANCIAL, INC., RICHMOND, VA:
3,313,321, INT. CL. 36.
- GEO CENTURY, HOUSTON, TX:
3,311,136, PUB. 7-31-2007. INT. CL. 42.
3,311,138, PUB. 7-31-2007. INT. CL. 42.
- GEOBRA BRANDSTÄTTER GMBH & CO. KG, FED REP GERMANY:
3,312,862, PUB. 7-31-2007. MULTIPLE CLASS, INT. CLS. 11 AND 21.
- GEORGE LITTLE MANAGEMENT, INC., WHITE PLAINS, NY:
2,410,566, CANC. INT. CL. 35.
- GEORGE M. RAYMOND CO., ORANGE, CA:
2,020,452, CANC. MULTIPLE CLASS, INT. CLS. 37 AND 42.
- GEORGE TOWNSEND & CO., INC., OKLAHOMA CITY, OK:
3,312,310, PUB. 7-31-2007. INT. CL. 5.
- GEORGETOWN RESTORATION, INC., WASHINGTON, DC:
2,410,690, CANC. INT. CL. 37.
- GEORGIA AGRIBUSINESS COUNCIL, INC., COMMERCE, GA:
2,083,184, REN. 9-12-07. MULTIPLE CLASS, INT. CLS. 36 AND 42.
2,083,185, REN. 9-12-07. MULTIPLE CLASS, INT. CLS. 36 AND 42.
- GEORGIA ALLIANCE OF COMMUNITY HOSPITALS, INC., TIFTON, GA:
2,162,819, REN. 9-13-07. INT. CL. 42.
- GEORGIA ASSOCIATION OF REALTORS, INC., ATLANTA, GA:
3,310,618, PUB. 7-31-2007. MULTIPLE CLASS, INT. CLS. 16, 35 AND 41.
- GEORGIA CAPITAL PARTNERS, INC., ATLANTA, GA:
2,411,060, CANC. INT. CL. 36.
- GEORGIA POWER COMPANY, ATLANTA, GA:
3,310,455, PUB. 7-31-2007. INT. CL. 35.
- GEORGIA-PACIFIC CONSUMER PRODUCTS LP, ATLANTA, GA:
3,311,661, PUB. 7-31-2007. INT. CL. 16.
- GEORGIA-PACIFIC CORPORATION, ATLANTA, GA:
1,500,510, REN. 9-8-07. INT. CL. 16.
- GEPE PRODUKTE AG, 6304 ZUG, SWITZERLAND:
1,461,736, REN. 9-9-07. INT. CL. 9.
- GERARD YOSCA ACCESSORIES, INC., NEW YORK, NY:
2,410,354, CANC. INT. CL. 25.
- GESTION PREMIERE MOISSON INC., DORION, QUEBEC, CANADA:
2,474,771, CANC. MULTIPLE CLASS, INT. CLS. 31, 35 AND 42.
- GFA DU CHATEAU L'ARROSEE; (GROUPEMENT FONCIER AGRICOLE), FRANCE:
3,312,811, PUB. 7-31-2007. INT. CL. 33.
- GHADA MUASHER, HOUSTON, TX:
2,409,892, CANC. INT. CL. 25.
- GHANIMOGHADAM, SAEED, THORNHILL, ONTARIO, CANADA:
3,313,082, INT. CL. 35.
- GHERMEZIAN, MARK, LAS VEGAS, NV:
3,311,637, PUB. 7-31-2007. INT. CL. 35.
- GHIDINI CIPRIANO S.P.A., BRESCIA, ITALY:
3,312,237, PUB. 7-31-2007. MULTIPLE CLASS, INT. CLS. 8 AND 21.
- GHR SYSTEMS, INC., WAYNE, PA:
2,411,162, CANC. INT. CL. 9.
- GIALO, MARK, BASKING RIDGE, NJ:
3,313,843, INT. CL. 9.
- GIANFRANCO FENIZIA, ITALY AND ALBINO D'AMATO, ITALY:
3,312,786, PUB. 4-10-2007. MULTIPLE CLASS, INT. CLS. 3, 18 AND 25.
- GIANT MEDIA LLC, BARRINGTON, IL:
3,311,907, PUB. 4-10-2007. INT. CL. 36.
- GIBBENS, HARRY C., JR., PROVO, UT, DBA THE DEAFWORKS, CO.:
2,409,957, CANC. INT. CL. 9.
- GIBBS, A. ROGER, GREENSBORO, NC:
3,310,879, PUB. 7-31-2007. INT. CL. 28.
- GIESECKE & DEVRIENT GMBH, FED REP GERMANY:
3,312,870, PUB. 7-31-2007. INT. CL. 9.
- GIFT CERTIFICATE CENTER, INC., MINNEAPOLIS, MN:
3,313,582, INT. CL. 35.
- GIFTONLINE, INC., ROCKVILLE, MD:
2,410,649, CANC. INT. CL. 35.
- GIGACRATE LLC, AUSTIN, TX:
3,310,972, PUB. 7-31-2007. INT. CL. 35.
- GIGAVAC LLC, CARPINTERIA, CA:
3,213,128, COR. INT. CL. 9.
- GIGGLING TOYS, LLC, HOUSTON, TX:
3,310,925, PUB. 7-31-2007. INT. CL. 35.
- GIGIESSE GROUP S.P.A., ITALY:
3,312,975, PUB. 7-31-2007. INT. CL. 25.
- GILBARCO INC., GREENSBORO, NC:
3,313,516, INT. CL. 9.
- GILLI S.R.L., ITALY:
3,312,722, PUB. 4-24-2007. MULTIPLE CLASS, INT. CLS. 9, 14, 18 AND 25.
- GILSON COMPANY, INC., COLUMBUS, OH:
3,312,528, PUB. 7-31-2007. INT. CL. 9.
- GIMMY LEE COMPANY S.R.L., MONTEBELLUNA (TREVISO), ITALY:
2,409,711, CANC. MULTIPLE CLASS, INT. CLS. 18 AND 25.
- GINKANA, S.A., VIZCAYA, SPAIN:
3,312,664, PUB. 7-31-2007. INT. CL. 25.
- GINO GREEN INC., NEW YORK, NY:
3,311,116, PUB. 7-31-2007. INT. CL. 25.
- GINSBURG, MARK, NEW YORK, NY:
2,073,786, REN. 9-10-07. INT. CL. 29.
2,073,787, REN. 9-10-07. INT. CL. 29.
2,073,788, REN. 9-10-07. INT. CL. 29.
- GIOVANNITTI, INC., YONKERS, NY:
3,311,816, PUB. 7-31-2007. MULTIPLE CLASS, INT. CLS. 6, 19, 40 AND 42.
- GITTENS, GARY A., JAMAICA, NY:
3,313,367, MULTIPLE CLASS, INT. CLS. 14, 35 AND 40.
- GITTER'S CARD GALLERY, INC., NEW YORK, NY TO GITTER ANAPOL & GLAZER COMMUNICATIONS, INC., NEW YORK, NY:
2,020,213, CANC. INT. CL. 35.
- GL DIABETES INC., ST-LAURENT, QUEBEC H4S 1S3, CANADA:
3,313,069, INT. CL. 5.
- GLAAZART USA INC., CHICAGO, IL:
2,410,964, CANC. INT. CL. 19.
- GLACIA NOVA, LLC, AUBURN, WA:
3,311,882, PUB. 7-31-2007. INT. CL. 32.
- GLASKOCH GLASHUETTEN -NIEDERLAGE B. KOCH JUN. GMBH & CO., D-33014 BAD DRIBURG, FED REP GERMANY:
2,409,982, CANC. MULTIPLE CLASS, INT. CLS. 3, 8, 11, 21 AND 28.
- GLASSTECH, INC., PERRYSBURG, OH:
1,077,745, REN. 9-11-07. INT. CL. 7.
- GLATTHAR, JOHN NELSON, CLIFF, NM:
3,311,568, PUB. 7-31-2007. INT. CL. 41.
- GLAXO WELLCOME INC., RESEARCH TRIANGLE PARK, NC:
2,410,799, CANC. INT. CL. 42.
- GLISSEN CHEMICAL COMPANY, INC., BROOKLYN, NY:
2,020,980, CANC. INT. CL. 3.
- GLOBAL FOODS INNOVATIONS, INC, CINCINNATI, OH:
3,312,056, PUB. 7-31-2007. INT. CL. 29.
- GLOBAL INTERFACE SOLUTIONS, INC., TULSA, OK:
2,410,411, CANC. INT. CL. 9.
- GLOBAL POLLUTION CONTROL, INC., MCKINNEY, TX:
2,411,365, CANC. INT. CL. 40.
- GLOBAL SECOND LANGUAGE, INC., SAN RAMON, CA:
3,313,896, MULTIPLE CLASS, INT. CLS. 35 AND 41.
- GLOBAL SOURCE MANAGEMENT & CONSULTING, INC., SUNRISE, FL:
2,021,160, CANC. INT. CL. 5.
- GLOBAL STRATEGIES, INC., SOUTH BOSTON, MA:
3,310,384, PUB. 7-31-2007. INT. CL. 22.
- GLOBAL TEL*LINK CORPORATION, MOBILE, AL:
3,312,666, PUB. 7-31-2007. INT. CL. 45.

- GLOBAL WASHERS LLC, SAN ANTONIO, TX:
3,314,632, INT. CL. 28.
- GLOBE HOLDING COMPANY, LLC, PITTSFIELD, NH:
3,310,678, PUB. 7-31-2007. INT. CL. 9.
- GLORY FOODS, INC., COLUMBUS, OH:
3,313,105, INT. CL. 29.
- GLOVER HOMES, INC., LYNNWOOD, WA:
3,311,065, PUB. 7-31-2007. INT. CL. 37.
- GLU MOBILE, INC., SAN MATEO, CA:
3,314,993, MULTIPLE CLASS, INT. CLS. 9 AND 41.
- GLYNLYON, INC., CHANDLER, AZ:
3,312,496, PUB. 7-31-2007. INT. CL. 9.
- GLÖCKL, JOSEF, FED REP GERMANY:
3,312,913, PUB. 7-31-2007. MULTIPLE CLASS, INT. CLS. 10 AND 20.
- GMAC MORTGAGE LLC, WILMINGTON, DE:
3,314,584, INT. CL. 36.
- GMG SOLUTIONS, LLC, CHADDS FORD, PA:
3,311,229, PUB. 7-31-2007. INT. CL. 42.
- GNITETSKIY, PAVEL V, NEW YORK, NY:
3,311,593, PUB. 7-31-2007. INT. CL. 35.
- GNLV CORP., LAS VEGAS, NV:
3,313,265, INT. CL. 41.
- GO LOW, LLC, PALATINE, IL:
3,312,342, PUB. 7-31-2007. INT. CL. 41.
- GOBACKTV, INC., MENLO PARK, CA:
3,310,285, PUB. 7-31-2007. INT. CL. 9.
- GODIVA BRANDS, INC., NEWARK, DE:
3,313,541, INT. CL. 30.
3,313,542, INT. CL. 30.
- GOETZE'S CANDY COMPANY, INC., BALTIMORE, MD:
1,492,478. REN. 9-13-07. INT. CL. 30.
- GOLD CANYON CANDLES, L.L.C., CHANDLER, AZ:
3,310,727, PUB. 7-31-2007. INT. CL. 4.
- GOLD KEYS DISTRIBUTION, CHAMBERSBURG, PA:
3,311,278, PUB. 7-31-2007. INT. CL. 35.
- GOLD MEDAL REHAB AND FITNESS, INC., ST. LOUIS, MO:
2,410,435, CANC. INT. CL. 42.
- GOLD, JEFFREY B., BELLMORE, NY:
2,411,411, CANC. INT. CL. 42.
- GOLDEN MARDI GRAS, INC., LAS VEGAS, NV:
3,312,014, PUB. 7-31-2007. INT. CL. 41.
- GOLDEN PRIDE, INC., WEST PALM BEACH, FL:
2,410,590, CANC. INT. CL. 5.
2,410,591, CANC. INT. CL. 5.
- GOLDEN PRODUCTION, INC., CARY, NC:
3,310,606, PUB. 7-31-2007. INT. CL. 41.
- GOLDEN TEAM SPORT GMBH & CO. KG, FED REP GERMANY:
3,312,716, PUB. 7-31-2007. MULTIPLE CLASS, INT. CLS. 12, 18, 22, 25 AND 28.
- GOLDSCHMIDT GMBH, 45127 ESSEN, FED REP GERMANY, TH. GOLDSCHMIDT AG, D-45127 ESSEN, FED REP GERMANY:
2,091,056. REN. 9-13-07. INT. CL. 1.
- GOLF INNOVATIONS, LLC, CORDOVA, TN:
3,314,271, INT. CL. 28.
- GONÇALO AIRES DE SÁ DA BANDEIRA, PORTUGAL:
3,312,841, PUB. 7-31-2007. INT. CL. 33.
- GONE TO THE DOGS, INC., FAIRVIEW PARK, OH:
3,313,936, INT. CL. 35.
- GONZALEZ DIAZ, ENRIQUE A., LAREDO, TX, DBA M.A. PRODUCTIONS/POLLYMOOD RECORDS:
3,311,464, PUB. 7-31-2007. MULTIPLE CLASS, INT. CLS. 9 AND 41.
- GOOD CHARMA INC., GREAT BARRINGTON, MA:
3,310,314, PUB. 7-31-2007. INT. CL. 14.
- GOOD STUFF, LLC, LONG ISLAND, NY:
2,411,403, CANC. INT. CL. 28.
- GOODE, INC., CARSON CITY, NV:
3,312,051, PUB. 7-31-2007. INT. CL. 5.
- GOODWAY PLASTIC PRODUCTS LIMITED, KWUN TONG, KOWLOON, HONG KONG:
3,313,109, MULTIPLE CLASS, INT. CLS. 7 AND 21.
- GOODWILL INDUSTRIES INTERNATIONAL, INC., ROCKVILLE, MD:
3,313,683, INT. CL. 35.
- GOODWOOD ESTATE COMPANY LIMITED, THE, WEST SUSSEX OP10 0PX, ENGLAND:
3,310,204, PUB. 4-17-2007. MULTIPLE CLASS, INT. CLS. 3, 4, 6, 9, 12, 14, 16, 18, 25, 26, 28, 35, 37, 41 AND 42.
- GOODY PRODUCTS, INC, PEACHTREE CITY, GA:
2,411,499, CANC. INT. CL. 9.
- GOODYEAR TIRE & RUBBER COMPANY, THE, AKRON, OH:
835,115. REN. 9-7-07. U.S. CL. 35 (INT. CL. 12).
- GORILLA GLUE COMPANY, THE, CINCINNATI, OH:
3,313,278, MULTIPLE CLASS, INT. CLS. 1, 16 AND 17.
- GORILLA SKINZ, LAS VEGAS, NV:
2,411,039, CANC. INT. CL. 25.
- GORSTEW LIMITED, KINGSTON 10, ST. ANDREW, JAMAICA:
3,311,825, PUB. 7-31-2007. MULTIPLE CLASS, INT. CLS. 39 AND 43.
- GOSUB 60, INC., SANTA MONICA, CA:
3,312,100, PUB. 7-31-2007. INT. CL. 9.
3,312,101, PUB. 7-31-2007. INT. CL. 9.
- GOTCODERS, INC., NORTH CALDWELL, NJ:
3,311,461, PUB. 7-31-2007. INT. CL. 42.
- GOUDA, INC., NEW YORK, NY:
3,314,264, INT. CL. 25.
- GOVANTRA, INC., ROSEVILLE, CA:
3,311,263, PUB. 7-31-2007. INT. CL. 35.
- GOVERNMENT EMPLOYEES INSURANCE COMPANY, WASHINGTON, DC:
3,314,725, INT. CL. 36.
- GRACE HILL SETTLEMENT HOUSE, ST. LOUIS, MO:
3,312,554, PUB. 7-31-2007. INT. CL. 45.
- GRACE MUSIC INCORPORATION, GARDEN GROVE, CA:
3,311,169, PUB. 7-31-2007. INT. CL. 15.
- GRAHAM WEBB INTERNATIONAL LIMITED PARTNERSHIP, CARLSBAD, CA:
2,410,056, CANC. INT. CL. 3.
- GRAHAM-WHITE MANUFACTURING CO., SALEM, VA:
3,312,486, PUB. 7-31-2007. INT. CL. 9.
3,312,487, PUB. 7-31-2007. INT. CL. 7.
- GRAHAM, STEPHEN J., LEMONT, IL:
3,314,644, INT. CL. 44.
- GRAND HALL ENTERPRISE CO., LTD., TAIPEI CITY, TAIWAN:
3,312,509, PUB. 7-31-2007. INT. CL. 11.
- GRAND RESORT PROPERTIES, LLC, OMAHA, NE:
3,310,315, PUB. 7-31-2007. MULTIPLE CLASS, INT. CLS. 35, 36 AND 37.
3,310,316, PUB. 7-31-2007. MULTIPLE CLASS, INT. CLS. 35, 36 AND 37.
- GRAND TRAVERSE RESORT AND SPA, LLC, ACME, MI:
3,312,121, PUB. 7-31-2007. MULTIPLE CLASS, INT. CLS. 35 AND 41.
- GRANT FOREST PRODUCTS INC., MISSISSAUGA, ONTARIO, CANADA:
3,313,354, INT. CL. 19.
- GRANT HUFFMAN, LP, DALLAS, TX:
3,311,448, PUB. 7-31-2007. INT. CL. 37.
- GRANT PRODUCTS, INC., GLENDALE, CA:
1,419,114, CANC. INT. CL. 12.
- GRANTHAM EDUCATION CORPORATION, SLIDELL, LA:
3,313,086, INT. CL. 41.
- GRAPHIC INFORMATION SYSTEMS, INC., WILSONVILLE, OR:
3,312,126, PUB. 7-31-2007. MULTIPLE CLASS, INT. CLS. 19, 20 AND 35.
3,312,128, PUB. 7-31-2007. MULTIPLE CLASS, INT. CLS. 19, 20 AND 35.
3,312,129, PUB. 7-31-2007. MULTIPLE CLASS, INT. CLS. 19, 20 AND 35.
- GRAVES SPRAY SUPPLY, INC., CLEARWATER, FL:
3,314,844, INT. CL. 7.
- GRAVITY LOCK SYSTEMS, INC., HOUSTON, TX:
2,167,988. REN. 9-13-07. INT. CL. 6.
- GRAVITY TECHNOLOGIES, SAN FRANCISCO, CA:
3,313,217, INT. CL. 42.
- GREAT AMERICAN INSURANCE CO., CINCINNATI, OH:
3,313,654, INT. CL. 9.

- GREAT AMERICAN LIFE INSURANCE COMPANY, CINCINNATI, OH:
2,020,788, CANC. INT. CL. 36.
- GREAT AMERICAN PRODUCTS, DESTIN, FL:
3,313,151, INT. CL. 5.
- GREAT LAKES ORTHODONTICS LTD., TONAWANDA, NY:
2,093,455, REN. 9-11-07. INT. CL. 10.
- GREAT LAKES PUBLISHING CO., CLEVELAND, OH:
3,314,639, INT. CL. 16.
- GREAT WESTERN CHEMICAL COMPANY, PORTLAND, OR:
2,411,551, CANC. INT. CL. 35.
- GREATER DES MOINES COMMUNITY FOUNDATION, DES MOINES, IA:
3,313,557, INT. CL. 35.
- GREATER KANSAS CITY SPORTS FOUNDATION, THE, KANSAS CITY, MO:
3,314,829, INT. CL. 36.
- GREATER MINNEAPOLIS CONVENTION & VISITORS ASSOCIATION, MINNEAPOLIS, MN:
3,314,525, INT. CL. 35.
- GREEN FROG MARKET BERNARD, LLC, BAKERSFIELD, CA:
3,310,703, PUB. 7-31-2007. INT. CL. 30.
- GREEN HOUSE NETWORK, LAKE OSWEGO, OR:
3,311,447, PUB. 7-31-2007. INT. CL. 35.
- GREEN LIGHT MOTORWORKS, INC., WILMETTE, IL:
2,410,797, CANC. INT. CL. 42.
- GREEN MOUNTAIN COFFEE ROASTERS, INC., WATERBURY, VT:
3,311,729, PUB. 7-4-2006. INT. CL. 32.
- GREEN, MINDY L., GLEN BURNIE, MD:
3,311,193, PUB. 7-31-2007. INT. CL. 44.
- GREENBERG, AMIE S., COVINA, CA:
2,410,522, CANC. MULTIPLE CLASS, INT. CLS. 25 AND 28.
- GREENE PLASTICS CORPORATION, HOPE VALLEY, RI:
3,313,110, INT. CL. 28.
- GREENE, SHAWN, SAN PABLO, CA:
2,410,516, CANC. INT. CL. 41.
- GREENVILLE PUBLISHING COMPANY, LLC., GREENEVILLE, TN:
3,310,688, PUB. 7-31-2007. INT. CL. 41.
- GREENLEAF NURSERY COMPANY, PARK HILL, OK:
2,145,477, REN. 9-7-07. INT. CL. 31.
- GREENLIGHT REINSURANCE, LTD., GRAND CAYMAN, CAYMAN ISLANDS:
3,313,807, INT. CL. 36.
- GREENLINE FOODS, INC., BOWLING GREEN, OH, TOLEDO ARMATURE WORKS, INC., BOWLING GREEN, OH, DBA T.A.W., INC.:
1,460,274, REN. 9-11-07. INT. CL. 31.
- GREENWAY PLASTICS INDUSTRY CORPORATION, WAYNE, NJ:
2,410,681, CANC. INT. CL. 21.
- GREENWICH VILLAGE ENTERTAINMENT GROUP LLC, NEW YORK, NY:
3,314,738, INT. CL. 43.
- GREP, SANTA CLARA, CA:
2,409,907, CANC. INT. CL. 25.
- GREYHAWK SERVICES, LLC, BRENTWOOD, TN:
3,310,700, PUB. 7-31-2007. INT. CL. 37.
- GRGICH HILLS CELLAR, RUTHERFORD, CA:
3,314,735, INT. CL. 33.
- GRIEF RECOVERY INSTITUTE, LLC, THE, SHERMAN OAKS, CA:
2,478,750, CANC. MULTIPLE CLASS, INT. CLS. 9 AND 16.
- GRIFFIN TECHNOLOGY, INC., NASHVILLE, TN:
3,310,415, PUB. 7-10-2007. INT. CL. 9.
3,313,112, INT. CL. 9.
- GRIFFIN, COURTNEY F., FRESNO, CA AND GRIFFIN, TINA R., FRESNO, CA:
3,310,382, PUB. 7-31-2007. INT. CL. 25.
- GRIFFITH INC, HUNTINGDON VALLEY, PA, TA ALPHA SYSTEMS:
3,311,120, PUB. 7-31-2007. INT. CL. 42.
- GRIFFITH INC T/A ALPHA SYSTEMS, HUNTINGDON VALLEY, PA:
3,311,119, PUB. 7-31-2007. INT. CL. 9.
- GRIMAC ROYAL FALCON CORP., SETAUKET, NY:
3,310,659, PUB. 7-31-2007. INT. CL. 35.
- GRIMES JR., CHARLES O., INGLEWOOD, CA:
3,312,118, PUB. 7-31-2007. INT. CL. 41.
- GRIZZA, LLC, PRINCETON, NJ:
3,313,977, INT. CL. 43.
- GROBAL, L.L.C., CHANDLER, AZ:
3,314,223, INT. CL. 21.
- GROMMETTE, LTD., NEWPORT, RI:
2,410,386, CANC. INT. CL. 25.
- GROSSBERG, JEFFREY, CHICAGO, IL:
3,314,754, MULTIPLE CLASS, INT. CLS. 36 AND 37.
- GROSSE POINTE GROUP, LLC, WESTPORT, CT:
3,312,436, PUB. 7-31-2007. INT. CL. 9.
- GROSSMAN, MATTHEW R., GEORGETOWN, IN:
2,410,238, CANC. INT. CL. 37.
- GROUP LOTUS, PLC, NORFOLK, UNITED KINGDOM:
3,313,392, INT. CL. 3.
- GROUP PLAN CLINIC, INC., HOUSTON, TX:
1,419,535, CANC. INT. CL. 42.
- GROUP PLAN CLINIC, INC., HOUSTON, TX, DBA NEW SPIRIT:
1,419,545, CANC. INT. CL. 42.
- GROUP USA, INC., SECAUCUS, NJ:
3,313,027, INT. CL. 25.
- GROUP 4 SECURITAS (INTERNATIONAL) B.V., 2585 HJ THE HAGUE, NETHERLANDS:
2,409,666, CANC. MULTIPLE CLASS, INT. CLS. 39 AND 42.
- GROUPE VERRIER NOVATECH INC./NOVATECH GLASS GROUP INC., STE-JULIE, QUEBEC, CANADA:
3,311,714, PUB. 7-31-2007. INT. CL. 6.
- GROVE REALTY, LLC, GLASTONBURY, CT, GROVE PROPERTY SERVICES, L.P., HARTFORD, CT:
2,086,000, REN. 9-11-07. INT. CL. 36.
- GROWMARK, INC., BLOOMINGTON, IL:
2,410,177, CANC. INT. CL. 39.
3,311,228, PUB. 7-31-2007. INT. CL. 44.
3,311,241, PUB. 7-31-2007. INT. CL. 44.
- GROWTH PRODUCTS, WHITE PLAINS, NY:
1,459,763, REN. 9-7-07. INT. CL. 1.
- GRUPO FUN & BASICS, S.A., SPAIN:
3,312,876, PUB. 7-31-2007. MULTIPLE CLASS, INT. CLS. 3, 9, 14, 16, 18, 24, 25 AND 35.
- GRUSIN, DON, CALABASAS, CA:
2,409,999, CANC. INT. CL. 41.
- GRYGOROVYCH, SERGIY, KYIV 04211, UKRAINE:
3,313,064, INT. CL. 41.
3,313,065, INT. CL. 9.
- GTE PRODUCTS CORPORATION, STAMFORD, CT:
1,419,091, CANC. INT. CL. 11.
- GTE WIRELESS SERVICE CORPORATION, ALPHARETTA, GA:
2,411,082, CANC. INT. CL. 36.
- GTN, INC., OK PARK, MI:
3,311,724, PUB. 7-31-2007. INT. CL. 41.
- GTT INTERNATIONAL, INC, RIVERSIDE, CA:
3,312,068, PUB. 2-20-2007. INT. CL. 24.
- GUALANDI, ALESSANDRO, NEW YORK, NY:
2,099,299, REN. 9-9-07. MULTIPLE CLASS, INT. CLS. 30 AND 42.
2,099,299, CANC. INT. CL. 29.
- GUANGZHOU FAIRLAND ELECTRIC CO., LTD., CHINA:
3,312,887, PUB. 7-31-2007. INT. CL. 11.
- GUARDIAN ELECTRIC MANUFACTURING CO., WOODSTOCK, IL, GUARDIAN ELECTRIC MANUFACTURING CO., CHICAGO, IL:
349,228, REN. 9-13-07. U.S. CL. 21 (INT. CL. 9).
- GUARDIAN ELECTRIC MANUFACTURING COMPANY, THE, WOODSTOCK, IL:
1,448,307, REN. 9-13-07. INT. CL. 9.

- GUELLA, CHRIS, CHARLOTTE, NC:
 2,410,620, CANC. INT. CL. 28.
- GUERLAIN S.A., 75008 PARIS, FRANCE:
 3,312,061, PUB. 7-31-2007. INT. CL. 3.
- GUERRA, DANIEL, TYLER, TX:
 3,310,771, PUB. 6-26-2007. INT. CL. 35.
- GUERRIER, LAURENT, NEW YORK, NY:
 3,312,364, PUB. 7-31-2007. INT. CL. 35.
- GUIDANT FINANCIAL GROUP, INC, BELLEVUE, WA:
 3,314,115, INT. CL. 36.
- GUIDANT FINANCIAL GROUP, INC., BELLEVUE, WA:
 3,313,943, INT. CL. 36.
 3,313,944, INT. CL. 36.
- GUITAR CENTER, INC., WESTLAKE VILLAGE, CA:
 3,314,673, INT. CL. 9.
- GULF FASTENER, INC., MOBILE, AL:
 3,312,579, PUB. 7-31-2007. INT. CL. 6.
- GULF PACIFIC, INC., HOUSTON, TX:
 2,103,377, REN. 9-10-07. INT. CL. 30.
 3,314,334, MULTIPLE CLASS, INT. CLS. 29, 30 AND 31.
- GULISTAN CARPET INC., ABERDEEN, NC:
 2,409,946, CANC. INT. CL. 35.
- GUMLINK A/S, VEJLE, DENMARK:
 3,313,959, INT. CL. 30.
 3,313,960, INT. CL. 30.
- GUPPY GAMES INC., BELLEVUE, WA:
 3,313,756, INT. CL. 9.
- GUPTA, LAXMI C, LOS ALAMITOS, CA:
 3,311,491, PUB. 7-31-2007. INT. CL. 2.
 3,311,533, PUB. 7-31-2007. INT. CL. 2.
- GUST GALLUCCI COMPANY, CLEVELAND, OH:
 2,410,458, CANC. INT. CL. 35.
- GUTH LIGHTING SYSTEMS, INC., ST. LOUIS, MO:
 1,419,095, CANC. INT. CL. 11.
- GUTHRIE, ARLO D., PITTSFIELD, MA:
 3,314,681, INT. CL. 30.
- GUTHRIE, JANICE M., SOUTHFIELD, MI:
 3,313,909, MULTIPLE CLASS, INT. CLS. 21 AND 25.
- GUTHY-RENKER CORPORATION, PALM DESERT, CA:
 2,411,075, CANC. INT. CL. 10.
 3,313,420, INT. CL. 5.
 3,314,249, INT. CL. 9.
- GUTIERREZ, ROBERT, RIVERSIDE, CA:
 3,311,981, PUB. 7-31-2007. INT. CL. 41.
- GUTMANN CUTLERY, INC., MOUNT VERNON, NY:
 1,418,964, CANC. INT. CL. 8.
- GUTMANN CUTLERY, INC., BELLINGHAM, WA:
 2,411,407, CANC. INT. CL. 9.
 2,411,408, CANC. INT. CL. 9.
- GUYTECH USA, INC., HILLSDALE, NY:
 3,313,613, INT. CL. 42.
- GVI SECURITY, INC., CARROLLTON, TX:
 3,311,987, PUB. 7-31-2007. INT. CL. 9.
- GWALTNEY, MARY LOU, BROOMFIELD, CO:
 2,409,869, CANC. INT. CL. 18.
- GÜNTER HOLZNER, CH-1212 GRAND-LANCY, SWITZERLAND:
 3,312,761, PUB. 7-31-2007. INT. CL. 18.
- H R INDUSTRIES, INC., LOS ANGELES, CA:
 2,409,852, CANC. INT. CL. 41.
- H. D. HUDSON MANUFACTURING COMPANY, CHICAGO, IL:
 842,813, REN. 9-13-07. U.S. CL. 23 (INT. CLS. 6, 7, 8, 9, 11, 12, 16, 21 AND 28).
- H. D. LEE COMPANY, INC., THE, WILMINGTON, DE:
 2,410,676, CANC. INT. CL. 25.
- H.C. BRILL COMPANY, INC., TUCKER, GA:
 2,035,254, REN. 9-7-07. INT. CL. 29.
- H.W. CARTER'S & SONS, INC., DEAL, NJ:
 2,088,406, REN. 9-10-07. INT. CL. 25.
- H&R BLOCK DIGITAL TAX SOLUTIONS, INC., KANSAS CITY, MO:
 2,410,984, CANC. INT. CL. 9.
- HÄFELE GMBH & CO KG, 72202 NAGOLD, FED REP GERMANY:
 3,312,960, PUB. 7-31-2007. MULTIPLE CLASS, INT. CLS. 6 AND 20.
- HABASIT AG, SWITZERLAND:
 3,312,825, PUB. 7-31-2007. INT. CL. 7.
- HACHETTE BOOK GROUP USA, INC., NEW YORK, NY:
 3,314,474, MULTIPLE CLASS, INT. CLS. 9, 16 AND 41.
- HACO ETIQUETAS LTDA., BLUMENAU, STATE OF SANTA CATARINA, BRAZIL:
 3,310,209, PUB. 7-31-2007. MULTIPLE CLASS, INT. CLS. 24 AND 26.
- HAGEMEYER N.V., GE NAARDEN, NETHERLANDS:
 1,419,432, CANC. INT. CL. 36.
- HAINES AND COMPANY, INC, N. CANTON, OH:
 2,583,973, COR. INT. CL. 35.
- HAINES, MARK S., GLEN ELLYN, IL:
 2,411,378, CANC. INT. CL. 5.
- HALE, ELECTA RUTH, COLUMBUS, KS:
 2,100,880, REN. 9-11-07. INT. CL. 25.
 2,102,680, REN. 9-11-07. INT. CL. 30.
 2,102,681, REN. 9-11-07. INT. CL. 30.
 2,108,250, REN. 9-11-07. INT. CL. 30.
- HALLER SCHWARZ, LONG BEACH, CA:
 3,313,298, INT. CL. 5.
 3,313,299, INT. CL. 5.
 3,314,500, INT. CL. 21.
- HALLMARK LICENSING, INC., KANSAS CITY, MO:
 3,314,689, INT. CL. 16.
 3,314,690, INT. CL. 16.
 3,314,858, INT. CL. 16.
- HALLOWELL ENGINEERING AND MANUFACTURING CORPORATION, PITTSFIELD, MA:
 3,312,345, PUB. 7-31-2007. MULTIPLE CLASS, INT. CLS. 9 AND 10.
- HALPERIN CREATIVE COMMUNICATIONS, L.P., DOYLESTOWN, PA:
 3,314,323, INT. CL. 41.
- HAMA FOODSERVICE GESMBH, AUSTRIA:
 3,123,806, COR. MULTIPLE CLASS, INT. CLS. 29, 30 AND 41.
- HAMBERGER INDUSTRIERWERKE GMBH, STEPHANSKIRCHEN, FED REP GERMANY:
 3,313,565, MULTIPLE CLASS, INT. CLS. 19 AND 27.
- HAMLIN MANAGEMENT GROUP, LIMITED, SPRINGFIELD, IL:
 2,409,755, CANC. INT. CL. 35.
- HAMPTON PRODUCTS INTERNATIONAL CORPORATION, FOOTHILL RANCH, CA:
 3,314,916, INT. CL. 6.
- HAMPTON STATE BANK, HAMPTON, IA:
 3,312,418, PUB. 7-31-2007. INT. CL. 35.
- HANDHELD POWER, LLC, NAPERVILLE, IL:
 3,313,245, INT. CL. 36.
- HANDS ON ATLANTA, INC., ATLANTA, GA:
 3,310,602, PUB. 7-31-2007. INT. CL. 35.
 3,312,580, PUB. 7-31-2007. INT. CL. 35.
- HANDYPRO FRANCHISE, INC., PLYMOUTH, MI:
 2,410,577, CANC. INT. CL. 37.
- HANLEY-WOOD, LLC, WASHINGTON, DC:
 3,312,321, PUB. 7-31-2007. INT. CL. 35.
 3,312,451, PUB. 7-31-2007. INT. CL. 35.
- HANNAH SAVANNAH, LLC, SAN ANTONIO, TX:
 3,311,409, PUB. 7-31-2007. INT. CL. 35.
- HANS SCHWARZKOPF & HENKEL GMBH & CO. KG, FED REP GERMANY:
 3,312,860, PUB. 7-31-2007. INT. CL. 3.
- HANS, DAVID R., PLEASANTON, CA AND HANS, KATHY LEE, PLEASANTON, CA:
 2,410,461, CANC. INT. CL. 9.
- HANSEN MANUFACTURING CORP., SIOUX FALLS, SD:
 3,312,181, PUB. 7-31-2007. INT. CL. 7.
- HANSGROHE AG, FED REP GERMANY:
 3,312,741, PUB. 7-31-2007. MULTIPLE CLASS, INT. CLS. 6, 9, 11, 20 AND 21.
- HANSGROHE AG, SCHILTACH, FED REP GERMANY:
 3,314,855, INT. CL. 11.
- HANSGROHE, INC., ALPHARETTA, GA:
 3,313,761, INT. CL. 11.
- HAPPY BIRD CORPORATION, WESTON, MA:
 3,313,903, INT. CL. 11.

HAPPY HIPPO PRESCHOOL, ORANGE, CA:
3,314,340, INT. CL. 41.

HARBINGER TECHNOLOGIES GROUP, MCLEAN, VA:
3,314,538, MULTIPLE CLASS, INT. CLS. 9 AND 42.

HARBRIDGE, CHRISTINA ANN, SAN FRANCISCO, CA:
3,312,365, PUB. 7-31-2007. INT. CL. 41.

HARDENBERG-WILTHEN AG, NORTEN-HARDENBERG,
FED REP GERMANY:
3,311,842, PUB. 2-27-2007. INT. CL. 33.

HARDIN CONSTRUCTION COMPANY, LLC, AVERY IS-
LAND, GA, IRA H. HARDIN COMPANY, ATLANTA, GA:
1,403,438. REN. 9-12-07. INT. CL. 37.

HARDINGE BROTHERS, INC., ELMIRA, NY:
1,418,936, CANC. INT. CL. 7.

HARDINGE INC., ELMIRA, NY:
1,451,786. REN. 9-7-07. INT. CL. 7.

HARDWOOD PRODUCTS COMPANY LLC, GUILFORD,
ME:
1,465,497. REN. 9-13-07. INT. CL. 20.

HARIBO GMBH & CO. KG, FED REP GERMANY:
3,312,957, PUB. 7-31-2007. INT. CL. 30.

HARMONISATION LIMITED, KINGSTON 6, JAMAICA:
3,311,696, PUB. 7-31-2007. MULTIPLE CLASS, INT. CLS.
3, 8, 14, 16, 18, 20, 21, 24, 25, 41, 42, 43, 44 AND 45.

HAROUNIAN, KAVEH, LOS ANGELES, CA AND HAROU-
NIAN, KOUROSH, LOS ANGELES, CA:
3,313,411, INT. CL. 5.

HARRINGTON, PERRY E, BOULDER CREEK, CA:
3,311,309, PUB. 7-31-2007. INT. CL. 40.

HARRIS COMPANIES, LLC, SPANISH FORT, AL:
3,313,748, INT. CL. 28.

HARRIS CORPORATION, MELBOURNE, FL:
3,313,406, MULTIPLE CLASS, INT. CLS. 9, 37 AND 42.

HARRIS NATIONAL ASSOCIATION, CHICAGO, IL:
2,086,063. REN. 9-7-07. INT. CL. 36.

HARRIS-LEE, PATRICIA, JERSEY CITY, NJ:
3,314,602, INT. CL. 3.

HARRIS, JERY, RICHMOND, VA:
3,312,281, PUB. 7-31-2007. INT. CL. 37.

HART, RUPERT MICHAEL, PALO ALTO, CA:
3,311,289, PUB. 7-31-2007. INT. CL. 20.

HARTL CRUSHTEK, L.L.C., ATLANTA, GA:
2,410,828, CANC. INT. CL. 7.

HARTMAN HOUSE, CALABASAS, CA:
3,313,117, MULTIPLE CLASS, INT. CLS. 35, 36, 41 AND
45.

HARVEY BALL SMILE LIMITED, JAPAN:
3,280,109, COR. MULTIPLE CLASS, INT. CLS. 12, 30
AND 34.

HARVEY, DEWAYNE, SARASOTA, FL:
2,410,509, CANC. INT. CL. 41.

HASBRO CANADA, INC., LONGUEUIL, QUEBEC, CANA-
DA:
1,419,330, CANC. INT. CL. 28.

HASCO IA LIMITED, RENO, NV:
3,313,916, INT. CL. 41.

HATFIELD, PHILLIP, SALINA, KS:
3,312,174, PUB. 7-31-2007. INT. CL. 25.

HAUTE DOG BOUTIQUE, INC., NEWBURGH, NY:
3,311,245, PUB. 7-10-2007. INT. CL. 35.

HAUTE TRASH: AN ARTIST'S COLLABORATIVE, NEVA-
DA CITY, CA:
3,311,298, PUB. 7-31-2007. INT. CL. 41.

HAVANA CAPPUCINO CO., OCEAN CITY, NJ:
3,312,045, PUB. 7-31-2007. INT. CL. 30.

HAWAIIAN HOST, INC., HONOLULU, HI:
3,314,628, INT. CL. 30.

HAWKES, ELMER, CAMBRIDGE, MA:
2,410,489, CANC. INT. CL. 9.

HAWKINS, BETH KINGSLEY, SEDONA, AZ:
3,311,073, PUB. 7-31-2007. MULTIPLE CLASS, INT. CLS.
16 AND 45.

HAYASHI TECNICA, LLC, HIGHLANDS RANCH, CO:
3,312,427, PUB. 7-31-2007. INT. CL. 3.

HAYDU INVESTMENTS LLC, LOMITA, CA:
3,314,942, INT. CL. 35.

HAYES-IVY MFG., INC., NEW TRIPOLI, NJ:
3,312,106, PUB. 7-31-2007. INT. CL. 24.

HAZELDEN FOUNDATION, CENTER CITY, MN:
3,313,673, INT. CL. 44.

HAZELQUIST, AL E., PORT ORCHARD, WA:
2,108,973, REN. 9-10-07. INT. CL. 28.

HBI BRANDED APPAREL ENTERPRISES, LLC, WINSTON-
SALEM, NC:
3,311,974, PUB. 7-31-2007. INT. CL. 25.
3,313,632, INT. CL. 25.
3,313,783, INT. CL. 25.
3,313,809, INT. CL. 25.

HBL IMPORTS, CORP, SANTA FE SPRINGS, CA:
3,312,015, PUB. 7-31-2007. MULTIPLE CLASS, INT. CLS. 6
AND 16.

HC LANGUAGE SOLUTIONS, INC., FOSTER CITY, CA:
3,313,316, INT. CL. 41.

HD AMERICA, INC., EARTH CITY, MO:
1,418,977, CANC. INT. CL. 9.
1,419,097, CANC. INT. CL. 12.

HEADSTRONG, INC., FAIRFAX, VA:
3,310,338, PUB. 7-31-2007. INT. CL. 42.

HEADWAITER UNIFORMS INC., TORONTO, ONTARIO,
CANADA:
2,411,260, CANC. INT. CL. 25.

HEADWATERS, INC., MARBLEHEAD, MA:
3,314,011, INT. CL. 11.

HEALING PATHS, LLC, RESTON, VA:
3,314,555, MULTIPLE CLASS, INT. CLS. 41, 44 AND 45.

HEALTH CONTACT PARTNERS, INC., LONG GROVE, IL:
3,312,029, PUB. 7-31-2007. MULTIPLE CLASS, INT. CLS.
35 AND 44.

HEALTH INITIATIVE PROJECT, INC., CANTON, OH:
3,310,975, PUB. 7-31-2007. INT. CL. 35.

HEALTH OPTIONS, INC., GOLDEN, CO:
3,313,296, INT. CL. 5.

HEALTH SYSTEMS DESIGN CORP., PLANO, TX:
2,094,928. REN. 9-10-07. INT. CL. 9.

HEALTHCARE UNIFORM COMPANY, INC., ST. LOUIS,
MO, DBA LIFE UNIFORM:
3,312,293, PUB. 7-31-2007. INT. CL. 35.

HEALTH PTY LTD ACN 104 814 842, AUSTRALIA:
3,312,735, PUB. 7-31-2007. MULTIPLE CLASS, INT. CLS.
9, 35, 36 AND 44.

HEALTHGATE DATA CORP., BURLINGTON, MA:
3,311,098, PUB. 7-31-2007. INT. CL. 42.

HEALTHWORKS FITNESS FOR WOMEN, LLC, LAKE-
VILLE, MN:
3,311,017, PUB. 7-31-2007. INT. CL. 41.

HEALTHY GAIN INVESTMENTS LIMITED, TSUEN WAN,
N.T., HONG KONG:
3,314,188, INT. CL. 7.

HEALTHY-IT, LLC, CHEVY CHASE, MD:
3,310,543, PUB. 7-31-2007. INT. CL. 9.

HEARING SCIENCE, SAN FRANCISCO, CA:
2,409,931, CANC. INT. CL. 35.

HEARST COMMUNICATIONS, INC., NEW YORK, NY:
3,313,024, INT. CL. 41.

HEARST CORPORATION, THE, NEW YORK, NY:
2,411,155, CANC. INT. CL. 35.

HEARST MAGAZINES PROPERTY, INC., GREENWICH,
CT:
2,410,089, CANC. INT. CL. 16.

HEARTLAND HEALTH SOLUTIONS, BRENTWOOD, TN:
3,313,471, INT. CL. 42.

HEARTSONG, INC., SCARSDALE, NY:
3,310,661, PUB. 7-31-2007. INT. CL. 44.

HEB GROCERY COMPANY, L.P., SAN ANTONIO, TX:
3,313,871, INT. CL. 29.
3,314,067, INT. CL. 21.
3,314,432, INT. CL. 29.

HEBEGRACE, INC., POTRERO, GUANACASTE, COSTA
RICA:
3,311,473, PUB. 7-31-2007. INT. CL. 14.

HECHT, MICHAEL A., MANHATTAN BEACH, CA:
3,314,926, INT. CL. 35.

HEDLOC PTY LTD, AUSTRALIA:
3,312,936, PUB. 7-31-2007. MULTIPLE CLASS, INT. CLS.
9, 35 AND 42.

- HEIDEN, MICHAEL, WOODCLIFF LAKE, NJ:
3,314,359, INT. CL. 28.
- HEIL & LAMBERT LLC, WALNUT CREEK, CA:
3,313,663, MULTIPLE CLASS, INT. CLS. 16 AND 21.
- HEILIG, DEBORAH L., TUCSON, AZ:
2,411,380, CANC. INT. CL. 40.
- HEIM DATA SYSTEMS, INC., WALL TOWNSHIP, NJ:
3,312,297, PUB. 7-31-2007. INT. CL. 9.
- HELEN LUO LLC., ROSEMEAD, CA:
3,310,568, PUB. 6-26-2007. INT. CL. 44.
- HELENE ABRAMS, ORLANDO, FL:
3,311,082, PUB. 7-31-2007. INT. CL. 9.
3,311,083, PUB. 7-31-2007. INT. CL. 9.
- HELIO LLC, LOS ANGELES, CA:
3,314,357, INT. CL. 9.
- HELIUM ENTERTAINMENT ASSOCIATES LLC, AND-OVER, MA:
3,313,260, INT. CL. 41.
- HELIX MEDICAL SYSTEMS LTD., KIRYAT SHMONA, ISRAEL:
3,311,880, PUB. 7-31-2007. INT. CL. 10.
- HELLONETWORK.COM, INC., LAS VEGAS, NV:
2,410,043, CANC. INT. CL. 42.
- HELLS ANGELS MOTORCYCLE CORPORATION, LACONIA, NH:
3,311,549, PUB. 7-31-2007. INT. CL. 26.
3,311,550, PUB. 7-31-2007. INT. CL. 14.
- HELPGUEST TECHNOLOGIES, INC., DELMAR, NY:
3,314,743, MULTIPLE CLASS, INT. CLS. 9 AND 35.
- HEMBCO, INC., NEW ORLEANS, LA:
3,311,919, PUB. 4-17-2007. INT. CL. 35.
3,311,920, PUB. 4-17-2007. INT. CL. 35.
- HENDERSON, WAYNE C., DOYLESTOWN, PA:
3,313,829, INT. CL. 39.
- HENG TONG CASTING CO. LTD., SHANXI, CHINA:
3,311,580, PUB. 7-31-2007. INT. CL. 6.
- HENKEL CORPORATION, GULPH MILLS, PA:
1,950,848, REN. 9-13-07. INT. CL. 1.
3,313,035, MULTIPLE CLASS, INT. CLS. 2 AND 17.
- HENKEL KGAA, DUESSELDORF, FED REP GERMANY:
3,313,600, INT. CL. 3.
- HENKEL KOMMANDITGESELLSCHAFT AUF AKTIEN, D-40191 DUESSELDORF, FED REP GERMANY:
2,409,933, CANC. INT. CL. 3.
- HENRY CLAY POTTERY, INC., WEST POINT, MS:
2,409,731, CANC. INT. CL. 21.
- HENRY, DAVID, LONG BEACH, NY:
2,409,889, CANC. INT. CL. 16.
- HEPLER, ERIC JACQUE, POTTSTOWN, PA:
2,411,310, CANC. INT. CL. 25.
- HER INTERACTIVE, INC., BELLEVUE, WA:
3,313,788, INT. CL. 9.
- HERBERGER, JENI, KIRKLAND, WA:
3,310,979, PUB. 7-31-2007. INT. CL. 35.
- HERBERT MALARKEY ROOFING COMPANY, PORTLAND, OR:
2,101,257, REN. 9-9-07. INT. CL. 19.
- HERBS, ETC., INC., SANTA FE, NM:
2,184,075, REN. 9-11-07. INT. CL. 5.
- HERBST GAMING, INC., LAS VEGAS, NV, PRIMADONNA CORPORATION, THE, JEAN (STATELINE), NV:
2,068,679, REN. 9-9-07. MULTIPLE CLASS, INT. CLS. 6, 9, 16 AND 25.
- HERBTHYME FARMS, INC., COMPTON, CA:
2,499,307, CANC. MULTIPLE CLASS, INT. CLS. 5, 29 AND 30.
- HERCO SERVICES, INC., COLBERT, WA:
3,312,457, PUB. 7-31-2007. INT. CL. 19.
- HERCULES INCORPORATED, WILMINGTON, DE:
3,313,261, INT. CL. 1.
- HERISTO AKTIENGESELLSCHAFT, FED REP GERMANY:
3,312,896, PUB. 7-31-2007. MULTIPLE CLASS, INT. CLS. 29, 30, 31, 32, 35, 36 AND 43.
- HERITAGE PRESERVATION CORPORATION, SPARTANBURG, SC:
3,314,594, INT. CL. 42.
- HERNANDEZ, RICARDO, TURLOCK, CA, DBA EWORLD REAL ESTATE:
3,310,446, PUB. 7-31-2007. INT. CL. 36.
- HERRON, WILLIAM F., WAUCONDA, IL, DBA HERRON EXCAVATING & TOPSOIL:
2,021,528, CANC. MULTIPLE CLASS, INT. CLS. 37, 39 AND 42.
- HERSCH AND COMPANY, LOS ANGELES, CA:
1,455,586, REN. 9-9-07. INT. CL. 28.
- HERSHEY CHOCOLATE & CONFECTIONERY CORP., WHEAT RIDGE, CO, PETER PAUL, INC., NAUGATUCK, CT:
829,881, REN. 9-13-07. U.S. CL. 46 (INT. CL. 30).
- HERSHEY CHOCOLATE & CONFECTIONERY CORP., WHEAT RIDGE, CO, BEECH-NUT LIFE SAVERS, INC., CANAJOHAIRE, NY, DBA BEECH-NUT:
836,400, REN. 9-13-07. U.S. CL. 46 (INT. CL. 30).
- HERSHEY CHOCOLATE & CONFECTIONERY CORPORATION, WHEAT RIDGE, CO:
3,311,601, PUB. 7-31-2007. INT. CL. 30.
3,313,834, MULTIPLE CLASS, INT. CLS. 5 AND 30.
- HESS CORPORATION, NEW YORK, NY:
3,310,764, PUB. 7-31-2007. MULTIPLE CLASS, INT. CLS. 1, 4, 25, 28, 35, 37, 39, 40 AND 42.
- HESSON, LYNN ANTHONY, NEENAH, WI:
3,314,339, INT. CL. 30.
- HETZEL, DAVID JOHN, ASHEVILLE, NC:
3,313,352, INT. CL. 44.
- HEWITT ASSOCIATES LLC, LINCOLNSHIRE, IL:
1,454,972, REN. 9-13-07. INT. CL. 9.
- HEWLETT-PACKARD COMPANY, PALO ALTO, CA:
2,410,116, CANC. INT. CL. 9.
- HHFFRRRRGGH, INC., JANESVILLE, WI:
2,411,324, CANC. INT. CL. 42.
- HICKEY, KENNETH, STATEN ISLAND, NY:
3,314,094, INT. CL. 41.
- HICKFORD, MICHELE, DEERFIELD BEACH, FL:
3,314,808, INT. CL. 26.
- HICKS, MUSE, TATE & FURST INCORPORATED, DALLAS, TX:
3,314,395, INT. CL. 36.
- HIGH END SYSTEMS, INC., AUSTIN, TX:
2,410,989, CANC. MULTIPLE CLASS, INT. CLS. 9 AND 11.
- HIGH FIDELITY MASTERING, ALBUQUERQUE, NM:
3,311,519, PUB. 7-31-2007. INT. CL. 41.
- HIGH INDUSTRIES, INC., LANCASTER, PA:
3,314,692, INT. CL. 42.
- HIGH POINT ACCESSORIES, INC., NEW YORK, NY:
2,409,691, CANC. MULTIPLE CLASS, INT. CLS. 9 AND 20.
- HIGH STREET FINANCIAL, INC., TAMPA, FL:
2,142,869, REN. 9-13-07. INT. CL. 36.
- HIGHLAND BEEF FARMS, RESTON, VA:
3,311,945, PUB. 7-31-2007. INT. CL. 30.
- HIGHTON, MARTIN, LA MESA, CA:
3,311,465, PUB. 7-31-2007. INT. CL. 30.
3,311,602, PUB. 7-31-2007. INT. CL. 30.
- HIGHWAY 12 VENTURES II, INC., BOISE, ID:
3,313,244, INT. CL. 36.
- HILCO TRADING CO., INC., NORTHBROOK, IL:
3,314,075, INT. CL. 35.
- HILL-ROM SERVICES, INC., BATESVILLE, IN:
1,479,168, REN. 9-13-07. INT. CL. 42.
2,141,247, REN. 9-13-07. INT. CL. 9.
- HILL'S PET NUTRITION, INC., TOPEKA, KS:
3,311,213, PUB. 7-17-2007. INT. CL. 31.
- HILLIARD, BRIAN WESLEY, SIMPSONVILLE, SC:
3,313,828, INT. CL. 35.
- HILLSIDE PATIENT FINANCING, L.P, OCALA, FL:
2,411,188, CANC. INT. CL. 36.
- HIRE TECHNOLOGIES, INC., AUSTIN, TX:
3,314,290, INT. CL. 35.
- HIREKO TRADING COMPANY, INC., CITY OF INDUSTRY, CA:
3,313,797, INT. CL. 28.
- HIRSCH, TOM, ASPEN, CO:
2,121,976, REN. 9-13-07. INT. CL. 35.

HISTORIC NATCHEZ FOUNDATION, NATCHEZ, MS:
3,311,840, PUB. 7-31-2007. INT. CL. 20.

HIT FACTORY, INC., NORTHFIELD, IL:
3,311,242, PUB. 7-31-2007. INT. CL. 38.

HITACHI METALS AMERICA, LTD., PURCHASE, NE:
1,047,590. REN. 9-11-07. INT. CL. 9.

HITACHI METALS, LTD., MINATO-KU TOKYO, JAPAN:
2,477,181, CANC. INT. CL. 6.

HITACHI SEIKI CO., LTD., CHIBA-KEN, 270-11, JAPAN:
2,020,162, CANC. INT. CL. 7.

HNI TECHNOLOGIES INC., MUSCATINE, IA:
2,094,796. REN. 9-10-07. INT. CL. 20.
3,312,114, PUB. 7-31-2007. INT. CL. 12.

HOBBS, STUART, NORTON, UNITED KINGDOM AND
JORDAN, GARY, BROMSGROVE, UNITED KINGDOM
AND XU, TINGJIAN, ZHAOQING CITY, CHINA AND
LOVE, JOHN, SHAWBURY, UNITED KINGDOM:
3,310,674, PUB. 6-26-2007. INT. CL. 16.

HOBLIN, JASON, YORBA LINDA, CA:
3,311,279, PUB. 7-31-2007. INT. CL. 42.

HOBSON, ROBERT A., NEWNAN, GA:
3,314,958, INT. CL. 32.

HODGES TRANSPORTATION, INC., CARSON CITY, NV,
DBA NEVADA AUTOMOTIVE TEST CENTER:
3,313,546, INT. CL. 42.

HOEY, GARY P., PELHAM, NH:
3,313,562, MULTIPLE CLASS, INT. CLS. 9, 35 AND 41.

HOLIDAY HAM & TURKEY, INC., MEMPHIS, TN:
3,314,709, INT. CL. 43.

HOLLAND HOME, GRAND RAPIDS, MI:
3,313,186, INT. CL. 44.

HOLLAND OIL COMPANY, AKRON, OH:
3,311,861, PUB. 7-31-2007. INT. CL. 45.

HOLLY HUNT LTD., CHICAGO, IL:
3,310,229, PUB. 7-31-2007. MULTIPLE CLASS, INT. CLS.
18 AND 24.

HOLLYMATIC CORPORATION, COUNTRYSIDE, IL:
1,080,202. REN. 9-13-07. INT. CL. 7.

HOLLYWOOD STOCK EXCHANGE LLC, NEW YORK, NY,
HSX, HOLDINGS, INC., NEW YORK, NY:
2,094,329. REN. 9-10-07. INT. CL. 41.

HOLMES-HALLY INDUSTRIES, LOS ANGELES, CA TO
CLOPAY BUILDING PRODUCTS R&D COMPANY, INC.,
CINCINNATI, OH:
2,020,726, CANC. INT. CL. 6.

HOLOGIX, INC., PHOENIX, AZ:
2,410,626, CANC. INT. CL. 42.

HOLOGRAFX, INC., EMERSON, NJ:
3,313,124, INT. CL. 9.

HOLT, ANDREW J., DES MOINES, IA, DBA WATER
CREATIONS TO WATER CREATIONS, INC., DES
MOINES, IA:
2,020,513, CANC. INT. CL. 19.

HOLY ARRAY, LLC, CHESTERFIELD, MO:
3,311,030, PUB. 7-31-2007. INT. CL. 25.
3,311,032, PUB. 7-31-2007. INT. CL. 25.

HOMAC MFG. COMPANY, ORMOND BEACH, FL:
3,314,770, INT. CL. 9.

HOME BOX OFFICE, INC., NEW YORK, NY:
3,313,438, INT. CL. 9.

HOME EDUCATION CONSULTATION, INC., FALLBROOK,
CA:
3,314,155, INT. CL. 41.

HOME PRODUCTS GROUP, INC., EDINA, MN:
3,311,628, PUB. 7-31-2007. INT. CL. 42.

HOMEGOODS, INC., FRAMINGHAM, MA:
3,312,674, PUB. 7-31-2007. INT. CL. 24.

HOMELAND VINYL PRODUCTS, INC., BIRMINGHAM,
AL:
3,312,377, PUB. 7-31-2007. INT. CL. 19.

HOMER TLC, INC., CLAYMONT, DE:
3,314,332, INT. CL. 11.

HOMESERVICES.COM, INC., EDINA, MN:
2,411,430, CANC. INT. CL. 36.

HONDA GIKEN KOGYO KABUSHIKI KAISHA, TOKYO
107-8556, JAPAN, TA HONDA MOTOR CO., LTD.:
3,313,040, INT. CL. 9.

HONEY ACRES, INC., ASHIPPUN, WI:
2,410,149, CANC. INT. CL. 30.

HONEYCUTT, RHODNEY, HICKORY, NC:
3,313,885, INT. CL. 43.

HONEYWELL INTELLECTUAL PROPERTIES INC.,
TEMPE, AZ:
1,436,974. REN. 9-11-07. INT. CL. 1.

HONEYWELL INTELLECTUAL PROPERTIES INC.,
TEMPE, AZ, HONEYWELL INC., MINNEAPOLIS, MN:
2,092,255. REN. 9-11-07. INT. CL. 9.

HONEYWELL INTELLECTUAL PROPERTIES INC.,
TEMPE, AZ:
2,104,228. REN. 9-7-07. INT. CL. 1.

HONEYWELL INTERNATIONAL INC., MORRISTOWN, NJ:
3,314,656, INT. CL. 11.
3,314,658, INT. CL. 11.
3,314,674, INT. CL. 12.

HONINGFORD, JASON M., CAPE CORAL, FL:
3,314,870, INT. CL. 42.

HONOR PLASTIC INDUSTRIAL CO., LTD., HU KOU, HSIN
CHU, TAIWAN:
3,312,603, PUB. 4-17-2007. INT. CL. 21.

HORMEL FOODS, LLC, AUSTIN, MN, HORMEL FOODS
CORPORATION, AUSTIN, MN:
2,097,703. REN. 9-10-07. INT. CL. 29.

HORMELL, MICHELLE ROARK, DENVER, CO:
3,313,740, INT. CL. 3.

HORZE OY, FI-15700 LAHTI, FINLAND:
3,312,754, PUB. 7-31-2007. MULTIPLE CLASS, INT. CLS.
18, 25 AND 28.

HOSHIZAKI AMERICA, INC., PEACHTREE CITY, GA:
2,021,478, CANC. INT. CL. 11.

HOSPITAL PURCHASING SERVICE OF MICHIGAN, MID-
DLEVILLE, MI:
3,310,984, PUB. 7-31-2007. INT. CL. 35.

HOSPITALITY FEDERAL CREDIT UNION, MEMPHIS, TN:
2,020,804, CANC. INT. CL. 36.

HOSS EQUIPMENT COMPANY, IRVING, TX:
2,128,172. REN. 9-13-07. INT. CL. 37.

HOSTLOGIC, INC., BOCA RATON, FL:
2,411,606, CANC. INT. CL. 35.

HOT DISH ADVERTISING, LLC, MINNEAPOLIS, MN:
3,314,850, INT. CL. 35.

HOT STUFF FOODS, LLC, SIOUX FALLS, SD:
3,311,611, PUB. 7-31-2007. INT. CL. 43.
3,313,726, INT. CL. 43.

HOTSPOT WIRELESS, INC., LAKE FOREST, CA:
3,310,721, PUB. 7-31-2007. INT. CL. 38.

HOUGHTON MIFFLIN COMPANY, BOSTON, MA:
3,313,132, INT. CL. 42.

HOUR MEDIA, LLC, ROYAL OAK, MI:
3,310,877, PUB. 7-31-2007. INT. CL. 16.

HOUSE OF HARDY LIMITED, NORTHUMBERLAND NE66
2PF, UNITED KINGDOM:
3,310,206, PUB. 7-31-2007. MULTIPLE CLASS, INT. CLS.
8, 18, 25 AND 28.

HOUSER PRODUCTS, LLC, GREEN CAMP, OH:
3,314,665, INT. CL. 12.

HOUSING PARTNERSHIP INC., THE, LOUISVILLE, KY:
3,310,435, PUB. 7-31-2007. MULTIPLE CLASS, INT. CLS.
36 AND 41.

HOWARD JOHNSON'S ENTERPRISES, INC., MILWAUKEE,
WI:
3,314,541, INT. CL. 1.

HOWARD MACHINERY CO., LTD., TAIWAN, TAIWAN:
2,409,780, CANC. MULTIPLE CLASS, INT. CLS. 7 AND
11.

HOWE FURNITURE CORPORATION, TRUMBULL, CT:
2,020,731, CANC. INT. CL. 20.

HPT TA PROPERTIES TRUST, NEWTON, MA:
3,313,992, INT. CL. 37.

HQ SUSTAINABLE MARITIME MARKETING INC., NEW
YORK, NY:
3,313,536, INT. CL. 29.

HR HOTLINE, INC., CONCORD, NH:
2,411,562, CANC. MULTIPLE CLASS, INT. CLS. 41 AND
42.

- HRB ROYALTY, INC., NASSAU, BAHAMAS:
3,314,586, INT. CL. 36.
- HSC RESEARCH DEVELOPMENT CORPORATION, TORONTO, ONTARIO, M5G 1XB, CANADA:
1,418,809, CANC. INT. CL. 1.
- HSIEH, HSIN MAO, KAOHSIUNG CITY, TAIWAN:
3,313,189, INT. CL. 12.
- HTC, INC, MONROE, LA:
3,311,414, PUB. 7-31-2007. INT. CL. 9.
3,311,416, PUB. 7-31-2007. INT. CL. 9.
- HTS STRUCTURES GROUP, LLC, EVANSVILLE, IN:
3,312,163, PUB. 7-31-2007. INT. CL. 6.
- HTS, LLC, LOS ANGELES, CA:
3,311,794, PUB. 7-31-2007. MULTIPLE CLASS, INT. CLS. 35, 37 AND 41.
- HUAWEI TECHNOLOGIES CO., LTD., SHENZHEN, CHINA:
3,313,908, INT. CL. 9.
- HUBBARD FEEDS INC., MANKATO, MN:
1,456,746, REN. 9-11-07. INT. CL. 31.
3,314,723, INT. CL. 31.
3,314,796, INT. CL. 31.
- HUBERT, KENNETH GERARD, HAZLETON, PA, TA FRE-CARVERS:
2,410,687, CANC. INT. CL. 20.
- HUDSON LIVESTOCK SUPPLEMENTS, INC., MILES, TX:
3,312,654, PUB. 4-24-2007. INT. CL. 5.
- HUDSON RIVER TRADING CO., INC, HOMER, GA:
3,310,547, PUB. 7-31-2007. INT. CL. 17.
- HUDSON'S GRILL OF AMERICA, INC., DALLAS, TX:
2,081,066, REN. 9-7-07. INT. CL. 42.
- HUESTIS MACHINE CORP., BRISTOL, RI:
1,418,958, CANC. INT. CL. 7.
- HUFNAGEL, KEITH, SAN FRANCISCO, CA:
3,312,384, PUB. 2-20-2007. INT. CL. 25.
3,312,385, PUB. 2-20-2007. INT. CL. 35.
3,312,419, PUB. 2-20-2007. INT. CL. 28.
- HUGGER MUGGER YOGA PRODUCTS, SALT LAKE CITY, UT:
3,314,597, INT. CL. 3.
- HUGHES-MILLAR HOLDINGS, LLC, ALISO VIEJO, CA:
3,314,037, INT. CL. 7.
- HUHTAMAKI COMPANY MANUFACTURING, DESOTO, KS:
3,314,158, INT. CL. 21.
- HUHTAMAKI FINANCE B.V., 2132 HE HOOFDDORP, NETHERLANDS:
3,310,863, PUB. 7-10-2007. INT. CL. 30.
3,310,864, PUB. 7-31-2007. INT. CL. 32.
3,311,207, PUB. 7-31-2007. INT. CL. 25.
- HUMAN SYNERGISTICS, INC., PLYMOUTH, MI:
3,314,462, INT. CL. 9.
- HUNTER CREEK HATTING & CO, DUBLIN, CA:
3,314,284, INT. CL. 25.
- HUNTER DOUGLAS INC., UPPER SADDLE RIVER, NJ:
3,314,019, INT. CL. 42.
- HUNTER FAN COMPANY, MEMPHIS, TN:
3,313,501, INT. CL. 11.
3,313,918, INT. CL. 11.
- HUNTER, RACHEL PRITZKER, CHICAGO, IL:
3,313,817, INT. CL. 35.
- HUNTINGTON BANCSHARES INCORPORATED, COLUMBUS, OH:
3,310,563, PUB. 7-31-2007. MULTIPLE CLASS, INT. CLS. 36 AND 42.
- HUNTINGTON COUNTRY STORE LLC, HUNTINGTON, MA:
3,313,248, INT. CL. 30.
- HUOT INSTRUMENTS LLC, MENOMONEE FALLS, WI:
3,313,867, INT. CL. 10.
- HURLEY, DENNIS P. III, SHEFFIELD, IL AND HURLEY, SHIRLEY, SHEFFIELD, IL:
2,411,111, CANC. INT. CL. 42.
- HURST, LEIGH A, MIDDLETOWN, PA:
3,310,546, PUB. 7-31-2007. INT. CL. 25.
- HUSH COMMUNICATIONS USA, INC., AUSTIN, TX:
2,410,144, CANC. INT. CL. 38.
- HUSQVARNA PROFESSIONAL OUTDOOR PRODUCTS INC., AUGUSTA, GA:
1,418,933, CANC. INT. CL. 7.
- HY CITE CORPORATION, MADISON, WI:
3,314,221, INT. CL. 7.
3,314,232, INT. CL. 7.
3,314,237, INT. CL. 7.
- HY-KO PRODUCTS COMPANY, NORTHFIELD, OH:
3,314,899, MULTIPLE CLASS, INT. CLS. 35 AND 40.
- HYALTECH LTD., EDINBURGH, SCOTLAND:
2,410,904, CANC. INT. CL. 5.
- HYATT CORPORATION, CHICAGO, IL:
2,038,345, REN. 9-7-07. INT. CL. 42.
2,039,956, REN. 9-13-07. INT. CL. 42.
- HYDRADRY, INC., ORLANDO, FL:
3,311,370, PUB. 7-31-2007. INT. CL. 37.
- HYDRAULIC WORLD, INC., SIOUX FALLS, SD, DAKOTA IRON, INC., SIOUX FALLS, SD:
1,479,015, REN. 9-7-07. INT. CL. 37.
- HYDRO INTERNATIONAL PLC, CLEVEDON, AVON BS217RD, UNITED KINGDOM:
3,006,908, COR. INT. CL. 11.
- HYDROTECH, INC., CINCINNATI, OH:
3,312,469, PUB. 7-31-2007. MULTIPLE CLASS, INT. CLS. 37, 40 AND 42.
3,312,502, PUB. 7-31-2007. MULTIPLE CLASS, INT. CLS. 37, 40 AND 42.
- HYDROX CHEMICAL COMPANY, INC., ELGIN, IL:
3,310,508, PUB. 7-31-2007. INT. CL. 5.
- HYMED GROUP CORPORATION, THE, BETHLEHEM, PA:
2,119,443, REN. 9-12-07. INT. CL. 5.
- HYPERCOM CORPORATION, PHOENIX, AZ:
2,411,537, CANC. INT. CL. 9.
- HYPERION ENERGY, L.P., DALLAS, TX:
3,310,344, PUB. 7-31-2007. INT. CL. 4.
3,310,345, PUB. 7-31-2007. INT. CL. 40.
- HYPERSEAL, INC., RANCHO MIRAGE, CA:
3,313,963, INT. CL. 2.
- HYPERSTRIKE, INC., SAN JOSE, CA:
3,312,006, PUB. 7-31-2007. INT. CL. 41.
- HYUNDAI MOTOR AMERICA, FOUNTAIN VALLEY, CA:
2,082,169, REN. 9-13-07. INT. CL. 41.
- HYUNDAI MOTOR COMPANY, CHONGRO-KU, SEOUL, REPUBLIC OF KOREA:
1,419,098, CANC. INT. CL. 12.
- H2O TO GO, LLC, MERCHANTVILLE, NJ, DBA PURIFIED WATER TO GO, WATER STORE NETWORK, THE, LAS VEGAS, NV:
2,022,848, REN. 9-10-07. INT. CL. 32.
- I.T.P., INCORPORATED, SPRINGFIELD, VA:
2,410,645, CANC. INT. CL. 28.
- IAR SYSTEMS AB, SE-75023 UPPSALA, SWEDEN:
3,310,230, PUB. 7-31-2007. MULTIPLE CLASS, INT. CLS. 7, 9, 10, 11, 12, 14, 16, 28 AND 42.
- ICASACOR, INC., BLUE BELL, PA:
3,314,509, INT. CL. 5.
- ICF INTERNATIONAL, INC., FAIRFAX, VA:
3,314,730, INT. CL. 35.
- ICHABOD INK, LLC, WEST CHESTER, PA:
3,313,127, INT. CL. 16.
- ICI AMERICAS INC., NEW CASTLE, DE, ICI UNITED STATES INC., WILMINGTON, DE:
1,072,963, REN. 9-7-07. INT. CL. 1.
- ICI AMERICAS INC., WILMINGTON, DE:
1,418,806, CANC. MULTIPLE CLASS, INT. CLS. 1 AND 4.
- ICL BERLIN BRILLEN GMBH, FED REP GERMANY:
3,312,746, PUB. 2-20-2007. MULTIPLE CLASS, INT. CLS. 9 AND 35.
- ICLISOY, JESSICA, BEVERLY HILLS, CA:
3,312,268, PUB. 6-19-2007. INT. CL. 3.
- ICMA RETIREMENT CORPORATION, WASHINGTON, DC:
2,410,218, CANC. INT. CL. 36.
- ICON HEALTH & FITNESS, INC., LOGAN, UT, ICON HEALTH & FITNESS, INC., LOGAN, UT:
2,093,932, REN. 9-10-07. INT. CL. 42.
- ICONLOGIC, INC., RIVA, MD:
3,311,892, PUB. 7-31-2007. INT. CL. 41.

ICOPY, L.L.C., DECATUR, TX:
3,311,771, PUB. 5-9-2006. MULTIPLE CLASS, INT. CLS. 16, 35 AND 39.

IDEMITSU KOSAN CO., LTD., TOKYO, JAPAN:
3,312,920, PUB. 7-31-2007. MULTIPLE CLASS, INT. CLS. 1 AND 9.

IDERKOU, HOURIA, SARATOGA, CA:
2,021,226, CANC. INT. CL. 3.

IF BY PHONE LLC, SKOKIE, IL:
3,312,216, PUB. 7-31-2007. MULTIPLE CLASS, INT. CLS. 38 AND 41.

IGAIN.COM, LLC, WESTPORT, CT:
2,410,397, CANC. INT. CL. 35.

IGT, RENO, NV:
3,312,449, PUB. 7-31-2007. INT. CL. 9.
3,313,519, INT. CL. 9.
3,313,530, INT. CL. 9.
3,313,649, INT. CL. 9.

IHEALTHSPOT INC., MARGATE, FL:
3,310,927, PUB. 7-31-2007. INT. CL. 42.

IKON OFFICE SOLUTIONS, INC., MALVERN, PA, IKON BRANDS, INC., PORTLAND, OR:
2,085,276, REN. 9-7-07. INT. CL. 42.

IKONISYS, INC., NEW HAVEN, CT:
3,314,400, INT. CL. 9.

IL BUCO CORP., NEW YORK, NY:
2,167,569, REN. 9-13-07. MULTIPLE CLASS, INT. CLS. 35 AND 42.

IL PADRINO, CANYON LAKE, TX:
3,311,751, PUB. 7-31-2007. INT. CL. 30.

ILLINOIS TOOL WORKS INC., GLENVIEW, IL, LOCTITE CORPORATION, HARTFORD, CT:
2,095,681, REN. 9-7-07. INT. CL. 17.

ILLINOIS TOOL WORKS INC., GLENVIEW, IL:
2,409,686, CANC. MULTIPLE CLASS, INT. CLS. 1 AND 4.
2,410,262, CANC. INT. CL. 3.
3,310,769, PUB. 7-31-2007. INT. CL. 7.
3,314,902, INT. CL. 7.

IM TRADING, LTD., NEW YORK, NY:
3,313,593, INT. CL. 25.

IMAGE BRANDS, INC., LA MESA, CA:
2,021,144, CANC. INT. CL. 30.

IMAGE GRAFIX, LLC, HUNTINGTON BEACH, CA:
3,311,917, PUB. 7-31-2007. INT. CL. 40.

IMAGE INFO, LLC, NEW YORK, NY:
3,313,750, INT. CL. 9.

IMAGE M.A.D. LIMITED, DUBLINO, SUCCURSALE DI LUGANO, LUGANO, SWITZERLAND:
3,313,393, INT. CL. 25.

IMAGENETIX, SAN DIEGO, CA:
3,313,317, INT. CL. 5.

IMAGINE MANUFACTURING, INC., MARBLEHEAD, MA:
2,411,258, CANC. INT. CL. 28.

IMATIX CORPORATION SPRL, BRUSSELS, BELGIUM:
2,411,595, CANC. INT. CL. 9.

IMERY'S PIGMENTS INC., ROSWELL, GA, THOMPSON-WEINMAN AND COMPANY, CARTERSVILLE, GA:
1,063,628, REN. 9-11-07. INT. CL. 1.

IMPACT SPORTS TECHNOLOGIES INC., LAS VEGAS, NV:
3,313,246, INT. CL. 10.

IMPACT SPORTS TECHNOLOGIES, INC., LAS VEGAS, NV:
3,313,603, INT. CL. 10.
3,314,405, INT. CL. 10.

IMPERIAL COMMODITIES CORPORATION, NEW YORK, NY:
2,091,760, REN. 9-13-07. INT. CL. 29.

IMPERIAL FINANCE & TRADING, LLC, BOCA RATON, FL:
3,311,483, PUB. 7-31-2007. INT. CL. 36.

IMPERIAL PALACE OF MISSISSIPPI, LLC, BILOXI, MS:
3,312,434, PUB. 7-31-2007. MULTIPLE CLASS, INT. CLS. 41 AND 43.

IMPERIAL USA LTD., CHARLOTTE, NC:
3,314,377, INT. CL. 6.

IMPRESSIVE TILE CO. INC., OAK PARK, MI:
3,312,311, PUB. 7-31-2007. INT. CL. 37.

IMPRIMIS GROUP, INC., DALLAS, TX:
3,313,167, INT. CL. 35.

INA USA CORPORATION, FORT MILL, SC, INA BEARING COMPANY, INC., FORT MILL, SC:
2,089,904, REN. 9-9-07. INT. CL. 6.

INAX CORPORATION, TOKONAME-SHI; AICHI-KEN 479-0838, JAPAN:
3,312,775, PUB. 7-31-2007. INT. CL. 11.

INBS INC., NEW YORK, NY:
3,314,119, INT. CL. 25.

INCREDIBLY EDIBLE DELITES, INC., BROOMALL, PA:
3,313,004, INT. CL. 29.

INDENA S.P.A., I-20139 MILANO, ITALY:
3,312,759, PUB. 2-20-2007. INT. CL. 5.

INDENTEC HARDNESS TESTING MACHINES LIMITED, WEST MIDLANDS DY9 8HX, ENGLAND:
2,411,496, CANC. INT. CL. 9.

INDEPENDENT DISTRIBUTORS ASSOCIATION, LLC, COLUMBIA, SC:
3,313,067, INT. CL. 41.

INDEPENDENT MEDICAL EVALUATIONS OF OKLAHOMA, TULSA, OK, DBA IME AMERICA:
1,419,525, CANC. INT. CL. 42.

INDIANA SOCIETY FOR THE PREVENTION OF CRUELTY TO ANIMALS CORP, INDIANAPOLIS, IN:
3,311,544, PUB. 7-31-2007. INT. CL. 35.

INDIANA UNIVERSITY FOUNDATION, BLOOMINGTON, IN TO INDIANA UNIVERSITY RESEARCH AND TECHNOLOGY CORPORATION, BLOOMINGTON, IA:
2,020,181, CANC. INT. CL. 16.

INDIEPENDENCEMUSIC.NET, INC., LAKE OSWEGO, OR:
3,310,411, PUB. 7-31-2007. INT. CL. 35.

INDIEWIRE LLC, NEW YORK, NY:
2,410,650, CANC. MULTIPLE CLASS, INT. CLS. 16 AND 41.

INDIGENE PHARMACEUTICALS, INC., WESTBOROUGH, MA:
3,312,361, PUB. 7-31-2007. INT. CL. 5.

INDO CITY PRODUCTIONS, INC., HEMPSTEAD, NY:
2,086,416, REN. 9-7-07. INT. CL. 16.

INDUSTRIAL COMPOSTIES, INC., BRIDGEVILLE, PA:
2,092,070, REN. 9-7-07. INT. CL. 7.

INDUSTRIAS LA CONSTANCIA, SOCIEDAD ANONIMA DE CAPITAL VARIABLE, ESCALON, SAN SALVADOR, EL SALVADOR:
3,312,334, PUB. 7-31-2007. INT. CL. 32.

INDYMAC BANK, F.S.B., PASADENA, CA:
3,314,099, INT. CL. 36.
3,314,101, INT. CL. 36.
3,314,384, INT. CL. 36.

INETEKK.COM, INC., SAN DIEGO, CA:
3,311,132, PUB. 7-31-2007. INT. CL. 35.

INFANTSEE4D, FAIRFAX, VA:
3,311,609, PUB. 7-31-2007. INT. CL. 41.

INFINEON TECHNOLOGIES AG, MUNICH, FED REP GERMANY:
3,310,548, PUB. 7-31-2007. MULTIPLE CLASS, INT. CLS. 9 AND 38.

INFINEON TECHNOLOGIES AG, MUNCHEN, FED REP GERMANY:
3,311,558, PUB. 7-31-2007. INT. CL. 9.

INFOCUS CORPORATION, WILSONVILLE, OR:
3,313,404, INT. CL. 9.

INFORMATION DYNAMICS, INC., INDIANAPOLIS, IN:
3,314,153, INT. CL. 42.

INFORMATION RADIO TECHNOLOGY, INC., EUCLID, OH:
2,094,477, REN. 9-12-07. INT. CL. 9.

INFOSPACE, INC., BELLEVUE, WA:
2,410,055, CANC. INT. CL. 35.

INFRARED FIBER SYSTEMS, INC., SILVER SPRING, MD:
3,312,007, PUB. 7-31-2007. INT. CL. 9.

INGEO SYSTEMS, INC., LOGAN, UT:
3,312,176, PUB. 7-31-2007. INT. CL. 42.

INGRAM ENTERPRISES, INC., SPRINGFIELD, MO:
2,170,820, REN. 9-13-07. INT. CL. 13.
3,314,342, INT. CL. 13.
3,314,347, INT. CL. 13.

INITIAL CALL, INC., NORMAN, OK:
3,311,246, PUB. 7-31-2007. INT. CL. 35.

- INJEN TECHNOLOGY, POMONA, CA:
3,310,991, PUB. 7-31-2007. INT. CL. 7.
- INLAND EMPIRE 66ERS BASEBALL CLUB OF SAN BERNARDINO, INC., SAN BERNARDINO, CA:
3,311,386, PUB. 7-31-2007. INT. CL. 25.
- INLAND TELEPHONE COMPANY, ROSLYN, WA:
3,314,542, INT. CL. 38.
- INLIGHTENMENT, INC., SPENCERVILLE, MD:
3,310,751, PUB. 7-17-2007. INT. CL. 16.
- INNER EQUITY PRODUCTIONS, MCKINNEY, TX:
3,310,824, PUB. 7-31-2007. INT. CL. 25.
- INNER MONGOLIA MENGNIU DAIRY (GROUP) CO., LTD., HUHHOT, INNER MONGOLIA, CHINA:
3,313,457, INT. CL. 30.
- INNERCAP TECHNOLOGIES, INC., TAMPA, FL:
3,310,609, PUB. 7-31-2007. INT. CL. 5.
- INNERLIGHT INTERNATIONAL, INC., ALPINE, UT:
2,410,499, CANC. INT. CL. 9.
- INNOVATION STRATEGY GROUP, INC., CAZENOVIA, NY:
2,411,493, CANC. INT. CL. 16.
- INNOVATIVE BIOSCIENCES CORPORATION, CARLSBAD, CA:
3,311,105, PUB. 7-31-2007. INT. CL. 3.
- INNOVATIVE DATA SOLUTIONS CORP., TOMS RIVER, NJ:
2,409,850, CANC. INT. CL. 9.
- INNOVATIVE IDEAS AND INFLUENCE CORPS, LLC, FORT MILL, SC:
3,314,235, INT. CL. 41.
- INNOVATIVE SPORTING SOLUTIONS INC., ST CHARLES, IL:
3,312,615, PUB. 7-31-2007. INT. CL. 28.
- INNOVATIVE WIRELESS TECHNOLOGIES, INC., FOREST, VA:
3,314,679, INT. CL. 9.
- INO THERAPEUTICS, LLC, CLINTON, NJ:
3,314,528, INT. CL. 5.
- INPHARMA AS, NORWAY:
3,312,819, PUB. 7-31-2007. MULTIPLE CLASS, INT. CLS. 3, 5 AND 21.
- INSIDE RADIO, INC., LITTLETON, NH:
2,095,005, REN. 9-13-07. INT. CL. 16.
- INSIGHT HEALTH CORP., LAKE FOREST, CA:
3,310,579, PUB. 7-31-2007. INT. CL. 44.
- INSIGHT IMAGING, INC., HUNTSVILLE, AL:
3,314,178, INT. CL. 44.
- INSPECTORATE HOLDINGS PLC, WITHAM, UNITED KINGDOM:
3,313,762, INT. CL. 42.
- INSTA-LEARN BY STEP, INC., MUKILTEO, WA:
1,477,665, REN. 9-11-07. INT. CL. 16.
- INSTEAD, INC., LAJOLLA, CA:
3,313,382, INT. CL. 5.
- INSTITUTE OF MANAGEMENT ACCOUNTANTS, MON-TVALE, NJ:
3,313,115, MULTIPLE CLASS, INT. CLS. 35 AND 41.
3,314,921, INT. CL. 41.
3,314,922, INT. CL. 41.
- INSTITUTION, INC., THE, CHAPEL HILL, NC:
2,410,311, CANC. INT. CL. 42.
- INSURANCEASSIST, INC., EL SEGUNDO, CA:
3,314,927, INT. CL. 36.
- INTECHRA LLC, JACKSON, MS:
3,310,616, PUB. 7-31-2007. MULTIPLE CLASS, INT. CLS. 35, 37 AND 40.
- INTEGRATED HEALTH, INC., SANTA MONICA, CA:
1,418,902, CANC. INT. CL. 5.
- INTEGRATED ILLUMINATION SYSTEMS, INC., MORRIS, CT:
3,312,294, PUB. 7-31-2007. INT. CL. 35.
- INTEGRATED PACKAGING ASSEMBLY CORPORATION, SAN JOSE, CA:
2,020,500, CANC. INT. CL. 40.
- INTEGRATED TELECOM SOLUTIONS, INC., RICHARDSON, TX:
2,410,670, CANC. INT. CL. 38.
- INTEGRATIA CORP., ST. LOUIS, MO:
2,411,391, CANC. INT. CL. 42.
- INTEGRATION ASSOCIATES INC., MOUNTAIN VIEW, CA:
3,314,882, INT. CL. 9.
- INTEK AMERICA, INC., TORRANCE, CA:
3,313,419, INT. CL. 16.
- INTELIHEALTH INC., BLUE BELL, PA:
2,410,792, CANC. INT. CL. 42.
- INTELLIGENCE PRESS INC., STERLING, VA:
3,312,662, PUB. 7-31-2007. MULTIPLE CLASS, INT. CLS. 35 AND 39.
3,312,663, PUB. 7-31-2007. MULTIPLE CLASS, INT. CLS. 16 AND 41.
- INTELLIGENT NUTRIENTS, LLC, MINNEAPOLIS, MN:
2,090,820, REN. 9-10-07. INT. CL. 5.
- INTELLIGENT RESULTS, INC., BELLEVUE, WA:
3,314,268, MULTIPLE CLASS, INT. CLS. 9 AND 42.
- INTEPROD LLC, MALVERN, PA:
3,311,092, PUB. 7-31-2007. INT. CL. 40.
- INTER-MARK USA, INC., ARMONK, NY:
3,312,299, PUB. 7-31-2007. INT. CL. 3.
- INTER-PACIFIC CORPORATION, LOS ANGELES, CA, DBA IPC:
1,419,305, CANC. INT. CL. 25.
- INTERACTIVE COMMUNICATIONS SOLUTIONS GROUP, INC., SEVERNA PARK, MD:
3,310,217, PUB. 7-31-2007. INT. CL. 42.
- INTERACTIVE MANAGEMENT COMPANY LTD, BATH, UNITED KINGDOM:
2,410,427, CANC. MULTIPLE CLASS, INT. CLS. 35 AND 42.
- INTERACTIVES MANAGEMENT COMPANY LTD, BATH BA1 5EZ, UNITED KINGDOM:
2,410,425, CANC. MULTIPLE CLASS, INT. CLS. 35 AND 42.
2,410,426, CANC. MULTIPLE CLASS, INT. CLS. 35 AND 42.
- INTERCOM ONLINE INC., NEW YORK CITY, NY:
2,410,863, CANC. INT. CL. 38.
2,410,864, CANC. INT. CL. 38.
2,410,865, CANC. INT. CL. 38.
- INTERCONTINENTAL HOTELS CORPORATION, NEW YORK, NY:
1,419,421, CANC. INT. CL. 35.
- INTERCYTEX LIMITED, WYTHENSHAW, UNITED KINGDOM:
3,311,750, PUB. 7-31-2007. MULTIPLE CLASS, INT. CLS. 5, 10, 42 AND 44.
- INTERHEALTH CORP., WHITTIER, CA:
2,411,518, CANC. INT. CL. 42.
- INTERKINETIC, INC., LOMBARD, IL:
3,311,627, PUB. 7-31-2007. INT. CL. 9.
- INTERLEGIS, INC., DALLAS, TX:
3,314,947, MULTIPLE CLASS, INT. CLS. 42 AND 45.
- INTERMARK COMMUNICATIONS, INC., FARMINGDALE, NY:
2,410,816, CANC. INT. CL. 36.
- INTERMARKET TECHNOLOGY, INC., WAYNE, NJ:
3,312,277, PUB. 7-31-2007. INT. CL. 20.
- INTERMEC TECHNOLOGIES CORPORATION, EVERETT, WA:
1,460,333, REN. 9-11-07. INT. CL. 37.
- INTERMET METALS SERVICES, INC., SCHAUMBURG, IL:
3,312,471, PUB. 7-31-2007. INT. CL. 6.
- INTERNAL DEFENSE SYTEM, INC., ST. CHARLES, IL:
3,311,888, PUB. 7-31-2007. INT. CL. 41.
- INTERNATIONAL ASSOCIATION FOR DENTAL RESEARCH, ALEXANDRIA, VA AND AMERICAN ASSOCIATION FOR DENTAL RESEARCH, ALEXANDRIA, VA:
2,153,294, REN. 9-11-07. INT. CL. 16.
- INTERNATIONAL ASSOCIATION OF INFANT MASSAGE, INC., VENTURA, CA:
3,312,110, PUB. 7-31-2007. INT. CL. 41.
- INTERNATIONAL BEAUTY PRODUCTS, FAIRFIELD, NJ:
3,310,908, PUB. 7-31-2007. INT. CL. 21.
- INTERNATIONAL BROTHERHOOD OF TEAMSTERS, WASHINGTON, DC:
3,310,272, PUB. 7-31-2007. MULTIPLE CLASS, U.S. CL. 200 INT. CL. 25.

- INTERNATIONAL CABLE CHANNELS PARTNERSHIP, LTD., ENGLEWOOD, CO:
2,411,135, CANC. MULTIPLE CLASS, INT. CLS. 38 AND 41.
- INTERNATIONAL CARTOONS LIMITED, OYSTER BAY, NY:
1,418,863, CANC. INT. CL. 3.
- INTERNATIONAL COMFORT PRODUCTS, LLC, LEWISBURG, TN, HEIL-QUAKER CORPORATION, LAVERGNE, TN:
1,456,415, REN. 9-7-07. INT. CL. 11.
1,465,334, REN. 9-7-07. INT. CL. 11.
- INTERNATIONAL CONFERENCE OF BUILDING OFFICIALS, INC., WHITTIER, CA:
2,090,997, REN. 9-12-07. INT. CL. 9.
- INTERNATIONAL CONSORTIUM OF CERTIFIED KNOWLEDGE EXPERTS, NEW YORK, NY:
3,311,218, PUB. 7-31-2007. INT. CL. 42.
- INTERNATIONAL ENVIROGUARD SYSTEMS, INC., MESQUITE, TX:
3,310,900, PUB. 7-31-2007. INT. CL. 9.
- INTERNATIONAL FOOD AND HOSPITALITY CONSULTING; MANAGEMENT SPRL, BELGIUM:
3,312,797, PUB. 7-31-2007. MULTIPLE CLASS, INT. CLS. 29, 32 AND 33.
- INTERNATIONAL FRANCHISE CORP., MARKHAM, ONTARIO, CANADA, HEIDI'S FROGEN YOZURT SHOPPES, INC., LAGUNA HILLS, CA:
1,430,697, REN. 9-7-07. INT. CL. 42.
- INTERNATIONAL GOLF & COUNTRY CLUB, LLC, BONITA SPRINGS, FL:
3,312,080, PUB. 7-31-2007. INT. CL. 35.
3,312,081, PUB. 7-31-2007. INT. CL. 35.
- INTERNATIONAL HOCKEY INDUSTRY ASSOCIATION, MONTREAL, CANADA:
3,312,363, PUB. 7-31-2007. INT. CL. 35.
- INTERNATIONAL LEARNING SOLUTIONS, BLOOMINGTON, IL:
3,311,755, PUB. 7-31-2007. MULTIPLE CLASS, INT. CLS. 9 AND 16.
- INTERNATIONAL MOTOR CONTEST ASSOCIATION, INC., VINTON, IA:
3,310,986, PUB. 7-31-2007. INT. CL. 41.
- INTERNATIONAL PAINT LIMITED, LONDON, UNITED KINGDOM, INTERNATIONAL PAINT COMPANY, INC., NEW YORK, NY:
432,974, REN. 9-7-07. U.S. CL. 16 (INT. CL. 2).
- INTERNATIONAL PAPER COMPANY:
1,418,827, CANC. INT. CL. 1.
- INTERNATIONAL PAPER COMPANY, MEMPHIS, TN:
3,313,830, INT. CL. 16.
3,313,831, INT. CL. 16.
- INTERNATIONAL PUBLISHING MANAGEMENT ASSOCIATION, LIBERTY, MO:
2,021,512, CANC. INT. CL. 42.
- INTERNATIONAL SEAWAY TRADING CORPORATION, BOCA RATON, FL:
3,314,228, INT. CL. 25.
- INTERNATIONAL SECURITY AGENCY INC., NEW YORK, NY:
2,410,819, CANC. INT. CL. 42.
- INTERNATIONAL SPORHORSE REGISTRY, CHICAGO, IL, DBA OLDENBURG REGISTRY NORTH AMERICA:
2,094,414, REN. 9-11-07. U.S. CL. A.
- INTERNATIONAL TELECOMMUNICATION DATA SYSTEMS, INC., STAMFORD, CT:
2,411,505, CANC. MULTIPLE CLASS, INT. CLS. 9, 35 AND 41.
- INTERNATIONAL UNION OF OPERATING ENGINEERS, THE, WASHINGTON, DC:
347,276, REN. 9-10-07. U.S. CL. 38 (INT. CLS. 9, 16 AND 28).
- INTERNATIONAL UTILITY STRUCTURES INC., CALGARY, ALBERTA T2P 3R5, CANADA:
2,410,653, CANC. INT. CL. 6.
- INTERNET HIGHWAY, INC., ST. HELENA, CA:
2,410,360, CANC. INT. CL. 35.
- INTERNET.COM CORPORATION, WESTPORT, CT:
2,410,440, CANC. INT. CL. 42.
2,410,441, CANC. INT. CL. 42.
- INTERNETBIZ.NET, LLC, TOPSFIELD, MA:
2,409,862, CANC. INT. CL. 42.
- INTERONE MARKETING GROUP, INC., SOUTHFIELD, MI:
2,411,416, CANC. MULTIPLE CLASS, INT. CLS. 35 AND 41.
- INTERSEARCH CORPORATION, HORSHAM, PA:
2,020,941, CANC. INT. CL. 35.
- INTERSTATE BAKERIES CORPORATION, KANSAS CITY, MO:
3,311,532, PUB. 7-31-2007. INT. CL. 30.
- INTERSTATE TELECOMMUNICATIONS COOPERATIVE, INC., CLEAR LAKE, SD:
3,311,908, PUB. 7-31-2007. INT. CL. 38.
- INTERTRUST TECHNOLOGIES CORPORATION, SANTA CLARA, CA:
2,410,947, CANC. INT. CL. 9.
- INTERVENTURE, LLC, SAN LUIS OBISPO, CA:
2,410,537, CANC. INT. CL. 35.
- INTREXON CORPORATION, BLACKSBURG, VA:
3,312,168, PUB. 7-31-2007. MULTIPLE CLASS, INT. CLS. 1, 5 AND 40.
- INTRUST FINANCIAL CORPORATION, WICHITA, KS:
2,411,021, CANC. INT. CL. 36.
- INVERELLE, INC., CARLYLE, IL, LANDAIRE, LTD., PALATINE, IL:
1,470,386, REN. 9-7-07. INT. CL. 5.
- INVESTORS CAFE, LLC, CHARLOTTE, NC:
3,312,223, PUB. 7-31-2007. INT. CL. 41.
- INVESTORS MORTGAGE HOLDINGS INC., SCOTTSDALE, AZ:
3,310,830, PUB. 7-31-2007. INT. CL. 36.
3,311,273, PUB. 7-31-2007. INT. CL. 36.
- INVICTA WATCH COMPANY OF AMERICA, INC., HOLLYWOOD, FL:
3,314,314, INT. CL. 14.
- INVISION EYECARE, INC., LAKEWOOD, NJ:
3,310,490, PUB. 7-31-2007. INT. CL. 44.
- IOMED, INC., SALT LAKE CITY, UT:
3,313,469, INT. CL. 10.
- IOVATION INC., PORTLAND, OR:
3,313,470, MULTIPLE CLASS, INT. CLS. 9 AND 42.
- IOWA WASTE REDUCTION CENTER, A DEPARTMENT OF THE UNIVERSITY OF NORTHERN IOWA, CEDAR FALLS, IA:
3,314,938, INT. CL. 9.
- IP BRANDS LLC, BRIDGEVILLE, PA, KAZAS, THOMAS P., CANONSBURG, PA:
2,095,516, REN. 9-13-07. INT. CL. 30.
- IP DEVELOPMENT, LLC, KNOXVILLE, TN:
2,410,403, CANC. INT. CL. 9.
- IR SQUARED, LLC, ATLANTA, GA:
3,310,515, PUB. 7-31-2007. INT. CL. 35.
- IRECO, LLC, BENSENVILLE, IL:
3,310,744, PUB. 7-31-2007. INT. CL. 6.
- IRIMINAGE, INC, DELRAY BEACH, FL:
3,310,729, PUB. 7-17-2007. INT. CL. 41.
- IRISH DISTILLERS LIMITED, SMITHFIELD, DUBLIN 7, IRELAND, DBA JOHN POWER & SON, DBA JOHN JAMESON & SON, DBA CORK DISTILLERIES COMPANY, DBA HUZZAR VODKA COMPANY, DBA TULLAMORE DEW COMPANY, AND DBA IRISH DISTILLERS:
1,453,448, REN. 9-9-07. INT. CL. 33.
- IRISO ELECTRONICS CO., LTD., KANAGAWA, JAPAN:
3,311,681, PUB. 7-31-2007. INT. CL. 9.
- ISCOTEC AB, STOCKHOLM, SWEDEN:
3,312,200, PUB. 7-31-2007. INT. CL. 5.
3,312,201, PUB. 7-31-2007. MULTIPLE CLASS, INT. CLS. 1 AND 5.
- ISECRUETRAC INC., OMAHA, NE:
3,313,220, INT. CL. 9.
- ISHIDA CO., LTD., KYOTO-SHI, KYOTO 606-8392, JAPAN:
3,313,122, MULTIPLE CLASS, INT. CLS. 7 AND 9.
- ISKENDERIAN, PHILIP G., VAN NUYS, CA:
3,312,042, PUB. 7-31-2007. INT. CL. 37.

- ISLE OF CAPRI CASINOS, INC., ST. LOUIS, MO:
3,311,623, PUB. 7-31-2007. INT. CL. 43.
- ISO CLAIMS SERVICES, INC., COLUMBIA, SC:
3,311,595, PUB. 7-31-2007. INT. CL. 9.
- ISO-SCIENCE LABORATORIES, INC., BURBANK, CA, DBA
ISOTOPE PRODUCTS LABORATORIES:
2,411,202, CANC. INT. CL. 10.
- ISS RESEARCH, LLC, CHARLOTTE, NC:
3,314,997, INT. CL. 5.
- ISTHMUS PUBLISHING COMPANY, INC., MADISON, WI:
3,312,244, PUB. 7-31-2007. INT. CL. 41.
- IT FIGURES, LLC, NEW YORK, NY:
2,170,458, REN. 9-10-07. INT. CL. 25.
- IT'S HIP TO BE ROUND, INC., RICHMOND, VA:
3,314,769, INT. CL. 35.
- ITALEE OPTICS, INC., LOS ANGELES, CA:
3,311,954, PUB. 7-31-2007. INT. CL. 9.
- ITHACA MEDIA CORPORATION, LA CANADA, CA:
2,411,299, CANC. INT. CL. 9.
- ITT CORPORATION, WHITE PLAINS, NY:
1,418,963, CANC. INT. CL. 7.
- ITT MANUFACTURING ENTERPRISES, INC., WILMING-
TON, DE:
2,410,179, CANC. INT. CL. 42.
2,410,180, CANC. INT. CL. 42.
- IUS JURIS, LLC, ORLANDO, FL:
3,311,319, PUB. 7-31-2007. INT. CL. 45.
- IVIS, INCORPORATED, RALEIGH, NC, DBA IVIS INTER-
NATIONAL:
2,020,720, CANC. INT. CL. 9.
- IVIVI TECHNOLOGIES, INC., NORTHVALE, NJ:
3,314,401, INT. CL. 10.
- IVX ANIMAL HEALTH, INC., ST. JOSEPH, MO:
3,314,093, INT. CL. 5.
- IVY BROWN JEANS, LLC, STAMFORD, CT:
3,313,863, INT. CL. 25.
- IZURASHI CO., LTD., TAGATA-GUN, SHIZUOKA-KEN,
JAPAN:
2,410,957, CANC. INT. CL. 6.
- 1411 INC, HERNDON, VA:
3,311,216, PUB. 7-31-2007. MULTIPLE CLASS, INT. CLS. 9, 35 AND 42.
- J CONSORTIUM, INC., CUPERTINO, CA:
2,411,412, CANC. INT. CL. 42.
- J SQUARED SALES INC., ALBERTSON, NY:
3,314,097, MULTIPLE CLASS, INT. CLS. 29 AND 30.
- J STEVENS INC., FAIR LAWN, OH:
3,310,378, PUB. 7-31-2007. INT. CL. 35.
- J. & P. COATS, LIMITED, GLASGOW G2 5PA, SCOTLAND:
3,312,639, PUB. 7-31-2007. INT. CL. 23.
3,312,640, PUB. 7-31-2007. INT. CL. 23.
- J. & P. COATS, LIMITED, GLASGOW, SCOTLAND:
3,314,739, INT. CL. 23.
3,314,742, INT. CL. 23.
- J. C. SCHUMACHER COMPANY, OCEANSIDE, CA:
1,418,826, CANC. INT. CL. 1.
- J. CHOO LIMITED, LONDON, ENGLAND:
3,312,541, PUB. 7-31-2007. MULTIPLE CLASS, INT. CLS. 3
AND 9.
- J. EDWARDS JEWELRY DISTRIBUTING LLC, EL PASO,
TX, DBA J. EDWARDS DIAMONDS:
3,314,695, INT. CL. 14.
- J. FILIPPI VINTAGE COMPANY INC., RANCHO CUCA-
MONGA, CA, DBA JOSEPH FILIPPI WINERY:
3,311,199, PUB. 7-10-2007. INT. CL. 33.
- J. S. MARKETING ORGANIZATION, INC., CRYSTAL
LAKE, IL:
2,410,261, CANC. INT. CL. 25.
- J.C. PENNEY COMPANY, INC., PLANO, TX:
2,410,181, CANC. INT. CL. 42.
2,410,303, CANC. INT. CL. 35.
- J.C. RAGS B.V., NETHERLANDS:
3,312,730, PUB. 7-31-2007. INT. CL. 25.
- J.G.I., INC., CHARLOTTE, NC:
2,411,517, CANC. INT. CL. 28.
- J.H. FENNER & CO. LIMITED, EAST YORKSHIRE, ENG-
LAND:
3,312,458, PUB. 7-31-2007. INT. CL. 9.
- J.J. BARKER COMPANY LIMITED, COWANSVILLE, CA-
NADA:
3,312,379, PUB. 7-31-2007. INT. CL. 19.
- J.J. DONAHUE & CO., BOSTON, MA:
2,091,230, REN. 9-13-07. INT. CL. 42.
- J.R. SIMPLOT COMPANY, BOISE, ID:
3,313,644, INT. CL. 31.
- J.W. ETC., THOUSAND OAKS, CA:
1,418,844, CANC. INT. CL. 2.
- J&J TECHNOLOGY, LLC, NASHVILLE, TN:
3,313,015, INT. CL. 3.
- J-NETWORK, INC., TORRANCE, CA:
2,411,145, CANC. INT. CL. 2.
- J/B INDUSTRIES, INC., AURORA, IL:
3,312,315, PUB. 7-31-2007. INT. CL. 7.
3,312,316, PUB. 7-31-2007. MULTIPLE CLASS, INT. CLS.
7, 9 AND 17.
- JA BUTLER COMPANIES INC., COSBY, MO:
3,311,566, PUB. 7-31-2007. INT. CL. 35.
- JAAM, LLC, WAYNE, NJ:
2,411,273, CANC. INT. CL. 28.
- JABIL GLOBAL SERVICES, INC., ST. PETERSBURG, FL:
2,410,183, CANC. INT. CL. 35.
- JACCARD CORPORATION, ORCHARD PARK, NY:
3,314,055, INT. CL. 8.
3,314,056, INT. CL. 8.
- JACKSON CAPITAL MARKETS, HIGHLAND PARK, IL:
3,311,015, PUB. 7-31-2007. INT. CL. 36.
- JACKSON HOLE WILDLIFE FOUNDATION, JACKSON,
WY:
2,077,193, REN. 9-9-07. INT. CL. 42.
- JACOBS ENTERTAINMENT, INC., GOLDEN, CO:
3,312,387, PUB. 7-31-2007. INT. CL. 35.
- JACOBS NEDERLAND B.V., 2332 CB LEIDEN, NETHER-
LANDS:
2,477,110, CANC. MULTIPLE CLASS, INT. CLS. 1 AND 9.
- JACOBS, PATRICK, LEXINGTON, MA:
2,411,173, CANC. INT. CL. 28.
- JACUZZI INC., DALLAS, TX:
3,313,661, INT. CL. 11.
- JADECOR GMBH, RHEINBROHL, FED REP GERMANY:
2,021,112, CANC. MULTIPLE CLASS, INT. CLS. 19 AND
27.
- JAFER LIMITED, HAMILTON HM12, BERMUDA:
3,313,967, INT. CL. 16.
- JAGUAR CARS LIMITED, COVENTRY, UNITED KING-
DOM:
2,410,990, CANC. INT. CL. 20.
- JAKI BASKOW, LAS VEGAS, NV:
3,310,565, PUB. 7-31-2007. INT. CL. 41.
- JAKKS PACIFIC, INC., MALIBU, CA:
3,313,388, INT. CL. 16.
3,314,322, INT. CL. 28.
3,314,393, INT. CL. 28.
- JAMBA JUICE COMPANY, EMERYVILLE, CA, JUICE
CLUB, INC., SAN FRANCISCO, CA:
2,087,566, REN. 9-10-07. INT. CL. 32.
- JAMECO INTERNATIONAL, LLC, LAKEWOOD, NJ:
3,311,942, PUB. 7-31-2007. INT. CL. 11.
- JAMES D. TERRINONI, OSWEGO, NY:
3,311,027, PUB. 7-31-2007. MULTIPLE CLASS, INT. CLS.
35 AND 41.
- JAMES HARDIE INTERNATIONAL FINANCE, B.V., AM-
STERDAM, NETHERLANDS:
2,410,958, CANC. INT. CL. 19.
- JAMES MCCULLY ORCHIDCULTURE, INC., HAKALAU,
HI:
2,410,466, CANC. INT. CL. 42.
- JAMES P. STILES, JUPITER, FL:
3,312,601, PUB. 7-31-2007. INT. CL. 37.
- JAMI, INC., OVERLAND PARK, KS:
3,313,326, INT. CL. 20.
- JAMMIN BEAR LLC, OLNEY, MD:
3,313,171, INT. CL. 25.
- JANAM PARTNERS, LLC, COLD SPRING HARBOR, NY:
3,313,263, INT. CL. 9.

JANE MYERS DREW PH.D. A PSYCHOLOGY CORPORATION, NEWPORT BEACH, CA:
3,313,640, INT. CL. 28.

JANUS CAPITAL CORPORATION, DENVER, CO:
2,410,879, CANC. INT. CL. 36.

JARAICIE, AYOUB, ESCONDIDO, CA:
2,410,733, CANC. INT. CL. 25.
2,410,734, CANC. INT. CL. 25.

JARDINE FOODS, INC., BUDA, TX:
1,456,732, REN. 9-9-07. INT. CL. 30.
3,310,676, PUB. 7-31-2007. INT. CL. 30.

JARRETT, JOHN R., EUGENE, OR:
2,410,629, CANC. INT. CL. 42.

JARYL INTERNATIONAL INC., ORADELL, NJ:
3,314,059, INT. CL. 28.

JARYL INTERNATIONAL, INC., ORADELL, NJ:
3,314,061, INT. CL. 28.

JASON INC., CONOVER, NC:
3,310,248, PUB. 7-31-2007. MULTIPLE CLASS, INT. CLS. 1, 2, 3, 7 AND 24.

JATO COMMUNICATIONS CORP., DENVER, CO:
2,410,378, CANC. INT. CL. 38.

JB LOCK LLC, BOISE, ID:
3,313,192, INT. CL. 6.

JCF ADVISORS, LLC, MILL VALLEY, CA:
3,311,074, PUB. 7-31-2007. INT. CL. 36.

JEAN-CLAUDE BOISSET WINES, USA, INC., SAUSALITO, CA:
3,313,570, INT. CL. 33.

JEANNIE, INC., MILWAUKEE, WI:
3,313,786, INT. CL. 32.

JEFFREY A. MORRISON, LLC, NEW YORK, NY:
3,313,289, INT. CL. 5.

JEI CORPORATION, SEOUL, 110-530, REPUBLIC OF KOREA:
3,310,292, PUB. 7-31-2007. INT. CL. 16.
3,310,293, PUB. 7-31-2007. INT. CL. 16.
3,310,294, PUB. 7-31-2007. INT. CL. 16.
3,310,295, PUB. 7-31-2007. MULTIPLE CLASS, INT. CLS. 16 AND 41.
3,310,296, PUB. 7-31-2007. MULTIPLE CLASS, INT. CLS. 16 AND 41.
3,310,297, PUB. 7-31-2007. MULTIPLE CLASS, INT. CLS. 16 AND 41.
3,310,298, PUB. 7-31-2007. MULTIPLE CLASS, INT. CLS. 16 AND 41.
3,310,299, PUB. 7-31-2007. MULTIPLE CLASS, INT. CLS. 16 AND 41.

JENNIFER CONVERTIBLES, INC., WOODBURY, NY:
2,047,946, REN. 9-10-07. INT. CL. 42.

JENNINGS, ANDREW BLAKE, MESA, AZ:
3,313,888, INT. CL. 9.

JENSEN INFORMATION SYSTEMS, INC., TIGARD, OR:
2,136,682, REN. 9-12-07. INT. CL. 9.

JESSICA SVOBODA, SANTA ANA, CA:
3,311,509, PUB. 7-31-2007. INT. CL. 25.

JEWEL DÉCOR CO., LTD., BANGKOK 10500, THAILAND:
3,310,286, PUB. 7-31-2007. INT. CL. 14.

JEWELX NEW YORK LTD., NEW YORK, NY:
3,313,214, MULTIPLE CLASS, INT. CLS. 14 AND 35.

JEWETT CAMERON LUMBER CORPORATION, NORTH PLAINS, OR:
3,314,184, INT. CL. 6.

JEWISH RENAISSANCE MEDIA, LLC, SOUTHFIELD, MI:
3,314,892, INT. CL. 16.

JH GLOBAL SERVICES, INC., GREENVILLE, SC:
3,310,289, PUB. 7-31-2007. INT. CL. 12.

JIANGSU EVER-GLORY INTERNATIONAL GROUP CORPORATION, NANJING, CHINA:
3,313,862, MULTIPLE CLASS, INT. CLS. 3, 18 AND 25.

JIM SCHWARZ ASSOCIATES, INC., DALLAS, TX:
2,410,259, CANC. INT. CL. 35.

JIMMY JOHN'S ENTERPRISES, LLC, CHAMPAIGN, IL:
3,313,753, INT. CL. 43.

JIMMY TEES INC., BURLINGTON, CANADA:
3,310,498, PUB. 7-31-2007. INT. CL. 25.

JINTHAY TRADING CORP., PORTLAND, OR:
3,312,224, PUB. 7-31-2007. MULTIPLE CLASS, INT. CLS. 35 AND 36.

JJ DENIM, LLC, LOS ANGELES, CA:
3,314,814, INT. CL. 25.

JJ TRADING COMPANY LLC, BOISE, ID:
3,314,571, MULTIPLE CLASS, INT. CLS. 14 AND 35.

JLJ MEDICAL DEVICES INTERNATIONAL, LLC, EDEN PRAIRIE, MN:
3,312,169, PUB. 7-31-2007. INT. CL. 10.

JLM CONNECTIONS, INC., KENOSHA, WI:
2,411,613, CANC. INT. CL. 35.

JLO HOLDING COMPANY, LLC, SANTA MONICA, CA:
3,311,649, PUB. 7-31-2007. MULTIPLE CLASS, INT. CLS. 14, 18 AND 25.

JMH TECHNOLOGIES, LLC, GAINESVILLE, FL:
2,106,186, REN. 9-13-07. INT. CL. 7.

JOBOSAURUS VENTURE HOLDING CO. INC., GREAT NECK, NY:
3,311,095, PUB. 7-31-2007. INT. CL. 35.

JOE BALTAKE, HADDONFIELD, NJ:
3,311,495, PUB. 7-31-2007. INT. CL. 41.

JOE COOPER MANAGEMENT COMPANY, LLC, MIDWEST CITY, OK:
3,310,512, PUB. 7-31-2007. INT. CL. 35.
3,310,514, PUB. 7-31-2007. INT. CL. 35.

JOE, T. Y., LOS ANGELES, CA:
2,410,504, CANC. INT. CL. 41.

JOEY CARNAL, MONROVIA, CA:
2,410,623, CANC. INT. CL. 25.

JOEY'S, INC., SAN ANTONIO, TX:
2,097,435, REN. 9-13-07. INT. CL. 42.

JOHANN EBERHARD GMBH, OISNITZ 39, AUSTRIA:
2,097,693, REN. 9-9-07. INT. CL. 8.

JOHMER, INC., ST. PETERSBURG, FL:
3,313,886, INT. CL. 37.

JOHN BRIAN LOSH, INC., SEATTLE, WA:
3,313,820, MULTIPLE CLASS, INT. CLS. 16, 35 AND 36.

JOHN CRANE INC., MORTON GROVE, IL, JOHN CRANE-HOUDAILLE, INC., MORTON GROVE, IL:
1,446,879, REN. 9-7-07. INT. CL. 42.

JOHN CRANE INC., MORTON GROVE, IL, EG&G SEALOL, CRANSTON, RI:
2,079,050, REN. 9-7-07. INT. CL. 7.

JOHN DEERE CONSUMER PRODUCTS, INC., CHARLOTTE, NC:
2,409,804, CANC. INT. CL. 7.

JOHN DEWAR & SONS LTD, UNITED KINGDOM:
3,063,922, COR. INT. CL. 33.

JOHN GALLIANO S.A., 75020 PARIS, FRANCE, MOHAMED, FAYCAL AMOR, 75003 PARIS, FRANCE:
2,088,483, REN. 9-9-07. INT. CL. 25.

JOHN PAUL MITCHELL SYSTEMS, SANTA CLARITA, CA:
2,143,743, REN. 9-12-07. INT. CL. 3.

JOHN Q INC., LOS ANGELES, CA:
3,311,884, PUB. 7-31-2007. INT. CL. 25.

JOHN R. SHORDIKE, SEBASTOPOL, CA:
3,311,078, PUB. 7-31-2007. INT. CL. 41.
3,311,079, PUB. 7-31-2007. INT. CL. 41.
3,311,080, PUB. 7-31-2007. INT. CL. 41.

JOHN RICH & SONS INVESTMENT HOLDING COMPANY, WILMINGTON, DE:
3,313,484, INT. CL. 25.
3,313,485, INT. CL. 25.
3,313,486, INT. CL. 25.
3,313,487, INT. CL. 25.
3,313,488, INT. CL. 25.
3,313,489, INT. CL. 24.
3,314,213, INT. CL. 20.
3,314,214, INT. CL. 21.
3,314,215, INT. CL. 24.
3,314,216, INT. CL. 27.

JOHN T'S PIPES AND FINE TOBACCOS, BAKERSFIELD, CA, DBA JOHN T'S PIPES AND FINE TOBACCOS:
1,461,259, REN. 9-7-07. INT. CL. 34.

JOHN W GASPARIANI INC, FORT WORTH, TX:
2,086,566, REN. 9-10-07. INT. CL. 42.

JOHN WAGNER ASSOCIATES, INC., ALPINE, UT:
2,409,788, CANC. INT. CL. 6.

- JOHN WIELAND HOMES, INC., ATLANTA, GA:
2,021,078, CANC. INT. CL. 37.
- JOHNCOL, INC., COLUMBUS, OH:
2,410,202, CANC. INT. CL. 36.
- JOHNNIE'S DOG HOUSE, LLC, BERWYN, PA:
3,313,098, INT. CL. 43.
- JOHNNY SUEDE INC., COSTA MESA, CA:
2,410,809, CANC. INT. CL. 25.
- JOHNNY WEAR N.Y. INC., ELMHURST, NY:
3,312,646, PUB. 4-10-2007. INT. CL. 25.
- JOHNSON & JOHNSON, NEW BRUNSWICK, NJ:
3,310,412, PUB. 7-31-2007. INT. CL. 3.
3,310,471, PUB. 7-31-2007. INT. CL. 5.
- JOHNSON FOODS, INC., SUNNYSIDE, WA:
3,311,845, PUB. 7-31-2007. INT. CL. 31.
3,311,846, PUB. 7-31-2007. INT. CL. 29.
- JOHNSON WINDOW FILMS, INC., CARSON, CA:
3,313,951, INT. CL. 17.
- JOHNSON, BRUCE L., MINNEAPOLIS, MN:
3,312,096, PUB. 7-31-2007. INT. CL. 9.
- JOHNSON, CHARLES T., SACHSE, TX, DBA CREATIVE REVELATIONS:
2,410,392, CANC. INT. CL. 20.
- JOHNSON, CHRISTY M., RICHMOND, TX:
3,314,438, INT. CL. 28.
- JOHNSON, GERALD P., OGDEN, UT, DBA TEFCO OF UTAH:
1,418,926, CANC. INT. CL. 6.
- JOHNSON, LEIF BRYNOLF, SEATTLE, WA:
2,410,363, CANC. INT. CL. 42.
- JOHNSON, MICHELE D., DALLAS, GA:
2,410,655, CANC. INT. CL. 38.
- JOHNSON, TIM, AGOURA HILLS, CA:
3,310,872, PUB. 7-31-2007. INT. CL. 35.
- JOHNSTON FARMS, L.L.C., HIGLEY, AZ FROM JOHNSTON FARM, L.P., HIGLEY, AZ:
3,313,236, MULTIPLE CLASS, INT. CLS. 29, 30 AND 43.
- JOHNSTON-MAIN, IAN GEORGE, ARLINGTON, TX:
3,313,529, INT. CL. 42.
- JOLT COMPANY, INC., THE, ROCHESTER, NY:
1,454,568, REN. 9-7-07. INT. CL. 32.
- JON E. HEMSTREET M.D. P.A., TAMPA, FL:
3,311,497, PUB. 7-31-2007. INT. CL. 44.
- JONATHAN DREW INC., MIAMI, FL:
3,313,061, INT. CL. 34.
- JONATHAN DREW, INC., MIAMI, FL, DBA DREW ESTATE:
3,313,832, INT. CL. 34.
- JONATHAN PRODUCT LLC, LINTHICUM HEIGHTS, MD:
3,312,692, PUB. 7-31-2007. INT. CL. 3.
- JONERIC PRODUCTS, INC., HORSHAM, PA, DBA JORDAN DAVID SAFETY PRODUCTS:
2,096,579, REN. 9-13-07. INT. CL. 25.
- JONES, LORRAINE WELLEN, BOYDS, MD:
3,313,510, INT. CL. 28.
- JONES, PATRICK W., HAMPTON COVE, AL:
3,313,554, INT. CL. 35.
- JONES, THOMAS K., MONROE, LA:
2,410,356, CANC. INT. CL. 39.
- JORDAN OUTDOOR ENTERPRISES, LTD., COLUMBUS, GA:
3,313,961, INT. CL. 20.
- JOSEF REIS GMBH & CO. KG, 63839 KLEINWALLSTADT, FED REP GERMANY:
3,312,898, PUB. 7-31-2007. MULTIPLE CLASS, INT. CLS. 9, 18 AND 25.
- JOSEPH C. CLAY AND MARK MAY PARTNERSHIP, THE, PARIS, KY TO CLAY, JOSEPH C. AND WENDY G. CLAY, PARIS, KY:
2,020,629, CANC. INT. CL. 42.
- JOSEPH D. D'AGOSTINO, GRAND ISLAND, NY:
3,311,152, PUB. 7-31-2007. INT. CL. 35.
- JOSEPH F. BLUM, CLU, WEYMOUTH, MA:
2,410,477, CANC. INT. CL. 36.
- JOSTENS, INC., MINNEAPOLIS, MN:
3,312,409, PUB. 7-31-2007. INT. CL. 14.
- JOUBERT, MICHAEL, GRETNA, LA AND FOLSE, ROY, GRETNA, LA:
3,313,088, INT. CL. 7.
- JOURNAL PUBLICATIONS, INC., HARRISBURG, PA:
2,410,693, CANC. INT. CL. 16.
- JOURNÉE LIGHTING, INC., WESTLAKE VILLAGE, CA:
3,314,623, INT. CL. 11.
- JOYCE/DAYTON CORP., DAYTON, OH:
2,603,744, CANC. INT. CL. 6.
- JP AND LEE FOODS, LLC, FARGO, ND:
3,310,785, PUB. 7-31-2007. INT. CL. 30.
- JULIA GHIGLIERI, SAN RAFAEL, CA AND TOM GHIGLIERI, SAN RAFAEL, CA:
2,123,077, REN. 9-7-07. INT. CL. 11.
2,123,078, REN. 9-7-07. INT. CL. 11.
- JULIA KEEFER, NEW YORK, NY:
3,314,481, INT. CL. 41.
- JULIE ANNE DIEHL, TEMECULA, CA:
3,311,419, PUB. 7-31-2007. INT. CL. 28.
- JULIETTE FOWLER HOMES INC., DALLAS, TX:
2,410,058, CANC. INT. CL. 42.
- JULIUS BLUM GESELLSCHAFT M.B.H., INDUSTRIES-TRASSE 1, AUSTRIA:
2,410,894, CANC. MULTIPLE CLASS, INT. CLS. 6 AND 20.
- JUMP ON IN, INC., WESTFORD, MA:
3,311,428, PUB. 7-31-2007. INT. CL. 41.
- JUNO MANUFACTURING, INC., DES PLAINES, IL:
3,314,102, MULTIPLE CLASS, INT. CLS. 9 AND 11.
- JUNO-LOUDOUN, LLC, NORTH PALM BEACH, FL:
3,314,231, INT. CL. 37.
- JUST DRIVE, INC., PORT WASHINGTON, WI:
3,311,855, PUB. 7-25-2006. INT. CL. 41.
- JUST HEAVEN SOAP & BODY PRODUCTS, LLC, SANTA FE SPRINGS, CA:
3,311,194, PUB. 7-31-2007. INT. CL. 3.
- JUST MANUFACTURING COMPANY, FRANKLIN PARK, IL:
3,311,792, PUB. 7-31-2007. INT. CL. 11.
- JUST ONE CALL RESTAURANT MANAGEMENT SERVICES, INC., RIVERHEAD, NY:
2,411,529, CANC. INT. CL. 35.
- JUST RIGHT REALTY CO., FORT MYERS, FL:
3,314,582, INT. CL. 36.
- JUST WHEELS & TIRES CO., HUNTINGTON BEACH, CA:
3,314,265, INT. CL. 12.
- JUSTIN DEAN FAZZARI, ARLINGTON, VA:
3,312,593, PUB. 7-31-2007. INT. CL. 41.
- JUSTMYJOBS.COM, INC., BOULDER, CO:
2,410,881, CANC. INT. CL. 42.
- J7 RECORDS, INC., BATON ROUGE, LA:
3,311,314, PUB. 7-31-2007. INT. CL. 41.
- K & F RESTAURANT MANAGEMENT, LLC, HOUSTON, TX:
3,211,758, NEW CERT. 10-16-2007. INT. CL. 43.
- K & M ENVIRONMENTAL, INC., VIRGINIA BEACH, VA:
3,313,544, INT. CL. 9.
- K & W AGRICHEMICALS INC., OWENS CROSS ROADS, AL:
3,311,113, PUB. 7-31-2007. INT. CL. 1.
- K BEITLER LLC, RUTHERFORD, CA:
3,314,436, INT. CL. 33.
- K K KEMPER, INC., ROUND ROCK, TX:
3,312,091, PUB. 7-31-2007. INT. CL. 41.
- K.H., L.L.C., WICHITA, KS:
3,310,261, PUB. 4-10-2007. INT. CL. 41.
- K.H.S. MUSICAL INSTRUMENT CO., LTD., LUZHOU CITY, TAIWAN:
3,314,862, INT. CL. 15.
- K.P. AUTO CENTER, L.P., INGLEWOOD, CA:
3,314,324, INT. CL. 35.
- KABUSHIKI KAISHA ACCESS, CHIYODA-KU, TOKYO, JAPAN, TA ACCESS CO., LTD.:
3,311,651, PUB. 7-31-2007. MULTIPLE CLASS, INT. CLS. 9, 35, 38 AND 42.
- KABUSHIKI KAISHA ADVICS, AICHI-KEN, JAPAN, DBA ADVICS CO., LTD.:
3,310,245, PUB. 6-26-2007. INT. CL. 12.
- KABUSHIKI KAISHA FAST RETAILING, YAMAGUCHI, JAPAN:
3,310,494, PUB. 7-31-2007. INT. CL. 16.

- KABUSHIKI KAISHA FAST RETAILING, JAPAN:
3,312,820, PUB. 7-31-2007. MULTIPLE CLASS, INT. CLS.
9, 18, 24 AND 25.
3,312,827, PUB. 7-31-2007. MULTIPLE CLASS, INT. CLS.
18 AND 25.
- KABUSHIKI KAISHA HITA TENRYOSUI, OITA-KEN, JA-
PAN:
3,313,514, INT. CL. 32.
- KABUSHIKI KAISHA KOBE SEIKO SHO, CHUO-KU, KOBE,
JAPAN, TA KOBE STEEL, LTD.:
2,124,775. REN. 9-13-07. INT. CL. 7.
- KABUSHIKI KAISHA NTT DOCOMO, CHIYODA-KU, TO-
KYO, JAPAN, DBA NTT DOCOMO, INC.:
3,216,691, COR. MULTIPLE CLASS, INT. CLS. 9, 38 AND
42.
- KABUSHIKI KAISHA NTT DOCOMO, TOKYO, JAPAN,
DBA NTT DOCOMO, INC.:
3,311,626, PUB. 7-31-2007. MULTIPLE CLASS, INT. CLS.
9, 16, 38 AND 42.
- KABUSHIKI KAISHA SEGA, TOKYO, JAPAN, DBA SEGA
CORPORATION:
3,313,258, INT. CL. 9.
3,313,259, INT. CL. 9.
- KABUSHIKI KAISHA SONY COMPUTER ENTERTAIN-
MENT, TOKYO 107-0052, JAPAN, TA SONY COMPUTER
ENTERTAINMENT INC.:
2,098,696. REN. 9-10-07. INT. CL. 9.
- KABUSHIKI KAISHA VOLKS, 600-8396 KYOTO, JAPAN:
3,310,317, PUB. 7-31-2007. INT. CL. 28.
- KABUSHIKI-KAISHA NIHON; KAGAKU GIJUTSU KEN-
SHUJO, JAPAN:
3,312,816, PUB. 7-31-2007. INT. CL. 9.
- KABUSHIKIGAISHA KI-AIKIDO PRODUCTS, TOKYO, 101-
0003, JAPAN:
3,314,919, MULTIPLE CLASS, INT. CLS. 16 AND 41.
- KAGEN, STEVEN L., APPLETON, WI:
2,102,026. REN. 9-7-07. INT. CL. 42.
- KAHNUNA ENTERTAINMENT, LLC, BROOMFIELD, CO:
3,314,252, INT. CL. 43.
- KAI U.S.A., LTD., TUALATIN, OR, DBA KERSHAW KNI-
VES:
3,311,702, PUB. 7-31-2007. INT. CL. 8.
- KAIROS FOUNDATION, THE, KNOXVILLE, TN:
3,310,258, PUB. 7-31-2007. MULTIPLE CLASS, INT. CLS. 9
AND 41.
- KALIL, CAROLYN, PACIFIC PALISADES, CA:
3,313,601, INT. CL. 16.
- KALMBACH PUBLISHING CO., WAUKESHA, WI:
1,497,683. REN. 9-13-07. INT. CL. 16.
- KALWALL CORPORATION, MANCHESTER, NH:
1,074,013. REN. 9-12-07. INT. CL. 17.
- KAMIRAN INC., LOS ANGELES, CA:
3,314,337, INT. CL. 25.
- KANE KLASSICS, HAYWARD, NV:
2,410,806, CANC. INT. CL. 28.
- KANE, TOM, JR., SAINT PAUL, MN AND LOWENSTEIN,
CHAIM, JACKSONVILLE, FL:
3,312,552, PUB. 4-17-2007. INT. CL. 9.
3,312,565, PUB. 4-17-2007. INT. CL. 9.
3,312,571, PUB. 4-17-2007. INT. CL. 9.
3,312,572, PUB. 4-17-2007. INT. CL. 9.
3,312,573, PUB. 4-17-2007. INT. CL. 9.
- KANEBO KABUSHIKI KAISHA (KANEBO, LTD.), SUMIDA-
KU, TOKYO, JAPAN:
2,409,736, CANC. INT. CL. 23.
- KANZAKI PAPER MFG. CO., LTD., CHUO-KU, TOKYO,
JAPAN:
1,419,594, CANC. INT. CL. 16.
- KAPITANELIS, GEORGE, BERGENFIELD, NJ:
3,311,127, PUB. 7-31-2007. INT. CL. 41.
- KAPPLER SAFETY GROUP, INC., GUNTERSVILLE, AL:
2,102,214. REN. 9-13-07. INT. CL. 24.
- KAPPLER, INC., GUNTERSVILLE, AL:
2,111,352. REN. 9-13-07. INT. CL. 17.
- KAPSCH TRAFFICOM AG, A-1121 WIEN, AUSTRIA:
3,312,865, PUB. 7-31-2007. MULTIPLE CLASS, INT. CLS.
9, 36 AND 37.
- KARCH, DALE, ANGOLA, IN AND KARCH, SANDRA,
ANGOLA, IN:
3,310,278, PUB. 7-31-2007. INT. CL. 28.
- KAREN RUSSELL, HOLLYWOOD, CA:
3,311,313, PUB. 7-17-2007. MULTIPLE CLASS, INT. CLS. 9
AND 41.
- KARO BIO AB, HUDDINGE, SWEDEN:
3,311,631, PUB. 7-31-2007. MULTIPLE CLASS, INT. CLS.
1, 5, 10, 14, 16, 25, 42 AND 44.
- KASIM INTERNATIONAL CORP., MIAMI, FL:
3,313,293, INT. CL. 29.
- KASON INDUSTRIES, INC., SHENANDOAH, GA:
2,177,708. REN. 9-9-07. INT. CL. 6.
2,181,603. REN. 9-13-07. INT. CL. 6.
- KASPER, MANUEL, JONA, SWITZERLAND:
3,311,253, PUB. 7-31-2007. INT. CL. 9.
- KASS INDUSTRIAL SUPPLY CORP., BRONX, NY:
3,313,358, INT. CL. 6.
- KATADYN PRODUKTE AG, 8304 WALLISELLEN, SWIT-
ZERLAND:
649,935. REN. 9-7-07. U.S. CL. 6 (INT. CL. 1).
- KATE SPADE LLC, NEW YORK, NY:
3,311,286, PUB. 7-17-2007. INT. CL. 18.
- KAUFFMAN IMAGING LLC, CORDOVA, TN:
3,314,887, INT. CL. 41.
- KAUFMAN, MICHAEL, CHICAGO, IL:
2,411,267, CANC. INT. CL. 36.
- KAYARIAN, LEON M., WARWICK, RI:
3,311,494, PUB. 7-31-2007. INT. CL. 14.
- KECDESIGN, INC. LLC, CHAMPAIGN, IL:
3,312,034, PUB. 7-31-2007. MULTIPLE CLASS, INT. CLS.
35, 37 AND 42.
- KECDESIGN, LLC, CHAMPAIGN, IL:
3,311,638, PUB. 7-31-2007. MULTIPLE CLASS, INT. CLS.
35, 37 AND 42.
- KEDGE HOLDING B.V., NETHERLANDS:
3,312,977, PUB. 7-31-2007. MULTIPLE CLASS, INT. CLS. 9
AND 19.
- KEENAN LLC, HOLLYWOOD, FL:
3,311,285, PUB. 7-31-2007. INT. CL. 35.
- KEENAN, JUDITH L., SEDONA, AZ:
3,310,790, PUB. 7-31-2007. INT. CL. 24.
- KEES GOEBEL MEDICAL SPECIALTY COMPANY, INC.,
HAMILTON, OH:
2,410,015, CANC. INT. CL. 17.
- KEFALONIA, LLC, MURRAY, UT:
3,313,942, INT. CL. 43.
- KELDERMAN MANUFACTURING, INC., OSKALOOSA, IA:
3,312,122, PUB. 7-31-2007. MULTIPLE CLASS, INT. CLS. 7
AND 12.
- KELLOGG NORTH AMERICA COMPANY, BATTLE
CREEK, MI:
3,313,975, INT. CL. 29.
- KEMON S.P.A., SAN GIUSTINO (PERUGIA), ITALY:
3,311,966, PUB. 7-31-2007. INT. CL. 3.
- KEN-A-VISION MANUFACTURING COMPANY, INC.,
KANSAS CITY, MO:
2,115,998. REN. 9-7-07. INT. CL. 41.
- KEN'S CAVE, INC., NEW YORK, NY:
3,314,785, INT. CL. 29.
- KENDALL, CHARLES S., RESTON, VA:
3,312,606, PUB. 7-31-2007. INT. CL. 9.
- KENDLE INTERNATIONAL INC., CINCINNATI, OH:
2,411,540, CANC. MULTIPLE CLASS, INT. CLS. 16 AND
41.
- KENNEDY, WILLIAM L., MANITOU SPRINGS, CO:
3,310,284, PUB. 7-31-2007. INT. CL. 12.
- KENNETH COLE PRODUCTIONS (LIC), INC., NASSAU,
BAHAMAS:
1,458,352. REN. 9-7-07. INT. CL. 18.
- KENNETH GORDON/IAG, INC., NEW ORLEANS, LA:
2,409,700, CANC. INT. CL. 25.
- KENONIC CONTROLS LTD., CALGARY, ALBERTA, CA-
NADA:
2,409,775, CANC. MULTIPLE CLASS, INT. CLS. 9 AND
42.
- KENSCOFF, LLC, DAVENPORT, FL:
2,411,610, CANC. INT. CL. 25.

- KENSINGTON NANNY DEVELOPMENT, ORANGE PARK, FL:
3,314,864, INT. CL. 35.
- KENT STATE UNIVERSITY, KENT, OH:
1,419,501, CANC. INT. CL. 41.
- KENTUCKY PACKAGING SERVICE, L.P., SUN VALLEY, CA:
3,313,473, INT. CL. 10.
- KENTUCKY SCHOOL PLANT MANAGEMENT ASSOCIATION, LEXINGTON, KY:
3,314,881, INT. CL. 35.
- KERNEX MICROSYSTEMS (INDIA) LTD, HYDERABAD, INDIA:
3,314,164, MULTIPLE CLASS, INT. CLS. 9 AND 42.
- KERRY GROUP SERVICES, LTD., TRALEE, COUNTY KERRY, IRELAND:
2,410,925, CANC. INT. CL. 30.
- KEVIN ANDERSON, STUDIO CITY, CA:
3,310,739, PUB. 7-31-2007. INT. CL. 3.
- KEYCORP, CLEVELAND, OH:
3,313,335, INT. CL. 36.
- KEYMORE INTERNATIONAL CO., LTD., JUNGHE CITY, TAIWAN:
3,310,998, PUB. 7-31-2007. INT. CL. 28.
- KEYS ENTERTAINMENT & ADVERTISING, INC., TAVERNIER, FL:
2,411,504, CANC. INT. CL. 41.
- KEYSTONE CONSOLIDATED INDUSTRIES, INC., DALLAS, TX:
3,311,991, PUB. 7-31-2007. INT. CL. 6.
- KEYSTONE FOOD PRODUCTS, INC., EASTON, PA:
2,096,708, REN. 9-7-07. INT. CL. 30.
- KEYSTONE LABORATORIES, INC., MEMPHIS, TN:
2,021,185, CANC. INT. CL. 3.
- KFG GROUP AG, CH-6341 BAAR, SWITZERLAND:
2,097,302, REN. 9-7-07. INT. CL. 9.
- KGO-AM IP, LLC, BURBANK, CA:
1,419,465, CANC. INT. CL. 38.
- KHANMAMEDOV, TOFIK K., SUGARLAND, TX, DBA THE TOFIK K. KHANMAMEDOV COMPANY:
2,158,873, REN. 9-13-07. INT. CL. 1.
- KHAVIDI, SHAHNAZ NOORI, MORTON GROVE, IL:
2,411,036, CANC. INT. CL. 42.
- KHOUGASSIAN SACHA; KHOUGASSIAN SANDIE, FRANCE AND KHOUGASSIAN MICHA; ROZEZ CLARA, ÉPOUSE KHOUGASSIAN, FRANCE:
3,312,752, PUB. 7-31-2007. INT. CL. 9.
3,312,753, PUB. 7-31-2007. INT. CL. 9.
- KIA MOTORS AMERICA, INC., LOS ANGELES, CA:
2,409,997, CANC. INT. CL. 28.
- KIDDE INDUSTRIES, INC., ISELIN, NJ:
1,419,247, CANC. INT. CL. 25.
- KIDS GOLF USA, LOS ANGELES, CA:
3,314,906, INT. CL. 41.
- KIDS KROP SHOP, INC., LAFAYETTE, LA:
2,410,644, CANC. INT. CL. 42.
- KIDS WAY, INC., OLD BETHPAGE, NY:
2,411,457, CANC. INT. CL. 25.
- KIDZ BUSINESS EXPO, SANDY, UT:
3,311,933, PUB. 7-31-2007. INT. CL. 41.
- KIJIJI INTERNATIONAL LIMITED, DUBLIN, IRELAND:
3,313,569, MULTIPLE CLASS, INT. CLS. 35 AND 42.
- KILGOUR, FRENCH & STANBURY, LTD., LONDON, WIX IAF, ENGLAND:
2,020,961, CANC. INT. CL. 25.
- KILMER, RICHARD M., EL DORADO HILLS, CA:
3,313,408, INT. CL. 33.
- KIM, BOOYUN, LA PUENTE, CA:
3,311,555, PUB. 7-31-2007. INT. CL. 9.
- KIM, HYUN, LOS ANGELES, CA:
3,314,682, INT. CL. 25.
- KIM, KWANG HO, REPUBLIC OF KOREA:
3,312,851, PUB. 7-31-2007. INT. CL. 44.
- KIMBALL, RONALD W., MOUNTAIN VIEW, CA:
3,313,287, INT. CL. 42.
- KIMPEN, S.A. DE C.V., MERIDA, MEXICO:
3,312,435, PUB. 7-31-2007. INT. CL. 1.
- KINESIX CORPORATION, HOUSTON, TX:
3,313,964, INT. CL. 9.
- KING OF FLEECE, LLC, WILLIAMSVILLE, NY:
3,314,606, INT. CL. 25.
- KING TECH INDUSTRY INC., SAN DIEGO, CA:
3,311,928, PUB. 7-31-2007. INT. CL. 24.
- KING, ROBERT F., ENCINITAS, CA:
2,410,349, CANC. INT. CL. 25.
- KINGS SMOKEHOUSE AND GRILL, EMPORIA, KS:
3,311,261, PUB. 7-31-2007. INT. CL. 43.
- KINNUNEN, NANCY, SAN FRANCISCO, CA:
3,314,348, INT. CL. 42.
- KINPEL MEDICAL, PC, ACCOKEEK, MD:
3,314,490, INT. CL. 44.
- KIRCHHOEFER, JOHN D., ORLANDO, FL:
3,312,037, PUB. 7-31-2007. INT. CL. 39.
- KIRK, RENEE, PETALUMA, CA, DBA SAGE INTERACTIVE:
2,020,483, CANC. INT. CL. 41.
- KIT CARPET SALES INC., ROUND LAKE BEACH, IL:
2,411,350, CANC. INT. CL. 19.
- KLAFS SAUNABAU GMBH & CO. KG MEDIZINISCHE TECHNIK, 74523 SCHWABISCH HALL, FED REP GERMANY:
3,311,284, PUB. 7-31-2007. MULTIPLE CLASS, INT. CLS. 9 AND 11.
- KLEIN TOOLS, INC., LINCOLNSHIRE, IL:
3,314,722, INT. CL. 4.
- KLEINER, SUSAN M., MERCER ISLAND, WA:
3,310,505, PUB. 7-31-2007. INT. CL. 41.
- KLEINSPORTS LLC, MONTGOMERY, IL:
3,314,794, INT. CL. 28.
- KLICK, INC., SACO, ME:
2,410,911, CANC. INT. CL. 9.
- KLIKLOK CORPORATION, DECATUR, GA:
849,001, REN. 9-10-07. U.S. CL. 23 (INT. CL. 7).
3,314,809, INT. CL. 7.
- KLINGER ADVANCED AESTHETICS, INC., NORWALK, CT:
3,313,752, INT. CL. 3.
- KLONDIKE CHEESE CO., MONROE, WI:
2,410,927, CANC. INT. CL. 29.
- KLUGE, ERIC M, BAMBERG, FED REP GERMANY:
3,314,378, INT. CL. 28.
- KNIGHT, ERIC A., UNIONVILLE, CT:
2,053,652, REN. 9-13-07. INT. CL. 9.
- KNIGHTS OF THE BAR, INC., MARIETTA, GA:
3,314,492, INT. CL. 35.
- KNOWLEDGE ADVENTURE, INC., TORRANCE, CA:
2,136,628, REN. 9-12-07. INT. CL. 9.
- KNOWLEDGE INDUSTRIES, INC., PALO ALTO, CA:
2,020,642, CANC. INT. CL. 9.
- KOBACKER COMPANY, THE, COLUMBUS, OH:
1,419,308, CANC. INT. CL. 25.
- KOBOR CORPORATION, THE, NEW YORK, NY:
1,444,058, REN. 9-13-07. INT. CL. 15.
- KOBRAND CORPORATION, NEW YORK, NY:
3,310,216, PUB. 7-31-2007. INT. CL. 33.
- KODAK S.A.; (SOCIÉTÉ ANONYME FRANÇAISE), FRANCE:
3,312,740, PUB. 7-31-2007. INT. CL. 9.
- KODER, GEMMA V., PALM BEACH GARDENS, FL:
3,313,157, INT. CL. 18.
- KODIAK MOUNTAIN STONE INC., CARDSTON, ALBERTA, CANADA:
3,310,254, PUB. 7-31-2007. INT. CL. 19.
- KOG ENTERPRISES, INC., CHANDLER, AZ:
3,312,226, PUB. 7-31-2007. INT. CL. 35.
- KOHL'S DEPARTMENT STORES, INC., MENOMONEE FALLS, WI:
1,419,301, CANC. INT. CL. 25.
- KOHL'S ILLINOIS, INC., AURORA, IL:
2,478,654, CANC. MULTIPLE CLASS, INT. CLS. 3, 8, 20, 21 AND 28.
- KOHLER CO., KOHLER, WI:
3,311,732, PUB. 7-31-2007. MULTIPLE CLASS, INT. CLS.

- 6, 11, 20 AND 21.
 3,313,341, INT. CL. 11.
 3,313,342, INT. CL. 11.
 3,313,343, INT. CL. 11.
 3,313,344, INT. CL. 11.
 3,313,345, INT. CL. 11.
 3,313,346, INT. CL. 11.
 3,313,347, INT. CL. 11.
- KOLTER HOLDINGS FLORIDA, INC., WEST PALM BEACH, FL:
 3,314,918, INT. CL. 37.
- KOMARO INC., NEW YORK, NY:
 3,310,180, PUB. 7-31-2007. INT. CL. 28.
- KONGSBERG OFFSHORE AS, 3601 KONGSBERG, NORWAY:
 2,411,312, CANC. INT. CL. 37.
- KONGSGAARD WINE LLC, ST. HELENA, CA:
 3,314,670, INT. CL. 33.
- KONINKLIJKE AHOLD N.V., AMSTERDAM, NETHERLANDS:
 2,165,842, REN. 9-13-07. INT. CL. 35.
- KONINKLIJKE PHILIPS ELECTRONICS N.V., EINDHOVEN, NETHERLANDS:
 2,091,025, REN. 9-7-07. INT. CL. 10.
- KONUS ENERGY SYSTEMS, INC., ATLANTA, GA:
 1,419,086, CANC. INT. CL. 11.
- KOP-FLEX, INC., HANOVER, MD:
 3,313,464, INT. CL. 35.
- KOPPERS DELAWARE, INC., WILMINGTON, DE:
 3,313,879, INT. CL. 17.
- KOREA IT INDUSTRY PROMOTION AGENCY, SEOUL, REPUBLIC OF KOREA:
 3,312,405, PUB. 7-31-2007. MULTIPLE CLASS, INT. CLS. 35 AND 36.
- KOREA KYOCHARO COMPANY LIMITED, SEOUL, REPUBLIC OF KOREA:
 3,311,454, PUB. 7-31-2007. INT. CL. 16.
 3,311,455, PUB. 7-31-2007. INT. CL. 16.
- KOSE CORPORATION, CHUO-KU, TOKYO, JAPAN:
 2,411,375, CANC. INT. CL. 3.
- KOSMAN, WILLIAM D., ARDMORE, PA:
 2,410,102, CANC. INT. CL. 35.
- KOST USA, INC., MASON, OH:
 3,313,915, INT. CL. 1.
- KOTLITZKY, AMIRAM, BAKERSFIELD, CA:
 3,310,259, PUB. 7-31-2007. INT. CL. 8.
- KPC-MASTER'S CRAFT INTERNATIONAL, INC., MASSILON, OH:
 3,315,017, INT. CL. 7.
- KRAFT FOODS HOLDINGS, INC., NORTHFIELD, IL,
 KRAFT FOODS, INC., NORTHFIELD, IL:
 2,092,007, REN. 9-13-07. INT. CL. 30.
- KRAFT FOODS HOLDINGS, INC., NORTHFIELD, IL:
 3,314,358, INT. CL. 29.
 3,314,539, INT. CL. 32.
- KRASNOW ENTERPRISES LTD./LES ENTREPRISES KRASNOW LTEE., WESTMOUNT, QUEBEC, CANADA:
 2,020,120, CANC. INT. CL. 25.
- KRASTEL, JOSEPH B., KINGSVILLE, MD:
 3,310,271, PUB. 7-31-2007. INT. CL. 25.
- KRAUS, JOYCE MARIE, NEW YORK, NY:
 2,409,701, CANC. MULTIPLE CLASS, INT. CLS. 18 AND 25.
- KRAUSE PUBLICATIONS, INC., IOLA, WI:
 2,410,325, CANC. INT. CL. 16.
 2,410,330, CANC. INT. CL. 16.
 2,410,333, CANC. INT. CL. 16.
 2,410,335, CANC. INT. CL. 16.
- KRAUSE, VICTOR A., ST. CHARLES, IL:
 3,310,326, PUB. 7-10-2007. INT. CL. 12.
- KRAV MAGA ASSOCIATION OF AMERICA, INC., LOS ANGELES, CA:
 3,310,192, PUB. 10-26-2004. INT. CL. 41.
- KRISTI C. ANDERSON, PC, SCOTTSDALE, AZ:
 3,311,552, PUB. 7-31-2007. INT. CL. 36.
- KRK SYSTEMS, L.L.C., HOLLYWOOD, FL:
 3,311,581, PUB. 7-31-2007. INT. CL. 9.
- KROFF, INC., PITTSBURGH, PA:
 3,312,362, PUB. 7-31-2007. INT. CL. 1.
- KRUEGER INTERNATIONAL, INC., GREEN BAY, WI:
 2,118,406, REN. 9-13-07. MULTIPLE CLASS, INT. CLS. 20 AND 21.
- KRUGER PRODUCTS LIMITED, MISSISSAUGA, ONTARIO:
 3,310,250, PUB. 7-31-2007. INT. CL. 16.
 3,311,921, PUB. 7-31-2007. MULTIPLE CLASS, INT. CLS. 5 AND 16.
- KSL RLP HOLDINGS, LLC, DENVER, CO:
 3,312,511, PUB. 7-31-2007. INT. CL. 44.
- KTR KUPPLUNGSTECHNIK GMBH, D-48432 RHEINE, FED REP GERMANY:
 2,103,130, REN. 9-11-07. INT. CL. 7.
- KUCERA, PATRICK S., OLATHE, KS:
 3,311,713, PUB. 7-31-2007. INT. CL. 45.
- KUDOS FINDER TRADING CO., LTD., TAIPEI, TAIWAN:
 3,314,683, INT. CL. 16.
- KUHTZ, LEE C., EAU CLAIRE, WI:
 3,311,736, PUB. 7-31-2007. INT. CL. 44.
- KULCHA SHOK MUZIK, INC., MIAMI, FL:
 3,312,537, PUB. 7-31-2007. INT. CL. 41.
- KURLAND, TODD, BOSTON, MA, DBA GLOBAL INTERACTION:
 2,410,050, CANC. INT. CL. 42.
- KUSMIK, BILL, FORT COLLINS, CO, DBA THE HEAT EXCHANGE:
 3,313,033, MULTIPLE CLASS, INT. CLS. 11 AND 37.
- KUTCH WINES LLC., SAN FRANCISCO, CA:
 3,314,687, INT. CL. 33.
- KUXIXO, INC., LOS ANGELES, CA:
 2,410,473, CANC. INT. CL. 25.
- KVH INDUSTRIES, INC., MIDDLETOWN, RI:
 2,098,109, REN. 9-13-07. INT. CL. 9.
 2,128,188, REN. 9-13-07. INT. CL. 9.
- KW AUTOMOTIVE NORTH AMERICA, INC., SANGER, CA:
 3,313,307, INT. CL. 12.
- KWIK GOAL, LTD., QUAKERTOWN, PA:
 2,134,267, REN. 9-9-07. INT. CL. 28.
- KWIK PRODUCTS, INC., PHOENIX, AZ:
 3,314,619, INT. CL. 7.
 3,314,620, INT. CL. 7.
- KWIKTOOL USA, INC., CLAYTON, NC:
 3,312,413, PUB. 7-31-2007. INT. CL. 7.
- KWOF SALONS, INC., GLENDALE, WI:
 3,315,020, INT. CL. 44.
- KWON, YOUNG, WALNUT, CA AND KWON, JENNIFER, WALNUT, CA:
 3,311,590, PUB. 7-31-2007. INT. CL. 26.
 3,311,591, PUB. 7-31-2007. INT. CL. 26.
- KYLE JOHNSON, LOS ANGELES, CA:
 3,310,725, PUB. 7-31-2007. INT. CL. 25.
- KYOCERA TYCOM CORPORATION, IRVINE, CA:
 3,313,625, INT. CL. 8.
- KYOKUYO CO., LTD., TOKYO, JAPAN:
 3,314,519, INT. CL. 30.
- KYORITSU GOKIN CO., LTD., NISHINOMIYA-SHI, HYOGO, JAPAN:
 3,312,551, PUB. 7-31-2007. INT. CL. 7.
- K2 INTERNATIONAL CO., LTD., INCHEON, REPUBLIC OF KOREA:
 3,310,499, PUB. 7-17-2007. MULTIPLE CLASS, INT. CLS. 22, 24 AND 25.
- L. M. SCOFIELD COMPANY, LOS ANGELES, CA:
 833,919, REN. 9-7-07. U.S. CL. 16 (INT. CL. 2).
- L.A. GEAR, INC., LOS ANGELES, CA:
 3,313,672, INT. CL. 25.
- L.A. HYDRO-JET & ROOTER SERVICE, INC., SUNVALLEY, CA:
 3,311,924, PUB. 7-31-2007. INT. CL. 37.
- L.A.V.A.I. S.A.S.; DI GIULIANO STATUA & C., I-31021 MOGLIANO VENETO (TV), ITALY:
 3,312,762, PUB. 7-31-2007. MULTIPLE CLASS, INT. CLS. 11 AND 21.
- L.E.K. CONSULTING LLC, BOSTON, MA:
 2,411,210, CANC. INT. CL. 35.

- L.R. NELSON CORPORATION, PEORIA, IL:
1,419,040, CANC. INT. CL. 9.
- L'AIR LIQUIDE SOCIETE ANONYME A DIRECTOINE ET CONSEIL DE SURVEILLANCE POUR L'ETUDE ET L'EXPLOITATION DES PROCEDES GEORGES CLAUDE, 75321 PARIS CEDEX 07, FRANCE, L'AIR LIQUIDE, 75321 PARIS CEDEX 07, FRANCE:
2,089,126, REN. 9-7-07. INT. CL. 1.
- L'OREAL, PARIS, FRANCE:
3,310,848, PUB. 7-31-2007. INT. CL. 3.
3,310,858, PUB. 7-31-2007. INT. CL. 3.
3,314,614, INT. CL. 3.
- L'OREAL USA CREATIVE, INC., NEW YORK, NY:
3,313,586, INT. CL. 3.
3,314,521, INT. CL. 3.
- LA COMPAGNIE D'EXPLOITATION DES SERVICES AUXILIAIRES AERIENS, SERVAVIR, 95726 ROISSY CDG CEDEX, FRANCE:
2,481,437, CANC. MULTIPLE CLASS, INT. CLS. 29, 30, 31, 32 AND 33.
- LA COQUETTE, TAMPA, FL:
3,311,887, PUB. 7-31-2007. INT. CL. 16.
- LA VACA INDEPENDIENTE, S.A. DE C.V., 11800 MEXICO, D.F., MEXICO:
3,311,900, PUB. 7-3-2007. INT. CL. 16.
- LA-CO INDUSTRIES, INC., ELK GROVE VILLAGE, IL:
2,411,121, CANC. MULTIPLE CLASS, INT. CLS. 1 AND 17.
- LABELL S.A., PAUDEX, SWITZERLAND:
3,311,630, PUB. 7-31-2007. MULTIPLE CLASS, INT. CLS. 18, 25, 35 AND 42.
- LABOR FINDERS INTERNATIONAL, INC., PALM BEACH GARDENS, FL:
3,314,507, INT. CL. 35.
- LABORATOIRES DE BIOLOGIE VEGETALE YVES ROCHER, 56200 LA GACILLY, FRANCE:
2,411,467, CANC. INT. CL. 3.
- LABORATORIOS NORUEL, SANTO DOMINGO OESTE, DOMINICAN REP:
3,311,413, PUB. 7-31-2007. INT. CL. 3.
- LACHEEN, DANIEL, MIAMI, FL:
3,311,471, PUB. 7-31-2007. INT. CL. 45.
- LADD, TROY L., BURBANK, CA:
3,312,394, PUB. 7-31-2007. INT. CL. 28.
- LADY GODIVA'S, INC., GRANTSVILLE, WV:
2,171,264, REN. 9-10-07. INT. CL. 42.
2,171,264, CANC. INT. CL. 41.
- LAFEM GIYIM INSAAT; SANAYI VE TICARET LIMITED SIRKETI, TURKEY:
3,312,919, PUB. 7-31-2007. MULTIPLE CLASS, INT. CLS. 25 AND 35.
- LAGUNA DEVELOPMENT CORPORATION, ALBUQUERQUE, NM:
3,311,913, PUB. 4-10-2007. INT. CL. 43.
- LAKELAND INDUSTRIES, INC., RONKONKOMA, NY:
3,313,183, INT. CL. 9.
- LAKELAND INDUSTRIES, INC., RONKONKOMA, NY:
3,313,184, INT. CL. 9.
- LALWANI, STEVEN S., UPPER MONTCLAIR, NJ:
2,410,578, CANC. INT. CL. 35.
- LAMBERT, ERNEST A., CUMBERLAND, RI, DBA LAMBERT & LAMBERT ASSOCIATES:
1,419,445, CANC. INT. CL. 36.
- LAMM, DAVID, BURNSVILLE, MN:
2,411,374, CANC. INT. CL. 36.
- LAMOON, INC., WESTMINSTER, CA:
3,313,133, INT. CL. 3.
- LAN-1 CORPORATION, TAPPAN, NY:
2,020,705, CANC. INT. CL. 37.
- LANCOME PARFUMS ET BEAUTE & CIE, 75008 PARIS, FRANCE:
2,410,067, CANC. INT. CL. 3.
- LANCOME PARFUMS ET BEAUTE & CIE, PARIS, FRANCE:
3,311,156, PUB. 7-31-2007. INT. CL. 3.
3,311,451, PUB. 7-31-2007. INT. CL. 3.
3,312,011, PUB. 7-31-2007. INT. CL. 3.
3,312,189, PUB. 7-31-2007. INT. CL. 3.
- LAND ROVER, WARWICK, WARWICKSHIRE, UNITED KINGDOM:
2,106,324, REN. 9-13-07. INT. CL. 12.
- LANDER CO., INC., WILMINGTON, DE:
1,089,523, REN. 9-13-07. INT. CL. 3.
- LANDER INTANGIBLES CORPORATION, WILMINGTON, DE:
836,059, REN. 9-13-07. U.S. CL. 51 (INT. CLS. 3 AND 5).
- LANDS' END DIRECT MERCHANTS, INC., RICHFIELD, MN:
3,314,386, INT. CL. 18.
- LANDSCAPE STRUCTURES, INC., DELANO, MN:
3,312,393, PUB. 7-31-2007. INT. CL. 36.
- LANE BRYANT PURCHASING CORP., REYNOLDSBURG, OH:
3,314,610, MULTIPLE CLASS, INT. CLS. 16 AND 35.
- LANGCHAO GROUP CO., LTD (LANGCHAO JITUAN YOUXIAN GONGSI), JINAN 250013, SHAN DONG, CHINA:
3,312,720, PUB. 7-31-2007. MULTIPLE CLASS, INT. CLS. 9 AND 42.
- LANGE UHREN GMBH, D-01768 GLASHUTTE, FED REP GERMANY:
2,410,313, CANC. INT. CL. 14.
- LANGER, TODD A., LAFAYETTE, CO:
3,313,165, INT. CL. 28.
- LANGOLF, AARON D, SAN DIEGO, CA:
3,314,669, INT. CL. 43.
- LANGUAGE SYSTEMS INC., WOODLAND HILLS, CA:
2,411,253, CANC. INT. CL. 9.
- LANIER, SEAN RICHARD, AMARILLO, TX:
3,311,217, PUB. 7-31-2007. INT. CL. 42.
- LANMARK CONTROLS, INC., BOXBOROUGH, MA:
3,313,012, INT. CL. 9.
- LANTERNA ALIMENTARI GENOVA S.P.A., ITALY:
3,312,732, PUB. 7-17-2007. INT. CL. 30.
- LAPOINT BLASE IND. INC., ST. LOUIS, MO:
3,310,660, PUB. 7-31-2007. INT. CL. 9.
- LAPPLE, RAINER, VALLEY / OBERLAINDERN, FED REP GERMANY:
2,107,901, REN. 9-8-07. INT. CL. 9.
- LAPTV ATLANTA PARTNERS, ATLANTA, GA:
3,310,803, PUB. 7-10-2007. INT. CL. 38.
- LARKSPUR HOTELS, LLC, CORTE MADERA, CA:
3,312,050, PUB. 7-31-2007. INT. CL. 43.
- LAS 5 ESTACIONES S.P.R. DE R.L., GUANAJUATO, MEXICO:
3,313,696, INT. CL. 31.
- LASALLE BANK CORPORATION, CHICAGO, IL:
3,312,366, PUB. 7-31-2007. INT. CL. 41.
- LASCENT LLC, TOLLAND, CT:
3,311,412, PUB. 7-31-2007. MULTIPLE CLASS, INT. CLS. 3 AND 5.
- LASERUS, INC., EAGLE POINT, OR:
3,314,685, INT. CL. 9.
- LASKO HOLDINGS, INC., WILMINGTON, DE:
3,313,723, INT. CL. 11.
- LASTAR, INC., DAYTON, OH:
2,411,531, CANC. INT. CL. 38.
- LATCHKEY CHILD SERVICES, INC., OKLAHOMA CITY, OK:
3,312,329, PUB. 7-31-2007. INT. CL. 43.
- LATE ROOMS LTD, UNITED KINGDOM:
3,312,869, PUB. 7-31-2007. INT. CL. 43.
- LATTIMORE, LINDA, CARLSBAD, CA:
3,314,952, INT. CL. 35.
- LAUNDRY ATHLETICS LLP, UNITED KINGDOM:
3,312,871, PUB. 7-31-2007. INT. CL. 18.
- LAURA'S LEAN BEEF COMPANY, LEXINGTON, KY:
2,165,065, REN. 9-11-07. INT. CL. 29.
- LAVA CONTROLS, LLC, CONCORDIA, MO:
3,311,351, PUB. 7-31-2007. INT. CL. 9.
- LAW COMPANIES GROUP, INC., ATLANTA, GA TO LAW ENGINEERING AND ENVIRONMENTAL SERVICES, INC., ALPHARETTA, GA:
2,020,177, CANC. INT. CL. 42.

- LAW ENFORCEMENT TECHNOLOGY GROUP, INC., PLYMOUTH, MN:
3,313,781, INT. CL. 9.
- LAW OFFICES OF MICHAEL A. MASTRACCI LLC, BALTIMORE, MD:
3,310,798, PUB. 7-31-2007. INT. CL. 45.
- LAWLEY, SUSAN MARC, CEDAR GROVE, NJ:
3,314,180, MULTIPLE CLASS, INT. CLS. 16 AND 41.
- LAWRENCE STEVENS FASHIONS, INC., NEW YORK, NY:
2,410,215, CANC. INT. CL. 25.
- LAWRENCE STEVENS FASHIONS, LTD., NEW YORK, NY:
2,410,220, CANC. INT. CL. 25.
- LB ICON AB, SE-101 37 STOCKHOLM, SWEDEN:
3,311,687, PUB. 4-10-2007. MULTIPLE CLASS, INT. CLS. 9, 35, 38, 41 AND 42.
- LE GRAND CONFECTIONARY, INC., SACRAMENTO, CA:
3,312,023, PUB. 7-31-2007. INT. CL. 30.
- LEADERSHIP CARES FOUNDATION, GAITHERSBURG, MD:
3,314,379, INT. CL. 41.
- LEADERWORK INTERNATIONAL LIMITED, TORTOLA, BR. VIRGIN ISLANDS:
3,313,714, INT. CL. 16.
- LEAGUE OF AMERICAN THEATRES AND PRODUCERS, INC., THE, NEW YORK, NY:
2,410,941, CANC. INT. CL. 21.
- LEAPFROG ENTERPRISES, INC., EMERYVILLE, CA:
3,314,599, INT. CL. 28.
- LEAPFROG ONLINE CUSTOMER ACQUISITION, LLC, EVANSTON, IL:
3,313,591, INT. CL. 35.
- LEARNING RESOURCES, INC., VERNON HILLS, IL:
3,314,049, INT. CL. 28.
- LEARNINGEXPRESS, LLC, NEW YORK, NY:
2,089,824, REN. 9-7-07. INT. CL. 42.
- LEASE QUOTE, INC., JENKINTOWN, PA:
2,411,003, CANC. INT. CL. 9.
- LEAVITT, CAROLYN R., MIAMI, FL:
3,313,145, INT. CL. 41.
- LEBOWITZ, MATHEW E., AMHERST, MA:
3,310,776, PUB. 7-31-2007. INT. CL. 42.
- LEE CAPITAL MANAGEMENT L.P., BOSTON, MA:
3,313,987, INT. CL. 36.
- LEE'S SANDWICHES INTERNATIONA, INC., SAN JOSE, CA:
3,310,427, PUB. 7-31-2007. INT. CL. 43.
- LEGACY HOCKEY, LLC, PHOENIX, AZ:
3,313,588, INT. CL. 25.
- LEGACY WORLD WIDE, INC., WASHINGTON, DC:
2,411,226, CANC. INT. CL. 28.
- LEGAL AND CORPORATE AFFAIRS OF TERABEAM, INC., SOUTH DEERFIELD, MA:
3,313,633, INT. CL. 9.
3,313,634, INT. CL. 9.
- LEGAL EAGLE, INC., GREENVILLE, SC:
2,092,554, REN. 9-13-07. INT. CL. 42.
- LEGAL SEA FOODS, BOSTON, MA:
3,314,267, INT. CL. 30.
- LEIBOVIT PRODUCTIONS, LTD., LOS ANGELES, CA:
1,419,328, CANC. INT. CL. 28.
- LEICA CAMERA AG, FED REP GERMANY:
3,312,950, PUB. 6-12-2007. INT. CL. 9.
- LEINER HEALTH SERVICES CORP., CARSON, CA:
2,411,228, CANC. INT. CL. 5.
- LEIPZIGER MESSE GMBH, LEIPZIG, FED REP GERMANY:
3,312,763, PUB. 7-31-2007. MULTIPLE CLASS, INT. CLS. 16, 35, 38, 39, 41 AND 42.
- LEKSANDSBRÖD AB, LÖKSAND, SWEDEN:
3,312,726, PUB. 7-31-2007. MULTIPLE CLASS, INT. CLS. 30 AND 32.
- LEMKE, KELLI J., GUTHRIE CENTER, IA, DBA K.D.L. SALES:
2,411,395, CANC. INT. CL. 20.
- LEMON VISION PRODUCTIONS LLC, TEMECULA, CA:
3,314,311, MULTIPLE CLASS, INT. CLS. 9 AND 16.
- LEN STAR WELDING & FABRICATORS LIMITED, TORONTO, ONTARIO, CANADA:
3,313,018, INT. CL. 6.
- LENRYS ASSOCIATES LIMITED, ATTLEBOROUGH, NORFOLK NR17 2QZ, UNITED KINGDOM:
2,410,359, CANC. INT. CL. 5.
- LENTIGEN CORPORATION, BALTIMORE, MD:
3,313,884, MULTIPLE CLASS, INT. CLS. 5, 40 AND 42.
- LENTRADE, INC., HOUSTON, TX, DBA CHANTAL COOKWARE CORP.:
3,314,877, INT. CL. 21.
- LEOMASTER S.P.A., ITALY:
3,312,976, PUB. 7-31-2007. INT. CL. 24.
- LEON CONSTANTIN CONSULTING, INC., NEW YORK, NY:
3,312,066, PUB. 7-31-2007. INT. CL. 35.
- LEONARD KREUSCH, INC., NORTHVALE, NJ:
3,311,348, PUB. 7-31-2007. INT. CL. 33.
- LEONI KABEL HOLDING GMBH & CO. KG, NURNBERG, FED REP GERMANY:
3,313,047, INT. CL. 9.
- LEONIDOVICH, KOGAN IGOR, MARIETTA, GA:
3,310,604, PUB. 7-31-2007. INT. CL. 30.
- LES FILOS PARTICIPACOES E COMERCIO LTDA, SAO PAULO, SP, BRAZIL:
3,313,518, INT. CL. 18.
- LES FILOS PARTICIPAÇÕES E COMERCIO LTDA, SAO PAULO-SP, BRAZIL:
3,313,609, INT. CL. 25.
- LES SCHWAB WAREHOUSE CENTER, INC., PRINEVILLE, OR:
3,314,518, MULTIPLE CLASS, INT. CLS. 35 AND 37.
- LES VINS GEORGES DUBOEUF, LA CHAPELLE DE GUINCHAY, FRANCE:
3,311,992, PUB. 5-29-2007. INT. CL. 33.
3,311,993, PUB. 5-29-2007. INT. CL. 33.
- LESAFFRE ET COMPAGNIE, PARIS, FRANCE:
3,311,851, PUB. 7-31-2007. INT. CL. 30.
- LEUPOLD & STEVENS, INC., BEAVERTON, OR:
3,313,846, INT. CL. 9.
3,313,989, INT. CL. 9.
3,313,994, INT. CL. 9.
- LEVINE, ALISON, SAN FRANCISCO, CA:
3,311,757, PUB. 7-31-2007. INT. CL. 45.
- LEVINE, BLASZAK, BLOCK & BOOTHBY LLP, WASHINGTON, DC:
3,314,050, MULTIPLE CLASS, INT. CLS. 16 AND 41.
- LEVINE, ROBERT I., NATICK, MA:
2,097,605, REN. 9-7-07. INT. CL. 29.
- LEVITATOR, INC., GLENBROOK, NV:
1,418,961, CANC. INT. CL. 7.
- LEVITON MANUFACTURING CO., INC., LITTLE NECK, NY:
2,115,785, REN. 9-13-07. INT. CL. 9.
3,312,576, PUB. 7-31-2007. INT. CL. 9.
- LEWIS BROTHERS BAKERIES, INCORPORATED, EVANSVILLE, IN, DBA LEWIS BAKERIES, INC.:
3,314,581, INT. CL. 30.
- LEWIS, MICHAEL, VISALIA, CA:
3,310,612, PUB. 7-31-2007. INT. CL. 41.
- LEWIS, OWEN M, CWMBRAN, UNITED KINGDOM:
3,314,806, INT. CL. 35.
- LG CHEM, LTD., SEOUL, REPUBLIC OF KOREA:
3,312,620, PUB. 7-31-2007. INT. CL. 17.
- LG ELECTRONICS INC., SEOUL, REPUBLIC OF KOREA:
3,313,545, INT. CL. 9.
- LI HAIBO, ZHEJIANG, CHINA:
3,312,931, PUB. 7-31-2007. INT. CL. 9.
- LI, DONGQING, SHENZHEN CITY, CHINA:
3,314,714, INT. CL. 9.
- LI, JINTAI, DONGGUAN, CHINA:
3,314,775, INT. CL. 9.
- LI, XIONG, LIUYANG, CHINA:
3,310,629, PUB. 7-31-2007. INT. CL. 13.
- LI, XUEYUAN, HACIENDA HEIGHTS, CA:
3,310,782, PUB. 7-31-2007. INT. CL. 35.
- LIANG XIAO BIN, CHINA:
3,312,954, PUB. 7-31-2007. INT. CL. 17.
- LIBRESTREAM TECHNOLOGIES INC., WINNIPEG, MANTOBA, CANADA:
3,312,230, PUB. 7-31-2007. INT. CL. 9.

- LICENCIAS Y EXCLUSIVAS TEXTILES, S.A., 08700 IGUALADA, SPAIN, INDUSTRIAS VALLS, S.A., IGUALADA, BARCELONA, SPAIN:
834,776, REN. 9-7-07. U.S. CL. 39 (INT. CL. 25).
- LIEBERMAN, ERIC, PALM BEACH, FL, DBA SPA TO GO:
2,410,161, CANC. MULTIPLE CLASS, INT. CLS. 35 AND 42.
- LIENFACTORS, LLC, NORTH HAVEN, CT:
3,314,924, INT. CL. 36.
- LIFE OPTICS HANDEL UND VERTRIEB GMBH, A-1190 WIEN, AUSTRIA:
3,310,199, PUB. 7-31-2007. MULTIPLE CLASS, INT. CLS. 9 AND 10.
- LIFE TIME PARADIGM, LLC, IRVINE, CA:
3,314,595, MULTIPLE CLASS, INT. CLS. 36 AND 41.
- LIFECHECK LABORATORY, LLC, OKLAHOMA CITY, OK:
3,311,763, PUB. 7-31-2007. INT. CL. 44.
3,311,764, PUB. 7-31-2007. INT. CL. 16.
- LIFEQUEST VENTURES, LLC, MT. PLEASANT, SC:
1,976,304, CANC. INT. CL. 16.
- LIFESTYLE TECHNOLOGIES, LLC, NEW YORK, NY:
3,313,053, MULTIPLE CLASS, INT. CLS. 35 AND 41.
- LIFETIME BRANDS, INC., GARDEN CITY, NY:
3,314,408, INT. CL. 8.
3,314,666, INT. CL. 21.
- LIFETIME FLOORS, LLC, HUDSON, WI:
3,314,240, INT. CL. 19.
- LIFEWAY CHRISTIAN RESOURCES OF THE SOUTHERN BAPTIST CONVENTION, NASHVILLE, TN:
2,411,338, CANC. INT. CL. 16.
- LIGHT MANUFACTURING CO, PORTLAND, OR:
3,311,869, PUB. 7-31-2007. INT. CL. 1.
- LILA'S RESTAURANT, INC., MIAMI, FL:
3,310,360, PUB. 7-31-2007. INT. CL. 43.
- LIME FINANCIAL SERVICES, LTD., LAKE OSWEGO, OR:
3,310,266, PUB. 7-31-2007. INT. CL. 36.
- LIMITED LIABILITY COMPANY "SANDORA", UKRAINE:
3,312,706, PUB. 7-31-2007. INT. CL. 32.
- LIMONEIRA COMPANY, SANTA PAULA, CA:
233,799, REN. 9-13-07. U.S. CL. 46 (INT. CL. 31).
- LIN, JONATHAN ZHI-HAN, TAIPEI, TAIWAN:
3,311,438, PUB. 7-31-2007. INT. CL. 9.
- LINGOLOOK PUBLISHING LLC, PRINCETON, NJ:
3,314,457, INT. CL. 16.
- LINING SPORTS (SHANGHAI) COMPANY LIMITED, PU-DONG, CHINA:
3,314,634, MULTIPLE CLASS, INT. CLS. 18, 25 AND 28.
- LINING SPORTS (SHANGHAI) COMPANY LIMITED, PU-DONG, SHANGHAI, CHINA:
3,314,636, MULTIPLE CLASS, INT. CLS. 18, 25 AND 28.
- LINK SOURCE, LLC, GOLDEN, CO:
3,311,110, PUB. 7-31-2007. MULTIPLE CLASS, INT. CLS. 37 AND 42.
- LINKS CHOICE LLC, SCOTTSVILLE, VA:
3,313,721, INT. CL. 28.
- LINKS FOR LIFE, INC., BAKERSFIELD, CA:
3,312,296, PUB. 7-31-2007. MULTIPLE CLASS, INT. CLS. 35, 36, 41 AND 45.
- LINOS PHOTONICS GMBH & CO. KG, GOTTINGEN, FED REP GERMANY:
1,467,047, REN. 9-12-07. INT. CL. 9.
- LIOCO WINE COMPANY, LLC, LOS ANGELES, CA:
3,310,619, PUB. 7-31-2007. INT. CL. 33.
- LIONESS FINANCIAL SERVICES, INC., SACRAMENTO, CA:
3,314,246, INT. CL. 36.
- LIPIDEX CORPORATION, DUXBURY, MA:
2,411,353, CANC. INT. CL. 9.
- LIPOTEC S.A., BARCELONA, SPAIN:
3,311,839, PUB. 7-31-2007. MULTIPLE CLASS, INT. CLS. 1, 3 AND 5.
- LIPPER INTERNATIONAL INC., WALLINGFORD, CT:
2,110,311, REN. 9-13-07. INT. CL. 21.
- LIQUID ASSETS, L.L.C., BATON ROUGE, LA:
3,314,127, INT. CL. 35.
- LIQUIDIA TECHNOLOGIES, INC., CHAPEL HILL, NC:
3,313,705, INT. CL. 5.
- LISA HILL, INC., LUBBOCK, TX:
2,169,375, REN. 9-13-07. INT. CL. 35.
- LISA M KADISON, OSSINING, NY:
3,311,151, PUB. 7-31-2007. MULTIPLE CLASS, INT. CLS. 3, 14, 21 AND 44.
- LISA MARIE TAYLOR, JACKSONVILLE, FL:
3,311,196, PUB. 7-31-2007. INT. CL. 35.
- LISTAN GMBH & CO. KG, FED REP GERMANY:
3,312,729, PUB. 7-31-2007. MULTIPLE CLASS, INT. CLS. 9, 38 AND 42.
- LITENS AUTOMOTIVE PARTNERSHIP, WOODBRIDGE, ONTARIO, CANADA:
3,311,759, PUB. 7-31-2007. MULTIPLE CLASS, INT. CLS. 7, 9, 12, 40 AND 42.
- LITIGEX INC., HIGHLAND PARK, IL:
3,311,522, PUB. 7-31-2007. INT. CL. 45.
- LITTLE PAPER COMPANY, INC., MANCHESTER, MA:
2,962,261, CANC. INT. CL. 16.
- LITTLE TIKES COMPANY, THE, FREEPORT, IL:
3,313,456, INT. CL. 28.
- LIVE FIRE TRAINING INSTITUTE, INC., ROYERSFORD, PA:
3,311,939, PUB. 7-31-2007. MULTIPLE CLASS, INT. CLS. 16 AND 41.
- LIVEPERSON, INC., NEW YORK, NY:
3,311,725, PUB. 7-31-2007. INT. CL. 9.
- LIVERNOIS MOTOR SPORTS, LLC, DEARBORN HEIGHTS, MI:
3,312,422, PUB. 7-31-2007. MULTIPLE CLASS, INT. CLS. 35 AND 37.
- LIVHOME, INC., LOS ANGELES, CA:
3,314,224, INT. CL. 45.
- LIVING CENTERS OF AMERICA, INC., HOUSTON, TX TO LCR, INC, ATLANTA, GA:
2,021,289, CANC. INT. CL. 42.
- LNS MEDIA CORPORATION, MCLEAN, VA:
3,311,086, PUB. 7-31-2007. INT. CL. 45.
- LO IACONO, RUBEN, PALMDALE, CA:
3,314,960, INT. CL. 16.
- LO NUESTRO PRODUCTS CORPORATION, SAN ANTONIO, TX:
3,311,561, PUB. 7-31-2007. INT. CL. 30.
- LOAN ALLIANCE INC., FRANKLIN, TN:
3,310,693, PUB. 7-31-2007. INT. CL. 35.
- LOCAL INITIATIVES SUPPORT CORPORATION, NEW YORK, NY:
3,311,282, PUB. 7-31-2007. INT. CL. 41.
- LOCALNEWS, LLC, CHICO, CA:
3,310,638, PUB. 7-31-2007. INT. CL. 41.
- LOCKHEED MARTIN CORPORATION, BETHESDA, MD:
3,312,036, PUB. 7-31-2007. INT. CL. 13.
- LOGAN, CHAD J., ENCINO, CA:
3,310,906, PUB. 7-31-2007. INT. CL. 40.
- LOGANENERGY CORP., ROSWELL, GA:
3,314,313, INT. CL. 37.
- LOGEL, TOBY, PIEDMONT, SC AND BURGAN, ROY E., PIEDMONT, SC:
3,310,328, PUB. 7-31-2007. INT. CL. 36.
- LOGICAL IMAGES, INC., ROCHESTER, NY:
3,311,368, PUB. 7-31-2007. INT. CL. 44.
- LOGICBLOX, INC., ATLANTA, GA:
3,312,600, PUB. 7-31-2007. INT. CL. 42.
- LOGIS MARKET, S.A., 08902 L'HOSPITALET DE LLOBREGAT, SPAIN:
3,312,989, MULTIPLE CLASS, INT. CLS. 35 AND 38.
3,312,990, MULTIPLE CLASS, INT. CLS. 35 AND 38.
- LOLLICUP USA INC., CITY OF INDUSTRY, CA:
3,312,340, PUB. 7-31-2007. INT. CL. 43.
- LOLONIS WINERY, REDWOOD VALLEY, CA:
3,311,492, PUB. 7-31-2007. INT. CL. 33.
- LOMBARDO, STEPHEN J., CHICAGO, IL:
3,310,275, PUB. 7-31-2007. INT. CL. 43.
- LONDON COMMERCIAL DISTRIBUTION, HIALEAH, FL:
3,314,917, INT. CL. 35.
- LONDON, OTIS L., SILVER SPRING, MD:
2,410,449, CANC. INT. CL. 35.
- LONGEVITY ALLIANCE, INC., WASHINGTON, DC:
3,315,014, INT. CL. 36.

- LONGMEADOW HOMES, LLC, ASHEVILLE, NC:
3,311,345, PUB. 7-31-2007. INT. CL. 37.
- LONGO, STEPHEN H., JR., WEST ORANGE, NJ:
2,094,510. REN. 9-7-07. INT. CL. 26.
- LONGS DRUG STORES CALIFORNIA, INC., WALNUT CREEK, CA:
3,313,737, INT. CL. 35.
- LOS CABALLOS DEL VALLE, INC., YUMA, AZ:
3,310,466, PUB. 7-31-2007. INT. CL. 44.
- LOSEY III, WILLIAM A., WILTON, NY:
3,312,643, PUB. 7-31-2007. INT. CL. 36.
- LOUD TECHNOLOGIES INC., WOODINVILLE, WA:
2,090,377. REN. 9-13-07. MULTIPLE CLASS, INT. CLS. 9 AND 16.
- LOUIS VUITTON MALLETIER, FRANCE:
3,312,959, PUB. 7-31-2007. INT. CL. 18.
- LOVELACE IP, LLC, ALBUQUERQUE, NM:
3,311,172, PUB. 7-31-2007. INT. CL. 42.
- LOWELL SHOE, INC., HUDSON, NH TO COLUMBIA INSURANCE COMPANY, OMAHA, NE:
2,021,183, CANC. INT. CL. 25.
2,021,423, CANC. INT. CL. 9.
- LOWY ENTERPRISES, INC., ST. LOUIS, MO TO LOWY GROUP, INC., ST. LOUIS, MO:
1,419,312, CANC. INT. CL. 27.
- LP STYLE, LLC, NEW YORK, NY:
3,313,350, MULTIPLE CLASS, INT. CLS. 18 AND 25.
- LP WHEEL GROUP, INC., LAS VEGAS, NV:
3,314,618, INT. CL. 12.
- LRSMEDIA, LLC, CHICAGO, IL:
3,312,139, PUB. 7-31-2007. INT. CL. 9.
- LU CHENG WU, CHAOYANG DISTRICT, CHINA:
3,312,813, PUB. 7-31-2007. INT. CL. 14.
- LUCAS INNOVATION, INC., W. DST., TAICHUNG CTY, TAIWAN:
3,312,232, PUB. 7-31-2007. INT. CL. 11.
- LUCID FUSION, INC., IRVINE, CA:
3,312,489, PUB. 7-31-2007. INT. CL. 25.
- LUCIDO, DANIELLE, KINGSTON, MA:
3,310,520, PUB. 7-31-2007. INT. CL. 38.
- LUFTHANSA TECHNIK AG, D-22335 HAMBURG, FED REP GERMANY:
2,478,849, CANC. MULTIPLE CLASS, INT. CLS. 6, 9, 11, 12, 16, 20 AND 40.
- LUFTHANSA TECHNIK AG, FED REP GERMANY:
3,312,830, PUB. 7-31-2007. MULTIPLE CLASS, INT. CLS. 9, 35, 41 AND 42.
- LUGGAGE TO GO, INC., GREENBRAE, CA:
3,311,557, PUB. 7-31-2007. INT. CL. 35.
- LUK LAMELLEN UND KUPPLUNGSBAU BEITEILIGUNGS KG, 77815 BUEHL, FED REP GERMANY:
3,312,567, PUB. 7-31-2007. INT. CL. 12.
- LULU BRANDS LLC, WILMINGTON, DE:
3,313,506, INT. CL. 24.
- LUMBER LIQUIDATORS, INC., TOANO, VA:
3,314,120, INT. CL. 19.
- LUMBERJACK'S INC., AKRON, OH:
2,020,839, CANC. INT. CL. 42.
- LUMIFICIENT TECHNOLOGIES, INC., MAPLE GROVE, MN:
3,310,301, PUB. 6-12-2007. INT. CL. 11.
- LUNA CARPET & BLINDS CO., INC., ROSEMONT, IL:
3,311,520, PUB. 7-31-2007. MULTIPLE CLASS, INT. CLS. 35 AND 37.
3,311,521, PUB. 7-31-2007. MULTIPLE CLASS, INT. CLS. 35 AND 37.
- LUNDBERG SURVEY INCORPORATED, CAMARILLO, CA:
1,467,327. REN. 9-10-07. INT. CL. 16.
1,468,294. REN. 9-10-07. INT. CL. 16.
- LUSAFRICA, PARIS, FRANCE:
2,410,603, CANC. INT. CL. 9.
- LYNATE PETTENGILL, LAWRENCE, KS:
3,311,128, PUB. 7-31-2007. INT. CL. 37.
- LYNCH, CECILIA M., SAN FRANCISCO, CA:
3,312,245, PUB. 7-31-2007. INT. CL. 35.
- LYONS GROUP, LTD., BOSTON, MA:
3,310,983, PUB. 7-31-2007. INT. CL. 43.
- M & D INDUSTRIES OF LOUISIANA, INC., LAFAYETTE, LA:
3,314,482, INT. CL. 35.
- M & E PAINTING, LLC, LOVELAND, CO:
3,310,460, PUB. 7-31-2007. INT. CL. 37.
- M REAL ESTATE, PORTLAND, ME:
3,314,198, INT. CL. 37.
- M T B ADVENTURES LLC, LITTLETON, CO:
2,410,607, CANC. INT. CL. 28.
- M. M. FOWLER, INC., DURHAM, NC:
3,313,226, INT. CL. 35.
- M.G. VULPINARI; DI MARIA GABRIELLA VULPINARI, ITALY:
3,312,884, PUB. 7-31-2007. INT. CL. 25.
- M.G.C. LAMPS LTD., IPSWICH, SUFFOLK IP1 5AP, UNITED KINGDOM:
2,020,409, CANC. INT. CL. 11.
- M.I.M.T. CORPORATION OF USA, NORTHRIDGE, CA:
2,130,111. REN. 9-13-07. INT. CL. 30.
- M-I L.L.C., HOUSTON, TX:
3,312,644, PUB. 4-17-2007. INT. CL. 7.
- MA CHER (USA), INC., VENICE, CA:
3,312,608, PUB. 7-31-2007. INT. CL. 35.
- MA'ANSHAN FANGYUAN SLEWING RING COMPANY LIMITED, ANHUI PROVINCE, CHINA:
3,312,279, PUB. 7-31-2007. INT. CL. 7.
- MAAX CANADA INC., LACHINE, QUEBEC, CANADA:
3,312,103, PUB. 7-31-2007. INT. CL. 11.
- MAC PUBLISHING L.L.C., SAN FRANCISCO, CA:
2,410,380, CANC. INT. CL. 42.
- MACARONI KIDS INC., PIEDMONT, CA:
2,409,830, CANC. INT. CL. 25.
- MACDERMID ACUMEN, INC., MIDDLETOWN, DE, ALIED RESEARCH PRODUCTS, INC., BALTIMORE, MD:
851,606. REN. 9-9-07. U.S. CL. 52 (INT. CL. 1).
- MACDERMID ACUMEN, INC., MIDDLETOWN, DE, MACDERMID, INCORPORATED, WATERBURY, CT:
2,167,515. REN. 9-9-07. INT. CL. 1.
- MACERICH PARTNERSHIP, L.P., THE, SANTA MONICA, CA:
2,410,248, CANC. INT. CL. 35.
- MACK SOFTWARE SOLUTIONS, INC., FRISCO, TX:
3,310,331, PUB. 7-31-2007. INT. CL. 9.
3,313,075, INT. CL. 9.
- MACMONAGLE, GERRI P., FAIRFIELD, CT:
2,021,210, CANC. INT. CL. 41.
- MACNEILL ENGINEERING COMPANY, INC., MARLBOROUGH, MA:
2,411,154, CANC. INT. CL. 25.
- MACRO INTERNATIONAL, INC., CALVERTON, MD:
3,310,489, PUB. 7-31-2007. INT. CL. 35.
- MACROTEC SECURITY CORP., FAYETTEVILLE, NC:
3,310,681, PUB. 7-17-2007. INT. CL. 45.
- MAD MAPS, INC., SAN FRANCISCO, CA:
3,312,302, PUB. 7-31-2007. INT. CL. 16.
3,312,303, PUB. 7-31-2007. INT. CL. 16.
- MADDOG TOYS, INC., RUXTON, MD:
3,311,038, PUB. 7-31-2007. INT. CL. 28.
- MADEJ, MALGORZATA, BOSTON, MA:
3,311,041, PUB. 7-31-2007. INT. CL. 41.
3,311,042, PUB. 7-31-2007. INT. CL. 41.
- MADISON SQUARE GARDEN L.P., NEW YORK, NY, MADISON SQUARE GARDEN CORPORATION, NEW YORK, NY:
835,284. REN. 9-9-07. U.S. CL. 107 (INT. CL. 41).
- MADLER PTY LIMITED, ST. IVES NSW 2075, AUSTRALIA:
3,313,005, INT. CL. 30.
- MADSHUS A/S, BIRI, NORWAY:
3,313,503, INT. CL. 28.
- MAGAL SECURITY SYSTEMS LTD., YEHUD 56100, ISRAEL:
3,313,160, INT. CL. 9.
3,313,161, INT. CL. 9.
- MAGASSY, CSABA L., MCLEAN, VA:
2,161,761. REN. 9-10-07. INT. CL. 42.
- MAGIC AMERICAN PRODUCTS, INC., BEDFORD HEIGHTS, OH:
3,312,033, PUB. 7-31-2007. MULTIPLE CLASS, INT. CLS. 3

- AND 8.
- MAGIC CASTLES, INC., HOLLYWOOD, CA:
3,311,068, PUB. 7-31-2007. INT. CL. 28.
- MAGIC FUR BALL, LLC, LAFAYETTE, IN:
3,310,615, PUB. 7-31-2007. INT. CL. 3.
- MAGIE VIRTUELLE, INC., MONTREAL, QUEBEC, CANADA, DBA TOMOVISION:
3,312,017, PUB. 7-31-2007. INT. CL. 9.
3,312,020, PUB. 7-31-2007. INT. CL. 9.
- MAGIKIST LTD., WINNIPEG, CANADA:
3,310,656, PUB. 7-31-2007. INT. CL. 9.
- MAGIS GROUP, INC., TARRYTOWN, NY:
3,310,714, PUB. 7-31-2007. INT. CL. 36.
- MAGNUM CASH ADVANCE, INCORPORATED, WILMINGTON, DE:
3,311,712, PUB. 8-29-2006. INT. CL. 36.
- MAGOTTEAUX INTERNATIONAL, SOCIÉTÉ ANONYME, BELGIUM:
3,312,777, PUB. 7-31-2007. INT. CL. 7.
- MAGYAR, DONALD W., WINTER SPRINGS, FL:
3,314,487, U.S. CL. 200.
- MAHAL, DAVID G., MARINA DEL REY, CA, DBA DGM ASSOCIATES:
2,020,821, CANC. INT. CL. 16.
- MAHARAM FABRIC CORPORATION, NEW YORK, NY:
1,468,379. REN. 9-10-07. INT. CL. 24.
- MAHARISHI AYUR-VED PRODUCTS INTERNATIONAL, INC., COLORADO SPRINGS, CO:
2,097,845. REN. 9-9-07. INT. CL. 5.
2,101,580. REN. 9-9-07. INT. CL. 5.
2,101,581. REN. 9-9-07. INT. CL. 5.
2,101,582. REN. 9-9-07. INT. CL. 5.
2,101,583. REN. 9-9-07. INT. CL. 30.
- MAHARISHI FOUNDATION, LTD., ST. HELIER JERSEY JE4 8YZ, CHANNEL ISLANDS:
1,082,923. REN. 9-9-07. INT. CL. 41.
- MAIDEN VOYAGE ENTERPRISES, LLC, HUBERTUS, WI:
3,310,555, PUB. 7-31-2007. INT. CL. 3.
- MAILLET, STACEY A., BROOKLYN, NY:
3,311,312, PUB. 7-17-2007. INT. CL. 25.
- MAIN INTERNETWORKS, INC., THE, WATERVILLE, ME:
2,410,020, CANC. INT. CL. 38.
- MAJOR LEAGUE SOCCER, LLC, NEW YORK, NY:
2,091,895. REN. 9-10-07. MULTIPLE CLASS, INT. CLS. 16, 25 AND 41.
- MAKEPEACE, CLAYTON, SARASOTA, FL:
3,313,732, INT. CL. 35.
3,313,733, INT. CL. 35.
- MALABAR PRODUCTOS NATURALES, L.L.C., SAN ANTONIO, TX:
3,312,320, PUB. 7-31-2007. INT. CL. 5.
- MALACHI GROUP, INC., THE, SUGAR LAND, TX:
2,410,348, CANC. INT. CL. 36.
- MALE POUCH, INC., NORTH PALM BEACH, FL:
3,313,021, INT. CL. 25.
- MALLORY & CHURCH, LLC, SEATTLE, WA:
1,459,287. REN. 9-9-07. INT. CL. 25.
- MAMA JIM'S PIZZA, INC., FARMERS BRANCH, TX:
3,310,358, PUB. 7-17-2007. INT. CL. 39.
- MAN-MADE ENTERPRISES, L.P., AUBURN, WA:
3,310,876, PUB. 7-31-2007. INT. CL. 16.
- MANAGEMENT COMPUTER CONTROLS, INC., MEMPHIS, TN:
3,310,624, PUB. 7-31-2007. MULTIPLE CLASS, INT. CLS. 9 AND 16.
- MANASOTA RESIDENTIAL REAL ESTATE INC., ELLENTON, FL:
3,310,828, PUB. 7-31-2007. INT. CL. 36.
- MANCINE COSMETICS PTY LTD, MORDIALLOC, AUSTRALIA:
3,310,748, PUB. 7-31-2007. INT. CL. 3.
3,310,750, PUB. 7-31-2007. INT. CL. 3.
- MANCINI GIUFFRE SALON, LTD, STATEN ISLAND, NY:
3,310,943, PUB. 7-31-2007. INT. CL. 44.
- MANCO, INC., AVON, OH:
2,411,127, CANC. INT. CL. 20.
- MANDEL GROUP, INC., MILWAUKEE, WI:
3,312,231, PUB. 7-31-2007. INT. CL. 37.
- MANHATTAN INN OPERATING COMPANY, LLC, MANHATTAN BEACH, CA:
3,311,353, PUB. 7-31-2007. INT. CL. 43.
- MANN, SEAN E., TRAPPE, MD:
3,311,166, PUB. 7-31-2007. INT. CL. 28.
- MANN, VIRGINIA C., TEMPLE, TX, DBA SIAMESE PRODUCTIONS LTD.:
2,409,992, CANC. INT. CL. 42.
- MANNING TURK, LLC, DARIEN, CT:
3,313,187, INT. CL. 18.
- MANPOWER INTERNATIONAL INC., MILWAUKEE, WI TO MANPOWER INC., MILWAUKEE, WI:
2,021,479, CANC. INT. CL. 35.
- MANUFACTURE D'ARMES FINES VERREES ET CIE, LIEGE, BELGIUM:
3,311,093, PUB. 7-31-2007. INT. CL. 13.
- MANUFACTURING JEWELERS AND SUPPLIERS OF AMERICA, INC., PROVIDENCE, RI:
2,410,346, CANC. U.S. CL. 200.
- MANUFACTURING TECHNOLOGY, INC., SOUTH BEND, IN:
1,070,910. REN. 9-13-07. INT. CL. 7.
- MAPCO EXPRESS, INC., BRENTWOOD, TN:
3,313,854, INT. CL. 43.
3,314,103, INT. CL. 35.
- MAPLE CITY RUBBER COMPANY, INC., THE, NORWALK, OH:
2,134,677. REN. 9-9-07. INT. CL. 28.
- MAPLE TECHNOLOGIES, LLC, MANALAPAN, NJ:
3,311,404, PUB. 7-31-2007. INT. CL. 42.
- MAR-LEN CONFECTIONS, INC., LARGO, FL:
3,312,156, PUB. 7-31-2007. INT. CL. 30.
- MARBERT COSMETICS GMBH, FED REP GERMANY:
3,312,939, PUB. 7-31-2007. INT. CL. 3.
- MARBLE KARE PRODUCTS, INC., BOCA RATON, FL:
3,310,544, PUB. 7-31-2007. INT. CL. 2.
3,310,545, PUB. 7-31-2007. INT. CL. 3.
- MARCH COMMUNITY CREDIT UNION, MORENO VALLEY, CA:
3,313,196, INT. CL. 36.
- MARCO OPHTHALMIC, INC., JACKSONVILLE, FL:
3,311,270, PUB. 7-31-2007. INT. CL. 10.
- MARCO POLO PUBLICATIONS, INC., SAINT PETERSBURG, FL:
3,312,607, PUB. 4-24-2007. INT. CL. 35.
- MARDX DIAGNOSTICS, INC., CARLSBAD, CA:
2,132,624. REN. 9-8-07. MULTIPLE CLASS, INT. CLS. 1 AND 5.
- MARETH, PAUL D., JONESBOROUGH, TN, DBA PROJECTIONS COMPANY:
1,459,658. REN. 9-11-07. INT. CL. 42.
- MARGARITAVILLE ENTERPRISES, LLC, PALM BEACH, FL:
3,314,327, INT. CL. 7.
3,314,328, INT. CL. 7.
- MARIN, CHRISTIAN J., SAN JOSE, CA AND MARIN, ROBERT J., SAN JOSE, CA:
3,313,653, INT. CL. 25.
- MARINE BOULEVARD NO. 9 CC, BLOUBERG, 7441, SOUTH AFRICA:
3,312,985, INT. CL. 38.
3,312,986, INT. CL. 42.
3,312,987, INT. CL. 35.
- MARIO A. BAYNE, PHOENIX, AZ:
2,108,303. REN. 9-10-07. INT. CL. 42.
- MARIO VALENTINO S.P.A., NAPOLI, ITALY, VALENTINO, MARIO, NAPOLI, ITALY:
1,454,256. REN. 9-11-07. MULTIPLE CLASS, INT. CLS. 18 AND 25.
- MARIO VALENTINO S.P.A., NAPOLI, ITALY:
1,455,215. REN. 9-8-07. MULTIPLE CLASS, INT. CLS. 18 AND 25.
1,455,215, CANC. INT. CL. 16.
- MARISOL INTERNATIONAL LLC, SPRINGFIELD, MO:
3,312,084, PUB. 7-31-2007. MULTIPLE CLASS, INT. CLS. 35 AND 39.
- MARK INFORMATION A/S, DENMARK:
3,312,733, PUB. 7-31-2007. MULTIPLE CLASS, INT. CLS.

- 9, 16, 35, 36, 37 AND 42.
MARK SIMONSON, MD, OJAI, CA:
3,310,613, PUB. 7-31-2007. INT. CL. 44.
MARKEL, HEATHER J, NEW YORK, NY:
3,314,579, MULTIPLE CLASS, INT. CLS. 41 AND 45.
MARKEL, HEATHER JILL, NEW YORK, NY:
3,311,554, PUB. 7-31-2007. INT. CL. 18.
MARKET COLLECTION INC., THE, MARBLEHEAD, MA:
2,101,696. REN. 9-13-07. INT. CL. 25.
MARKETDELTA, LLC, AURORA, IL:
3,310,825, PUB. 7-31-2007. INT. CL. 9.
MARKETING AND CONSULTANT SERVICES, INC., WICHITA, KS:
3,312,618, PUB. 4-17-2007. INT. CL. 41.
3,312,619, PUB. 4-17-2007. INT. CL. 41.
MARKETING SYSTEMS OF AMERICA, INC., WEST PALM BEACH, FL:
2,410,905, CANC. INT. CL. 3.
MARKETING TOOLS, INC., GRAND RAPIDS, MI:
3,314,985, INT. CL. 35.
MARKETING.COMM, INC., OVERLAND PARK, KS:
2,409,881, CANC. INT. CL. 42.
MARKETPLACE TECHNOLOGIES, CAMBRIDGE, MA:
3,311,031, PUB. 7-31-2007. INT. CL. 35.
MARKETSPACE COMMUNICATIONS, LLC, CRANBERRY TOWNSHIP, PA:
3,313,971, MULTIPLE CLASS, INT. CLS. 35 AND 42.
MARKETWARE COPORATION, NORCROSS, GA:
2,411,466, CANC. INT. CL. 35.
MARKEY'S VIDEO IMAGES, LLC, INDIANAPOLIS, IN:
3,314,652, INT. CL. 9.
MARKLIN HOLDING GMBH, 73037 GOPPINGEN, FED REP GERMANY:
2,410,062, CANC. INT. CL. 28.
MARKOWITZ, PAULA, TEANECK, NJ:
1,419,189, CANC. MULTIPLE CLASS, INT. CLS. 18 AND 24.
MARKS, DAVID, LANCASTER, PA:
3,311,376, PUB. 7-31-2007. MULTIPLE CLASS, INT. CLS. 5 AND 35.
MARKSLÖJD AB, SWEDEN:
3,312,804, PUB. 7-31-2007. INT. CL. 11.
MARLENA INTERNATIONAL, LLC., LAWRENCEVILLE, GA:
3,310,282, PUB. 7-31-2007. INT. CL. 24.
MARLYN NUTRACEUTICALS, INC., PHOENIX, AZ, DBA NATURALLY VITAMINS:
3,310,189, PUB. 7-31-2007. INT. CL. 5.
MAROONEY, KIMBERLY, SAN DIEGO, CA:
2,021,013, CANC. INT. CL. 16.
MARQUEZ BROTHERS INTERNATIONAL, INC., SAN JOSE, CA:
3,313,130, INT. CL. 29.
MARRERO WEALTH MANAGEMENT, LLC, BATON ROUGE, LA:
3,310,887, PUB. 7-31-2007. INT. CL. 36.
3,310,889, PUB. 7-31-2007. INT. CL. 36.
MARRIOTT INTERNATIONAL, INC., BETHESDA, MD:
3,313,610, INT. CL. 43.
3,314,044, INT. CL. 35.
MARS, INCORPORATED, MCLEAN, VA:
2,411,514, CANC. INT. CL. 30.
3,311,506, PUB. 7-31-2007. INT. CL. 35.
3,311,507, PUB. 7-31-2007. INT. CL. 35.
3,313,237, INT. CL. 29.
3,313,325, INT. CL. 31.
3,314,352, INT. CL. 30.
3,314,827, INT. CL. 3.
MARSDEN BLDG MAINTENANCE, L.L.C., ST. PAUL, MN:
3,312,024, PUB. 7-31-2007. INT. CL. 37.
MARSELLUS CASKET COMPANY, SYRACUSE, NY:
2,020,832, CANC. INT. CL. 20.
MARSHALL & SWIFT/BOECKH, LLC, LOS ANGELES, CA:
3,312,410, PUB. 7-31-2007. MULTIPLE CLASS, INT. CLS. 9 AND 36.
3,312,411, PUB. 7-31-2007. MULTIPLE CLASS, INT. CLS. 9 AND 36.
MARTHA STEWART LIVING OMNIMEDIA, INC., NEW YORK, NY:
3,313,881, INT. CL. 9.
MARTIN RAY WINERY, INC., SANTA ROSA, CA:
3,314,209, INT. CL. 33.
MARTIN, JUDEE, SANTA BARBARA, CA:
3,310,368, PUB. 7-31-2007. INT. CL. 3.
MARTIN, VICTOR L., SR., IRWINDALE, CA:
3,313,630, INT. CL. 30.
MARTINDALE, WINK, CALABASAS, CA AND QUINTANA, RICARDO, VIRGINIA BEACH, VA:
2,411,426, CANC. INT. CL. 41.
2,411,427, CANC. INT. CL. 9.
MARTINEZ, CASEY, NORCO, CA:
3,313,803, INT. CL. 25.
MARTINI, LLC, COLUMBIA, MD, DBA GAME TIME MARKETING:
3,313,621, INT. CL. 35.
MARVEL CHARACTERS, INC., BEVERLY HILLS, CA:
2,411,372, CANC. INT. CL. 16.
3,311,091, PUB. 7-31-2007. INT. CL. 28.
MARWI TAIWAN INDUSTRIAL CO. LTD., TACHIA TOWN, TAICHUNG HSIEN, TAIWAN:
2,143,614, REN. 9-13-07. MULTIPLE CLASS, INT. CLS. 11 AND 12.
MARY KAY INC., ADDISON, TX:
3,312,681, PUB. 7-31-2007. INT. CL. 9.
MARYLAND/ISRAEL DEVELOPMENT CENTER, INC., BALTIMORE, MD:
3,312,193, PUB. 7-31-2007. INT. CL. 35.
MAS QUE VINOS GLOBAL, S.L., SPAIN:
3,312,968, PUB. 7-31-2007. INT. CL. 33.
MASEEH, FARIBORZ, NEWPORT BEACH, CA:
3,166,104, COR. MULTIPLE CLASS, INT. CLS. 36 AND 41.
MASON COMPANIES, INC., CHIPPEWA FALLS, WI:
2,030,018, REN. 9-13-07. INT. CL. 42.
2,048,991, REN. 9-11-07. INT. CL. 42.
MASON-DIXON RESCUE DOGS, INC., ABINGDON, MD:
3,312,485, PUB. 7-31-2007. INT. CL. 39.
MASON, TERRY, CHICAGO, IL:
1,419,538, CANC. INT. CL. 42.
MASSACHUSETTS FINANCIAL SERVICES COMPANY, BOSTON, MA:
3,311,236, PUB. 7-31-2007. INT. CL. 36.
MASTER LOCK COMPANY LLC, OAK CREEK, WI:
2,410,992, CANC. INT. CL. 6.
MASTER'S BIBLE CHURCH, DENVER, CO:
3,310,973, PUB. 7-31-2007. INT. CL. 45.
MASTERVISION, INC., NEW YORK, NY:
1,457,282, REN. 9-13-07. INT. CL. 9.
MAT, INC., FLOODWOOD, MN:
3,314,886, INT. CL. 31.
MATAMIS, TED, MT. PROSPECT, IL:
1,419,151, CANC. INT. CL. 16.
MATERIAL SCIENCES CORPORATION, ENGINEERED MATERIALS AND SOLUTIONS GROUP, INC., ELK GROVE VILLAGE, IL:
3,313,066, INT. CL. 6.
MATEVEZA, LLC, SAN FRANCISCO, CA:
3,314,818, INT. CL. 32.
MATSUSADA PRECISION, INC., JAPAN:
3,312,915, PUB. 7-31-2007. INT. CL. 9.
MATSUSHITA ELECTRIC WORKS, LTD., OSAKA, JAPAN:
2,410,966, CANC. INT. CL. 9.

- MATTEL, INC., EL SEGUNDO, CA:
 1,461,136, REN. 9-11-07. INT. CL. 28.
 2,410,994, CANC. INT. CL. 28.
 2,411,244, CANC. INT. CL. 28.
 2,411,302, CANC. INT. CL. 28.
 2,411,332, CANC. INT. CL. 28.
 3,312,337, PUB. 7-31-2007. INT. CL. 9.
 3,312,529, PUB. 7-31-2007. INT. CL. 28.
 3,312,530, PUB. 7-31-2007. INT. CL. 28.
 3,312,595, PUB. 7-31-2007. INT. CL. 28.
 3,312,610, PUB. 7-31-2007. INT. CL. 28.
 3,312,611, PUB. 7-31-2007. INT. CL. 28.
 3,312,612, PUB. 7-31-2007. INT. CL. 28.
 3,312,613, PUB. 7-31-2007. INT. CL. 28.
 3,313,461, INT. CL. 28.
 3,313,808, INT. CL. 28.
 3,314,020, INT. CL. 28.
 3,314,660, INT. CL. 28.
 3,314,661, INT. CL. 28.
 3,314,702, INT. CL. 28.
 3,314,978, INT. CL. 28.
 3,315,023, INT. CL. 28.
- MATTERHORN ICE CREAM COMPANY, THE, SEATTLE, WA:
 2,410,746, CANC. INT. CL. 30.
- MATTRESS DISCOUNTERS CORPORATION, UPPER MARLBORO, MD:
 2,411,420, CANC. INT. CL. 20.
- MATTUS, INC., GIBSONIA, PA, DBA KEMMA SOFTWARE:
 2,410,538, CANC. INT. CL. 9.
- MAUMEE PLUMBING & HEATING SUPPLY, INC., PERYSBURG, OH:
 3,314,737, INT. CL. 35.
- MAUNEY, TERRY L., CHARLOTTE, NC:
 2,410,983, CANC. INT. CL. 25.
- MAVETY MEDIA GROUP LTD., NEW YORK, NY:
 2,410,901, CANC. INT. CL. 16.
- MAX CONTROL SYSTEMS INC., LANSDALE, PA TO METSO AUTOMATION MAX CONTROLS, INC., LANSDALE, PA:
 2,486,428, CANC. INT. CL. 42.
- MAXFIELD, ANTHONY, R., HALEIWA, HI:
 3,312,653, PUB. 7-31-2007. INT. CL. 3.
- MAXY TRADING CORP., CARLSTADT, NJ:
 3,311,828, PUB. 7-31-2007. INT. CL. 25.
- MAYER-BERKSHIRE CORPORATION, WAYNE, NJ:
 1,475,045, REN. 9-13-07. INT. CL. 25.
- MAYFIELD, TAMARA YVONNE, ROCK HILL, SC:
 3,311,936, PUB. 7-31-2007. INT. CL. 25.
- MAYR-MELNHOF HOLZ LEOBEN GMBH, AUSTRIA:
 3,312,718, PUB. 7-31-2007. INT. CL. 19.
- MAYTAG CORPORATION, NEWTON, IA:
 3,314,310, INT. CL. 7.
- MAZZANTI, INC., HOBOKEN, NJ:
 3,314,929, INT. CL. 42.
- MBNA AMERICA BANK, NATIONAL ASSOCIATION, NEWARK, DE:
 2,020,104, CANC. INT. CL. 36.
- MCC BROADCASTING COMPANY, INC., BOSTON, MA:
 2,020,735, CANC. INT. CL. 38.
 2,020,738, CANC. INT. CL. 38.
- MCCABE, BERNARD P., CLARKSTON, WA:
 2,410,009, CANC. INT. CL. 11.
- MCCASSY V, MALCOLM C., IRVINE, CA:
 3,313,394, INT. CL. 25.
- MCCORMICK & COMPANY, INCORPORATED, SPARKS, MD:
 2,183,132, REN. 9-10-07. INT. CL. 30.
- MCCOY INC., HOUSTON, TX:
 2,020,208, CANC. MULTIPLE CLASS, INT. CLS. 36, 37, 39 AND 42.
- MCCULLOCH, JOHN, MORROW, OH:
 3,313,656, INT. CL. 33.
- MCDANIELS, DARRYL, NEW YORK, NY:
 3,310,249, PUB. 7-10-2007. MULTIPLE CLASS, INT. CLS. 9, 25 AND 41.
- MCDONALD, KEVIN R., JACKSONVILLE, FL:
 2,411,614, CANC. INT. CL. 35.
- MCGARRY, ERIN, CLIFTON PARK, NY:
 3,310,556, PUB. 7-31-2007. INT. CL. 25.
- MCGEEVER, LLC, PAINESVILLE, OH:
 3,310,437, PUB. 7-31-2007. INT. CL. 35.
- MCI COMMUNICATIONS CORPORATION, WASHINGTON, DC:
 1,419,463, CANC. INT. CL. 38.
 2,409,694, CANC. INT. CL. 38.
- MCKESSON HEALTH SOLUTIONS LLC, ALPHARETTA, GA:
 3,312,300, PUB. 7-31-2007. MULTIPLE CLASS, INT. CLS. 9 AND 16.
- MCKINNON BROADCASTING COMPANY, SAN DIEGO, CA:
 3,311,203, PUB. 7-31-2007. MULTIPLE CLASS, INT. CLS. 38 AND 41.
 3,311,205, PUB. 7-31-2007. MULTIPLE CLASS, INT. CLS. 38 AND 41.
- MCLAREN, ROBERT R., COLORADO SPRINGS, CO:
 3,312,993, INT. CL. 13.
- MCLAUGHLIN, APRIL AMBER, BRAINTREE, MA:
 2,094,781, REN. 9-13-07. INT. CL. 42.
- MCMILLAN HERBERT L., FAYETTEVILLE, NC:
 3,310,451, PUB. 7-31-2007. INT. CL. 35.
- MCS (U.S.A.) MARKETING, SERVICE & COMMERCE, INC., HIGHLAND PARK, IL:
 2,020,125, CANC. INT. CL. 18.
- MD DRINKS, INC., REDONDO BEACH, CA:
 3,310,909, PUB. 7-31-2007. MULTIPLE CLASS, INT. CLS. 5 AND 32.
- MDE MEDIZINTECHNIK GMBH, SCHAFFHAUSEN, SWITZERLAND:
 3,313,370, MULTIPLE CLASS, INT. CLS. 5 AND 10.
- MDR FITNESS CORP, SUNRISE, FL:
 3,314,999, INT. CL. 5.
- MEAD CORPORATION, THE, DAYTON, OH:
 2,410,823, CANC. INT. CL. 16.
 2,410,930, CANC. INT. CL. 16.
 2,411,463, CANC. INT. CL. 16.
- MEADWESTVACO CORPORATION, GLEN ALLEN, VA:
 3,314,211, INT. CL. 16.
- MEATHEAD MOVERS, INC., SAN LUIS OBISPO, CA:
 3,310,747, PUB. 7-31-2007. INT. CL. 39.
- MECA SOFTWARE, L.L.C., FAIRFIELD, CT TO CERTEGY E-BANKING SERVICES, INC., ALPHARETTA, GA:
 2,020,732, CANC. INT. CL. 9.
- MECA SOFTWARE, L.L.C., FAIRFIELD, CT TO YAHOO! INC., SUNNYVALE, CA:
 2,020,736, CANC. INT. CL. 9.
- MECALUX, S.A., 08902 BARCELONA, SPAIN:
 3,313,002, MULTIPLE CLASS, INT. CLS. 35 AND 38.
- MECHATRONICS, INC., PRESTON, WA, MECHATRONICS SAB, INC., MERCER ISLAND, WA:
 1,485,196, REN. 9-13-07. INT. CL. 11.
- MEDCO HEALTH SOLUTIONS, INC., FRANKLIN LAKES, NJ:
 3,314,698, INT. CL. 44.
- MEDCOST, LLC, WINSTON-SALEM, NC:
 3,310,885, PUB. 7-31-2007. INT. CL. 41.
- MEDEXPRESS URGENT CARE HOLDING CO., INC., MORGANTOWN, WV:
 3,311,726, PUB. 4-24-2007. INT. CL. 44.
- MEDI CONCEPT UNTERNEHMENSBERATUNGS AND BETEILIGUNGSGESELLSCHAFT MBH, 78462 KONSTANZ, FED REP GERMANY:
 2,409,938, CANC. INT. CL. 42.
- MEDI-SCREW, INC., KNXVILLE, TN:
 3,313,381, INT. CL. 10.
- MEDIA CART HOLDINGS, INC., PLANO, TX:
 3,311,984, PUB. 7-31-2007. MULTIPLE CLASS, INT. CLS. 9, 12 AND 35.
- MEDIA PUBLISHING HOUSE, LLC, HEBRON, IN:
 3,310,687, PUB. 7-31-2007. INT. CL. 16.
 3,310,689, PUB. 7-31-2007. INT. CL. 41.
- MEDIA STAGE, INC., SUNRISE, FL:
 3,310,246, PUB. 7-31-2007. INT. CL. 41.
- MEDIAPLANT LLC, SEATTLE, WA:
 2,410,656, CANC. MULTIPLE CLASS, INT. CLS. 41 AND

42.
MEDIATEC PUBLISHING, INC., CHICAGO, IL:
3,310,482, PUB. 7-31-2007. INT. CL. 16.
- MEDIAWORKS, L.L.C., FALLS CHURCH, VA:
2,410,148, CANC. MULTIPLE CLASS, INT. CLS. 35 AND 42.
- MEDICAL MANAGEMENT INTERNATIONAL, INC., PORTLAND, OR:
3,312,152, PUB. 7-31-2007. INT. CL. 16.
- MEDICAL SCIENTIFIC RESOURCES OF NEVADA, INC., LAS VEGAS, NV:
3,314,461, INT. CL. 44.
- MEDICIS PHARMACEUTICAL CORPORATION, SCOTTSDALE, AZ:
3,313,332, INT. CL. 5.
- MEDIFOR INC., NORDLAND, WA:
2,021,454, CANC. INT. CL. 9.
- MEDIMETRIX GROUP, INC., BOCA RATON, FL:
3,312,282, PUB. 7-31-2007. MULTIPLE CLASS, INT. CLS. 14 AND 44.
- MEDLINE INDUSTRIES, INC., MUNDELEIN, IL:
2,134,224. REN. 9-9-07. INT. CL. 10.
2,138,611. REN. 9-9-07. INT. CL. 10.
2,166,538. REN. 9-10-07. INT. CL. 5.
- MEDLINE INDUSTRIES, INC., CHICAGO, IL:
3,311,664, PUB. 7-31-2007. MULTIPLE CLASS, INT. CLS. 3, 5, 9, 10, 12, 16, 20, 21, 24, 25, 27 AND 35.
- MEDLINE INDUSTRIES, INC., MUNDELEIN, IL:
3,311,898, PUB. 7-31-2007. MULTIPLE CLASS, INT. CLS. 3, 9, 11, 12, 16, 20, 21, 22, 24, 25, 27 AND 35.
- MEDQUIST IP CORPORATION, MT. LAUREL, NJ:
3,312,026, PUB. 7-31-2007. INT. CL. 42.
- MEDSTAT GROUP, INC., THE, ANN ARBOR, MI:
2,410,763, CANC. INT. CL. 9.
- MEDTEXX MEDICAL CORPORATION, ORLANDO, FL:
3,311,101, PUB. 7-31-2007. INT. CL. 41.
3,311,103, PUB. 7-31-2007. INT. CL. 16.
- MEDTRONIC, INC., HENDERSON, NV:
1,419,076, CANC. INT. CL. 10.
- MEDTRONIC, INC., MINNEAPOLIS, MN:
3,310,724, PUB. 7-31-2007. INT. CL. 10.
3,314,317, INT. CL. 9.
- MEDUG UWE GÜNTHER E.K., FED REP GERMANY:
3,312,806, PUB. 7-31-2007. INT. CL. 9.
- MEETING PROFESSIONALS INTERNATIONAL, DALLAS, TX:
2,073,050. REN. 9-13-07. INT. CL. 41.
- MEGA INDUSTRIES CORP., PHOENIX, AZ:
3,310,502, PUB. 7-31-2007. INT. CL. 2.
- MEGA LIFE AND HEALTH INSURANCE COMPANY, THE, NORTH RICHLAND HILLS, TX:
3,313,100, INT. CL. 35.
- MEGA WAREHOUSE COMPANY LIMITED, KWAI CHUNG, NEW TERRITORIES, HONG KONG:
2,409,732, CANC. INT. CL. 28.
- MEHRABAN, STEVEN H., CHANTILLY, VA:
2,410,022, CANC. INT. CL. 42.
- MEIJER, INC., GRAND RAPIDS, MI:
2,328,006, CANC. MULTIPLE CLASS, INT. CLS. 1, 9 AND 25.
- MEINL BANK AKTIENGESELLSCHAFT, AUSTRIA:
3,312,937, PUB. 7-31-2007. MULTIPLE CLASS, INT. CLS. 35 AND 36.
- MELAMINE CHEMICALS, INC., DONALDSONVILLE, LA:
2,409,668, CANC. INT. CL. 42.
- MELLENDEZ, ROBERT F., RIO RANCHO, NM:
3,314,950, INT. CL. 9.
- MELET PLASTICS INC., WINNIPEG, MANITOBA, CANADA:
2,411,524, CANC. INT. CL. 10.
- MELI MELI, INC., PALO ALTO, CA:
3,311,925, PUB. 7-31-2007. INT. CL. 25.
- MELISSA JOY MANNING, INC., OAKLAND, CA:
3,311,420, PUB. 7-31-2007. INT. CL. 14.
3,311,470, PUB. 7-31-2007. INT. CL. 14.
- MELLICK, CARL, FOUNTAIN HILLS, AZ AND MELLICK, ELKE, FOUNTAIN HILLS, AZ:
3,312,494, PUB. 7-31-2007. INT. CL. 42.
- MENARD, INC., EAU CLAIRE, WI:
2,093,831. REN. 9-10-07. MULTIPLE CLASS, INT. CLS. 6, 40 AND 42.
2,119,014. REN. 9-10-07. MULTIPLE CLASS, INT. CLS. 6, 40 AND 42.
- MENDEZ, CHRISTOPHER, APOPKA, FL:
3,310,525, PUB. 7-31-2007. INT. CL. 37.
3,310,593, PUB. 7-31-2007. INT. CL. 37.
- MENTOR GRAPHICS CORPORATION, WILSONVILLE, OR:
3,311,654, PUB. 7-31-2007. INT. CL. 9.
- MENTORING MINDS, L.P., TYLER, TX:
3,310,980, PUB. 7-31-2007. INT. CL. 16.
- MERCANTIL DE COMERCIO, S.A., GUATEMALA CITY, GUATEMALA:
3,314,888, INT. CL. 3.
- MERCEDES BENZ CLUB OF AMERICA, INC., COLORADO SPRINGS, CO:
2,108,592. REN. 9-11-07. INT. CL. 41.
- MERCER HR SERVICES, LLC, NORWOOD, MA:
3,313,924, INT. CL. 35.
- MERCER HUMAN RESOURCE CONSULTING, INC., NEW YORK, NY:
3,311,540, PUB. 7-31-2007. MULTIPLE CLASS, INT. CLS. 36 AND 42.
- MERCER VALVE COMPANY, INC., OKLAHOMA CITY, OK:
3,312,371, PUB. 7-31-2007. INT. CL. 9.
3,312,372, PUB. 7-31-2007. INT. CL. 9.
- MERCY MINISTRIES OF AMERICA, INC., NASHVILLE, TN:
3,314,815, MULTIPLE CLASS, INT. CLS. 43, 44 AND 45.
- MEREDITH CORPORATION, DES MOINES, IA:
2,041,419. REN. 9-13-07. INT. CL. 16.
2,409,905, CANC. INT. CL. 35.
- MERIDIAN ENTERPRISES CORPORATION, HAZELWOOD, MO:
3,313,595, INT. CL. 39.
- MERIDIAN ENVIRONMENTAL TECHNOLOGY, INC., GRAND FORKS, ND:
2,410,111, CANC. INT. CL. 42.
- MERISANT COMPANY, CHICAGO, IL:
3,314,361, INT. CL. 30.
- MERIT INDUSTRIES, INC., BENSALEM, PA:
2,093,860. REN. 9-12-07. INT. CL. 28.
- MERIT MEDICAL SYSTEMS, INC., SOUTH JORDAN, UT:
3,314,740, INT. CL. 10.
- MERLIN TECHNOLOGIES, INC., GENEVA, IL:
2,178,562. REN. 9-13-07. INT. CL. 28.
- MERRILL LYNCH & CO., INC., NEW YORK, NY:
3,313,164, INT. CL. 36.
3,313,232, INT. CL. 36.
- MERRITT HOSPITALITY, LLC, NORWALK, CT:
3,310,778, PUB. 7-31-2007. INT. CL. 43.
- MERVYN'S BRANDS, LLC, HAYWARD, CA, MERVYN'S, HAYWARD, CA:
1,475,977. REN. 9-7-07. INT. CL. 25.
- MESSAGE LOGIX, INC., WHITE PLAINS, NY:
3,311,547, PUB. 7-31-2007. INT. CL. 38.
- MESSER CUTTING & WELDING GMBH, FED REP GERMANY:
3,312,846, PUB. 7-31-2007. INT. CL. 7.
- METCO TREATING AND DEVELOPMENT COMPANY, CHICAGO, IL:
1,074,745. REN. 9-13-07. INT. CL. 40.
- METER ENGINEERS, INC., MAIZE, KS:
3,311,821, PUB. 7-31-2007. MULTIPLE CLASS, INT. CLS. 9, 37, 40 AND 42.
- METROKANE, INC., NEW YORK, NY:
3,314,605, INT. CL. 18.
- METROLOGIC INSTRUMENTS, INC., BLACKWOOD, NJ:
2,410,847, CANC. INT. CL. 9.
- METROMEDIA TECHNOLOGIES, INC., NEW YORK, NY:
3,314,447, INT. CL. 41.
- METTLER, MICHAEL, 54497 MORBACH, FED REP GERMANY, DBA PAPIER-METTLER INHABER:
3,312,274, PUB. 7-31-2007. INT. CL. 16.

- MI WINDOWS AND DOORS, INC., GRATZ, PA:
2,411,200, CANC. INT. CL. 19.
2,411,201, CANC. INT. CL. 19.
- MICHAEL DAVID WARD PRODUCTIONS, INC., SANTA ROSA, CA:
3,313,581, MULTIPLE CLASS, INT. CLS. 16 AND 25.
- MICHAEL J. FOX FOUNDATION FOR PARKINSON'S RESEARCH, NEW YORK, NY:
3,312,506, PUB. 7-31-2007. MULTIPLE CLASS, INT. CLS. 16, 35, 36 AND 41.
- MICHAEL JOHN CHAVES, BOISE, ID AND JOHN ELMIRO DA ROCHA CHAVES, BOISE, ID:
3,311,392, PUB. 7-31-2007. INT. CL. 41.
- MICHAEL KICKARO'S MARTIAL ARTS AND FITNESS, LLC, BROOKFIELD, CT:
3,314,514, INT. CL. 41.
- MICHAEL L LAMBERT, ATLANTA, GA:
3,315,002, INT. CL. 26.
- MICHAEL NESTOR, AVALON, NJ AND SEAN FORD, AVALON, NJ:
3,311,688, PUB. 7-31-2007. MULTIPLE CLASS, INT. CLS. 30 AND 43.
- MICHAELS OF OREGON CO., OVERLAND PARK, KS:
2,168,875, REN. 9-9-07. INT. CL. 13.
- MICHAELSTEVEN SHERMAN, P.C., WEXFORD, PA:
3,314,834, INT. CL. 42.
- MICHEL LAROCHE & JORGE CODERCH S.A., TALCA, CHILE:
3,311,642, PUB. 7-31-2007. INT. CL. 33.
- MICHELIN NORTH AMERICA, INC., GREENVILLE, SC:
3,313,055, INT. CL. 9.
- MICHELIN STAR, INC., NEW YORK, NY:
3,311,598, PUB. 7-31-2007. INT. CL. 25.
- MICHELLE BELAU S.A.C., LIMA, PERU:
3,312,463, PUB. 4-10-2007. INT. CL. 25.
- MICHIGAN CONSTRUCTION INDUSTRY MUTUAL INSURANCE COMPANY, LANSING, MI:
3,311,728, PUB. 7-31-2007. INT. CL. 36.
- MICRO AUDIOMETRICS CORP., MURPHY, NC:
3,311,607, PUB. 7-31-2007. INT. CL. 10.
3,311,608, PUB. 7-31-2007. INT. CL. 10.
- MICRO CLAIR INTERNATIONAL, INC., QUEBEC, CANADA, C. ITOH & COMPANY (CANADA) LTD., MONTREAL, QUEBEC, CANADA:
1,456,560, REN. 9-10-07. INT. CL. 21.
- MICRO POWER SYSTEMS, INCORPORATED, SANTA CLARA, CA:
1,419,575, CANC. INT. CL. 9.
- MICRO TECH MFG. INC., WORCESTER, MA:
1,453,006, REN. 9-9-07. INT. CL. 9.
- MICRON INDUSTRIES CORPORATION, ELMHURST, IL:
2,085,861, REN. 9-7-07. INT. CL. 9.
- MICROSOLVED, INC., COLUMBUS, OH:
3,314,637, INT. CL. 9.
- MICRO SOUND A/S, DENMARK:
3,312,842, PUB. 7-31-2007. MULTIPLE CLASS, INT. CLS. 9 AND 10.
- MICROTHIN.COM, INC., ADDISON, IL:
3,311,422, PUB. 7-31-2007. INT. CL. 21.
3,311,423, PUB. 7-31-2007. INT. CL. 21.
- MID SOUTH INDUSTRIES, INC., LAUREL, MS:
1,075,438, REN. 9-13-07. INT. CL. 11.
- MID-SOUTH REGIONAL BLOOD CENTER, MEMPHIS, TN:
3,310,919, PUB. 7-31-2007. MULTIPLE CLASS, INT. CLS. 1, 42 AND 44.
3,310,921, PUB. 7-31-2007. MULTIPLE CLASS, INT. CLS. 1, 42 AND 44.
- MID-STATES DISTRIBUTING COMPANY, INC., ST. PAUL, MN:
2,480,706, CANC. MULTIPLE CLASS, INT. CLS. 6, 9, 18 AND 22.
- MIDDLEBURG BANK, MIDDLEBURG, VA:
2,410,003, CANC. INT. CL. 36.
- MIDFIRST BANK, OKLAHOMA CITY, OK:
3,312,335, PUB. 7-31-2007. INT. CL. 35.
- MIDLAND NATIONAL LIFE INSURANCE COMPANY, SIOUX FALLS, SD:
2,129,763, REN. 9-7-07. INT. CL. 36.
- MIDLAND STATES BANCORP, INC., EFFINGHAM, IL:
3,313,048, INT. CL. 36.
- MIDWEST FASTENER CORPORATION, KALAMAZOO, MI:
3,310,845, PUB. 7-31-2007. INT. CL. 6.
- MIDWEST INDUSTRIAL SUPPLY, INC., CANTON, OH:
3,313,902, INT. CL. 1.
- MIDWEST OIL SUPPLY INC., DEARBORN, MI:
3,311,862, PUB. 2-13-2007. MULTIPLE CLASS, INT. CLS. 4 AND 35.
- MIGHTY FINE, LOS ANGELES, CA:
2,410,621, CANC. INT. CL. 25.
- MIKASA LICENSING, INC., SECAUCUS, NJ:
2,072,941, REN. 9-10-07. INT. CL. 21.
- MIKI CORPORATION, TOKYO, JAPAN:
3,310,279, PUB. 7-31-2007. INT. CL. 3.
- MIKOLAJCZYK, WILLIAM C., ANTHEM, AZ:
3,313,264, INT. CL. 35.
- MILAZZO INDUSTRIES, PITTSTON, PA:
2,409,848, CANC. INT. CL. 19.
- MILES PER HOUR, INC., CARLSBAD, CA:
2,409,975, CANC. INT. CL. 25.
- MILITARY BENEFIT ASSOCIATION, INC., CHANTILLY, VA:
3,313,249, INT. CL. 36.
- MILK STUDIOS, NEW YORK, NY:
3,312,318, PUB. 7-31-2007. MULTIPLE CLASS, INT. CLS. 35 AND 41.
- MILLAR, JOHN JR., ASPERS, PA:
1,419,105, CANC. INT. CL. 12.
- MILLER ENGINEERING GROUP, INC., DAYTON, OH:
2,411,550, CANC. INT. CL. 42.
- MILLER FREEMAN, INC., SAN FRANCISCO, CA:
2,411,521, CANC. INT. CL. 35.
- MILLER STUDIOS, INC., NEW PHILADELPHIA, OH:
2,411,148, CANC. MULTIPLE CLASS, INT. CLS. 20 AND 27.
- MILLER WELDMASTER CORPORATION, NAVARRE, OH:
3,311,247, PUB. 7-31-2007. MULTIPLE CLASS, INT. CLS. 9 AND 37.
3,311,257, PUB. 7-31-2007. MULTIPLE CLASS, INT. CLS. 9 AND 37.
- 3,311,308, PUB. 7-31-2007. MULTIPLE CLASS, INT. CLS. 37 AND 41.
- MILLERSPORT INC., COMMACK, NY:
3,313,104, INT. CL. 28.
- MILWAUKEE BUCKS, INC., MILWAUKEE, WI:
2,095,423, REN. 9-10-07. INT. CL. 25.
- MIMVISTA CORP., CLEVELAND, OH:
3,312,564, PUB. 7-31-2007. INT. CL. 9.
- MINDLIN COMPANIES, LOS ANGELES, CA:
2,822,384, AM. MULTIPLE CLASS, INT. CLS. 35, 36 AND 37.
- MINDLIN COMPANIES, LLC, LOS ANGELES, CA:
2,850,230, AM. INT. CL. 36.
- MINDMATTERS, INC., FAIRBURN, GA:
1,962,480, CANC. INT. CL. 16.
- MINDO AB, SWEDEN:
3,312,713, PUB. 7-31-2007. MULTIPLE CLASS, INT. CLS. 16, 35 AND 41.
- MINGOY, STEVEN D., SIDNEY, NE:
2,411,333, CANC. INT. CL. 25.
- MINKA LIGHTING, INC., CORONA, CA:
3,313,777, INT. CL. 9.
- MINNESOTA MINING AND MANUFACTURING COMPANY, SAINT PAUL, MN, AKA 3M:
1,419,083, CANC. INT. CL. 10.
- MINNESOTA PUBLIC RADIO, ST. PAUL, MN:
3,312,531, PUB. 4-17-2007. INT. CL. 41.
- MINNESOTA SCIENTIFIC, INC., ST. PAUL, MN:
3,313,146, INT. CL. 10.
- MINOLTA KABUSHIKI KAISHA (MINOLTA CO., LTD.), CHUO-KU, OSAKA-SHI, OSAKA, 541-8556, JAPAN:
2,020,368, CANC. INT. CL. 9.
- MINTO HOLDINGS INC., OTTAWA, ONTARIO, CANADA:
3,312,027, PUB. 7-31-2007. INT. CL. 36.
- MIRACLE RECREATION EQUIPMENT COMPANY, MONETT, MO:
3,311,947, PUB. 7-31-2007. INT. CL. 28.

MIRIKI, TITOE ETIENMUDOH, MIAMI, FL:
2,411,290, CANC. INT. CL. 3.

MIRO COMPUTER PRODUCTS AG, 38112 BRAUNSCHWEIG, FED REP GERMANY TO PINNACLE SYSTEMS, INC., MOUNTAIN VIEW, CA:
2,020,296, CANC. INT. CL. 9.

MIROMAR DEVELOPMENT CORPORATION, ESTERO, FL:
3,313,366, INT. CL. 36.

MIROTZNIK, CHARLES M., NEW YORK, NY:
3,314,900, INT. CL. 41.

MISS EILEEN IV, INC., BOROUGH OF MANHATTAN, NY:
1,419,266, CANC. INT. CL. 25.

MISS KIMBERLY'S DAY CARE CENTER INC., MENTOR, OH:
3,311,283, PUB. 7-31-2007. INT. CL. 43.

MISS PROFESSIONAL NAIL PRODUCTS, INC., GARDENA, CA:
1,445,871, REN. 9-11-07. INT. CL. 3.

MISSISSIPPI BOTTLED WATER COMPANY, INC., JACKSON, MS:
3,311,019, PUB. 7-31-2007. INT. CL. 32.
3,311,020, PUB. 7-31-2007. INT. CL. 32.

MISSISSIPPI LIME COMPANY, ST. LOUIS, MO:
3,313,614, INT. CL. 1.
3,314,800, INT. CL. 1.

MISSOURI VALLEY COMMUNICATIONS PUBLISHING INCORPORATED LLC, LAWRENCE, KS:
2,411,555, CANC. INT. CL. 16.

MITRA, SANTANU, HUNTSVILLE, AL:
3,310,653, PUB. 7-31-2007. INT. CL. 41.

MITSUBISHI ELECTRIC CORPORATION, CHIYODA-KU, TOKYO, JAPAN:
3,313,623, INT. CL. 7.

MITSUBISHI GAS CHEMICAL COMPANY, INC., CHIYODA-KU, TOKYO, JAPAN:
3,313,131, INT. CL. 3.

MITSUBISHI SHOJI KAISHA, LTD., CHIYODA-KU, TOKYO, JAPAN:
2,410,123, CANC. MULTIPLE CLASS, INT. CLS. 1 AND 4.

MITSUBOSHI DIAMOND INDUSTRIAL CO., LTD., OSAKA 566, JAPAN:
2,094,175, REN. 9-13-07. INT. CL. 8.

MITSUI MINING & SMELTING CO., LTD., TOKYO, JAPAN:
3,312,605, PUB. 7-31-2007. INT. CL. 6.

MIXED NUTS, INC., OLD HICKORY, TN:
2,410,920, CANC. INT. CL. 16.

MIZUNO USA, INC., NORCROSS, GA:
3,311,545, PUB. 7-31-2007. INT. CL. 28.

MJB PIZZA INC, CAREFREE, AZ AND A&D PIZZA INC, GILBERT, AZ:
3,312,621, PUB. 7-31-2007. MULTIPLE CLASS, INT. CLS. 30 AND 43.

MJW CORPORATION, INC., AMHERST, NY:
3,313,000, MULTIPLE CLASS, INT. CLS. 9, 37, 39 AND 42.

MLSTODAY.COM, LLC, PASO ROBLES, CA:
2,410,588, CANC. INT. CL. 9.

MM SYSTEMS CORPORATION, TUCKER, GA:
1,419,197, CANC. INT. CL. 19.

MMA/CARAT, INC., WILTON, CT:
3,313,520, INT. CL. 9.

MMC 20/20, INC., BASKING RIDGE, NJ:
2,410,619, CANC. INT. CL. 42.

MMG HOLDINGS, INC., SOUTH WEYMOUTH, MA:
3,310,891, PUB. 7-31-2007. INT. CL. 38.

MMI, S.A. DE C.V., MEXICO CITY, MEXICO:
3,311,639, PUB. 7-31-2007. INT. CL. 18.

MOBILE HQ, INC., MESA, AZ:
3,313,970, INT. CL. 35.

MOBILE ON SITE THERAPY, INC., YORK, PA:
3,311,537, PUB. 7-31-2007. MULTIPLE CLASS, INT. CLS. 41 AND 44.

MOBILITY ELECTRONIC, INC., SCOTTSDALE, AZ:
2,410,269, CANC. INT. CL. 42.

MOBILITY ELECTRONICS, INC., SCOTTSDALE, AZ:
2,410,267, CANC. INT. CL. 9.
2,410,268, CANC. INT. CL. 42.

MOBO SYSTEMS, INC., NEW YORK, NY:
3,312,288, PUB. 7-31-2007. INT. CL. 9.

MOBOOGIE.NET, LLC, DENVER, CO:
3,311,357, PUB. 7-31-2007. INT. CL. 41.

MODEL HOME ACCENTS, LLC, DBA MODEL HOME ACCENTS, ZEPHYR COVE, NV:
3,314,955, INT. CL. 35.

MODERN LUXURY MEDIA, LLC, CHICAGO, IL:
3,312,465, PUB. 7-31-2007. MULTIPLE CLASS, INT. CLS. 9 AND 16.

MODERNICA INC., LOS ANGELES, CA:
2,095,029, REN. 9-7-07. INT. CL. 20.

MODESITT, BRUCE D., SAN CARLOS, CA:
3,313,447, INT. CL. 10.

MOELLERS, LUCAS, HUTCHINSON, MN, DBA MO MOD COMPANY AND MOELLERS, SARANYA, HUTCHINSON, MN, DBA MO MOD COMPANY:
3,314,185, INT. CL. 9.

MOGUL MORTGAGE, LLC, BOULDER, CO:
3,310,682, PUB. 7-31-2007. INT. CL. 36.

MOHAWK BRANDS, INC., WILMINGTON, DE, GALAXY CARPET MILLS, INC., ELK GROVE VILLAGE, IL:
1,073,683, REN. 9-13-07. INT. CL. 27.

MOIXA ENERGY HOLDINGS LTD., LONDON, UNITED KINGDOM:
3,315,004, INT. CL. 9.

MOLECULAR BIO-PRODUCTS, INC., SAN DIEGO, CA:
2,091,514, REN. 9-12-07. INT. CL. 1.

MOLL, CHRISTOPHER THOMAS, CLEARWATER, FL AND RIZZO, SALVATORE N., III, CLEARWATER, FL:
3,313,266, INT. CL. 9.

MOLLENKAMP, LOUIS B., TOLEDO, OH, DBA L. MOLLENKAMP & ASSOCIATES:
2,410,922, CANC. INT. CL. 17.

MOLLYGUARD CORPORATION, SAN FRANCISCO, CA:
3,311,863, PUB. 7-31-2007. INT. CL. 35.

MOLTAN COMPANY, MEMPHIS, TN:
2,409,757, CANC. MULTIPLE CLASS, INT. CLS. 1 AND 31.

MOMENTUM INTERACTIVE, EL PASO, TX:
3,310,642, PUB. 7-31-2007. INT. CL. 11.

MOMS-FOR-PROFIT, LLC, ST. JAMES, NY:
3,310,484, PUB. 7-31-2007. INT. CL. 36.

MONACO COACH CORPORATION, COBURG, OR:
1,463,410, REN. 9-12-07. INT. CL. 12.

MONARCH MARKING SYSTEMS, INC., MIAMISBURG, OH:
1,418,937, CANC. INT. CL. 7.

MONDRAGON TELECOMMUNICATIONS, S.L., 46550 ALBUIXECH, VALENCIA, SPAIN:
2,409,855, CANC. INT. CL. 9.

MONEY GAMING CORPORATION LTD., THE, LONDON, UNITED KINGDOM:
3,314,013, INT. CL. 41.

MONITOR AUDIO LIMITED, ESSEX, UNITED KINGDOM:
3,313,592, INT. CL. 9.

MONITOR CLOSELY.COM, LLC, CINCINNATI, OH:
3,314,901, INT. CL. 45.

MONITOR COMPANY GROUP LIMITED PARTNERSHIP, CAMBRIDGE, MA:
3,310,959, PUB. 7-31-2007. MULTIPLE CLASS, INT. CLS. 35 AND 41.

MONITOR TECHNOLOGIES LLC, ELBURN, IL:
3,314,229, INT. CL. 9.

MONOTYPE CORPORATION, THE, REDMOND, WA:
2,066,196, REN. 9-11-07. INT. CL. 9.

MONSANTO COMPANY, ST. LOUIS, MO:
2,095,766, REN. 9-10-07. INT. CL. 31.

MONSANTO TECHNOLOGY LLC, ST. LOUIS, MO, MONSANTO COMPANY, ST. LOUIS, MO:
2,101,872, REN. 9-10-07. INT. CL. 31.

MONTAGE HOTELS & RESORTS, LLC, HENDERSON, NV:
3,313,373, MULTIPLE CLASS, INT. CLS. 41 AND 44.

MONTGOMERY ASSET MANAGEMENT, LLC, SAN FRANCISCO, CA:
2,411,172, CANC. INT. CL. 42.

MOONWALK UNIVERSAL PTY LTD, AUSTRALIA:
3,312,904, PUB. 7-31-2007. MULTIPLE CLASS, INT. CLS. 9 AND 42.

- MOORE INDUSTRIES-INTERNATIONAL, INC., SEPULVEDA, CA:
2,131,919. REN. 9-12-07. INT. CL. 9.
- MOORE, DANIAL, COVINGTON, GA AND MOORE, NAIMA, COVINGTON, GA:
3,314,523, INT. CL. 35.
- MORE PREPARED LLC, MANHATTAN BEACH, CA:
3,311,311, PUB. 7-31-2007. INT. CL. 35.
- MORETTI, PATRICIA B., PROVIDENCE, RI:
3,312,516, PUB. 7-31-2007. INT. CL. 43.
- MORIARTY, PAUL, ROCHESTER, NY:
3,310,365, PUB. 7-31-2007. INT. CL. 9.
- MORNING FOODS LTD., CREWE, ENGLAND:
1,449,938. REN. 9-12-07. INT. CL. 30.
- MORPHOSYS UK LIMITED, OXFORD, UNITED KINGDOM:
2,091,282. REN. 9-10-07. INT. CL. 1.
- MORRELL, MARCUS, LONDON SW3 4TQ, UNITED KINGDOM:
3,310,628, PUB. 7-31-2007. INT. CL. 41.
- MORRIS PRODUCTS, INC., QUEENSBURY, NY:
3,310,584, PUB. 7-31-2007. INT. CL. 6.
- MORRISON, CYNTHIA L., OCOEE, FL:
3,313,399, INT. CL. 16.
- MORRISON, GEORGE IVAN, LONDON W1U 2JW, ENGLAND, DBA VAN MORRISON:
3,311,731, PUB. 7-31-2007. MULTIPLE CLASS, INT. CLS. 9, 39 AND 41.
- MORSE, JAMES D., WEYBRIDGE, VT:
2,178,124. REN. 9-13-07. INT. CL. 9.
- MORTON, JUSTIN W., TECUMSEH, MI:
3,311,049, PUB. 7-31-2007. INT. CL. 41.
- MOSS, KATE, LONDON SW3 3TD, ENGLAND:
3,313,239, INT. CL. 25.
- MOSSY ENTERPRISES PTY LTD (ACN: 084441109), AUSTRALIA:
3,312,929, PUB. 7-31-2007. MULTIPLE CLASS, INT. CLS. 35 AND 44.
- MOTEK, INC., SEATTLE, WA:
1,453,087. REN. 9-11-07. INT. CL. 9.
- MOTHERCARE UK LIMITED, WATFORD WD246SH, UNITED KINGDOM, MOTHERCARE LIMITED, LONDON, ENGLAND:
826,906. REN. 9-13-07. U.S. CL. 39 (INT. CLS. 10, 25 AND 26).
- MOTION PICTURE AND EVENT PRODUCTION SERVICES, INC., WILMINGTON, NC:
2,409,911, CANC. INT. CL. 40.
- MOTION WATER SPORTS, INC., REDMOND, WA, DOUBLEUP WAKEBOARDS, LLC, TRUCKEE, CA:
2,117,564. REN. 9-13-07. INT. CL. 28.
- MOTOVAN CORPORATION, BOUCHERVILLE, QUEBEC, CANADA:
3,312,478, PUB. 7-31-2007. MULTIPLE CLASS, INT. CLS. 6, 7, 12 AND 22.
- MOTT'S INC., STAMFORD, CT:
2,077,128. REN. 9-10-07. INT. CL. 32.
- MOUNT ZION BAPTIST CHURCH, NASHVILLE, TN:
3,311,943, PUB. 7-31-2007. MULTIPLE CLASS, INT. CLS. 25 AND 41.
- MOUNTAIRE CORPORATION, NORTH LITTLE ROCK, AR:
3,311,272, PUB. 7-31-2007. INT. CL. 29.
- MOUZZON, DEMARCUS, RALEIGH, NC:
3,312,547, PUB. 7-31-2007. INT. CL. 41.
- MOVE OVER, INC, CLERMONT, FL:
2,411,476, CANC. INT. CL. 16.
- MOVEABLE CUBICLE, INC., SAN CLEMENTE, AZ:
3,314,932, INT. CL. 35.
- MOVIEFONE, INC., NEW YORK, NY TO AOL LLC, DULLES, VA:
2,020,164, CANC. INT. CL. 41.
- MOVIES UNLIMITED, INC., PHILADELPHIA, PA:
2,411,584, CANC. INT. CL. 35.
- MOVO MEDIA, INC., LOS ANGELES, CA:
2,409,728, CANC. INT. CL. 42.
- MPACS LLC, MADISON, WI:
2,409,756, CANC. INT. CL. 9.
- MPHASIS LIMITED, BANGALORE, INDIA:
3,310,308, PUB. 7-31-2007. INT. CL. 35.
3,310,309, PUB. 7-31-2007. INT. CL. 35.
- MR. GOODNUTTS, INC., LAS VEGAS, NV:
3,314,285, INT. CL. 30.
- MR. IDEA, INC., ATTLEBORO, MA:
3,314,991, INT. CL. 24.
- MRB COMMUNICATIONS, INC., PHILADELPHIA, PA:
3,310,501, PUB. 7-31-2007. INT. CL. 42.
- MS BRANDS, LLC, MEMPHIS, TN:
1,419,358, CANC. INT. CL. 29.
- MS. O'S EXCLUSIVE CATERING, INC., DETROIT, MI:
3,313,584, INT. CL. 30.
- MSTAR SEMICONDUCTOR, INC., HSINCHU HSIEN 302, TAIWAN:
3,312,568, PUB. 7-31-2007. INT. CL. 9.
- MTI CORPORATION, IVYLAND, PA:
1,418,946, CANC. INT. CL. 7.
- MTM TRADING (PROPRIETARY) LIMITED, ROODEPOORT 1724, GAUTENG PROVINCE, SOUTH AFRICA:
2,410,074, CANC. INT. CL. 11.
- MTOCLEAN, INC., INDEPENDENCE, OH:
3,314,429, MULTIPLE CLASS, INT. CLS. 35 AND 37.
- MTS EUROPE GMBH, KONSTANZ, FED REP GERMANY:
3,311,768, PUB. 7-31-2007. MULTIPLE CLASS, INT. CLS. 10 AND 42.
- MU SECURITY, SUNNYVALE, CA:
3,314,472, INT. CL. 9.
- MUDLARK PAPERS, INC., BOLINGBROOK, IL:
3,313,216, INT. CL. 4.
- MULBERRY GREEN TEA LTD., PART., HUAYKWANG, BANGKOK 10310, THAILAND:
3,313,170, INT. CL. 30.
- MULHOLLAND HEADWEAR, LTD., FORT WORTH, TX:
3,312,669, PUB. 7-31-2007. INT. CL. 25.
- MULLENGER, SUSIE K, CANYON COUNTRY, CA:
3,311,734, PUB. 7-31-2007. INT. CL. 24.
- MULTI-COMMUNICATION,; NAAMLOZE VENNOOTSCHAP, BELGIUM:
3,312,941, PUB. 7-31-2007. MULTIPLE CLASS, INT. CLS. 2, 11 AND 24.
- MULTIBAND SUBSCRIBER SERVICES, INC., NEW HOPE, MN:
3,311,797, PUB. 7-31-2007. MULTIPLE CLASS, INT. CLS. 37 AND 38.
- MULTIMEDIA GAMES, INC., AUSTIN, TX:
3,313,675, INT. CL. 9.
3,313,925, INT. CL. 9.
- MULTIPLAN, INC., NEW YORK, NY:
3,310,907, PUB. 7-31-2007. INT. CL. 9.
- MULTIVAC SEPP HAGGENMÜLLER GMBH & CO. KG, WOLFERTSCHWENDEN, FED REP GERMANY:
3,311,881, PUB. 7-31-2007. MULTIPLE CLASS, INT. CLS. 9 AND 42.
- MULTIZEN HOLDINGS LIMITED, TST, HONG KONG:
3,310,487, PUB. 7-31-2007. INT. CL. 30.
- MUMM'S THE WORD, INC., SPOKANE, WA:
2,411,192, CANC. INT. CL. 24.
- MUNRO & COMPANY, INC., HOT SPRINGS, AR:
3,314,123, INT. CL. 25.
- MUPPETS STUDIO, LLC, THE, BURBANK, CA:
3,314,910, INT. CL. 28.
- MURANO DUE S.R.L., SALZANO (VENEZIA), ITALY:
2,410,192, CANC. INT. CL. 11.
- MURPHY, VALARIE, BOULDER, CO:
3,311,843, PUB. 7-31-2007. INT. CL. 9.
- MUSEUM OF SCIENCE INC., MIAMI, FL:
3,310,422, PUB. 7-31-2007. MULTIPLE CLASS, INT. CLS. 16 AND 41.
- MUSIC LESSONS ON WHEELS, LLC, SEATTLE, WA:
3,310,733, PUB. 7-31-2007. INT. CL. 41.
- MUSSER, MICHAEL W., SAN RAFAEL, CA:
3,313,853, INT. CL. 25.
- MUSTANG FASTENERS, INC., WESLEY CHAPEL, FL:
3,314,129, INT. CL. 35.
- MUSZYNSKI, GARY, OAKLAND, CA:
2,120,910. REN. 9-10-07. INT. CL. 41.
2,124,863. REN. 9-10-07. INT. CL. 41.

- MUTTLUKS INC, TORONTO ONTARIO, CANADA:
2,089,420, REN. 9-9-07. INT. CL. 18.
- MWM AND ASSOCIATES INCORPORATED, FORT WAYNE, IN:
3,313,864, INT. CL. 41.
- MXGA INC., IRVING, TX:
3,312,012, PUB. 7-31-2007. INT. CL. 36.
- MY FAVORITE JERKY, L.L.C., BOULDER, CO:
2,411,336, CANC. INT. CL. 29.
- MY OWN GARDEN, 75001 PARIS, FRANCE:
2,409,971, CANC. INT. CL. 3.
2,409,972, CANC. INT. CL. 3.
- MYERS INDUSTRIES, INC., AKRON, OH:
1,444,044, REN. 9-8-07. INT. CL. 12.
- MYSTIC TAN, INC., FARMERS BRANCH, TX:
3,313,669, INT. CL. 3.
- MYSTICAL TREASURES, INC., TARZANA, CA:
2,410,727, CANC. INT. CL. 14.
- M2 DESIGN BY MARY MARGRILL, INC. D/B/A KEATING & ROARK BY MARY MARGRILL, NEW YORK, NY:
3,311,897, PUB. 7-31-2007. INT. CL. 14.
- N.V. BEKAERT S.A., ZWEVEGEM, BELGIUM:
1,483,045, REN. 9-7-07. INT. CL. 6.
- N.V. SPAAS KAARSEN NAAMLOZE VENNOTSCHAP, B-3930 HAMONT-ACHEL, BELGIUM:
2,410,932, CANC. INT. CL. 4.
- N&W GLOBAL VENDING S.P.A., ITALY:
3,312,965, PUB. 7-31-2007. INT. CL. 9.
3,312,966, PUB. 7-31-2007. INT. CL. 9.
- N-LINE TRAFFIC MAINTENANCE, BRYAN, TX:
3,310,742, PUB. 7-31-2007. INT. CL. 37.
- NADICENT TECHNOLOGIES LLC, GLASTONBURY, CT:
3,313,455, MULTIPLE CLASS, INT. CLS. 35, 37 AND 42.
- NADINE CARIDI, INC., GARDENA, CA:
3,311,324, PUB. 7-31-2007. INT. CL. 25.
3,311,478, PUB. 7-31-2007. INT. CL. 25.
3,311,479, PUB. 7-31-2007. INT. CL. 25.
- NAILBOMB, PHOENIX, AZ:
2,020,708, CANC. INT. CL. 9.
- NAKED JUICE CO. OF GLENDORA, INC., AZUSA, CA:
3,311,144, PUB. 7-31-2007. INT. CL. 32.
- NAKED MODERN, LLC, MILWAUKEE, WI:
3,313,833, INT. CL. 35.
- NAM WAH DEVELOPMENT LIMITED, TUEN MUN, N.T., HONG KONG:
3,311,977, PUB. 7-17-2007. MULTIPLE CLASS, INT. CLS. 9 AND 12.
- NAMBITION GMBH, FED REP GERMANY:
3,312,738, PUB. 7-31-2007. INT. CL. 9.
- NAMENDORF, ARTHUR R., PHOENIXVILLE, PA:
3,311,292, PUB. 7-31-2007. INT. CL. 43.
- NANOSHINE, INC., EVERETT, WA:
3,313,945, INT. CL. 2.
- NANTUCKET HARVEST CO., INC., FALL RIVER, MA:
3,312,637, PUB. 7-31-2007. INT. CL. 30.
- NAPA VALLEY VINTNERS ASSOCIATION, ST. HELENA, CA:
3,311,274, PUB. 7-31-2007. INT. CL. 35.
- NARYRATHA HENG SCHLUESSEL, TIBURON, CA AND ROLAND SCHLUESSEL, TIBURON, CA:
3,310,486, PUB. 6-26-2007. INT. CL. 14.
- NASTROFLEX S.P.A., ITALY:
3,312,907, PUB. 7-31-2007. INT. CL. 3.
- NATIONAIR INSURANCE AGENCIES, INC., CHESTERFIELD, MO:
3,310,608, PUB. 7-31-2007. INT. CL. 36.
- NATIONAL ACADEMY OF RECORDING ARTS & SCIENCES, INC., SANTA MONICA, CA:
3,311,841, PUB. 7-31-2007. INT. CL. 41.
- NATIONAL AIRLINES, INC., LAS VEGAS, NV:
2,410,872, CANC. INT. CL. 39.
- NATIONAL APARTMENT EXCHANGE, LLC, AUSTIN, TX:
3,314,266, MULTIPLE CLASS, INT. CLS. 35, 36 AND 42.
- NATIONAL ARTICULATION AND TRANSFER NETWORK, SAN FRANCISCO, CA:
3,314,990, INT. CL. 41.
- NATIONAL ASSOCIATION OF PROFESSIONAL BASEBALL LEAGUES, INC., ST. PETERSBURG, FL:
3,311,212, PUB. 7-31-2007. INT. CL. 41.
- NATIONAL AUDUBON SOCIETY, INC., NEW YORK, NY:
2,091,017, REN. 9-11-07. INT. CL. 9.
- NATIONAL AUTOMOTIVE PARTS ASSOCIATION, ATLANTA, GA:
3,311,793, PUB. 7-31-2007. INT. CL. 41.
- NATIONAL BOARD OF BOILER AND PRESSURE VESSEL INSPECTORS, THE, COLUMBUS, OH:
2,409,854, CANC. U.S. CL. B.
- NATIONAL BUSINESS AVIATION ASSOCIATION, INC., WASHINGTON, DC, NATIONAL BUSINESS AVIATION ASSOCIATION, INC., WASHINGTON, DC:
2,177,242, REN. 9-8-07. INT. CL. 9.
- NATIONAL BUSINESS SERVICES, INC., LANGHORNE, PA:
2,411,316, CANC. INT. CL. 35.
- NATIONAL CANCER INSTITUTE, BETHESDA, MD:
2,411,492, CANC. INT. CL. 42.
- NATIONAL CARE NETWORK, LP, IRVING, TX:
3,310,937, PUB. 7-31-2007. INT. CL. 35.
3,310,938, PUB. 7-31-2007. INT. CL. 35.
- NATIONAL CITY CORPORATION, CLEVELAND, OH:
2,411,428, CANC. INT. CL. 36.
- NATIONAL CONFERENCE OF STANDARDS LABORATORIES, BOULDER, CO:
3,313,769, INT. CL. 16.
- NATIONAL DIRECTORY COMPANY, INC., TUSTIN, CA:
2,411,406, CANC. INT. CL. 16.
- NATIONAL INSTITUTE ON MEDIA AND THE FAMILY, MINNEAPOLIS, MN, NATIONAL INSTITUTE ON MEDIA AND THE FAMILY, MINNEAPOLIS, MN:
2,124,171, REN. 9-12-07. INT. CL. 16.
- NATIONAL LEAGUE OF JUNIOR COTILLIONS, CHARLOTTE, NC:
2,084,078, REN. 9-10-07. INT. CL. 41.
- NATIONAL LIBRARY OF MEDICINE, THE, BETHESDA, MD:
1,419,532, CANC. INT. CL. 42.
- NATIONAL MARINE MANUFACTURERS ASSOCIATION, INC., CHICAGO, IL:
3,311,530, PUB. 7-31-2007. INT. CL. 35.
- NATIONAL PROGRAMMING SERVICE, LLC, INDIANAPOLIS, IN:
3,311,326, PUB. 7-31-2007. INT. CL. 35.
- NATIONAL READY MIXED CONCRETE ASSOCIATION, SILVER SPRING, MD:
3,311,209, PUB. 7-31-2007. INT. CL. 41.
- NATIONAL RESEARCH CORPORATION, LINCOLN, NE:
3,312,055, PUB. 7-31-2007. INT. CL. 35.
- NATIONAL SOCIETY OF HISPANIC MBAS, IRVING, TX:
3,312,001, PUB. 7-31-2007. MULTIPLE CLASS, INT. CLS. 16, 35, 36 AND 41.
- NATIONAL SPECIALITY ALLOYS, INC., HOUSTON, TX:
3,311,704, PUB. 4-17-2007. MULTIPLE CLASS, INT. CLS. 6, 7 AND 14.
3,311,705, PUB. 4-17-2007. MULTIPLE CLASS, INT. CLS. 6, 7 AND 14.
3,311,706, PUB. 4-17-2007. MULTIPLE CLASS, INT. CLS. 6, 7 AND 14.
- NATIONAL TAXPAYERS ALLIANCE, INC., SACRAMENTO, CA:
2,411,538, CANC. INT. CL. 42.
- NATIONAL TELECOM ASSOCIATES, INC., ORLANDO, FL, DBA VOOICER, INC.:
3,310,981, PUB. 7-31-2007. INT. CL. 38.
- NATIONAL VIDEO RESOURCES, INC., NEW YORK, NY:
2,410,593, CANC. MULTIPLE CLASS, INT. CLS. 16 AND 41.
- NATIONAL VISION, INC., LAWRENCEVILLE, GA:
3,312,175, PUB. 7-31-2007. INT. CL. 9.
- NATIONAL WESTERN LIFE INSURANCE COMPANY, AUSTIN, TX:
2,020,659, CANC. INT. CL. 36.
- NATIONALWAY HEALTHCARE ASSOCIATION, HOUSTON, TX:
3,313,599, INT. CL. 35.

- NATIVE AMERICAN TELEVISION, INC., WASHINGTON, DC:
3,311,599, PUB. 7-31-2007. MULTIPLE CLASS, INT. CLS. 38 AND 41.
- NATREN, INC., LOS ANGELES, CA:
2,135,776, REN. 9-13-07. INT. CL. 5.
- NATROL, INC., CHATSWORTH, CA:
3,314,577, INT. CL. 5.
- NATURAL ALTERNATIVES INTERNATIONAL, INC., SAN MARCOS, CA:
2,095,080, REN. 9-7-07. INT. CL. 5.
- NATURAL MOTION MARTIAL ARTS, INC., SCARBOROUGH, ME:
3,313,700, INT. CL. 41.
- NATURAL NUTRITION CENTER INC., AMITYVILLE, NY:
2,109,089, REN. 9-7-07. INT. CL. 5.
- NATURAL ORGANICS INC., MELVILLE, NY:
3,314,466, INT. CL. 5.
- NATURE'S SUNSHINE PRODUCTS, INC., SPANISH FORK, UT:
1,419,567, CANC. INT. CL. 5.
1,419,568, CANC. INT. CL. 5.
- NAUTEL MAINE, INC., BANGOR, ME:
3,311,184, PUB. 7-31-2007. INT. CL. 9.
- NAVARRO DISCOUNT PHARMACIES NO. 1, LLC., MIAMI, FL:
2,098,890, REN. 9-7-07. INT. CL. 35.
2,102,864, REN. 9-13-07. INT. CL. 3.
- NAVISON AUDIO, SAN JOSE, CA:
3,310,811, PUB. 7-31-2007. INT. CL. 9.
- NCC INDUSTRIES, INC., NEW YORK, NY, GELMART INDUSTRIES, INC., COLLEGE POINT, NY:
1,071,869, REN. 9-13-07. INT. CL. 25.
- NCH CORPORATION, IRVING, TX:
1,450,296, REN. 9-13-07. INT. CL. 4.
- NEAR NORTH NATIONAL GROUP, INC., CHICAGO, IL:
2,411,468, CANC. INT. CL. 36.
- NEGOCIOS EDITORIALES PANAMÁ, S.A., PANAMÁ, PANAMA:
3,311,950, PUB. 7-31-2007. INT. CL. 16.
- NEIL JONES FOOD COMPANY, THE, VANCOUVER, WA:
2,089,203, REN. 9-7-07. INT. CL. 29.
- NEILL CORPORATION, HAMMOND, LA:
3,310,418, PUB. 7-31-2007. INT. CL. 35.
- NELLIE MAE CORPORATION, BRAINTREE, MA:
3,312,408, PUB. 7-31-2007. INT. CL. 36.
- NELSON, JEFFERY J., CHATHAM, MA:
3,313,376, INT. CL. 16.
- NEOPERL SERVISYS AG, SWITZERLAND:
3,312,857, PUB. 7-31-2007. MULTIPLE CLASS, INT. CLS. 11, 16, 17, 40 AND 42.
- NEOPETS, INC., GLENDALE, CA:
3,313,491, INT. CL. 20.
3,313,492, INT. CL. 20.
3,313,493, INT. CL. 20.
3,313,494, INT. CL. 20.
- NEPTUNE RESEARCH GROUP, INC., SAMMAMISH, WA:
3,313,425, INT. CL. 28.
- NER DATA PRODUCTS, INC., GLASSBORO, NJ:
3,314,218, MULTIPLE CLASS, INT. CLS. 37 AND 42.
- NERNBERG, ARNOLD, WHITTIER, CA:
2,974,053, COR. INT. CL. 10.
- NEST ENTERTAINMENT, INC., IRVING, TX:
2,410,234, CANC. INT. CL. 16.
- NESTLE WATERS NORTH AMERICA INC., GREENWICH, CT:
3,314,504, INT. CL. 32.
3,314,646, INT. CL. 32.
- NET RESOURCE GROUP, INC., GREER, SC:
2,410,472, CANC. INT. CL. 35.
- NETALOG, INC., CHARLESTON, SC:
3,313,500, INT. CL. 9.
- NETBANK, INC., ALPHARETTA, GA:
3,313,571, INT. CL. 36.
- NETFOLIO, L.L.C., GREENWICH, CT TO NETFOLIO, L.L.C., GREENWICH, CT:
2,411,402, CANC. INT. CL. 36.
- NETGIFT REGISTRY, INC., DURHAM, NC:
2,411,542, CANC. INT. CL. 35.
- NETSET INTERNET SERVICES, INC., HILLIARD, OH:
2,409,896, CANC. INT. CL. 42.
- NETVALUE (S.A.), 75116 PARIS, FRANCE:
2,410,203, CANC. MULTIPLE CLASS, INT. CLS. 9, 35, 38 AND 42.
- NETWORK OPTIONS, INC., FORT COLLINS, CO:
3,311,930, PUB. 4-10-2007. INT. CL. 35.
- NETWORK SOLUTIONS, LLC, HERNDON, VA:
3,313,204, INT. CL. 35.
- NEUSOFT GROUP LTD., LIAONING PROVINCE, CHINA:
3,311,849, PUB. 7-31-2007. MULTIPLE CLASS, INT. CLS. 9, 10 AND 42.
- NEUVILLE INDUSTRIES, INC., HICKORY, NC:
1,419,251, CANC. INT. CL. 25.
- NEVADA BOB'S TRADEMARKS LLC, HARTFORD, CT:
1,462,974, REN. 9-13-07. INT. CL. 28.
- NEVADA BOB'S TRADEMARKS LLC, HARTFORD, CT, NEVADA BOB'S PRO SHOP, INC., LAS VEGAS, NV:
2,046,177, REN. 9-13-07. INT. CL. 25.
- NEW ACCESS MUSIC, LP, HOUSTON, TX:
3,312,470, PUB. 7-31-2007. INT. CL. 41.
- NEW BRAUNFELS UTILITIES, NEW BRAUNFELS, TX:
3,310,305, PUB. 7-31-2007. INT. CL. 45.
- NEW CENTURY SNACKS, LLC, COMMERCE, CA:
3,313,046, MULTIPLE CLASS, INT. CLS. 29 AND 30.
- NEW ENGLAND BROADCASTING AND ENTERTAINMENT CO., INC., MARLBOROUGH, MA:
3,312,271, PUB. 7-31-2007. INT. CL. 43.
- NEW ENGLAND ORTHOPEDIC SPECIALISTS, PEABODY, MA:
3,310,670, PUB. 7-31-2007. INT. CL. 44.
- NEW ENGLAND TEA & COFFEE CO., INC., MALDEN, MA:
3,312,138, PUB. 7-31-2007. INT. CL. 35.
3,312,141, PUB. 7-31-2007. INT. CL. 21.
3,312,144, PUB. 7-31-2007. INT. CL. 30.
3,312,145, PUB. 7-31-2007. INT. CL. 30.
- NEW PHAZE PACKAGING, INC., CHATSWORTH, CA:
3,313,380, INT. CL. 3.
- NEW VISION USA, INC., SCOTTSDALE, AZ:
3,313,458, INT. CL. 3.
- NEW YORK - NEW YORK HOTEL & CASINO, LLC, LAS VEGAS, NV:
3,311,662, PUB. 7-31-2007. INT. CL. 35.
- NEW YORK - NEW YORK HOTEL & CASINO, LLC., LAS VEGAS, NV:
2,409,761, CANC. INT. CL. 25.
- NEW YORK DESIGN CENTER, INC., NEW YORK, NY:
3,310,346, PUB. 7-31-2007. INT. CL. 35.
- NEW YORK TIMES COMPANY, THE, NEW YORK, NY:
2,087,054, REN. 9-7-07. INT. CL. 16.
- NEW YORK YACHT CLUB, NEW YORK, NY:
822,593, REN. 9-12-07. U.S. CL. 200.
- NEW YORK-NEW YORK HOTEL & CASINO, LLC, LAS VEGAS, NV:
3,312,526, PUB. 7-31-2007. INT. CL. 43.
- NEWBAY MEDIA LLC, NEW YORK, NY:
3,314,977, INT. CL. 41.
- NEWCOMB OIL CO., BARDSTOWN, KY:
2,088,705, REN. 9-7-07. INT. CL. 42.
- NEWCOMB OIL CO. LLC, BARDSTOWN, KY:
3,312,632, PUB. 3-20-2007. MULTIPLE CLASS, INT. CLS. 4 AND 35.
- NEWEDGE, INC., RICHLAND, WA:
3,314,925, INT. CL. 35.
3,315,016, INT. CL. 35.
- NEWHOME WARRANTY MANAGEMENT, INC., ROSWELL, GA:
3,310,655, PUB. 7-31-2007. INT. CL. 36.
- NEWMAN, ROBERT D., GREENWOOD, MO AND SPECIALTY PRODUCTS OF GREENWOOD, MISSOURI, INC., GREENWOOD, MO:
3,313,034, INT. CL. 16.
- NEWPOINT CORPORATION, SAN DIEGO, CA TO SECURESOFT, INC., SEOUL, REPUBLIC OF KOREA:
2,020,620, CANC. INT. CL. 9.

NEWSDAY, INC., MELVILLE, NY:
2,411,591, CANC. INT. CL. 16.

NEWTEK BUSINESS SERVICES, INC., NEW YORK, NY:
3,312,445, PUB. 7-31-2007. MULTIPLE CLASS, INT. CLS.
35, 36, 38 AND 42.

NEXGEN SOFTWARE (S.A.R.L.), 92370 CHAVILLE,
FRANCE:
3,310,207, PUB. 7-31-2007. INT. CL. 9.

NEXO COMMUNICATIONS, LLC, LAKE WORTH, FL:
3,312,148, PUB. 7-31-2007. INT. CL. 38.

NEXT WAVE WORLD INCORPORATED, SAYVILLE, NY:
2,411,261, CANC. INT. CL. 3.

NGUYEN, MARC T., GARDENA, CA:
2,410,778, CANC. INT. CL. 25.

NHN CORPORATION, GYEONGGI-DO, REPUBLIC OF
KOREA:
3,312,065, PUB. 7-31-2007. MULTIPLE CLASS, INT. CLS. 9
AND 41.

NHS, INC., SANTA CRUZ, CA:
2,134,679, REN. 9-13-07. INT. CL. 25.
2,137,534, REN. 9-13-07. INT. CL. 16.

NICHOLAS RESEARCH ASSOCIATES INTERNATIONAL,
INC., NEW YORK, NY:
3,311,045, PUB. 7-31-2007. INT. CL. 42.

NICKELL, ROBERT P, TORRANCE, CA:
3,313,255, INT. CL. 5.

NIDAR AS, 7004 TRONDHEIM, NORWAY:
1,459,414, REN. 9-13-07. INT. CL. 30.

NIDCAP FEDERATION INTERNATIONAL, INC., MEL-
ROSE, MA:
3,314,889, INT. CL. 16.

NIELSEN, JOHN, LOS ANGELES, CA:
2,410,304, CANC. MULTIPLE CLASS, INT. CLS. 38 AND
39.

NIEN MADE ENTERPRISE CO., LTD., TAICHUNG, TAI-
WAN:
3,313,114, MULTIPLE CLASS, INT. CLS. 19, 20 AND 24.

NIGHT FLOWERS, INC.:
1,419,285, CANC. INT. CL. 25.

NIGRELLI SYSTEMS, INC., KIEL, WI:
3,311,645, PUB. 7-31-2007. MULTIPLE CLASS, INT. CLS.
7, 11 AND 35.

NIKE, INC., BEAVERTON, OR:
3,314,006, INT. CL. 9.

NIKON INC., GARDEN CITY, NY:
1,419,058, CANC. INT. CL. 9.

NIKON INC., MELVILLE, NY:
1,419,578, CANC. INT. CL. 9.

NINE STONES, LLC, PORTLAND, ME:
3,313,041, INT. CL. 44.

NINGBO FUTIAN GROUP CO., LTD., CHINA:
3,312,922, PUB. 7-31-2007. INT. CL. 25.

NINGBO HAITAI MACHINERY; MANUFACTURE CO.,
LTD., CHINA:
3,312,916, PUB. 7-31-2007. INT. CL. 7.

NINGBO ORIENT GROUP CO., LTD; (NINGBO DONG-
FANG JITUAN; YOUXIAN GONGSI), NINGBO CITY;
ZHEJIANG 315800, CHINA:
3,312,784, PUB. 4-17-2007. INT. CL. 9.

NINGBO QIFA FURNITURE CO., LTD, CIXI CITY, ZHE-
JIANG, CHINA:
3,312,048, PUB. 7-31-2007. INT. CL. 20.

NIPPON KAGAKU KOGYO KABUSHIKI KAISHA, KOTO-
KU, TOKYO, JAPAN, DBA NIPPON CHEMICAL INDUS-
TRIAL CO., LTD.:
2,092,320, REN. 9-13-07. INT. CL. 1.

NISSAN JIDOSHA KABUSHIKI KAISHA, TOKYO, JAPAN,
TA NISSAN MOTOR CO., LTD.:
3,313,368, INT. CL. 28.

NISSHINBO INDUSTRIES, INC., TOKYO, JAPAN:
1,419,256, CANC. INT. CL. 25.

NLGI, KANSAS CITY, MO:
3,313,956, U.S. CL. A.

NLP IP COMPANY, WILMINGTON, DE:
2,411,586, CANC. INT. CL. 16.

NO HEAT RESOURCES, LLC, MIDLAND, TX:
3,310,794, PUB. 7-31-2007. INT. CL. 1.
3,310,795, PUB. 7-31-2007. INT. CL. 1.
3,310,796, PUB. 7-31-2007. INT. CL. 1.
3,310,812, PUB. 7-31-2007. INT. CL. 1.

NOBEL BIOCARE SERVICES AG, ZURICH-FLUGHAFEN,
SWITZERLAND:
3,311,902, PUB. 7-31-2007. INT. CL. 44.

NOBL LABORATORIES, INC., SIOUX CENTER, IA:
1,418,900, CANC. INT. CL. 5.

NOBLE FIBER TECHNOLOGIES, LLC, SCRANTON, PA:
3,314,157, INT. CL. 25.
3,314,258, INT. CL. 5.

NOBLE HOUSE GROUP PTY LTD, FYSHWICK, AUSTRALIA:
3,311,906, PUB. 7-31-2007. INT. CL. 10.

NOKIAN TYRES LIMITED, 37101 NOKIA, FINLAND:
2,593,508, CANC. INT. CL. 12.

NOMACO INC., ZEBULON, NC:
2,113,026, REN. 9-7-07. INT. CL. 17.

NOMURA, NAOHIRA, NEW YORK, NY:
3,313,962, MULTIPLE CLASS, INT. CLS. 3 AND 44.

NONESUCH RECORDS INC., NEW YORK, NY:
3,313,537, INT. CL. 9.

NORBAR TORQUE TOOLS LTD., BANBURY, ENGLAND:
2,154,753, REN. 9-11-07. INT. CL. 7.

NORCO PRODUCTS, LTD., BURNABY, BRITISH COLUMBIA,
CANADA:
1,419,107, CANC. INT. CL. 12.

NORCOM INCORPORATED, NORCROSS, GA:
2,410,754, CANC. INT. CL. 16.

NORDSON CORPORATION, WESTLAKE, OH:
3,313,442, INT. CL. 6.

NORESCO, LLC, WESTBOROUGH, MA:
2,410,236, CANC. INT. CL. 35.

NORLANDER'S ORIGINAL FOODS, INC., AMARILLO, TX:
3,310,923, PUB. 7-31-2007. MULTIPLE CLASS, INT. CLS.
29 AND 30.

NORSK HYDRO ASA, NORWAY:
3,312,712, PUB. 7-31-2007. MULTIPLE CLASS, INT. CLS.
1, 4, 6, 22, 37, 39, 40 AND 42.

NORTEL NETWORKS NA INC., SANTA CLARA, CA:
2,409,682, CANC. INT. CL. 9.

NORTH AMERICAN COMPANY FOR LIFE AND HEALTH
INSURANCE, CHICAGO, IL:
3,311,596, PUB. 7-31-2007. INT. CL. 36.

NORTH AMERICAN GREEN, INC., EVANSVILLE, IN:
2,411,368, CANC. INT. CL. 19.

NORTH AMERICAN MEMBERSHIP GROUP INC., MINNE-
TONKA, MN:
2,481,912, CANC. INT. CL. 35.
2,484,032, CANC. INT. CL. 35.

NORTH AMERICAN PUBLISHING COMPANY, PHILADEL-
PHIA, PA:
3,314,288, INT. CL. 16.

NORTH PACIFIC GROUP, INC., PORTLAND, OR:
2,409,778, CANC. INT. CL. 35.

NORTH PASS, LTD., FORT COLLINS, CO:
3,314,394, INT. CL. 13.

NORTH POINT MINISTRIES, INC., ALPHARETTA, GA:
3,310,518, PUB. 7-31-2007. INT. CL. 41.

NORTH STATES INDUSTRIES, INC., BLAINE, MN:
3,312,466, PUB. 7-31-2007. INT. CL. 19.

NORTH TEXAS PUBLIC BROADCASTING, INC., DALLAS,
TX:
3,313,279, INT. CL. 41.

NORTHERN CANOLA GROWERS ASSOCIATION INC,
BISMARCK, ND:
3,311,427, PUB. 7-31-2007. INT. CL. 4.

NORTHERN GOOSE PROCESSORS LTD., TEULON, MAN-
ITOBA, CANADA:
2,020,482, CANC. INT. CL. 29.

NORTHERN STAR DEALERSHIP SERVICES, L.L.C., OAK-
BROOK, IL:
2,410,598, CANC. INT. CL. 36.

NORTHFORK ENTERPRISE, INC., SANTA CLARITA, CA:
3,314,092, INT. CL. 35.

- NORTHVILLE LABORATORIES, INC., NORTHVILLE, MI:
341,211, CANC. U.S. CL. 46.
- NORTHWEST ENERGY EFFICIENCY ALLIANCE, PORTLAND, OR:
2,410,294, CANC. U.S. CL. B.
- NORTON LLC, ST. PAUL, MN:
3,310,444, PUB. 7-31-2007. MULTIPLE CLASS, INT. CLS. 35 AND 41.
- NOSA, INC., TOLEDO, OH:
3,314,744, INT. CL. 42.
- NOTTINGHAM REHAB LIMITED, UNITED KINGDOM:
3,312,760, PUB. 7-31-2007. INT. CL. 10.
- NOURISHE, L.L.C., JUPITER, FL:
3,313,269, INT. CL. 44.
- NOVA DEVELOPMENT CORPORATION, CALABASAS, CA:
2,168,005, REN. 9-10-07. INT. CL. 9.
- NOVA GRAFON'S GRÁFICA E EDITORA LTDA, BARUERI - SP, BRAZIL:
3,313,736, INT. CL. 16.
- NOVARTIS AG, BASEL, SWITZERLAND, SANDOZ PHARMACEUTICALS CORPORATION, E. HANOVER, NJ:
1,452,879, REN. 9-11-07. INT. CL. 5.
- NOVARTIS AG, 4002 BASEL, SWITZERLAND:
2,411,125, CANC. INT. CL. 20.
- NOVARTIS AG, BASEL, SWITZERLAND:
2,411,219, CANC. INT. CL. 16.
- NOVARTIS AG, SWITZERLAND:
3,312,949, PUB. 7-31-2007. INT. CL. 5.
3,312,974, PUB. 7-31-2007. INT. CL. 5.
- NOVATEK INTERNATIONAL INC., PROVO, UT:
3,314,779, INT. CL. 7.
- NOVAVISION, INC., BOCA RATON, FL:
3,310,260, PUB. 7-31-2007. MULTIPLE CLASS, INT. CLS. 10, 16, 41 AND 44.
- NOVIA CARECLINICS, LLC, INDIANAPOLIS, IN:
3,312,018, PUB. 7-31-2007. INT. CL. 35.
3,312,025, PUB. 7-31-2007. INT. CL. 35.
- NOVOSEL, SR, JOHN M., LEAWOOD, KS:
3,310,958, PUB. 7-31-2007. INT. CL. 28.
- NOVOZYMES DELTA LIMITED, NOTTINGHAM, UNITED KINGDOM:
3,310,188, PUB. 7-31-2007. MULTIPLE CLASS, INT. CLS. 1 AND 5.
- NOVUS PUBLISHING, INC., OAK BROOK, IL:
2,411,554, CANC. INT. CL. 16.
- NOXELL CORPORATION, HUNT VALLEY, MD:
3,314,356, INT. CL. 3.
- NPB GREETINGS CORPORATION, EAST ORANGE, NJ:
3,310,447, PUB. 7-31-2007. INT. CL. 16.
- NPOINT, INC., MIDDLETON, WI:
2,411,396, CANC. INT. CL. 9.
- NRX GLOBAL CORP., TORONTO, ONTARIO M5H 3S5, CANADA:
3,313,044, MULTIPLE CLASS, INT. CLS. 9 AND 42.
- NSCORE, INC., JAPAN:
3,312,912, PUB. 7-31-2007. MULTIPLE CLASS, INT. CLS. 7, 9, 37, 40 AND 42.
- NSF INTERNATIONAL, ANN ARBOR, MI:
3,312,090, PUB. 7-31-2007. MULTIPLE CLASS, INT. CLS. 35, 36, 37 AND 42.
- NSM RESOURCES CORPORATION, TAHOE CITY, CA:
3,310,854, PUB. 7-31-2007. MULTIPLE CLASS, INT. CLS. 28 AND 35.
- NTP DISTRIBUTION, INC., WILSONVILLE, OR:
1,419,170, CANC. INT. CL. 16.
- NTR, S.L., SPAIN:
3,312,867, PUB. 7-31-2007. MULTIPLE CLASS, INT. CLS. 9, 38 AND 42.
3,312,946, PUB. 7-31-2007. MULTIPLE CLASS, INT. CLS. 9, 38 AND 42.
- NTT ADVANCED TECHNOLOGY CORPORATION, SHINJUKU-KU, TOKYO, JAPAN:
3,314,219, INT. CL. 21.
- NU HORIZONS ELECTRONICS CORP., MELVILLE, NY:
3,313,794, INT. CL. 35.
- NUCANOE, INC., BELLINGHAM, WA:
3,314,205, INT. CL. 12.
- NUCOR CORPORATION, CHARLOTTE, NC:
2,411,469, CANC. INT. CL. 6.
- NUEVE ESPERANZA, INC., PHILADELPHIA, PA:
3,311,982, PUB. 7-31-2007. INT. CL. 35.
- NUHERTZ TECHNOLOGIES, LLC, PHOENIX, AZ:
3,310,731, PUB. 7-31-2007. INT. CL. 9.
- NUMENTA, INC., MENLO PARK, CA:
3,314,259, INT. CL. 9.
- NUTRAMAX LABORATORIES, INC., EDGEWOOD, MD:
3,314,416, INT. CL. 5.
- NUTRIBIOTIC, INC., LAKEPORT, CA:
3,310,212, PUB. 7-31-2007. INT. CL. 5.
- NUTRIGENIC LABORATORIES INC., AMITYVILLE, NY:
3,314,024, INT. CL. 5.
- NUTRITION NOW, INC., VANCOUVER, WA:
3,311,264, PUB. 7-31-2007. INT. CL. 5.
- NUTRITION XPRESS, LLC, HOUSTON, TX:
3,314,110, INT. CL. 35.
- NVE BANK, ENGLEWOOD, NJ:
3,311,371, PUB. 7-31-2007. INT. CL. 36.
- NVISION DESIGN, INC., OMAHA, NE:
2,410,229, CANC. MULTIPLE CLASS, INT. CLS. 35 AND 42.
- NWT WORLD ARTS, INC., PALM SPRINGS, CA, DBA NEW WORLD TRADING:
3,312,354, PUB. 7-31-2007. INT. CL. 21.
- NYX, LOS ANGELES INC., COMMERCE, CA:
3,310,379, PUB. 7-31-2007. INT. CL. 3.
3,310,409, PUB. 7-31-2007. INT. CL. 3.
- NZ HYDROPONICS INTERNATIONAL LTD., TAURANGA, NEW ZEALAND:
3,311,858, PUB. 7-31-2007. MULTIPLE CLASS, INT. CLS. 9 AND 11.
- O.T.C.B. INC., CLEARWATER, FL:
2,411,351, CANC. INT. CL. 5.
- O'BRIEN FAMILY VINEYARD LLC, NAPA, CA:
3,310,881, PUB. 7-31-2007. INT. CL. 36.
- O'KEEFE, MILES J., GULFPORT, MS AND HAWTHORNE, RICHARD C., GULFPORT, MS AND O'KEEFE, JULES, GULFPORT, MS:
3,310,836, PUB. 7-31-2007. INT. CL. 41.
- O'NEIL, BRIAN, CARMEL, CA:
3,311,692, PUB. 2-13-2007. INT. CL. 25.
- O'NEIL, DIANNE, NASHVILLE, TN:
3,313,178, INT. CL. 30.
- O'SULLIVAN, JAMES P. SR., LEESBURG, FL:
3,314,441, INT. CL. 25.
- O'SULLIVAN, PATRICIA A., SANTA FE, NM:
3,312,207, PUB. 7-31-2007. INT. CL. 41.
- OAKLEY, INC., FOOTHILL RANCH, CA:
3,313,594, INT. CL. 9.
- OBEDIENCE WORKS, LLC, SILVER SPRING, MD:
3,310,391, PUB. 7-10-2007. INT. CL. 41.
- OBERON MEDIA, INC., NEW YORK, NY:
3,311,700, PUB. 7-31-2007. MULTIPLE CLASS, INT. CLS. 9, 35, 41 AND 42.
- OBSHCHESTVO S OGRANICHENNOY; OTVETSTVENNOSTYU "GRUPPA; KOMPANY UNISERVIS", RUSSIAN FED.:
3,312,849, PUB. 7-31-2007. INT. CL. 30.
- OC HOSTING, INC., SAN CLEMENTE, CA:
3,205,369, CANC. IIRN. RESTORED TO S.N. 78-731,516.
- OCE-TECHNOLOGIES B.V., VENLO, NETHERLANDS:
3,311,634, PUB. 7-31-2007. MULTIPLE CLASS, INT. CLS. 2, 9, 16, 37 AND 42.
- OCEAN GROUP, INC., THE, PROVIDENCE, RI:
2,021,049, CANC. INT. CL. 42.
- OCEANSIDE GLASSTILE COMPANY, CARLSBAD, CA:
3,314,274, INT. CL. 19.
- ODORIZZI PORFIDI S.P.A., ITALY:
3,312,847, PUB. 7-31-2007. INT. CL. 19.
- ODWALLA, INC., HALF MOON BAY, CA:
3,310,686, PUB. 7-31-2007. INT. CL. 30.
- ODYSSEY EYEWEAR PTY LTD, NORTH FREMANTLE, AUSTRALIA:
2,411,449, CANC. INT. CL. 9.
- ODYSSEY, L.P., SAN FRANCISCO, CA:
2,021,245, CANC. INT. CL. 42.

OF THE NET, INC., RUTHERFORD, NJ:
3,311,291, PUB. 7-31-2007. INT. CL. 35.

OFFENBACHER, DOUG, SANTA ROSA, CA AND GENERATIONS OF SONOMA, LLC, SONOMA, CA:
3,312,009, PUB. 7-31-2007. INT. CL. 33.

OFFICIAL PILLOWTEX LLC, COLUMBUS, OH:
2,410,029, CANC. MULTIPLE CLASS, INT. CLS. 20 AND 24.

OFFPLANPLANET LTD., UNITED KINGDOM:
3,312,917, PUB. 7-31-2007. INT. CL. 36.

OGALLALA DOWN COMFORTER COMPANY, OGALLALA, NE:
3,310,904, PUB. 7-31-2007. MULTIPLE CLASS, INT. CLS. 3 AND 4.

OGUDE, CHUKUMA MARCEL, ITHACA, NY:
3,310,974, PUB. 7-31-2007. INT. CL. 41.

OH, STEVEN S., STUDIO CITY, CA:
3,310,994, PUB. 7-31-2007. MULTIPLE CLASS, INT. CLS. 9 AND 18.

OHIO BRANDS, INC., SUNNY ISLES, FL:
3,314,179, INT. CL. 34.

OHIO FARMERS INSURANCE COMPANY, WESTFIELD CENTER, OH:
3,314,556, MULTIPLE CLASS, INT. CLS. 35, 36, 41, 42, 44 AND 45.

OHIO MATTRESS COMPANY LICENSING AND COMPONENTS GROUP, THE, CLEVELAND, OH:
1,419,216, CANC. INT. CL. 20.

OIL PROCESS SYSTEMS, INC., ALLENTOWN, PA:
3,311,911, PUB. 7-31-2007. INT. CL. 1.

OILS BY NATURE, INC., SOLON, OH:
3,313,856, MULTIPLE CLASS, INT. CLS. 1 AND 3.
3,313,857, MULTIPLE CLASS, INT. CLS. 1 AND 3.

OKLAHOMA STATE UNIVERSITY FOUNDATION, STILLWATER, OK:
3,311,458, PUB. 7-31-2007. INT. CL. 36.

OKONSKY, DANIEL, SAN MARCOS, CA AND OKONSKY, DORIS, SAN MARCOS, CA:
2,411,015, CANC. INT. CL. 20.

OLAES ENTERPRISES, INC., POWAY, CA, DBA ODM:
3,314,854, INT. CL. 25.

OLD EUROPEAN BREWERY COMPANY, SAN DIEGO, CA:
2,021,290, CANC. INT. CL. 32.
2,021,291, CANC. INT. CL. 32.

OLD EUROPEAN BREWERY COMPANY, SAN DIEGO, IL:
2,021,292, CANC. INT. CL. 32.

OLIVE, MARCEL, MARSEILLE, FRANCE:
3,311,960, PUB. 7-31-2007. INT. CL. 9.

OLIVINA, LLC, LIVERMORE, CA:
3,313,799, INT. CL. 29.

OLMIX, FRANCE:
3,312,708, PUB. 7-31-2007. MULTIPLE CLASS, INT. CLS. 5 AND 31.

OLSSON, RICHARD C., RIVERSIDE, CA, DBA ALLIANCE GAME COMPANY:
2,410,774, CANC. INT. CL. 28.

OLYMPUS AMERICA, INC., CENTER VALLEY, PA:
3,313,415, INT. CL. 41.

OLYMPUS OPTICAL CO., LTD., TOKYO, JAPAN:
2,409,688, CANC. INT. CL. 9.

OM BEBE INC., SAUSALITO, CA:
3,311,800, PUB. 7-31-2007. MULTIPLE CLASS, INT. CLS. 24 AND 25.

OMEGA BOYS CLUB, SAN FRANCISCO, CA:
2,096,546, REN. 9-10-07. INT. CL. 42.

OMEGA ONE COMMUNICATIONS, LLC, SUMMERSVILLE, SC:
2,411,063, CANC. INT. CL. 9.

OMNI INSURANCE GROUP, ATLANTA, GA:
3,310,775, PUB. 7-31-2007. INT. CL. 36.

OMNICOM HOLDINGS INC., SAN FRANCISCO, CA, OMNICOM GROUP INC., NEW YORK, NY:
2,090,599, REN. 9-10-07. INT. CL. 35.
2,090,629, REN. 9-10-07. INT. CL. 35.

OMNIFLIGHT HELICOPTERS, INC., ADDISON, TX:
3,311,055, PUB. 7-31-2007. MULTIPLE CLASS, INT. CLS. 37 AND 39.

OMNITECH INTERNATIONAL, INC., GOLDEN, CO:
3,310,434, PUB. 5-15-2007. INT. CL. 42.

OMS INVESTMENTS, INC., LOS ANGELES, CA:
1,071,233, REN. 9-9-07. INT. CL. 1.

OMS INVESTMENTS, INC., LOS ANGELES, CA, CHEVRON CHEMICAL COMPANY, SAN FRANCISCO, CA:
1,071,832, REN. 9-13-07. INT. CL. 16.

ON AIR ON LINE, SHERMAN OAKS, CA:
3,310,220, PUB. 7-31-2007. INT. CL. 14.

ON SITE DERMATOLOGY, LLC, BOCA RATON, FL:
3,313,933, INT. CL. 44.

ON THE GO SOLUTIONS, INC., SKOKIE, IL:
3,312,559, PUB. 4-24-2007. INT. CL. 35.

ONAIRFUNDRAISING, LLC, ROSEVILLE, MN:
3,314,751, INT. CL. 35.

ONBOARD RESEARCH CORPORATION, CARROLLTON, TX:
3,313,931, INT. CL. 9.
3,313,932, INT. CL. 9.

ONE COMMUNICATIONS, WALTHAM, MA:
3,310,581, PUB. 7-31-2007. MULTIPLE CLASS, INT. CLS. 38 AND 42.

ONE SIX EIGHT, LLC, BEDFORD HEIGHTS, OH, DBA KRIS' KITCHEN:
3,311,358, PUB. 7-31-2007. INT. CL. 35.

ONEPIN, INC., WESTBOROUGH, MA:
3,312,488, PUB. 7-31-2007. INT. CL. 35.

ONEWAY, LLC, CHARLESTON, SC:
3,310,786, PUB. 7-31-2007. INT. CL. 35.

ONGISTICS CORPORATION, HOUSTON, TX:
3,313,149, INT. CL. 35.

ONIEAL, KATHERINE, MUNCIE, IN:
3,313,711, INT. CL. 43.

ONSCREEN TECHNOLOGIES, INC., SAFETY HARBOR, FL:
3,313,126, INT. CL. 9.

ON2 TECHNOLOGIES, INC., TARRYTOWN, NY:
3,311,574, PUB. 7-31-2007. INT. CL. 9.

ON24, INC., SAN FRANCISCO, CA:
3,314,298, INT. CL. 42.

OPEL EISENACH GMBH, EISENACH, FED REP GERMANY:
3,312,440, PUB. 7-31-2007. INT. CL. 12.

OPEL EISENACH GMBH, FED REP GERMANY:
3,312,828, PUB. 7-31-2007. INT. CL. 12.
3,312,854, PUB. 7-31-2007. INT. CL. 12.
3,312,856, PUB. 7-31-2007. INT. CL. 12.

OPEN GRID FORUM, LEMONT, IL:
3,311,738, PUB. 7-31-2007. MULTIPLE CLASS, INT. CLS. 16 AND 41.

OPENPAD, INC., NEW YORK, NY:
3,311,390, PUB. 7-31-2007. INT. CL. 42.

OPPORTUNITY FINANCE CORPORATION, PHILADELPHIA, PA:
3,312,227, PUB. 7-31-2007. INT. CL. 35.

OPTIMAL WELLNESS AND BODY SCULPTING, INC., PHILADELPHIA, PA:
3,310,761, PUB. 7-31-2007. INT. CL. 41.

OPTIMISO SA, SWITZERLAND:
3,312,758, PUB. 4-10-2007. MULTIPLE CLASS, INT. CLS. 9, 35, 41 AND 42.

OPTIMUM NUTRITION, INC., AURORA, IL:
3,311,720, PUB. 7-31-2007. INT. CL. 5.

OPTIMUS, INC., MIAMI, FL:
3,310,510, PUB. 7-31-2007. INT. CL. 35.

OPTIONS UNLIMITED INTERNATIONAL, L.L.C., WOODINVILLE, WA:
3,314,212, INT. CL. 20.

ORACLE CORPORATION, REDWOOD CITY, CA:
2,411,477, CANC. INT. CL. 9.

ORALABS, INC., PARKER, CO:
3,314,149, INT. CL. 3.

ORANBURG, PHILIP R., BOCA RATON, FL:
3,313,090, INT. CL. 44.

ORCA BAY SEAFOODS, INC., RENTON, WA:
2,141,043, REN. 9-13-07. INT. CL. 29.

- ORCAS INTERNATIONAL, INC., FLANDERS, NJ:
3,310,402, PUB. 7-31-2007. INT. CL. 5.
3,310,405, PUB. 7-31-2007. INT. CL. 5.
3,310,423, PUB. 7-31-2007. INT. CL. 5.
- ORCHARD YARN AND THREAD COMPANY INC., NEW YORK, NY, DBA LION BRAND YARN COMPANY:
3,314,741, INT. CL. 23.
- ORECK HOLDINGS, LLC, CHEYENNE, WY:
1,453,989. REN. 9-11-07. INT. CL. 9.
1,454,954. REN. 9-13-07. INT. CL. 9.
- OREGON ENVIRONMENTAL SYSTEMS, BEAVERTON, OR:
3,310,428, PUB. 7-31-2007. INT. CL. 40.
- ORIBAY MIRROR BUTTONS, S.L., E-20018 SAN SEBASTIÁN (GUIPÚZCOA), SPAIN:
3,312,945, PUB. 7-31-2007. INT. CL. 12.
- ORIENTAL MOTOR CO., LTD., TOKYO, JAPAN:
3,313,779, MULTIPLE CLASS, INT. CLS. 7 AND 9.
- ORIGIN PRODUCTS LIMITED, LONDON, UNITED KINGDOM:
3,311,932, PUB. 7-31-2007. MULTIPLE CLASS, INT. CLS. 9, 16, 28 AND 41.
- ORIGINS NATURAL RESOURCES, INC., NEW YORK, NY:
3,312,089, PUB. 7-31-2007. INT. CL. 3.
- ORION SCREENWORKS INC., NORTH VANCOUVER, CANADA:
3,312,030, PUB. 7-31-2007. INT. CL. 25.
- ORION SEARCH GROUP, INC., EDINA, MN:
3,311,774, PUB. 7-31-2007. INT. CL. 35.
- ORIOR AG, CH-8052 ZÜRICH, SWITZERLAND:
3,312,858, PUB. 7-31-2007. MULTIPLE CLASS, INT. CLS. 29 AND 30.
- ORNER, CAROLINE H., HAGERSTOWN, MD:
3,313,231, INT. CL. 9.
- ORO CLEAN CHEMIE AG, CH-8320 FEHRALTORF, SWITZERLAND:
3,312,914, PUB. 7-31-2007. INT. CL. 5.
- OROBIANCO S.R.L., I-21013 GALLARATE (VA), ITALY:
3,312,925, PUB. 7-31-2007. MULTIPLE CLASS, INT. CLS. 18 AND 25.
- ORTHO-FLEX SADDLE COMPANY, INC., NEVADA, MO:
2,409,734, CANC. MULTIPLE CLASS, INT. CLS. 18 AND 25.
- ORVIS COMPANY, INC., THE, MANCHESTER, VT:
2,484,682, CANC. INT. CL. 40.
- OSIM INTERNATIONAL LTD., SINGAPORE, SINGAPORE:
3,311,644, PUB. 7-31-2007. INT. CL. 35.
- OSRAM SYLVANIA INC., DANVERS, MA:
2,020,109, CANC. INT. CL. 11.
- OSSUR HF., REYKJAVIK 110, ICELAND:
2,178,925. REN. 9-13-07. INT. CL. 10.
- OTEY, LISA, TUCSON, AZ:
2,410,205, CANC. INT. CL. 9.
- OTREERRE S.P.A., ITALY:
3,312,700, PUB. 7-31-2007. INT. CL. 25.
- OUTCOMES PHARMACEUTICAL HEALTH CARE, L.C., DES MOINES, IA:
3,310,339, PUB. 7-31-2007. INT. CL. 35.
3,310,340, PUB. 7-31-2007. INT. CL. 35.
- OUTDOOR LIFE NETWORK, L.L.C., STAMFORD, CT:
3,313,523, INT. CL. 41.
- OUTDOOR SPORTS MARKETING, HENDERSONVILLE, NC:
3,311,553, PUB. 7-31-2007. INT. CL. 35.
- OUTERWEARS, INC., SCHOOLCRAFT, MI:
3,313,203, INT. CL. 28.
- OVERRIDE COSMETICS, LLC, NEW YORK, NY:
3,314,810, INT. CL. 3.
- OWENS CORNING INTELLECTUAL CAPITAL, LLC, TOLEDO, OH:
2,095,980. REN. 9-13-07. INT. CL. 17.
2,101,119. REN. 9-13-07. INT. CL. 19.
- OWNER AMERICAN CORP., COSTA MESA, CA:
3,314,878, INT. CL. 28.
- OX IDEAS, INC., MIAMI, FL:
3,310,838, PUB. 7-31-2007. INT. CL. 41.
- OXBO INTERNATIONAL CORPORATION, BYRON, NY:
3,314,624, INT. CL. 7.
- OXFORD UNIVERSITY PRESS, INC., NEW YORK, NY:
3,314,913, MULTIPLE CLASS, INT. CLS. 41 AND 42.
- OXYFRESH WORLDWIDE, INC., COEUR D'ALENE, ID:
3,312,461, PUB. 12-19-2006. INT. CL. 5.
- OZANTEKS TEKSTIL; SANAYI VE TICARET ANONIM SIRKETI, TURKEY:
3,312,803, PUB. 6-19-2007. MULTIPLE CLASS, INT. CLS. 24 AND 25.
- OZMOZIZ CORPORATION, CORAL GABLES, FL:
2,410,387, CANC. INT. CL. 3.
- P. EAST TRADING CORP., BRONX, NY:
3,314,565, INT. CL. 29.
- P. H. GLATFELTER COMPANY, YORK, PA:
3,314,230, INT. CL. 16.
- P.S. CLEARANCE CO., INC., NEW HYDE PARK, NY:
3,310,218, PUB. 7-31-2007. INT. CL. 39.
- PABST BREWING COMPANY, MILL VALLEY, CA, G. HEILEMAN BREWING COMPANY, INC., LA CROSSE, WI:
1,080,557. REN. 9-7-07. INT. CL. 32.
- PABST BREWING COMPANY, MILL VALLEY, CA, STROH BREWERY COMPANY, THE, DETROIT, MI:
2,086,765. REN. 9-13-07. INT. CL. 32.
- PABST BREWING COMPANY, MILL VALLEY, CA:
2,126,978. REN. 9-13-07. INT. CL. 32.
- PACHELLA, SOPHIE, NEW YORK, NY:
3,312,582, PUB. 4-17-2007. INT. CL. 44.
- PACIFIC BRANDS SPORT & LEISURE PTY LTD, VICTORIA, AUSTRALIA:
3,311,684, PUB. 7-31-2007. MULTIPLE CLASS, INT. CLS. 9, 18 AND 25.
3,311,685, PUB. 7-31-2007. INT. CL. 9.
3,311,686, PUB. 7-31-2007. MULTIPLE CLASS, INT. CLS. 25 AND 35.
- PACIFIC COAST FEATHER COMPANY, SEATTLE, WA:
2,411,319, CANC. INT. CL. 24.
- PACIFIC PEDIATRIC SUPPLY LLC, WINCHESTER, CA:
3,314,450, INT. CL. 10.
- PACIFIC SUNWEAR OF CALIFORNIA, ANAHEIM, CA:
2,411,057, CANC. INT. CL. 25.
- PACIFIC TOYS, INC., COMMERCE, CA:
3,312,591, PUB. 7-31-2007. INT. CL. 28.
- PACK 'N' STACK, INC., PHILADELPHIA, PA:
2,411,110, CANC. INT. CL. 16.
- PACKAGING POST, INC., BLUE BELL, PA:
3,312,325, PUB. 7-31-2007. INT. CL. 42.
- PACTIMO, LLC, GREENWOOD VILLAGE, CO:
3,311,310, PUB. 7-10-2007. INT. CL. 25.
- PADDOCK POOL CONSTRUCTION CO., SCOTTSDALE, AZ:
3,313,029, INT. CL. 20.
- PADRES L.P., SAN DIEGO, CA:
3,313,955, INT. CL. 41.
- PAGLIASSOTTI, DRUANN LYNN, THOUSAND OAKS, CA:
3,311,359, PUB. 7-31-2007. INT. CL. 41.
- PAI SERVICES, LLC, MORRESTOWN, NJ:
3,313,782, INT. CL. 35.
- PAIDPOST INC, CEDAR GROVE, NJ:
3,314,948, INT. CL. 35.
- PAIR NETWORKS, INC., PITTSBURGH, PA:
3,311,762, PUB. 7-31-2007. INT. CL. 42.
- PALMA POLONIO, MARIA AMPARO, 28109 ALCOBENDAS (MADRID), SPAIN:
3,313,032, INT. CL. 3.
- PALO CREATIVE, LLP, BOARDMAN, OH:
3,313,421, INT. CL. 41.
- PAMELA SIMON VINTAGE, INC., AMBLER, PA:
3,312,275, PUB. 7-31-2007. MULTIPLE CLASS, INT. CLS. 24 AND 35.
- PAN PACIFIC MEDIA INC., SAN FRANCISCO, CA:
3,314,036, MULTIPLE CLASS, INT. CLS. 35 AND 38.
- PAN-AMERICAN LIFE INSURANCE COMPANY, NEW ORLEANS, LA:
3,314,485, INT. CL. 36.
- PANACEA CREAM PRODUCTS, LLC, LAFAYETTE, LA:
3,313,201, INT. CL. 5.

- PANASONIC CORPORATION OF NORTH AMERICA, SECAUCUS, NJ:
3,313,017, INT. CL. 7.
3,313,760, INT. CL. 9.
3,314,497, INT. CL. 8.
- PANAVISION INTERNATIONAL, L.P., WOODLAND HILLS, CA:
3,312,671, PUB. 7-31-2007. INT. CL. 9.
3,313,384, INT. CL. 11.
- PANCHO BARNES ENTERPRISES, INCORPORATED, PASADENA, CA:
3,311,699, PUB. 7-31-2007. INT. CL. 25.
- PANDA CO., LTD., APIA, SAMOA:
3,314,534, INT. CL. 7.
- PANELS & CONTROLS CORP., GURNEE, IL:
3,310,375, PUB. 7-31-2007. INT. CL. 9.
- PANESCU, DUMITRU, SANTA CRUZ, CA:
2,107,467. REN. 9-10-07. INT. CL. 42.
- PANLINE U.S.A., INC., ENGLEWOOD, NJ:
2,409,714, CANC. INT. CL. 16.
- PANNELL KERR FORSTER OF TEXAS, P.C., HOUSTON, TX:
3,312,587, PUB. 7-31-2007. INT. CL. 35.
- PANNELL-FINDLEY, PAMELA D., WEST FARGO, ND:
3,313,426, INT. CL. 35.
- PANOCEAN SOUTHLAND INCORPORATED, SAVANNAH, GA:
1,419,473, CANC. INT. CL. 39.
- PANORAMA CITY, LACEY, WA:
3,311,941, PUB. 7-31-2007. INT. CL. 43.
- PANSCOPIC CORPORATION, SAN FRANCISCO, CA:
3,313,641, MULTIPLE CLASS, INT. CLS. 9, 41 AND 42.
- PANTHEON FLOOR SOLUTIONS, DALLAS, TX:
3,310,779, PUB. 7-31-2007. INT. CL. 19.
- PANTHERS HOCKEY LLLP, SUNRISE, FL, DBA SUNRISE SPORTS & ENTERTAINMENT:
3,313,869, MULTIPLE CLASS, INT. CLS. 35, 41 AND 43.
- PAPAZACHARIOU, ILIAS, ASTORIA, NY:
3,311,746, PUB. 7-31-2007. MULTIPLE CLASS, INT. CLS. 5 AND 29.
- PAPER-PAK INDUSTRIES, LA VERNE, CA:
1,450,747. REN. 9-12-07. INT. CL. 16.
- PAPERBACK GMBH & CO. KG, 65549 LIMBURG, FED REP GERMANY:
2,409,851, CANC. MULTIPLE CLASS, INT. CLS. 16, 37, 39, 40 AND 42.
- PAPERPAK PRODUCTS, INC., GREENVILLE, NC:
3,311,361, PUB. 7-31-2007. INT. CL. 5.
3,311,362, PUB. 7-31-2007. INT. CL. 5.
3,311,474, PUB. 7-31-2007. INT. CL. 5.
- PAPIERFABRIK AUGUST KOEHLER AG, FED REP GERMANY:
3,312,810, PUB. 7-31-2007. INT. CL. 16.
- PAQUETTE, MARTIN, LOS ANGELES, CA:
3,313,443, INT. CL. 25.
- PARADISE HERBS, INC., FOUNTAIN VALLEY, CA:
3,311,551, PUB. 7-31-2007. INT. CL. 5.
- PARALEGALS PLUS, INC., DALLAS, TX:
2,410,595, CANC. INT. CL. 35.
- PARAMOUNT PASTA CO., INC., WOODBURY, NY:
2,411,170, CANC. INT. CL. 30.
2,411,229, CANC. INT. CL. 30.
- PARAMOUNT PICTURES CORPORATION, LOS ANGELES, CA:
2,184,533. REN. 9-12-07. INT. CL. 9.
- PARENTAL VENTURES LLC, PORTLAND, OR:
3,310,934, PUB. 7-31-2007. MULTIPLE CLASS, INT. CLS. 38, 41 AND 42.
- PARENTING GROUP INC., THE, NEW YORK, NY, LEAM CORPORATION, NEW YORK, NY:
661,932. REN. 9-13-07. U.S. CL. 38 (INT. CL. 16).
- PARFUMS CARON, 75008 PARIS, FRANCE:
3,312,656, PUB. 7-31-2007. INT. CL. 3.
- PARFUMS CHRISTIAN DIOR, PARIS 75008, FRANCE:
3,311,321, PUB. 7-31-2007. INT. CL. 3.
- PARFUMS CHRISTIAN DIOR, PARIS, FRANCE:
3,311,620, PUB. 7-31-2007. INT. CL. 3.
- PARFUMS CHRISTIAN DIOR, S.A., 75008 PARIS, FRANCE:
2,410,113, CANC. INT. CL. 3.
- PARFUMS VAN CLEEF & ARPELS S.A., 92200 - NEUILLY SUR SEINE, FRANCE:
2,411,045, CANC. INT. CL. 3.
- PARIS ACCESSORIES, INC., NEW YORK, NY:
3,314,513, INT. CL. 25.
- PARIS GOURMET OF NEW YORK INC., CARLSTADT, NJ:
2,410,270, CANC. INT. CL. 16.
- PARK JAE WOO, SEOUL, REPUBLIC OF KOREA:
3,310,623, PUB. 7-31-2007. MULTIPLE CLASS, INT. CLS. 41 AND 44.
- PARK PLACE CORPORATION, GREENVILLE, SC:
3,310,366, PUB. 7-31-2007. INT. CL. 20.
3,310,367, PUB. 7-31-2007. INT. CL. 20.
- PARKER STATION, INC., LOS OLIVOS, CA, DBA FESS PARKER WINERY & VINEYARD:
2,095,307. REN. 9-10-07. INT. CL. 33.
2,117,829. REN. 9-11-07. MULTIPLE CLASS, INT. CLS. 25, 33, 35 AND 42.
- PARKER, RICHARD L., JR., WALLA WALLA, WA:
2,410,860, CANC. INT. CL. 28.
2,410,861, CANC. INT. CL. 28.
- PARKING COMPANY OF AMERICA, INC., CINCINNATI, OH:
1,486,489. REN. 9-10-07. INT. CL. 39.
- PARRAGON BOOKS LIMITED, BATH, UNITED KINGDOM:
3,312,991, INT. CL. 16.
- PARTY WAREHOUSE MANAGEMENT, L.L.C., CHERRY HILL, NJ:
2,410,571, CANC. INT. CL. 35.
- PAR3 COMMUNICATIONS, INC., SEATTLE, WA:
3,311,715, PUB. 7-31-2007. INT. CL. 38.
- PATEL, MONABEN, BELLEVUE, WA:
3,310,511, PUB. 7-31-2007. INT. CL. 42.
- PATHFINDER SERVICES, INC., HUNTINGTON, IN:
2,176,998. REN. 9-13-07. INT. CL. 28.
- PATHOLOGY BUSINESS SOLUTIONS, INC., HIGHLAND PARK, IL:
3,310,696, PUB. 7-31-2007. INT. CL. 35.
- PATIENT NEWS PUBLISHING LTD., HALIBURTON, ONTARIO, CANADA:
3,310,821, PUB. 7-31-2007. INT. CL. 16.
3,310,822, PUB. 7-31-2007. INT. CL. 16.
3,310,823, PUB. 7-31-2007. INT. CL. 16.
- PATRICK-WOUT, HEATHER D., BELTSVILLE, MD:
3,310,461, PUB. 7-31-2007. INT. CL. 42.
- PATRIOT HOMES, INC., ELKHART, IN:
3,313,495, INT. CL. 19.
- PATRIOT LIFT CO., LTD., KINGSHILL, US VIRGIN ISLANDS:
3,311,798, PUB. 7-31-2007. INT. CL. 7.
- PATSCHULL, GREGORY S., SAN PEDRO, CA:
3,314,511, INT. CL. 25.
- PAUL HARTMANN AKTIENGESELLSCHAFT, HEIDENHEIM, FED REP GERMANY:
1,473,840. REN. 9-11-07. MULTIPLE CLASS, INT. CLS. 5 AND 16.
- PAUL KIRCHOFF, AUSTIN, TX:
3,312,432, PUB. 7-31-2007. INT. CL. 35.
3,312,433, PUB. 7-31-2007. INT. CL. 35.
- PAUL SORVINO FOODS, INC., GREENVILLE, DE:
3,312,022, PUB. 7-31-2007. INT. CL. 29.
- PAULA PALM & ASSOCIATES, CHICAGO, IL:
2,410,418, CANC. INT. CL. 35.
- PAULSON, MEGAN C., VENTURA, CA:
3,314,544, INT. CL. 12.
- PAULSON, RICK, BISMARCK, ND:
3,313,042, INT. CL. 5.
- PAWELSKI, PAUL R., MATTESON, IL:
2,410,784, CANC. INT. CL. 28.
- PAYAN, JAVIER, EL CAJON, CA AND PAYAN, STEPHANIE, EL CAJON, CA:
3,312,425, PUB. 7-31-2007. INT. CL. 25.
- PAYMINE INC., JUPITER, FL:
3,311,021, PUB. 7-31-2007. INT. CL. 36.

- PAYROLLGURU, INC., SAN DIEGO, CA:
3,311,356, PUB. 7-31-2007. MULTIPLE CLASS, INT. CLS. 35 AND 42.
- PAYSETT CORPORATION, LOGANVILLE, GA:
3,311,504, PUB. 7-31-2007. INT. CL. 9.
- PCM TECHNOLOGIES, INC., CONCORD, CANADA:
3,311,799, PUB. 7-31-2007. INT. CL. 42.
- PDQ FOOD STORES, INC., MADISON, WI:
834,148. REN. 9-7-07. U.S. CL. 101 (INT. CL. 42).
- PEACEFUL PAWS PET CREMATION & MEMORIALS, INC., VANCOUVER, WA:
3,311,269, PUB. 7-31-2007. MULTIPLE CLASS, INT. CLS. 20 AND 45.
3,311,275, PUB. 7-31-2007. MULTIPLE CLASS, INT. CLS. 20 AND 45.
- PEACEWORKS FOUNDATION, NEW YORK, NY:
3,313,446, INT. CL. 41.
- PEAK DEVELOPMENT, LLC, SPEARFISH, SD:
3,314,312, INT. CL. 41.
- PEBBITONE, INC., ATLANTA, GA TO TITTY LESS CREW, LLC, LOS ANGELES, CA:
2,020,419, CANC. INT. CL. 9.
2,020,535, CANC. INT. CL. 16.
- PEDDERS SHOCK ABSORBER SERVICE PTY LTD, AUSTRALIA:
3,312,736, PUB. 7-31-2007. MULTIPLE CLASS, INT. CLS. 12 AND 37.
- PEEDEE PRODUCTIONS LIMITED, MARLOW, BUCKINGHAMSHIRE, ENGLAND:
3,311,707, PUB. 4-17-2007. INT. CL. 9.
- PEEK& CLOPPENBERG K.G., D-4000 DUSSELDORF ONE, FED REP GERMANY:
1,419,284, CANC. INT. CL. 25.
- PEGASUS AIR EXPRESS, INC., GLEN BURNIE, MD:
2,089,193. REN. 9-7-07. INT. CL. 39.
- PEGASUS LABORATORIES, INC., KANSAS CITY, MO:
3,314,781, INT. CL. 5.
- PEGGY KNIGHT SOLUTIONS, INC., SAUSALITO, CA:
3,313,436, INT. CL. 26.
- PEIRONE PRODUCE COMPANY, SPOKANE, WA:
1,453,656. REN. 9-9-07. INT. CL. 42.
- PENDERGRASS, TORRY, LOS ANGELES, CA:
3,312,698, PUB. 7-11-2006. INT. CL. 25.
- PENGUIN BRANDS, INC., SHARON HILL, PA:
3,312,108, PUB. 7-31-2007. MULTIPLE CLASS, INT. CLS. 9, 18, 21 AND 25.
- PENNINGTON SEED, INC., MADISON, GA:
3,311,807, PUB. 7-31-2007. INT. CL. 31.
- PENRECO, THE WOODLANDS, TX, PENNZOIL PRODUCTS COMPANY, HOUSTON, TX:
1,452,692. REN. 9-7-07. INT. CL. 1.
- PEOPLE INC., WILLAIMSVILLE, NY:
3,310,500, PUB. 7-31-2007. MULTIPLE CLASS, INT. CLS. 36, 41, 44 AND 45.
- PEOPLENET COMMUNICATIONS CORPORATION, CHASKA, MN:
3,312,589, PUB. 7-31-2007. INT. CL. 35.
- PEOPLES BANK, PARIS, TX:
3,313,677, INT. CL. 36.
- PEPCO SALES OF DALLAS, INC., IRVING, TX:
3,314,724, INT. CL. 11.
3,314,746, INT. CL. 11.
3,314,747, INT. CL. 11.
- PEPE JEANS LONDON, LLC, NEW YORK, NY:
3,311,325, PUB. 7-31-2007. INT. CL. 25.
- PEPPER NA INC., CHICAGO, IL:
3,313,531, INT. CL. 35.
- PEPPERS UNLIMITED OF LOUISIANA, INC., ST MARTINVILLE, LA:
3,311,163, PUB. 7-31-2007. INT. CL. 30.
- PEPPERS UNLIMITED OF LOUISIANA, INC., ST. MARTINVILLE, LA:
3,311,165, PUB. 7-31-2007. INT. CL. 30.
- PEPSICO, INC., PURCHASE, NY:
2,021,312, CANC. INT. CL. 32.
2,411,339, CANC. INT. CL. 32.
- PERAZA, DIANE, MUTTONTOWN, NY:
3,310,610, PUB. 7-31-2007. INT. CL. 44.
- PERCUSSIVE INNOVATIONS, LLC, PINION HILLS, CA:
3,311,352, PUB. 7-31-2007. INT. CL. 15.
- PERDUE HOLDINGS, INC., WILMINGTON, DE:
2,020,349, CANC. INT. CL. 29.
2,020,643, CANC. INT. CL. 16.
3,313,715, INT. CL. 29.
- PERFECT MORTGAGE LLC., RANDOLPH, MA:
3,311,288, PUB. 7-31-2007. INT. CL. 36.
- PERFECT SWING POWER TEE, INC., ORLANDO, FL:
2,411,029, CANC. INT. CL. 28.
- PERFORMANCE PET NUTRITION, LLC, DURANGO, CO, DBA A GUY & HIS DOG COMPANY:
2,101,484. REN. 9-13-07. INT. CL. 31.
- PERFUMER'S WORKSHOP INTERNATIONAL, LTD., THE, NEW YORK, NY:
2,410,339, CANC. INT. CL. 3.
- PERGO (EUROPE) AB, TRELLEBORG, SWEDEN:
3,314,134, INT. CL. 19.
3,314,136, INT. CL. 19.
3,314,446, INT. CL. 19.
3,314,449, INT. CL. 19.
- PERI, DAVID J., YERINGTON, NV:
3,314,306, INT. CL. 31.
- PERIMETER HEALTH, LLC, BRENTWOOD, TN:
3,311,915, PUB. 4-10-2007. INT. CL. 9.
- PERKINS, MATTHEW J., BOISE, ID:
3,314,721, INT. CL. 36.
- PERMA-PIPE, INC., NILES, IL:
3,313,022, INT. CL. 6.
3,313,701, INT. CL. 17.
- PERMACHARGE CORPORATION, RIO RANCHO, NM:
3,314,823, INT. CL. 16.
- PERONI NASTRO AZZURRO LIMITED, DOUGLAS, ISLE OF MAN IMP1 1 A, UNITED KINGDOM:
1,463,049. REN. 9-7-07. INT. CL. 32.
- PERPETUAL TECHNOLOGIES, LLC, BROOMFIELD, CO:
3,311,139, PUB. 7-31-2007. INT. CL. 9.
- PERRY STREET PRODUCTIONS, LLC, NEW YORK, NY:
3,310,692, PUB. 7-31-2007. INT. CL. 35.
- PERSHING INVESTMENTS LLC, NEWARK, DE:
3,313,855, INT. CL. 35.
- PERSONAL CAPTIONING SYSTEMS, INC., MORTON GROVE, IL:
3,310,313, PUB. 7-10-2007. INT. CL. 9.
- PERSONAL NEWTRITION, LLC, CINCINNATI, OH:
3,311,111, PUB. 7-31-2007. INT. CL. 44.
- PERSONIFY DESIGN INC., SEATTLE, WA:
3,311,046, PUB. 7-31-2007. MULTIPLE CLASS, INT. CLS. 9 AND 42.
3,311,047, PUB. 7-31-2007. INT. CL. 9.
3,311,048, PUB. 7-31-2007. INT. CL. 9.
- PERSYST DEVELOPMENT CORPORATION, INC., PRESCOTT, AZ:
3,311,084, PUB. 7-31-2007. INT. CL. 9.
3,311,085, PUB. 7-31-2007. INT. CL. 9.
- PET FOOD EXPRESS, LTD., SAN LEANDRO, CA:
3,312,054, PUB. 7-31-2007. INT. CL. 45.
- PET INCORPORATED, MINNEAPOLIS, MN:
3,314,335, INT. CL. 29.
- PETERMAN, CHRISTION J., NEW YORK, NY:
3,311,176, PUB. 7-31-2007. INT. CL. 25.
- PETERSON AMERICAN CORPORATION, SOUTHFIELD, MI:
3,311,904, PUB. 7-31-2007. INT. CL. 7.
- PETROSOFT, INC., HUNTINGTON VALLEY, PA:
3,312,623, PUB. 7-31-2007. INT. CL. 42.
- PETROVIC, PAULA E., SEDONA, AZ:
2,106,303. REN. 9-12-07. INT. CL. 42.
- PF BRANDS, INC., NEWARK, DE:
3,313,417, INT. CL. 30.
- PFISTER HYBRID CORN COMPANY, EL PASO, IL TO PFISTER HYBRID CORN COMPANY, EL PASO, IL:
2,020,586, CANC. INT. CL. 31.
- PFIZER INC, NEW YORK, NY:
3,314,570, INT. CL. 44.
- PFIZER INC., NEW YORK, NY:
3,314,281, INT. CL. 44.

PH BEAUTY LABS, INC., LOS ANGELES, CA:
3,312,341, PUB. 7-31-2007. INT. CL. 3.

PHAROS CONSULTING LTD., DUNROBIN, ONTARIO, K0A1T0, CANADA:
2,410,250, CANC. MULTIPLE CLASS, INT. CLS. 16 AND 35.

PHH VEHICLE MANAGEMENT SERVICES, LLC, SPARKS, MD:
3,312,555, PUB. 7-31-2007. INT. CL. 35.

PHIL LONG DEALERSHIPS INC., COLORADO SPRINGS, CO:
3,310,871, PUB. 7-31-2007. INT. CL. 35.

PHILADELPHIA CHURCH OF GOD, EDMOND, OK:
3,314,028, INT. CL. 41.

PHILADELPHIA EAGLES LLC, PHILADELPHIA, PA:
3,311,187, PUB. 7-31-2007. MULTIPLE CLASS, INT. CLS. 9, 14 AND 28.

PHILD CO., LTD., KYOTO CITY, KYOTO PREF., JAPAN:
3,313,790, MULTIPLE CLASS, INT. CLS. 18 AND 20.

PHILIP A. JAMIESON, TOPSFIELD, MA, DBA PREAMFROEDERS.COM:
2,411,445, CANC. INT. CL. 42.

PHILIPS ELECTRONICS NORTH AMERICA CORPORATION, NEW YORK, NJ:
1,454,082, REN. 9-13-07. INT. CL. 10.

PHILLIPS, BRIAN, SAN ANTONIO, TX, DBA AERO COSMETICS:
2,021,259, CANC. INT. CL. 3.

PHILLIPS, MARK O., EL CAJON, CA:
3,310,607, PUB. 7-31-2007. INT. CL. 42.

PHILLIPS, PAMELA, ASPEN, CO:
3,312,264, PUB. 7-31-2007. INT. CL. 45.
3,312,265, PUB. 7-31-2007. INT. CL. 16.

PHILMAC PTY LTD, NORTH PLYMPTON, AUSTRALIA:
3,313,720, INT. CL. 17.

PHILOSOPHY, INC., PHOENIX, AZ:
3,313,362, INT. CL. 3.
3,313,981, INT. CL. 3.

PHOENIX INTANGIBLES HOLDING COMPANY, GREENVILLE, DE:
3,314,693, INT. CL. 40.

PHONE DIRECTORIES COMPANY, LP, OREM, UT:
3,312,442, PUB. 7-31-2007. INT. CL. 35.

PHS INTERNATIONAL, PHOENIX, AZ:
3,311,299, PUB. 7-31-2007. MULTIPLE CLASS, INT. CLS. 18 AND 25.

PHYTOTRONICS, INC., EARTH CITY, MO:
3,310,268, PUB. 7-31-2007. INT. CL. 11.

PI KAPPA LAMBDA, COLUMBUS, OH:
2,159,038, REN. 9-13-07. INT. CL. 14.

PICA POLLOS VICTORINA CORP., BRONX, NY:
3,311,154, PUB. 7-31-2007. INT. CL. 43.

PICAFLORE LLC, PORTLAND, OR:
3,311,277, PUB. 7-31-2007. INT. CL. 25.

PICHU LLC, BEVERLY HILLS, CA:
3,314,245, INT. CL. 25.

PICK OF THE GLITTER, LLC, GRANTS PASS, OR:
3,312,499, PUB. 7-31-2007. INT. CL. 14.

PIECES OF EIGHT, LTD., SHERMAN OAKS, CA:
3,314,974, INT. CL. 41.

PIERCE, RONALD I, TROY, AL:
3,310,805, PUB. 7-31-2007. INT. CL. 28.

PIERSON, MARK R., DES MOINES, IA:
3,314,945, INT. CL. 16.

PIKE BREWING COMPANY, THE, TUKWILA, WA:
2,091,299, REN. 9-13-07. INT. CL. 32.

PILLAR INTERNATIONAL CO, TAIPEI, TAIWAN:
1,418,916, CANC. INT. CL. 5.

PILLOWS FOR POINTES, INC., COMMACK, NY:
3,311,873, PUB. 7-31-2007. INT. CL. 25.

PIMENTAL, TERRY W., RENO, NV:
3,313,496, INT. CL. 19.

PINAR SUT MAMULLERI SANAYII ANONIM SIRKETI, POST CODES 35210 PASAPORT-IZMAR, TURKEY:
2,411,094, CANC. INT. CL. 29.

PINNEY, CRAIG W., SOLANA BEACH, CA:
3,311,535, PUB. 7-31-2007. INT. CL. 38.

PIONEER INTERSTATE, INC., KNOXVILLE, TN, DBA TIGER CLAW:
3,313,626, INT. CL. 16.
3,313,627, INT. CL. 9.
3,313,628, INT. CL. 21.

PIONEER LABORATORIES, INC., MARQUETTE, MI:
3,314,600, INT. CL. 10.

PIONEER TELEPHONE COOPERATIVE, INC., KING-FISHER, OK:
2,176,703, REN. 9-9-07. MULTIPLE CLASS, INT. CLS. 16 AND 38.

PIPEDREAM PRODUCTS, INC., CHATSWORTH, CA:
3,313,037, MULTIPLE CLASS, INT. CLS. 3 AND 5.

PIPPIG, UTA, BOCA RATON, FL:
3,310,743, PUB. 7-31-2007. MULTIPLE CLASS, INT. CLS. 41, 44 AND 45.

PIRELLI TYRE S.P.A., MILAN, ITALY:
3,311,606, PUB. 7-31-2007. INT. CL. 12.

PIXTO-U, LLC, CEDAR FALLS, IA:
3,311,951, PUB. 7-31-2007. MULTIPLE CLASS, INT. CLS. 35 AND 40.
3,311,952, PUB. 7-31-2007. MULTIPLE CLASS, INT. CLS. 35 AND 40.
3,311,953, PUB. 7-31-2007. MULTIPLE CLASS, INT. CLS. 35 AND 40.

PIZZA HAUS, INC., JEFFERSON CITY, MO:
3,312,130, PUB. 7-31-2007. INT. CL. 43.

PJB HOLDING, 75009 PARIS, FRANCE:
3,311,721, PUB. 7-31-2007. MULTIPLE CLASS, INT. CLS. 3, 16, 18, 21, 24 AND 43.

PK MANUFACTURING, INC., PITTSBURG, KS:
2,410,060, CANC. INT. CL. 11.

PKF INTERNATIONAL LIMITED, LONDON, UNITED KINGDOM, PANNELL KERR FORSTER INTERNATIONAL ASSOCIATION B.V., 2625 RE DELFT, NETHERLANDS:
2,087,030, REN. 9-11-07. MULTIPLE CLASS, INT. CLS. 35 AND 36.
2,087,031, REN. 9-11-07. MULTIPLE CLASS, INT. CLS. 35 AND 36.
2,087,032, REN. 9-11-07. MULTIPLE CLASS, INT. CLS. 35 AND 36.

PLAN LIFE & WEALTH MANAGEMENT, INC., FRESNO, CA:
3,310,951, PUB. 7-31-2007. INT. CL. 36.

PLANCHERS DES APPALACHES LTÉE, COWANSVILLE, CANADA:
3,311,901, PUB. 7-31-2007. INT. CL. 2.

PLANET HOTTIEWOOD, COCONUT CREEK, FL:
3,314,731, INT. CL. 41.

PLANETOUTDOORS.COM, INC., NEW YORK, NY:
2,410,703, CANC. INT. CL. 35.

PLANET3 WIRELESS, INC., ATLANTA, GA:
3,313,993, INT. CL. 41.

PLANIT ADVERTISING, INC., BALTIMORE, MD, DBA BUOYANT DUCK:
3,312,383, PUB. 7-31-2007. MULTIPLE CLASS, INT. CLS. 35, 41 AND 42.

PLANK LLC, CHARLESTOWN, MA:
3,314,025, INT. CL. 3.
3,314,299, INT. CL. 3.

PLANMATIC, INC., CHARLESTOWN, ST. CHRIST-NEVIS:
3,312,428, PUB. 7-31-2007. INT. CL. 9.

PLANTES ET MEDECINES, CASTRES, FRANCE:
3,312,263, PUB. 7-31-2007. MULTIPLE CLASS, INT. CLS. 3 AND 5.

PLANTRONICS, INC., SANTA CRUZ, CA:
2,088,053, REN. 9-11-07. INT. CL. 9.

PLANTSCAPERS, LLC, WACO, TX:
3,312,414, PUB. 7-31-2007. MULTIPLE CLASS, INT. CLS. 16, 35, 42 AND 44.

PLAN4EVER.COM, LLC, LOS ANGELES, CA:
2,410,136, CANC. MULTIPLE CLASS, INT. CLS. 35 AND 42.

PLATINUM FUNDING GROUP LLC, NEW YORK, NY:
3,314,189, INT. CL. 36.

- PLATINUM TECHNOLOGY, INC., ISLANDIA, NY:
2,021,442, CANC. INT. CL. 9.
2,021,443, CANC. INT. CL. 9.
- PLATINUM TECHNOLOGY, INC., OAKBROOK TERRACE, IL:
2,021,468, CANC. INT. CL. 9.
- PLATT, SHERI, PASADENA, MD:
3,313,194, INT. CL. 21.
- PLAYBOY ENTERPRISES INTERNATIONAL, INC., CHICAGO, IL:
3,314,130, INT. CL. 38.
3,314,131, INT. CL. 41.
- PLAYER'S COMPANY INC., QUEBEC, CANADA:
3,311,188, PUB. 7-31-2007. INT. CL. 34.
- PLAYFIRST, INC., SAN FRANCISCO, CA:
3,310,558, PUB. 7-31-2007. INT. CL. 9.
- PLAYMATES TOYS INC., COSTA MESA, CA:
3,314,305, INT. CL. 28.
- PLAYTEX MARKETING CORP., NEW YORK, NY:
3,313,997, INT. CL. 3.
- PLAYTIME LLC, ENGLEWOOD, CO:
3,310,641, PUB. 7-31-2007. INT. CL. 42.
- PLISE COMPANIES, LLC, LAS VEGAS, NV:
3,314,719, INT. CL. 36.
3,314,720, INT. CL. 37.
- PLUS OFFICE SYSTEMS CORP., HICKSVILLE, NY:
2,020,777, CANC. INT. CL. 20.
- PLYMKRAFT, INC., NEWPORT NEWS, VA:
3,314,608, INT. CL. 22.
- PLYMOUTH POULTRY COMPANY, SEATTLE, WA:
2,180,736. REN. 9-7-07. INT. CL. 29.
- PND INC., ANCHORAGE, AK:
3,311,787, PUB. 7-31-2007. INT. CL. 6.
3,311,788, PUB. 7-31-2007. INT. CL. 6.
3,311,789, PUB. 7-31-2007. INT. CL. 6.
- PODCASTPEOPLE, INC., CHADDS FORD, PA:
3,311,467, PUB. 7-31-2007. INT. CL. 38.
- POGOREL, BARRY, LAGUNA HILLS, CA, DBA THE CROSSROADS GROUP, INC.:
2,410,118, CANC. INT. CL. 35.
- POINTE NOIR PTY LTD., PYRMONT, AUSTRALIA:
3,314,664, INT. CL. 25.
- POINTE PEST CONTROL, L.L.C., PROVO, UT:
3,314,069, INT. CL. 37.
- POLANER, INC., PARSIPPANY, NJ:
3,314,898, INT. CL. 29.
- POLAR COMMUNICATIONS, L.L.C., ROCKFORD, MI:
3,315,015, INT. CL. 16.
- POLARIS INDUSTRIES INC., MEDINA, MN:
3,313,360, INT. CL. 14.
3,314,876, INT. CL. 7.
- POLITICAL WORLD COMMUNICATIONS, LLC, PLAINSBORO, NJ:
3,313,308, INT. CL. 35.
- POLKA LOVERS KLUB OF AMERICA PO. L. K. OF A., EXCELSIOR, MN:
1,459,701. REN. 9-13-07. INT. CL. 42.
- POLO CLUB, FRANCE:
3,312,709, PUB. 7-31-2007. MULTIPLE CLASS, INT. CLS. 25, 28 AND 41.
- POLSGROVE, JEFFREY, MANCHESTER, MO:
3,314,192, INT. CL. 43.
- POLYCHEM DISPERSIONS, INC., MIDDLEFIELD, OH:
2,158,918. REN. 9-11-07. INT. CL. 1.
2,160,515. REN. 9-10-07. INT. CL. 1.
- POLYNICE, DOMINIKA S., OWINGS MILLS, MD:
3,311,134, PUB. 7-31-2007. INT. CL. 3.
- POLYONE CORPORATION, AVON LAKE, OH:
3,313,866, INT. CL. 1.
- POLYSAT, INC., PHILADELPHIA, PA:
3,312,353, PUB. 7-31-2007. INT. CL. 2.
- POOF-SLINKY, INC., PLYMOUTH, MI:
1,455,493. REN. 9-10-07. INT. CL. 28.
- POOL COVER CORP., HAUPPAUGE, NY:
3,313,719, INT. CL. 22.
- POOL DISTRIBUTION, LLC, ST. PAUL, MN:
3,310,580, PUB. 7-31-2007. INT. CL. 35.
- POPULUS GROUP, LLC, SOUTHFIELD, MI:
2,758,549, AM. INT. CL. 35.
- POR MATAMOR, NYACK, NY:
2,410,824, CANC. INT. CL. 34.
- PORGES S.A., PARIS, FRANCE:
1,419,071, CANC. INT. CL. 10.
- POROUS MEDIA CORPORATION, ST. PAUL, MN:
3,312,078, PUB. 7-31-2007. INT. CL. 11.
- POROUS MEDIA CORPORATION, CONROE, TX:
3,312,133, PUB. 7-31-2007. INT. CL. 11.
- PORT, INC., SOUTH NORWALK, CT:
2,410,907, CANC. INT. CL. 9.
- PORTABLE SOUND LABORATORIES, LLC, CHATSWORTH, CA:
3,281,989, CANC. IIRN. RESTORED TO S.N. 77-037,966.
- PORTALCAST, INC., IRVINE, CA:
3,313,770, MULTIPLE CLASS, INT. CLS. 35, 38 AND 41.
- PORTIK, DANIEL, WESTLAKE, OH:
2,410,395, CANC. INT. CL. 9.
- POST & M CO., INC., GLENDALE, CA:
2,410,825, CANC. INT. CL. 25.
- POST, CONNIE B., BARBOURSVILLE, WV:
2,410,337, CANC. INT. CL. 42.
- POTLATCH FOREST PRODUCTS CORPORATION, SPOKANE, WA:
3,313,295, INT. CL. 16.
- POWELL, RANDY, PRESCOTT, AZ AND POWELL, SUSAN, PRESCOTT, AZ:
2,411,223, CANC. INT. CL. 9.
- POWER & ENERGY, INC., IVYLAND, PA:
3,310,475, PUB. 7-31-2007. INT. CL. 11.
- POWER ELECTRONICS INTERNATIONAL, INC., CHICAGO, IL:
1,467,057. REN. 9-13-07. INT. CL. 9.
- POWER TECHNOLOGY INCORPORATED, FITCHBURG, MA:
2,411,281, CANC. INT. CL. 42.
- POWERHOUSE ENGINE COMPONENTS, INC., BAKERSFIELD, CA:
3,310,559, PUB. 7-31-2007. INT. CL. 35.
- POWERWORX ONLINE, INC., BOULDER, CO:
2,410,583, CANC. INT. CL. 38.
- PPG INDUSTRIES OHIO, INC., CLEVELAND, OH:
3,313,387, INT. CL. 1.
- PPG INDUSTRIES, INC., PITTSBURGH, PA:
1,419,194, CANC. INT. CL. 19.
- PRACTICEMATCH SERVICES, LLC, SAINT LOUIS, MO:
3,314,761, INT. CL. 42.
- PRAGER BRUSH CO., INC., ATLANTA, GA:
2,059,134. REN. 9-7-07. INT. CL. 16.
- PRAIRIE CARDIOVASCULAR CONSULTANTS, LTD., SPRINGFIELD, IL:
3,312,105, PUB. 7-31-2007. INT. CL. 44.
- PRAIRIE ENTERPRISES, INC., WILMETTE, IL:
2,088,678. REN. 9-10-07. MULTIPLE CLASS, INT. CLS. 30 AND 42.
- PRALIBEL N.V., BELGIUM:
3,223,195, COR. INT. CL. 30.
- PRASSAS, GEORGE N., TUCSON, AZ:
2,411,598, CANC. INT. CL. 6.
- PRE-ENGINEERING SOFTWARE CORPORATION, BATON ROUGE, LA:
2,411,204, CANC. INT. CL. 9.
- PRECIOUS MOMENTS, INCORPORATED, ROLLING MEADOWS, IL:
3,310,834, PUB. 7-31-2007. INT. CL. 9.
- PRECISION DYNAMICS CORPORATION, SAN FERNANDO, CA:
2,020,954, CANC. INT. CL. 20.
2,409,782, CANC. INT. CL. 20.
- PRECISION LABORATORIES, INC., WAUKEGAN, IL:
3,313,155, INT. CL. 1.
- PREMAS PREVENTIVE MAINTENANCE SERVICE AG, ZURICH, SWITZERLAND:
3,310,238, PUB. 6-14-2005. MULTIPLE CLASS, INT. CLS. 35, 36, 37, 39 AND 42.

PREMIER DENTAL PRODUCTS COMPANY, PLYMOUTH MEETING, PA:
3,312,154, PUB. 7-31-2007. INT. CL. 10.

PREMIER DESIGNS, INC., IRVING, TX:
3,313,038, INT. CL. 35.

PREMIER TRUST, INC., LAS VEGAS, NV:
3,310,263, PUB. 7-31-2007. INT. CL. 36.

PREMIERE INNOVATIONS, INC., SANTA MONICA, CA TO AMERILAB TECHNOLOGIES, INCORPORATED, PLYMOUTH, MN:
2,021,058, CANC. INT. CL. 32.

PREMIERE RADIO NETWORKS, INC., SAN ANTONIO, TX:
3,310,625, PUB. 7-31-2007. INT. CL. 38.

PRESBYTERIAN CONFERENCE ASSOCIATION, INC., HOLMES, NY:
3,314,959, INT. CL. 41.

PRESCOTT VALLEY HOCKEY CLUB, LLC, PRESCOTT VALLEY, AZ:
3,314,116, INT. CL. 25.
3,314,117, INT. CL. 25.

PRESENCE FROM INNOVATION, LLC, ST. LOUIS, MO:
2,410,069, CANC. INT. CL. 20.

PRESENTATION STRATEGIES, INC., DURHAM, NC:
3,313,087, INT. CL. 42.

PRESS-SENSE LTD., OR AKIVA, ISRAEL:
3,314,203, MULTIPLE CLASS, INT. CLS. 9 AND 42.

PRESTON CAPITAL MANAGEMENT LLC, LUTHERVILLE, MD:
3,314,111, INT. CL. 36.
3,314,112, INT. CL. 36.

PRET-A-HABITER LLC, NEW YORK, NY:
3,310,866, PUB. 7-31-2007. INT. CL. 42.

PREVERCO INC., BEAUPORT, QUEBEC G1C 1A2, CANADA:
2,411,377, CANC. INT. CL. 19.

PRICE PIRATES, HUNTINGTON BEACH, CA:
2,410,048, CANC. INT. CL. 35.

PRICE, DEIRDRA, SAN DIEGO, CA:
2,098,944, REN. 9-8-07. INT. CL. 41.

PRIDE ENGINEERING, INC., MINNEAPOLIS, MN:
3,314,585, INT. CL. 7.

PRIMARY IP LLC, BALTIMORE, MD:
3,310,307, PUB. 7-10-2007. INT. CL. 37.

PRIMARY PHYSICIANS CARE, INC., CHARLOTTE, NC:
3,312,577, PUB. 7-31-2007. INT. CL. 41.

PRIME ENERGY RENTAL LLC, LA PORTE, TX:
2,409,923, CANC. MULTIPLE CLASS, INT. CLS. 35 AND 37.

PRIME FOOD PROCESSING CORP., BROOKLYN, NY:
2,154,674, REN. 9-13-07. INT. CL. 30.

PRIME TIME PRODUCTIONS HOLDINGS PTY LTD, AUSTRALIA:
3,312,874, PUB. 7-31-2007. MULTIPLE CLASS, INT. CLS. 9, 16, 28 AND 41.

PRIME WEST JORDANELLE, LLC, OREM, UT:
3,314,705, INT. CL. 37.

PRIMEDIA MAGAZINE FINANCE INC, NEW YORK, NY:
2,411,526, CANC. INT. CL. 16.

PRIMOZONE PRODUCTION AB, SWEDEN:
3,312,905, PUB. 7-31-2007. MULTIPLE CLASS, INT. CLS. 9, 11 AND 40.

PRINCIPESSA BEAUTY INC., VANCOUVER, CANADA:
3,311,374, PUB. 7-31-2007. INT. CL. 25.

PRINTCOM, INC., SEATTLE, WA:
3,310,325, PUB. 7-10-2007. INT. CL. 40.

PRIVATE ISLE PRODUCTS, INC., AUSTIN, TX:
2,410,610, CANC. INT. CL. 28.

PRIZEFLIGHT L.L.C., PHOENIX, AZ:
3,312,047, PUB. 7-31-2007. INT. CL. 42.

PRO-HEALTH, LLC, WRAY, CO:
3,311,013, PUB. 7-31-2007. INT. CL. 31.

PRO-PAK INDUSTRIES, INC., WEST CHICAGO, IL:
3,312,005, PUB. 7-31-2007. INT. CL. 17.

PROCAPS L.P., VILLE ST. LAURENT, QUEBEC, CANADA:
3,312,250, PUB. 7-31-2007. INT. CL. 28.
3,312,251, PUB. 7-31-2007. INT. CL. 28.
3,312,252, PUB. 7-31-2007. INT. CL. 28.

PROCTER & GAMBLE COMPANY, THE, CINCINNATI, OH:
1,418,883, CANC. INT. CL. 3.
2,411,131, CANC. INT. CL. 3.
2,411,320, CANC. INT. CL. 3.

PROF. DR. HABIL THOMAS GEISHAUSER, WITTIBREUT, FED REP GERMANY:
3,312,132, PUB. 7-31-2007. INT. CL. 5.

PROFESSIONAL BOWLERS ASSOCIATION LLC, SEATTLE, WA:
3,314,078, MULTIPLE CLASS, INT. CLS. 25, 35 AND 41.

PROFESSIONAL CLINICAL LABORATORY, INC., FORT WORTH, TX:
3,313,210, INT. CL. 44.

PROFESSIONAL RODEO COWBOYS ASSOCIATION, INC., COLORADO SPRINGS, CO:
2,091,143, REN. 9-7-07. INT. CL. 25.
2,094,035, REN. 9-7-07. INT. CL. 25.

PROFESSIONAL SPECIALTY WATCH COMPANY, INC., SMITHTOWN, NY:
1,419,135, CANC. INT. CL. 14.

PROFITKEY INTERNATIONAL, INC., SALEM, NH:
1,418,979, CANC. INT. CL. 9.

PROFORCE TECHNOLOGIES, INC., OKLAHOMA CITY, OK:
2,410,047, CANC. INT. CL. 35.

PROGRESSIVE DYNAMICS, INC., MARSHALL, MI:
3,311,770, PUB. 7-31-2007. INT. CL. 9.

PROGRESSIVE GROUP ALLIANCE, LLC, RICHMOND, VA:
1,078,504, REN. 9-13-07. INT. CL. 29.
1,078,504, CANC. MULTIPLE CLASS, INT. CLS. 30 AND 32.
3,314,792, INT. CL. 29.

PROGRESSIVE GROWTH CORP., GAYLORD, MN:
3,311,018, PUB. 7-31-2007. INT. CL. 36.

PROGRESSIVE LIGHTING SYSTEMS, INC., SANTA ANA, CA:
3,310,962, PUB. 7-31-2007. INT. CL. 9.

PROJECT KID SMART, WASHINGTON, DC:
3,310,583, PUB. 7-31-2007. INT. CL. 9.
3,310,589, PUB. 7-31-2007. INT. CL. 9.

PROJECT MANAGEMENT INSTITUTE, INC., NEWTOWN SQUARE, PA:
2,152,599, REN. 9-10-07. MULTIPLE CLASS, INT. CLS. 16 AND 42.

PROJETCLUB, VILLENEUVE D'ASCQ, FRANCE:
3,312,307, PUB. 7-31-2007. INT. CL. 28.

PROLIFARON LLC, SAN DIEGO, CA:
2,410,340, CANC. INT. CL. 42.

PROMAX INTERNATIONAL HOLDINGS LIMITED, ROAD TOWN, TORTOLA, BR. VIRGIN ISLANDS:
3,312,212, PUB. 7-31-2007. MULTIPLE CLASS, INT. CLS. 3, 9, 14, 18, 25 AND 35.

PROMENS USA, INC., SOUTH BEND, IN:
3,312,344, PUB. 7-31-2007. MULTIPLE CLASS, INT. CLS. 20 AND 40.

PROMET MARINE SERVICE CORPORATION, PROVIDENCE, RI:
3,310,913, PUB. 7-31-2007. INT. CL. 37.

PROMONTORY INTERFINANCIAL NETWORK, LLC, ARLINGTON, VA:
3,314,470, INT. CL. 36.

PROMOTIF MEDIA, INC., BOULDER, CO:
2,410,039, CANC. INT. CL. 35.

PROMOTION DECISIONS, INC.:
1,419,426, CANC. INT. CL. 35.

PROPERTY PROFESSIONALS, INC., BOCA RATON, FL:
3,313,162, INT. CL. 36.

PROPEX INC., CHATTANOOGA, TN:
3,312,553, PUB. 7-31-2007. MULTIPLE CLASS, INT. CLS. 17, 19, 22, 24 AND 28.

PROPOCO, INC., PLYMOUTH MEETING, PA:
3,310,668, PUB. 7-10-2007. INT. CL. 43.

PROPPER INTERNATIONAL SALES, INC., ST. CHARLES, MO:
3,311,137, PUB. 7-31-2007. INT. CL. 25.

PROPPER MANUFACTURING CO., INC., LONG ISLAND CITY, NY:
1,054,243, REN. 9-12-07. INT. CL. 9.

- PRORESPONSE, INC., SCOTTSDALE, AZ:
2,410,223, CANC. INT. CL. 9.
- PRORODEO FILMS, INC., NEW YORK, NY:
3,314,548, INT. CL. 9.
- PROST, ALAIN, 1137 YENS, SWITZERLAND:
2,410,041, CANC. MULTIPLE CLASS, INT. CLS. 5, 9 AND 25.
- PROSTRONG, INC., OAKVILLE, CT:
3,310,911, PUB. 7-31-2007. INT. CL. 3.
- PROTECTIVE LIFE CORPORATION, BIRMINGHAM, AL:
2,411,414, CANC. INT. CL. 36.
- PROTECTIVE LIFE INSURANCE COMPANY, BIRMINGHAM, AL:
3,313,300, INT. CL. 36.
- PROTRADES CONNECTION, SAN JOSE, CA:
3,313,070, INT. CL. 35.
- PROVEST, INC., TAMPA, FL:
3,310,341, PUB. 7-31-2007. MULTIPLE CLASS, INT. CLS. 35, 39, 41, 42 AND 45.
- PROVIDENCE PRESBYTERIAN CHURCH (PCA), DALLAS, TX:
3,312,475, PUB. 7-31-2007. INT. CL. 45.
- PROVO CRAFT AND NOVELTY, INC., SPANISH FORK, UT:
3,313,548, INT. CL. 8.
3,313,549, INT. CL. 8.
- PROXURE, INC., SAN LUIS OBISPO, CA:
3,311,099, PUB. 7-31-2007. INT. CL. 9.
- PRZEDSIĘBIORSTWO PRZEMYSŁU SPIRYTUSOWEGO "POLMOS" W WARSZAWIE SPOLKA AKCYJNA, WARSAW, POLAND:
3,311,795, PUB. 7-31-2007. INT. CL. 33.
- PSI CORPORATION LIMITED, KOWLOON, HONG KONG:
3,314,764, INT. CL. 14.
3,314,765, INT. CL. 18.
- PT DJARUM, KUDUS 59317, INDONESIA:
3,313,093, INT. CL. 34.
- PT. OKUSI JAYA, JAKARTA PUSAT, INDONESIA:
3,312,221, PUB. 7-31-2007. INT. CL. 38.
- PUBLIC BROADCASTING SERVICE, ARLINGTON, VA:
2,091,506, REN. 9-7-07. INT. CL. 35.
- PUBLIC SERVICE COMPANY OF NEW MEXICO, ALBUQUERQUE, NM:
2,093,386, REN. 9-13-07. INT. CL. 35.
- PUP-PUP DESIGNS, LLC, SANTA CLARA, CA:
3,310,965, PUB. 7-31-2007. INT. CL. 18.
- PURE & SIMPLE CONCEPTS INC., MONTREAL (ST-LAURENT), CANADA:
3,311,189, PUB. 7-31-2007. INT. CL. 25.
- PURE FISHING, INC., SPIRIT LAKE, IA:
3,313,814, INT. CL. 28.
3,314,233, INT. CL. 28.
3,314,406, INT. CL. 28.
- PURE HEALTH SOLUTIONS, INC., SANDPOINT, ID:
3,313,152, INT. CL. 11.
- PUREDATA, LLC, VICKSBURG, MI:
3,311,693, PUB. 7-31-2007. INT. CL. 42.
- PURESPECTRUM TECHNOLOGIES, INC., DENVER, CO:
3,310,343, PUB. 7-31-2007. INT. CL. 11.
- PURITAN MEDICAL PRODUCTS COMPANY LLC, GUILFORD, ME:
1,464,402, REN. 9-13-07. INT. CL. 9.
- PURITY ITALIA S.R.L., NOVI LIGURE, PROVINCE OF ALESSANDRIA, ITALY:
2,411,472, CANC. MULTIPLE CLASS, INT. CLS. 21 AND 32.
- PURONYX, INC., SAN DIEGO, CA:
3,313,810, INT. CL. 3.
- PWG HOLDINGS, LLC, LAKE MARY, FL:
3,312,010, PUB. 7-31-2007. INT. CL. 35.
- PYLON MANUFACTURING CORPORATION, DEERFIELD BEACH, FL:
3,314,411, INT. CL. 12.
- PYRAMID PUBLISHING AND PRODUCTIONS, INC., CHICAGO, IL:
3,314,872, INT. CL. 3.
- PYRO ENGINEERING, INC., HUNTINGTON STATION, NY:
3,310,768, PUB. 7-31-2007. INT. CL. 41.
- QSA LIMITED, AL1 3DW, ENGLAND:
2,409,867, CANC. INT. CL. 9.
- QSI CORPORATION, SALT LAKE CITY, UT:
3,313,887, INT. CL. 9.
- QUADRANT EPP AG, LENZBURG, SWITZERLAND:
2,088,048, REN. 9-7-07. INT. CL. 17.
- QUALEX FINANCIAL CORPORATION, WILMINGTON, DE:
1,419,484, CANC. INT. CL. 40.
- QUALIGENCE, INC., LIVONIA, MI:
3,311,453, PUB. 7-31-2007. INT. CL. 35.
- QUALITY ASSURE SERVICES, INC., ORLANDO, FL:
3,314,331, INT. CL. 42.
- QUALITY COSMETICS CORP., SOUTH PLAINFIELD, NJ:
3,313,555, INT. CL. 3.
- QUALITY LOGO PRODUCTS, INC., OSWEGO, IL:
3,311,183, PUB. 7-31-2007. INT. CL. 35.
- QUALITY STORES SERVICES, INC., MUSKEGON, MI:
2,410,800, CANC. INT. CL. 35.
- QUANDEL GROUP, INC., THE, HARRISBURG, PA:
2,410,832, CANC. INT. CL. 37.
- QUANTEL LIMITED, NEWBURY, BERKSHIRE, ENGLAND:
2,409,998, CANC. INT. CL. 9.
- QUANTUM JEWELRY DISTRIBUTORS, INC., KENT, OH:
3,314,170, INT. CL. 14.
3,314,190, INT. CL. 14.
- QUANTUM3D, SAN JOSE, CA:
3,314,853, INT. CL. 9.
- QUANTZ MACHINE SALES, INC., COLUMBIA, SC:
2,093,037, REN. 9-13-07. INT. CL. 30.
- QUARK, INC., DENVER, CO:
3,314,251, INT. CL. 9.
- QUELLAN INCORPORATED, SANTA CLARA, CA:
3,312,585, PUB. 7-31-2007. MULTIPLE CLASS, INT. CLS. 9 AND 42.
- QUEPASA CORPORATION, SCOTTSDALE, AZ:
3,311,215, PUB. 7-31-2007. INT. CL. 41.
3,312,660, PUB. 7-31-2007. MULTIPLE CLASS, INT. CLS. 38, 41 AND 42.
- QUESTAR ASSESSMENT, INC., BREWSTER, NY:
3,311,024, PUB. 7-10-2007. INT. CL. 16.
- QUICKIE MANUFACTURING CORPORATION, CINNAMINSON, NJ:
3,313,504, INT. CL. 21.
- QUINTANILLA, ELIZABETH J., WOODBRIDGE, VA:
3,314,239, INT. CL. 25.
- QUINTILES TRANSNATIONAL CORP., DURHAM, NC:
3,313,517, MULTIPLE CLASS, INT. CLS. 41 AND 44.
- QVC, INC., WEST CHESTER, PA:
2,095,048, REN. 9-7-07. INT. CL. 35.
- QWEST COMMUNICATIONS INTERNATIONAL INC., DENVER, CO:
2,411,157, CANC. INT. CL. 38.
3,314,273, INT. CL. 35.
- R & S CONSULTANTS, SPRINGFIELD, NJ:
2,410,951, CANC. INT. CL. 25.
- R. E. TRICKER HOLDINGS LIMITED, NORTHAMPTON, UNITED KINGDOM:
3,313,793, INT. CL. 25.
- R. SEELIG & HILLE OHG, DUESSELDORF, FED REP GERMANY:
3,312,561, PUB. 7-31-2007. INT. CL. 30.
- R.A.P. SECURITY, INC., CUDAHY, CA:
3,313,106, INT. CL. 6.
- R.G. RINCOE & ASSOCIATES, INC., GOLDEN, CO:
2,410,738, CANC. INT. CL. 10.
- R&R POOL & PATIO, INC., STAMFORD, CT:
2,411,515, CANC. INT. CL. 35.
- RABA INC., CHICAGO, IL:
3,312,456, PUB. 7-31-2007. INT. CL. 43.
- RABB, ELAINE, STOCKTON, CA:
3,311,129, PUB. 7-31-2007. INT. CL. 30.
- RACE-TRAX, LLC, CARTERSVILLE, GA:
2,020,918, CANC. INT. CL. 9.
- RACER-MATE, INC., SEATTLE, WA:
2,123,114, REN. 9-9-07. INT. CL. 28.

- RADER, GEORGE, CANTON, OH:
3,313,805, MULTIPLE CLASS, INT. CLS. 29 AND 30.
- RADIANS INNOVA AB, 400 20 GOTEBORG, SWEDEN:
2,410,121, CANC. INT. CL. 9.
- RADIATOR EXPRESS WAREHOUSE, INC., BENICIA, CA:
3,310,529, PUB. 7-31-2007. INT. CL. 35.
- RADIO CALL COMPANY, INC., MELVILLE, NY:
1,419,418, CANC. MULTIPLE CLASS, INT. CLS. 35 AND 38.
- RADIO LOTTERY, INC., AURORA, CO:
3,313,660, INT. CL. 41.
- RADIO SYSTEMES INGENIERIE; (SOCIÉTÉ ANONYME), FRANCE:
3,312,799, PUB. 7-31-2007. MULTIPLE CLASS, INT. CLS. 9, 37, 38, 42 AND 45.
- RADIOSTORM INC., CLEVELAND, OH:
2,409,786, CANC. INT. CL. 9.
- RADIUS ADVERTISING, HAYWARD, CA:
3,312,609, PUB. 7-31-2007. INT. CL. 35.
- RADLYN LLC, CINCINNATI, OH:
3,314,360, INT. CL. 10.
- RADTECH, LLC, EARTH CITY, MO:
3,312,085, PUB. 7-31-2007. INT. CL. 9.
- RAE SYSTEMS INC., SAN JOSE, CA:
3,310,702, PUB. 7-31-2007. INT. CL. 9.
3,310,784, PUB. 7-31-2007. INT. CL. 9.
- RAHMANI HOLDINGS PTY. LTD., DANDENONG, VICTORIA 3175, AUSTRALIA:
3,310,477, PUB. 7-31-2007. INT. CL. 12.
- RAIMONDO, NANCY, MIAMI, FL:
3,310,996, PUB. 7-31-2007. INT. CL. 21.
- RAINBOW MEDIA HOLDINGS LLC, JERICHO, NY, RAINBOW PROGRAM ENTERPRISES, WOODBURY, NY:
2,088,172, REN. 9-12-07. INT. CL. 41.
- RAINFOREST NUTRITIONALS, INC, RALEIGH, NC:
3,313,890, INT. CL. 5.
- RAISIO YHTYMA OYJ, 21200 RAISIO, FINLAND:
2,410,000, CANC. INT. CL. 29.
- RALCO NUTRITION, INC., MARSHALL, MN:
3,310,468, PUB. 6-26-2007. INT. CL. 5.
- RALPH MALTBY ENTERPRISES, INC., NEWARK, OH:
2,411,185, CANC. INT. CL. 28.
- RAM FASHION ACCESSORIES, INC., BRISBANE, CA:
3,311,586, PUB. 7-31-2007. INT. CL. 18.
- RAMKING, INC., CLAREMONT, NH:
3,310,820, PUB. 7-31-2007. MULTIPLE CLASS, INT. CLS. 39 AND 43.
- RAMOS FINANCIAL, STREAMWOOD, IL:
3,315,010, INT. CL. 36.
- RAMVAC DENTAL PRODUCTS, INC., SPEARFISH, SD:
3,310,564, PUB. 7-31-2007. INT. CL. 10.
- RAN INSTITUTE, INC., THE, LAND O'LAKES, MO:
2,090,933, REN. 9-13-07. INT. CL. 16.
- RANCHO DOS PALMAS, BRAWLEY, CA, DBA TWIN PALMS RANCH:
1,419,391, CANC. INT. CL. 31.
- RANCO CONTROLS ASIA PACIFIC INC., PLAIN CITY, OH:
2,021,251, CANC. INT. CL. 11.
- RANDOLPH, ROBERT RICHARD JR., OXNARD, CA:
3,314,381, INT. CL. 36.
- RANDOM HOUSE, INC., NEW YORK, NY:
3,314,578, INT. CL. 16.
- RANGE KLEEN MFG., INC., LIMA, OH:
3,314,863, INT. CL. 21.
- RANGE ONLINE MEDIA, INC., FORT WORTH, TX:
3,310,355, PUB. 7-31-2007. MULTIPLE CLASS, INT. CLS. 35 AND 42.
- RASMUSSEN, TIMOTHY W., MAPLE GROVE, MN:
2,410,117, CANC. MULTIPLE CLASS, INT. CLS. 35 AND 42.
- RATHBUN ASSOCIATES, INC., MOUNTAIN VIEW, CA:
2,409,887, CANC. INT. CL. 9.
- RATHBUN, RONALD W., OCEANSIDE, CA:
3,310,385, PUB. 7-31-2007. INT. CL. 41.
- RATIONAL TECHNOLOGY OF IDAHO, LLC, EAGLE, ID:
3,312,035, PUB. 7-31-2007. MULTIPLE CLASS, INT. CLS. 9 AND 35.
- RAVANDI, DAVID, LOS ANGELES, CA AND HERMOSILLO, JOSE, LOS ANGELES, CA:
3,311,691, PUB. 7-31-2007. INT. CL. 33.
- RAVE, LLC, DELRAY BEACH, FL:
3,311,766, PUB. 7-31-2007. MULTIPLE CLASS, INT. CLS. 9 AND 37.
- RAVENSUN, INC., CLEAR WATER, FL:
2,131,160, REN. 9-9-07. INT. CL. 9.
- RAVENWOLFE, OVERLAND, MO:
3,313,826, INT. CL. 30.
- RAVINDRA JHAVERI, HOLMDEL, NJ:
3,310,793, PUB. 7-10-2007. INT. CL. 3.
- RAY CATENA MOTOR CAR CORPORATION, EDISON, NJ:
3,310,684, PUB. 7-31-2007. MULTIPLE CLASS, INT. CLS. 16, 18, 25, 35 AND 37.
- RAY L. TRAVERS, CARMEL VALLEY, CA:
3,311,820, PUB. 7-31-2007. INT. CL. 31.
- RAY QUINNEY & NEBEKER, P.C., SALT LAKE CITY, UT:
3,312,351, PUB. 7-31-2007. INT. CL. 42.
- RAYMOND FRANCIS FRIESECKE, SAN RAFAEL, CA:
3,311,389, PUB. 7-31-2007. INT. CL. 5.
- RAYNOR MFG. CO., DIXON, IL:
2,854,261, COR. INT. CL. 6.
- RAYNOR MFG. CO., DIXON, IL:
2,635,635, COR. INT. CL. 6.
2,820,183, COR. INT. CL. 6.
2,882,937, COR. MULTIPLE CLASS, INT. CLS. 6, 9, 16 AND 41.
- RAYNOR MFG. CO., DIXON, IL:
1,206,936, COR. INT. CL. 6.
2,036,749, COR. INT. CL. 6.
- RAYTRON ENTERPRISES, INC. OF FLORIDA, ST. PETERSBURG, FL, DBA FANTASTIC SAMS:
2,393,658, COR. INT. CL. 42.
- RAZOR & TIE DIRECT, L.L.C., NEW YORK, NY:
3,314,826, MULTIPLE CLASS, INT. CLS. 35 AND 41.
- RAZORGATOR INTERACTIVE GROUP, INC., BEVERLY HILLS, CA:
3,313,709, MULTIPLE CLASS, INT. CLS. 35, 39 AND 43.
- REACHUSA SALES GROUP, LLC, CINCINNATI, OH:
2,410,138, CANC. INT. CL. 35.
- READYCHEM INC., SANFORD, FL:
3,312,164, PUB. 7-31-2007. INT. CL. 3.
- REAL TABACALERA SANCHEZ-ROMAY, S.A., SANTIAGO, DOMINICAN REP:
3,314,873, INT. CL. 34.
- REALFUL, LLC., FLOWER MOUND, TX:
3,311,075, PUB. 7-31-2007. INT. CL. 45.
- REALITY ENGINEERING, INC., VANCOUVER, WA:
3,311,972, PUB. 7-31-2007. INT. CL. 9.
- REALLINX, INC., AUSTIN, TX:
3,311,162, PUB. 7-31-2007. INT. CL. 38.
- REALM HOLDINGS, LLC, MASON, OH:
3,312,306, PUB. 7-31-2007. INT. CL. 12.
- REBA MCENTIRE, A U.S. CITIZEN, A TRUSTEE OF THE SMITH TRUST, NASHVILLE, TN:
2,090,414, REN. 9-7-07. INT. CL. 16.
- REBEL WINE CO. LLC, ST. HELENA, CA:
3,311,926, PUB. 4-10-2007. INT. CL. 33.
- REBEL YELL, LLC, LOS ANGELES, CA:
3,313,731, INT. CL. 25.
- REBERLAND EQUIPMENT, INC., APPLE CREEK, OH:
3,314,187, INT. CL. 40.
- REBORN PRODUCTS CO., INC., BENSLEM, PA, DBA THE AMERICAN BELT COMPANY:
1,419,290, CANC. INT. CL. 25.
- RECEPTORS LLC, CHASKA, MN:
3,314,970, MULTIPLE CLASS, INT. CLS. 1, 5, 9, 10 AND 42.
- RECHARGEABLE BATTERY RECYCLING CORPORATION, ATLANTA, GA:
2,063,043, REN. 9-7-07. INT. CL. 40.
- RECKITT BENCKISER INC., PARSIPPANY, NJ:
3,312,645, PUB. 7-31-2007. INT. CL. 3.
3,313,754, INT. CL. 25.
- RECONNECTING THE CIRCLE, INC., RESTON, VA:
3,310,554, PUB. 7-31-2007. INT. CL. 41.

- RECREATION DESIGNS, INC., RICHFIELD, MN:
2,411,183, CANC. INT. CL. 40.
- RED CASTLE FRANCE, FRANCE:
3,312,970, PUB. 7-31-2007. INT. CL. 12.
- RED CHIP COMPANY LTD., WICKHAMS CAY, BR. VIRGIN ISLANDS:
3,311,652, PUB. 7-31-2007. MULTIPLE CLASS, INT. CLS. 9 AND 15.
- RED HAT SOCIETY, INC., FULLERTON, CA:
3,313,659, INT. CL. 35.
- RED HAT, INC., RALEIGH, NC, RED HAT SOFTWARE, INC., DURHAM, NC:
2,142,662, REN. 9-11-07. MULTIPLE CLASS, INT. CLS. 9 AND 42.
- RED LANTERN CORP., OREM, UT:
2,410,710, CANC. INT. CL. 42.
- RED OXX MFG INCORPORATED, BILLINGS, MT:
3,314,087, INT. CL. 18.
- RED RESTAURANT VENTURES, LLC, ATLANTA, GA:
3,310,274, PUB. 7-31-2007. INT. CL. 43.
- RED SPIDER LIMITED, GLASGOW G14 9NF, SCOTLAND:
2,409,811, CANC. MULTIPLE CLASS, INT. CLS. 9, 35 AND 41.
- RED THREADS INC., THE, NEW YORK, NY:
3,311,837, PUB. 7-31-2007. INT. CL. 24.
- REDCATS USA, L.P., INDIANAPOLIS, IN:
3,314,338, INT. CL. 25.
- REDIFFUSION SIMULATION INCORPORATED, ARLINGTON, TX:
1,419,041, CANC. INT. CL. 9.
- REDINGTON COUNTERS, INC., WINDSOR, CT:
3,311,367, PUB. 7-31-2007. INT. CL. 12.
- REDLAND MAGNESIA LIMITED, HARTLEPOOL, CLEVELAND TS24 OBY, UNITED KINGDOM:
2,020,101, CANC. INT. CL. 1.
- REDSOUT, INC., NEW YORK, NY:
3,311,579, PUB. 7-31-2007. INT. CL. 35.
- REEBOK INTERNATIONAL LTD., SToughton, MA:
2,410,276, CANC. INT. CL. 25.
- REED ELSEVIER INC., NEWTON, MA:
2,183,152, REN. 9-13-07. INT. CL. 16.
- REED ELSEVIER PROPERTIES INC., WILMINGTON, DE:
2,136,038, REN. 9-11-07. INT. CL. 16.
2,410,804, CANC. MULTIPLE CLASS, INT. CLS. 16 AND 42.
2,411,348, CANC. INT. CL. 16.
2,411,549, CANC. INT. CL. 16.
2,411,576, CANC. INT. CL. 16.
2,411,587, CANC. INT. CL. 42.
- REEL-NEAT SYSTEMS, INC., OKLAHOMA CITY, OK:
2,096,089, REN. 9-13-07. INT. CL. 9.
- REFLEX PHOTONICS, INC., MONTREAL QUEBEC, CANADA:
3,313,524, INT. CL. 9.
- REGAL HERITAGE HOMES, INC., BOISE, ID:
3,311,044, PUB. 7-31-2007. INT. CL. 37.
- REGAL NAILS, L.L.C., BATON ROUGE, LA:
3,311,350, PUB. 7-31-2007. INT. CL. 44.
- REGALADO, MANUAL, SOUTH GATE, CA, DBA EL COWBOY:
3,310,288, PUB. 7-31-2007. INT. CL. 16.
- REGENCY PLUS, INC., MT. CARMEL, PA:
3,310,350, PUB. 7-31-2007. INT. CL. 19.
- REGENT HOSPITALITY WORLDWIDE, INC., MINNEAPOLIS, MN:
3,311,970, PUB. 7-31-2007. MULTIPLE CLASS, INT. CLS. 39 AND 43.
3,311,971, PUB. 7-31-2007. MULTIPLE CLASS, INT. CLS. 39 AND 43.
- REGENTS OF THE UNIVERSITY OF MINNESOTA, MINNEAPOLIS, MN:
3,310,497, PUB. 7-31-2007. INT. CL. 41.
- REGINA U.S.A., INC., CAMBRIDGE, MD:
1,458,985, REN. 9-13-07. INT. CL. 7.
- REGIO IV, LLC, LOS ANGELES, CA:
3,313,838, INT. CL. 9.
- REGION VII EDUCATION SERVICE CENTER, KILGORE, TX:
3,312,586, PUB. 7-31-2007. INT. CL. 42.
- REGIS CORPORATION, MINNEAPOLIS, MN TO TRADE SECRET INC, MINNEAPOLIS, MN:
2,021,048, CANC. INT. CL. 3.
- REHAU AG & CO., D-8673 REHAU, FED REP GERMANY:
1,419,183, CANC. INT. CL. 17.
- REITZEL, ANDREW, S, MESA, AZ:
3,314,079, INT. CL. 35.
- RELACOM INTERNATIONAL HOLDING AB, SWEDEN:
3,312,879, PUB. 7-31-2007. MULTIPLE CLASS, INT. CLS. 9, 37, 38 AND 42.
- RELIANT GROUP, INC., THE, SAN FRANCISCO, CA:
2,322,883, CANC. INT. CL. 36.
- REMINGTON, INC., VALENCIA, CA:
3,314,992, INT. CL. 11.
- REMO, INC., VALENCIA, CA:
3,310,373, PUB. 7-31-2007. INT. CL. 15.
- REMOTE COMMUNICATIONS, INC., LITTLETON, CO:
2,411,101, CANC. INT. CL. 9.
- REMOTEPİPES, INC., HOPKINS, MN:
2,834,149, CANC. INT. CL. 38.
- RENA ENTERPRISES, INC., SINKING SPRING, PA:
3,314,493, INT. CL. 25.
- RENAISSANCE MARK, INC., DENVER, CO:
1,419,533, CANC. INT. CL. 42.
- RENAL CARE GROUP, NASHVILLE, TN, DBA INTEGRATED WOUND CARE SYSTEMS:
2,410,834, CANC. INT. CL. 9.
- RENAL CARE GROUP, INC., NASHVILLE, TN, DBA INTEGRATED WOUND CARE SYSTEMS:
2,410,835, CANC. INT. CL. 9.
- RENASAS TECHNOLOGY CORP., CHIYODA-KU, TOKYO, JAPAN:
3,312,996, MULTIPLE CLASS, INT. CLS. 9 AND 42.
- RENFROW, JESSICA ASHLEY, SARASOTA, FL AND RENFROW, JUSTIN ERIC, SARASOTA, FL:
3,313,031, INT. CL. 30.
- REINHARD, DJI, SEATTLE, WA:
3,313,432, MULTIPLE CLASS, INT. CLS. 25 AND 35.
- RENT-A-CENTER WEST, INC., PLANO, TX:
3,310,465, PUB. 7-31-2007. INT. CL. 36.
- RENTBUREAU, LLC, ATLANTA, GA:
3,311,426, PUB. 7-31-2007. INT. CL. 36.
- REPROQUEST, LLC, FITCHBURG, WI:
3,314,505, INT. CL. 5.
- REPUBLIC CLOTHING CORPORATION, NEW YORK, NY:
2,410,524, CANC. INT. CL. 25.
- RESCO PRODUCTS, INC., NORRISTOWN, PA, NORTH STATE PYROPHYLLITE COMPANY, INC., GREENSBORO, NC:
662,981, REN. 9-7-07. U.S. CL. 12 (INT. CLS. 6, 17 AND 19).
- RESCUE BEVERAGE COMPANY, PALM HARBOR, FL:
3,313,304, INT. CL. 5.
- RESCUE, INCORPORATED, MINNEAPOLIS, MN:
3,311,487, PUB. 7-31-2007. INT. CL. 39.
- RESORT AT SUMMERLIN, L.P., THE, LAS VEGAS, NV:
2,411,251, CANC. INT. CL. 42.
- RESORT PROPERTY MANAGEMENT, INC., DESTIN, FL:
2,074,276, REN. 9-10-07. MULTIPLE CLASS, INT. CLS. 39, 41 AND 42.
- RESCARE, INC., COCONUT CREEK, FL:
3,314,467, INT. CL. 10.
- RESTAURANT DEVELOPERS CORP., MIDDLEBURG HEIGHTS, OH, MR. HERO SANDWICH SYSTEMS, INC., CLEVELAND, OH:
1,072,331, REN. 9-12-07. MULTIPLE CLASS, INT. CLS. 30, 35 AND 42.
- RESTAURANT DEVELOPERS CORP., INDEPENDENCE, OH:
2,020,567, CANC. INT. CL. 42.
- RESTEK CORPORATION, BELLEFONTE, PA:
3,311,210, PUB. 7-31-2007. INT. CL. 9.
- RESTİFO PHİLİP, LAS VEGAS, NV:
3,311,456, PUB. 7-31-2007. INT. CL. 33.
- RESTORING ORDER LLC, SHERWOOD, OR:
3,314,675, INT. CL. 16.

- RESTRAD, LLC, NEW YORK, NY:
3,313,792, MULTIPLE CLASS, INT. CLS. 3 AND 8.
- RETAIL ROYALTY COMPANY, LAS VEGAS, NV:
3,312,075, PUB. 7-31-2007. INT. CL. 25.
- RETIREMENT BRIDGE, LLC, SAN FRANCISCO, CA:
3,314,777, INT. CL. 42.
- RETROSPECS & CO., AUTHENTIC EARLY AMERICAN EYEWEAR, SANTA MONICA, CA:
3,310,664, PUB. 7-31-2007. INT. CL. 35.
- RF TECHNOLOGIES, INC., BROOKFIELD, WI:
2,137,314, REN. 9-9-07. INT. CL. 9.
- RFA, INC., FT. LAUDERDALE, FL, RAIN FOREST AQUACULTURE PRODUCTS, INC., NEWCASTLE, ME:
2,083,757, REN. 9-7-07. INT. CL. 29.
- RGF ENVIRONMENTAL GROUP, INC., WEST PALM BEACH, FL:
3,310,493, PUB. 7-17-2007. INT. CL. 11.
- RH CAPITAL ASSOCIATES LLC, SADDLE RIVER, NJ:
3,312,215, PUB. 7-31-2007. INT. CL. 36.
- RHODIA CHIMIE, FRANCE:
3,312,953, PUB. 7-31-2007. MULTIPLE CLASS, INT. CLS. 1 AND 40.
- RHONE-POULENC SPECIALTY CHEMICALS CO., CRANBURY, NJ:
2,409,671, CANC. INT. CL. 42.
- RICCO TIZIO WORLDWIDE, LLC, POMPANO BEACH, FL:
3,313,651, INT. CL. 25.
- RICECO LLC, MEMPHIS, TN:
3,313,052, INT. CL. 5.
- RICH-SEAPAK CORPORATION, ST. SIMON'S ISLAND, GA:
2,409,913, CANC. INT. CL. 29.
- RICH, LAWRENCE, NEW YORK, NY AND LEVY, SEYMOUR, NEW YORK, NY:
2,089,422, REN. 9-13-07. INT. CL. 25.
- RICHARD L SNOW, CLOVIS, CA AND LADONNA SNOW, CLOVIS, CA:
3,311,853, PUB. 7-31-2007. MULTIPLE CLASS, INT. CLS. 25 AND 35.
- RICHARDS & APPLEBY LIMITED, LONDON, ENGLAND:
1,418,852, CANC. INT. CL. 3.
- RICHARDS, ANN, DANVILLE, CA AND RICHARDS, CARISSA, DANVILLE, CA:
3,313,744, INT. CL. 36.
- RICHARDSON COMPANY, PHILADELPHIA, PA:
3,312,525, PUB. 7-31-2007. INT. CL. 41.
- RICHDALE MANAGEMENT, INC., OMAHA, NE:
3,311,316, PUB. 7-31-2007. INT. CL. 36.
- RICHTER, ALEXANDER EGON, 56422 WIRGES, FED REP GERMANY:
2,409,785, CANC. MULTIPLE CLASS, INT. CLS. 9 AND 41.
- RIDDELL & ASSOCIATES, INC., JACKSONVILLE, FL:
3,311,307, PUB. 7-10-2007. INT. CL. 5.
- RIDDLE, DAVID, HENRY, MURRIETA, CA:
3,310,694, PUB. 7-31-2007. INT. CL. 26.
- RIDE TO REMEMBER 9-11, CHICAGO, IL:
3,310,523, PUB. 7-31-2007. INT. CL. 45.
- RIDLEY BLOCK OPERATIONS, INC., MANKATO, MN:
3,314,244, INT. CL. 5.
- RIEDEL SHOES, INC., RED WING, MN:
3,311,035, PUB. 7-31-2007. INT. CL. 28.
- RIGHT SYSTEMS, THE, SOMERS POINT, NJ:
2,411,435, CANC. MULTIPLE CLASS, INT. CLS. 16 AND 42.
- RIGHT TRACK ACADEMY, LLC, RALEIGH, NC:
3,312,278, PUB. 7-31-2007. INT. CL. 41.
- RIH ACQUISITIONS MS I, LLC, TUNICA RESORTS, MS:
3,311,011, PUB. 7-31-2007. INT. CL. 41.
- RIH ACQUISITIONS NJ, LLC, ATLANTIC CITY, NJ:
3,310,893, PUB. 7-31-2007. INT. CL. 41.
3,311,003, PUB. 7-31-2007. INT. CL. 41.
3,311,004, PUB. 7-31-2007. INT. CL. 41.
3,311,005, PUB. 7-31-2007. INT. CL. 41.
- RIO PRODUCTS INTL., INC., IDAHO FALLS, ID, ORVIS COMPANY, INC., THE, MANCHESTER, VT:
2,096,276, REN. 9-13-07. INT. CL. 28.
- RIOPELE TÊXTEIS, S.A., PORTUGAL:
3,312,835, PUB. 7-31-2007. INT. CL. 24.
- RIPTIDE TECHNOLOGIES INC., SURREY, BRITISH COLUMBIA, V3T 5T4, CANADA:
2,411,001, CANC. MULTIPLE CLASS, INT. CLS. 9 AND 42.
- RISKDOCTOR, INC., BOULDER, CO:
3,310,987, PUB. 7-31-2007. INT. CL. 36.
- RITTAL GMBH & CO. KG, FED REP GERMANY:
3,312,756, PUB. 7-31-2007. MULTIPLE CLASS, INT. CLS. 6, 9, 11, 19, 37 AND 42.
- RIVENDELL WINERY LLC, NEW PALTZ, NY:
3,311,965, PUB. 7-31-2007. MULTIPLE CLASS, INT. CLS. 33, 35, 41 AND 43.
- RIZOMA S.R.L., S. MACARIO (VARESE), ITALY:
3,311,742, PUB. 7-31-2007. MULTIPLE CLASS, INT. CLS. 9, 12, 14 AND 25.
- RJ FEDER & ASSOCIATES, INC., CALABASAS, CA:
3,313,011, MULTIPLE CLASS, INT. CLS. 16, 35, 39, 41 AND 42.
- RK NETMEDIA, INC., MIAMI BEACH, FL:
3,310,789, PUB. 7-31-2007. INT. CL. 41.
- RMB & FAMILY INVESTMENTS LTD., TORONTO, ONTARIO, M2J 1V1, CANADA:
2,021,109, CANC. INT. CL. 10.
- ROADSIDE WERX, L.L.C., CHESTERFIELD, MO:
3,311,115, PUB. 7-31-2007. MULTIPLE CLASS, INT. CLS. 37 AND 39.
3,311,488, PUB. 7-31-2007. INT. CL. 40.
- ROB RO ENTERPRISES, INC., FREDERICK, MD, DBA THE CELESTIAL UNICORN:
2,410,527, CANC. INT. CL. 16.
- ROBBINS-GIOIA, LLC, ALEXANDRIA, VA:
3,313,010, INT. CL. 42.
- ROBELLE CONSULTING LTD., SURREY BRITISH COLUMBIA, CANADA:
2,410,502, CANC. INT. CL. 9.
- ROBERT A. TOIGO FOUNDATION, OAKLAND, CA:
3,310,989, PUB. 7-31-2007. INT. CL. 35.
- ROBERT BOSCH GMBH, 70442 STUTTGART, FED REP GERMANY:
2,100,692, REN. 9-13-07. INT. CL. 42.
- ROBERT J., WHITTINGHAM, ORANGE, CA:
3,314,458, INT. CL. 37.
- ROBERT JAMES LUNTE, KIRKLAND, WA:
3,312,094, PUB. 7-31-2007. INT. CL. 41.
- ROBERT TALBOTT, INC., CARMEL VALLEY, CA:
3,313,874, INT. CL. 25.
- ROBERT-LESLIE PUBLISHING LLC, EVANSTON, IL:
3,311,435, PUB. 7-31-2007. MULTIPLE CLASS, INT. CLS. 16 AND 28.
3,311,514, PUB. 7-31-2007. INT. CL. 28.
3,311,516, PUB. 7-31-2007. INT. CL. 28.
3,311,518, PUB. 7-31-2007. INT. CL. 28.
- ROBERTS DAIRY COMPANY, OMAHA, NE:
2,100,103, REN. 9-12-07. MULTIPLE CLASS, INT. CLS. 29 AND 30.
- ROBERTS, ESTHER L., KNOXVILLE, TN:
2,095,325, REN. 9-12-07. INT. CL. 16.
2,103,562, REN. 9-12-07. INT. CL. 16.
- ROBERTSON, MAUREEN M., EAU CLAIRE, WI, DBA ROUTE 66 FROZEN CUSTARD & DINER:
3,312,992, MULTIPLE CLASS, INT. CLS. 30 AND 42.
- ROBIN HOOD SOFTWARE LIMITED, NOTTINGHAM NG13 8AH, GREAT BRITAIN:
3,310,247, PUB. 7-31-2007. MULTIPLE CLASS, INT. CLS. 9, 16, 35, 38 AND 42.
- ROBIN MARIETON, 69550 AMPLEPUIS, FRANCE:
2,410,293, CANC. INT. CL. 24.
- ROBINSON MANUFACTURING COMPANY, INC., DAYTON, TN:
1,456,631, REN. 9-13-07. INT. CL. 25.
1,460,976, REN. 9-13-07. INT. CL. 25.
- ROBINSON MFG. COMPANY, INC., DAYTON, TN:
350,881, REN. 9-13-07. U.S. CL. 39 (INT. CL. 25).
- ROBINSON, NATALIE, LAKE CHARLES, LA:
2,411,301, CANC. INT. CL. 35.
- ROBINSON, WILLIAM P., SAN DIEGO, CA, DBA ROBINSON ENTERPRISES:
1,419,045, CANC. INT. CL. 9.

- ROBIO'S RESTAURANTS, INC., CARLSBAD, CA:
1,429,640. REN. 9-9-07. INT. CL. 42.
- ROBOTIC PRODUCTION TECHNOLOGY, INC., AUBURN HILLS, MI:
3,312,570, PUB. 7-31-2007. MULTIPLE CLASS, INT. CLS. 7 AND 9.
- ROCHE THERAPEUTICS INC., NUTLEY, NJ:
3,312,079, PUB. 7-31-2007. MULTIPLE CLASS, INT. CLS. 35 AND 44.
- ROCHE, DENNIS, WASHINGTON, DC:
2,411,024, CANC. MULTIPLE CLASS, INT. CLS. 3 AND 42.
- ROCHESTER MIDLAND CORPORATION, ROCHESTER, NY:
3,312,508, PUB. 7-31-2007. INT. CL. 9.
- ROCK AND ROLL MAN, INC., BALTIMORE, MD:
2,410,119, CANC. INT. CL. 41.
- ROCK HOUSE WAY, BRENTWOOD, TN:
3,311,331, PUB. 7-17-2007. INT. CL. 41.
- ROCK INTERNATIONAL (SINGAPORE) PTE LTD, SINGAPORE, SINGAPORE:
3,312,043, PUB. 7-31-2007. INT. CL. 34.
- ROCK N' ROE PROMO, INC., BROOKLYN, NY:
3,310,342, PUB. 7-31-2007. INT. CL. 9.
- ROCKHILL INSURANCE COMPANY, KANSAS CITY, MO:
3,312,515, PUB. 7-31-2007. INT. CL. 36.
- ROCKIES TRADEMARKS, INC., LOUISVILLE, CO,
ROCKIES BREWING COMPANY, BOULDER, CO:
2,101,351. REN. 9-9-07. INT. CL. 32.
- ROCKIT SCIENCE LABS, LLC, NEW YORK, NY:
3,310,442, PUB. 7-31-2007. INT. CL. 18.
- ROCKWOOD, AMY, MODESTO, CA:
3,314,484, INT. CL. 28.
- ROCKY BRANDS, INC., NELSONVILLE, OH:
3,310,438, PUB. 7-31-2007. INT. CL. 25.
- RODALE INC., EMMAUS, PA:
2,410,903, CANC. INT. CL. 16.
- RODELY, EUGENE P., DUQUOIN, IL, AKA CIRCLE. R STEAK HOUSE:
1,419,517, CANC. INT. CL. 42.
- RODENHISER, WILLIAM, HOLLISTON, MA:
3,311,060, PUB. 7-31-2007. INT. CL. 43.
3,311,061, PUB. 7-31-2007. INT. CL. 43.
- RODGER, NORMAN D., CHICAGO, IL:
2,040,338. REN. 9-9-07. INT. CL. 16.
2,045,817. REN. 9-9-07. INT. CL. 16.
- RODRIGO, JACKS A., ASUNCION, PARAGUAY:
3,313,478, INT. CL. 25.
- RODRIGUEZ, RAUL CAMPILLO, ELCHE (ALICANTE), SPAIN:
3,314,167, INT. CL. 25.
- ROECKL SPORHANDSCHUHE; GMBH & CO. KG, 80469 MÜNCHEN, FED REP GERMANY:
3,312,938, PUB. 7-31-2007. MULTIPLE CLASS, INT. CLS. 25 AND 28.
- ROEM CORPORATION, SANTA CLARA, CA:
3,313,561, INT. CL. 37.
- ROGERS, ANDREW, TOORAK, AUSTRALIA:
3,311,832, PUB. 7-31-2007. INT. CL. 19.
- ROGERS, JOEL E., MADISON, WI:
3,311,741, PUB. 7-31-2007. INT. CL. 41.
- ROGERS, JOHN, KANSAS CITY, KS:
3,311,398, PUB. 7-31-2007. INT. CL. 35.
- ROHLEDER GMBH, FED REP GERMANY:
3,312,812, PUB. 7-31-2007. MULTIPLE CLASS, INT. CLS. 23, 24, 25 AND 27.
- ROIALTE INTERNATIONALE, INC., CARDIFF, CA:
3,310,617, PUB. 7-31-2007. INT. CL. 38.
- ROIG BORONAT, JOSE MARIA, TARRAGONA, SPAIN:
3,311,838, PUB. 7-31-2007. INT. CL. 25.
- ROIZEN, MICHAEL F., SHAKER HEIGHTS, OH AND OZ, MEHMET C., NEW YORK, NY:
3,313,306, INT. CL. 9.
- ROJAS, JOSUE O., SALINAS, CA AND LOPEZ, CARLOS C., SALINAS, CA:
3,311,174, PUB. 7-10-2007. INT. CL. 35.
- ROLEX WATCH USA, INC., NEW YORK, NY:
3,312,062, PUB. 7-31-2007. INT. CL. 14.
- ROLF BENZ AG & CO. KG, FED REP GERMANY:
3,312,783, PUB. 7-31-2007. MULTIPLE CLASS, INT. CLS. 3, 4, 8, 14, 18, 21, 24 AND 25.
- ROLLESOLUTIONS, INC., CASTRO VALLEY, CA:
3,311,146, PUB. 7-31-2007. INT. CL. 10.
- ROLLIE WILLIAMS PAINT SPOT, INC., ELKHART, IN:
2,092,907. REN. 9-13-07. INT. CL. 35.
- ROLY POLY FRANCHIS SYSTEMS, LLC, WESTPORT, CT:
2,128,651. REN. 9-11-07. INT. CL. 42.
- ROMA FOODS ENTERPRISES, INC., PISCATAWAY, NJ:
2,481,136, CANC. MULTIPLE CLASS, INT. CLS. 8 AND 18.
- ROMAN SANCHEZ, III, CHICAGO, IL:
2,409,980, CANC. INT. CL. 42.
- ROMANO, SALVATORE N., SCOTTSDALE, AZ:
3,314,427, INT. CL. 16.
- ROMAR INTERNATIONAL CORP., NEW YORK, NY:
3,313,898, INT. CL. 21.
- RONG ZHIGUO, CHAOYANG DISTRICT; BEIJING, CHINA:
3,312,940, PUB. 7-31-2007. INT. CL. 25.
- ROOFERS' SUCCESS INTERNATIONAL, LLC, ST. LOUIS, MO:
3,311,303, PUB. 7-31-2007. INT. CL. 41.
- ROOTER EXPRESS CORPORATION, BRUNSWICK, GA:
3,271,627, CANC. IIRN. RESTORED TO S.N. 78-670,458.
- ROPER, JESSE, III, INGLEWOOD, CA:
3,310,488, PUB. 7-31-2007. INT. CL. 18.
- ROSE PLASTICS USA, L.P., CALIFORNIA, PA:
1,447,520. REN. 9-13-07. INT. CL. 20.
- ROSE VALLEY GROUP, INC., WOODLAND, CA. ROSE VALLEY PRODUCE COMPANY, WOODLAND, CA:
432,235. REN. 9-10-07. U.S. CL. 46 (INT. CL. 31).
- ROSEVILLE COMMUNICATIONS COMPANY, ROSEVILLE, CA:
2,410,660, CANC. INT. CL. 38.
- ROSS, PETER, CARLSBAD, CA AND ROSS, NICHOLAS, CARLSBAD, CA AND ROSS, DAVID, CARLSBAD, CA:
3,313,445, INT. CL. 25.
- ROTH KASE U.S.A. LTD., MONROE, WI:
3,313,995, INT. CL. 29.
3,313,996, INT. CL. 29.
- ROTOSTUD LLC, ROSLYN HEIGHTS, NY:
3,310,839, PUB. 7-31-2007. INT. CL. 25.
- ROUND HILL CELLARS, ST. HELENA, CA, DBA RUTHERFORD WINE COMPANY:
3,314,263, INT. CL. 33.
- ROUND LAKE PUBLISHING COMPANY, INC., TRUMBULL, CT:
2,515,373, CANC. INT. CL. 16.
- ROUNABOUT THEATRE COMPANY, INC., NEW YORK, NY:
3,312,167, PUB. 7-31-2007. INT. CL. 35.
- ROUSE-FAIRWOOD DEVELOPMENT LIMITED PARTNERSHIP, COLUMBIA, MD:
3,312,691, PUB. 7-31-2007. INT. CL. 37.
3,312,693, PUB. 7-31-2007. INT. CL. 37.
- ROUX ASSOCIATES, INC., ISLANDIA, NY:
3,312,423, PUB. 7-31-2007. INT. CL. 42.
- ROVCAL, INC., MADISON, WI:
1,480,838. REN. 9-7-07. INT. CL. 21.
- ROXS, INC., AUSTIN, TX:
3,311,104, PUB. 7-31-2007. INT. CL. 43.
- ROY F. WESTON, INC., WEST CHESTER, PA:
1,419,415, CANC. INT. CL. 35.
- ROYAL IMEX INC., COMMERCE, CA:
2,409,956, CANC. INT. CL. 26.
- ROYAL ROBBINS, INC., MODESTO, CA:
3,314,387, INT. CL. 25.
- ROYAL WEST SALES, INC., WOODLAND HILLS, CA:
3,314,697, INT. CL. 9.
- ROYALE INTERIORS, LTD., TUCSON, AZ:
3,314,732, MULTIPLE CLASS, INT. CLS. 20 AND 37.
3,314,733, MULTIPLE CLASS, INT. CLS. 20 AND 37.
- ROYSE CITY FINANCIAL, INC., ROCKWALL, TX:
3,313,883, INT. CL. 36.
- ROYSTER-CLARK, INC., TARBORO, NC:
2,411,352, CANC. INT. CL. 1.

- ROZEK, CAROL E., MIDLAND PARK, NJ:
3,311,360, PUB. 7-31-2007. INT. CL. 41.
- RSC EQUIPMENT RENTAL, INC., SCOTTSDALE, AZ:
3,313,502, MULTIPLE CLASS, INT. CLS. 37, 39, 40 AND 44.
- RT BROKERAGE SERVICES, INC., SEATTLE, WA:
3,311,349, PUB. 7-31-2007. INT. CL. 36.
- RUBBERMAID INCORPORATED, WOOSTER, OH:
2,410,877, CANC. INT. CL. 20.
- RUBBERMAID INCORPORATED, ATLANTA, GA:
3,313,954, MULTIPLE CLASS, INT. CLS. 6 AND 12.
- RUBIN WELLNESS ASSETS LLC, NIWOT, CO:
3,313,286, INT. CL. 37.
- RUCKUS HOUSE PARTNERS, LLC, KANNAPOLIS, NC:
3,312,292, PUB. 7-31-2007. MULTIPLE CLASS, INT. CLS. 41 AND 43.
- RUDDER, FAITH, BELLFLOWER, CA:
3,311,508, PUB. 7-31-2007. INT. CL. 25.
- RUIZ ROZILES, HECTOR DANIEL, ZAPOPAN, JALISCO, MEXICO:
3,314,039, INT. CL. 33.
- RUN RUN, INC., NEW YORK, NY:
2,410,639, CANC. MULTIPLE CLASS, INT. CLS. 18, 20, 25 AND 35.
- RUSS WHITE & ASSOCIATES, L.L.C., GRAPEVINE, TX, DBA RWA FLOORING SOLUTIONS:
3,314,677, INT. CL. 35.
- RUSSELL ALISTAIR MCLEAN, NEW SOUTH WALES, AUSTRALIA:
3,312,186, PUB. 7-31-2007. INT. CL. 5.
- RUSSELL CORPORATION, ATLANTA, GA:
2,411,447, CANC. INT. CL. 25.
- RUSSELL, ERICH, HEALDSBURG, CA, DBA RABBIT RIDGE VINEYARDS:
2,176,857, REN. 9-9-07. INT. CL. 33.
- RUTHMAN PUMP & ENGINEERING, INC., CINCINNATI, OH:
3,310,370, PUB. 7-31-2007. INT. CL. 7.
- RUTTER COMMUNICATIONS NETWORK, LLC, MUNCIE, IN:
3,311,012, PUB. 7-31-2007. INT. CL. 37.
- RUTTKAY, LYNNE, ESCONDIDO, CA:
2,411,233, CANC. INT. CL. 9.
- RUUD LIGHTING, INC., RACINE, WI:
3,314,081, INT. CL. 11.
- RUUD, WILLIAM, OAKS, PA:
3,313,791, INT. CL. 25.
- RVISION, INC., SAN DIEGO, CA:
3,312,331, PUB. 7-31-2007. INT. CL. 9.
- RWD TECHNOLOGIES, INC., BALTIMORE, MD:
3,312,438, PUB. 7-31-2007. INT. CL. 9.
- RWK EINBAUKÜCHEN R. & W. KUHLMANN GMBH, FED REP GERMANY:
3,312,958, PUB. 7-31-2007. INT. CL. 20.
- RWS GROUP PLC, GERRARDS CROSS, BUCKS, UNITED KINGDOM AND MINESOFT LIMITED, LONDON, UNITED KINGDOM:
3,310,237, PUB. 7-31-2007. MULTIPLE CLASS, INT. CLS. 9, 16, 35, 38, 41 AND 42.
- RY-CON SPECIALTY FOODS, INC., CAMP HILL, PA:
3,311,088, PUB. 7-31-2007. INT. CL. 29.
- RYAN HILL REALTY, LLC, NAPERVILLE, IL:
3,313,247, INT. CL. 36.
- RYAN, JENNIFER, MILL VALLEY, CA:
3,058,072, CANC. INT. CL. 25.
- RYAN'S RESTAURANT GROUP, INC., GREER, SC:
1,467,753, REN. 9-8-07. INT. CL. 42.
- RYDER SYSTEM, INC., MIAMI, FL:
2,042,234, REN. 9-13-07. MULTIPLE CLASS, INT. CLS. 37 AND 39.
- RYOBI LTD., HIROSHIMA-KEN, JAPAN:
2,411,366, CANC. INT. CL. 28.
- RYOBI NORTH AMERICA, INC., ANDERSON, SC:
2,410,769, CANC. INT. CL. 7.
- RYOHIN KEIKAKU CO., LTD., TOKYO, JAPAN:
3,314,969, MULTIPLE CLASS, INT. CLS. 3, 4, 6, 8, 9, 11, 12, 14, 16, 18, 20, 21, 24, 25, 26, 29, 30, 32 AND 35.
- RYOBI LTD., LOS ANGELES, CA:
3,311,968, PUB. 7-31-2007. INT. CL. 25.
- S & B PARTNERS, HUMANSVILLE, MO:
3,310,647, PUB. 7-31-2007. INT. CL. 28.
- S & M BIKES, INC., SANTA ANA, CA:
3,311,711, PUB. 6-26-2007. INT. CL. 12.
- S & S FIRESTONE, INC., LEXINGTON, KY:
3,311,655, PUB. 7-31-2007. INT. CL. 12.
- S. A. BENDHEIM CO., INC., PASSAIC, NJ:
2,094,755, REN. 9-13-07. INT. CL. 35.
- S. L. BAGBY CO., CHARLOTTE, NC:
3,311,268, PUB. 7-31-2007. INT. CL. 42.
- S.A.T. SWISS ARMS TECHNOLOGY AG, NEUHAUSEN, SWITZERLAND:
3,311,777, PUB. 6-5-2007. INT. CL. 13.
3,311,778, PUB. 6-26-2007. INT. CL. 13.
- S.A.T. SWISS ARMS TECHNOLOGY AG, NEUHAUSEN CH-8212, SWITZERLAND:
3,311,963, PUB. 7-10-2007. INT. CL. 13.
3,311,964, PUB. 7-10-2007. INT. CL. 13.
- S.L.B. INC., LAS VEGAS, NV:
3,311,499, PUB. 7-31-2007. INT. CL. 37.
- S.T.T.H., INC., SUNNY ISLES BEACH, FL:
3,314,766, INT. CL. 34.
- S.W.B. APPAREL, INC., NEW YORK, NY:
3,313,242, INT. CL. 25.
3,314,650, INT. CL. 25.
- S-ANON INTERNATIONAL FAMILY GROUPS, NASHVILLE, TN:
3,311,364, PUB. 7-31-2007. MULTIPLE CLASS, INT. CLS. 16 AND 45.
- S-E-S KABUSHIKI KAISHA, TOKYO, JAPAN, TA S-E-S CO., LTD.:
3,311,830, PUB. 7-31-2007. INT. CL. 7.
- S-LCD CORPORATION, ASAN-SI, CHUNGCHEONGNAM-DO, REPUBLIC OF KOREA:
3,313,687, MULTIPLE CLASS, INT. CLS. 9 AND 11.
- SA ACKERMAN-REMY PANNIER, SAINT FLORENT 49400 SAUMUR, FRANCE:
3,313,566, INT. CL. 33.
- SAAB AB, LINKOPING, SWEDEN:
3,311,668, PUB. 7-31-2007. MULTIPLE CLASS, INT. CLS. 9, 38 AND 42.
- SABAN ENTERTAINMENT, INC., LOS ANGELES, CA:
2,411,072, CANC. INT. CL. 41.
- SABERTOOTH MOTORCYCLES LLC, GREER, SC:
3,314,172, INT. CL. 12.
- SABOUNJIAN, RAFI, PATERSON, NJ:
2,410,371, CANC. MULTIPLE CLASS, INT. CLS. 18 AND 20.
- SABRI NIHARI, INC., CHICAGO, IL:
3,311,302, PUB. 7-31-2007. INT. CL. 43.
- SACO, 75010 PARIS, FRANCE:
2,476,964, CANC. MULTIPLE CLASS, INT. CLS. 3 AND 18.
- SADRICIA WILSON, FLORENCE, AL AND CHAD WILSON, KILLEN, AL:
3,310,802, PUB. 7-31-2007. INT. CL. 9.
3,310,804, PUB. 7-31-2007. INT. CL. 9.
- SAEGER, TERRY M., POTOMAC FALLS, VA:
3,310,995, PUB. 7-31-2007. INT. CL. 35.
- SAEHAN INDUSTRIES INC., KYUNGSANGBUK-DO, REPUBLIC OF KOREA:
3,313,089, INT. CL. 24.
- SAEHAN INDUSTRIES INC., KYUNGSANG-DO, REPUBLIC OF KOREA:
3,313,135, INT. CL. 23.
- SAFE DAUGHTERS, LAKE ZURICH, IL:
3,314,275, INT. CL. 41.
- SAFE SHREDDING, LLC, ROSELAND, NJ:
3,314,418, INT. CL. 40.
- SAFE-COM GMBH & CO. KG, LICHTENFELS, FED REP GERMANY:
3,312,236, PUB. 7-31-2007. MULTIPLE CLASS, INT. CLS. 5, 9, 10 AND 44.
- SAFECO INSURANCE COMPANY OF AMERICA, SEATTLE, WA:
2,411,328, CANC. INT. CL. 36.

- SAFETY SYRINGE CORP., BOUNTIFUL, UT:
2,411,417, CANC. INT. CL. 10.
- SAFETY VISION, L.P., HOUSTON, TX:
2,169,946, REN. 9-10-07. INT. CL. 9.
- SAFEWAY INC., PLEASANTON, CA:
3,310,404, PUB. 7-17-2007. INT. CL. 29.
- SAFILO USA, INC., PARSIPPANY, NJ:
2,172,652, REN. 9-13-07. INT. CL. 9.
- SAFILO USA, INC., PARSIPPANY, NJ:
2,176,859, REN. 9-11-07. INT. CL. 9.
- SAGA SOFTWARE, INC., RESTON, VA:
2,410,282, CANC. INT. CL. 42.
- SAGE, MICHAEL R., GAINESVILLE, FL:
3,310,585, PUB. 7-31-2007. INT. CL. 35.
- SAGITTARIUS BRANDS, INC., NASHVILLE, TN:
3,314,391, INT. CL. 35.
3,314,510, INT. CL. 35.
- SAINT-GOBAIN ABRASIVES, INC., WORCESTER, MA:
1,452,120, REN. 9-8-07. INT. CL. 17.
- SALAMANDER HOLDINGS N.V., ORANJESTAD, ARUBA:
3,311,096, PUB. 7-31-2007. INT. CL. 35.
3,311,097, PUB. 7-31-2007. INT. CL. 35.
- SALENTEIN ARGENTINA B.V., BUENOS AIRES C.F. C1001
AAD, ARGENTINA:
3,312,882, PUB. 7-31-2007. INT. CL. 33.
- SALES PERFORMANCE HOLDING COMPANY, CHAR-
LOTTE, NC:
3,312,104, PUB. 7-31-2007. MULTIPLE CLASS, INT. CLS.
35 AND 41.
- SALIT, RICHARD M., BEVERLY HILLS, CA TO PALM
LABORATORIES, INC., LOS ANGELES, CA:
2,021,227, CANC. INT. CL. 3.
- SALOMON S.A., 74370 METZ-TESSY, FRANCE:
2,410,976, CANC. INT. CL. 28.
- SALTER STREET FILMS LIMITED, HALIFAX, NOVA
SCOTIA, CANADA:
2,409,693, CANC. MULTIPLE CLASS, INT. CLS. 9 AND
41.
- SALVATORE FERRAGAMO ITALIA S.P.A., FLORENCE,
ITALY, SALVATORE FERRAGAMO S.P.A., FLORENCE,
ITALY:
1,454,689, REN. 9-7-07. INT. CL. 42.
- SAM'S ITALIAN FOODS, LEWISTON, ME:
3,312,420, PUB. 7-31-2007. INT. CL. 43.
- SAMICK MUSIC CORPORATION, GALLATIN, TN:
2,410,921, CANC. INT. CL. 15.
- SAMMONS, BEN, DAYTON, OH:
3,312,220, PUB. 7-31-2007. INT. CL. 12.
- SAMMY CORPORATION, TOSHIMA-KU TOKYO, JAPAN:
3,310,205, PUB. 7-31-2007. INT. CL. 35.
- SAMUEL HEATH & SONS PLC, BIRMINGHAM, UNITED
KINGDOM:
3,312,404, PUB. 7-31-2007. MULTIPLE CLASS, INT. CLS. 6
AND 7.
- SAMY MARK, INC., MIAMI, FL:
3,313,922, INT. CL. 44.
- SAN ANTONIO LIGHTHOUSE, SAN ANTONIO, TX:
3,311,186, PUB. 7-31-2007. INT. CL. 16.
- SAN CRISTOBAL MULTIMERCADOS, INC., KIRKLAND,
WA, DBA SAN CRISTOBAL COFFEE IMPORTERS:
3,310,371, PUB. 7-31-2007. INT. CL. 30.
- SAN DIEGO PORTABLE RENTALS LLC, SAN YSIDRO, CA:
3,310,643, PUB. 7-31-2007. INT. CL. 44.
- SAN FERNANDO BEAUTY ACADEMY, PANORAMA CITY,
CA:
3,312,060, PUB. 7-31-2007. INT. CL. 41.
- SAN FRANCISCO BASEBALL ASSOCIATES L.P., SAN
FRANCISCO, CA:
3,313,920, INT. CL. 18.
3,313,921, INT. CL. 28.
- SAN FRANCISCO FRENCH BREAD COMPANY, DEER-
FIELD, IL TO INTERSTATE BAKERIES CORPORATION,
KANSAS CITY, MO:
2,021,264, CANC. INT. CL. 30.
- SAN JOSE MERCURY NEWS, INC., SAN JOSE, CA:
2,411,545, CANC. INT. CL. 16.
- SANCHEZ ROMERO CARVAJAL JABUGO S.A., CADIZ,
SPAIN:
3,310,591, PUB. 7-31-2007. MULTIPLE CLASS, INT. CLS.
29 AND 43.
- SAND DUNE VENTURES, INC., HERMOSA BEACH, CA:
3,312,185, PUB. 7-31-2007. MULTIPLE CLASS, INT. CLS.
9, 35, 36, 40 AND 42.
- SANDERS, ROBERT ALAN, FRUITLAND, ID:
3,310,736, PUB. 7-31-2007. INT. CL. 37.
- SANDLOT RADIO NETWORK, LLC, LITTLETON, CO:
3,312,272, PUB. 7-31-2007. INT. CL. 41.
3,312,273, PUB. 7-31-2007. INT. CL. 41.
- SANDS, ROLAND W., LONG BEACH, CA:
3,313,813, INT. CL. 25.
- SANFORD WINERY CORPORATION, BUELLTON, CA:
3,313,738, INT. CL. 33.
- SANGAMO BIOSCIENCES, INC., RICHMOND, CA:
3,311,747, PUB. 7-31-2007. MULTIPLE CLASS, INT. CLS. 1
AND 5.
- SANITARY FISH MARKET AND RESTAURANT, INC.,
MOREHEAD CITY, NC:
3,310,533, PUB. 7-10-2007. MULTIPLE CLASS, INT. CLS.
25 AND 30.
- SANUVOX TECHNOLOGIES INC., QUEBEC, CANADA:
3,312,518, PUB. 7-31-2007. INT. CL. 11.
- SANYO ELECTRIC CO., LTD., MORIGUCHIO CITY, OSA-
KA, JAPAN:
824,045, COR. MULTIPLE CLASS, U.S. CLS. 31 AND 36.
SANYO ELECTRIC CO., LTD., MORIGUCHI CITY, OSAKA,
JAPAN:
3,313,410, INT. CL. 9.
- SAPHONE LLC, NEW YORK, NY:
3,310,846, PUB. 7-17-2007. INT. CL. 38.
- SAPIEN, ENRIQUE, SANTA CATARINA, MEXICO:
3,311,493, PUB. 7-31-2007. INT. CL. 16.
- SAPPI TRANSCRIPT LIMITED, LONDON, SW1X 9QX,
UNITED KINGDOM:
2,410,382, CANC. INT. CL. 16.
- SAPUTO CHEESE USA INC., LINCOLNSHIRE, IL, UNIVER-
SAL FOODS CORPORATION, MILWAUKEE, WI:
1,073,709, REN. 9-13-07. INT. CL. 29.
- SARA LEE CORPORATION, WINSTON-SALEM, NC:
2,031,112, CANC. INT. CL. 3.
- SARA LEE/DE N.V., 3532 AD UTRECHT, NETHERLANDS:
3,312,390, PUB. 7-31-2007. INT. CL. 9.
3,312,391, PUB. 7-31-2007. INT. CL. 11.
- SARAH BROWN, BROOKLYN, NY:
3,310,737, PUB. 7-31-2007. INT. CL. 41.
- SARAMAR CORPORATION, DOVER, DE:
1,419,302, CANC. INT. CL. 25.
- SARP INDUSTRIES, 78520 LIMAY, FRANCE:
2,410,176, CANC. MULTIPLE CLASS, INT. CLS. 11 AND
40.
- SARTORIUS AG, D-37075 GOTTINGEN, FED REP GER-
MANY:
3,234,006, COR. INT. CL. 9.
- SASCHA LLC, PORTLAND, OR:
3,314,803, INT. CL. 25.
- SASCHA PELJHAN, FED REP GERMANY AND JOZO
LONAC, FED REP GERMANY:
3,312,894, PUB. 7-31-2007. MULTIPLE CLASS, INT. CLS.
18, 25 AND 42.
- SATORI MOVEMENT, SAN FRANCISCO, CA:
3,310,673, PUB. 7-31-2007. INT. CL. 28.
- SAUNDERS, CAMILLE P., FORT MYERS, FL:
2,409,940, CANC. INT. CL. 16.
- SAUSE, MARK, F, WATERFORD, MI AND SAUSE, BAR-
BARA, J, WATERFORD, MI:
3,312,074, PUB. 7-31-2007. INT. CL. 20.
- SAVANNAH FOOD COMPANY, INC., SAVANNAH, TN:
3,312,687, PUB. 7-31-2007. MULTIPLE CLASS, INT. CLS.
29 AND 30.
- SAVE-A-LOT FOOD STORES, LTD., EARTH CITY, MO:
3,314,520, INT. CL. 30.
- SAVI MEDIA GROUP, INC., HUNTINGTON BEACH, CA:
3,313,757, INT. CL. 7.
- SAVVIER, L.P., CARLSBAD, CA:
3,312,367, PUB. 7-31-2007. INT. CL. 9.

- SAWGRASS TECHNOLOGIES, INC., MOUNT PLEASANT, SC:
3,310,453, PUB. 7-31-2007. INT. CL. 9.
- SAWYER, GEOFFREY, ATLANTA, GA AND SAWYER, NIGEL, MARIETTA, GA:
3,314,270, INT. CL. 25.
- SAY WHAT! CORP., LOUISVILLE, KY:
2,410,529, CANC. INT. CL. 16.
- SAYCHAR, LLC, HOUSTON, TX:
3,311,946, PUB. 7-31-2007. INT. CL. 28.
- SBB, LLC, LOS ANGELES, CA:
3,312,523, PUB. 7-31-2007. INT. CL. 41.
- SCANSOURCE, INC., GREENVILLE, SC:
3,312,545, PUB. 7-31-2007. INT. CL. 35.
3,312,546, PUB. 7-31-2007. INT. CL. 35.
- SCAVOK ENTERPRISES, INC., AURORA, CO:
2,409,922, CANC. INT. CL. 42.
- SCHÄFER, CHRISTOPH, ARISDORF, SWITZERLAND:
3,241,627, COR. MULTIPLE CLASS, INT. CLS. 14, 18 AND 25.
- SCHACHT SPINDLE COMPANY, INC., BOULDER, CO, SCHACHT SPINDLE COMPANY, BOULDER, CO:
1,098,555, REN. 9-13-07. INT. CL. 7.
- SCHAERER MAYFIELD USA, INC., CINCINNATI, OH:
3,313,079, INT. CL. 10.
- SCHENCK ROTEC GMBH, DARMSTADT, FED REP GERMANY:
3,310,495, PUB. 7-31-2007. MULTIPLE CLASS, INT. CLS. 7 AND 37.
- SCHERING-PLOUGH ANIMAL HEALTH CORPORATION, SUMMIT, NJ:
1,418,920, CANC. INT. CL. 5.
3,311,899, PUB. 7-31-2007. INT. CL. 5.
- SCHERING-PLOUGH HEALTHCARE PRODUCTS, INC., MEMPHIS, TN:
348,879, REN. 9-7-07. U.S. CL. 6 (INT. CLS. 1, 2, 3, 4 AND 5).
2,411,436, CANC. INT. CL. 25.
- SCHILLER, HENRI, PARIS, FRANCE:
1,478,230, REN. 9-13-07. INT. CL. 5.
- SCHIMMEL VERWALTUNGSGESELLSCHAFT MBH, FED REP GERMANY:
3,312,787, PUB. 7-31-2007. MULTIPLE CLASS, INT. CLS. 9 AND 15.
- SCHLEIEN, BERNARD ALBERTO, LIMA, PERU:
3,310,728, PUB. 7-31-2007. MULTIPLE CLASS, INT. CLS. 39 AND 43.
- SCHMID, CHRISTIAN, HERBOLZHEIM, FED REP GERMANY:
3,313,895, INT. CL. 42.
- SCHNEIDER, JESSE, HOLLYWOOD, FL, DBA HUH CLOTHING:
3,312,150, PUB. 7-31-2007. INT. CL. 25.
- SCHOEPP, ALEXANDRA, RICHMOND, VA:
3,313,558, MULTIPLE CLASS, INT. CLS. 25, 35 AND 45.
- SCHOLLE CORPORATION, IRVINE, CA:
3,314,254, INT. CL. 17.
- SCHONFELD & COMPANY LLC, NEW YORK, NY:
2,410,182, CANC. INT. CL. 36.
- SCHOOL APPAREL, INC., SAN BRUNO, CA:
3,312,235, PUB. 7-31-2007. MULTIPLE CLASS, INT. CLS. 25 AND 40.
- SCHOOL SPECIALTY, INC., APPLETON, WI:
2,410,188, CANC. INT. CL. 16.
- SCHOTT ZWIESEL AG, 94227 ZWIESEL, FED REP GERMANY:
2,916,899, CANC. INT. CL. 21.
3,006,851, CANC. INT. CL. 21.
- SCHRAMM, INC., WEST CHESTER, PA:
3,314,173, INT. CL. 7.
- SCHREIBER FOODS, INC., GREEN BAY, WI:
3,313,268, INT. CL. 29.
- SCHREIFER, SARAH K., DESTIN, FL:
3,311,033, PUB. 7-31-2007. INT. CL. 43.
- SCHULTZ FINANCIAL GROUP INCORPORATED, RENO, NV:
3,311,403, PUB. 7-31-2007. INT. CL. 36.
- SCHUMACHER PAINTING INC., YAKIMA, WA:
3,311,790, PUB. 4-24-2007. INT. CL. 43.
- SCHWAN-STABILO; COSMETICS GMBH & CO. KG, FED REP GERMANY:
3,312,755, PUB. 7-31-2007. MULTIPLE CLASS, INT. CLS. 3 AND 5.
- SCHWAN'S IP, LLC, MARSHALL, MN:
1,454,504, REN. 9-13-07. MULTIPLE CLASS, INT. CLS. 29, 30 AND 32.
3,313,674, INT. CL. 30.
- SCHWARTZ, TRACY LYNN, LUSBY, MD:
3,311,784, PUB. 7-31-2007. INT. CL. 28.
- SCIELE PHARMA, INC., ATLANTA, GA:
3,314,557, INT. CL. 5.
- SCIENCE APPLICATIONS INTERNATIONAL CORPORATION ("SAIC"), SAN DIEGO, CA:
2,410,759, CANC. INT. CL. 42.
- SCIENTIFIC COMPUTING ASSOCIATES, INC., NEW HAVEN, CT:
3,313,402, INT. CL. 9.
- SCIENTIFIC INSTRUMENT SERVICES, INC., RINGOES, NJ:
3,313,221, INT. CL. 9.
- SCIMETRIKA, LLC, RESEARCH TRIANGLE PARK, NC:
3,310,649, PUB. 7-31-2007. INT. CL. 35.
- SCISSORMAN PTY LTD, AUSTRALIA:
3,312,973, PUB. 7-31-2007. INT. CL. 8.
- SCOTT FETZER COMPANY, THE, WESTLAKE, OH:
2,176,722, REN. 9-13-07. INT. CL. 7.
- SCOTT USA LIMITED, UNITED KINGDOM:
3,312,814, PUB. 7-31-2007. INT. CL. 12.
- SCRANTON GILLETTE COMMUNICATIONS, INC., ARLINGTON HEIGHTS, IL:
3,311,223, PUB. 7-31-2007. INT. CL. 16.
- SCRATCH CONCEPTS, INC., GREENVILLE, SC:
3,313,303, MULTIPLE CLASS, INT. CLS. 39 AND 43.
- SCREENLINE INNOVATIONS, INC., LANGLEY, CANADA:
3,312,289, PUB. 7-31-2007. INT. CL. 6.
3,312,290, PUB. 7-31-2007. INT. CL. 6.
3,312,291, PUB. 7-31-2007. INT. CL. 6.
- SCREENVUE, INC., LOS ANGELES, CA:
3,312,388, PUB. 7-31-2007. INT. CL. 35.
- SCS LTD., LAKE ARIEL, PA:
3,314,343, INT. CL. 20.
- SDI TECHNOLOGIES INC., RAHWAY, NJ:
3,241,348, CANC. IIRN. RESTORED TO S.N. 78-629,917.
- SE-IR CORPORATION, GOLETA, CA:
3,310,792, PUB. 7-31-2007. INT. CL. 9.
- SE-KURE CONTROLS, INC., FRANKLIN PARK, IL:
3,311,872, PUB. 7-31-2007. MULTIPLE CLASS, INT. CLS. 6, 8, 9, 17 AND 20.
- SEA WATCH INTERNATIONAL, LTD., EASTON, MD:
2,087,556, REN. 9-13-07. INT. CL. 29.
2,087,557, REN. 9-13-07. INT. CL. 29.
- SEABREEZE ELECTRIC CORPORATION, TORONTO, ONTARIO, CANADA:
3,314,407, INT. CL. 11.
- SEAFIRE MICROS, INC., PEABODY, MA:
3,310,740, PUB. 7-31-2007. INT. CL. 9.
- SEAGATE TECHNOLOGY LLC, SCOTTS VALLEY, CA:
3,311,613, PUB. 7-31-2007. INT. CL. 9.
- SEALY TECHNOLOGY LLC, TRINITY, NC:
3,313,377, INT. CL. 20.
- SEATTLE GOURMET FOODS, INC., KENT, WA:
2,021,061, CANC. INT. CL. 5.
- SEB S.A., FRANCE:
3,312,826, PUB. 7-31-2007. MULTIPLE CLASS, INT. CLS. 6, 7, 8, 9, 10, 11, 16, 20, 21, 37 AND 41.
- SEBA-DYNATRONIC, BAUNACH, FED REP GERMANY:
1,419,009, CANC. INT. CL. 9.
- SECOND CHANCE MOTORS, INC., MARIETTA, GA:
3,313,277, MULTIPLE CLASS, INT. CLS. 35 AND 36.
- SECRET DOORWAYS, INC., SUNBURY, OH:
3,310,633, PUB. 7-31-2007. INT. CL. 19.
- SECTION8TACTICAL INC, CARY, NC:
3,311,117, PUB. 7-31-2007. INT. CL. 9.
- SECURE ASSET REPORTING SERVICES, INC., BELLEVUE, WA:
3,313,363, INT. CL. 35.

- SECURED TECHNOLOGY, L.L.C., STILWELL, KS:
3,310,467, PUB. 7-31-2007. INT. CL. 42.
- SECURITY METAL PRODUCTS CO., KANKAKEE, IL:
1,418,939, CANC. INT. CL. 7.
- SECURITY-CONNECTICUT LIFE INSURANCE COMPANY,
AVON, CT:
1,419,443, CANC. INT. CL. 36.
- SEE IT RIGHT! CORPORATION, RANCHO CUCAMONGA,
CA:
3,312,395, PUB. 7-31-2007. MULTIPLE CLASS, INT. CLS. 9
AND 16.
- SEFA S.P.A., 20123-MILAN, ITALY, SEFA S.R.L., 20123
MILAN, ITALY:
2,086,250, REN. 9-8-07. INT. CL. 30.
- SEITZ GMBH, 65830 KRIFTEL, FED REP GERMANY:
2,410,961, CANC. MULTIPLE CLASS, INT. CLS. 1 AND 3.
- SELDOM BLUES, LLC, DETROIT, MI:
3,312,041, PUB. 7-31-2007. INT. CL. 43.
- SELECT APPOINTMENTS (HOLDINGS) LIMITED, ST. AL-
BANS, ENGLAND:
3,311,034, PUB. 7-31-2007. INT. CL. 35.
- SELEY RANCHES LIMITED PARTNERSHIP, SOUTH PA-
SADENA, CA:
3,312,542, PUB. 7-31-2007. INT. CL. 31.
- SELL-HIGH LLC, WALTHAM, MA:
3,313,880, INT. CL. 35.
- SEMBA, INC., MADISON, WI:
3,310,894, PUB. 7-31-2007. MULTIPLE CLASS, INT. CLS. 9
AND 42.
- SENCO PRODUCTS, INC., CINCINNATI, OH:
1,418,928, CANC. INT. CL. 6.
- SENIOR LIFECHOICE CORP., FRAZER, PA TO SENIOR
LIFECHOICE, LLC, KIMBERTON, PA:
2,021,406, CANC. INT. CL. 42.
- SENKIR, DAMIEN JP, FONTANA, CA:
2,411,058, CANC. INT. CL. 25.
- SENSATA TECHNOLOGIES HOLLAND, B.V., AMSTER-
DAM, NETHERLANDS:
3,310,312, PUB. 7-31-2007. INT. CL. 9.
- SENTECH MEDICAL SYSTEMS, INC., CORAL SPRINGS,
FL:
2,049,058, REN. 9-10-07. INT. CL. 10.
- SEOUL LASER DIEBOARD SYSTEM CO., LTD., SAN
DIEGO, CA:
3,312,115, PUB. 7-31-2007. INT. CL. 7.
- SEPHORA, BOULOGNE BILLAN COURT, FRANCE TO
SEPHORA, BOULOGNE BILLAN COURT, FRANCE:
2,431,967, CANC. INT. CL. 38.
- SEQUENT LEARNING NETWORKS, INC., SAG HARBOR,
NY:
3,312,187, PUB. 7-31-2007. MULTIPLE CLASS, INT. CLS.
35 AND 41.
- SEQUIM LAVENDER GROWERS ASSOCIATION, SEQUIM,
WA:
3,312,072, PUB. 7-31-2007. MULTIPLE CLASS, INT. CLS.
35 AND 39.
- 3,312,073, PUB. 7-31-2007. INT. CL. 35.
- SERGEANTS BENEVOLENT ASSOCIATION, INC., NEW
YORK, NY:
3,310,532, PUB. 6-12-2007. INT. CL. 41.
- SERIANNI, MICHAEL, A., CLIFTON PARK, NY:
3,312,028, PUB. 7-31-2007. INT. CL. 43.
- SERVICEMASTER BRANDS L.L.C., BURLINGTON, VT:
3,311,733, PUB. 7-31-2007. MULTIPLE CLASS, INT. CLS.
35 AND 37.
- SESTER FARMS INC., GRESHAM, OR:
3,310,683, PUB. 7-31-2007. INT. CL. 31.
- SESTRAP, ROBERT, VASHON ISLAND, WA, DBA WAX
ORCHARDS:
1,419,603, CANC. INT. CL. 32.
- SEVEN HILLS SETTLEMENTS, LLC, ROME, GA:
3,313,796, INT. CL. 36.
- SEVENTH RANK MANAGEMENT, L.L.C., TUCSON, AZ:
3,310,323, PUB. 7-31-2007. INT. CL. 35.
3,310,324, PUB. 7-31-2007. INT. CL. 9.
- SEWARD, JAN STEFANACCI, GREAT BARRINGTON,
MA:
3,314,847, INT. CL. 45.
- SGTR, INC., PALM BEACH GARDENS, FL:
3,315,011, INT. CL. 44.
- SHAFER COMMERCIAL SEATING, INC., DENVER, CO:
3,312,057, PUB. 7-31-2007. INT. CL. 20.
- SHALOM INTERNATIONAL INC., PERTH AMBOY, NJ:
3,310,273, PUB. 7-31-2007. INT. CL. 26.
- SHAMBAN, AVA T., SANTA MONICA, CA:
3,313,988, INT. CL. 3.
- SHANAHAN, RICHARD, NAPLES, FL:
3,310,905, PUB. 7-31-2007. INT. CL. 9.
- SHANGHAI BENCHI METAL WARE COMPANY, CHINA:
3,312,770, PUB. 7-31-2007. INT. CL. 6.
- SHANGHAI STATIONERY & SPORTING GOODS IMPORT/
EXPORT CORPORATION, SHANGHAI, CHINA:
1,419,318, CANC. INT. CL. 28.
- SHANGHAI Y.W.E. INDUSTRY INC. LTD., SHANGHAI,
CHINA:
3,314,515, INT. CL. 18.
- SHARI'S BERRIES, INC., SACRAMENTO, CA:
3,312,287, PUB. 7-31-2007. INT. CL. 30.
- SHARP BANCYSYSTEMS INC., BEDFORD, TX:
3,313,505, INT. CL. 9.
- SHARPER IMAGE CORPORATION, SAN FRANCISCO, CA:
2,410,648, CANC. INT. CL. 28.
2,411,160, CANC. INT. CL. 11.
3,313,676, INT. CL. 11.
- SHARPLINE CONVERTING, INC., WICHITA, KS:
3,310,711, PUB. 7-31-2007. INT. CL. 17.
- SHAW INDUSTRIES, INC., DALTON, GA:
2,020,998, CANC. INT. CL. 27.
- SHAY L. PALMER, TUSTIN, CA AND CHRIS THOMPSON,
TUSTIN, CA:
3,311,669, PUB. 7-31-2007. INT. CL. 25.
- SHEA, MARJORIE E., KITTY HAWK, NC:
3,310,833, PUB. 7-31-2007. INT. CL. 35.
- SHEAFFER INTERNATIONAL, LLC, GLEN ELLYN, IL:
3,312,136, PUB. 7-31-2007. INT. CL. 42.
- SHEAFFER PEN CORPORATION, FORT MADISON, IA:
3,311,866, PUB. 7-31-2007. INT. CL. 16.
- SHEEHY, SUSAN M., NEW MILFORD, CT:
3,313,119, INT. CL. 28.
- SHEFA FRANCHISES, LTD., MIAMI, FL:
3,314,329, MULTIPLE CLASS, INT. CLS. 29, 30 AND 32.
3,314,330, INT. CL. 35.
- SHEFFER, MICHAEL J., SAN LUIS OBISPO, CA:
3,312,514, PUB. 7-31-2007. INT. CL. 28.
- SHEILA MOSES, SPOKANE VALLEY, WA AND MARTY
MOSES, SPOKANE VALLEY, WA:
3,312,003, PUB. 7-31-2007. INT. CL. 36.
- SHELFWORKS TECHNOLOGIES, LLC, ENGLEWOOD, NJ:
3,311,761, PUB. 7-31-2007. INT. CL. 20.
- SHELL OIL COMPANY, HOUSTON, TX:
2,410,944, CANC. INT. CL. 9.
- SHELL TRADEMARK MANAGEMENT B.V., THE HAGUE,
NETHERLANDS:
2,343,492, CANC. INT. CL. 1.
- SHELTERED WINGS, INC., MIDDLETOWN, WI:
3,312,396, PUB. 7-31-2007. INT. CL. 9.
3,312,550, PUB. 7-31-2007. INT. CL. 9.
- SHENYANG SBT TECHNOLOGY; & DEVELOPMENT CO.,
LTD., CHINA:
3,312,955, PUB. 7-31-2007. MULTIPLE CLASS, INT. CLS.
5, 10 AND 34.
- SHEPPARD, GEORGE, LEAWOOD, KS:
3,310,557, PUB. 7-31-2007. INT. CL. 5.
- SHERWOOD SERVICES AG, SCHAFFHAUSEN, SWITZER-
LAND, BRUNSWICK CORPORATION, CHICAGO, IL:
824,501, REN. 9-7-07. U.S. CL. 44 (INT. CL. 10).
- SHIMANO INC., SAKAI, OSAKA, JAPAN:
2,020,437, CANC. INT. CL. 12.
- SHIMANO INC., JAPAN:
3,218,293, COR. INT. CL. 9.
- SHIMANO INC., SAKAI CITY, JAPAN:
3,313,285, INT. CL. 28.
- SHINNY USA, INC., WEST CHESTER, PA:
3,310,644, PUB. 7-31-2007. INT. CL. 41.
3,310,645, PUB. 7-31-2007. INT. CL. 41.
3,310,646, PUB. 7-31-2007. INT. CL. 41.

SHIPLEY DO-NUT FLOUR AND SUPPLY CO., INC., HOUSTON, TX:
3,313,755, INT. CL. 30.

SHIPPER CENTRAL, INC., COPPELL, TX:
3,312,002, PUB. 7-31-2007. INT. CL. 39.

SHIPWRECK COFFEE COMPANY, VEAZIE, ME:
3,311,375, PUB. 7-31-2007. INT. CL. 30.

SHIRT SUPPLY AND DECORATION LLC, LEWES, DE:
3,311,405, PUB. 7-31-2007. INT. CL. 35.

SHOE WORKS, INC., THE, COLUMBUS, OH:
1,419,280, CANC. INT. CL. 25.

SHOPPERTRAK RCT CORPORATION, CHICAGO, IL:
3,312,172, PUB. 7-31-2007. INT. CL. 42.

SHOWDOWN CREATIONS, INC., SAN ANTONIO, TX:
3,313,893, INT. CL. 28.

SHRI RAM CHANDRA MISSION, AUSTIN, TX:
2,090,527. REN. 9-11-07. INT. CL. 41.

SHUFFLE MASTER INC., LAS VEGAS, NV:
3,314,435, INT. CL. 41.

SHULMAN, DAVID, BELLEVUE, WA:
3,311,402, PUB. 7-31-2007. INT. CL. 35.

SHULMAN, JACK A., WESTFIELD, NJ:
3,311,870, PUB. 7-31-2007. INT. CL. 35.

SHUSTERMAN, RICHARD, WEST CONSHOHOCKEN, PA:
3,314,944, INT. CL. 36.

SIDDHI, ANDREW, LARKSPUR, CA:
3,313,143, INT. CL. 20.

SIDEMA SA, 6917 BARBENGO/LUGANO, SWITZERLAND:
2,020,533, CANC. MULTIPLE CLASS, INT. CLS. 24 AND 25.

SIDEWARE SYSTEMS INC., NORTH VANCOUVER, BRITISH COLUMBIA, CANADA:
2,410,095, CANC. INT. CL. 9.

SIEGMUND, BERND, FED REP GERMANY:
3,312,889, PUB. 7-31-2007. MULTIPLE CLASS, INT. CLS. 6, 7 AND 8.

SIEMENS AKTIENGESELLSCHAFT, FED REP GERMANY:
3,312,749, PUB. 7-31-2007. MULTIPLE CLASS, INT. CLS. 7, 9 AND 41.

SIEMENS MEDICAL SOLUTIONS USA, INC., MALVERN, PA:
3,313,359, INT. CL. 10.

SIEMENS WATER TECHNOLOGIES HOLDING CORP., WARRENDALE, PA, WESTGATE RESEARCH CORPORATION, MARINA DEL REY, CA:
1,075,440. REN. 9-13-07. INT. CL. 11.

SIENNA TECHNOLOGIES, INC., MARLBOROUGH, MA:
3,311,377, PUB. 7-31-2007. INT. CL. 35.
3,311,381, PUB. 7-31-2007. INT. CL. 35.

SIERRA ENTERTAINMENT, INC., BELLEVUE, WA:
3,311,334, PUB. 7-31-2007. INT. CL. 9.

SIGMA ALPHA SORORITY, BAD AXE, MI:
3,312,284, PUB. 7-31-2007. U.S. CL. 200.

SIGMA-TAU HEALTHSCIENCE, INC., NEW YORK, NY:
3,313,113, INT. CL. 5.

SIGMATEX (UK) LTD, RUNCORN, CHESHIRE WA7 3DU, ENGLAND:
2,409,776, CANC. INT. CL. 12.

SIGNAL INVESTMENT & MANAGEMENT CO., WILMINGTON, DE:
2,410,802, CANC. INT. CL. 5.
2,410,803, CANC. INT. CL. 5.

SIGNATURE CHEF COMPANY, LLC, GRAFTON, WI:
3,311,833, PUB. 4-24-2007. INT. CL. 43.

SIGNSTOREY, INC., ROCKY HILL, CT:
3,001,687, COR. MULTIPLE CLASS, INT. CLS. 9 AND 35.

SIKA AG, SWITZERLAND:
3,312,845, PUB. 7-31-2007. MULTIPLE CLASS, INT. CLS. 1 AND 17.

SILVER SPRING REALTY, LLC, SILVER SPRING, MD:
3,313,802, MULTIPLE CLASS, INT. CLS. 16, 36 AND 41.

SIMILASAN CORPORATION, HIGHLANDS RANCH, CO:
3,314,830, INT. CL. 5.

SIMMONS PET FOOD, INC., SILOAM SPRINGS, AR:
3,314,091, INT. CL. 31.

SIMMONS-BOARDMAN PUBLISHING CORPORATION, NEW YORK, NY:
3,313,816, INT. CL. 41.

SIMON & SIMON LLC, WASHINGTON, DC:
3,312,533, PUB. 7-31-2007. INT. CL. 9.
3,312,534, PUB. 7-31-2007. INT. CL. 9.

SIMON INTERNATIONAL TRADING CORP., NEW YORK, NY:
3,313,209, INT. CL. 25.

SIMON VOLKOV, INC., ORANGE, CA:
3,314,302, MULTIPLE CLASS, INT. CLS. 35 AND 41.

SIMONE CHICKENBONE, LLC, WICHITA, KS:
3,310,952, PUB. 7-31-2007. INT. CL. 3.
3,310,953, PUB. 7-31-2007. INT. CL. 3.
3,310,954, PUB. 7-31-2007. INT. CL. 3.
3,310,955, PUB. 7-31-2007. INT. CL. 3.

SIMPSON DOOR COMPANY, TACOMA, WA:
3,313,567, INT. CL. 19.
3,313,568, INT. CL. 19.

SINAI TEMPLE, LOS ANGELES, CA, DBA MOUNT SINAI MEMORIAL PARK:
3,312,657, PUB. 7-31-2007. MULTIPLE CLASS, INT. CLS. 36, 44 AND 45.

SINAI TEMPLE DBA MOUNT SINAI MEMORIAL PARK, LOS ANGELES, CA:
3,312,658, PUB. 7-31-2007. MULTIPLE CLASS, INT. CLS. 36, 44 AND 45.

SINGULUS TECHNOLOGIES AKTIENGESELLSCHAFT, KAHL, FED REP GERMANY:
2,087,398. REN. 9-7-07. INT. CL. 7.

SINTON ELECTRIC CO. LTD., TAICHUNG, TAIWAN:
3,310,978, PUB. 7-31-2007. INT. CL. 9.

SINTON ELECTRIC CO., LTD., WUFENG, TAICHUNG, TAIWAN:
3,310,730, PUB. 7-31-2007. INT. CL. 9.

SIR DRAKE LLC, NEW YORK, NY:
3,313,062, INT. CL. 25.

SIRONA DENTAL SYSTEMS GMBH, 64625 BENSHEIM, FED REP GERMANY:
3,312,711, PUB. 7-31-2007. MULTIPLE CLASS, INT. CLS. 9 AND 10.

SISTERS YOGA, LLC, FRESNO, CA:
3,310,968, PUB. 7-31-2007. INT. CL. 41.

SITE MANAGWARE, INC., FORT LAUDERDALE, FL:
3,314,465, INT. CL. 42.

SIWIN FOODS LTD., LEDUC, ALBERTA, CANADA:
3,314,032, INT. CL. 29.
3,314,033, INT. CL. 29.

SIX COMPANIONS FABRIC INDUSTRY CO., LTD., SHE-TOU SHIANG, TAIWAN:
3,314,627, INT. CL. 25.

SK CHEMICALS CO., LTD., KYUNGKI-DO, REPUBLIC OF KOREA AND SK NETWORKS CO., LTD., KYONGGI-DO, REPUBLIC OF KOREA AND SKC CO., LTD., KYONGGI-DO, REPUBLIC OF KOREA AND SK CORPORATION, SEOUL, REPUBLIC OF KOREA AND SK TELECOM CO., LTD., SEOUL, REPUBLIC OF KOREA:
3,311,834, PUB. 7-31-2007. INT. CL. 37.
3,311,835, PUB. 7-31-2007. INT. CL. 41.

SKILA, INC., MAHWAH, NJ:
2,409,829, CANC. INT. CL. 9.

SKIS DYNASTAR, INC., PARK CITY, UT:
1,452,335. REN. 9-13-07. INT. CL. 28.

SKY HIGH PROMOTIONS, INC., LOUISVILLE, KY:
3,314,716, INT. CL. 41.

SKYCOASTER OF FLORIDA, LLC, KISSIMMEE, FL:
3,310,671, PUB. 7-31-2007. INT. CL. 41.

SKYLIGHT HEALTHCARE SYSTEMS, INC., SAN DIEGO, CA:
3,314,896, INT. CL. 38.

SKYPE LIMITED, DUBLIN 2, IRELAND:
3,314,895, INT. CL. 38.

SKYSPO RTS INTERNATIONAL, INC., LINDEN, MI:
3,312,131, PUB. 7-31-2007. INT. CL. 9.

SLAM MARKETING, LLC, CARLE PLACE, NY:
3,314,923, INT. CL. 16.

SLANT/FIN CORPORATION, GREENVALE, NY:
1,468,192. REN. 9-11-07. INT. CL. 11.

SLICKFORCE ENTERTAINMENT LLC, LOS ANGELES, CA:
3,310,960, PUB. 7-31-2007. INT. CL. 41.

- SLL, INC., VERNON, CA:
3,230,251, COR. INT. CL. 25.
- SLOAN VALVE COMPANY, FRANKLIN PARK, IL:
2,089,987, REN. 9-7-07. INT. CL. 11.
- SLP AUTOMOTIVE GROUP, INC., TROY, MI:
2,409,764, CANC. INT. CL. 12.
- SMARKETING LLC, MONTECITO, CA:
3,310,454, PUB. 7-31-2007. INT. CL. 16.
- SMART CIRCLE INTERNATIONAL CORP., CONCORD, ONTARIO, CANADA:
3,313,868, INT. CL. 35.
- SMART TECHNOLOGIES INC., CALGARY, ALBERTA, CANADA:
3,312,149, PUB. 7-31-2007. INT. CL. 9.
- SMARTCALL, INC., LOS ANGELES, CA:
2,410,122, CANC. INT. CL. 35.
- SMARTEQUIP, INC., NORWALK, CT:
3,311,914, PUB. 7-31-2007. MULTIPLE CLASS, INT. CLS. 35 AND 37.
- SMARTMONEY, NEW YORK, NY:
2,177,037, REN. 9-9-07. INT. CL. 42.
- SMARTPHOTOLAB, LLC, MAHWAH, NJ, DBA NOROMIS:
3,311,076, PUB. 7-31-2007. INT. CL. 41.
- SMARTPHOTOLAB, LLC D/B/A NOROMIS, MAHWAH, NJ:
3,311,077, PUB. 7-31-2007. INT. CL. 41.
- SMARTSOUND SOFTWARE, INC., NORTHRIDGE, CA:
3,314,195, INT. CL. 9.
- SMEKAL, AARON, PALM HARBOR, FL:
2,410,289, CANC. MULTIPLE CLASS, INT. CLS. 9 AND 41.
- SMELL THE COFFEE, INC., HOUSTON, TX:
2,411,231, CANC. INT. CL. 42.
- SMILE EYES, INC., CEDARHURST, NY, DBA SMILEN EYEWEAR:
2,411,276, CANC. INT. CL. 9.
- SMITH & NEPHEW INC., TORONTO, ONTARIO, CANADA:
1,418,899, CANC. INT. CL. 5.
- SMITH BROTHERS, INC., DENTON, TX:
3,312,648, PUB. 7-31-2007. INT. CL. 22.
- SMITH, DANIEL BROWNING, SANTA MONICA, CA:
3,312,143, PUB. 7-31-2007. INT. CL. 41.
- SMITH, EARL F., PORTSMOUTH, VA:
2,411,124, CANC. MULTIPLE CLASS, INT. CLS. 35 AND 40.
- SMITH, KEVIN T., WASHINGTON, DC AND BUNTIN, BILLY, WASHINGTON, DC:
3,314,286, INT. CL. 25.
- SMITH, TIMOTHY C., ST. CHARLES, IL:
3,314,417, INT. CL. 41.
- SMITHKLINE BEECHAM CORPORATION, PHILADELPHIA, PA:
2,410,973, CANC. MULTIPLE CLASS, INT. CLS. 5 AND 42.
3,310,573, PUB. 7-31-2007. INT. CL. 5.
- SMOOCH, INC., ENCINO, CA:
3,314,936, INT. CL. 25.
- SNAP COURT, LLC, SALT LAKE CITY, UT:
3,311,380, PUB. 7-31-2007. INT. CL. 28.
- SNAPBRIDGE SOFTWARE, INC., CARLSBAD, CA:
3,314,021, INT. CL. 38.
3,314,022, INT. CL. 35.
- SNIKIDDY, LLC, BETHESDA, MD:
3,314,546, INT. CL. 30.
- SNIPITRON, LLC, CHICAGO, IL:
3,313,322, INT. CL. 9.
- SNOW TIME, INC., YORK, PA:
3,311,498, PUB. 7-31-2007. INT. CL. 41.
3,311,500, PUB. 7-31-2007. INT. CL. 41.
3,311,501, PUB. 7-31-2007. INT. CL. 41.
- SNUS HILL VINEYARD & WINERY, INC., MADRID, IA:
3,310,570, PUB. 7-31-2007. INT. CL. 33.
- SNYDER, SUSAN R., NORWALK, CT:
2,102,710, REN. 9-7-07. INT. CL. 42.
- SOAP DOPE COMPANY, THE, BLOOMINGTON, MN:
2,409,977, CANC. INT. CL. 3.
2,409,978, CANC. INT. CL. 3.
- SOCIÉTÉ CIVILE DU DOMAINE DE LA ROMANÉE-CONTI, VOSNE-ROMANÉE 21700, FRANCE:
3,310,265, PUB. 7-17-2007. INT. CL. 33.
- SOCIAL CONCEPTS, INC., LOS ALTOS, CA:
3,311,140, PUB. 7-31-2007. MULTIPLE CLASS, INT. CLS. 35, 38, 42 AND 45.
3,311,141, PUB. 7-31-2007. MULTIPLE CLASS, INT. CLS. 35, 38, 42 AND 45.
- SOCIEDAD COOPERATIVA DE PRODUCCION PESQUERA BUZOS Y PESCADORES DE LA BAJA CALIFORNIA S.C.L., ENSENADA, B.C., MEXICO:
2,088,609, REN. 9-12-07. INT. CL. 29.
- SOCIETE DE CONSEILS DE RECHERCHES ET D'APPLICATIONS SCIENTIFIQUES (S.C.R.A.S.), 75016 PARIS, FRANCE:
2,410,024, CANC. MULTIPLE CLASS, INT. CLS. 3, 5 AND 16.
- SOCIETE DES PRODUITS NESTLE S.A., VEVEY, SWITZERLAND:
3,313,323, INT. CL. 31.
3,313,327, INT. CL. 31.
3,314,811, INT. CL. 31.
- SOCIETE DES PRODUITS NESTLE, S.A., 1800 VEVEY, SWITZERLAND:
2,046,272, REN. 9-7-07. INT. CL. 30.
2,096,255, REN. 9-7-07. INT. CL. 11.
- SOCIETE GENERALE, 75009 PARIS, FRANCE:
2,086,905, REN. 9-11-07. MULTIPLE CLASS, INT. CLS. 36 AND 38.
- SOCIETY OF ACTUARIES, SCHAUMBURG, IL:
3,310,594, PUB. 7-31-2007. MULTIPLE CLASS, INT. CLS. 35, 41 AND 42.
- SOCIETY OF INCENTIVE & TRAVEL EXECUTIVES, CHICAGO, IL:
3,312,249, PUB. 7-31-2007. MULTIPLE CLASS, INT. CLS. 16, 35 AND 41.
- SOCIETY OF PETROLEUM ENGINEERS (SPE), INC., RICHARDSON, TX:
3,314,096, INT. CL. 42.
- SOCRATIC SOLUTIONS, INC., MIAMI, FL:
3,314,350, MULTIPLE CLASS, INT. CLS. 9, 16, 18, 25, 28, 35 AND 41.
3,314,508, MULTIPLE CLASS, INT. CLS. 9, 16, 18, 25, 28, 35 AND 41.
- SODEXHO USA, INC., WALTHAM, MA TO SODEXHO, INC., GAITHERSBURG, MD:
2,020,799, CANC. INT. CL. 42.
- SOFTWARE PRODUCTIVITY RESEARCH, LLC, HENDERSONVILLE, NC:
3,310,920, PUB. 7-31-2007. INT. CL. 9.
- SOFTWARENESS, RANDALLSTOWN, MD:
3,311,070, PUB. 7-31-2007. MULTIPLE CLASS, INT. CLS. 41 AND 42.
- SOH IP COMPANY, INC., PHOENIX, AZ:
3,311,225, PUB. 7-31-2007. INT. CL. 30.
3,311,226, PUB. 7-31-2007. INT. CL. 30.
3,311,227, PUB. 7-31-2007. INT. CL. 30.
- SOLE CREATIONS INC., FLUSHING, NY:
3,314,459, INT. CL. 25.
- SOLE MATTERS, LLC, CHATTANOOGA, TN:
3,313,282, MULTIPLE CLASS, INT. CLS. 25 AND 35.
- SOLIDSCAPE, INC., MERRIMACK, NH:
3,313,334, INT. CL. 9.
3,314,867, INT. CL. 9.
- SOLO INCORPORATED, NEWPORT NEWS, VA:
3,311,675, PUB. 5-9-2006. INT. CL. 8.
- SOLUTIA INC., ST. LOUIS, MO:
2,482,655, CANC. INT. CL. 4.
- SOLVAY SA, B-1050 BRUXELLES, BELGIUM:
3,312,892, PUB. 7-31-2007. MULTIPLE CLASS, INT. CLS. 1 AND 17.
3,312,893, PUB. 7-31-2007. MULTIPLE CLASS, INT. CLS. 1 AND 17.
- SOMFY SAS, FRANCE:
3,312,823, PUB. 7-31-2007. MULTIPLE CLASS, INT. CLS. 7 AND 9.

- SOMNUS MATTRESS CORPORATION, DOUBLE SPRINGS, AL:
3,311,585, PUB. 7-31-2007. INT. CL. 20.
- SONAFI, VIROFLAY, FRANCE:
3,311,779, PUB. 7-31-2007. INT. CL. 30.
- SONG CHUAN PRECISION CO., LTD., SHU-LIN CHENG, TAIPEI HSIEN, TAIWAN:
2,160,020, REN. 9-13-07. INT. CL. 9.
2,172,318, REN. 9-13-07. INT. CL. 9.
- SONG, DA, SAN LEANDRO, CA:
3,313,272, MULTIPLE CLASS, INT. CLS. 9 AND 11.
- SONG, RUHUA, MONTEREY PARK, CA:
3,310,363, PUB. 7-10-2007. INT. CL. 35.
- SONIC INNOVATIONS, INC., SALT LAKE CITY, UT:
3,313,463, INT. CL. 10.
- SONIQUE SURGICAL SYSTEMS, INC., ESCONDIDO, CA:
2,021,150, CANC. INT. CL. 10.
- SONY COMPUTER ENTERTAINMENT AMERICA INC., FOSTER CITY, CA:
3,314,562, INT. CL. 9.
- SONY DADC AUSTRIA AG, A-5081 ANIF, AUSTRIA:
3,312,721, PUB. 7-31-2007. MULTIPLE CLASS, INT. CLS. 9 AND 42.
- SONY ERICSSON MOBILE COMMUNICATIONS AB, SE-22188 LUND, SWEDEN:
3,311,567, PUB. 7-31-2007. INT. CL. 41.
- SONY ERICSSON MOBILE COMMUNICATIONS AB, LUND, SWEDEN:
3,312,890, PUB. 7-31-2007. INT. CL. 9.
- SONY KABUSHIKI KAISHA, TOKYO, JAPAN, TA SONY CORPORATION:
3,310,528, PUB. 7-31-2007. INT. CL. 9.
3,313,900, INT. CL. 9.
- SONY KABUSHIKI KAISHA (ALSO TRADING AS SONY CORPORATION), TOKYO, JAPAN:
2,020,093, CANC. INT. CL. 37.
- SONY ONLINE ENTERTAINMENT INC., CULVER CITY, CA:
3,313,616, INT. CL. 9.
- SONY PICTURES TELEVISION INC., CULVER CITY, CA:
3,314,930, MULTIPLE CLASS, INT. CLS. 38 AND 41.
- SONYA PAZ INCORPORATED, SANTA CLARA, CA:
3,310,997, PUB. 7-31-2007. MULTIPLE CLASS, INT. CLS. 14, 21, 24 AND 35.
- SOP SERVICES, INC., LAS VEGAS, NV:
3,310,741, PUB. 6-26-2007. INT. CL. 28.
3,312,392, PUB. 7-31-2007. INT. CL. 28.
3,313,372, INT. CL. 28.
- SOPRA - CONSEIL ET ASSISTANCE EN INFORMATIQUE, 74940 ANNECY LE VIEUX, FRANCE:
2,409,909, CANC. MULTIPLE CLASS, INT. CLS. 9, 16, 35, 38, 39, 40, 41 AND 42.
- SORIA NATURAL, S.L., 42162 GARRAY (SORIA), SPAIN:
3,313,383, INT. CL. 5.
- SOTSU CO., LTD., TOKYO, JAPAN:
1,450,948, REN. 9-13-07. INT. CL. 28.
- SOULE, MORGAN JEAN, ENCINITAS, CA:
3,310,539, PUB. 7-31-2007. INT. CL. 14.
3,310,540, PUB. 7-31-2007. INT. CL. 14.
- SOUNDHOUSE MUSIC ALLIANCE PTY LTD., EAST MELBOURNE, AUSTRALIA:
3,311,765, PUB. 7-31-2007. MULTIPLE CLASS, INT. CLS. 9 AND 15.
- SOUTH CAROLINA EDUCATION LOTTERY COMMISSION, COLUMBIA, SC:
3,314,471, INT. CL. 41.
- SOUTH CONE, INC., SAN DIEGO, CA:
2,411,196, CANC. INT. CL. 25.
- SOUTH DAKOTA BOARD OF REGENTS, PIERRE, SD:
3,313,973, INT. CL. 36.
- SOUTH EDGE, LLC, LAS VEGAS, NV:
3,312,624, PUB. 7-31-2007. INT. CL. 36.
3,312,625, PUB. 7-31-2007. INT. CL. 37.
- SOUTHEAST FINANCIAL CORPORATION, MIAMI LAKES, FL:
2,410,080, CANC. INT. CL. 36.
- SOUTHEASTERN GUIDE DOGS, INC., PALMETTO, FL:
3,314,587, MULTIPLE CLASS, INT. CLS. 41 AND 44.
- SOUTHERN FASTENER CORPORATION, MOBILE, AL:
2,411,166, CANC. INT. CL. 6.
- SOUTHERN MANOR LIVING CENTERS, LLC, BRENTWOOD, TN:
3,312,197, PUB. 7-31-2007. INT. CL. 43.
- SOUTHERN OUTDOOR TECHNOLOGIES, LLC, WEST POINT, MS:
3,310,429, PUB. 7-31-2007. INT. CL. 31.
- SOUTHERN STATES POLICE BENEVOLENT ASSOCIATION, INC., MCDONOUGH, GA:
3,311,753, PUB. 7-31-2007. MULTIPLE CLASS, INT. CLS. 35 AND 41.
- SOUTHWEST RESTAURANT SYSTEMS, INC., MESA, AZ:
2,020,082, CANC. INT. CL. 42.
- SOUTHWEST VIRGINIA COMMUNITY FOUNDATION, INC., GATE CITY, VA:
3,312,319, PUB. 7-31-2007. INT. CL. 41.
- SOVEREIGN BANK, WYOMISSING, PA:
3,314,439, INT. CL. 36.
3,314,726, MULTIPLE CLASS, INT. CLS. 35 AND 36.
- SOVEREIGN LABORATORIES, INC., FORT WALTON BEACH, FL:
3,312,680, PUB. 7-31-2007. INT. CL. 5.
- SOX UNLIMITED SALES CO., NEW YORK, NY:
2,410,092, CANC. INT. CL. 25.
- SP LICENSING, LLC, LOS ANGELES, CA:
3,314,354, INT. CL. 25.
- SPACE TO GO, L.P., MONONGAHELA, PA:
3,314,041, INT. CL. 39.
- SPAGHETTI SHOP, INC., THE, EDINA, MN TO SPAGHETTI SHOP OF MID-AMERICA, INC., THE, SPRINGFIELD, IL:
2,020,166, CANC. INT. CL. 42.
- SPAN TECH LLC, GLASGOW, KY:
3,314,591, INT. CL. 7.
- SPANISH BROADCASTING SYSTEM, INC., COCONUT GROVE, FL:
3,310,399, PUB. 7-31-2007. INT. CL. 41.
3,310,400, PUB. 7-31-2007. INT. CL. 41.
3,310,403, PUB. 7-31-2007. INT. CL. 41.
- SPANISH WATER DOG ASSOCIATION OF AMERICA, INC., SALT LAKE CITY, UT:
3,312,219, PUB. 7-31-2007. INT. CL. 35.
- SPANO, ANTHONY, NAPLES, FL:
3,312,581, PUB. 7-31-2007. MULTIPLE CLASS, INT. CLS. 16 AND 41.
- SPARKS, AUGUSTUS O.B. III, MILL VALLEY, CA:
3,310,677, PUB. 7-31-2007. INT. CL. 41.
- SPECIALITES UNLIMITED, INC., WATERBURY, VT:
3,312,599, PUB. 7-31-2007. INT. CL. 14.
- SPECIALTY CONSTRUCTION BRANDS, INC., SAINT PAUL, MN, H. B. FULLER COMPANY, ST. PAUL, MN:
1,065,566, REN. 9-12-07. INT. CL. 1.
- SPECIALTY CONSTRUCTION BRANDS, INC., SAINT PAUL, MN:
3,313,302, INT. CL. 19.
- SPECIALTY MINERALS (MICHIGAN) INC., BINGHAM FARMS, MI:
3,311,496, PUB. 7-31-2007. MULTIPLE CLASS, INT. CLS. 9 AND 42.
- SPECK PRODUCT DESIGN INC., PALO ALTO, CA:
3,313,872, INT. CL. 42.
- SPECTRUM BUILDING SYSTEMS, INC., GAINESVILLE, GA:
3,312,063, PUB. 7-31-2007. INT. CL. 42.
- SPECTRUM FOODS, INC., IRVINE, CA:
1,453,651, REN. 9-13-07. INT. CL. 42.
- SPECTRUM METALWORKS, INC, AUBURN HILLS, MI:
3,311,159, PUB. 7-31-2007. INT. CL. 2.
- SPECTRUM ORGANIC PRODUCTS, INC., PETALUMA, CA:
3,313,077, MULTIPLE CLASS, INT. CLS. 5, 29 AND 30.
- SPECTRUM SOLAR, LLC, HOLLYWOOD, FL:
3,310,967, PUB. 7-10-2007. INT. CL. 39.
- SPEEDO INTERNATIONAL LIMITED, LONDON W1U 3PH, UNITED KINGDOM:
2,122,618, REN. 9-12-07. INT. CL. 14.
- SPEEDWAY TBA, INC., CONCORD, NC:
2,409,706, CANC. INT. CL. 41.

- SPELLBOUND DEVELOPMENT GROUP, INC., NEWPORT BEACH, CA:
2,110,582. REN. 9-12-07. INT. CL. 8.
- SPI LASERS UK LIMITED, SOUTHAMPTON, SO30 2QU, UNITED KINGDOM:
3,313,169, INT. CL. 9.
- SPIEGELHOFF'S MARKET, LLC, BURLINGTON, WI:
3,314,593, INT. CL. 35.
- SPIER WINES (PTY) LTD, STELLENBOSCH, SOUTH AFRICA:
3,314,062, INT. CL. 33.
- SPINAL DYNAMICS CORPORATION, BELLVUE, WA:
2,411,068, CANC. INT. CL. 10.
- SPIRITED SISTERS, INC., BRIDGEWATER, MA:
3,314,001, INT. CL. 25.
- SPIRITS MARQUE ONE, LLC, NEW YORK, NY:
3,311,429, PUB. 7-31-2007. INT. CL. 33.
- SPLASH DESIGN B.V., NETHERLANDS:
3,312,866, PUB. 7-31-2007. MULTIPLE CLASS, INT. CLS. 9, 18 AND 25.
- SPM THERMO-SHIELD, INC., CUSTER, SD, GENERAL INDUSTRIES CORPORATION, COLORADO SPRINGS, CO:
1,457,881. REN. 9-7-07. INT. CL. 17.
- SPORT CLIPS IP, INC., GEORGETOWN, TX:
2,020,864, CANC. INT. CL. 42.
- SPORT GLOVE INTERNATIONAL, INC., DUXBURY, MA:
3,310,252, PUB. 7-31-2007. INT. CL. 28.
- SPORTS COSMETICS COMPANY LTD., THE, NEW YORK, NY:
2,410,916, CANC. INT. CL. 3.
- SPORTS@HOME, L.L.C., EVANSTON, IL:
2,411,116, CANC. INT. CL. 9.
- SPORTSOHIO INC., DUBLIN, OH:
2,174,367. REN. 9-11-07. INT. CL. 41.
- SPRADLIN, MATTHEW, DALLAS, TX:
3,313,023, MULTIPLE CLASS, INT. CLS. 9, 16 AND 41.
- SPRAY ON PRODUCTS, LTD., HOUSTON, TX:
3,310,392, PUB. 7-31-2007. INT. CL. 2.
3,310,393, PUB. 7-31-2007. INT. CL. 2.
- SPRINGHILL WHOLESALE, INC., TERRE HAUTE, IN:
3,311,597, PUB. 7-31-2007. INT. CL. 25.
- SPRINT NEXTEL CORPORATION, OVERLAND PARK, KS:
2,020,331, CANC. INT. CL. 37.
- SPROOSE, INC., DANVILLE, CA:
3,314,084, INT. CL. 45.
3,314,085, INT. CL. 42.
- SPX CORPORATION, CHARLOTTE, NC:
3,311,860, PUB. 7-31-2007. INT. CL. 7.
- SPYDERCUBE, INC., FORT LAUDERDALE, FL:
3,311,087, PUB. 7-31-2007. MULTIPLE CLASS, INT. CLS. 35 AND 36.
- SQUARE CO., LTD., TOKYO, JAPAN:
2,021,310, CANC. INT. CL. 16.
- SQUARE PEG SOFTWARE, LLC, FRANKLIN, TN:
3,311,814, PUB. 7-31-2007. INT. CL. 42.
- SQUIGLE, INC., NARBERTH, PA, PILOT RESEARCH & DEVELOPMENT CO., MERION, PA:
2,139,597. REN. 9-7-07. INT. CL. 10.
- SQUIRRELS AND MORE, LLC, SOMERS, CT:
3,311,365, PUB. 7-31-2007. INT. CL. 35.
- SRAM CORPORATION, CHICAGO, IL:
3,314,648, INT. CL. 12.
- SRH PRODUCTIONS, SAN DIEGO, CA:
2,021,091, CANC. INT. CL. 25.
- SRS LABS, INC., SANTA ANA, CA:
2,044,183. REN. 9-7-07. INT. CL. 9.
2,048,101. REN. 9-7-07. INT. CL. 9.
- SSJ DEVELOPMENT LLC, BROOKLYN, NY:
3,314,946, MULTIPLE CLASS, INT. CLS. 35 AND 37.
- SSM CARDINAL GLENNON CHILDREN'S HOSPITAL, ST. LOUIS, MO:
3,313,979, INT. CL. 41.
- SSP ENTERPRISES - AYS, LLC, GLENDALE, AZ:
3,310,302, PUB. 7-31-2007. INT. CL. 18.
- ST. CHARLES TRADING, INC., BATAVIA, IL:
3,314,253, MULTIPLE CLASS, INT. CLS. 29 AND 30.
- ST. LOUIS COMMUNITY CREDIT UNION, ST. LOUIS, MO:
3,314,894, INT. CL. 36.
- ST. MARY'S HEALTH CARE SYSTEM, INC., ATHENS, GA:
3,313,003, INT. CL. 44.
- ST. VINCENT - ST. MARY HIGH SCHOOL, AKRON, OH:
3,312,196, PUB. 7-31-2007. MULTIPLE CLASS, INT. CLS. 16, 25 AND 41.
3,312,198, PUB. 7-31-2007. MULTIPLE CLASS, INT. CLS. 16 AND 41.
- STACCATO COMMUNICATIONS, INC., SAN DIEGO, CA:
3,313,550, INT. CL. 9.
- STAMOR CORPORATION, NORFOLK, VA:
3,314,088, INT. CL. 35.
- STAMPINGSIMULATION.COM PTY LTD, DALBY, AUSTRALIA:
3,311,617, PUB. 7-31-2007. INT. CL. 42.
- STAMPINGSIMULATION.COM PTY LTD., DALBY, AUSTRALIA:
3,311,616, PUB. 7-31-2007. INT. CL. 42.
- STANDARD CABLE, RANCHO SANTA MARGARITA, CA, DBA CONDUCTIVE CABLE:
3,311,161, PUB. 7-31-2007. INT. CL. 9.
- STANDARD FORMS, INC., NORFOLK, VA TO WORKFLOW SOLUTIONS LLC, NORFOLK, VA:
2,020,703, CANC. INT. CL. 42.
- STANDARD FURNITURE MANUFACTURING COMPANY, INC., BAY MINETTE, AL:
3,310,334, PUB. 7-31-2007. INT. CL. 20.
3,310,335, PUB. 7-31-2007. INT. CL. 20.
3,310,336, PUB. 7-31-2007. INT. CL. 20.
- STANDARD INSURANCE COMPANY, PORTLAND, OR:
2,100,939. REN. 9-7-07. INT. CL. 36.
- STANDARD MOTOR PRODUCTS, INC., LEWISVILLE, TX:
3,310,318, PUB. 7-31-2007. INT. CL. 7.
3,310,319, PUB. 7-31-2007. INT. CL. 7.
3,310,320, PUB. 7-31-2007. INT. CL. 7.
3,310,321, PUB. 7-31-2007. INT. CL. 7.
- STANDARD SUPPLY & EQUIPMENT CO., INC., BALTIMORE, MD:
2,020,734, CANC. INT. CL. 20.
- STANFORD FINANCIAL GROUP COMPANY, HOUSTON, TX:
3,312,270, PUB. 7-31-2007. INT. CL. 39.
- STANICO, INC.:
1,419,381, CANC. INT. CL. 30.
- STANLEY MUSEUM, INC., KINGFIELD, ME:
3,311,653, PUB. 7-31-2007. MULTIPLE CLASS, INT. CLS. 14, 16 AND 41.
- STANNARD, JOHN, CLEARWATER, FL:
3,314,148, INT. CL. 15.
- STAPLES THE OFFICE SUPERSTORE, LLC, FRAMINGHAM, MA, STAPLES, INC., NEWTON, MA:
1,459,182. REN. 9-10-07. MULTIPLE CLASS, INT. CLS. 16 AND 42.
- STAPLES THE OFFICE SUPERSTORE, LLC, FRAMINGHAM, MA:
3,086,467, COR. INT. CL. 35.
3,313,497, INT. CL. 35.
- STAR COMMUNITY PUBLISHING GROUP, LLC, HICKSVILLE, NY, NEWPORT MEDIA, INC., HICKSVILLE, NY:
2,099,752. REN. 9-9-07. INT. CL. 35.
- STAR HEADLIGHT & LANTERN CO., INC., AVON, NY:
3,311,922, PUB. 6-26-2007. INT. CL. 9.
- STAR LINEN INC., MOORESTOWN, NJ:
2,409,718, CANC. INT. CL. 24.
- STAR TELEVISION PRODUCTIONS LIMITED, ROAD TOWN, TORTOLA, BR.VIRGIN ISLANDS:
3,312,988, MULTIPLE CLASS, INT. CLS. 38 AND 41.
- STARBUCKS U.S. BRANDS, LLC, MINDEN, NV, STARBUCKS CORPORATION, SEATTLE, WA, DBA STARBUCKS COFFEE COMPANY:
2,091,940. REN. 9-7-07. INT. CL. 30.
2,091,941. REN. 9-9-07. INT. CL. 30.
- STARDEM COUNTDOWN PRODUCTS, INC., PHOENIX, AZ:
2,020,182, CANC. INT. CL. 9.

- STARR, DWAIN S, HESSEL, MI AND STARR, SHARON M, HESSEL, MI AND STARR, BRITNEY L, HESSEL, MI: 3,313,941, INT. CL. 29.
- STATE BOARD OF REGENTS, UNIVERSITY OF OKLAHOMA OKLAHOMA CLIMATOLOGICAL SURVEY, NORMAN, OK: 2,410,256, CANC. INT. CL. 9.
- STATE INDUSTRIAL PRODUCTS CORPORATION, CLEVELAND, OH: 1,441,708, REN. 9-13-07, INT. CL. 3.
- STATE INDUSTRIAL PRODUCTS CORPORATION, CLEVELAND, OH, STATE CHEMICAL MANUFACTURING COMPANY, THE, CLEVELAND, OH: 2,073,457, REN. 9-13-07, INT. CL. 3.
- STATE INDUSTRIAL PRODUCTS CORPORATION, CLEVELAND, OH: 2,409,841, CANC. INT. CL. 21.
- STATUS PRO MASCHINENMESSTECHNIK GMBH, BOCHUM, FED REP GERMANY: 3,312,476, PUB. 7-31-2007, MULTIPLE CLASS, INT. CLS. 9 AND 42.
- STATUS, LLC, LENEXA, KS: 3,311,145, PUB. 7-31-2007, MULTIPLE CLASS, INT. CLS. 14, 18, 25 AND 35.
- STEAG C.V.D. SYSTEMS LTD., MIGDAL HAERIEK, ISRAEL: 2,410,982, CANC. INT. CL. 9.
- STEEL-GROOMING FOR MEN, INC., NAPLES, FL: 3,314,615, INT. CL. 44.
- STEELCASE DEVELOPMENT CORPORATION, CALEDONIA, MI: 3,310,549, PUB. 7-31-2007, MULTIPLE CLASS, INT. CLS. 9, 37 AND 42. 3,314,383, INT. CL. 20.
- STEINBERGER, BRIAN S., MERRITT ISLAND, FL: 2,166,423, REN. 9-7-07, INT. CL. 42.
- STEINER MARKS LIMITED, NASSAU, BAHAMAS: 3,311,680, PUB. 10-11-2005, INT. CL. 44.
- STEINY AND COMPANY, INC., LOS ANGELES, CA: 1,075,210, REN. 9-11-07, INT. CL. 37.
- STELOR PRODUCTIONS, LLC, DARNESTOWN, MD: 3,313,804, MULTIPLE CLASS, INT. CLS. 9 AND 42.
- STEMCO LP, LONGVIEW, TX: 1,418,935, CANC. MULTIPLE CLASS, INT. CLS. 7 AND 9.
- STENTOR MUSIC CO. LTD., SURREY, UNITED KINGDOM: 3,311,931, PUB. 7-31-2007, INT. CL. 15.
- STEP-BY-STEP SYSTEMS, LLC, MINNEAPOLIS, MN: 2,411,023, CANC. INT. CL. 19.
- STERILIZING PACKAGING COMPANY OF L.A. LTD., THE, TEFEN, WESTERN GALILEE, ISRAEL: 2,091,696, REN. 9-13-07, INT. CL. 16.
- STERLING JEWELERS INC., AKRON, OH: 3,313,172, INT. CL. 14.
- STERLING LIFE INSURANCE COMPANY, GLENVIEW, IL: 3,311,122, PUB. 7-31-2007, INT. CL. 36. 3,311,123, PUB. 7-31-2007, INT. CL. 36.
- STERLING MEDIVATIONS, INC., NORCROSS, GA, DBA SIMPLECHOICE: 3,313,622, INT. CL. 10.
- STERLING SERVICES GROUP, L.C., EUDORA, KS: 3,313,764, MULTIPLE CLASS, INT. CLS. 35 AND 37.
- STICH, JOHN L., MESA, AZ, DBA TRUSTEE OF THE STICH FAMILY TRUST: 3,311,254, PUB. 7-31-2007, INT. CL. 11.
- STIEFLER, PAULE, GRAND JUNCTION, CO: 3,310,910, PUB. 7-31-2007, INT. CL. 44.
- STILES, COLLEEN, K., COLORADO SPRINGS, CO: 3,314,621, INT. CL. 12.
- STIRRINGS, LLC, FALL RIVER, MA: 3,311,267, PUB. 7-31-2007, INT. CL. 30.
- STOCKYARDS HOTEL, LLC, FORT WORTH, TX, AMERICAN FOOD CLASSICS, INC., FORT WORTH, TX: 2,014,792, REN. 9-12-07, INT. CL. 32.
- STOKKE AS, NORWAY: 3,312,800, PUB. 7-31-2007, INT. CL. 20.
- STONE CREEK CREATIONS, INC., MOUNT DORA, FL: 3,312,557, PUB. 7-31-2007, INT. CL. 18.
- STONE SOLUTIONS, INC., AUSTIN, TX: 2,095,033, REN. 9-7-07, INT. CL. 19.
- STONEWRITER, LLC, CALISTOGA, CA: 3,314,659, INT. CL. 33.
- STORA ENSO OYJ, HELSINKI, FINLAND: 3,311,876, PUB. 7-31-2007, INT. CL. 16.
- STORAGE CONDOS, L.L.C., BILLINGS, MT: 3,314,522, INT. CL. 36.
- STORM PRODUCTS CO., HINSDALE, IL: 1,419,019, CANC. INT. CL. 9.
- STOUFFER CORPORATION, THE, SOLON, OH TO SOCIETE DES PRODUITS NESTLE S.A., 1800 VEVEY, SWITZERLAND: 2,020,145, CANC. MULTIPLE CLASS, INT. CLS. 29 AND 30.
- STRACCIA, PIETRO, SAN FRANCISCO, CA AND LUPINACCI, PAOLO GIORDANO, SAN FRANCISCO, CA: 3,314,207, INT. CL. 41.
- STRAND LIFE SCIENCES PRIVATE LIMITED, KARNATAKA, INDIA: 3,311,791, PUB. 7-31-2007, MULTIPLE CLASS, INT. CLS. 9 AND 16.
- STRAPACK CORPORATION, TOKYO, JAPAN: 2,096,814, REN. 9-13-07, INT. CL. 7.
- STRATAGENE CALIFORNIA, LA JOLLA, CA: 2,409,831, CANC. INT. CL. 42.
- STRATATECH CORPORATION, MADISON, WI: 3,312,981, MULTIPLE CLASS, INT. CLS. 1 AND 5.
- STRATEGIC HEALTHCARE INITIATIVES, INC., ADDISON, TX: 3,313,071, MULTIPLE CLASS, INT. CLS. 41 AND 44.
- STRATEGIC SPORTS GROUP, INC., NEW YORK, NY, DBA STRATEGIC: 3,312,077, PUB. 7-31-2007, INT. CL. 35.
- STRATEGICOM, INC., BOZEMAN, MT: 3,314,206, MULTIPLE CLASS, INT. CLS. 35, 41 AND 42.
- STRATHMORE PARTNERS LP, CONCORD, NH: 3,313,025, MULTIPLE CLASS, INT. CLS. 29 AND 30.
- STRATUM GLOBAL, INC., LITTLETON, CO: 3,167,825, COR. INT. CL. 9.
- STRAW HAT COOPERATIVE CORPORATION, SAN RAMON, CA: 3,312,655, PUB. 7-31-2007, INT. CL. 30.
- STREAM PROCESSORS, INC., SUNNYVALE, CA: 3,311,171, PUB. 7-31-2007, INT. CL. 9.
- STRICTLY STERLING, INC., NEW YORK, NY: 3,310,886, PUB. 7-31-2007, INT. CL. 14. 3,310,890, PUB. 7-31-2007, INT. CL. 14.
- STRUCTURAL SYSTEMS, INC., GAITHERSBURG, MD: 2,410,915, CANC. MULTIPLE CLASS, INT. CLS. 37 AND 42.
- STUART LEVINE & ASSOCIATES, LLC, JERICHO, NY: 3,313,533, MULTIPLE CLASS, INT. CLS. 16 AND 41.
- STUDIO CROSSROADS, INC., SUGAR LAND, TX: 3,313,745, INT. CL. 21.
- STYLE INTERNATIONAL SOURCE, LLC, TORRENCE, CA: 3,028,542, CANC. INT. CL. 25.
- STYLE INTERNATIONAL SOURCE, LLC, TORRANCE, CA: 3,313,686, INT. CL. 25.
- STYLING TECHNOLOGY CORPORATION, SCOTTSDALE, AZ: 2,410,002, CANC. INT. CL. 3.
- STYLORS, INC., JACKSONVILLE, FL AND JESSE BRIGGS & BLANCA F. BRIGGS, FORT LAUDERDALE, FL: 3,311,570, PUB. 7-31-2007, INT. CL. 3.
- SUBLIMATION FACTORY, INC., LOS ANGELES, CA: 3,314,569, INT. CL. 25.
- SUBSIDE SPORTS LTD, CHAGFORD, DEVON, ENGLAND: 3,312,140, PUB. 7-31-2007, INT. CL. 35.
- SUBURBAN PROPANE, L.P., WHIPPANY, NJ: 3,310,566, PUB. 7-31-2007, MULTIPLE CLASS, INT. CLS. 4, 35, 37 AND 39. 3,310,567, PUB. 7-31-2007, INT. CL. 4. 3,310,575, PUB. 7-31-2007, MULTIPLE CLASS, INT. CLS. 4, 37 AND 39. 3,313,128, MULTIPLE CLASS, INT. CLS. 35 AND 39.
- SUCCEED GROUP INC., CITY OF INDUSTRY, CA: 2,410,866, CANC. INT. CL. 9.

- SUCESORES DE JOSE JESUS RESTREPO Y CIA S.A., MANIZALES, COLOMBIA, DBA CASA LUKER S.A.: 3,310,215, PUB. 7-31-2007. INT. CL. 30.
- SUDZZFX, INC., OXNARD, CA: 3,314,014, INT. CL. 3.
- SULCUS COMPUTER CORPORATION, GREENSBURG, PA: 1,418,987, CANC. INT. CL. 9.
- SULLIVAN AUTOMOTIVE GROUP, SANTA MONICA, CA: 3,310,327, PUB. 7-31-2007. INT. CL. 35.
- SUMITOMO CHEMICAL CO., LTD., TOKYO, JAPAN: 1,039,038. REN. 9-13-07. INT. CL. 2.
- SUMMER THE SURF GIRL LIMITED, COVENTRY, UNITED KINGDOM: 3,312,739, PUB. 7-31-2007. MULTIPLE CLASS, INT. CLS. 9, 16, 21, 25 AND 28.
- SUMMIT FOODS, INC., ST. PAUL, MN: 3,313,009, INT. CL. 30.
- SUMMIT LABORATORIES, INC., HARVEY, IL: 3,313,980, MULTIPLE CLASS, INT. CLS. 3 AND 5.
- SUMMIT PARTNERS LP, BOSTON, MA: 3,312,765, PUB. 7-31-2007. INT. CL. 36.
3,312,766, PUB. 7-31-2007. INT. CL. 36.
3,312,767, PUB. 7-31-2007. INT. CL. 36.
3,312,768, PUB. 7-31-2007. INT. CL. 36.
3,312,769, PUB. 7-31-2007. INT. CL. 36.
- SUMMIT SPORTS, INC., FORT WAYNE, IN: 3,313,197, INT. CL. 41.
- SUN BLOOM PARTICIPACOES S/C LTDA., JUNDIAI/SP, BRAZIL: 3,313,416, INT. CL. 25.
- SUN CHEMICAL CORPORATION, PARSIPPANY, NJ: 3,313,688, INT. CL. 2.
3,314,060, INT. CL. 2.
3,314,277, INT. CL. 2.
- SUN GREEN INTERNATIONAL, INC., RICHARDSON, TX: 3,314,869, INT. CL. 5.
- SUN OPTICS, INC., SALT LAKE CITY, UT: 3,314,680, INT. CL. 9.
- SUN SEED COMPANY, INC., BOWLING GREEN, OH: 3,314,250, INT. CL. 31.
- SUN-MAID GROWERS OF CALIFORNIA, KINGSBURG, CA: 3,314,026, INT. CL. 29.
3,314,027, INT. CL. 29.
- SUNDANCE ENTERPRISES, INC., SUNDANCE, UT: 3,312,679, PUB. 7-31-2007. INT. CL. 24.
- SUNKIST GROWERS, INC., SHERMAN OAKS, CA: 3,313,475, INT. CL. 41.
- SUNMARKS, LLC, CLAYMONT, DE: 3,312,447, PUB. 7-31-2007. INT. CL. 37.
- SUNNYWIPES PTY LTD, AUSTRALIA: 3,312,776, PUB. 7-31-2007. INT. CL. 21.
- SUNRISE CAPITAL, INC., HONOLULU, HI: 3,312,111, PUB. 7-31-2007. INT. CL. 31.
- SUNRISE SENIOR LIVING, INC., MCLEAN, VA: 3,313,615, MULTIPLE CLASS, INT. CLS. 35, 36, 43 AND 44.
- SUNSET HEALTH PRODUCTS, INC., LOS ANGELES, CA: 3,310,791, PUB. 7-31-2007. INT. CL. 5.
- SUNSHINE ACE HARDWARE, INC., NAPLES, FL: 3,313,418, INT. CL. 35.
- SUNSTONE FINANCIAL GROUP, INC., MILWAUKEE, WI: 2,410,283, CANC. MULTIPLE CLASS, INT. CLS. 35 AND 42.
- SUNSTONE IMPORTS, INC., ST. LOUIS, MO: 3,311,369, PUB. 7-31-2007. INT. CL. 14.
- SUNTORY FLOWERS LIMITED, JAPAN: 3,312,961, PUB. 7-31-2007. INT. CL. 31.
- SUNTORY FLOWERS LIMITED, TOKYO, JAPAN: 3,313,063, INT. CL. 31.
- SUNTRUST BANKS, INC., ORLANDO, FL: 3,311,562, PUB. 7-31-2007. INT. CL. 36.
3,314,874, MULTIPLE CLASS, INT. CLS. 35 AND 36.
3,314,875, MULTIPLE CLASS, INT. CLS. 35 AND 36.
- SUPER BAKERY, INCORPORATED, PITTSBURGH, PA: 3,312,696, PUB. 7-31-2007. INT. CL. 30.
- SUPER PARX, SAN JUAN CAPISTRANO, CA: 3,311,155, PUB. 7-10-2007. INT. CL. 35.
- SUPERBLOCK, LLC, CRYSTAL LAKE, DE: 3,310,961, PUB. 7-31-2007. INT. CL. 42.
- SUPERCUE CORPORATION, SEMINOLE, FL: 2,410,208, CANC. INT. CL. 28.
- SUPERIOR CAPITAL PARTNERS LLC, DETROIT, MI: 3,314,537, INT. CL. 36.
- SUPERIOR SPECIALTIES, INC., APPLETON, WI: 3,310,590, PUB. 7-31-2007. MULTIPLE CLASS, INT. CLS. 35 AND 40.
- SUPERSKYROCKET, LLC, CARLSBAD, CA: 2,410,012, CANC. INT. CL. 40.
- SUPRE, INC., DALLAS, TX: 3,313,309, INT. CL. 3.
- SUPRESS PRODUCTS LLC, SAN RAFAEL, CA: 3,313,742, MULTIPLE CLASS, INT. CLS. 6 AND 19.
- SURE DRIVE USA, SOUTH SAN FRANCISCO, CA: 2,410,396, CANC. INT. CL. 7.
- SURF CITY ANIMAL RESPONSE TEAM (SCART), HUNTINGTON BEACH, CA: 3,310,349, PUB. 7-31-2007. INT. CL. 45.
- SURF CITY GARAGE, HUNTINGTON BEACH, CA: 3,312,430, PUB. 2-20-2007. INT. CL. 3.
- SURGIPATH MEDICAL INDUSTRIES, INC., RICHMOND, IL: 3,311,615, PUB. 7-31-2007. INT. CL. 1.
- SURPRISE VILLAGE COMPANY, L.L.C., PHOENIX, AZ: 2,020,428, CANC. INT. CL. 37.
- SUSIE AGA, ALPHARETTA, GA: 3,311,142, PUB. 7-31-2007. INT. CL. 43.
- SUSMAN, ANDREW, NEW YORK, NY: 2,411,007, CANC. INT. CL. 42.
- SUTTLE, RENE, WILLIAMSBURG, VA: 2,410,565, CANC. INT. CL. 35.
- SUTTON, JOSEPH, WEST HOLLYWOOD, CA: 3,313,211, INT. CL. 41.
- SUZANNE M. THOMAS, LONG BEACH, CA: 3,312,676, PUB. 7-31-2007. INT. CL. 41.
- SUZUKI MOTOR CORPORATION (SUZUKI KABUSHIKI KAISHA), SHIZUOKA-KEN, JAPAN: 2,724,499, COR. MULTIPLE CLASS, INT. CLS. 6, 16, 18, 24 AND 25.
- SVO TRADEMARK, INC., ORLANDO, FL, VISTANA RESORT DEVELOPMENT, INC., ORLANDO, FL: 1,461,460. REN. 9-13-07. INT. CL. 42.
- SWANGIN, TERICA LYNN, LUMBERTON, NJ: 3,314,700, INT. CL. 42.
- SWANNER-RENNER, JACKIE J., BAKER, MT: 3,314,967, INT. CL. 35.
- SWEDEX INTERNATIONAL, HESPERIA, CA: 2,411,270, CANC. INT. CL. 20.
- SWEEPSTER ATTACHMENTS, LLC, CEDAR RAPIDS, IA: 1,450,367. REN. 9-7-07. INT. CL. 7.
- SWEET & SASSY IP, LLC, SOUTHLAKE, TX: 3,310,757, PUB. 7-10-2007. MULTIPLE CLASS, INT. CLS. 35, 41 AND 44.
- SWEET MAMA JANISSE, EUREKA, CA: 3,311,836, PUB. 7-31-2007. INT. CL. 30.
- SWEET SALVATION, LLC, TEMPE, AZ: 3,312,039, PUB. 7-31-2007. INT. CL. 30.
- SWEETSKINZ INC., BALA CYNWYD, PA: 3,311,233, PUB. 7-31-2007. INT. CL. 12.
- SWIFT TRANSPORTATION CO., INC., PHOENIX, AZ: 3,311,758, PUB. 7-31-2007. INT. CL. 39.
- SWIMC, INC., WILMINGTON, DE, SHERWIN-WILLIAMS COMPANY, THE, CLEVELAND, OH: 2,091,731. REN. 9-7-07. INT. CL. 2.
2,134,855. REN. 9-13-07. INT. CL. 2.
- SWIMC, INC., WILMINGTON, DE: 2,411,016, CANC. INT. CL. 16.
3,310,596, PUB. 7-31-2007. INT. CL. 16.
- SWINGER, TRUYEN, NEW YORK, NY: 3,313,785, INT. CL. 16.
- SWINMURN VENTURES LLC, HENDERSON, NV: 3,313,547, INT. CL. 41.
- SYLA LLC, NEW YORK, NY: 3,314,774, INT. CL. 25.

- SYLVIA'S SECRETVITAMIN & NUTRITIONAL SUPPLEMENTS, LTD, CHESTNUT RIDGE, NY:
3,314,501, INT. CL. 5.
- SYMANTEC CORPORATION, CUPERTINO, CA:
3,314,016, INT. CL. 9.
3,314,282, INT. CL. 9.
- SYMATRIX TECHNOLOGY, INC., PORTLAND, OR:
2,410,032, CANC. MULTIPLE CLASS, INT. CLS. 9, 35 AND 42.
- SYNAPTA, PALO ALTO, CA:
2,410,630, CANC. INT. CL. 42.
- SYNCOM INTERNATIONAL L.C., SCOTTSDALE, AZ:
2,020,092, CANC. INT. CL. 38.
- SYNCSORT INCORPORATED, WOODCLIFF LAKE, NJ:
2,023,810, REN. 9-10-07. INT. CL. 9.
- SYNDEL LABORATORIES LTD., QUALICUM BEACH, B.C., CANADA:
2,141,628, REN. 9-12-07. INT. CL. 5.
- SYNERGY COMPUTING BUSINESS GROUP, INC., LAGUNA HILLS, CA:
3,311,923, PUB. 7-31-2007. INT. CL. 35.
- SYNGENTA LIMITED, SURREY, UNITED KINGDOM:
3,313,428, INT. CL. 5.
- SYNTHETIC LUBRICANTS, INC, GREENVILLE, MI:
2,410,547, CANC. INT. CL. 40.
- SYRVET, INC., WAUKEE, IA:
3,313,692, INT. CL. 10.
- SYSCO CORPORATION, HOUSTON, TX:
2,086,222, REN. 9-7-07. MULTIPLE CLASS, INT. CLS. 25, 29 AND 30.
2,089,907, REN. 9-10-07. INT. CL. 29.
2,090,173, REN. 9-7-07. MULTIPLE CLASS, INT. CLS. 29 AND 30.
- SYSTAR, INC., GREENBELT, MD:
1,455,039, REN. 9-13-07. INT. CL. 9.
- SYSTEM DYNAMICS, INC., SCOTTSDALE, AZ:
2,272,982, COR. INT. CL. 9.
- SYSTEMAX, INC., PORT WASHINGTON, NY:
3,310,244, PUB. 7-31-2007. INT. CL. 9.
3,310,425, PUB. 7-31-2007. MULTIPLE CLASS, INT. CLS. 8 AND 9.
- SYSTEMS COMPLETE, LLC, SUNNYVALE, CA:
2,410,567, CANC. INT. CL. 42.
- SYSTRAN FINANCIAL SERVICES CORPORATION, LAKE OSWEGO, OR:
3,314,043, INT. CL. 36.
- SYYP, CHRISTOPHER J. PLANO, TX:
3,314,294, INT. CL. 25.
- T. ROWE PRICE GROUP, INC., BALTIMORE, MD:
3,313,180, INT. CL. 36.
- T-INK, INC., NEW YORK, NY:
3,313,365, INT. CL. 28.
- T-SQUARE EXPRESS, INC., MIAMI, FL:
3,313,835, MULTIPLE CLASS, INT. CLS. 16, 40, 41 AND 42.
- TA CHEN INTERNATIONAL, INC., LONG BEACH, CA:
3,310,303, PUB. 7-10-2007. INT. CL. 19.
- TACHIKARA U.S.A., INC., MCCARRAN, NV, ARCH BILLMIRE CO., INC., SPARKS, NV:
1,469,180, REN. 9-10-07. INT. CL. 28.
- TACIT NETWORKS, INC., SOUTH PLAINFIELD, NJ:
3,127,863, CANC. INT. CL. 9.
- TACK, ROBERT, WASHINGTON, DC:
3,310,538, PUB. 7-31-2007. MULTIPLE CLASS, INT. CLS. 35 AND 36.
- TAH CHUNG STEEL CORPORATION, TAICHUNG, TAIWAN:
3,311,940, PUB. 7-31-2007. INT. CL. 6.
- TAHEEBO JAPAN KABUSHIKI KAISHA, OSAKA 541-0048, JAPAN:
3,312,710, PUB. 7-31-2007. MULTIPLE CLASS, INT. CLS. 29, 30 AND 32.
- TAIHUANG CHANG, TAICHUNG CITY, TAIWAN:
3,310,861, PUB. 7-31-2007. INT. CL. 1.
- TAILORED TRAVEL, L.L.C., OMAHA, NE:
3,311,903, PUB. 7-31-2007. INT. CL. 39.
- TAIWAN PAIHO LIMITED, HO MEI TOWN, CHANGHUA HSIEN, TAIWAN:
3,313,141, INT. CL. 17.
- TAKAMIYA, DAVID, HONOLULU, HI, DBA DAVID T OF HAWAII:
2,110,868, REN. 9-7-07. INT. CL. 28.
- TAKARA U.S.A. CORPORATION, NEW YORK, NY:
2,411,280, CANC. INT. CL. 14.
- TAKKLE, INC., NEW YORK, NY:
3,314,434, MULTIPLE CLASS, INT. CLS. 38, 41 AND 45.
- TALARIS CORPORATION, SAN MATEO, CA:
3,313,058, INT. CL. 9.
- TALES OF WONDER, INC., ROSWELL, GA:
2,098,178, REN. 9-9-07. INT. CL. 16.
- TALINDA AND COMPANY, LLC, COSTA MESA, CA:
3,310,635, PUB. 7-31-2007. INT. CL. 25.
- TALISKER MOUNTAIN INCORPORATED, PARK CITY, UT:
3,310,417, PUB. 7-31-2007. INT. CL. 37.
3,310,421, PUB. 7-31-2007. INT. CL. 41.
- TALK CITY, INC., CAMPBELL, CA:
2,410,936, CANC. INT. CL. 35.
- TALKSOFT, PRINCETON, NJ:
2,411,358, CANC. INT. CL. 9.
- TALLEY, HOWARD C., BOYDE, MD:
3,313,699, INT. CL. 45.
- TALTECH LIMITED, TORTOLA, BR. VIRGIN ISLANDS:
3,312,067, PUB. 7-31-2007. INT. CL. 25.
- TANI, KANARI, ANAHEIM, CA:
2,410,720, CANC. INT. CL. 10.
- TANIMURA & ANTLE, INC., SALINAS, CA:
2,411,181, CANC. INT. CL. 31.
- TARA, LTD., SCOTTSDALE, AZ:
2,410,897, CANC. MULTIPLE CLASS, INT. CLS. 21 AND 26.
- TARGET BRANDS, INC., MINNEAPOLIS, MN, DAYTON HUDSON CORPORATION, MINNEAPOLIS, MN:
2,091,444, REN. 9-9-07. INT. CL. 42.
- TARGET BRANDS, INC., MINNEAPOLIS, MN:
3,311,962, PUB. 7-31-2007. MULTIPLE CLASS, INT. CLS. 16 AND 35.
3,314,031, INT. CL. 3.
- TARGET TRAINING INTERNATIONAL, INC., SCOTTSDALE, AZ:
3,311,667, PUB. 7-31-2007. INT. CL. 35.
- TARGETED MARKETING SOLUTIONS, INC., WALTHAM, MA TO IMAGITAS, INC., WALTHAM, MA:
2,020,780, CANC. INT. CL. 16.
- TARGETMATCH LTD., TEL AVIV 65787, ISRAEL:
2,411,548, CANC. INT. CL. 42.
- TARKETT INC., FARNHAM, QUEBEC:
2,409,943, CANC. INT. CL. 27.
- TARKETT INC., FARNHAM, CANADA:
3,310,717, PUB. 7-31-2007. MULTIPLE CLASS, INT. CLS. 19 AND 27.
- TASK FORCE TIPS, INC., VALPARAISO, IN:
1,468,151, REN. 9-13-07. INT. CL. 9.
- TATONKA CAPITAL CORPORATION, DENVER, CO:
3,312,510, PUB. 7-31-2007. INT. CL. 36.
- TAYLOR NUTRITIONAL PRODUCTS, SAN FRANCISCO, CA:
3,311,211, PUB. 7-31-2007. INT. CL. 3.
- TAYLOR, ADAM S., FALMOUTH, ME:
3,314,018, INT. CL. 41.
- TAYLOR, SARA, SAN FRANCISCO, CA:
3,311,197, PUB. 7-10-2007. INT. CL. 5.
- TB PROPRIETARY CORP., WILMINGTON, DE:
1,453,539, REN. 9-9-07. INT. CL. 37.
- TBC CORPORATION, MEMPHIS, TN:
1,419,104, CANC. MULTIPLE CLASS, INT. CLS. 12 AND 17.
- TC LICENSE, LTD., HUMMELSTOWN, PA:
3,313,635, MULTIPLE CLASS, INT. CLS. 9, 35 AND 39.
- TCI ACQUISITION CORP., NEW YORK, NY:
3,314,638, INT. CL. 9.
- TCM CORPORATION, OSAKA, JAPAN, TOYO UMPANKI COMPANY, LIMITED, OSAKA, JAPAN:
2,107,911, REN. 9-10-07. MULTIPLE CLASS, INT. CLS. 7

- AND 12.
 TCSP, INC., IRVINE, CA:
 3,312,190, PUB. 7-31-2007. INT. CL. 35.
 TD BANKNORTH, INC., PORTLAND, ME:
 3,312,558, PUB. 7-31-2007. MULTIPLE CLASS, INT. CLS.
 16 AND 36.
 TEACH ME PLEASE, DOG SERIES, INC., BEAVERTON, OR:
 2,410,851, CANC. INT. CL. 41.
 TEAM SD, INC., ALHAMBRA, CA:
 3,311,575, PUB. 7-31-2007. INT. CL. 13.
 3,311,576, PUB. 7-31-2007. INT. CL. 13.
 TECHLITE DESIGNS, GRAFTON, MA:
 3,313,812, INT. CL. 11.
 TECHNI AUTOMATION PTY LTD, CAMPBELLFIELD VIC
 3061, AUSTRALIA:
 3,313,746, INT. CL. 9.
 TECHNICAL COMMUNICATIONS CORPORATION, CON-
 CORD, MA:
 3,310,808, PUB. 7-31-2007. INT. CL. 9.
 TECHNIQUE TUESDAY, LLC, BEAVERTON, OR:
 3,311,446, PUB. 7-31-2007. MULTIPLE CLASS, INT. CLS. 3
 AND 16.
 TECHNOFORM CAPRANO UND; BRUNNHOFER GMBH &
 CO. KG, FED REP GERMANY:
 3,312,801, PUB. 7-31-2007. INT. CL. 17.
 TECHNOLOGY BRIDGE, INC., BOSTON, MA:
 2,409,891, CANC. INT. CL. 42.
 TECKXCO, INC, KILDEER, IL:
 3,311,378, PUB. 7-31-2007. INT. CL. 28.
 TED NUGENT'S WORLD BOWHUNTERS, INCORPO-
 RATED, JACKSON, MI:
 1,875,605, COR. INT. CL. 41.
 TED PROHASKA, INC., DALLAS, TX:
 2,020,815, CANC. INT. CL. 37.
 TEDESCO, GARY W., CONNELLSVILLE, PA:
 2,410,071, CANC. INT. CL. 9.
 TEE, TRACEY S., LOS ANGELES, CA:
 3,312,151, PUB. 7-31-2007. INT. CL. 35.
 TEEL ENTERPRISES, INC, DALLAS, TX:
 3,313,118, INT. CL. 36.
 TEKSYSTEMS, INC., HANOVER, MD:
 3,313,991, INT. CL. 35.
 TELBOOK INTERNATIONAL, INC., SOUTHAMPTON, NY:
 2,095,299, REN. 9-8-07. INT. CL. 16.
 TELEBRANDS CORPORATION, FAIRFIELD, NJ:
 3,314,941, INT. CL. 28.
 TELECOM ITALIA S.P.A., ITALY:
 3,312,742, PUB. 7-31-2007. MULTIPLE CLASS, INT. CLS.
 9, 38 AND 41.
 TELEDYNE INDUSTRIES, INC., LOS ANGELES, CA:
 1,419,065, CANC. INT. CL. 10.
 TELEDYNE ISCO, INC., LINCOLN, NE:
 1,454,002, REN. 9-8-07. INT. CL. 9.
 TELEDYNE TECHNOLOGIES INCORPORATED, LOS AN-
 GELES, CA:
 2,411,052, CANC. INT. CL. 9.
 TELEMAC CORPORATION, LOS ANGELES, CA, TELEMAC
 CELLULAR CORPORATION, DANVILLE, CA:
 2,085,835, REN. 9-7-07. INT. CL. 9.
 TELENOR ASA, 1331 FORNEBU, NORWAY, TELEVERKET,
 N-0130 OSLO, NORWAY:
 2,086,746, REN. 9-11-07. INT. CL. 38.
 TELEPO AB, SWEDEN:
 3,312,901, PUB. 7-31-2007. MULTIPLE CLASS, INT. CLS.
 9, 38 AND 42.
 TELESNAP GMBH, 70565 STUTTGART, FED REP GER-
 MANY:
 2,409,817, CANC. INT. CL. 9.
 TELLKAMP SYSTEMS, INC., SANTA FE SPRINGS, CA AND
 TREVISAN COMETAL, VERONA, ITALY:
 3,314,297, INT. CL. 7.
 TELSCO INDUSTRIES, INC., GARLAND, TX:
 3,312,544, PUB. 7-31-2007. INT. CL. 6.
 TELSEY ADVISORY GROUP LLC, NEW YORK, NY:
 3,314,336, MULTIPLE CLASS, INT. CLS. 9, 16, 35, 36 AND
 41.
 TEMBIZI, INC., WEST NEWBURY, MA:
 3,313,123, INT. CL. 39.
 TEMECULA VALLEY WINEGROWERS ASSOCIATION, TE-
 MECULA, CA:
 3,311,399, PUB. 7-31-2007. INT. CL. 35.
 TEMPLATE CONSOLIDATED PRESS, LLC, PHOENIX, AZ:
 3,310,632, PUB. 7-31-2007. INT. CL. 35.
 TENNESSEE MAT COMPANY, INC., NASHVILLE, TN:
 2,410,668, CANC. INT. CL. 27.
 TENNESSEE STATE BANK, PIGEON FORGE, TN:
 3,312,695, PUB. 7-31-2007. INT. CL. 36.
 TEPLY, DARRIN B., GRAND JUNCTION, CO:
 2,410,171, CANC. INT. CL. 16.
 TEQUILA CUERVO LA ROJENA, S.A. DE C.V., CODIGO,
 MEXICO:
 3,312,495, PUB. 7-31-2007. INT. CL. 33.
 TEQUILA INSIGNIA, S.A. DE C.V., MÉXICO, DF, MEXICO:
 3,310,526, PUB. 6-5-2007. INT. CL. 33.
 TEQUILAS RANCHO VIEJO SA DE CV, TEPATITLAN,
 MEXICO:
 3,314,857, INT. CL. 33.
 TERAGON CONSULTING, ROCKVILLE, MD:
 2,410,888, CANC. INT. CL. 42.
 TERCET CAPITAL, LLC, SMITHFIELD, RI:
 3,314,566, INT. CL. 36.
 TERCICA , INC., BRISBANE, CA:
 3,313,013, INT. CL. 42.
 TERME BANCORP, INC., SUMMIT, IL:
 3,311,251, PUB. 7-31-2007. INT. CL. 36.
 TEROG MANUFACTURING COMPANY, STEPHEN, MN:
 1,469,603, REN. 9-13-07. INT. CL. 7.
 TERRA NETWORKS, S.A., 28224 POZUELO DE ALARCON
 (MADRID), SPAIN:
 3,310,202, PUB. 7-31-2007. INT. CL. 38.
 TERRE DA VINO S.P.A., BAROLO, CUNEO, ITALY:
 3,311,957, PUB. 7-31-2007. INT. CL. 33.
 3,311,958, PUB. 7-31-2007. INT. CL. 33.
 3,311,959, PUB. 7-31-2007. INT. CL. 33.
 TERRELL PUBLISHING COMPANY, KANSAS CITY, MO:
 3,313,097, MULTIPLE CLASS, INT. CLS. 16 AND 20.
 TERROR-FREE OIL INITIATIVE, CORAL SPRINGS, FL:
 3,313,280, INT. CL. 35.
 TERRY L. JACOBSON, MD, PLLC, ISSAQUAH, WA:
 3,311,100, PUB. 7-31-2007. INT. CL. 44.
 TESTI S.P.A., 50053 EMPOLI (FIRENZE), ITALY:
 3,313,914, INT. CL. 14.
 TEXAS AMERICAN EAGLES SOCCER CLUB, INC., COL-
 LEYVILLE, TX:
 2,410,018, CANC. INT. CL. 41.
 TEXAS FARM PRODUCTS HOLDING COMPANY, NACOG-
 DOCHES, TX:
 3,313,958, INT. CL. 31.
 TEXAS FIREWORKS COMPANY, INC., SILSBEE, TX:
 3,312,125, PUB. 7-31-2007. INT. CL. 13.
 TEXTILE KNOCK OUTS INC., NEW YORK, NY, DBA TKO:
 2,411,452, CANC. INT. CL. 25.
 TH SPORTS MARKETING, INC., HICKORY, KY:
 2,411,027, CANC. INT. CL. 6.
 THALES NANOTECHNOLÓGIAI RT., HUNGARY:
 3,312,717, PUB. 7-31-2007. MULTIPLE CLASS, INT. CLS.
 1, 7 AND 9.
 THANE INTERNATIONAL, INC., LA QUINTA, CA:
 3,312,046, PUB. 7-31-2007. INT. CL. 3.
 THAROS LABORATORIES, INC., SHARON, MA:
 3,314,975, INT. CL. 5.
 THE ALLEN COMPANY, INC., BROOMFIELD, CO:
 3,313,182, INT. CL. 25.
 THE AMBAGE, LLC, GILBERT, AZ:
 3,313,081, INT. CL. 44.
 THE AMERICAN ALPINE CLUB, GOLDEN, CO:
 3,311,883, PUB. 7-31-2007. MULTIPLE CLASS, INT. CLS.
 16, 41 AND 42.
 THE AMERICAN HOTEL & LODGING EDUCATIONAL
 INSTITUTE, ORLANDO, FL:
 3,310,654, PUB. 7-31-2007. MULTIPLE CLASS, INT. CLS. 9
 AND 16.
 THE AMERICAN ORTHOPAEDIC ASSOCIATION, ROSE-
 MONT, IL:
 3,311,878, PUB. 7-31-2007. INT. CL. 35.

- THE ANDREA RIZZO FOUNDATION, CHARLESTOWN, RI:
3,310,519, PUB. 7-31-2007. INT. CL. 36.
- THE APPAREL SOURCING GROUP, LLC, BUCK HILL FALLS, PA:
3,310,419, PUB. 7-31-2007. INT. CL. 25.
- THE ARGEN CORPORATION, SAN DIEGO, CA:
3,311,589, PUB. 7-31-2007. INT. CL. 5.
- THE AROMATIC OFFICE, FREDERICK, CO:
3,311,224, PUB. 7-31-2007. INT. CL. 3.
- THE BACHMAN COMPANY, WYOMISSING, PA, BACHMAN BAKERIES CORPORATION, READING, PA:
658,890. REN. 9-13-07. U.S. CL. 46 (INT. CL. 30).
- THE BEAR STEARNS COMPANIES INC., NEW YORK, NY:
3,313,710, MULTIPLE CLASS, INT. CLS. 9, 36 AND 42.
- THE BEER GARDEN, INC., NEW YORK, NY:
3,311,827, PUB. 7-31-2007. INT. CL. 41.
- THE BLACK & DECKER CORPORATION, TOWSON, MD:
3,313,984, INT. CL. 21.
- THE BOBBY WILLIAMS GOLF COMPANY, CAMP HILL, PA:
2,411,577, CANC. INT. CL. 28.
- THE CANADIAN WILD RICE MERCANTILE LTD., THUNDER BAY, CANADA:
3,312,369, PUB. 7-31-2007. MULTIPLE CLASS, INT. CLS. 30 AND 35.
- THE CARTOON NETWORK, INC., ATLANTA, GA:
3,313,845, INT. CL. 41.
- THE CASTLE PINES GOLF CLUB, INC., CASTLE ROCK, CO:
3,311,180, PUB. 7-31-2007. INT. CL. 41.
- THE CEILING FAN COMPANY, INC., LAS VEGAS, NV, DBA FANCO:
3,314,772, INT. CL. 11.
- THE CHRONIC PAIN STORE, LLC, GLEN ELLYN, IL:
3,312,504, PUB. 7-31-2007. INT. CL. 35.
- THE CLARITY GROUP, INC., URBANDEALE, IA:
3,311,444, PUB. 7-31-2007. INT. CL. 16.
- THE COBALT GROUP, INC., SEATTLE, WA:
2,409,903, CANC. INT. CL. 9.
- THE COCA-COLA COMPANY, ATLANTA, GA:
3,313,553, INT. CL. 32.
3,313,923, MULTIPLE CLASS, INT. CLS. 16, 35 AND 41.
3,314,601, INT. CL. 32.
- THE COUNCIL TOOL CO., INC., LAKE WACCAMAW, NC:
3,314,540, INT. CL. 8.
- THE CYTOSCAPE CONSORTIUM, SAN DIEGO, CA:
3,312,539, PUB. 7-31-2007. INT. CL. 9.
- THE DANNON COMPANY, INC., WHITE PLAINS, NY:
3,311,248, PUB. 7-31-2007. INT. CL. 29.
3,311,250, PUB. 7-31-2007. INT. CL. 32.
- THE DEAL, LLC, NEW YORK, NY:
3,311,565, PUB. 7-31-2007. INT. CL. 41.
- THE DILLER CORPORATION, CINCINNATI, OH:
3,311,683, PUB. 7-31-2007. INT. CL. 17.
- THE DINEX GROUP, LLC, NEW YORK, NY:
3,313,498, INT. CL. 43.
- THE DOCTORS COMPANY, NAPA, CA:
3,311,401, PUB. 7-31-2007. INT. CL. 36.
- THE DORADO BEACH COMPANY, LLC, SAN JUAN, PUERTO RICO:
3,314,304, INT. CL. 43.
- THE DORIS DILLON CENTER, NEW YORK, NY:
3,311,983, PUB. 7-31-2007. INT. CL. 41.
3,311,985, PUB. 7-31-2007. INT. CL. 41.
- THE DRY ROOF COMPANY, LLC, HILLSBORO, OR:
3,313,940, INT. CL. 19.
- THE ECLIPSE GROUP LLP, GRANADA HILLS, CA:
3,312,304, PUB. 7-31-2007. INT. CL. 42.
- THE ELECTRIC GRAPEVINE INCORPORATED, COSTA MESA, CA:
3,313,998, INT. CL. 25.
3,313,999, INT. CL. 25.
3,314,000, INT. CL. 35.
- THE EPISCOPAL CHURCH, NEW YORK, NY:
3,310,672, PUB. 7-31-2007. INT. CL. 45.
- THE FIRST AMERICAN CORPORATION, SANTA ANA, CA:
3,310,752, PUB. 7-31-2007. INT. CL. 9.
3,311,811, PUB. 7-31-2007. INT. CL. 9.
- THE FIZZY FRUIT COMPANY, PORTLAND, OR:
3,314,588, INT. CL. 29.
- THE FOLEY GROUP, MINNEAPOLIS, MN:
3,314,736, INT. CL. 35.
- THE FORCE, INC., HUNTSVILLE, AL:
3,314,425, INT. CL. 9.
- THE FRENCH PASTRY SCHOOL LLC, CHICAGO, IL:
3,310,535, PUB. 7-31-2007. INT. CL. 36.
- THE FRESH MARKET, INC., GREENSBORO, NC:
2,902,361, CANC. INT. CL. 35.
- THE GUARDIAN LIFE INSURANCE COMPANY OF AMERICA, NEW YORK, NY:
3,313,333, INT. CL. 36.
- THE H.D. LEE COMPANY, INC., WILMINGTON, DE:
3,313,361, INT. CL. 25.
- THE HAGERTY GROUP, INC., TRAVERSE CITY, MI:
3,311,847, PUB. 7-31-2007. MULTIPLE CLASS, INT. CLS. 16 AND 39.
- THE HAIN CELESTIAL GROUP, INC., MELVILLE, NY:
3,314,758, INT. CL. 30.
- THE HAPPIEST BABY, INC., PACIFIC PALISADES, CA:
3,313,059, MULTIPLE CLASS, INT. CLS. 9 AND 41.
- THE HARKER SCHOOL, SAN JOSE, CA:
3,310,759, PUB. 7-31-2007. INT. CL. 41.
- THE HARMAN GROUP, INC., MANASSAS, VA:
3,311,204, PUB. 7-31-2007. INT. CL. 35.
- THE HAWORTH PRESS, INC., BINGHAMTON, NY:
3,311,801, PUB. 7-31-2007. INT. CL. 16.
- THE HELMAN GROUP, LTD., OXNARD, CA:
3,314,568, INT. CL. 7.
- THE HERCULES TIRE & RUBBER COMPANY, FINDLAY, OH:
3,310,895, PUB. 7-31-2007. INT. CL. 35.
- THE HILLIARD CORPORATION, ELMIRA, NY:
3,314,183, INT. CL. 12.
- THE HOFF COMPANIES, INC., MERIDIAN, ID:
3,313,972, INT. CL. 19.
- THE HOUSING PARTNERSHIP INC., LOUISVILLE, KY:
3,310,436, PUB. 7-31-2007. MULTIPLE CLASS, INT. CLS. 36 AND 41.
- THE ICONFACTORY, INC., GREENSBORO, NC:
3,311,150, PUB. 7-31-2007. INT. CL. 42.
- THE INSTITUTE OF INTERNAL AUDITORS, INC., ALTA-MONTE SPRINGS, FL:
3,310,348, PUB. 7-31-2007. INT. CL. 42.
- THE KNOT, INC., NEW YORK, NY:
3,312,259, PUB. 7-31-2007. INT. CL. 42.
3,314,066, INT. CL. 41.
- THE KRAMER GROUP, INC., ORLANDO, FL:
3,313,697, INT. CL. 42.
- THE KRAUS ORGANIZATION LIMITED, NEW YORK, NY:
3,315,019, INT. CL. 16.
- THE LANGUAGE WORKS, INC., NEW YORK, NY:
3,310,695, PUB. 7-31-2007. MULTIPLE CLASS, INT. CLS. 35 AND 41.
- THE LEGAL ASSISTANT, LLC, GARFIELD, NJ:
3,311,306, PUB. 7-31-2007. INT. CL. 42.
3,311,338, PUB. 7-31-2007. INT. CL. 9.
- THE LEONARD BERNSTEIN OFFICE, INC., NEW YORK, NY:
3,312,694, PUB. 7-31-2007. INT. CL. 3.
- THE LODESTONE GUITAR COMPANY LIMITED, UNITED KINGDOM:
3,312,930, PUB. 7-31-2007. MULTIPLE CLASS, INT. CLS. 9 AND 15.
- THE MARKETING COLLABORATIVE GROUP, INC., BURLINGTON, MA:
3,310,783, PUB. 7-31-2007. INT. CL. 35.
- THE MARRYING GUY, BURBANK, CA:
3,310,957, PUB. 7-31-2007. INT. CL. 45.
3,310,970, PUB. 7-31-2007. INT. CL. 45.
- THE MCGRAW-HILL COMPANIES, INC., NEW YORK, NY:
3,313,597, INT. CL. 41.
- THE MEYER COMPANY, CLEVELAND, OH:
2,411,385, CANC. INT. CL. 3.

- THE MODELLERS, LLC, SALT LAKE CITY, UT:
3,311,996, PUB. 7-31-2007. INT. CL. 35.
- THE NATIONAL ALLIANCE FOR INSURANCE EDUCATION & RESEARCH, AUSTIN, TX:
3,311,125, PUB. 7-17-2007. INT. CL. 41.
- THE NATIONAL TERRAZZO & MOSAIC ASSOCIATION, INC., PURCELLVILLE, VA:
3,310,815, PUB. 7-31-2007. INT. CL. 35.
- THE NED HERRMANN GROUP INC., LAKE LURE, NC:
3,311,874, PUB. 7-31-2007. MULTIPLE CLASS, INT. CLS. 16 AND 35.
- THE NEW YORK RACING ASSOCIATION INC., JAMAICA, NY:
3,312,378, PUB. 7-10-2007. INT. CL. 41.
- THE OLSON COMPANY, SEAL BEACH, CA:
3,310,473, PUB. 7-31-2007. INT. CL. 37.
3,310,474, PUB. 7-31-2007. INT. CL. 37.
- THE PAPER DIVA, INC., MORROW, GA:
3,312,493, PUB. 7-31-2007. INT. CL. 16.
- THE PROCTER & GAMBLE COMPANY, CINCINNATI, OH:
3,313,694, INT. CL. 3.
3,313,695, MULTIPLE CLASS, INT. CLS. 3 AND 21.
3,314,433, INT. CL. 29.
3,314,506, INT. CL. 3.
- THE PROTOCOL, SEATTLE, WA:
3,310,837, PUB. 7-31-2007. INT. CL. 41.
- THE PRUDENTIAL INSURANCE COMPANY OF AMERICA, NEWARK, NJ:
3,314,760, INT. CL. 36.
- THE RADIAN GROUP LLC, MELVILLE, NY:
3,314,489, INT. CL. 9.
- THE RED ELEPHANT, LLC, TALLAHASSEE, FL:
3,310,396, PUB. 7-31-2007. INT. CL. 43.
- THE REGENTS OF THE UNIVERSITY OF CALIFORNIA, OAKLAND, CA:
3,313,356, INT. CL. 31.
- THE RESOURCE CLUB LTD., NEW YORK, NY:
3,314,589, INT. CL. 25.
3,314,590, INT. CL. 25.
- THE RISK MANAGEMENT ASSOCIATION, PHILADELPHIA, PA:
2,021,395, CANC. INT. CL. 16.
- THE RITZ-CARLTON HOTEL COMPANY, L.L.C., BETHESDA, MD:
3,312,443, PUB. 7-31-2007. INT. CL. 35.
3,312,444, PUB. 7-31-2007. INT. CL. 36.
- THE S. HEKEMIAN GROUP, LLC, PARAMUS, NJ:
3,314,657, INT. CL. 36.
- THE SAUSALITO GROUP, INC., SAUSALITO, CA:
3,310,597, PUB. 7-31-2007. MULTIPLE CLASS, INT. CLS. 9 AND 38.
3,310,598, PUB. 7-31-2007. MULTIPLE CLASS, INT. CLS. 9 AND 38.
- THE SAVINGS BANK LIFE INSURANCE COMPANY OF MASSACHUSETTS, WOBURN, MA:
3,310,571, PUB. 7-31-2007. INT. CL. 36.
- THE SCONE PONY, LLC, BELMAR, NJ:
3,311,009, PUB. 7-31-2007. INT. CL. 30.
- THE SCOTT FETZER COMPANY, WESTLAKE, OH:
3,313,181, INT. CL. 7.
- THE SECRETAN CENTER INC., ONTARIO, CANADA:
3,312,032, PUB. 7-31-2007. MULTIPLE CLASS, INT. CLS. 9, 16, 35, 41 AND 45.
- THE SEMINOLE NATION OF OKLAHOMA, WEWOKA, OK:
3,311,603, PUB. 7-31-2007. MULTIPLE CLASS, INT. CLS. 35 AND 41.
- THE SHADE STORE LLC, LONG ISLAND CITY, NY:
3,313,329, INT. CL. 35.
- THE SHELTON COMMUNICATIONS GROUP, INC, KNOXVILLE, TN:
3,312,675, PUB. 7-31-2007. INT. CL. 35.
- THE SLIDING DOOR COMPANY, INC., VAN NUYS, CA:
3,310,658, PUB. 7-17-2007. INT. CL. 19.
- THE SMEAD MANUFACTURING COMPANY, HASTINGS, MN:
3,313,713, INT. CL. 16.
- THE SPERRY AND HUTCHINSON COMPANY, INC., DELRAY BEACH, FL:
2,409,960, CANC. INT. CL. 35.
- THE THREE ARTS CLUB OF CHICAGO, CHICAGO, IL:
3,310,470, PUB. 7-31-2007. INT. CL. 35.
- THE TOLLY GROUP, INC., BOCA RATON, FL:
3,310,377, PUB. 7-31-2007. INT. CL. 42.
- THE TRADE MARK LICENSING COMPANY LIMITED, PRESTWICH, MANCHESTER M25 9WB, UNITED KINGDOM:
3,310,235, PUB. 4-17-2007. MULTIPLE CLASS, INT. CLS. 9, 18 AND 25.
- THE TRUSTEES OF THE HEISMAN TROPHY TRUST, NEW YORK, NY:
3,311,769, PUB. 7-31-2007. INT. CL. 28.
- THE WAY, LTD, BEAR, DE:
3,313,822, INT. CL. 35.
- THE WEALTH CORP., INDIANAPOLIS, IN:
3,314,843, INT. CL. 16.
- THE WRITERS COMPUTER STORE, LOS ANGELES, CA:
3,312,651, PUB. 7-31-2007. MULTIPLE CLASS, INT. CLS. 38 AND 39.
- THE ZEPPONETWORK, INC., HONOLULU, HI:
3,313,784, INT. CL. 9.
- THEFACESHOP KOREA CO., LTD., SEOUL, REPUBLIC OF KOREA:
3,311,804, PUB. 7-31-2007. INT. CL. 3.
- THERADDEX SYSTEMS, INC., PRINCETON JUNCTION, NJ:
3,310,333, PUB. 4-10-2007. INT. CL. 9.
- THERAGEAR INTERNATIONAL LTD., MISSION, BRITISH COLUMBIA, CANADA:
3,313,528, MULTIPLE CLASS, INT. CLS. 10, 20 AND 28.
- THERAPEUTICS:101 INC., TINTON FALLS, NJ:
3,313,202, INT. CL. 10.
- THERENOW, INC., NORTH LOGAN, UT:
3,311,175, PUB. 7-31-2007. INT. CL. 41.
- THERMA-COTE, INC., ATLANTA, GA:
3,311,719, PUB. 7-31-2007. INT. CL. 17.
- THERMAL CERAMICS INC., AUGUSTA, GA, BABCOCK & WILCOX COMPANY, THE, NEW YORK, NY:
643,128, REN. 9-10-07. U.S. CL. 12 (INT. CL. 19).
- THERMO-STONE USA, LLC, MARINA, CA:
3,312,431, PUB. 7-31-2007. INT. CL. 40.
- THF EQUITIES, LP, WESTCHESTER, IL:
1,419,356, CANC. MULTIPLE CLASS, INT. CLS. 29 AND 30.
- THIAM, ALIAUNE, ATLANTA, GA:
3,312,153, PUB. 7-31-2007. INT. CL. 41.
- THINK SMART, S.A., ALCOBENDAS, MADRID, SPAIN:
3,312,031, PUB. 7-31-2007. INT. CL. 35.
- THINK-STRATEGY.ORG, COLUMBIA, MD:
2,410,488, CANC. INT. CL. 9.
- THINKING PAYS, INC., BOCA RATON, FL:
3,314,609, INT. CL. 41.
- THINKING TECHNOLOGY INC., NASSAU, BAHAMAS:
3,313,836, INT. CL. 28.
- THIRD FEDERAL SAVINGS AND LOAN ASSOCIATION OF CLEVELAND, CLEVELAND, OH, DBA THIRD FEDERAL SAVINGS:
2,411,291, CANC. INT. CL. 36.
- THIRD PARTY VERIFICATION, INC., ALTAMONTE SPRINGS, FL:
3,311,980, PUB. 7-31-2007. INT. CL. 42.
- THIS LITTLE PIGGY, INC., VAN NUYS, CA:
2,410,563, CANC. INT. CL. 28.
- THOMAS LLOYD CETTA, RACINE, WI:
3,311,961, PUB. 7-31-2007. INT. CL. 12.
- THOMAS NELSON, INC., NASHVILLE, TN:
2,411,054, CANC. INT. CL. 16.
- THOMAS WIRESPOOLS, INC., EDMOND, OK:
2,410,091, CANC. INT. CL. 6.
- THOMPSON CENTER ARMS COMPANY INC., ROCHESTER, NH:
3,314,141, INT. CL. 13.
3,314,142, INT. CL. 13.
3,314,296, INT. CL. 13.
3,314,423, INT. CL. 3.
3,314,640, INT. CL. 13.

THOMPSON, DENNIS R., OCALA, FL:
 3,311,462, PUB. 7-31-2007. INT. CL. 31.
 THOMPSON, MARC, SUN CITY, CA:
 2,409,774, CANC. INT. CL. 37.
 THOMSON INDUSTRIES, INC., SIMSBURY, CT:
 650,866, REN. 9-13-07. U.S. CL. 23 (INT. CL. 7).
 THOMSON, EDWARD M. JR., SAN BERNARDINO, CA:
 3,313,310, INT. CL. 28.
 THORNBURG, CHRIS, SAN CLEMENTE, CA AND DUR-
 KEE, JAY, SAN CLEMENTE, CA:
 3,314,100, INT. CL. 25.
 THORNE RESEARCH, INC., DOVER, ID:
 3,310,416, PUB. 7-31-2007. INT. CL. 5.
 THORNE, ASHIDA ONRAE, LOS ANGELES, CA:
 3,311,396, PUB. 7-31-2007. INT. CL. 41.
 THORP DIRECT SALES, INC., DORAVILLE, GA:
 3,314,512, INT. CL. 25.
 THORSEN TOOL COMPANY, ONTARIO, CA:
 3,313,311, INT. CL. 12.
 THREE ANGELS BROADCASTING NETWORK, INC.,
 WEST FRANKFORT, IL:
 3,310,797, PUB. 7-31-2007. INT. CL. 41.
 THREE RIDGES, LLC, BREVARD, NC:
 3,314,064, INT. CL. 28.
 THRIFTY DRUG STORES, INC., MAPLE GROVE, MN:
 3,310,537, PUB. 7-10-2007. MULTIPLE CLASS, INT. CLS.
 35, 40 AND 41.
 THRONEBURG, JAMES L., STATESVILLE, NC:
 2,164,738, REN. 9-8-07. INT. CL. 25.
 2,167,811, REN. 9-8-07. INT. CL. 41.
 3,313,858, MULTIPLE CLASS, INT. CLS. 25 AND 35.
 3,313,859, MULTIPLE CLASS, INT. CLS. 25 AND 35.
 3,313,913, MULTIPLE CLASS, INT. CLS. 25 AND 35.
 THULE GMBH & CO. KG, FED REP GERMANY:
 3,312,822, PUB. 7-31-2007. INT. CL. 12.
 THUNDER BAY FASHIONS INC./LES MODES THUNDER
 BAY INC., MONTRÉAL, QUÉBEC, CANADA:
 3,312,092, PUB. 7-31-2007. INT. CL. 25.
 THUNDER BIRD SISTERS, LLC, SOUTHAMPTON, NY:
 2,411,286, CANC. INT. CL. 9.
 THUOLO INC., HOUSTON, TX:
 2,410,124, CANC. INT. CL. 25.
 THURMOND, SARAH, EAST HADDAM, CT:
 3,311,935, PUB. 7-31-2007. INT. CL. 42.
 THYSSENKRUPP ELEVATOR CAPITAL CORPORATION,
 TROY, MI:
 3,313,482, INT. CL. 35.
 TIANJIN KANGLI ENAMEL; PRODUCTS CO., LTD., CHI-
 NA:
 3,312,790, PUB. 7-31-2007. INT. CL. 21.
 TIAX LLC, CAMBRIDGE, MA:
 3,313,369, INT. CL. 42.
 TIDE ACQUISITION CORPORATION, BEVERLY HILLS,
 CA:
 2,411,570, CANC. INT. CL. 38.
 TIFFANY (NJ) INC., PARSIPPANY, NJ:
 3,310,859, PUB. 7-31-2007. INT. CL. 14.
 TIJUANA TAXI EXPRESS, INC., DALLAS, TX:
 3,313,655, INT. CL. 43.
 TIMBERLINE LUMBER COMPANY OF ASHEVILLE, ASHE-
 VILLE, NC:
 3,314,592, INT. CL. 19.
 TIME INC., NEW YORK, NY:
 2,411,349, CANC. INT. CL. 16.
 TIME WISE SOLUTIONS, LLC., MORRILL, ME:
 3,310,424, PUB. 7-31-2007. INT. CL. 41.
 TIMES GRILL RESTAURANT GROUP, LLC, JACKSON-
 VILLE, FL:
 3,311,531, PUB. 7-31-2007. INT. CL. 43.
 TIMES MIRROR MAGAZINES, INC., NEW YORK, NY:
 2,410,133, CANC. INT. CL. 41.
 2,411,588, CANC. INT. CL. 41.
 TIMESHARE MLS INC., ORLANDO, FL:
 3,314,994, INT. CL. 35.
 TIME4 MEDIA, INC., WINTER PARK, FL:
 1,069,824, REN. 9-7-07. INT. CL. 16.
 TIPPI DOBROFSKY, SANTA MONICA, CA:
 3,312,349, PUB. 7-31-2007. INT. CL. 41.
 TISHCON CORP., WESTBURY, NY:
 3,314,574, INT. CL. 5.
 3,314,752, INT. CL. 5.
 TITAN DESIGNS, INC., LOS ANGELES, CA:
 3,313,218, INT. CL. 14.
 TJM DEVELOPMENT GP, LLC, DALLAS, TX:
 3,312,670, PUB. 7-31-2007. INT. CL. 43.
 TJX COMPANIES, INC., THE, FRAMINGHAM, MA:
 2,164,679, REN. 9-9-07. INT. CL. 25.
 TLS INTERNATIONAL, LLC, NEEDHAM, MA:
 3,314,530, INT. CL. 25.
 TMG-EMEDIA, INC., NEW YORK, NY:
 3,311,776, PUB. 7-31-2007. MULTIPLE CLASS, INT. CLS.
 35 AND 42.
 TNS PAYMENT SOLUTIONS, INC., WATERVLIET, NY:
 2,410,338, CANC. MULTIPLE CLASS, INT. CLS. 37, 41
 AND 42.
 TOBESMART, LLC, LITTLETON, CO:
 3,314,607, INT. CL. 28.
 TOBY COREY, LOS GATOS, CA:
 3,314,995, INT. CL. 41.
 TODD MAGALINE, SAN RAFAEL, CA:
 3,310,896, PUB. 7-31-2007. INT. CL. 25.
 TODD SHAW, INC., ATLANTA, GA, DBA SHORT RE-
 CORDS:
 2,409,989, CANC. INT. CL. 9.
 TODD WARD LLC, TACOMA, WA:
 3,311,195, PUB. 7-31-2007. MULTIPLE CLASS, INT. CLS.
 37 AND 42.
 TODD, DONALD D., MUKWONAGO, WI:
 1,419,408, CANC. MULTIPLE CLASS, U.S. CL. 200 INT.
 CLS. 35 AND 42.
 TOHO CO., LTD., NISHI-KU, HIROSHIMA-SHI, HIROSHI-
 MA, JAPAN:
 3,313,102, MULTIPLE CLASS, INT. CLS. 14 AND 26.
 TOLTEC FABRICS, INC., NEW YORK, NY:
 1,419,239, CANC. INT. CL. 24.
 TOM CHRISTAL COMPANY, SAN ANTONIO, TX:
 2,020,938, CANC. INT. CL. 35.
 TOM INCORPORATED, WASHINGTON, DC:
 2,411,322, CANC. INT. CL. 20.
 TOMASELLO WINERY, INC., HAMMONTON, NJ:
 3,311,994, PUB. 7-31-2007. INT. CL. 33.
 TOMTEC IMAGING SYSTEMS GMBH, FED REP GER-
 MANY:
 3,211,594, COR. MULTIPLE CLASS, INT. CLS. 9, 10, 42
 AND 44.
 TONGLIANG HUANG, CH-6003 LUZERN, SWITZERLAND:
 3,312,704, PUB. 7-31-2007. MULTIPLE CLASS, INT. CLS.
 5, 16, 41 AND 44.
 TONI & GUY (USA) LIMITED, CARROLLTON, TX:
 3,311,895, PUB. 4-10-2007. MULTIPLE CLASS, INT. CLS.
 11 AND 21.
 TOP EIGHT INDUSTRIAL CORP., TAIPEI 114, TAIWAN:
 3,313,150, INT. CL. 9.
 TOP OF THE LINE, INC., MALIBU, CA:
 2,411,195, CANC. INT. CL. 28.
 TOP SPEED INTERNET SERVICE, LLC, SPARKS, NV:
 3,314,790, INT. CL. 38.
 TOPCO ASSOCIATES, LLC, SKOKIE, IL:
 3,313,604, INT. CL. 29.
 TOPCON MEDICAL SYSTEMS, INC., PARAMUS, NJ:
 3,310,817, PUB. 7-31-2007. INT. CL. 10.
 TORAY KABUSHIKI KAISHA (TORAY INDUSTRIES, INC.),
 TOKYO, JAPAN:
 3,312,317, PUB. 7-31-2007. INT. CL. 24.
 TORCHQUEST, INC., AUSTIN, TX:
 2,755,935, CANC. MULTIPLE CLASS, INT. CLS. 9 AND
 42.
 TORO COMPANY, THE, MINNEAPOLIS, MN:
 1,418,948, CANC. INT. CL. 7.
 TORRE, DAVID, P, EL GRANADA, CA:
 3,314,375, INT. CL. 42.
 TOSHIBA AMERICA CONSUMER PRODUCTS, L.L.C.,
 WAYNE, NJ:
 3,313,435, INT. CL. 9.
 TOSHIBA MEDICAL SYSTEMS CORPORATION, JAPAN:
 3,312,935, PUB. 7-31-2007. INT. CL. 10.

- TOTAL LOGISTIC CONTROL LLC, ZEELAND, MI:
3,311,889, PUB. 2-13-2007. MULTIPLE CLASS, INT. CLS.
35 AND 39.
- TOTES ISOTONER CORPORATION, CINCINNATI, OH:
3,312,107, PUB. 6-19-2007. MULTIPLE CLASS, INT. CLS.
8, 9 AND 11.
- TOTO PRODUCTS, LLC, MIRAMAR, FL:
3,310,406, PUB. 7-31-2007. INT. CL. 28.
- TOUCHPRO INSTITUTE OF CHAIR MASSAGE, SAN
FRANCISCO, CA:
2,410,594, CANC. INT. CL. 16.
- TOUREEN BOARDING KENNELS, INC., BRIGHTON, MA:
3,311,388, PUB. 7-31-2007. INT. CL. 43.
- TOWN OF NEW CASTLE, NEW CASTLE, CO:
3,312,672, PUB. 7-31-2007. INT. CL. 35.
- TOWN24.COM, INC., NEW YORK, NY:
2,410,057, CANC. INT. CL. 42.
- TOY STATE INDUSTRIAL LTD., TSTE, KOWLOON, HONG
KONG:
3,314,718, INT. CL. 28.
- TOYOTA BOSHOKU KABUSHIKI KAISHA, KARIYA-SHI,
AICHI-KEN, JAPAN:
3,238,822, COR. MULTIPLE CLASS, INT. CLS. 7, 12 AND
27.
- TOYOTA JIDOSHA KABUSHIKI KAISHA, AICHI-KEN,
JAPAN:
843,138, REN. 9-13-07. U.S. CL. 19 (INT. CL. 12).
- TOYOTA JIDOSHA KABUSHIKI KAISHA, TOYOTA-SHI,
AICHI-KEN, JAPAN, TA TOYOTA MOTOR CORPORA-
TION:
3,313,966, INT. CL. 9.
- TOYOTA MOTOR CREDIT CORPORATION, TORRANCE,
CA:
3,311,556, PUB. 7-31-2007. INT. CL. 36.
- TOZIER, LTD., HONOLULU, HI:
3,313,948, INT. CL. 25.
- TP ORTHODONTICS, INC., LAPORTE, IN:
2,103,472, REN. 9-13-07. INT. CL. 10.
- TRACE LIFE SCIENCES, INC., DENTON, TX:
3,312,109, PUB. 7-31-2007. INT. CL. 10.
- TRACE MINERALS RESEARCH, L.C., OGDEN, UT:
3,312,170, PUB. 7-31-2007. INT. CL. 5.
- TRACER CONSTRUCTION COMPANY, HOUSTON, TX:
2,038,554, REN. 9-9-07. INT. CL. 11.
- TRACSECURITY, INC., BATON ROUGE, LA:
3,311,701, PUB. 7-31-2007. MULTIPLE CLASS, INT. CLS.
9, 42 AND 45.
- TRACI SCOTT, L.L.C., HOUSTON, TX:
3,313,666, INT. CL. 3.
- TRACKTION SOLE INC., QUEBEC, CANADA:
2,411,590, CANC. INT. CL. 25.
- TRADECAPTURE, INC., STAMFORD, CT:
3,311,749, PUB. 7-31-2007. INT. CL. 36.
- TRADEMARK ACQUISITION COMPANY, FORT MITCH-
ELL, KY, DBA ZARING PREMIER HOMES:
3,313,142, INT. CL. 19.
- TRADEYARD, INC., SAN FRANCISCO, CA:
2,410,451, CANC. INT. CL. 42.
- TRADITIONAL MEDICINALS, INC., SEBASTOPOL, CA:
2,176,476, REN. 9-12-07. INT. CL. 5.
2,176,477, REN. 9-12-07. INT. CL. 5.
- TRADITIONAL WATERCRAFT, INC., LARGO, FL, DBA
ISLAND PACKET YACHTS:
3,313,620, INT. CL. 12.
- TRADITIONS CAPITAL, LLC, BETHLEHEM, PA:
3,312,188, PUB. 7-31-2007. INT. CL. 36.
- TRAIN EXPRESS, INC., INDIANAPOLIS, IN:
2,020,883, CANC. INT. CL. 42.
- TRAINING TECHNOLOGIES, INC., CINCINNATI, OH:
2,409,792, CANC. MULTIPLE CLASS, INT. CLS. 35, 41
AND 42.
- TRAJAH, INC., BUFFALO GROVE, IL:
3,314,804, INT. CL. 35.
- TRALLIANCE CORPORATION, NEW YORK, NY:
3,313,153, INT. CL. 42.
- TRAN, TUONG VI, SAN JOSE, CA:
3,314,146, INT. CL. 43.
- TRANS CONSOLIDATED DISTRIBUTORS, INC., CHATS-
WORTH, CA:
2,021,135, CANC. INT. CL. 17.
- TRANSAMERICA FINANCIAL RESOURCES, INC., LOS
ANGELES, CA:
2,409,993, CANC. INT. CL. 36.
- TRANSILWRAP COMPANY, INC., FRANKLIN PARK, IL:
2,410,723, CANC. INT. CL. 16.
2,410,741, CANC. INT. CL. 17.
- TRANSIT REALTY ASSOCIATES, LLC, BOSTON, MA:
3,314,982, INT. CL. 9.
- TRANSPAC MARINAS, INC., ANACORTES, WA:
1,446,812, REN. 9-8-07. INT. CL. 37.
- TRANSTAR INDUSTRIES, INC., CLEVELAND, OH:
2,410,616, CANC. INT. CL. 35.
- TRASK INDUSTRIES, LLC, KISSIMMEE, FL:
3,314,833, INT. CL. 41.
- TRAVELZOO INC., NEW YORK, NY:
3,312,355, PUB. 7-31-2007. INT. CL. 42.
- TRAVIS HAMILTON, HOUSTON, TX:
3,311,909, PUB. 7-31-2007. INT. CL. 25.
- TRE FRATELLI, SAN FRANCISCO, CA:
2,410,004, CANC. INT. CL. 42.
- TREDEGAR CORPORATION, RICHMOND, VA:
2,411,438, CANC. INT. CL. 17.
- TREK AMERICA TRAVEL LIMITED, SEST SUSSEX RH10
9GX, ENGLAND, TREK ADVENTURES, INC., NEW
YORK, NY:
1,057,948, REN. 9-10-07. INT. CL. 39.
- TRENDMASTERS, INC., ST. LOUIS, MO:
2,411,425, CANC. INT. CL. 28.
- TRI-LYNX CORPORATION, IRVING, TX:
3,312,574, PUB. 7-31-2007. INT. CL. 20.
- TRI-MOTION INDUSTRIES, INC., TAMPA, FL:
1,457,237, REN. 9-7-07. INT. CL. 9.
- TRIAD HOSPITALS, INC., PLANO, TX:
2,411,367, CANC. INT. CL. 36.
3,314,962, INT. CL. 36.
3,314,963, INT. CL. 44.
- TRIALTEA USA, LLC, MIAMI, FL:
3,310,257, PUB. 7-31-2007. MULTIPLE CLASS, INT. CLS. 9
AND 16.
- TRIANON PROPERTIES, INC., NAPLES, FL:
3,314,156, INT. CL. 36.
- TRIDELTA INDUSTRIES, INC., MENTOR, OH:
1,419,011, CANC. INT. CL. 9.
- TRIDIUM, INC., RICHMOND, VA:
3,313,929, INT. CL. 9.
- TRIDONIC-BAUELEMENTE GESELLSCHAFT MBH, A-6851
DORNBIRN, AUSTRIA:
2,410,174, CANC. INT. CL. 9.
2,410,175, CANC. INT. CL. 9.
- TRIDONIC-BAUELEMENTE GESELLSCHAFT MBH, A-6850
DORNBIRN, AUSTRIA:
2,410,450, CANC. INT. CL. 9.
- TRIENDA CORPORATION, PORTAGE, WI TO WILBERT,
INC., BROADVIEW, IL:
2,021,276, CANC. INT. CL. 20.
- TRIEXE MANAGEMENT GROUP ULC, FONTHILL, ON-
TARIO, CANADA:
3,313,179, INT. CL. 23.
- TRILEGIANT CORPORATION, NORWALK, CT:
3,313,882, MULTIPLE CLASS, INT. CLS. 35, 41 AND 43.
3,313,935, MULTIPLE CLASS, INT. CLS. 35, 40 AND 41.
- TRINITY FORGE, INC., MANSFIELD, TX:
3,311,387, PUB. 7-31-2007. INT. CL. 6.
- TRIPLE CROWN SPORTS, FORT COLLINS, CO:
3,311,258, PUB. 7-10-2007. INT. CL. 41.
- TRIPOD, INC., WILLIAMSTOWN, MA:
2,410,274, CANC. INT. CL. 38.
- TRITON CARTRIDGE CORPORATION, WAPPINGERS
FALLS, NY:
2,410,812, CANC. INT. CL. 13.
- TRIUMPH HOSIERY CORP., HOLLYWOOD, FL:
3,313,328, INT. CL. 25.
- TRIVITA, INC., SCOTTSDALE, AZ:
3,314,558, INT. CL. 5.

- TRONJEN INDUSTRY CO., LTD, TAICHUNG HSIEN, TAIWAN:
2,483,529, CANC. INT. CL. 10.
- TROPICAL NUT & FRUIT CO., CHARLOTTE, NC:
3,314,880, INT. CL. 29.
- TROXEL PRODUCTS, LLC, WEST POINT, MS:
2,411,582, CANC. INT. CL. 28.
- TROYER POTATO PRODUCTS, INC., ERIE, PA:
3,310,509, PUB. 7-31-2007. MULTIPLE CLASS, INT. CLS. 29 AND 30.
- TRUCK ADS, LLC, MCLEAN, VA:
3,311,394, PUB. 7-31-2007. INT. CL. 12.
- TRUCK 'N I, INC., ATLANTA, GA, DBA TRUCK AND I:
3,312,556, PUB. 7-31-2007. INT. CL. 39.
- TRUCKPRO, INC., CORDOVA, TN, MID-CON CORP., INDIANAPOLIS, IN:
1,071,956, REN. 9-7-07. MULTIPLE CLASS, INT. CLS. 37 AND 42.
- TRUE COMPANIONS OF NY, INC., NEW YORK, NY:
3,310,530, PUB. 7-31-2007. MULTIPLE CLASS, INT. CLS. 41 AND 43.
- TRUE VALUE COMPANY, CHICAGO, IL:
1,090,538, REN. 9-13-07. U.S. CL. 200.
3,313,539, INT. CL. 11.
3,313,540, INT. CL. 11.
- TRUMP MARINA ASSOCIATES, LLC, ATLANTIC CITY, NJ:
2,092,055, REN. 9-13-07. INT. CL. 9.
- TRUST NUMBER SR-1, AVENTURA, FL:
3,310,586, PUB. 7-31-2007. MULTIPLE CLASS, INT. CLS. 36 AND 37.
- TRUSTEES OF THE CALVERT FAMILY TRUST, THE, SAN JOSE, CA:
3,312,238, PUB. 7-31-2007. INT. CL. 36.
- TRUSTEES OF THE ROBERT ROOK CHILDREN'S TRUST, BROOKLINE, MA:
3,312,462, PUB. 7-31-2007. INT. CL. 30.
- TRYLON TSF INC., NORTH YORK, ONTARIO, CANADA:
2,526,475 NEW CERT. 10-16-2007. MULTIPLE CLASS, INT. CLS. 9, 37 AND 42.
- TSAI, ALEX H.N., PLANO, TX:
3,311,469, PUB. 7-31-2007. INT. CL. 16.
- TSAI, ROGER K., LOS ANGELES, CA:
3,310,964, PUB. 7-31-2007. INT. CL. 20.
- TSENG, ALTA K., SAN FRANCISCO, CA:
3,314,135, INT. CL. 42.
- TSEVDOS, DION, CLEVELAND, OH:
3,312,173, PUB. 7-31-2007. MULTIPLE CLASS, INT. CLS. 29, 30 AND 35.
- TSINGHUA UNIVERSITY, CHINA:
3,312,848, PUB. 7-31-2007. MULTIPLE CLASS, INT. CLS. 16, 41 AND 42.
- TSN LABS, INC., MURRAY, UT:
2,090,699, REN. 9-7-07. INT. CL. 5.
- TSUKIBOSHI MFG. CO. LTD, PREF, 922, JAPAN:
3,313,190, INT. CL. 7.
- TSUMURA & CO., TOKYO, JAPAN:
2,091,878, REN. 9-13-07. INT. CL. 3.
- TTR-IP, INC., HOUSTON, TX:
3,314,045, MULTIPLE CLASS, INT. CLS. 35 AND 43.
- TTS&H, LLC, NORMAN, OK:
2,151,630, REN. 9-13-07. INT. CL. 42.
2,151,630, CANC. INT. CL. 25.
- TUCKER, JOHN E., BLANCHARD, OK:
3,311,206, PUB. 7-31-2007. INT. CL. 44.
- TUDOR PLACE FOUNDATION, INC., WASHINGTON, DC:
3,313,946, MULTIPLE CLASS, INT. CLS. 16, 20, 39 AND 41.
- TUGGLE, WILLIAM E., NORFOLK, VA:
1,457,345, REN. 9-10-07. INT. CL. 12.
- TUNZE AQUARIENTECHNIK GMBH, PENZBERG, FED REP GERMANY:
3,312,437, PUB. 7-31-2007. MULTIPLE CLASS, INT. CLS. 7 AND 11.
- TURMAN, JANET, RENO, NV:
2,410,646, CANC. INT. CL. 42.
- TURNBULL, LISA A., MAPLE GROVE, MN AND TURNBULL, RICHARD A., MAPLE GROVE, MN:
3,313,521, INT. CL. 25.
- TURNER MARKETING INCORPORATED, DAYTON, OH:
3,311,927, PUB. 7-31-2007. MULTIPLE CLASS, INT. CLS. 35 AND 42.
- TURNER NETWORK TELEVISION, INC., ATLANTA, GA:
3,314,835, INT. CL. 38.
3,314,836, INT. CL. 41.
- TURTLE FOUNTAINS, LLC, GALLAWAY, TN:
3,310,503, PUB. 7-31-2007. INT. CL. 11.
- TV GUIDE MAGAZINE GROUP, INC., LOS ANGELES, CA, DBA TV GUIDE, TRIANGLE PUBLICATIONS, INC., PHILADELPHIA, PA:
650,942, REN. 9-7-07. U.S. CL. 38 (INT. CL. 16).
- TWENTIETH CENTURY FOX FILM CORPORATION, LOS ANGELES, CA:
2,085,037, REN. 9-10-07. INT. CL. 41.
2,410,765, CANC. INT. CL. 41.
- TWENTY FIRST CENTURY COMMUNICATIONS, INC., COLUMBUS, OH:
3,312,424, PUB. 7-31-2007. INT. CL. 38.
- TWIN CITIES PASTA CO., LLC, MINNEAPOLIS, MN:
3,314,163, INT. CL. 43.
- TWIN MODAL, INC., ST. PAUL, MN:
2,410,543, CANC. INT. CL. 39.
- TWO WISHES, LILBURN, GA:
3,311,337, PUB. 7-17-2007. INT. CL. 25.
- TYCO HEALTHCARE RETAIL SERVICES AG, NEUHAUSEN AM RHEINFALL, SWITZERLAND, CONFAB, INC., KING OF PRUSSIA, PA:
2,091,046, REN. 9-7-07. INT. CL. 16.
- U.I. LAPP GMBH, STUTTGART, FED REP GERMANY, U. I. LAPP KG, 7000 STUTTGART-VAIHINGEN, FED REP GERMANY:
1,070,924, REN. 9-13-07. INT. CL. 9.
- U.S. DEPARTMENT OF VETERANS AFFAIRS, WASHINGTON, DC:
3,311,893, PUB. 7-31-2007. MULTIPLE CLASS, INT. CLS. 35, 36 AND 41.
- U.S. ENGINES CORPORATION, SYRACUSE, NY TO FUNNOVATIONS, INC, WILKES-BARRE, PA:
2,021,508, CANC. MULTIPLE CLASS, INT. CLS. 7 AND 12.
- U.S. GRAPHICS INC, NORFOLK, VA:
2,089,298, REN. 9-8-07. INT. CL. 25.
- U.S. GRAPHICS, INC., NORFOLK, VA:
2,147,107, REN. 9-8-07. INT. CL. 25.
- U.S. KINGKING, LLC, BENTONVILLE, AR:
3,313,957, INT. CL. 3.
- U.S. MERCHANT SYSTEMS, INC., NEWARK, CA:
2,410,464, CANC. INT. CL. 36.
- U.S. NONWOVENS CORP., BRENTWOOD, NY:
3,313,850, INT. CL. 3.
- U.S. NUTRACEUTICALS, L.L.C., EUSTIS, FL:
3,314,303, INT. CL. 5.
- U.S. RUBBER RECYCLING, INC., RIVERSIDE, CA:
2,132,050, REN. 9-13-07. INT. CL. 27.
- U.S. SIGNS, INC., HOUSTON, TX:
3,310,441, PUB. 7-31-2007. MULTIPLE CLASS, INT. CLS. 37 AND 42.
- U.S. WELLNESS LTD., FALLS CHURCH, VA:
2,411,483, CANC. INT. CL. 42.
- U-LONG PROSPERITY CO., LTD., TAI PAO CITY, TAIWAN:
3,314,175, INT. CL. 23.
- UAB "CAUSA FORMALIS", LT-08124 VILNIUS, LITHUANIA:
3,312,798, PUB. 7-31-2007. INT. CL. 35.
- UDV NORTH AMERICAS, INC, NORWALK, CT:
2,409,799, CANC. INT. CL. 33.
- UHS OF DELAWARE, INC., KING OF PRUSSIA, PA:
3,312,543, PUB. 7-31-2007. INT. CL. 35.
- UI HOLDING CO., CONKLIN, NY:
3,312,984, INT. CL. 9.
- UK INDUSTRIAL TAPES LIMITED, GATESHEAD, UNITED KINGDOM:
3,313,552, INT. CL. 16.
- ULLIO, RICCARDO, ATLANTA, GA:
3,312,479, PUB. 7-31-2007. INT. CL. 43.
- ULLRICH, PETER F., CORAL GABLES, FL:
2,411,151, CANC. INT. CL. 31.

- ULTA SALON, COSMETICS & FRAGRANCE, INC., RO-MEOVILLE, IL:
3,311,177, PUB. 7-31-2007. INT. CL. 35.
3,311,178, PUB. 7-31-2007. INT. CL. 35.
- ULTIMATE ACQUISITION PARTNERS, L.P., THORNTON, CO:
3,314,431, INT. CL. 37.
- ULTIMATE RESORT, LLC, KISSIMMEE, FL:
3,310,264, PUB. 7-31-2007. INT. CL. 35.
- ULTRA NUTRITIONALS CORP, ST AUGUSTINE, FL:
3,310,712, PUB. 7-31-2007. INT. CL. 5.
- ULTRA PRO, LLC, VENICE, CA, NINA INTERNATIONAL, INC., INDIANAPOLIS, IN:
2,034,442, REN. 9-10-07. INT. CL. 3.
- ULTRAECCHO, LTD., ROCHESTER, MN:
3,313,212, INT. CL. 41.
- ULTRAFAB INC., FARMINGTON, NY:
2,095,809, REN. 9-13-07. INT. CL. 17.
- ULTRAFLEX SYSTEMS, INC., RANDOLPH, NJ:
3,310,716, PUB. 7-31-2007. INT. CL. 17.
- ULTRASOUND DEEJAYS, INC., GAITHERSBURG, MD:
3,313,668, INT. CL. 9.
- UMG RECORDINGS, INC., SANTA MONICA, CA:
3,313,766, INT. CL. 9.
3,314,971, MULTIPLE CLASS, INT. CLS. 35, 38 AND 41.
- UMICORE AG & CO. KG, HANAU, FED REP GERMANY:
3,311,641, PUB. 7-31-2007. MULTIPLE CLASS, INT. CLS. 1, 7 AND 11.
- UN TECHO PARA MI PAIS, SANTIAGO CITY, CHILE:
3,311,259, PUB. 7-31-2007. INT. CL. 36.
- UNCLE JESSE'S, INC., BROOKLYN, NY:
1,471,530, REN. 9-13-07. INT. CL. 29.
- UNIBOARD CANADA INC., LAVAL, CANADA:
3,312,044, PUB. 7-31-2007. INT. CL. 19.
- UNIC S.A.S, CARROS CEDEX 1, FRANCE:
2,115,148, REN. 9-9-07. INT. CL. 11.
- UNICOM SALES ASSOCIATES, INC., MOUNTAINSIDE, NJ:
2,101,964, REN. 9-12-07. INT. CL. 9.
- UNICONTROL INC., CLEVELAND, OH:
3,311,271, PUB. 7-31-2007. INT. CL. 9.
- UNIFIED VOICE, CHICAGO, IL, DBA INTERNATIONAL INTERIOR DESIGN ASSOCIATION:
3,312,086, PUB. 7-31-2007. INT. CL. 41.
- UNILEVER N.V., 3013 AL ROTTERDAM, NETHERLANDS:
2,411,236, CANC. INT. CL. 10.
- UNILEVER SUPPLY CHAIN, INC., CLINTON, CT:
2,088,996, REN. 9-13-07. INT. CL. 30.
2,410,795, CANC. INT. CL. 9.
3,313,407, INT. CL. 3.
3,313,427, INT. CL. 3.
3,313,982, INT. CL. 29.
- UNION CARBIDE CORPORATION, DANBURY, CT:
1,418,832, CANC. INT. CL. 1.
- UNION SECURITY INSURANCE COMPANY, KANSAS CITY, MO:
3,314,040, INT. CL. 36.
- UNIONTOOLS, INC., COLUMBUS, OH:
2,411,180, CANC. INT. CL. 8.
- UNIPAC SERVICE CORPORATION, AURORA, CO:
2,410,719, CANC. INT. CL. 36.
- UNIQUE MEDIA, INCORPORATED, TORONTO, ONTARIO, CANADA:
2,410,572, CANC. INT. CL. 16.
- UNISOURCE INSTITUTIONAL SUPPLY CORPORATION, PHILADELPHIA, PA:
3,314,643, INT. CL. 3.
- UNISOURCE SOLUTIONS, INC., PICO RIVERA, CA:
3,311,894, PUB. 7-31-2007. MULTIPLE CLASS, INT. CLS. 35, 37, 39 AND 42.
- UNITED AUTO CARE, INC., NEW YORK, NY:
2,411,047, CANC. INT. CL. 35.
- UNITED COMB & NOVELTY CORPORATION, LEOMINSTER, MA:
3,314,145, INT. CL. 20.
3,314,147, INT. CL. 21.
- UNITED COMPOST AND ORGANICS, ARCATA, CA:
2,099,952, REN. 9-11-07. INT. CL. 1.
- UNITED MICROELECTRONICS CORP, HSINCHU, TAIWAN:
3,313,572, INT. CL. 9.
3,313,573, INT. CL. 9.
- UNITED NEGRO COLLEGE FUND, INC., FAIRFAX, VA:
2,144,660, REN. 9-13-07. INT. CL. 36.
- UNITED SERVICE ORGANIZATIONS, INC., ARLINGTON, VA:
3,311,868, PUB. 7-31-2007. MULTIPLE CLASS, INT. CLS. 25, 35, 36, 39, 41, 43 AND 45.
- UNITED SERVICES AUTOMOBILE ASSOCIATION, SAN ANTONIO, TX:
3,313,772, INT. CL. 36.
- UNITED SOUVENIR & APPAREL, INC., BALTIMORE, MD:
3,310,267, PUB. 7-31-2007. INT. CL. 25.
- UNITED STATES CRYOBANKS OF FLORIDA, INC., ALTA-MONTE SPRINGS, FL:
2,411,612, CANC. INT. CL. 42.
- UNITED STATES DISTILLED PRODUCTS COMPANY, PRINCETON, MN:
3,314,535, INT. CL. 33.
- UNITED STATES GEOSPATIAL INTELLIGENCE FOUNDATION, HERNDON, VA:
3,311,665, PUB. 7-31-2007. MULTIPLE CLASS, INT. CLS. 16, 35 AND 41.
- UNITED STATES GOLF ASSOCIATION, FAR HILLS, NJ, AKA USGA:
2,086,902, REN. 9-13-07. MULTIPLE CLASS, INT. CLS. 18 AND 25.
- UNITED STATES GYMNASTICS FEDERATION, INDIANAPOLIS, IN:
3,310,534, PUB. 7-31-2007. INT. CL. 41.
- UNITED STATES HUNTER JUMPER ASSOCIATION, LEXINGTON, KY:
3,314,424, INT. CL. 16.
- UNITED STATES MARINE CORPS, A COMPONENT OF THE DEPARTMENT OF THE NAVY, ARLINGTON, VA:
3,313,474, INT. CL. 35.
- UNITED STATES MINERAL PRODUCTS COMPANY, STANHOPE, NJ, DBA ISOLATEK INTERNATIONAL:
2,093,722, REN. 9-10-07. INT. CL. 16.
- UNITED STATES POSTAL SERVICE, WASHINGTON, DC:
2,410,890, CANC. MULTIPLE CLASS, INT. CLS. 35 AND 39.
3,314,759, MULTIPLE CLASS, INT. CLS. 16, 35 AND 39.
- UNITED STATES TENNIS ASSOCIATION INCORPORATED, WHITE PLAINS, NY:
2,410,953, CANC. INT. CL. 25.
- UNITED TOBACCO DISTRIBUTORS INC, SUNRISE, FL:
3,314,694, INT. CL. 34.
- UNITED WATER LEAKGUARD INC., HARRINGTON PARK, NJ:
2,411,388, CANC. INT. CL. 37.
- UNITUS, INC., REDMOND, WA:
3,311,829, PUB. 7-31-2007. INT. CL. 36.
- UNITY POWER LLC, ALEXANDRIA, VA:
3,313,230, INT. CL. 42.
- UNIVERSAL DE DESARROLLOS ELECTRONICOS, S.A., 08226 TERRASSA, SPAIN:
3,311,886, PUB. 7-31-2007. MULTIPLE CLASS, INT. CLS. 9 AND 28.
- UNIVERSAL ENERGY CORPORATION, TORONTO, CANADA:
3,312,415, PUB. 7-31-2007. MULTIPLE CLASS, INT. CLS. 35 AND 36.
- UNIVERSAL LENDING CORPORATION, DENVER, CO:
2,410,702, CANC. INT. CL. 36.
- UNIVERSAL PHOTONICS INC., HICKSVILLE, NY:
2,021,045, CANC. INT. CL. 3.
- UNIVERSITY GAMES CORPORATION, SAN FRANCISCO, CA:
3,312,097, PUB. 7-31-2007. INT. CL. 28.
- UNIVERSITY INSTRUCTORS, INC, STAUNTON, VA:
3,310,552, PUB. 7-31-2007. INT. CL. 41.
- UNIVERSITY OF KENTUCKY, LEXINGTON, KY:
2,110,576, REN. 9-9-07. MULTIPLE CLASS, INT. CLS. 16 AND 25.

- UNIVERSITY OF NEW HAMPSHIRE, DURHAM, NH:
3,312,266, PUB. 7-31-2007. INT. CL. 42.
- UNIVERSITY OF SOUTH FLORIDA, TAMPA, FL:
3,314,351, INT. CL. 44.
- UNIVERSITY OF TULSA, THE, TULSA, OK:
2,091,092, REN. 9-10-07. MULTIPLE CLASS, INT. CLS. 14,
16, 25 AND 41.
- UNIVISION RADIO, INC., DALLAS, TX:
2,410,389, CANC. MULTIPLE CLASS, INT. CLS. 18 AND
25.
2,410,393, CANC. MULTIPLE CLASS, INT. CLS. 18 AND
25.
2,410,394, CANC. MULTIPLE CLASS, INT. CLS. 18 AND
25.
- UP PHIT INC., TOMBALL, TX:
3,312,191, PUB. 7-31-2007. INT. CL. 25.
- UPNP IMPLEMENTERS CORPORATION, SAN RAMON,
CA:
3,312,995, U.S. CL. A.
- UPPER CORNER LACROSSE, LLC, ASHBURN, VA:
3,310,880, PUB. 7-31-2007. MULTIPLE CLASS, INT. CLS.
25 AND 41.
3,310,884, PUB. 7-31-2007. INT. CL. 25.
- UPSHER-SMITH LABORATORIES, INC., MAPLE GROVE,
MN:
1,486,671, REN. 9-10-07. INT. CL. 5.
2,166,535, REN. 9-10-07. INT. CL. 5.
- URBANA CITYSPA & TEABAR, INC, CHARLOTTE, NC:
3,312,389, PUB. 7-31-2007. INT. CL. 44.
- US HOUSING LLC., DAVIS, CA:
2,410,459, CANC. INT. CL. 36.
- USA GROUP, INC., INDIANAPOLIS, IN TO SALLIE MAE,
INC., RESTON, VA:
2,020,958, CANC. INT. CL. 36.
2,020,964, CANC. INT. CL. 36.
- USA TEE TIMES GENERAL PARTNERSHIP, SAN JOSE, CA:
2,410,151, CANC. INT. CL. 41.
2,410,152, CANC. INT. CL. 41.
- USA.NET, INC., COLORADO SPRINGS, CO:
2,211,431, AM. INT. CL. 38.
- USAGENCY, INC., LEWISBURG, PA:
3,312,102, PUB. 7-31-2007. INT. CL. 41.
3,315,001, INT. CL. 41.
- USERSCAPE, INC, LAGRANGEVILLE, NY:
3,310,572, PUB. 7-31-2007. INT. CL. 9.
- UTAH VALLEY PEDIATRICS, L.C., PROVO, UT:
3,312,040, PUB. 7-31-2007. INT. CL. 44.
- UTILIMAN SYSTEMS, INC., NORCROSS, GA:
2,409,793, CANC. MULTIPLE CLASS, INT. CLS. 35 AND
37.
- UUNET TECHNOLOGIES, INC., FAIRFAX, VA:
2,410,287, CANC. INT. CL. 38.
2,410,760, CANC. INT. CL. 37.
2,410,761, CANC. INT. CL. 38.
- V&S VIN & SPRIT AKTIEBOLAG, S-117 97 STOCKHOLM,
SWEDEN:
2,409,844, CANC. INT. CL. 33.
2,409,873, CANC. INT. CL. 33.
- V&S VIN & SPRIT AKTIEBOLAG (PUBL), STOCKHOLM,
SWEDEN:
3,310,426, PUB. 7-31-2007. INT. CL. 33.
- VAIL TRADEMARKS, INC., VAIL, CO:
3,310,946, PUB. 7-31-2007. INT. CL. 37.
3,310,949, PUB. 7-31-2007. INT. CL. 36.
3,311,481, PUB. 7-31-2007. INT. CL. 37.
3,311,482, PUB. 7-31-2007. INT. CL. 37.
- VAISALA OYJ, VANTAA, FINLAND:
1,456,349, REN. 9-11-07. INT. CL. 9.
- VALAGRO S.P.A., ITALY:
3,312,705, PUB. 7-31-2007. INT. CL. 1.
- VALGARD OF PINECREST, LLP, MIAMI, FL:
3,313,154, INT. CL. 39.
- VALIANT TECHNOLOGIES, INC., SAN DIEGO, CA:
3,310,818, PUB. 7-31-2007. INT. CL. 1.
- VALISERE INDUSTRIA E COMERCIO LTDA., MAUA,
BRAZIL:
3,311,430, PUB. 7-31-2007. INT. CL. 25.
- VALOIS SAS, 27110 LE NEUBOURG, FRANCE:
3,310,476, PUB. 7-31-2007. INT. CL. 10.
- VALPAK DIRECT MARKETING SYSTEMS, INC., LARGO,
FL:
2,411,020, CANC. INT. CL. 35.
- VALUED SALES, INC., SANTA ROSA, CA:
3,311,016, PUB. 7-31-2007. INT. CL. 35.
- VAN DER BLOM SAPP, MARGRET, MARIETTA, GA:
2,021,179, CANC. MULTIPLE CLASS, INT. CLS. 29 AND
30.
- VANILLASOFT, INC, PLANO, TX:
3,313,448, INT. CL. 42.
- VANITY FAIR, INC., WILMINGTON, DE:
2,411,347, CANC. INT. CL. 25.
2,411,355, CANC. INT. CL. 25.
- VANTAGE BUSINESS SUPPORT & INSURANCE SERVICES,
EMERYVILLE, CA:
3,310,595, PUB. 7-31-2007. INT. CL. 36.
- VARIAN ASSOCIATES, INC., PALO ALTO, CA:
1,418,990, CANC. INT. CL. 9.
- VBAZ CORPORATION, LAS VEGAS, NV:
2,410,491, CANC. MULTIPLE CLASS, INT. CLS. 9 AND
42.
- VEAL CONNECTION CORPORATION, THE, SANTA ROSA,
CA:
1,419,361, CANC. INT. CL. 29.
- VECIMA NETWORKS INC., VICTORIA, BRITISH COLUM-
BIA, CANADA:
3,310,389, PUB. 7-31-2007. INT. CL. 9.
- VECTRIX CORPORATION, DALLAS, TX:
2,410,775, CANC. INT. CL. 35.
- VEGAS.COM, LLC, HENDERSON, NV:
3,311,739, PUB. 7-31-2007. INT. CL. 43.
- VEKTEK, INC., EMPORIA, KS:
1,453,949, REN. 9-8-07. INT. CL. 7.
3,312,497, PUB. 7-31-2007. INT. CL. 7.
- VELP SCIENTIFICA S.R.L., ITALY:
3,312,873, PUB. 7-31-2007. INT. CL. 9.
- VELTEK ASSOCIATES, INC., MALVERN, PA:
3,313,331, INT. CL. 42.
- VENUS KNITTING MILLS, INC., MURRAY HILL, NJ:
3,311,026, PUB. 7-31-2007. INT. CL. 25.
- VERACODE, INC., BURLINGTON, MA:
3,314,622, INT. CL. 42.
- VERALLO-ROWELL, DRA. VERMÉN, MAKATI, METRO
MANILA, PHILIPPINES:
3,310,936, PUB. 7-31-2007. INT. CL. 3.
3,310,939, PUB. 7-31-2007. INT. CL. 5.
3,310,940, PUB. 7-31-2007. INT. CL. 16.
3,310,941, PUB. 7-31-2007. INT. CL. 18.
3,310,942, PUB. 7-31-2007. INT. CL. 21.
- VERDE REALTY OPERATING PARTNERSHIP L.P., EL
PASO, TX:
3,313,222, MULTIPLE CLASS, INT. CLS. 36 AND 37.
3,313,224, MULTIPLE CLASS, INT. CLS. 36 AND 37.
- VEREIN MÜNCHNER BRAUEREIEN E.V., 80333 MÜNCH-
EN, FED REP GERMANY:
3,312,719, PUB. 7-31-2007. MULTIPLE CLASS, INT. CLS.
32 AND 43.
- VERINT AMERICAS INC., ROSWELL, GA:
3,310,459, PUB. 7-31-2007. INT. CL. 9.
- VERISMA SYSTEMS, INC., PUEBLO, CO:
3,313,522, MULTIPLE CLASS, INT. CLS. 9, 35, 36, 39, 42
AND 44.
- VERITY, JULIE L., WAPPINGERS FALLS, NY:
3,311,072, PUB. 7-31-2007. INT. CL. 16.
- VERMAR S.R.L., I-20121 MILANO, ITALY:
3,312,745, PUB. 7-31-2007. MULTIPLE CLASS, INT. CLS.
3, 18 AND 25.
- VERMONT TEDDY BEAR CO., INC., THE, SHELBURNE,
VT:
2,131,281, REN. 9-8-07. MULTIPLE CLASS, INT. CLS. 28
AND 35.
- VERNON J. EDWARDS, CONSULTANT, LLC, LAKE OSWE-
GO, OR:
3,311,040, PUB. 7-31-2007. INT. CL. 41.
- VERSAR, INC., SPRINGFIELD, VA:
3,310,626, PUB. 7-17-2007. MULTIPLE CLASS, INT. CLS.

- 35, 37, 42 AND 45.
 VERTELLUS SPECIALTIES INC., INDIANAPOLIS, IN:
 3,314,651, INT. CL. 1.
 3,314,755, INT. CL. 1.
 VERTIFLEX, INC., SAN CLEMENTE, CA:
 3,313,800, INT. CL. 10.
 VERUS PHARMACEUTICALS INC., SAN DIEGO, CA:
 3,311,867, PUB. 7-31-2007. INT. CL. 5.
 VERYFINE PRODUCTS, INC., NORTHFIELD, IL:
 3,314,248, INT. CL. 32.
 VETO BV, 2404 HN ALPHEN AAN DEN RIJN, NETHERLANDS:
 2,410,036, CANC. INT. CL. 8.
 VETOQUINOL U.S.A., INC., TAMPA, FL TO NEOGEN CORPORATION, LANSING, MI:
 2,021,323, CANC. INT. CL. 5.
 VETTER UMFORMTECHNIK GMBH, BURBACH, FED REP GERMANY:
 3,312,330, PUB. 7-31-2007. INT. CL. 12.
 VIACOM INTERNATIONAL INC., NEW YORK, NY:
 2,411,152, CANC. INT. CL. 41.
 3,312,123, PUB. 7-31-2007. INT. CL. 16.
 3,312,124, PUB. 7-31-2007. INT. CL. 38.
 3,313,702, INT. CL. 41.
 3,313,708, INT. CL. 41.
 3,313,911, INT. CL. 38.
 3,314,496, INT. CL. 41.
 VIBES BASE GROUP CORP., EL MONTE, CA:
 3,310,354, PUB. 4-24-2007. INT. CL. 25.
 VICK, BILL, PLANO, TX:
 2,410,752, CANC. INT. CL. 35.
 VICTORIA ALBI S.A.R.L., 75010 PARIS, FRANCE:
 3,310,414, PUB. 7-31-2007. INT. CL. 3.
 VICTORIA'S SECRET STORES BRAND MANAGEMENT, INC., REYNOLDSBURG, OH:
 3,313,357, INT. CL. 3.
 3,313,953, INT. CL. 3.
 VIEWDO LLC, OAKLAND, CA, AKA VIEWDO:
 3,314,236, INT. CL. 9.
 VIEWFINDER PRODUCTIONS, LLC, BOSTON, MA:
 3,310,337, PUB. 7-31-2007. INT. CL. 35.
 VIEWSONIC CORPORATION, WALNUT, CA:
 2,409,827, CANC. INT. CL. 9.
 VIKING SURFBOARDS, INC., DAVIE, FL:
 3,312,248, PUB. 7-31-2007. MULTIPLE CLASS, INT. CLS. 18, 25 AND 28.
 VILLACRESES, LUIS ALFREDO, ELMHURST, NY:
 3,313,580, INT. CL. 29.
 VILLAGE TAVERN, INC., THE, WINSTON-SALEM, NC:
 2,020,518, CANC. INT. CL. 42.
 VINNY'S, LLC, UNIONTOWN, PA:
 3,314,349, INT. CL. 43.
 3,314,353, INT. CL. 43.
 VINOS SANTA EMA S.A., ISLA DE MAIPO, CHILE:
 3,314,023, INT. CL. 33.
 3,314,202, INT. CL. 33.
 VINTESSENTIAL LABORATORIES PTY LTD, AUSTRALIA:
 3,312,818, PUB. 7-31-2007. MULTIPLE CLASS, INT. CLS. 1, 9 AND 42.
 VIOX CORPORATION, SEATTLE, WA:
 3,311,582, PUB. 7-31-2007. INT. CL. 21.
 VIRBAC CORPORATION, FORT WORTH, TX:
 1,453,783, REN. 9-13-07. INT. CL. 1.
 VIRGIN COMICS, LLC, HOLMDEL, NJ:
 3,314,283, INT. CL. 16.
 VIRGIN MOBILE USA, LLC, WARREN, NJ:
 3,314,488, INT. CL. 38.
 VIRTUALPBX.COM, INC., SAN JOSE, CA:
 3,312,146, PUB. 7-31-2007. INT. CL. 38.
 VISALUS HOLDINGS LLC, TROY, MI:
 3,312,137, PUB. 7-31-2007. MULTIPLE CLASS, INT. CLS. 5 AND 35.
 VISCAR, INC., EL PASO, TX:
 3,310,362, PUB. 7-31-2007. INT. CL. 43.
 VISINSKI, MICHELLE, SANTAY, MONROE TOWNSHIP, NJ:
 3,312,521, PUB. 7-31-2007. INT. CL. 41.
 VISION COMPUTER WORKS, INC., VENICE, CA:
 3,311,297, PUB. 7-31-2007. INT. CL. 35.
 VISION SERVICE PLAN, RANCHO CORDOVA, CA:
 3,314,124, INT. CL. 44.
 VISION 2 EXECUTION, LLC, LAGUNA BEACH, CA:
 3,311,340, PUB. 7-31-2007. INT. CL. 35.
 VISIONCORP INTERNATIONAL INC., EDMONTON, CANADA:
 3,313,452, INT. CL. 9.
 VISIONIX LTD., JERUSALEM, ISRAEL:
 2,410,211, CANC. INT. CL. 9.
 VISIONQUEST INDUSTRIES, INC., IRVINE, CA:
 3,313,947, INT. CL. 10.
 VISIONS EAST, INC., FORT LAUDERDALE, FL:
 3,312,454, PUB. 7-31-2007. MULTIPLE CLASS, INT. CLS. 7 AND 37.
 VISTACARE, INC., SCOTTSDALE, AZ:
 3,310,236, PUB. 7-31-2007. INT. CL. 44.
 VISX, INCORPORATED, SANTA CLARA, CA:
 2,411,410, CANC. INT. CL. 10.
 VITALE AML CONSULTANTS, INC., NEW YORK, NY:
 3,313,891, INT. CL. 9.
 VIVAYOU FASHION INC., LOS ANGELES, CA:
 2,355,395, CANC. INT. CL. 25.
 VIVID ENTERTAINMENT, LLC, LOS ANGELES, CA:
 3,310,718, PUB. 7-31-2007. INT. CL. 21.
 VIZABILITY LLC, CEDAR RAPIDS, IA:
 3,313,690, INT. CL. 9.
 VL COMMUNICATIONS, L.C., POTOMAC, MD:
 2,411,309, CANC. INT. CL. 35.
 VMI - AZ EXTRUSION GMBH, 93486 RUNDING, FED REP GERMANY:
 3,311,809, PUB. 7-31-2007. MULTIPLE CLASS, INT. CLS. 6 AND 7.
 VOGEL PAINT AND WAX COMPANY, ORANGE CITY, IA:
 2,116,233, REN. 9-11-07. INT. CL. 2.
 VOICE GENESIS, INC., HUNTINGTON BEACH, CA:
 3,314,831, INT. CL. 38.
 3,314,832, INT. CL. 38.
 VOICE PREPAID, INC., MEDFORD, MA:
 3,310,867, PUB. 7-31-2007. INT. CL. 16.
 VOICE SOLUTIONS, LLC, SALISBURY, MD:
 3,312,480, PUB. 7-31-2007. INT. CL. 38.
 VOLATILE FREE, INC., BROOKFIELD, WI:
 3,312,360, PUB. 7-31-2007. MULTIPLE CLASS, INT. CLS. 1 AND 2.
 VOLKART MAY & ASSOCIATES, INC, MINNEAPOLIS, MN:
 2,410,224, CANC. INT. CL. 42.
 VOLLRATH COMPANY, L.L.C., THE, SHEBOYGAN, WI:
 2,410,739, CANC. INT. CL. 21.
 VOLNY, WILLIAM R.J., JR., YORKVILLE, IL:
 3,314,003, INT. CL. 45.
 VOLTAIRE LTD, HERZELIA, ISRAEL:
 2,411,480, CANC. INT. CL. 9.
 VONDERAHE, ROGER P., ROCHESTER, NY:
 3,314,278, INT. CL. 12.
 VP FOOTWEAR, INC., S. EL MONTE, CA:
 3,313,121, MULTIPLE CLASS, INT. CLS. 18 AND 28.
 VPP FILTER AND RECLAMATION, WATERVILLE, ME:
 2,411,169, CANC. INT. CL. 1.
 VRL INTERNATIONAL LTD., GRAND CAYMAN, CAYMAN ISLANDS:
 3,310,788, PUB. 7-31-2007. INT. CL. 41.
 VRL INTERNATIONAL LTD., GEORGETOWN, CAYMAN ISLANDS:
 3,314,756, INT. CL. 44.
 VRUMONA B.V., 3981 HT BUNNIK, NETHERLANDS:
 2,409,941, CANC. MULTIPLE CLASS, INT. CLS. 29, 30, 32 AND 33.
 VYGON, FRANCE:
 3,312,843, PUB. 7-31-2007. INT. CL. 10.
 V1 JETS INTERNATIONAL, INC., NEW YORK, NY:
 3,312,049, PUB. 7-31-2007. MULTIPLE CLASS, INT. CLS. 36 AND 39.
 W. E. BASSETT COMPANY, THE, SHELTON, CT:
 655,900, REN. 9-13-07. U.S. CL. 44 (INT. CL. 8).
 W.F. YOUNG, INC., EAST LONGMEADOW, MA:
 3,314,805, INT. CL. 5.

- W.R. COBB COMPANY, CRANSTON, RI:
2,411,536, CANC. INT. CL. 14.
- W.R. GRACE & CO.-CONN., BOCA RATON, FL:
1,418,994, CANC. INT. CL. 9.
- W.W. GRAINGER, INC., LAKE FOREST, IL:
2,410,808, CANC. INT. CL. 35.
2,410,814, CANC. INT. CL. 35.
- WA GOLF COMPANY, L.L.C., NEWTON, MA:
3,313,136, INT. CL. 43.
- WABEKE, JOHN A., COTTONWOOD, AZ:
3,312,179, PUB. 7-31-2007. INT. CL. 42.
- WADENA INSURANCE COMPANY, WEST DES MOINES,
IA:
3,314,396, INT. CL. 36.
3,314,397, INT. CL. 36.
- WAGNER GREENHOUSES, INC., MINNEAPOLIS, MN:
3,314,161, INT. CL. 31.
- WAHL CLIPPER CORPORATION, STERLING, IL:
3,313,045, INT. CL. 8.
- WAIMARIE ASSETS LIMITED, HONG KONG:
3,310,413, PUB. 7-31-2007. INT. CL. 9.
- WAL-MART STORES, INC., BENTONVILLE, AR:
3,312,112, PUB. 7-31-2007. INT. CL. 31.
3,313,969, INT. CL. 5.
- WALCHEM CORPORATION, HOLLISTON, MA:
3,311,578, PUB. 7-31-2007. INT. CL. 9.
- WALCO INTERNATIONAL, INC., WESTLAKE, TX:
3,314,318, INT. CL. 5.
- WALDROP, MARK A., ROSWELL, GA:
3,311,317, PUB. 7-31-2007. INT. CL. 41.
- WALL BEDS BY WILDING, LLC, ST. GEORGE, UT:
3,310,407, PUB. 7-31-2007. INT. CL. 20.
3,310,408, PUB. 7-31-2007. INT. CL. 20.
- WALLIN FUNERAL HOMES, SANGER, CA:
2,020,332, CANC. INT. CL. 42.
- WALLY BOYKO PRODUCTIONS, INC., WHITE CITY, OR:
3,311,391, PUB. 7-31-2007. INT. CL. 16.
- WALLY BOYKO PRODUCTIONS, INC., WHITE CITY, OK:
3,311,393, PUB. 7-31-2007. INT. CL. 35.
- WALSH, RIANNON, EAST COVENTRY, PA:
3,314,762, INT. CL. 5.
- WALSH, STEPHEN W., BRIDGTON, ME:
3,314,817, INT. CL. 28.
- WALTON CHAINTECH CORPORATION, TAIPEI COUNTY,
TAIWAN:
3,314,612, INT. CL. 9.
- WALTON, ADRIAN GEORGE, ILKLEY, WEST YORK-
SHIRE, UNITED KINGDOM:
3,312,688, PUB. 4-24-2007. MULTIPLE CLASS, INT. CLS.
36, 39 AND 43.
- WAN NET TECHNOLOGY, LTD. (BVI), TORTOLA, BR. VIR-
GIN ISLANDS:
3,311,663, PUB. 7-31-2007. MULTIPLE CLASS, INT. CLS.
9, 39, 41 AND 42.
- WARD, DANIEL R., CARLSBAD, CA:
3,311,859, PUB. 7-31-2007. INT. CL. 12.
- WARD, KRISTINA, LA JOLLA, CA AND WARD, CRAIG S.,
LA JOLLA, CA:
3,312,464, PUB. 7-31-2007. INT. CL. 41.
- WARDROBE STATIONERY, INC., FULLERTON, CA:
3,310,637, PUB. 7-31-2007. INT. CL. 16.
- WAREHOUSE CLUB, INC., NILES, IL:
1,419,523, CANC. INT. CL. 42.
- WARM UP AMERICA! FOUNDATION, GASTONIA, NC:
3,311,347, PUB. 7-31-2007. INT. CL. 45.
- WARNACO, INC., NEW YORK, NY:
2,411,460, CANC. INT. CL. 25.
- WARNER BROS. ENTERTAINMENT INC., BURBANK, CA:
2,020,848, CANC. INT. CL. 9.
- WARNER MANUFACTURING COMPANY, MINNEAPO-
LIS, MN:
2,122,721, REN. 9-7-07. INT. CL. 11.
2,122,721, CANC. INT. CL. 9.
- WARNER-LAMBERT COMPANY LLC, MORRIS PLAINS,
NJ:
3,174,850, CANC. MULTIPLE CLASS, INT. CLS. 3 AND 5.
3,197,301, CANC. MULTIPLE CLASS, INT. CLS. 3 AND 5.
- WARNER, JAN L., COLUMBIA, SC:
3,313,008, INT. CL. 45.
- WARNICK, BRUCE D., KNOXVILLE, TN:
2,411,295, CANC. INT. CL. 28.
- WARREN INDUSTRIES, INC., LAFAYETTE, IN:
2,021,455, CANC. INT. CL. 28.
- WARREN PUMPS, LLC, WARREN, MA:
3,312,338, PUB. 7-31-2007. INT. CL. 7.
- WARREN, JAMES EDWARD CHARLES, CHESHIRE SK12
1QJ, UNITED KINGDOM:
3,313,437, INT. CL. 25.
- WASATCH CREST MUTUAL INSURANCE COMPANY,
SALT LAKE CITY, UT:
2,410,153, CANC. INT. CL. 36.
2,410,163, CANC. INT. CL. 36.
- WASHABAMA, L.P., HUNTSVILLE, AL:
2,409,845, CANC. MULTIPLE CLASS, INT. CLS. 36 AND
37.
- WASHINGTON MUTUAL, INC., SEATTLE, WA:
3,313,767, INT. CL. 9.
- WASHINGTON SHOE COMPANY, KENT, WA:
3,314,137, INT. CL. 25.
3,314,138, MULTIPLE CLASS, INT. CLS. 18 AND 25.
- WASKOW, DAN, BRYAN, TX:
2,410,548, CANC. INT. CL. 35.
- WASNEY, DAVID A, CHICO, CA:
3,310,966, PUB. 7-31-2007. INT. CL. 43.
- WATCH SYSTEMS, LLC, COVINGTON, LA:
3,314,940, INT. CL. 42.
- WATCHWORLD LICENSING CORP., NEW YORK, NY:
2,410,923, CANC. INT. CL. 35.
- WATER STORE NETWORK, THE, LAS VEGAS, NV TO H2O
TO GO, LLC, MERCHANTVILLE, NJ, DBA PURIFIED
WATER TO GO:
2,022,848, CANC. INT. CL. 30.
- WATER WONDERS INC., SANTA MARIA, CA:
2,411,553, CANC. INT. CL. 11.
- WATERFORD RADIATOR, INC., WATERFORD, MI:
3,310,762, PUB. 7-31-2007. INT. CL. 37.
- WATERFORD WEDGWOOD PLC, KILBARRY, WATER-
FORD, IRELAND:
2,090,835, REN. 9-13-07. INT. CL. 21.
2,090,837, REN. 9-7-07. INT. CL. 21.
2,090,839, REN. 9-13-07. INT. CL. 21.
- WATKINS, INGA, NEW ROCHELLE, NY:
3,310,357, PUB. 7-31-2007. INT. CL. 41.
- WATTYL AUSTRALIA PTY. LTD., NEW SOUTH WALES,
AUSTRALIA:
1,482,099, REN. 9-7-07. INT. CL. 2.
1,482,100, REN. 9-7-07. INT. CL. 2.
- WAVE SYSTEMS CORP., NEW YORK, NY:
2,411,397, CANC. INT. CL. 35.
- WAYNE & JENDY, LLC, DALLAS, TX:
3,314,753, INT. CL. 7.
- WAYNE T. MOORE, IONE, CA:
3,314,428, INT. CL. 9.
- WBL ENTERPRISE LLC, DEVILS LAKE, ND:
3,311,877, PUB. 7-31-2007. INT. CL. 16.
- WEALTH ADVISOR GROUP LLC, HENDERSONVILLE, NC:
3,314,143, INT. CL. 36.
- WEB GRAPHICS, INC., MILFORD, IA:
3,314,516, INT. CL. 35.
- WEBB, LIZANNE E., RESEDA, CA AND KOENIG, JOHN L,
RESEDA, CA:
3,311,418, PUB. 7-31-2007. INT. CL. 41.
- WEBCONSULS, LLC, NEWPORT BEACH, CA:
3,314,603, INT. CL. 35.
- WEBENERGY.NET, INC., NEW YORK, NY:
3,314,631, INT. CL. 9.
- WEBSAFE, INC., BIRMINGHAM, AL:
3,312,098, PUB. 7-31-2007. INT. CL. 39.
- WEBSITE PROS, INC., JACKSONVILLE, FL:
2,411,130, CANC. MULTIPLE CLASS, INT. CLS. 9, 16, 35,
36, 38 AND 42.
- WEBSTER VETERINARY SUPPLY, INC., ST. PAUL, MN:
2,020,531, CANC. INT. CL. 31.

- WEDI, STEPHAN, D-48282 EMSDETTEN, FED REP GERMANY:
3,312,701, PUB. 7-31-2007. MULTIPLE CLASS, INT. CLS. 1, 2, 6, 9, 11, 17 AND 19.
- WEE GALLERY, INC., ST PETERSBURG, FL:
3,310,605, PUB. 7-10-2007. INT. CL. 16.
- WEF BROKERAGE SPECIALISTS, LLC, MIDDLETOWN, NJ:
3,310,767, PUB. 7-31-2007. INT. CL. 36.
- WEIGHT LOSS DIRECT, LLC, MAPLE GROVE, MN:
3,312,374, PUB. 7-31-2007. INT. CL. 5.
- WEINBERG, MICHAEL C., NORTH CANTON, OH:
2,410,164, CANC. INT. CL. 42.
- WEIR MINERALS NETHERLANDS B.V., NETHERLANDS:
3,312,883, PUB. 7-31-2007. INT. CL. 7.
- WEIR, VICTORIA LEE, WILDOMAR, CA:
3,310,569, PUB. 7-31-2007. INT. CL. 41.
- WEISS, ALAN, COLUMBUS, OH:
2,410,481, CANC. INT. CL. 41.
- WELCH FOODS INC., A COOPERATIVE, CONCORD, MA:
2,411,256, CANC. INT. CL. 30.
- WELLA AG, 64274 DARMSTADT, FED REP GERMANY:
651,000, REN. 9-13-07. U.S. CL. 51 (INT. CL. 3).
- WELLINX, INC., ST. LOUIS, MO:
3,310,982, PUB. 7-31-2007. INT. CL. 42.
- WELLMARK INTERNATIONAL, SCHAUMBURG, IL:
3,313,001, INT. CL. 5.
- WELLS' DAIRY, INC., LEMARS, IA:
3,310,182, PUB. 7-31-2007. INT. CL. 30.
- WELLS' DAIRY, INC., LE MARS, IA:
3,311,671, PUB. 7-31-2007. INT. CL. 30.
- WELLSPACE, INC., SOMERVILLE, MA:
2,410,373, CANC. INT. CL. 35.
- WELSER PROFILE AG, AUSTRIA:
3,312,923, PUB. 7-31-2007. MULTIPLE CLASS, INT. CLS. 6 AND 42.
- WELSER PROFILE AG, YBBSITZ, AUSTRIA:
3,312,924, PUB. 7-31-2007. MULTIPLE CLASS, INT. CLS. 6 AND 42.
- WELSER PROFILE AG, AUSTRIA:
3,312,932, PUB. 7-31-2007. MULTIPLE CLASS, INT. CLS. 6 AND 42.
- WELTON INVESTMENT CORPORATION, CARMEL, CA:
3,311,355, PUB. 7-31-2007. INT. CL. 36.
- WENGER SA, CH-2800 DELEMONT, SWITZERLAND:
2,094,131, REN. 9-12-07. MULTIPLE CLASS, INT. CLS. 14 AND 18.
- WERNER CO., GREENVILLE, PA:
3,314,217, INT. CL. 6.
- WES PAK INC., LITTLE ROCK, AR:
2,410,438, CANC. INT. CL. 16.
- WEST BEND HOUSEWARES, LLC, VERNON HILLS, IL:
3,314,058, INT. CL. 11.
- WEST BEND MUTUAL INSURANCE COMPANY, WEST BEND, WI:
3,314,986, INT. CL. 36.
- WEST COAST TANNING, LLC, PORTLAND, OR:
3,311,995, PUB. 7-31-2007. INT. CL. 44.
- WEST PHARMACEUTICAL SERVICES, INC., LIONVILLE, PA:
2,410,263, CANC. INT. CL. 40.
- WEST PUBLISHING CORPORATION, EAGAN, MN:
3,313,717, INT. CL. 42.
- WESTAR SEEDS INTERNATIONAL, INC., EL CENTRO, CA:
2,112,407, REN. 9-11-07. INT. CL. 31.
- WESTBLOCK PRODUCTS, INC., PORTLAND, OR:
1,419,204, CANC. INT. CL. 19.
- WESTBRIDGE AGRICULTURAL PRODUCTS, VISTA, CA, DBA WESTBRIDGE:
2,411,497, CANC. INT. CL. 5.
- WESTCOM SOFTWARE, LLC, FUQUAY-VARINA, NC:
3,314,456, INT. CL. 9.
- WESTERFIELD, DINAH BIRD, XENIA, OH:
3,314,495, MULTIPLE CLASS, INT. CLS. 33 AND 40.
- WESTERN FARM SERVICE, INC., FRESNO, CA:
3,313,389, INT. CL. 1.
- WESTERN HEALTH ADVANTAGE, SACRAMENTO, CA:
2,173,537, REN. 9-9-07. INT. CL. 42.
- WESTERN PULP PRODUCTS CO., CORVALLIS, OR:
3,312,116, PUB. 7-31-2007. MULTIPLE CLASS, INT. CLS. 16 AND 21.
- WESTERN RESERVE LIFE ASSURANCE CO. OF OHIO, ST. PETERSBURG, FL:
2,036,473, REN. 9-8-07. INT. CL. 36.
- WESTINGHOUSE ELECTRIC CORPORATION, NEW YORK, NY:
3,313,374, INT. CL. 11.
- WESTINGHOUSE LIGHTING CORPORATION, PHILADELPHIA, PA:
2,475,276, CANC. INT. CL. 11.
- WESTJET AIRLINES LTD., CALGARY, CANADA:
3,311,716, PUB. 7-31-2007. MULTIPLE CLASS, INT. CLS. 35, 39 AND 43.
- WESTMINSTER, INC., ATLANTA, GA:
3,313,819, INT. CL. 21.
- WET ENTERPRISES, INC., SUN VALLEY, CA:
1,474,503, REN. 9-7-07. INT. CL. 37.
- WEYERHAEUSER COMPANY, FEDERAL WAY, WA:
3,311,717, PUB. 7-31-2007. INT. CL. 19.
- WF ALLIANCE CORPORATION, ST. LOUIS, MO:
3,314,767, INT. CL. 35.
- WFC HOLDINGS CORPORATION, MINNEAPOLIS, MN, WELLS FARGO & COMPANY, SAN FRANCISCO, CA:
1,428,720, REN. 9-10-07. INT. CL. 36.
- WHAT I LIKE ABOUT JEW LLC, NEW YORK, NY:
3,313,889, MULTIPLE CLASS, INT. CLS. 25 AND 41.
- WHATABURGER, INC., CORPUS CHRISTI, TX:
2,409,945, CANC. INT. CL. 32.
- WHATTA COMPANY, CORNELIUS, NC:
2,410,019, CANC. MULTIPLE CLASS, INT. CLS. 21, 35, 40 AND 41.
- WHEATMARK, INC., TUCSON, AZ:
3,312,513, PUB. 7-31-2007. INT. CL. 41.
- WHEATON INDUSTRIES, INC., CHATTANOOGA, TN:
1,419,589, CANC. INT. CL. 9.
- WHEELABRATOR AIR POLLUTION CONTROL, INC., PITTSBURGH, PA:
2,411,478, CANC. INT. CL. 11.
- WHEELED COACH INDUSTRIES, INC., WINTER PARK, FL:
1,413,260, REN. 9-10-07. INT. CL. 12.
- WHITAKER CORPORATION, THE, WILMINGTON, DE, AMP INCORPORATED, HARRISBURG, PA:
1,453,011, REN. 9-9-07. INT. CL. 9.
- WHITE PARCEL, LLC, CHARLESTON, SC:
3,311,975, PUB. 7-31-2007. INT. CL. 35.
- WHITE, DAVID L., SHORT HILLS, NJ:
3,312,998, MULTIPLE CLASS, INT. CLS. 41 AND 42.
- WHITEFLASH.COM, INC., HOUSTON, TX:
3,312,233, PUB. 7-31-2007. INT. CL. 14.
- WHITFORD, TAYLOR & PRESTON L.L.P., BALTIMORE, MD:
3,310,651, PUB. 7-31-2007. INT. CL. 42.
- WHITESPACE SOFTWARE, LLC, SKANEATELES, NY:
3,314,222, MULTIPLE CLASS, INT. CLS. 35 AND 36.
- WHITETAIL INSTITUTE OF NORTH AMERICA, INC., PINTLALA, AL:
2,411,568, CANC. INT. CL. 5.
- WHITNEY INNOVATIONS, INC., ELK CREEK, CA:
3,311,323, PUB. 7-31-2007. INT. CL. 8.
- WHITTLE, TAMARA, LANTANA, FL:
2,477,430, CANC. INT. CL. 16.
- WHYTE AND MACKAY LIMITED, GLASGOW, UNITED KINGDOM, WHYTE & MACKAY GROUP PLC, THE, GLASGOW, G2 5RG, SCOTLAND:
2,040,242, REN. 9-13-07. INT. CL. 33.
- WICHITA COFFEE ROASTERIE, INC., WICHITA, KS:
3,312,261, PUB. 7-31-2007. INT. CL. 30.
- WICKED GOOD COMPANY, LLC, BRISTOL, RI:
3,311,541, PUB. 7-31-2007. INT. CL. 30.
- WICKED VISION LIMITED, LONDON, UNITED KINGDOM:
3,310,462, PUB. 7-31-2007. INT. CL. 28.
- WIDELOAD GAMES, INC., CHICAGO, IL:
3,310,587, PUB. 7-31-2007. INT. CL. 9.
3,312,659, PUB. 7-31-2007. INT. CL. 9.

- WILBUR-ELLIS COMPANY, SAN FRANCISCO, CA:
3,311,584, PUB. 7-31-2007. INT. CL. 1.
- WILD BIRD CENTERS OF AMERICA, INC., GLEN ECHO, MD:
3,313,743, INT. CL. 16.
- WILD GEESE IMPORTS LTD., NEW YORK, NY:
2,411,334, CANC. INT. CL. 35.
- WILD GOOSE HOLDING CO., INC., WILMINGTON, DE:
2,133,458, REN. 9-13-07. INT. CL. 42.
- WILDLIFE CONSERVATION SOCIETY, BRONX, NY:
2,409,832, CANC. INT. CL. 28.
- WILDWOOD INTERNATIONAL, OMAHA, NE:
1,419,316, CANC. INT. CL. 28.
- WILEY, DEBRA A., BOSTON, MA:
3,313,927, INT. CL. 18.
- WILHELM KACHELE GMBH, 73235 WEILHEIM, FED REP GERMANY:
2,087,142, REN. 9-11-07. INT. CL. 17.
- WILKENS MEDICAL GROUP, JELICO, TN:
3,311,244, PUB. 7-31-2007. INT. CL. 41.
- WILKES GROUP, INC., THE, OLD LYME, CT:
2,090,928, REN. 9-13-07. INT. CL. 3.
- WILKES UNIVERSITY/JUSC, WILKES-BARRE, PA:
3,314,968, INT. CL. 41.
- WILLIAM CAMPBELL D/B/A/ LIFETIME COASTAL VACATIONS WORLDWIDE, CHANDLER, AZ:
3,312,597, PUB. 7-31-2007. INT. CL. 39.
- WILLIAM GRANT & SONS, INC., EDISON, NJ:
2,048,911, REN. 9-11-07. INT. CL. 33.
- WILLIAM R. HOUGH & CO., INC., ST. PETERSBURG, FL:
2,020,105, CANC. INT. CL. 36.
- WILLIAM T. CONN, CLINTON, WA:
3,311,114, PUB. 7-31-2007. INT. CL. 35.
- WILLIAMS ELECTRONICS GAMES, INC., CHICAGO, IL:
2,092,088, REN. 9-13-07. INT. CL. 28.
- WILLIAMS, NIKKI N., HOUSTON, TX:
3,312,093, PUB. 7-31-2007. INT. CL. 44.
- WILLIAMS, PHYLLIS, STUDIO CITY, CA:
2,411,190, CANC. INT. CL. 42.
2,411,191, CANC. INT. CL. 42.
- WILLIAMSON, DIXIE LAIN, LAFAYETTE, LA:
3,310,225, PUB. 7-31-2007. MULTIPLE CLASS, INT. CLS. 16 AND 24.
- WILLOW DRIVE NURSERY, INC., EPHRATA, WA:
2,020,489, CANC. INT. CL. 31.
- WILSETT CORPORATION, THE, HOOKSETT, NH:
2,411,453, CANC. MULTIPLE CLASS, INT. CLS. 41 AND 42.
- WILSON, DARRICK, ROCHESTER, NY:
3,314,108, INT. CL. 41.
- WIMBOCK GMBH, D - 8216 REIT IM WINKL, FED REP GERMANY:
2,037,380, REN. 9-13-07. INT. CL. 11.
- WINDMERE CORPORATION, MIAMI LAKES, FL TO APPLICA CONSUMER PRODUCTS, INC., MIRAMAR, FL:
2,021,230, CANC. INT. CL. 8.
- WINDSET GREENHOUSES LIMITED PARTNERSHIP, BRITISH COLUMBIA, CANADA:
3,313,589, INT. CL. 31.
- WINDSWELL DESIGNS, LLC, CARY, NC:
3,313,252, INT. CL. 28.
- WINE MASTER CELLARS LLC, DENVER, CO:
3,311,538, PUB. 7-31-2007. INT. CL. 20.
- WINELOVERS, LLC, BOCA RATON, FL:
3,314,641, INT. CL. 35.
- WINGS SYSTEMS LIMITED, GREECE:
3,312,703, PUB. 7-31-2007. MULTIPLE CLASS, INT. CLS. 9, 16, 23, 26, 41 AND 42.
- WINK TECHNOLOGIES INC. (A DELAWARE CORPORATION), LOS ALTOS, CA:
3,313,175, INT. CL. 42.
- WINMARK CORPORATION, MINNEAPOLIS, MN:
2,411,390, CANC. INT. CL. 35.
- WINN-DIXIE STORES, INC., JACKSONVILLE, FL:
3,314,325, INT. CL. 29.
- WINNER GLOBAL DEFENSE LLC, SHARON, PA:
3,314,560, INT. CL. 7.
- WINNER MANIA LIMITED, ALTOONA, PA:
2,411,419, CANC. INT. CL. 28.
- WINNING LINK, INC., HIGH POINT, NC:
3,314,242, INT. CL. 20.
- WINTER EQUIPMENT COMPANY, INC., WILLOUGHBY, OH:
3,311,090, PUB. 7-31-2007. INT. CL. 7.
- WINTER GARDENS QUALITY FOODS, INC., NEW OXFORD, PA:
3,312,548, PUB. 7-31-2007. INT. CL. 29.
- WINTER PARK RECREATIONAL ASSOCIATION, WINTER PARK, CO:
2,020,248, CANC. MULTIPLE CLASS, INT. CLS. 25 AND 41.
- WIOR, CAROL, BELL GARDENS, CA:
3,312,628, PUB. 7-31-2007. INT. CL. 25.
- WISCONSIN ALUMINUM FOUNDRY COMPANY, INC., MANITOWOC, WI:
3,312,634, PUB. 7-31-2007. INT. CL. 21.
- WISCONSIN ORGANIZATION FOR ASIAN AMERICANS, INC., MILWAUKEE, WI:
3,312,134, PUB. 7-31-2007. INT. CL. 41.
- WISE BUYS INC., ATLANTA, GA:
3,314,256, INT. CL. 25.
- WISE FOODS, INC., BERWICK, PA, MOORE'S POTATO CHIP CO., INC., BRISTOL, VA:
1,086,546, REN. 9-13-07. MULTIPLE CLASS, INT. CLS. 29 AND 30.
- WISE FOODS, INC., BERWICK, PA:
2,054,967, REN. 9-10-07. MULTIPLE CLASS, INT. CLS. 29 AND 30.
- 2,105,371, REN. 9-13-07. MULTIPLE CLASS, INT. CLS. 29 AND 30.
- WISHES & MORE, FRIDLEY, MN:
3,313,507, MULTIPLE CLASS, INT. CLS. 36 AND 45.
- WISHNACK, STEPHEN, ANDOVER, MA:
2,093,113, REN. 9-7-07. MULTIPLE CLASS, INT. CLS. 9 AND 41.
- WISPL.NET, INC., ATLANTA, GA:
3,310,669, PUB. 7-31-2007. MULTIPLE CLASS, INT. CLS. 40 AND 42.
- WM K. WALTHERS, INC., MILWAUKEE, WI, LIFE-LIKE PRODUCTS, INC., BALTIMORE, MD:
2,064,793, REN. 9-12-07. INT. CL. 28.
- WM. R. HAGUE, INC., GROVEPORT, OH:
1,500,440, REN. 9-10-07. INT. CL. 11.
- WM. WRIGLEY JR. COMPANY, CHICAGO, IL, WM. WRIGLEY JR. CO., CHICAGO, IL:
64,816, REN. 9-7-07. U.S. CL. 46 (INT. CL. 30).
- WMK HOLDINGS, INC., WILMINGTON, DE:
3,313,878, INT. CL. 35.
3,314,554, INT. CL. 29.
- WMS GAMING INC., WAUKEGAN, IL:
3,314,567, INT. CL. 9.
- WMS, INC., SUN VALLEY, CA:
2,020,573, CANC. INT. CL. 12.
- WOLFENSOHN, JAMES DAVID, WAGGA WAGGA, AUSTRALIA:
3,310,456, PUB. 7-31-2007. INT. CL. 33.
- WOLTERS KLUWER HEALTH, INC., CONSHOHOCKEN, PA:
2,410,284, CANC. INT. CL. 42.
- WOLTERS KLUWER HEALTH, INC., AMBLER, PA:
3,311,542, PUB. 7-31-2007. INT. CL. 16.
- WOLVERINE BEER LLC, ANN ARBOR, MI:
3,314,678, INT. CL. 32.
3,314,684, INT. CL. 32.
- WOLVERINE OUTDOORS, INC., ROCKFORD, MI:
3,314,645, INT. CL. 25.
- WOMEN EXPRESS, INC., BOSTON, MA:
2,093,272, REN. 9-7-07. INT. CL. 16.
- WOOD FLOOR MART, INC., MIAMI, FL:
3,314,598, INT. CL. 19.
- WOOD-FORUM HANDELSGESELLSCHAFT M.B.H., AUSTRIA:
3,312,863, PUB. 7-31-2007. MULTIPLE CLASS, INT. CLS. 3, 19 AND 27.

- WOODARD PHOTOGRAPHIC, INC., BELLEVUE, OH:
3,310,388, PUB. 7-31-2007. INT. CL. 41.
- WOODFORD INDUSTRIES, INC., LOS ANGELES, CA:
3,314,780, INT. CL. 9.
- WOODLAND PUBLISHING, INC., PARK CITY, UT:
3,312,209, PUB. 7-31-2007. INT. CL. 41.
- WOODS, VAN, NEW YORK, NY:
3,311,986, PUB. 7-31-2007. INT. CL. 41.
- WOODSIDE-ATHERTON AUXILIARY FOR CHILDREN,
MENLO PARK, CA:
3,311,944, PUB. 7-31-2007. MULTIPLE CLASS, INT. CLS.
36 AND 43.
- WOODSTOCK INTERNATIONAL, INC., BELLINGHAM,
WA:
2,168,567. REN. 9-7-07. INT. CL. 8.
- WOODWARD, DAVID, FALLS CHURCH, VA:
2,410,721, CANC. INT. CL. 28.
- WORD OF FAITH WORLD OUTREACH CENTER, INC.,
DALLAS, TX:
1,419,507, CANC. INT. CL. 41.
- WORDSWORTH, CHLOE FAITH, SCOTTSDALE, AZ:
3,314,451, INT. CL. 41.
3,314,452, INT. CL. 41.
- WORK GEAR, LLC, WEYMOUTH, MA:
2,483,153, CANC. INT. CL. 25.
- WORKING CHEMICAL SOLUTIONS, INC., EL DORADO,
AR:
3,313,937, MULTIPLE CLASS, INT. CLS. 3 AND 5.
- WORLD DIAMOND SOURCE, INC., POMPANO BEACH, FL:
3,310,705, PUB. 7-31-2007. INT. CL. 7.
3,310,707, PUB. 7-31-2007. INT. CL. 7.
3,310,708, PUB. 7-31-2007. INT. CL. 7.
- WORLD ECONOMIC FORUM, SWITZERLAND:
3,312,910, PUB. 7-31-2007. MULTIPLE CLASS, INT. CLS.
9, 16 AND 38.
- WORLD IMPORTS INTERNATIONAL, INC., FORT LAU-
DERDALE, FL:
3,314,128, INT. CL. 11.
- WORLD LOGISTICS SERVICE (U.S.A.), INC., LONG
BEACH, CA:
3,312,350, PUB. 7-31-2007. INT. CL. 35.
- WORLD PROPERTIES INTERNATIONAL INC., WETHERS-
FIELD, CT:
3,314,118, INT. CL. 35.
- WORLD SHIPPING COUNCIL, WASHINGTON, DC:
3,312,563, PUB. 7-31-2007. INT. CL. 35.
- WORLD STORIES, L.L.C., UNION, NJ:
2,410,317, CANC. INT. CL. 35.
- WORLD WIDE JEWELRY ONLINE, INC., NEW YORK, NY:
3,311,546, PUB. 7-31-2007. INT. CL. 35.
- WORLD WRESTLING ENTERTAINMENT, INC., STAM-
FORD, CT:
3,314,280, INT. CL. 25.
- WORLDFREE.NET, INC., BEVERLY HILLS, CA:
2,410,892, CANC. INT. CL. 9.
- WORLD SERVE MINISTRIES, FRISCO, TX:
3,310,561, PUB. 7-31-2007. INT. CL. 36.
- WORLDTELEMETRY, INC., TULSA, OK:
3,310,800, PUB. 7-31-2007. INT. CL. 42.
- WORLDWIDE CHRISTIAN SCHOOLS, GRAND RAPIDS,
MI:
1,452,532. REN. 9-13-07. MULTIPLE CLASS, INT. CLS. 37
AND 39.
- WORLDWIDE CLEANING SOLUTIONS, INC., WOBURN,
MA:
3,310,897, PUB. 7-31-2007. INT. CL. 3.
- WORLDWIDE DREAMS LLC, NEW YORK, NY:
2,409,683, CANC. INT. CL. 18.
- WORLDWIDE FINANCIAL SERVICE, INC., SOUTHFIELD,
MI:
2,411,304, CANC. INT. CL. 36.
- WORLDWIDE FINANCIAL SERVICE, INC., BIRMING-
HAM, MI:
2,411,305, CANC. INT. CL. 36.
- WORLDWIDE NUTRACEUTICALS, MCKINNEY, TX:
3,313,257, INT. CL. 5.
- WORTHINGTON CAREER SERVICES LLC, COLUMBUS,
OH:
3,312,403, PUB. 7-31-2007. INT. CL. 35.
- WOVEN ELECTRONICS CORPORATION, GREENVILLE,
SC:
3,313,134, INT. CL. 9.
- WRANGLER APPAREL CORP., WILMINGTON, DE:
3,311,624, PUB. 7-31-2007. INT. CL. 25.
- WRG SERVICES INC., WILLOUGHBY, OH:
3,311,646, PUB. 7-31-2007. INT. CL. 9.
- WRIGHT EXPRESS CORPORATION, SOUTH PORTLAND,
ME:
3,311,744, PUB. 7-31-2007. MULTIPLE CLASS, INT. CLS.
35 AND 36.
- WRIGHT, CHAD D., MARIETTA, OH:
3,311,007, PUB. 7-31-2007. INT. CL. 30.
- WRIGHT, GARIN, C., LAKEWOOD, OH:
3,312,617, PUB. 4-10-2007. INT. CL. 32.
- WRIGHTSOFT CORPORATION, LEXINGTON, MA:
3,312,008, PUB. 7-31-2007. INT. CL. 9.
- WTC-TRADE MART, L.P., DALLAS, TX:
3,310,706, PUB. 7-31-2007. INT. CL. 41.
- WYETH, MADISON, NJ:
3,310,666, PUB. 7-31-2007. INT. CL. 44.
- WYNDHAM TM CORP., LAS VEGAS, NV:
3,313,324, INT. CL. 43.
- XANTREX INTERNATIONAL, THE GARRISON, BARBA-
DOS:
3,311,748, PUB. 7-31-2007. MULTIPLE CLASS, INT. CLS. 9
AND 11.
- XENCOR, INC., MONROVIA, CA:
3,314,272, INT. CL. 42.
- XENOGEN CORPORATION, ALAMEDA, CA:
3,312,979, MULTIPLE CLASS, INT. CLS. 1 AND 9.
- XES ENTERTAINMENT LLC, STOUGHTON, MA:
3,314,703, INT. CL. 41.
- XIANGSHAN SOUTH AQUATIC FOOD CO., LTD., CHINA:
3,312,838, PUB. 7-31-2007. INT. CL. 29.
- XL SPECIALTY PERCUSSION, INC., HUNTERTOWN, IN:
1,419,136, CANC. INT. CL. 15.
- XORAN TECHNOLOGIES, LLC, ANN ARBOR, MI:
2,875,552, COR. INT. CL. 10.
- XSIGO SYSTEMS, INC., SUNNYVALE, CA:
3,313,611, INT. CL. 9.
- XTREME COIL DRILLING CORP., CALGARY, ALBERTA,
CANADA:
3,313,926, INT. CL. 37.
- XU JIAMAN, PERTH, AUSTRALIA:
3,311,198, PUB. 7-31-2007. MULTIPLE CLASS, INT. CLS.
18 AND 25.
- XYVEST HOLDINGS, INC., WALNUT CREEK, CA:
2,137,728. REN. 9-12-07. INT. CL. 36.
- Y.Z.Y. INC, MIAMI, FL:
3,314,287, INT. CL. 3.
3,314,319, INT. CL. 3.
- Y&Z WORLD DEVELOPMENT INC., NEW YORK, NY:
3,313,450, INT. CL. 25.
- YACHT CITY, INC., SAINT PETERSBURG, FL:
2,410,585, CANC. INT. CL. 41.
- YADULLAH T. JORDAN, COLUMBUS, OH:
3,310,819, PUB. 7-31-2007. INT. CL. 9.
- YAHOO! INC., SUNNYVALE, CA:
2,088,896. REN. 9-7-07. MULTIPLE CLASS, INT. CLS. 35
AND 42.
- YAKABOD, INC., WESTMINSTER, MD:
3,311,871, PUB. 7-31-2007. MULTIPLE CLASS, INT. CLS. 9
AND 42.
- YAMAHA CORPORATION, SHIZUOKA 430, JAPAN:
3,313,163, INT. CL. 9.
- YAMASHITA FISHING TACKLES COMPANY LIMITED,
MIURA, KANAGAWA PREFECTURE, 238-0231, JAPAN:
2,411,220, CANC. INT. CL. 28.
- YAMASHITA FISHING TACKLES COMPANY LIMITED,
238-0231, JAPAN:
2,411,221, CANC. INT. CL. 28.
- YANMAR CO., LTD., KITA-KU, OSAKA, JAPAN:
3,313,125, INT. CL. 7.
3,313,147, INT. CL. 7.

YASH RAJ FILMS PVT. LTD., ANDHERI (WEST), MUMBAI, INDIA:
3,310,255, PUB. 7-31-2007. MULTIPLE CLASS, INT. CLS. 9 AND 41.

YES I AM PRODUCTS, LLC, LARGO, FL:
3,314,260, INT. CL. 14.

YIN SHAN MFG BRUSHES CO., LTD., TAIZHOU CITY, ZHEJIANG, CHINA:
3,313,596, INT. CL. 21.

YMARKETING.COM, INC., SAN DIEGO, CA:
2,410,385, CANC. INT. CL. 35.

YOGURT SHACK, DANVILLE, CA:
3,312,356, PUB. 7-31-2007. INT. CL. 30.

YOKOHAMA RUBBER CO., LTD., THE, MINATO-KU, TOKYO, JAPAN:
1,454,350. REN. 9-13-07. INT. CL. 25.

YOKOMI, DARRICK, FOUNTAIN VALLEY, CA:
3,313,657, INT. CL. 28.

YOUNG CONCERT ARTISTS, INC., NEW YORK, NY:
2,094,664. REN. 9-9-07. MULTIPLE CLASS, INT. CLS. 35 AND 41.

YOUNG M.D., SCOTT C., ASHLAND, OR AND JAMES, SULARA, ASHLAND, OR, AKA ROBIN:
3,311,808, PUB. 7-31-2007. MULTIPLE CLASS, INT. CLS. 37 AND 45.

YOUR-BEST-RATE FINANCIAL, LLC, ATLANTA, GA:
3,311,743, PUB. 7-31-2007. INT. CL. 36.

YOYODYNE ENTERTAINMENT, INC., IRVINGTON, NY:
2,409,800, CANC. INT. CL. 35.

YU, PATRICIA, MADISON, WI:
2,128,529. REN. 9-13-07. INT. CL. 9.
2,128,529, CANC. INT. CL. 41.

YUEQING ONESTO ELECTRIC, CO., LTD., CHINA:
3,312,943, PUB. 7-31-2007. INT. CL. 9.

YUILL, RICK, COSTA MESA, CA:
2,411,474, CANC. INT. CL. 36.

YUYAO TIRIT INDUSTRY & TRADE CO., LTD, CHINA:
3,312,903, PUB. 7-31-2007. INT. CL. 8.

Z-FORCE ENTERPRISES, LLC, WEST PALM BEACH, FL:
3,313,391, INT. CL. 9.

ZABEL INDUSTRIES INTERNATIONAL, LTD., LOUISVILLE, KY:
2,411,174, CANC. INT. CL. 7.

ZABOLOTSKAIA, ZHANNA, VALLEY VILLAGE, CA:
3,311,437, PUB. 7-31-2007. INT. CL. 18.

ZACCAI, JOSEPH AND ZACCAI, MARC, BROOKLYN, NY:
3,313,449, INT. CL. 25.

ZAKARIAN, ARTIN, LAS VEGAS, CA:
3,314,316, INT. CL. 8.

ZAMPERLA INC., PARSIPPANY, NJ:
1,453,325. REN. 9-7-07. INT. CL. 28.

ZAWADZKI, JEFFREY JOSEPH, GRAND RAPIDS, MI:
3,313,511, INT. CL. 37.

ZAXCOM, INC., POMTON PLAINS, NJ:
2,122,168. REN. 9-10-07. INT. CL. 9.

ZELBY, LLC, PAWTUCKET, RI:
3,312,535, PUB. 7-31-2007. MULTIPLE CLASS, INT. CLS. 35 AND 42.

ZELFDEN, ALAN VAN, DALLAS, TX:
2,410,685, CANC. INT. CL. 35.

ZEMEX MICA CORPORATION, ATLANTA, GA:
2,411,119, CANC. INT. CL. 17.
2,411,120, CANC. INT. CL. 17.

ZENECA INC, WILMINGTON, DE:
2,410,364, CANC. INT. CL. 41.

ZENITH ELECTRONICS CORPORATION, LINCOLNSHIRE, IL:
3,314,807, INT. CL. 9.

ZERRAN INTERNATIONAL CORPORATION, PACOIMA, CA:
2,021,404, CANC. INT. CL. 3.

ZETA BETA TAU FRATERNITY INC., INDIANAPOLIS, IN:
1,490,680. REN. 9-10-07. U.S. CL. 200.

ZF SACHS AG, FED REP GERMANY:
3,312,831, PUB. 7-31-2007. INT. CL. 12.
3,312,832, PUB. 7-31-2007. INT. CL. 12.

ZHANG YUHUI, CHINA:
3,312,864, PUB. 7-31-2007. INT. CL. 9.

ZHE, WANG, ZHEJIANG, CHINA:
3,311,503, PUB. 7-31-2007. INT. CL. 9.

ZHEJIANG QINGSHENG TEXTILE GROUP CO., LTD., ZHEJIANG PROVINCE, CHINA:
3,313,398, INT. CL. 24.

ZHEJIANG RED-CROWN CLOTHING; LIMITED COMPANY., CHINA:
3,312,971, PUB. 7-31-2007. INT. CL. 25.

ZHEJIANG SHENGHUA YUNFENG GREENNEO STOCK CO., LTD., ZHEJIANG, CHINA AND DEQUINGXIAN SHENGQIANG WOOD CO., LTD, ZHEJIANG, CHINA:
3,311,760, PUB. 7-31-2007. INT. CL. 19.

ZHENJIANG FEIDA GARMENT CO., LTD., CHINA:
3,312,774, PUB. 7-31-2007. INT. CL. 25.

ZI PANI VENTURES, LLC, WICHITA, KS:
2,411,035, CANC. MULTIPLE CLASS, INT. CLS. 29, 30 AND 42.

ZIEBELL LIVING TRUST, SEAL BEACH, CA:
2,070,801. REN. 9-10-07. INT. CL. 42.

ZIER, INC., WESTON, FL:
3,310,262, PUB. 7-31-2007. MULTIPLE CLASS, INT. CLS. 25 AND 35.

ZIMMER GMBH, WINTERTHUR, SWITZERLAND:
3,312,467, PUB. 7-31-2007. INT. CL. 41.

ZIMMER TECHNOLOGY, INC., WARSAW, IN:
3,313,301, INT. CL. 10.

ZIMMERMAN ASSOCIATES, INC., FAIRFAX, VA:
3,313,671, MULTIPLE CLASS, INT. CLS. 9 AND 42.

ZINKY ELECTRONICS, FLAGSTAFF, AZ:
3,311,327, PUB. 7-17-2007. INT. CL. 9.

ZIP CHARGE CORPORATION, TOKYO 100, JAPAN:
2,020,819, CANC. INT. CL. 9.

ZUBAROO, FREMONT, CA:
3,310,621, PUB. 7-31-2007. INT. CL. 45.

ZULULOG LLC, DEPTFORD, NJ:
3,311,102, PUB. 7-31-2007. INT. CL. 42.

ZURICH AMERICAN INSURANCE COMPANY, SCHAUMBURG, IL:
2,410,788, CANC. INT. CL. 36.
3,310,290, PUB. 7-31-2007. INT. CL. 36.

ZWANENBERG FOOD GROUP (USA) , INC., MORRISTOWN, NJ, BROKERS CHOICE INC., CLARK, NJ:
2,089,244. REN. 9-11-07. INT. CL. 29.

ZWIRL.COM, INC., NEW YORK, NY:
2,410,324, CANC. INT. CL. 42.

ZZOOM, INC., LAS VEGAS, NV:
2,037,278. REN. 9-7-07. INT. CL. 36.

ZZOUNDS MUSIC, LLC, MIDLAND PARK, NJ:
2,085,286. REN. 9-11-07. INT. CL. 16.

1-866-MR-TRASH, TORONTO, CANADA:
3,314,363, INT. CL. 39.

1.4 GROUP, INC., MERIDIAN, ID:
3,313,560, INT. CL. 1.

10MINMANICURE LLC, MIAMI, FL:
3,314,174, INT. CL. 44.

100 PLUS REALTY GROUP, LLC, PALM COAST, FL:
3,311,826, PUB. 7-31-2007. INT. CL. 36.

101 TEA, INC., FREMONT, CA:
2,166,935. REN. 9-7-07. INT. CL. 30.

101COMMUNICATIONS LLC, CHATSWORTH, CA:
2,409,754, CANC. INT. CL. 16.

1094752 ONTARIO LIMITED, OPERATING AS NISIM INTERNATIONAL, BRAMPTON, ONTARIO, CANADA:
3,312,578, PUB. 7-31-2007. INT. CL. 3.

1138, INC., OVERLAND PARK, KS:
3,314,498, MULTIPLE CLASS, INT. CLS. 44 AND 45.

1338477 ONTARIO LIMITED O/A BLACK DOG UNLIMITED, TORONTO, ONTARIO, CANADA:
3,312,381, PUB. 7-31-2007. INT. CL. 38.

1580605 ONTARIO INC., TORONTO, ONTARIO, CANADA:
3,310,420, PUB. 7-31-2007. INT. CL. 43.

1610 RESTAURANT, LLC, ARLINGTON, VA:
3,313,727, INT. CL. 43.

2 BB UNLIMITED, INC., LOS ANGELES, CA:
3,314,825, INT. CL. 25.

20/20 GROUP INC., VANCOUVER, BRITISH COLUMBIA, CANADA:
3,310,738, PUB. 7-17-2007. INT. CL. 37.

20/20 RESEARCH, INCORPORATED, NASHVILLE, TN, DBA RESEARCH CONCEPTS: 2,410,446, CANC. INT. CL. 35.	566382 ONTARIO LIMITED, MISSISSAUGA, ONTARIO L4T 3X2, CANADA, TA USHER'S WHOLESALE GROCERS: 2,409,912, CANC. INT. CL. 3.
3-DMATRIX, INC., BROOKLINE, MA: 3,311,237, PUB. 7-31-2007. INT. CL. 1.	670 N MICHIGAN LLC, CHICAGO, IL: 3,314,345, INT. CL. 37.
3SP LIMITED, NOTTINGHAM, UNITED KINGDOM: 3,311,973, PUB. 7-31-2007. INT. CL. 9.	7HBF, LTD., FORT WORTH, TX: 3,312,222, PUB. 7-31-2007. INT. CL. 9.
350 MARKET STREET, INC., SAINT PAUL, MN: 3,311,658, PUB. 7-31-2007. INT. CL. 43.	8 PAWS LLC, EAST HAMPTON, NY: 3,314,715, INT. CL. 41.
360DECISIONS, SANTA CLARA, CA: 3,310,878, PUB. 7-31-2007. INT. CL. 42.	91620542 QUEBEC, INC., MONTREAL, QUEBEC, CANADA: 3,314,072, INT. CL. 25.
496268 NEW YORK, INC., NORTH BOSTON, NY: 3,314,980, INT. CL. 25.	3,314,073, INT. CL. 25.

* * * * *